

MD280 Series

General-purpose AC Drive

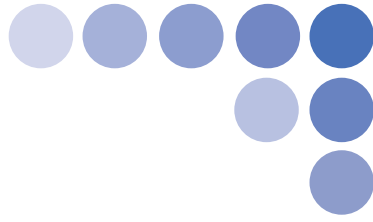

User Manual

V1.0

Data code:19010088

Preface

Thank you for purchasing the MD280 series AC drive developed by Shenzhen Inovance Technology Co., Ltd.

The MD280 series AC drive is a general-purpose AC drive, which implements V/F control on AC asynchronous motors. It is used to drive various automation production equipment of different fields involving textile, paper-making, wiredrawing, machine tool, packing, food, fan and pump. Featuring large startup torque and 8-speed running, it also supports closed-loop process control and networking, and can be commissioned easily.

This manual describes the correct use of the MD280 series AC drive, including selection, parameter setting, commissioning, maintenance & inspection. Read and understand the manual before use and forward the manual to the end user.

Notes
<ul style="list-style-type: none"><li data-bbox="135 592 926 660">• The drawings in the manual are sometimes shown without covers or protective guards. Remember to install the covers or protective guards as specified first, and then perform operations in accordance with the instructions.<li data-bbox="135 671 956 718">• The drawings in the manual are shown for description only and may not match the product you purchased.<li data-bbox="135 729 967 775">• The instructions are subject to change, without notice, due to product upgrade, specification modification as well as efforts to increase the accuracy and convenience of the manual.<li data-bbox="135 786 893 805">• Contact our agents or customer service center if you have problems during the use.

Introduction

The basic configuration and functions of the MD280 are described in the following table.

Input/Output terminal	<ul style="list-style-type: none"> • 5 x DI (DI5 can be used for high-speed input) • 2 x AI (AI2 for voltage or current input, or operation panel potentiometer setting) • 2 x DO • 1 x AO (voltage or current output, or frequency or DO output through FM) • 1 x relay output
Control mode	V/F
Analog setting	Straight-line mode
Multi-speed	8 speeds
Simple PLC	8-period scheduled running
Swing frequency and fixed length control	Supported
Communication function	RS485 communication port
PID control	Supported
V/F mode	Straight-line V/F, multi-point V/F, square V/F

■ Product Checking

Upon unpacking, check:

- Whether the nameplate model and AC drive ratings are consistent with your order. The box contains the AC drive, certificate of conformity, user manual and warranty card.
- Whether the AC drive is damaged during transportation. If you find any omission or damage, contact Inovance or your supplier immediately.

■ First-time Use

For the users who use this product for the first time, read the manual carefully. If in doubt concerning any function or performance, contact the technical support personnel of Inovance to ensure correct use.

■ Standard Compliant

The MD280 series AC drive complies with the following standards:

- IEC/EN 61800-5-1: 2003 Speed Electric Drive Systems Safety Requirements
- IEC/EN 61800-3: 2004 Speed Electric Drive System; Part 3: EMC Standard and Specified Test Method (the MD280 series AC drive complies with the requirements of standard IEC/EN 61800-3 on the condition of correct installation and use by following the instructions in chapter 7)

■ Connection to Peripheral Devices

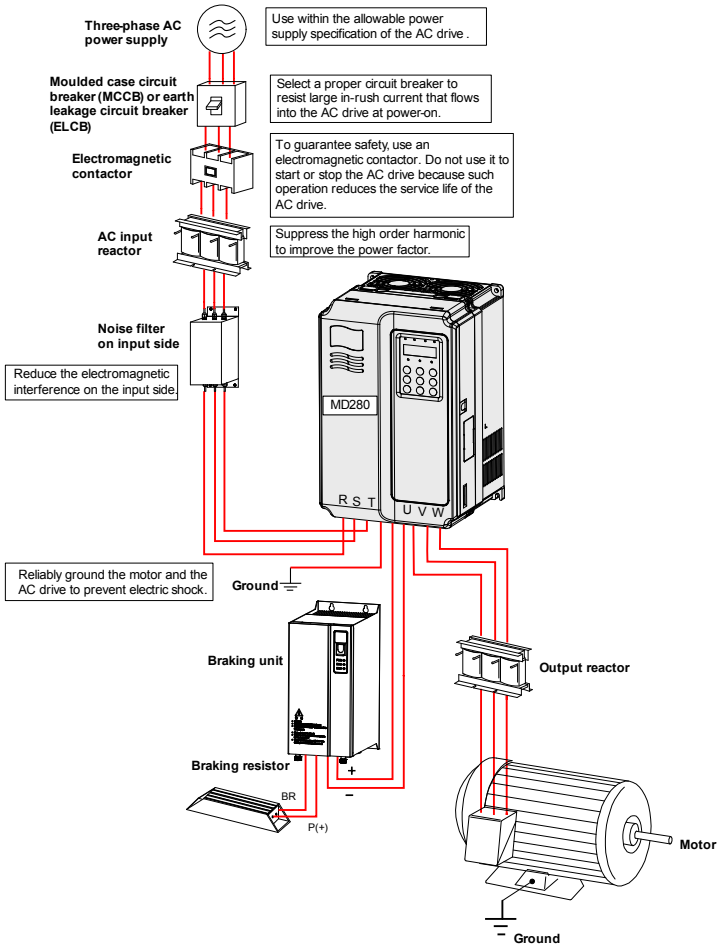

- Do not install the capacitor or surge suppressor on the output side of the AC drive. Otherwise, it may cause faults to the AC drive or damage to the capacitor and surge suppressor.
- Inputs/Outputs (main circuit) of the AC drive contain harmonics, which may interfere with the communication device connected to the AC drive. Therefore, install an anti-interference filter to minimize the interference.
- For more details on peripheral devices, refer to section 3.2.1.

Contents

Preface	1
Introduction	2
Chapter 1 Safety Information and Precautions.....	8
1.1 Safety Information	8
1.2 General Precautions.....	10
Chapter 2 Product Information	16
2.1 Designation Rules and Nameplate of the MD280	16
2.2 MD280 Models and Technical Data.....	16
2.3 Technical Specifications	17
2.4 Physical Appearance and Overall Dimensions of the MD280	20
2.5 Optional Parts.....	24
2.6 Maintenance.....	24
2.7 Warranty	26
2.8 Braking Component Selection Guideline.....	26
Chapter 3 Mechanical and Electrical Installation.....	30
3.1 Mechanical Installation	30
3.2 Electrical Installation.....	36
Chapter 4 Operation and Display	52
4.1 Operation Panel.....	52
4.2 Viewing and Modifying Function Codes	54
4.3 Viewing Status Parameters	55
4.4 Starting or Stopping the AC Drive.....	56
4.5 JOG Running.....	60
4.6 Setting the Running Frequency	61
4.7 Setting and Auto-tuning of Motor Parameters	69
4.8 Use of DI Terminals	70
4.9 Use of DO Terminals	70
4.10 Use of AI Terminals.....	71
4.11 Use of AO Terminals.....	72
4.12 Use of Serial Communication.....	72

4.13 Password Setting.....73

4.14 Default Initialization73

Chapter 5 Function Code Table.....76

Chapter 6 Description of Function Codes.....98

Group F0: Basic Parameters98

Group F1: Motor Parameters and V/F Control Parameters.....105

Group F2: Input Terminals109

Group F3: Output Terminals118

Group F4: Start/Stop Control.....122

Group F5: Auxiliary Functions127

Group F6: Process Control PID Function134

Group F7: Swing Frequency, Fixed Length and Count137

Group F8: Multi-Reference and Simple PLC Function141

Group F9: Reserved144

Group FA: Communication Parameters.....144

Group FB: Overload and Protection144

Group FC: Motor 2 Parameters149

Group FD: AI Correction150

Group FF: Factory Parameters (Reserved).....151

Group FP: User Password.....151

Chapter 7 EMC.....154

7.1 Definition.....154

7.2 Introduction to EMC Standard154

7.3 EMC Guideline154

Chapter 8 Troubleshooting158

8.1 Faults and Solutions.....158



8.2 Common Faults and Solutions162



Safety Information and Precautions





Chapter 1 Safety Information and Precautions





In this manual, the notices are graded based on the degree of danger:





-  **DANGER** indicates that failure to comply with the notice will result in severe personal injury or even death.
-  **WARNING** indicates that failure to comply with the notice will result in personal injury or property damage.

Read this chapter carefully so that you have a thorough understanding, and perform all operations such as installation, commissioning or maintenance by following the notices in this chapter. Inovance will assume no liability or responsibility for any injury or loss caused by improper operation.

1.1 Safety Information

Use Stage	Safety Grade	Precautions
Before installation	 WARNING	<ul style="list-style-type: none"> • Do not install the equipment if you find water seepage, component missing or damage upon unpacking. • Do not install the equipment if the packing list does not conform to the product you received.
	 DANGER	<ul style="list-style-type: none"> • Handle the equipment with care during transportation to prevent damage to the equipment. • Do not use the equipment if any component is damaged or missing. Failure to comply will result in personal injury. • Do not touch the components with your hands. Failure to comply will result in static electricity damage.
During installation	 DANGER	<ul style="list-style-type: none"> • Install the equipment on incombustible objects such as metal, and keep it away from combustible materials. Failure to comply may result in a fire. • Do not loosen the fixed screws of the components, especially the screws with red mark.
	 WARNING	<ul style="list-style-type: none"> • Do not drop wire end or screw into the AC drive. Failure to comply will result in damage to the AC drive. • Install the AC drive in places free of vibration and direct sunlight. • When two AC drives are laid in the same cabinet, arrange the installation positions properly to ensure the good cooling effect.

Use Stage	Safety Grade	Precautions
At wiring	 DANGER	<ul style="list-style-type: none"> • Wiring must be performed only by qualified personnel under instructions described in this manual. Failure to comply may result in unexpected accidents. • A circuit breaker must be used to isolate the power supply and the AC drive. Failure to comply may result in a fire. • Ensure that the power supply is cut off before wiring. Failure to comply may result in electric shock. • Tie the AC drive to ground properly according to the requirements. Failure to comply may result in electric shock.
	 WARNING	<ul style="list-style-type: none"> • Never connect the power cables to the output terminals (U, V, W) of the AC drive. Pay attention to the marks of the wiring terminals and ensure correct wiring. Failure to comply will result in damage to the AC drive. • Never connect the braking resistor between the DC bus terminals (+) and (-). Failure to comply may result in a fire. • Ensure that all wiring complies with the EMC requirements and local safety standard. Use wire sizes recommended in the manual. Failure to comply may result in accidents. • Use a shielded cable for the encoder, and ensure that the shielding layer is reliably grounded.
Before power-on	 WARNING	<ul style="list-style-type: none"> • Check that the following requirements are met: <ul style="list-style-type: none"> – The voltage class of the power supply is consistent with the rated voltage class of the AC drive. – The input terminals (R, S, T) and output terminals (U, V, W) are properly connected. – No short-circuit exists in the peripheral circuit. – The wiring is secured. Failure to comply will result in damage to the AC drive • Do not perform the voltage resistance test on any part of the AC drive because such test has been done in the factory. Failure to comply will result in accidents.
	 DANGER	<ul style="list-style-type: none"> • Cover the AC drive properly before power-on to prevent electric shock. • All peripheral devices must be connected properly under the instructions described in this manual. Failure to comply will result in accidents.
After power-on	 DANGER	<ul style="list-style-type: none"> • Do not open the AC drive's cover after power-on. Failure to comply may result in electric shock. • Do not touch any I/O terminal of the AC drive. Failure to comply may result in electric shock. • The AC drive automatically performs safety detection on the external strong power circuit immediately after power-on. Do not touch the U, V, W terminals of the AC drive or wiring terminals of the motor. Failure to comply may result in electric shock.

Use Stage	Safety Grade	Precautions
After power-on	 DANGER	<ul style="list-style-type: none"> Do not touch the rotating part of the motor during the motor auto-tuning or running. Failure to comply will result in accidents. Do not change the default settings of the AC drive. Failure to comply will result in damage to the AC drive.
During running	 DANGER	<ul style="list-style-type: none"> Do not touch the fan or the discharging resistor to check the temperature. Otherwise, you may get burnt. Signal detection must be performed only by qualified personnel during operation. Failure to comply will result in personal injury or equipment damage.
	 WARNING	<ul style="list-style-type: none"> Avoid objects falling into the AC drive when it is running. Failure to comply will result in damage to the AC drive. Do not start/stop the AC drive by turning the contactor ON/OFF. Failure to comply will result in damage to the AC drive.
During maintenance	 DANGER	<ul style="list-style-type: none"> Repair or maintenance of the AC drive can be performed only by qualified personnel. Failure to comply will result in personal injury or damage to the AC drive. Do not repair or maintain the AC drive at power-on. Failure to comply will result in electric shock. Repair or maintain the AC drive only ten minutes after the AC drive is powered off. Otherwise, the residual voltage in the capacitor will result in personal injury. Ensure that the AC drive is disconnected from all power supplies before starting repair or maintenance on the AC drive. Set and check the parameters again after the AC drive is replaced.

1.2 General Precautions

1) Requirement on residual current device (RCD)

The AC drive generates high leakage current during running, which flows through the protective earthing (PE) conductor. Thus install a type-B RCD at primary side of the power supply. When selecting the RCD, you should consider the transient and steady-state leakage current to ground that may be generated at startup and during running of the AC drive. You can select a specialized RCD with the function of suppressing high harmonics or a general-purpose RCD with relatively large residual current.

2) High leakage current warning

The AC drive generates high leakage current during running, which flows through the PE conductor. Earth connection must be done before connection of power supply. Earthing shall comply with local regulations and related IEC standards.

3) Motor insulation test

Perform the insulation test when the motor is used for the first time, or when it is reused after being stored for a long time, or in a regular check-up, in order to prevent the poor insulation of motor windings from damaging the AC drive. The motor must be disconnected from the AC drive during the insulation test. A 500-V mega-Ohm meter is

recommended for the test. The insulation resistance must not be less than 5 MΩ.

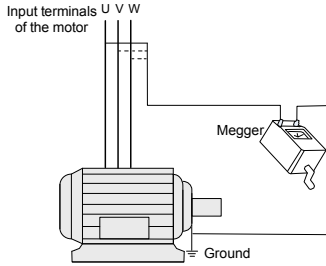

4) Thermal protection of motor

If the rated capacity of the motor selected does not match that of the AC drive, especially when the AC drive's rated power is greater than the motor's, adjust the motor protection parameters on the operation panel of the AC drive or install a thermal relay in the motor circuit for protection.

5) Running at over 50 Hz

The AC drive provides frequency output of 0–300 Hz. If the AC drive is required to run at over 50 Hz, consider the capacity of the machine.

6) Vibration of mechanical device

The AC drive may encounter the mechanical resonance point at some output frequencies, which can be avoided by setting the skip frequency.

7) Motor heat and noise

The output of the AC drive is pulse width modulation (PWM) wave with certain harmonics, and therefore, the motor temperature, noise, and vibration are slightly greater than when the AC drive runs at power frequency (50 Hz).

8) Voltage-sensitive device or capacitor on output side of the AC drive

Do not install the capacitor for improving power factor or lightning protection voltage-sensitive resistor on the output side of the AC drive because the output of the AC drive is PWM wave. Otherwise, the AC drive may suffer transient overcurrent or even be damaged.

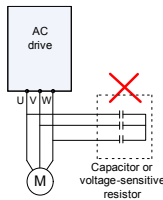

9) Contactor at the I/O terminal of the AC drive

When a contactor is installed between the input side of the AC drive and the power supply, the AC drive must not be started or stopped by switching the contactor on or off. If the AC drive has to be operated by the contactor, ensure that the time interval

between switching is at least one hour since frequent charge and discharge will shorten the service life of the capacitor inside the AC drive.

When a contactor is installed between the output side of the AC drive and the motor, do not turn off the contactor when the AC drive is active. Otherwise, modules inside the AC drive may be damaged.

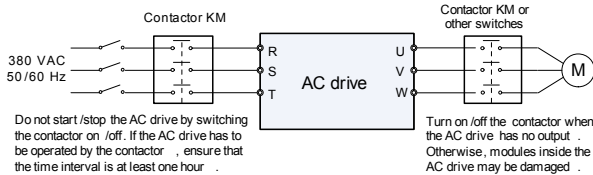

10) When external voltage is out of rated voltage range

The AC drive must not be used outside the allowable voltage range specified in this manual. Otherwise, the AC drive's components may be damaged. If required, use a corresponding voltage step-up or step-down device.

11) Prohibition of three-phase input changed into two-phase input

Do not change the three-phase input of the AC drive into two-phase input. Otherwise, a fault will result or the AC drive will be damaged.

12) Surge suppressor

The AC drive has a built-in voltage dependent resistor (VDR) for suppressing the surge voltage generated when the inductive loads (electromagnetic contactor, electromagnetic relay, solenoid valve, electromagnetic coil and electromagnetic brake) around the AC drive are switched on or off. If the inductive loads generate a very high surge voltage, use a surge suppressor for the inductive load or also use a diode.

Note

Do not connect the surge suppressor on the output side of the AC.

13) Altitude and de-rating

In places where the altitude is above 1000 m and the cooling effect reduces due to thin air, it is necessary to de-rate the AC drive. Contact Inovance for technical support.

14) Some special usages

If wiring that is not described in this manual such as common DC bus is applied, contact the agent or Inovance for technical support.

15) Disposal

The electrolytic capacitors on the main circuits and PCB may explode when they are burnt. Poisonous gas is generated when the plastic parts are burnt. Treat them as ordinary industrial waste.

16) Adaptable Motor

- The standard adaptable motor is adaptable four-pole squirrel-cage asynchronous induction motor or PMSM. For other types of motor, select a proper AC drive according to the rated motor current.
- The cooling fan and rotor shaft of non-variable-frequency motor are coaxial, which results in reduced cooling effect when the rotational speed declines. If variable speed is required, add a more powerful fan or replace it with variable-frequency motor in applications where the motor overheats easily.
- The standard parameters of the adaptable motor have been configured inside the AC drive. It is still necessary to perform motor auto-tuning or modify the default values based on actual conditions. Otherwise, the running result and protection performance will be affected.
- The AC drive may alarm or even be damaged when short-circuit exists on cables or inside the motor. Therefore, perform insulation short-circuit test when the motor and cables are newly installed or during routine maintenance. During the test, make sure that the AC drive is disconnected from the tested parts.



Product Information

Chapter 2 Product Information

2.1 Designation Rules and Nameplate of the MD280

Figure 2-1 Designation rules and nameplate of the MD280

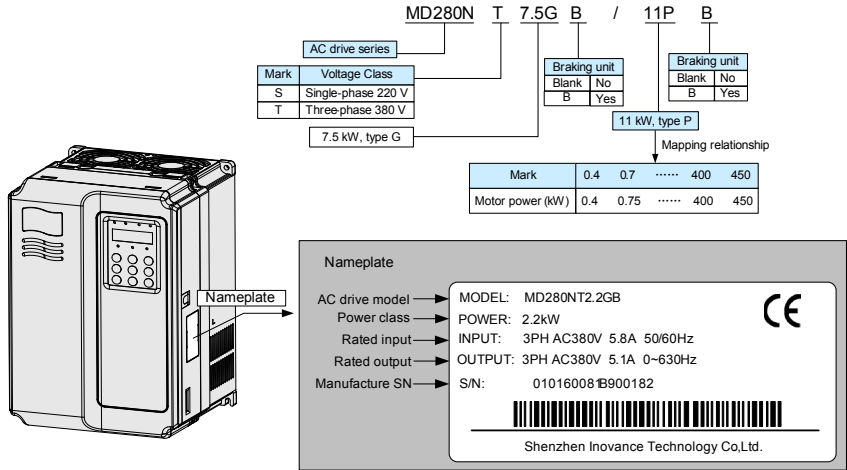

2.2 MD280 Models and Technical Data

Table 2-1 MD280 models and technical data

MD280 Model	Input Voltage	Power Capacity (kVA)	Input Current (A)	Output Current (A)	Motor Power (kW)
MD280NS0.4GB	Single-phase 220 V, range: -15% to 20%	1.0	5.4	2.3	0.4
MD280NS0.7 GB		1.5	8.2	4.0	0.75
MD280NS1.5 GB		3.0	14.2	7.0	1.5
MD280NS2.2 GB		4.0	23.0	9.6	2.2
MD280NT0.7 GB	Three-phase 380 V, range: -15% to 20%	1.5	3.4	2.1	0.75
MD280NT1.5 GB		3.0	5.0	3.8	1.5
MD280NT2.2 GB		4.0	5.8	5.1	2.2
MD280NT3.7GB/5.5PB		5.9	14.6	9.0/13.0	3.7/5.5
MD280NT5.5GB/7.5PB		8.9	20.5	13.0/17.0	5.5/7.5
MD280NT7.5GB/11PB		11.0	26.0	17.0/25.0	7.5/11
MD280NT11GB/15PB	17.0	35.0	25.0/32.0	11.0/15	

MD280 Model	Input Voltage	Power Capacity (kVA)	Input Current (A)	Output Current (A)	Motor Power (kW)
MD280NT15GB/18.5PB	Three-phase 380 V, range: -15% to 20%	21.0	38.5	32.0/37.0	15.0/18.5
MD280NT18.5G/22P		30.0	46.5	37.0/45.0	18.5/22
MD280NT22G/30P		40.0	62.0	45.0/60.0	22/30
MD280NT30G/37P		57.0	76.0	60.0/75.0	30/37
MD280NT37G/45P		69.0	92.0	75.0/91.0	37/45
MD280NT45G/55P		85.0	113.0	91.0/112.0	45/55
MD280NT55G/75P		114.0	157.0	112.0/150.0	55/75
MD280NT75G/90P		134.0	180.0	150.0/176.0	75/90
MD280NT90G/110P		160.0	214.0	176.0/210.0	90/110
MD280NT110G/132P		192.0	256.0	210.0/253.0	110/132
MD280NT132G/160P		231.0	307.0	253.0/304.0	132/160
MD280NT160G/200P		250.0	385.0	304.0/377.0	160/200
MD280NT200G/220P		280.0	430.0	377.0/426.0	200/220
MD280NT220G/250P		355.0	468.0	426.0/465.0	220/250
MD280NT250G/280P		396.0	525.0	465.0/520.0	250/280
MD280NT280G/315P		445.0	590.0	520.0/585.0	280/315
MD280NT315G/355P		500.0	665.0	585.0/650.0	315/355
MD280NT355G/400P		565.0	785.0	650.0/725.0	355/400
MD280NT400G/450P	630.0	883.0	752.0/820.0	400/450	

2.3 Technical Specifications

Table 2-2 Technical specifications of the MD280

Item		Specifications
Standard functions	Maximum frequency	630 Hz
	Carrier frequency	0.5–16 kHz The carrier frequency is automatically adjusted based on the load features.
	Input frequency resolution	Digital setting: 0.01 Hz Analog setting: maximum frequency x 0.025%
	Control mode	Voltage/Frequency (V/F) control
	Startup torque	150%
	Speed range	1:50

Item		Specifications
Standard functions	Speed stability accuracy	±1%
	Overload capacity	<ul style="list-style-type: none"> G type: 60s for 150% of the rated current P type: 60s for 130% of the rated current
	Torque boost	<ul style="list-style-type: none"> Fixed boost Customized boost 0.1%–30.0%
	V/F curve	<ul style="list-style-type: none"> Straight-line V/F curve Multi-point V/F curve Square V/F curve
	Ramp mode	<ul style="list-style-type: none"> Straight-line ramp S-curve ramp Two groups of acceleration/deceleration time with the range of 0.00–300.0s (m)
	DC braking	DC braking frequency: 0.00 Hz to maximum frequency Braking time: 0.0–36.0s Braking action current value: 0.0%–100.0%
	JOG control	JOG frequency range: 0.00 Hz to maximum frequency JOG acceleration/deceleration time: 0.0–300.0s
	Simple PLC, multi-speed running	It implements up to 8 speeds via the simple PLC function or combination of DI terminal states.
	Built-in PID	It implements the closed-loop process control system easily.
	Auto voltage regulation (AVR)	It can keep constant output voltage automatically when the mains voltage changes.
	Overcurrent stall control	The current is limited automatically during the running so as to avoid frequent tripping due to overcurrent.
Rapid current limit	It decreases the overcurrent faults to the minimum and ensures normal running of the AC drive.	
Individualized functions	Peripheral device safety check at power-on	The AC drive performs safety check such as grounding and short-circuit on peripheral devices at power-on.
	Common DC bus	Multiple AC drives share the DC bus.
	MF.K key	This key can be used for command source switchover, forward/reverse running selection, and jog running selection.
	Textile swing frequency control	Control of multiple triangular wave frequencies is supported.
	Fixed length control	The fixed length control is supported.

Item		Specifications
RUN	Running command source	<ul style="list-style-type: none"> • Operation panel control • Terminal control • Communication control You can perform switchover between these sources in various ways.
	Frequency source	There are a total of eight frequency sources, including digital setting, analog voltage setting, analog current setting, pulse setting, multi-speed, PLC, PID and communication setting.
	Input terminal	5 x DI, one of which supports high-speed pulse input 2 x AI, AI1 supporting 0–10 V voltage input and AI2 supporting 0–10 V voltage input or 4–20 mA current input (or operation panel potentiometer input through jumper selection)
	Output terminal	2 x DO 1 x relay output 1 x AO that supports 0–20 mA current output or 0–10 V voltage output, to output the set frequency and running frequency (FM can also be used for AO output)
Display and operation on the operation panel	LED display	It displays the parameters and monitored state of the AC drive.
	Protection function	Motor short-circuit detection at power-on, input/output phase loss protection, overcurrent protection, overvoltage protection, undervoltage protection, overheat protection and overload protection
	Optional parts	External operation panel (with or without the potentiometer), braking components, external operation panel cable
Environment	Installation location	Indoor, free from direct sunlight, dust, corrosive gas, combustible gas, oil smoke, vapour, drip or salt.
	Altitude	Lower than 1000 m (de-rated if higher than 1000 m)
	Ambient temperature	-10°C to +40°C (de-rated if the ambient temperature is between 40°C and 50°C)
	Humidity	Less than 95%RH, without condensing
	Vibration	Less than 5.9 m/s ² (0.6 g)
	Storage temperature	-20°C to +60°C
	IP level	IP20
Pollution degree	PD2	
Environment	Power distribution system	TN , TT

2.4 Physical Appearance and Overall Dimensions of the MD280

2.4.1 Product Appearance and Mounting Dimensions of the MD280

Figure 2-2 Physical appearance and overall dimensions of the MD280

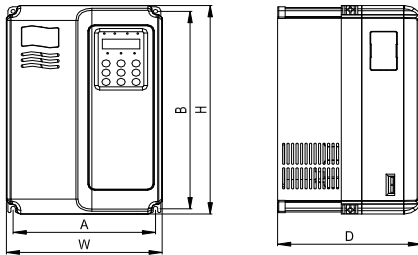
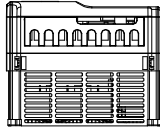

(MD280NS0.4GB to MD280NT15GB/18.5PB)

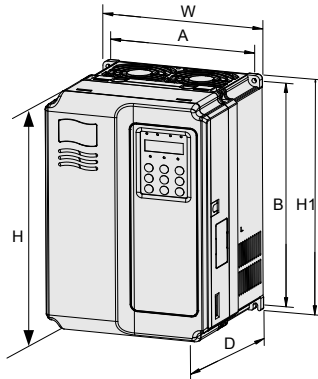

(MD280NT18.5G/22P to MD280NT400G/450P)

Table 2-3 Physical dimensions and mounting dimensions of the MD280

MD280 Model	Mounting Hole (mm)		Physical Dimensions (mm)				Mounting Hole Diameter (mm)	Weight (kg)
	A	B	H	H1	W	D		
MD280NS0.4GB	113	172	186	-	125	164	Ø5.0	1.1
MD280NS0.7GB								
MD280NS1.5GB								
MD320NS2.2GB								
MD280NT0.7GB								
MD280NT1.5GB								
MD280NT2.2GB								
MD280NT3.7GB	148	236	248	-	160	183	Ø5.0	2.5
MD280NT5.5GB/7.5PB								
MD280NT7.5GB/11PB	190	305	322	-	208	192	Ø6	6.5
MD280NT11GB/15PB								
MD280NT15GB/18.5PB								
MD280NT18.5G/22P	235	447	432	463	285	228	Ø6.5	20
MD280NT22G/30P								
MD280NT30G/37P								
MD280NT37G/45P	260	580	549	600	385	265	Ø10	32
MD280NT45G/55P								
MD280NT55G/75P								
MD280NT75G/90P	343	678	660	700	473	307	Ø10	47
MD280NT90G/110P								
MD280NT110G/132P	449	903	880	930	579	380	Ø10	90
MD280NT132G/160P								
MD280NT200G/220P	420	1030	983	1060	650	377	Ø12	130
MD280NT220G/250P								
MD280NT250G/280P								
MD280NT280G/315P								
MD280NT315G/355P	520	1300	1203	1358	800	400	Ø16	200
MD280NT355G/400P								
MD280NT400G/450P								

2.4.2 Physical Dimensions and Mounting Dimensions of the External Operation Panel

Figure 2-3 Physical dimensions of the external operation panel

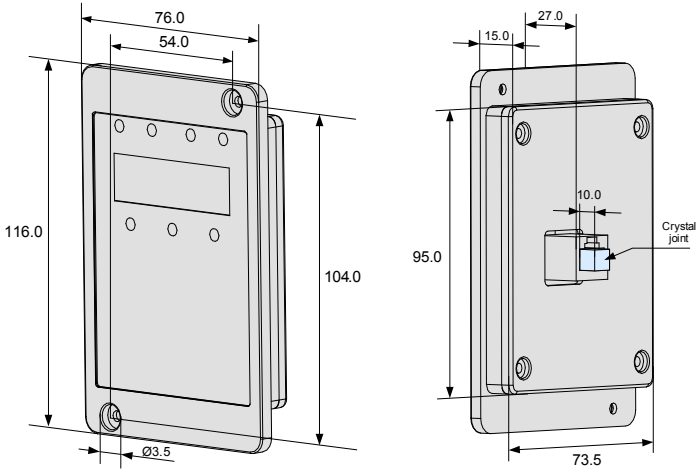
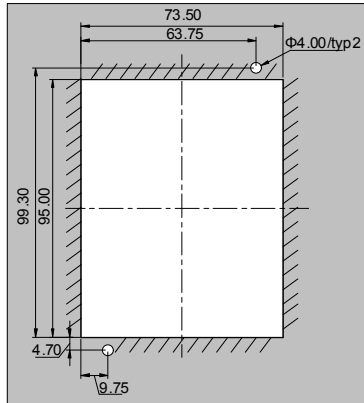

Figure 2-4 Mounting hole dimensions of the external operation panel



2.4.3 Mounting Dimensions of the External DC Reactor

Figure 2-5 Mounting dimensions of external DC reactor

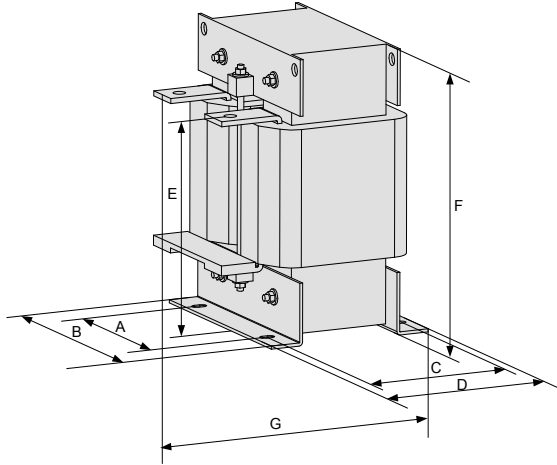

Table 2-4 Adaptable DC reactor and mounting dimensions

AC Drive Model	A	B	C	D	E	F	G	Mounting Hole	Diameter of the Hole for Connecting Copper Busbar	Adaptable Reactor Model
MD280NT75G/90P	160	190	125	161	192	255	195	10 x 15	Ø12	DCL-0200
MD280NT90G/110P, MD280NT110G/132P	160	190	125	161	192	255	195	10 x 15	Ø12	DCL-0250
MD280NT132G/160P, MD280NT160G/200P	160	190	125	161	192	255	195	10 x 15	Ø12	DCL-0360
MD280NT200G/220P, MD280NT220G/250P	190	230	93	128	250	325	200	13 x 18	Ø15	DCL-0600
MD280NT250G/280P, MD280NT280G/315P	190	230	93	128	250	325	200	13 x 18	Ø15	DCL-0700
MD280NT315G/355P, MD280NT355G/400P, MD280NT400G/450P	224	250	135	165	260	335	235	12 x 20	Ø14	DCL-1000

Note

Customized models can be provided for special requirements.

The MD280 AC drives of 75 kW and above are configured with an external DC reactor. The DC reactor is packed in separate wooden box for delivery.

When installing the DC reactor, remove the shorting copper busbar between the main circuit connection terminals P and +. Then connect the DC reactor between terminals P and + (no polarity requirement). The copper busbar is not used any longer after the installation is complete.

2.5 Optional Parts

If any optional part is required, specify it in your order.

Table 2-5 Optional parts for the MD280

Name	Model	Function	Remarks
Internal braking unit	-	The MD280 of 15GB/18.5PB or below contains the internal braking unit in the standard configuration The built-in braking unit is optional for the MD280 of 18.5G/22P to 30G/37P.	-
External braking unit	MDBUN	The MD280 of 37G/45P or above needs to be configured with an external braking unit.	Multiple external braking units are connected in parallel for 55G/75P or above.
External LED operation panel (without the potentiometer)	MDKE2	The external LED operation panel provides the same functions as the operation panel on the AC drive.	-
External LED operation panel (with the potentiometer)	MD28KE2	The external LED operation panel provides the same functions as the operation panel on the AC drive.	The potentiometer is used for AI2 input.
Extension cable	MDCAB	MDCAB is a standard 8-core network cable used as the external cable for the external operation panel.	Length: 3 m

2.6 Maintenance

2.6.1 Routine Maintenance

Ambient temperature, humidity, dust and vibration will cause the aging of the components inside the AC drive, which may cause potential faults or reduce the service life of the AC drive. Therefore, it is necessary to carry out routine and periodic maintenance.

 **WARNING**

Do not repair or maintain the AC drive immediately after power-off because there is still voltage on the filter capacitor. Wait until the CHARGE indicator becomes OFF and the bus voltage measured by the multimeter is lower than 36 V.

Routine maintenance involves checking:

- Whether the installation environment of the AC drive changes
- Whether the cooling fan works properly
- Whether the motor vibrates excessively
- Whether the AC drive overheats

Routine cleaning involves:

- Keeping the AC drive clean all the time.
- Removing the dust, especially metal powder, from the surface of the AC drive, to prevent the dust from entering the AC drive.
- Clearing the oil stain on the cooling fan of the AC drive.

2.6.2 Periodic Inspection

Perform periodic inspection on the items that are difficult to check during running. Periodic inspection involves:

- Checking and cleaning the air filter periodically.
- Checking whether the screws become loose.
- Checking whether the AC drive is corroded.
- Checking whether the wiring terminals have arc signs.
- Carrying out the main circuit insulation test.

Note

Before measuring the insulating resistance with megameter (500 VDC megameter recommended), disconnect the main circuit from the AC drive. Do not use the insulating resistance meter to test the insulation of the control circuit. The high voltage test need not be performed again because it has been completed before delivery.

2.6.3 Replacement of Vulnerable Components

Vulnerable components of the AC drive include the cooling fan and filter electrolytic capacitor. Their service life is related to the operating environment and maintenance.

The service life of the two components is listed in the following table.

Table 2-6 Service life of cooling fan and filter electrolytic capacitor

Component	Service Life	Possible Damage Cause	Judging Criteria
Fan	2 to 3 years	<ul style="list-style-type: none"> Bearing worn Blade aging 	<ul style="list-style-type: none"> Check whether there is crack on the blade. Check whether there is abnormal vibration noise upon startup.
Electrolytic capacitor	4 to 5 years	<ul style="list-style-type: none"> Input power supply in poor quality High ambient temperature Frequent load jumping Electrolytic aging 	<ul style="list-style-type: none"> Check whether there is liquid leakage. Check whether the safety valve has projected. Measure the static capacitance. Measure the insulating resistance.

2.6.4 Storage of the AC Drive

For storage of the AC drive, pay attention to the following two aspects:

- 1) Pack the AC drive with the original packing box provided by Inovance.
- 2) Long-term storage degrades the electrolytic capacitor. Thus, the AC drive must be energized once every 2 years, each time lasting at least 5 hours. The input voltage must be increased slowly to the rated value with the regulator.

2.7 Warranty

- 1) The warranty agreement applies only to the AC drive itself.
- 2) The warranty period of the product is 18 months as of its manufacturing date (refer to the barcode on the product). Maintenance out of warranty will be charged.
- 3) Within the warranty period, maintenance will be charged for the damages due to the following causes:
 - Improper operation without following the instructions
 - Fire, flood, and abnormal voltage
 - Using the AC drive for non-recommended functions
- 4) The maintenance fee is charged according to Inovance's uniform standard. If there is an agreement, the agreement prevails.

2.8 Braking Component Selection Guideline

The braking resistor model is dependent on the generation power of the motor in the actual system and is also related to the system inertia, deceleration time and potential energy load. Select the braking resistor based on the actual conditions. The larger the system inertia, the shorter the deceleration time, and the more frequent the braking is. In this case, you need to select a braking resistor of larger power and smaller resistance.

2.8.1 Calculating the Resistance

The motor and load's regenerative energy is almost consumed on the braking resistor when braking.

According to the formula $U \times U/R = P_b$:

- U refers to the braking voltage at system stable braking.
- The value of U varies with different systems. For 380V AC systems, U is generally assigned a value of 700V.
- P_b refers to the braking power.

2.8.2 Calculating the Power of Braking Resistor

In theory, the power of the braking resistor is consistent with the braking power. Considering de-rating use to 70%, you can calculate the power of the braking resistor according to the formula $0.7 \times P_r = P_b \times D$.

- P_r refers to the power of resistor.
- D refers to the braking frequency (percentage of the regenerative process to the whole working process)

Application	Elevator	Winding and unwinding	Centrifuge	Occasional braking load	General Application
Braking Frequency	20%–30%	20%–30%	50%–60%	5%	10%

Table 2-7 Recommended values of braking resistor

AC Drive Model	Recommended Power	Recommended Resistance	Braking Unit	Remarks
MD280NS0.4GB	80 W	$\geq 200 \Omega$	Built-in (standard)	-
MD280NS0.7GB	80 W	$\geq 150 \Omega$		
MD280NS1.5GB	100 W	$\geq 100 \Omega$		
MD280NS2.2GB	100 W	$\geq 70 \Omega$		
MD280NT0.7GB	150 W	$\geq 300 \Omega$		
MD280NT1.5GB	150 W	$\geq 220 \Omega$		
MD280NT2.2GB	250 W	$\geq 220 \Omega$		
MD280NT3.7GB/5.5PB	300 W	$\geq 130 \Omega$		
MD280NT5.5GB/7.5PB	400 W	$\geq 90 \Omega$		
MD280NT7.5GB/11PB	500 W	$\geq 65 \Omega$		
MD280NT11GB/15PB	800 W	$\geq 43 \Omega$		
MD280NT15GB/18.5PB	1000 W	$\geq 32 \Omega$		
MD280NT18.5G/22P	1300 W	$\geq 25 \Omega$	Built-in (optional)	"B" added to the AC drive model
MD280NT22G/30P	1500 W	$\geq 22 \Omega$		
MD280NT30G/37P	2500 W	$\geq 16 \Omega$		

AC Drive Model	Recommended Power	Recommended Resistance	Braking Unit	Remarks
MD280NT37G/45P	3.7 kW	$\geq 16 \Omega$	External	MDBUN-45-T
MD280NT45G/55P	4.5 kW	$\geq 12 \Omega$	External	MDBUN-60-T
MD280NT55G/75P	5.5 kW	$\geq 12 \Omega$	External	MDBUN-60-T
MD280NT75G/90P	7.5 kW	$\geq 8.0 \Omega$	External	MDBUN-90-T
MD280NT90G/110P	9.0 kW	$\geq 8.0 \Omega$	External	MDBUN-90-T
MD280NT110G/132P	5.5 kW x 2	$\geq 12 \Omega \times 2$	External	MDBUN-60-T x 2
MD280NT132G/160P	6.5 kW x 2	$\geq 8 \Omega \times 2$	External	MDBUN-90-T x 2
MD280NT160G/200P	16 kW	$\geq 2.5 \Omega$	External	MDBU-200-B
MD280NT200G/220P	20 kW	$\geq 2.5 \Omega$	External	MDBU-200-B
MD280NT220G/250P	22 kW	$\geq 2.5 \Omega$	External	MDBU-200-B
MD280NT250G/280P	12.5 kW x 2	$\geq 2.5 \Omega \times 2$	External	MDBU-200-B x 2
MD280NT280G/315P	14 kW x 2	$\geq 2.5 \Omega \times 2$	External	MDBU-200-B x 2
MD280NT315G/355P	16 kW x 2	$\geq 2.5 \Omega \times 2$	External	MDBU-200-B x 2
MD280NT355G/400P	17 kW x 2	$\geq 2.5 \Omega \times 2$	External	MDBU-200-B x 2
MD280NT400G/450P	20 kW x 2	$\geq 2.5 \Omega \times 2$	External	MDBU-200-B x 2
" x 2" indicates that two braking units with their respective braking resistor are connected in parallel.				



Mechanical and Electrical Installation

Chapter 3 Mechanical and Electrical Installation

3.1 Mechanical Installation

3.1.1 Installation Environment Requirements

Item	Requirements
Ambient temperature	-10°C to +50°C
Heat dissipation	Install the AC drive on the surface of an incombustible object, and ensure that there is sufficient space around for heat dissipation. Install the AC drive vertically on the support using screws.
Mounting location	Free from direct sunlight, high humidity and condensation
	Free from corrosive, explosive and combustible gas
	Free from oil dirt, dust and metal powder
Vibration	Less than 0.6 g
	Far away from the punching machine or the like

3.1.2 Installation Clearance Requirements

The clearance that needs to be reserved varies with the power class of the MD280, as shown in the following figure.

Figure 3-1 Clearance around the MD280 for installation

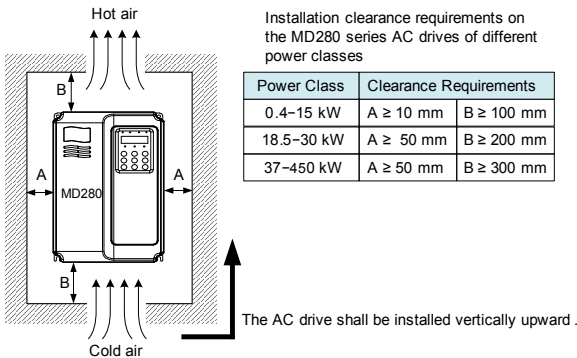

The MD280 series AC drive dissipates heat from bottom to the top. When multiple AC drives are required to work together, install them side by side.

For application installing multiple AC drives, if one row of AC drives need to be installed above another row, install an insulation guide plate to prevent AC drives in the lower row from heating those in the upper row and causing faults.

Figure 3-2 Installation of the insulation guide plate

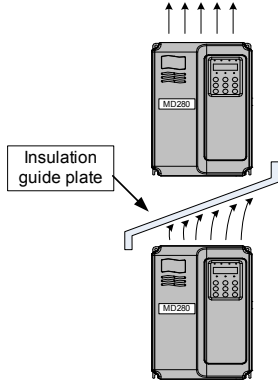

3.1.3 Mechanical Installation Method and Process

The MD280 series AC drives have two housing types, plastic housing and sheet metal housing, according to different voltage and power classes. The MD280 supports both wall-mounting installation and embedded installation in different applications.

- 1) Wall-mounting installation of the MD280 (plastic housing)

Figure 3-3 Wall-mounting installation of the MD280 (plastic housing)

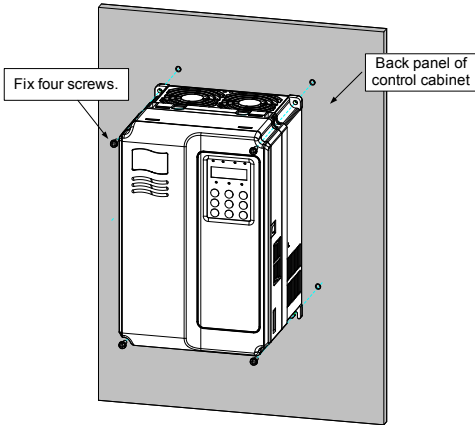

2) Embedded installation of the MD280 (plastic housing)

Figure 3-4 External hanging bracket for the MD280

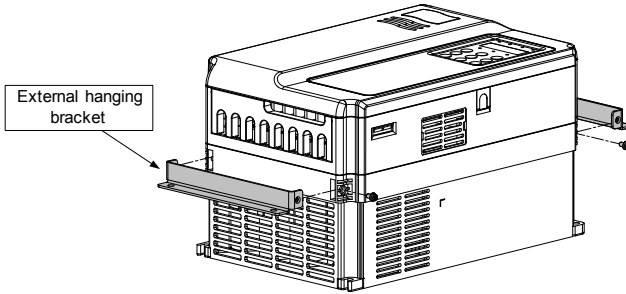

Figure 3-5 Embedded installation of the MD280 (plastic housing)

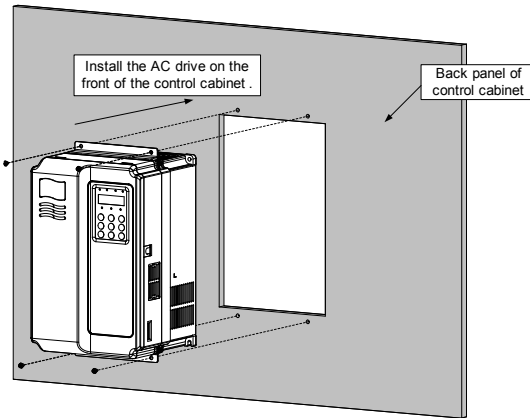
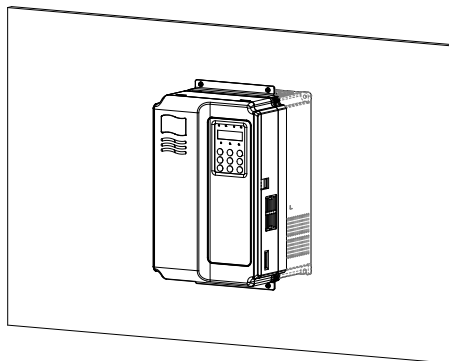

Figure 3-6 Embedded installation effect of the MD280 (plastic housing)



3) Wall-mounting installation of the MD280 (sheet metal housing)

Figure 3-7 Wall-mounting installation of the MD280 (sheet metal housing)

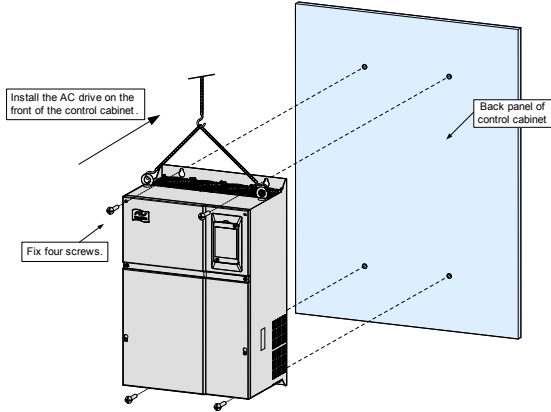
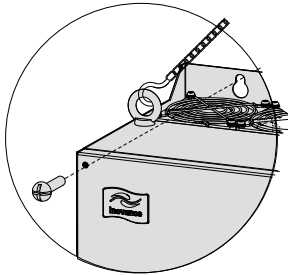

Figure 3-8 Hoisting the MD280 (sheet metal housing)



4) Embedded installation of the MD280 (sheet metal housing)

Figure 3-9 External hanging bracket for the MD280 (sheet metal housing)

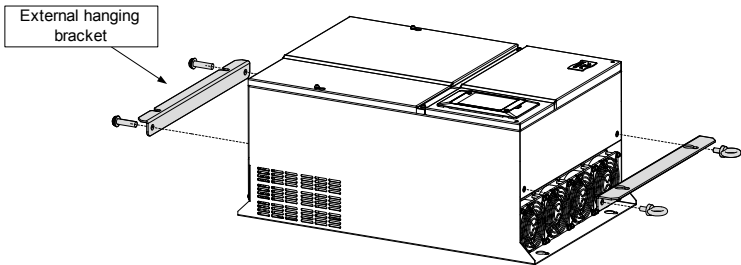

Figure 3-10 Embedded installation of the MD280 (sheet metal housing)

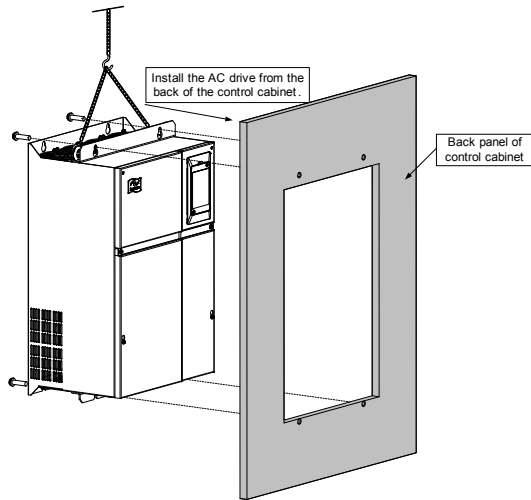

Figure 3-11 Embedded installation effect of the MD280 (sheet metal housing)



The installation precautions are as follows:

- 1) Reserve the installation clearances as specified in Figure 3-1 to ensure sufficient space for heat dissipation. Take heat dissipation of other parts in the cabinet into consideration.
- 2) Install the AC drives upright to facilitate heat dissipation. If multiple AC drives are installed in the cabinet, install them side by side. If one row of AC drives need to be installed above another row, install an insulation guide plate, as shown in Figure 3-2.
- 3) Use the incombustible hanging bracket.
- 4) In scenarios with heavy metal powder, install the heatsink outside the cabinet, and ensure that the room inside the fully-sealed cabinet is as large as possible.

3.1.4 Removal and Installation of the Front Cover of the MD280

For the MD280 series AC drives, you need to remove the front cover and before wiring the main circuit and control circuit.

Figure 3-12 Removal of the front cover of the MD280 (plastic housing)

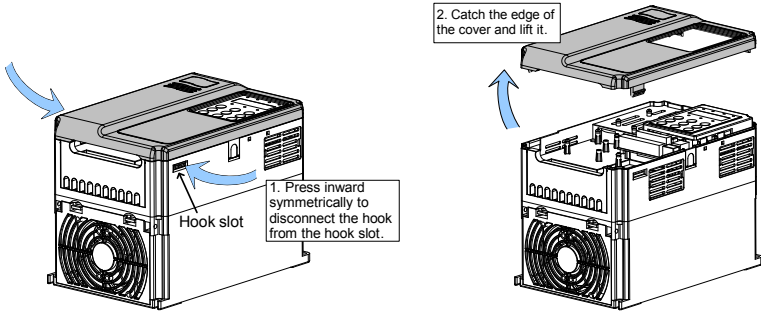
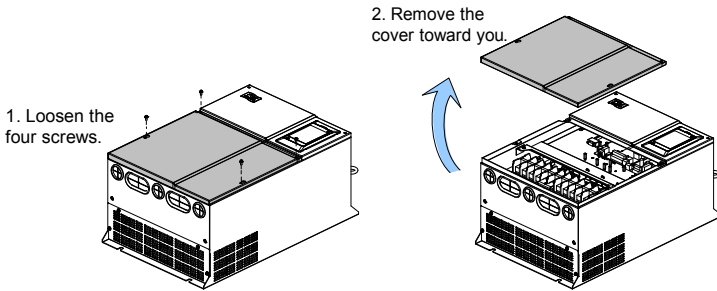

Figure 3-13 Removal of the front cover of the MD280 (sheet metal housing)



Prevent the cover from falling off during the removal. Otherwise, damage to the equipment or personal injury may result.

3.2 Electrical Installation

3.2.1 Selection of Peripheral Electrical Devices

Table 3-1 Selection of peripheral electrical devices for the MD280

AC Drive Model	MCCB (A)	Contactora (A)	Cable of Input Side Main Circuit (mm ²)	Cable of Output Side Main Circuit (mm ²)	Cable of Control Circuit (mm ²)
MD280NS0.4GB	6	9	0.75	0.75	0.5
MD280NS0.7GB	10	12	0.75	0.75	0.5
MD280NS1.5GB	16	18	1.5	1.5	0.5
MD280NS2.2GB	25	25	2.5	2.5	0.5
MD280NT0.7GB	4	9	0.75	0.75	0.5
MD280NT1.5GB	6	9	0.75	0.75	0.5
MD280NT2.2GB	6	9	0.75	0.75	0.5
MD280NT3.7GB/5.5PB	20	25	2.5	2.5	0.75
MD280NT5.5GB/7.5PB	25	25	4.0	4.0	0.75
MD280NT7.5GB/11PB	32	32	4.0	4.0	0.75
MD280NT11GB/15PB	40	40	6.0	6.0	0.75
MD280NT15GB/18.5PB	50	50	10	10	1.0
MD280NT18.5G/22P	50	50	10	10	0.75
MD280NT22G/30P	63	63	16	16	0.75
MD280NT30G/37P	80	80	25	25	1.0
MD280NT37G/45P	100	115	35	35	1.0
MD280NT45G/55P	125	125	50	50	1.0
MD280NT55G/75P	160	185	70	70	1.0
MD280NT75G/90P	200	225	95	95	1.0
MD280NT90G/110P	225	225	120	120	1.0
MD280NT110G/132P	315	330	120	120	1.0
MD280NT132G/160P	350	400	150	150	1.0
MD280NT160G/200P	400	400	185	185	1.0
MD280NT200G/220P	500	500	240	240	1.0
MD280NT220G/250P	500	500	2 x 120	2 x 120	1.0
MD280NT250G/280P	630	630	2 x 120	2 x 120	1.0
MD280NT280G/315P	630	630	2 x 150	2 x 150	1.0
MD280NT315G/355P	700	800	2 x 185	2 x 185	1.0
MD280NT355G/400P	800	800	2 x 240	2 x 240	1.0
MD280NT400G/450P	800	800	2 x 240	2 x 240	1.0

3.2.2 Description of Peripheral Electrical Devices

Table 3-2 Description of peripheral electrical devices

Part	Installation Location	Function Description
Molded case circuit breaker (MCCB)	At the front end of the input circuit	Interrupts the power supply when overcurrent occurs on downstream devices.
Contactor	Between the MCCB and the input side of the AC drive	Starts and stops the AC drive. Do not start or stop the AC drive frequently by switching the contactor on and off (less than twice per minute), or use it to directly start the AC drive.
AC input reactor	On the input side of the AC drive	Improves the power factor on the input side. Eliminates the high order harmonics on the input side effectively and prevent other device from being damaged due to distortion of the voltage waveform. Eliminates the input current unbalance due to unbalance between the power phases.
EMC input filter	On the output side of the AC drive	Reduces the external conduction and radiation interference of the AC drive. Decreases the conduction interference flowing from the power supply side to the AC drive and improves the anti-interference capacity of the AC drive.
DC reactor	Configured for AC drive of 7.5G/11P or above	Improves the power factor on the input side. Improves the efficiency and thermal stability of the AC drive. Eliminates the impact of input side high order harmonics on the AC drive and reduces the external conduction and radiation interference.
AC output reactor	Between the output side of the AC drive and the motor, close to the AC drive	The output side of the AC drive generally has much high order harmonics. When the motor is far from the AC drive, there is much distributed capacitance in the circuit and certain harmonics may cause resonance in the circuit, bringing about the following two impacts: Degrade the motor insulation performance and damage the motor in the long run. Generate large leakage current and cause frequent AC drive trips. If the distance between the AC drive and the motor is greater than 100 m, install the AC output reactor.

3.2.3 Wiring Method

The following figure shows single-phase wiring of the AC drive.

Figure 3-14 Single-phase wiring of the AC drive (MD280NS0.4GB, MD280NS0.7GB, MD280NS1.5GB, MD280NS2.2GB)

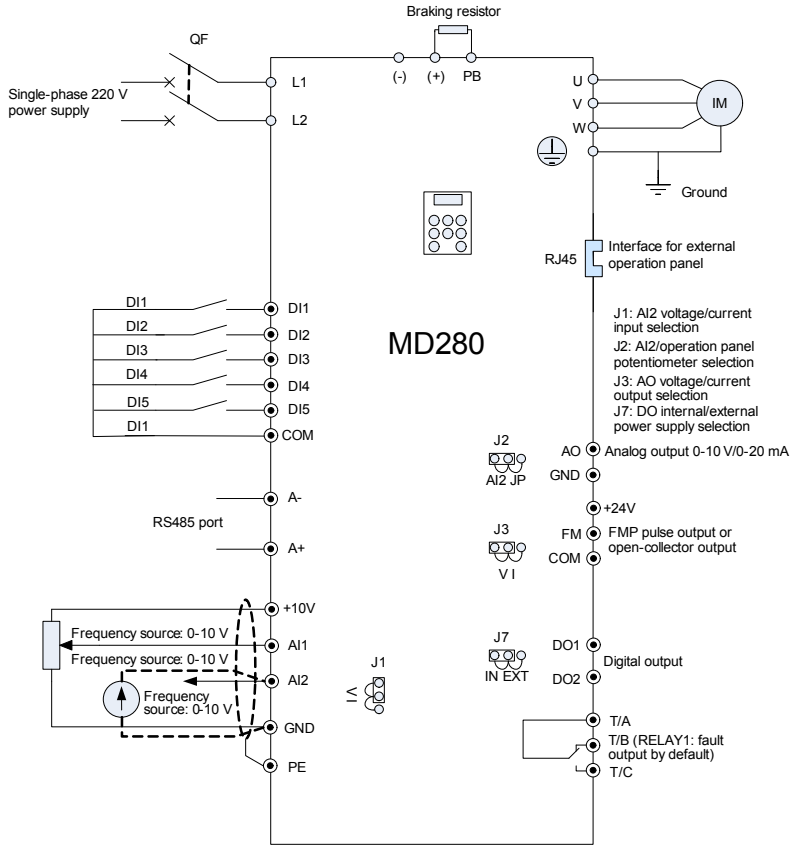

Figure 3-15 Three-phase wiring of the AC drive (MD280NT0.7GB to MD280NT30G/37P)

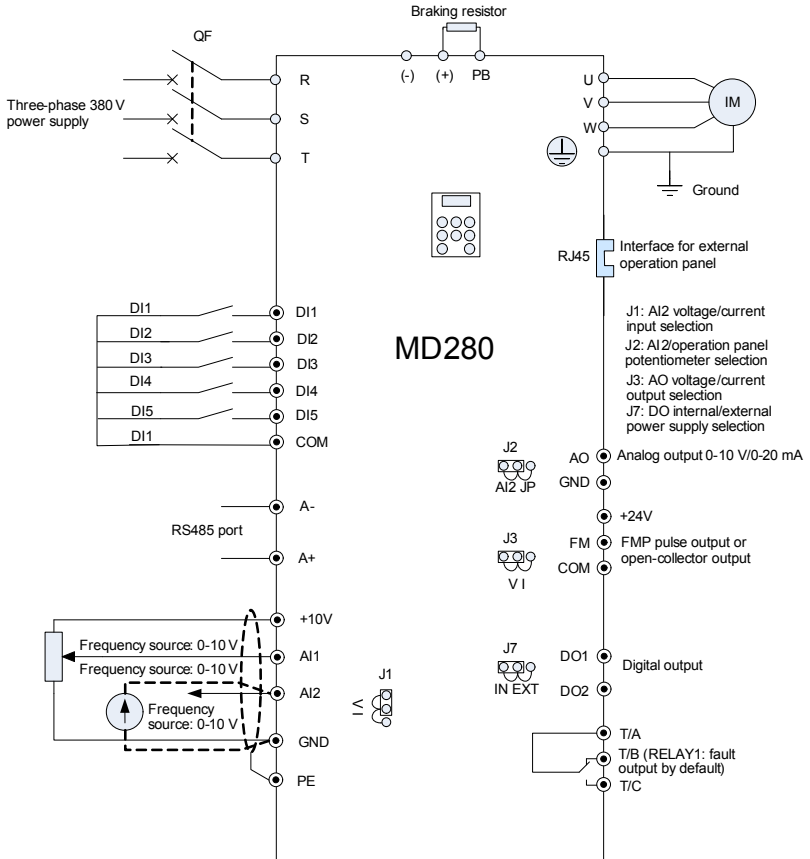

Figure 3-16 Three-phase wiring of the AC drive (MD280NT37G/45P to MD280NT55G/75P)

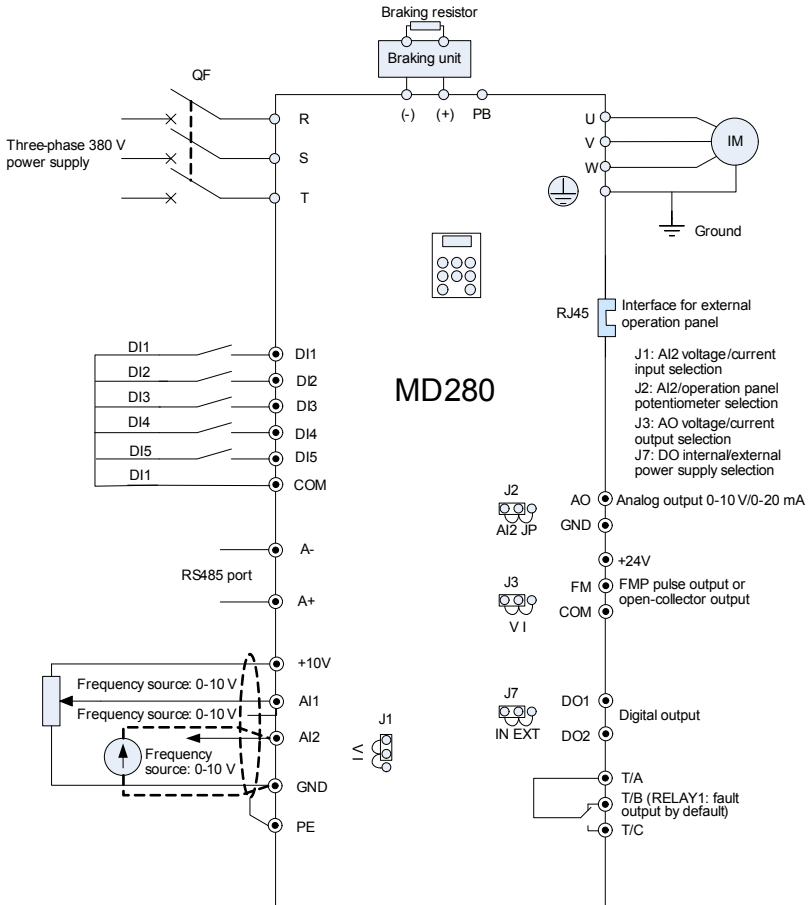
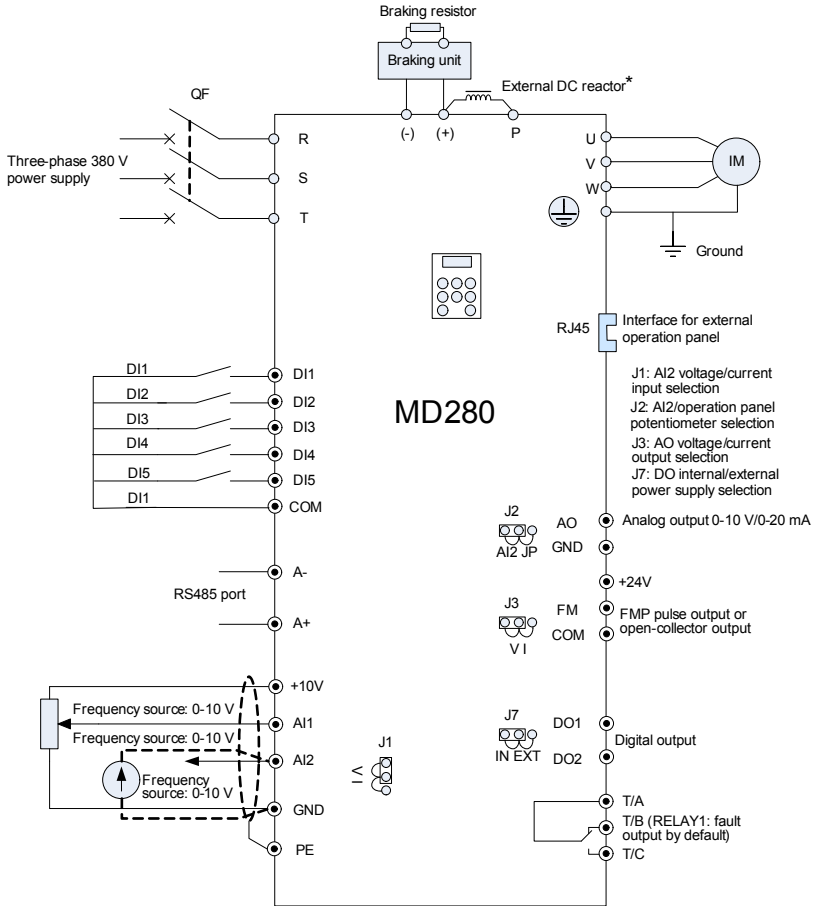

Figure 3-17 Wiring of the external reactor for the AC drive (MD280NT75G/90P to MD280NT400G/450P)



Note

- The models of 7.5–55 kW have a built-in DC reactor, and no external reactor is required; terminal P is unavailable for these models.
- The models of 75 kW and above require an external DC reactor. Terminals P and (+) are connected by a jumper bar by default. When installing the external DC reactor, remove the jumper bar, and connect the reactor between terminals P and (+).
- Select a proper external reactor according to the recommendations in Table 2-4.

3.2.4 Terminal Layout of Different Power Classes

Figure 3-18 Terminal layout of MD280NS0.4G, MD280NS0.7G, MD280NS1.5G, and MD280NS2.2G

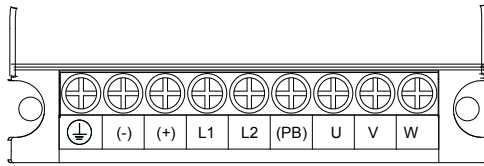

MD280 Model	Maximum Cable Size of Power Terminal (mm ² , AWG)		Torque of the Torque Driver (Kgf-cm)
S0.4GB	6	10	14±0.5
S0.7GB	6	10	14±0.5
S1.5GB	6	10	14±0.5
S2.2GB	6	10	14±0.5

Figure 3-19 Terminal layout of MD280NT0.7GB to MD280NT 5.5GB/7.5PB

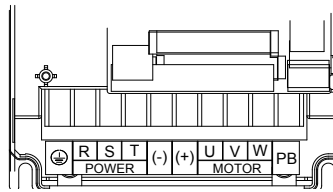

MD280 Model	Maximum Cable Size of Power Terminal (mm ² , AWG)		Torque of the Torque Driver (Kgf-cm)
T0.7GB	2.5	12	14±0.5
T1.5GB	2.5	12	14±0.5
T2.2GB	2.5	12	14±0.5
T3.7GB/5.5PB	2.5	12	14±0.5
T5.5GB/7.5PB	2.5	12	14±0.5

Figure 3-20 Terminal layout of MD280NT7.5GB/11PB to MD280NT15GB/18.5PB

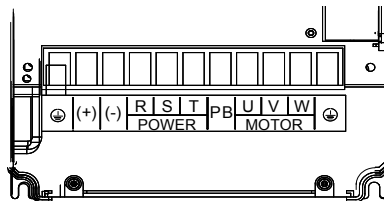

MD280 Model	Maximum Cable Size of Power Terminal (mm ² , AWG)		Torque of the Torque Driver (Kgf-cm)
T7.5GB/11PB	10	8	23±2
T11GB/15PB	10	8	23±2
T15GB/18.5PB	10	8	23±2

Figure 3-21 Terminal layout of MD280NT18.5G/22P to MD280NT30G/37P

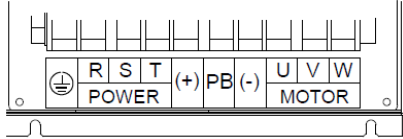

MD280 Model	Maximum Cable Size of Power Terminal (mm ² , AWG)		Torque of the Torque Driver (Kgf-cm)
T18.5G/22P	16	4	23±2
T22G/30P	16	4	23±2
T30G/37P	16	4	23±2

Figure 3-22 Terminal layout of MD280NT37G/45P to MD280NT90G/110P

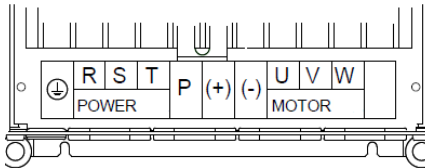

MD280 Model	Maximum Cable Size of Power Terminal (mm ² , AWG)		Torque of the Torque Driver (Kgf-cm)
T37G/45P	50	1/0	46±2
T45G/55P	50	1/0	46±2
T55G/75P	50	1/0	46±2
T75G/90P	120	250 kcmiL	98±5
T90G/110P	120	250 kcmiL	98±5

Figure 3-23 Terminal layout of MD280NT110G/132P to MD280NT400G/450P

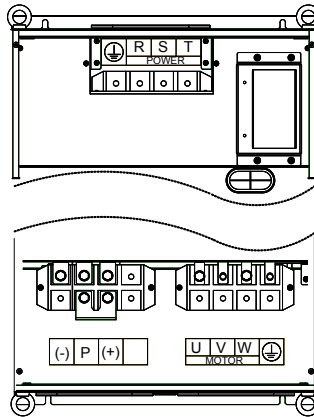

MD280 Model	Maximum Cable Size of Power Terminal (mm ² , AWG kcmil)		Torque of the Torque Driver (Kgf-cm)
T110G/132P	150	300	98±5
T132G/160P	150	300	98±5
T160G/200P	150	300	98±5
T200G/220P	360	750	245±10
T220G/250P	360	750	245±10
T250G/280P	360	750	245±10
T280G/315P	360	750	245±10
T315G/355P	360	750	245±10

3.2.5 Description of Main Circuit Terminals

■ Safety Information



- Perform wiring only after all power supply is cut off. Failure to comply will result in electric shock.
- Only qualified personnel are allowed to perform wiring. Failure to comply will result in equipment damage or personal injury.
- The device must be reliably grounded. Otherwise, it will cause electric shock or fire.

 WARNING	
<ul style="list-style-type: none"> • Ensure that the input power is consistent with the rated value of the AC drive. Otherwise, the AC drive will be damaged. • Ensure that the motor is adaptable to the AC drive. Failure to comply may result in motor damage or cause trips to the AC drive. • Do not connect the power supply to the U, V, W terminals. Otherwise, the AC drive will be damaged. • Do not connect the braking resistor directly to the (+), (-) terminals of the DC bus. Failure to comply will result in a fire. 	

■ Description of Main Circuit Terminals of Single-phase AC Drive

Table 3-3 Description of main circuit terminals of single-phase AC drive

Terminal	Name	Description
L1, L2	Single-phase power supply input terminals	Connect the single-phase 220 VAC power supply.
(+), (-)	Positive and negative terminals of DC bus	Common DC bus input points.
(+), PB	Connecting terminals of braking resistor	Connect a braking resistor.
U, V, W	AC drive output terminals	Connect a three-phase motor.
	Grounding terminal	Must be grounded.

■ Description of Main Circuit Terminals of Three-phase AC Drive

Table 3-4 Description of main circuit terminals of three-phase AC drive

Terminal	Name	Description
R, S, T	Three-phase power supply input terminals	Connect the three-phase AC power supply
(+), (-)	Positive and negative terminals of DC bus	Common DC bus input point Connect external braking unit for AC drives of 37 kW and above.
(+), PB	Connecting terminals of braking resistor	Connect the braking resistor for the AC drives of 30 kW and below.
P, (+)	Connecting terminals of external reactor	Connect an external reactor.
U, V, W	AC drive output terminals	Connect a three-phase motor.
	Grounding terminal	Must be grounded.

■ Precautions on the Wiring

1) Power input terminals L1, L2 or R, S, T

- The cable connection on the input side of the AC drive has no phase sequence

requirement. The specification and installation method of external power cables must comply with the local safety regulations and related IEC standards.

- Use copper conductors of a proper size as power cables according to the recommended values in section 8.3.
- 2) DC bus terminals (+), (-)
- Terminals (+) and (-) of DC bus have residual voltage after power-off. Do not touch them before ensuring that the CHARGE indicator becomes off and the voltage is less than 36 V. Otherwise, you may get electric shock.
 - When connecting the external braking unit for the AC drive of 37 kW or above, do not reverse poles (+) and (-). Otherwise, it may damage the AC drive and even cause a fire.
 - The cable length of the braking unit must not exceed 5 m. Use twisted pair wire or pair wires for parallel connection.
 - Do not connect the braking resistor directly to the DC bus. Otherwise, it may damage the AC drive and even cause a fire.
- 3) Terminals (+), PB for connecting the braking resistor
- The connecting terminals of the braking resistor are effective only for the AC drives configured with a built-in braking unit.
 - The cable length of the braking resistor must be smaller than 5 m. Otherwise, it may damage the AC drive.
- 4) Terminals P, (+) for connecting the external reactor

For the AC drives of 75G/90P and above, remove the jumper bar across terminals P and (+) and install the reactor between the two terminals.

- 5) AC drive output terminals U, V, W
- The capacitor or surge absorber must not be connected to the output side of the AC drive. Otherwise, it may cause frequent AC drive faults or even damage the AC drive.
 - If the motor cable is too long, electrical resonance will be generated due to the impact of distributed capacitance. This will damage the motor insulation or generate higher leakage current, thus causing the AC drive to trip in overcurrent protection. If the motor cable is greater than 100 m long, an AC output reactor must be installed close to the AC drive.
- 6) Terminal  PE
- This terminal must be grounded reliably. The resistance of the grounding cable must be less than 0.1 Ω . Otherwise, it may cause fault or damage to the AC drive.
 - Do not connect the earthing terminal to the neutral conductor of the power supply.
 - The impedance of the PE conductor must be able to withstand the large short-circuit current that may arise when a fault occurs.
 - Select the size of the PE conductor according to the following table.

Cross-sectional Area of a Phase Conductor (S)	Min. Cross-sectional Area of Protective Conductor (Sp)
$S \leq 16 \text{ mm}^2$	S
$16 \text{ mm}^2 < S \leq 35 \text{ mm}^2$	16 mm ²
$35 \text{ mm}^2 < S$	S/2

- You must use a yellow/green cable as the PE conductor.

3.2.3 Description of Control Circuit Terminals

■ Terminal Arrangement of Control Circuit

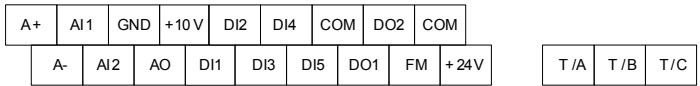

■ Description of Control Circuit Terminals

Table 3-5 Description of control circuit terminals

Type	Terminal	Name	Function Description
Power supply	+10V-GND	External +10 V power supply	Provide +10 V power supply to the external unit. Generally, it provides power supply to the external potentiometer with resistance range of 1–5 kΩ. Maximum output current: 10 mA
	+24V-COM	External +24 V power supply	Provide +24 V power supply to the external unit. Generally, it provides power supply to DI/DO terminals and external sensors. Maximum output current: 200 mA
Analog input	AI1-GND	Analog input 1	Input voltage range: 0–10 VDC (-10 to +10 VDC customized) Input impedance: 20 kΩ
	AI2-GND	Analog input 2	Input range: 0–10 VDC (-10 to +10 VDC customized) or 0–20 mA, decided by jumper J1 on the control board Input impedance: 20 kΩ (voltage input), 500 Ω (current input) Operation panel potentiometer input: switchover between AI2 and operation panel potentiometer input can be performed by jumper J2

Type	Terminal	Name	Function Description
Digital input	DI1-COM	Digital input 1	Optical coupling isolation Input impedance: 3.3 kΩ
	DI2-COM	Digital input 2	
	DI3-COM	Digital input 3	
	DI4-COM	Digital input 4	
	DI5-COM	High-speed pulse input	Optical coupling isolation Input impedance: 3.3 kΩ High-speed pulse input Maximum input frequency:50 kHz
Analog output	AO-GND	Analog output 1	Voltage or current output is decided by jumper J3. Output voltage range: 0–10 V Output current range: 0–20 mA
Digital output	DO1-COM DO2-COM	Digital output	When powered by external power supply: short 24V and EXT via jumper J7; when powered by internal power supply: short 24V and IN via jumper J7. Optical coupling isolation, open-collector output Output voltage range: 0–24 V Output current range: 0–50 mA
	FM- COM	High-speed pulse output	It is limited by F5-00 (FM terminal output mode selection). As high-speed pulse output, the maximum frequency hits 50 kHz. As open-collector output, its specification is the same as that of DO1 FM terminal can be selected as AO, FM or DO3 output.
Relay output	T/A-T/B	NC terminal	Contact driving capacity: 250 VAC, 3 A, COSφ = 0.4 30 VDC, 1 A
	T/A-T/C	NO terminal	
Auxiliary interface	A+/A-	RS485 communication port	It is the standard RS485
	Keypad	External operation panel interface	It is the standard RJ45 network cable interface and connects the external operation panel.

■ Wiring of Control Circuit Terminals

1) Wiring of AI terminals

Weak analog voltage signals are easy to suffer external interference, and therefore the shielded cable must be used and the cable length must be less than 20 m, as shown in following figure.

Figure 3-24 Wiring mode of AI terminals

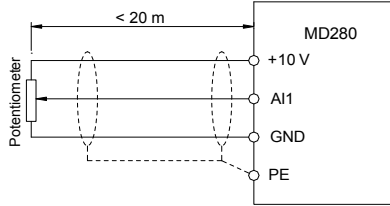

In applications where the analog signal suffers severe interference, install the filter capacitor or ferrite magnetic core at the analog signal source.

Figure 3-25 Wiring of AI terminals in special scenarios

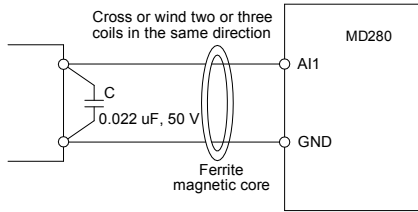

2) Wiring of DI terminals

Generally, use shielded cables not longer than 20 m. When active driving is adopted, necessary filtering measures must be taken to reduce interference to the power supply. It is recommended to use the contact control mode.

3) Wiring of DO terminal

The load is directly connected between terminals DO and +24V. There is a freewheeling absorption circuit inside the AC drive. The load current is not larger than 50 mA. If the load is too large, use a relay.



Operation and Display

Chapter 4 Operation and Display

4.1 Operation Panel

You can modify the parameters, monitor the working status and start or stop the MD280 by operating the operation panel, as shown in the following figures.

Figure 4-1 Diagram of the operation panel (without the potentiometer)

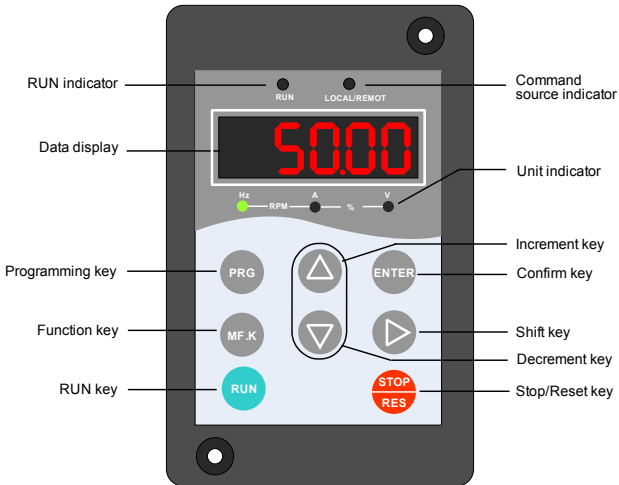







Figure 4-2 Diagram of the operation panel (with the potentiometer)







4.1.1 Description of Indicators





- RUN
ON indicates that the AC drive is in the running state, and OFF indicates that the AC drive is in the stop state.
- LOCAL/REMOT
It indicates whether the AC drive is operated by means of operation panel, terminals or communication.



 LOCAL/REMOT: OFF	Operation panel control
 LOCAL/REMOT: ON	Terminal control
 LOCAL/REMOT: blinking	Communication control





- Unit Indicators
 means that the indicator is ON, and  means that the indicator is OFF.

-RPM--- Hz: unit of frequency

-RPM--- A: unit of current

-RPM--- V: unit of voltage



-RPM--- RPM: unit of rotational speed

-RPM--- %: percentage

- Digital Display
The 5-digit LED display is able to display the set frequency, output frequency, monitoring data and fault codes.

4.1.2 Description of Keys on the Operation Panel

Table 4-1 Description of keys on the operation panel

Key	Name	Function
	Programming	Enter or exit Level I menu.
	Confirm	Enter the menu interfaces level by level, and confirm the parameter setting.
	Increment	Increase data or function code.

Key	Name	Function
	Decrement	Decrease data or function code.
	Shift	Select the displayed parameters in turn in the stop or running state, and select the digit to be modified when modifying parameters.
	RUN	Start the AC drive in the operation panel control mode.
	Stop/Reset	Stop the AC drive when it is in the running state and perform the reset operation when it is in the fault state. The functions of this key are restricted in F7-16.
	Function	Perform function switchover (such as quick switchover of command source or direction) according to the setting of F7-15.

4.2 Viewing and Modifying Function Codes

The operation panel of the MD280 adopts three-level menu.

The three-level menu consists of function code group (Level I), function code (Level II), and function code setting value (level III), as shown in the following figure.

Figure 4-3 Operation procedure on the operation panel

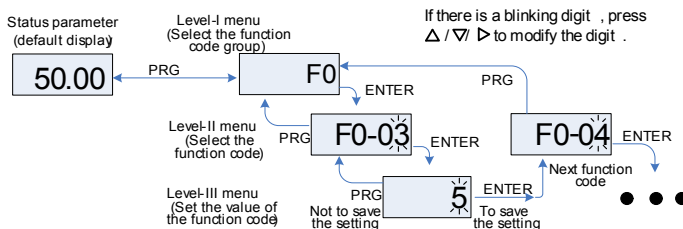

You can return to Level II menu from Level III menu by pressing or .

- After you press , the system saves the parameter setting first, and then goes back to Level II menu and shifts to the next function code.
- After you press , the system does not save the parameter setting, but directly returns to Level II menu and remains at the current function code.

Here is an example of changing the value of F1-06 to 15.00 Hz.

Figure 4-4 Example of changing the parameter value

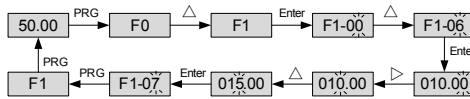

In Level III menu, if the parameter has no blinking digit, it means that the parameter cannot be modified. This may be because:

- Such a function code is only readable, such as, AC drive model, actually detected parameter and running record parameter.
- Such a function code cannot be modified in the running state and can only be changed at stop.

In the function code display state, select the required function code pressing or .

4.3 Viewing Status Parameters

In the stop or running state, you can press on the operation panel to display status parameters. Whether parameters are displayed is determined by the binary bits of values converted from the values of F7-13 and F7-14 in the hexadecimal format.

In running state, a total of 16 running status parameters can be displayed by default, set in F7-13, as listed in the following table.

Function Code	Parameter Name	Setting Range	Default
F7-13	LED display running parameters	1-65535 	799

In stop state, a total of eight status parameters can be displayed, as listed in the following table.

Function Code	Parameter Name	Setting Range	Default
F7-14	LED display stop parameters	1–511 	51

When the AC drive is powered on again after power failure, the parameters that are selected before power failure are displayed.

Select the required parameters by pressing . The following example shows how to set F7-13 to display the running parameters on LED.

- 1) Assume that the following parameters need to be displayed:
Running frequency, bus voltage, output voltage, output current, output power, and PID feedback
- 2) Set the corresponding bit of each parameter to be displayed to 1.
- 3) Convert the binary data to a decimal value, and set this value in F7-13.

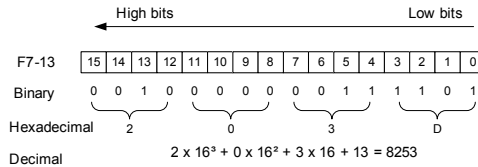



4.4 Starting or Stopping the AC Drive

4.4.1 Selecting the Start/Stop Command Source

There are three start/stop command sources, namely, operation panel control, terminal control, and communication control. You can select the command source in F0-00.

Function Code	Parameter Name	Setting Range	Description	Default
F0-00	Command source selection	0: Operation panel control (indicator OFF) 1: Terminal control (indicator ON) 2: Communication control (indicator blinking)	Press or to start or stop the AC drive. A DI terminal needs to be defined as the run/stop terminal. The Modbus-RTU communication protocol is used.	0

- 0: Operation panel control

After you press  , the AC drive starts running (the RUN indicator is ON). After you press  when the AC drive is in running state, the AC drive stops running (the RUN indicator is OFF).

- 1: Terminal control

This control mode is applicable to scenarios where the DIP switch or electromagnetic button is used to start or stop the application system or scenarios where the dry contact signal is used to start or stop the AC drive.

The switch signal mode is set in F2-06. The input terminal of the start/stop signal is set in F2-00 to F2-04. For details, see the description of F2-06 and F2-00 to F2-04.

Example 1:

To use the DIP switch as the start/stop source, and allocate the forward rotation switch signal to DI2 and the reverse rotation switch signal to DI3, perform the setting as shown in the following figure.

Figure 4-5 Setting of using the DIP switch for start/stop

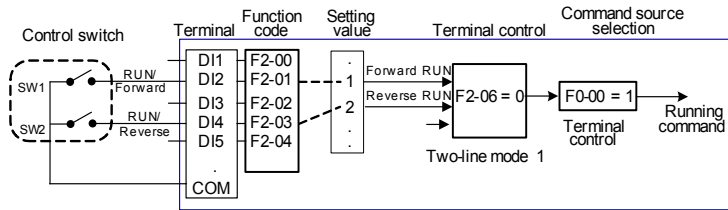

In the preceding figure, when SW1 is ON, the AC drive instructs forward rotation; when SW1 is OFF, the AC drive stops. When SW2 is ON, the AC drive instructs reverse running; when SW2 is OFF, the AC drive stops. If SW1 and SW2 are ON or OFF simultaneously, the AC drive stops.

Example 2:

To use the electromagnetic button as the start/stop source, and allocate the startup signal to DI2, stop signal to DI3 and reverse rotation signal to DI4, perform the setting as shown in the following figure.

Figure 4-6 Setting of using the electromagnetic button for start/stop

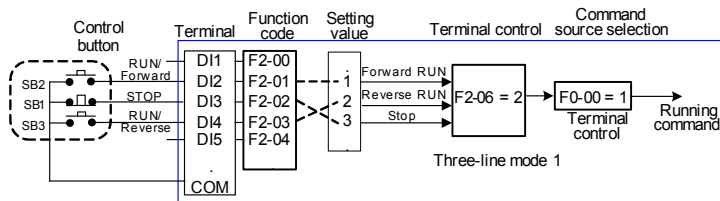

In the preceding figure, SB1 must stay ON during normal start and running. The AC drive stops immediately after SB1 becomes OFF. The signals from SB2 and SB3 become valid once the two buttons become ON. The running state of the AC drive is determined by the final actions on the three buttons.

- 2: Communication control

The MD280 provides the RS485 communication port for interaction with the host computer (PC or PLC). You can set the running command and function codes, and acquire the working state and fault information of the AC drive through communication.

Set F0-00 to 2. Then, you can start or stop the AC drive in communication mode. The following figure shows the setting method.

Figure 4-7 Setting for start/stop using the communication control mode

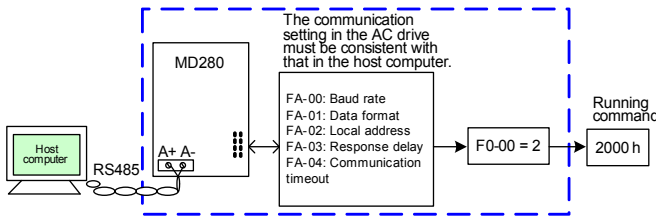

When FA-04 is set to a non-zero number, the function of automatic AC drive stop upon communication timeout is enabled. This prevents uncontrollable AC drive running due to faults of the communication cable or the host computer.

The communication port of the AC drive supports the Modbus-RTU protocol, and the communication is implemented only when the host computer supports the Modbus-RTU master station protocol.

4.4.2 Start Mode

The MD280 supports two start modes, namely, direct start and rotational speed tracking restart, set in F4-00.

- F4-00 = 0 (direct start)

It is applicable to small-inertia load. The frequency curve in this mode is shown in the following figure.

"DC braking" before the start is applicable to drive of load such as elevator and crane. "Startup frequency" is applicable to drive with burst start under start torque, such as cement mixer.

Figure 4-8 Frequency curve of direct start

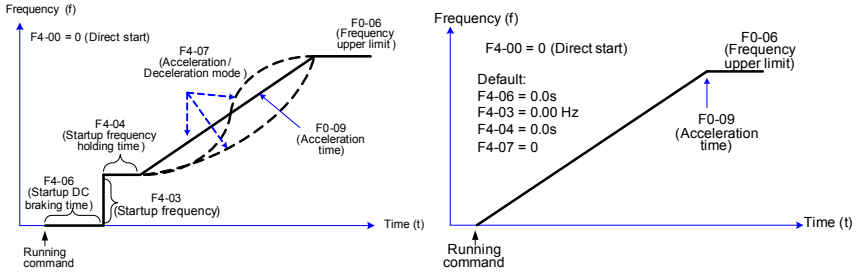

- F4-00 = 1 (Rotational speed tracking restart)

It is applicable to large-inertia load. The frequency curve in this mode is shown in the following figure. If the motor is still rotating due to the inertia when the AC drive starts, this mode is used to prevent start overcurrent.

Figure 4-9 Frequency curve of rotational speed tracking restart

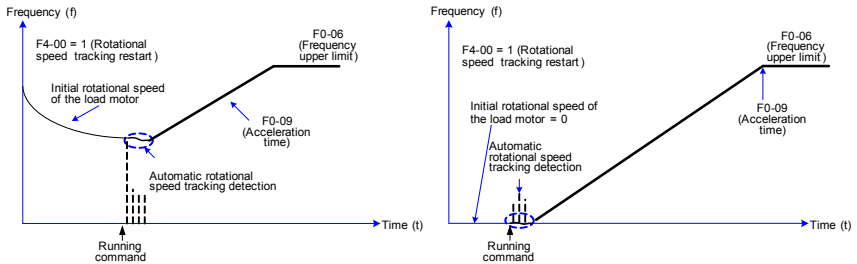

4.4.3 Stop Mode

The AC drive supports two stop modes, decelerate to stop and coast to stop, set in F4-10.

Figure 4-10 Diagram of two stop modes (decelerate to stop and coast to stop)

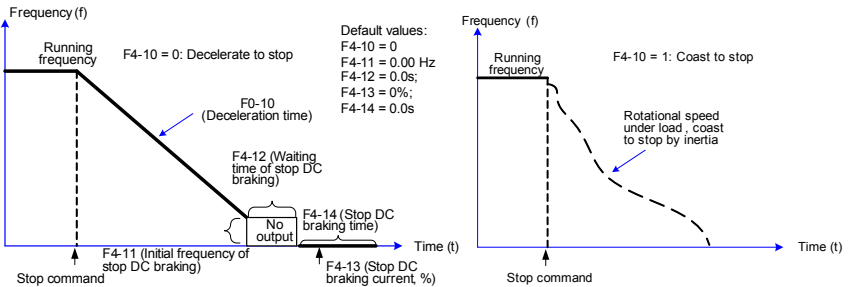

4.4.4 Timing Stop

The MD280 supports timing stop. The timing duration is set in F5-12; when it is set to 0, the timing stop function is disabled. When F5-13 is set to 1, the AC drive automatically stops when the accumulative running time reaches the set time.

Figure 4-11 Setting of the timing stop function

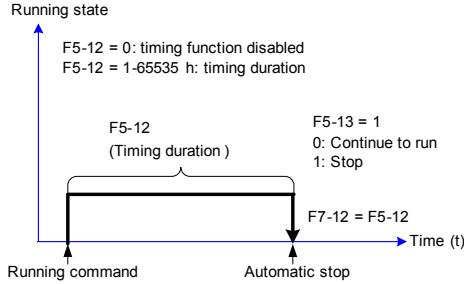

For more details, see the description of F5-12 and F5-13.

4.5 JOG Running

In certain applications, the AC drive needs to run at a low speed temporarily to facilitate equipment test or other commissioning operations. In this case, you can set the AC drive to perform JOG running.

Figure 4-12 JOG running

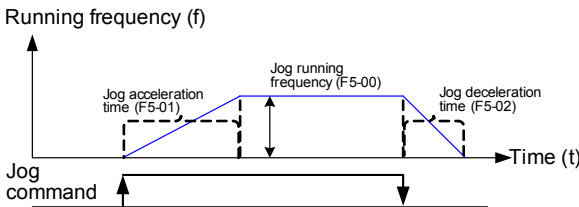

Parameter Setting and Operation of JOG Running in Operation Panel Control

Figure 4-13 JOG running in operation panel control

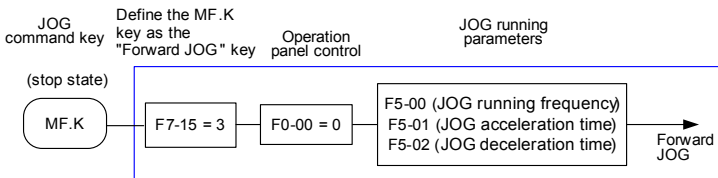

Set the parameters according to the preceding figure. In stop state of the AC drive, hold down **MF.K**, and the AC drive starts JOG running. After you release **MF.K**, the AC drive decelerates to stop.

To perform reverse JOG, set F0-12 to 1. Hold down **M.F.K** and the AC drive starts reverse JOG running.

Note

If the reverse jog running cannot be implemented after setting F0-12 to 1, check and make sure F5-09 is set to 0.

■ Parameter Setting and Operation of JOG Running in DI Terminal Control

For equipment that requires frequent JOG operations, such as textile machine, it is more convenient to control JOG running by using keys or buttons. You need to install two extra buttons, namely FJOB and RJOB buttons, to realize such operation. To achieve convenient control, perform the setting according to the following figure.

Figure 4-14 JOG running in DI terminal control

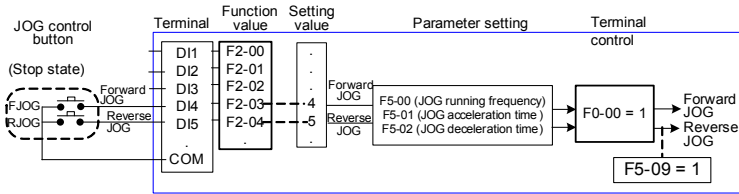

After performing the setting according to the preceding figure, press the FJOB button when the AC drive is in stop state. Then, the AC drive starts forward JOG running. After you press the FJOB button again, the AC drive decelerates to stop.

4.6 Setting the Running Frequency

The AC drive provides two frequency sources, namely, main frequency source X and auxiliary frequency source Y. You can select one frequency source and switch over between the two sources. You can also perform superposition on the two sources by setting the calculation formula to meet different control requirements of different scenarios.

4.6.1 Frequency Setting by the Main Frequency Source

There are 10 setting modes of main frequency sources, digital setting (terminal UP/DOWN), AI1, AI2, pulse setting, multi-reference, simple PLC, PID, communication setting, PID+AI1, and PID+AI2. You can select one in F0-01.

Figure 4-15 Frequency set by the main frequency source

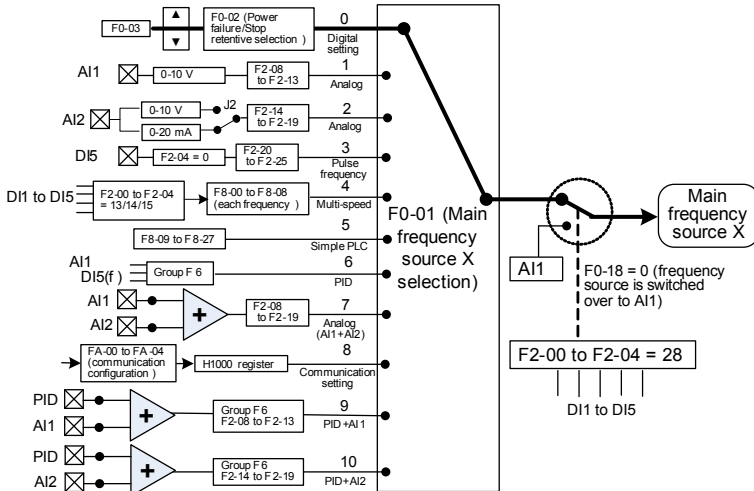

According to the preceding figure, the running frequency of the AC drive can be set by means of function codes, manual adjustment, analog input, multi-speed terminal, external feedback signal, internal PID regulator, or the host computer.

Set the corresponding function codes of each frequency setting mode, as shown in the preceding figure.

4.6.2 Frequency Setting by the Auxiliary Frequency Source

The frequency setting by the auxiliary frequency source is the same as the frequency setting by the main frequency source. You can set the auxiliary frequency source in F0-04.

Figure 4-16 Frequency set by the auxiliary frequency source

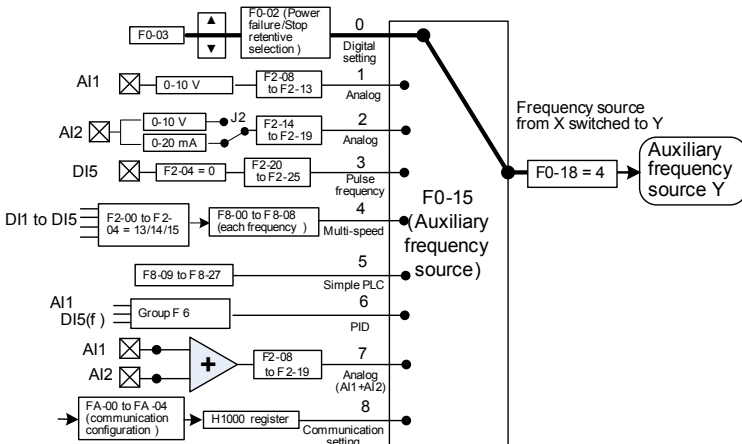

The relationship between the target running frequency and the main/auxiliary frequency source is set in F0-18, as follows:

- 1) Main frequency source X: The main frequency source is directly used to set the target running frequency.
- 2) Auxiliary frequency source Y: The auxiliary frequency source is directly used to set the target running frequency.
- 3) X and Y superposition: The target running frequency is set by means of X and Y superposition.
- 4) Frequency switchover: A DI terminal is used to switch over between the preceding three frequency setting channels.

The following figure shows how to set the relationship in F0-18, in which the bold line indicates the default setting.

Figure 4-17 Relationship between the target running frequency and main and auxiliary frequency sources

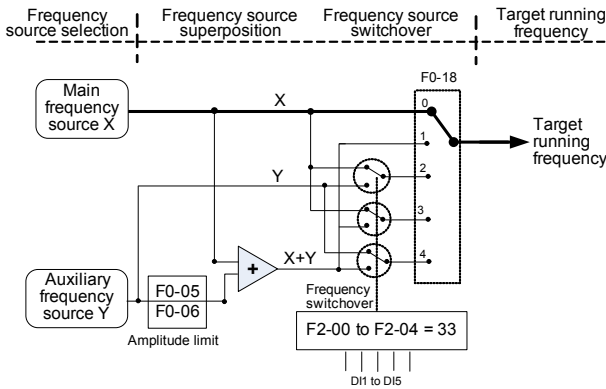

The superposition between the main frequency source and the auxiliary frequency source can be used for closed-loop speed control. For example, using the main frequency source for setting the required frequency and the auxiliary frequency source for automatic adjustment, in conjunction with switchover performed by the external DI terminal signal, the required closed-loop control can be implemented.

4.6.3 AI as the Frequency Source

The AI terminal can be used as the frequency source. The MD280 provides two AI terminals (AI1 and AI2). When an external operation panel (with the potentiometer) is used, the potentiometer is used for AI2 by default, and this function is realized by jumper J2 on the control board.

The following figures show how to use the AI as the frequency source.

Figure 4-18 Voltage input of AI1 connected to the potentiometer as the frequency source (2–10 V corresponding to 10–40 Hz)

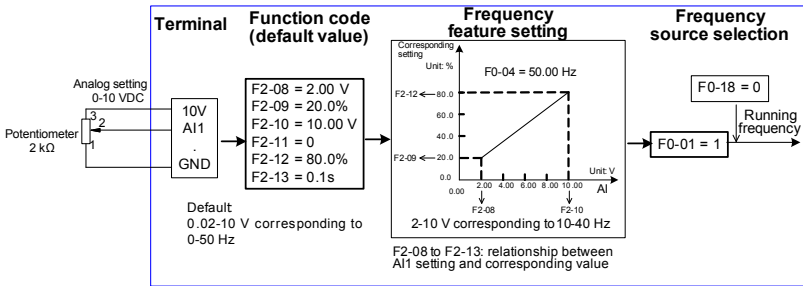
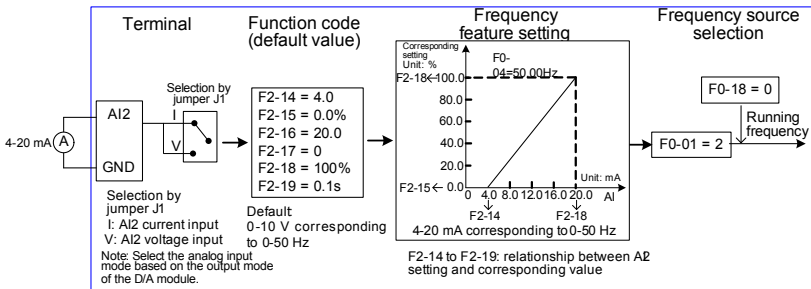

Figure 4-19 Current input of AI2 connected to 4DA module of the PLC as the frequency source (4–20 mA corresponding to 0–50 Hz)



Note

1. The MD280 provides two AI terminals (AI1 and AI2). AI1 provides 0–10 V voltage input. AI2 provides 0–10 V voltage input or 0–20 mA current input, determined by jumper J1 on the control board. AI3 provides -10 V to +10 V bipolar voltage input.
2. When AI is used as the frequency source, 100% of the voltage or current input corresponding setting corresponds to the maximum frequency in F0-04.
3. F2-11 and F2-17 can not be set to 1 at the same time. Otherwise, AI1 and AI2 will become invalid due to the corresponding setting conflict.
4. The potentiometer of the external operation panel and AI2 terminal on the AC drive can not function at the same time. Jumper J2 on the control board decides which one works.
5. Analog setting and the corresponding values are set in F2-08 to F2-19.

4.6.4 Pulse Setting as the Frequency Source

In many scenarios, pulse input is used as the frequency source. The specifications of pulse signals are: voltage 9–30 V, frequency 0–50 kHz.

Only DI5 can be used for pulse input. The relationship between pulse input from DI5 and the corresponding setting is set in F2-20 to F2-25. The relationship is a two-point line, and

100% of pulse input corresponding setting corresponds to the maximum frequency of F0-04, as shown in the following figure.

Figure 4-20 Pulse setting as the frequency source

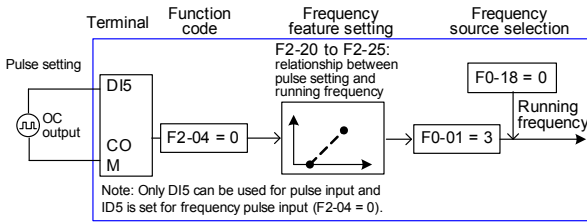

4.6.5 Frequency Closed-Loop Control

The MD280 has a built-in PID regulator. Together with the frequency sources, the PID regulator can implement automatic adjustment of process control, such as constant temperature, constant pressure, and tension control.

Figure 4-21 Automatic adjustment by PID regulator

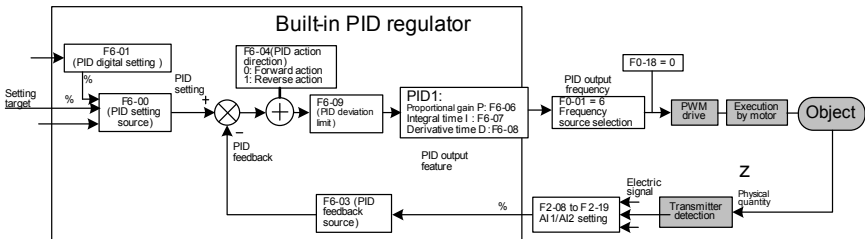

When PID frequency closed-loop control is implemented, F0-01 (Main frequency source X selection) must be set to 6 (PID). The PID-related parameters are set in group F6, as shown in the preceding figure.

4.6.6 Swing Mode

For the textile and chemical fiber processing equipment, the swing function improves the uniform density of traversing and winding, as shown in the following figure. The function is set in F7-00 to F7-04. For details, see the description of these function codes.

Figure 4-22 Swing function

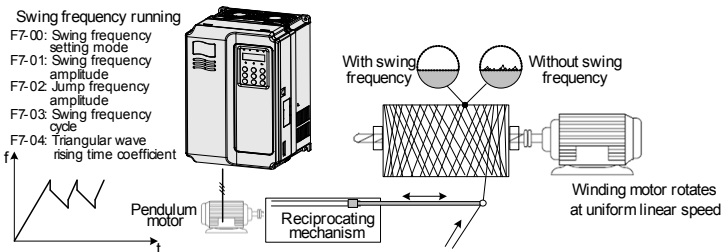

4.6.7 Multi-Speed Mode

In scenarios where the running frequency of the AC drive need not be adjusted continuously and only several frequencies are required, the multi-speed control can be used. The MD280 supports a maximum of eight running frequencies, which are implemented by state combinations of three DI terminals. Set the function codes corresponding to DI terminals to a value among 13 to 15, and then the DI terminals are specified as the multi-frequency input terminals. The multiple frequencies are set based on the multi-frequency table in group F8. In addition, you need to set F0-01 (Main frequency source X selection) to 6 (Multi-reference). The following figure shows how to set the multi-speed function.

Figure 4-23 Setting the multi-speed function

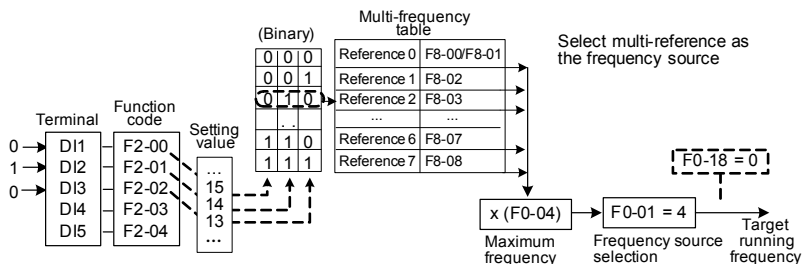

In the preceding figure, DI3, DI2 and DI1 are used as the multi-frequency input terminals, each of which has a bit value. The state combinations of these terminals correspond to multiple frequencies. When (DI3, DI2, DI1) = (0, 1, 0), the state combination value is 2, corresponding to the value set in F8-02. The target running frequency is automatically calculated by (F8-02) x (F0-04).

The MD280 supports a maximum of three DI terminals to be used as the multi-frequency input terminals. You can also use less than three DI terminals, and the empty bit is considered to be 0.

4.6.8 Setting the Motor Rotating Direction

After the AC drive restores the default settings, press **RUN** to drive the motor to rotate. In this case, the rotating direction is regarded as the forward rotation. If the rotating direction is reverse to the direction required by the equipment, power off the AC drive and exchange any two of the output UVW cables (wait until the main capacitor of the AC drive is completely discharged).

In some applications where both forward rotation and reverse rotation are required, enable the reverse control (F5-09 = 0, default value) and meanwhile reverse the rotating direction by setting F0-12 to 1. Then press **RUN** to make the motor rotate in the reverse direction, as shown in the following figure.

Figure 4-24 Reversing the motor rotating direction

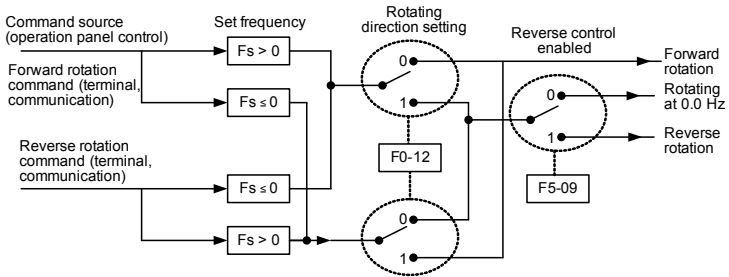

According to the preceding figure, when the running frequency of the AC drive is set by means of communication (F0-01 = 8) and reverse control is enabled (F5-09 = 0), the AC drive instructs the reverse direction if the set frequency Fs is a negative value.

If the give running command is reverse rotation or the set frequency is a negative value, but reverse control is disabled (F5-09 = 1), the AC drive will run at 0 Hz and has no output.

In some applications where reverse rotation is prohibited, do not change the rotating direction by modifying the function codes because the function codes will be restored once the AC drive restores the default settings.

4.6.9 Setting the Fixed Length Control Mode

The MD280 has the fixed length control function. The length pulses are sampled by the DI allocated with function 25 (Length count input). The "Actual length" (F7-06) is obtained by dividing the number of pulses sampled by the value of F7-07 (Number of pulses per meter). If the actual length is larger than the "Set length" (F7-05), the multifunctional DO terminal becomes ON.

In the process of fixed length control, the length can be reset by means of the DI terminal allocated with function 26 (Length reset). The related setting is shown in the following figure.

Figure 4-25 Function code setting for fixed length control

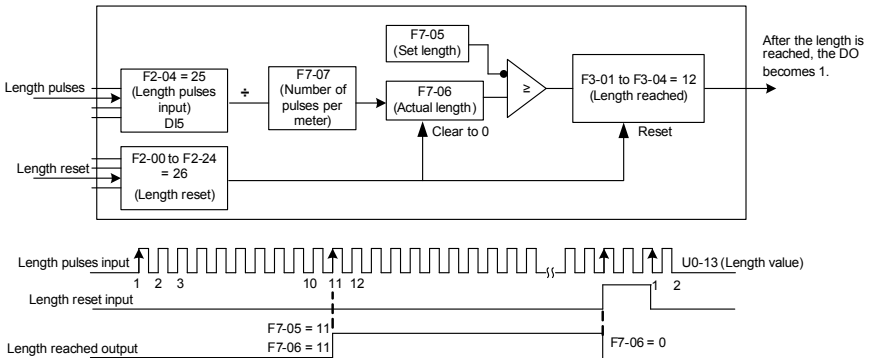

Note

- In the fixed length control mode, the direction cannot be identified and only the length shall be calculated based on the number of pulses.
- Only DI5 can be allocated with the function "Length count input".
- An automatic stop system can be implemented if the length reached signal output by the DO is fed back to the AC drive input terminal with the stop function.

Figure 4-26 Common application example of the fixed length control function

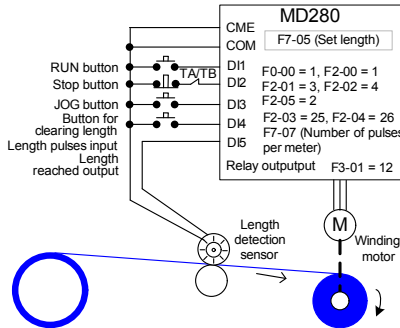

4.6.10 Use of the Counting Function

The count value needs to be collected by the DI terminal that is allocated with function 23. When the count value reaches F7-08 (Set count value), the DO terminal allocated with function 10 (Set count value reached) becomes ON. Then the counter stops counting.

When the count value reaches F7-09 (Designated count value), the DO terminal allocated with function 11 (Designated count value reached) becomes ON. The counter continues to count until "Set count value" is reached.

Figure 4-27 Parameter setting in the counting mode

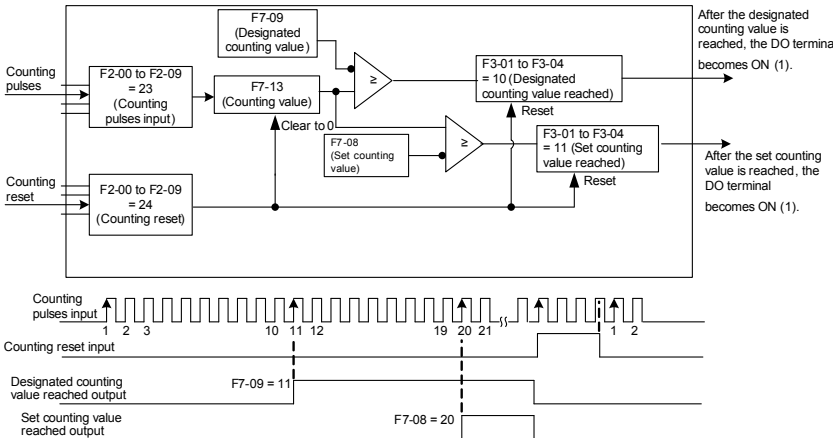

Note

- F7-09 (Designated count value) must not be greater than F7-08 (Set count value).
- DI5 must be used when the pulse frequency is high.
- The DO terminal that is allocated with function 11 (Designated count value reached) and the DO terminal that is allocated with function 10 (Set count value reached) must not be the same.
- In the RUN/STOP state of the AC drive, the counter will not stop until "Set count value" is reached.
- The count value is retentive at power failure.
- An automatic stop system can be implemented if the signal output by the DO terminal with the function (Count value reached) is fed back to the DI terminal of the AC drive with stop function.

4.7 Setting and Auto-tuning of Motor Parameters

4.7.1 Motor Parameters to Be Set

The MD280 AC drive adopts V/F mode to drive the motor. Accurate motor parameters are required to ensure desired driver performance and running efficiency. Set the motor parameters according to the nameplate.

Motor parameters (motor 1 by default) that need to be set are listed in the following table.

Table 4-2 Motor parameters to be set

Function Code	Parameter Name	Remarks
F1-00	Rated motor power	Model dependent, manual input
F1-01	Rated motor voltage	
F1-02	Rated motor current	
F1-03	Rated motor frequency	

After setting the motor parameters correctly, set F1-18 to 1 to start static motor auto-tuning to obtain the stator resistance of the motor automatically. For details, see the description of F1-18.

4.7.2 Switchover Between Motor 1 Parameters and Motor 2 Parameters

The AC drive supports switchover between two groups of motor parameters, namely, group F1 (F1-00 to F1-03) and group FC.

You can select the current effective group of motor parameters by means of DI terminal with function 32.

Figure 4-28 Switchover between motor 1 and motor 2

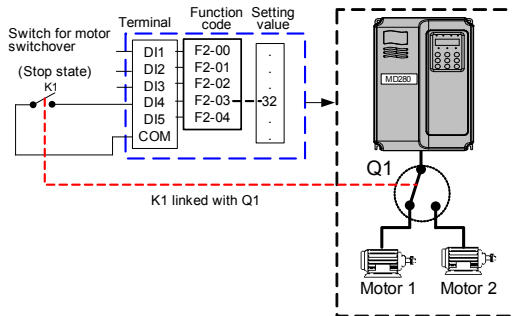

4.8 Use of DI Terminals

The control board provides five DI terminals DI1 to DI5.

The internal hardware of DI terminals is configured with 24 VDC power supply for detection. You can input a signal to a DI terminal of the AC drive only by shorting the DI terminal and COM.

By default, a DI terminal is active (logic 1) when being shorted with COM and inactive (logic 0) when being not shorted with COM.

You can change the DI terminal active mode. That is, a DI terminal is inactive (logic 0) when shorted with COM, and active (logic 1) when not shorted to COM. Set the active mode in F2-26 (bit0 to bit4 in the value of this function code respectively specify the active mode setting of DI1 to DI5; set the corresponding bit to 1 and convert the binary value to a decimal value).

The AC drive also provides F2-05 (DI filter time) for the DI signal to improve the anti-interference level.

The five DI terminals can be defined in function codes F2-00 to F2-04. Each DI can be allocated with their respective function from the 33 functions. For details, see descriptions of F2-00 to F2-04.

The hardware design allows only DI5 to receive high-speed pulse signal. If high-speed pulse count is required, use DI5.

4.9 Use of DO Terminals

The MD280 provides a multi-function FM terminal (FMP, AO or DO3), a relay output terminal, and two DO terminals (DO1 and DO2). FM, DO1, and DO2 are transistor outputs and can drive 24 VDC low-voltage circuit; TA/TB/TC is relay output, and can drive 250 VAC control circuit.

Set the function of the multi-function FM terminal (FMP, AO or DO3; only one function can be enabled each time) in F3-00. When the FM terminal is used as DO3, the usage is the same as that of DO1 and DO2. When F3-00 is set to 0, the FM terminal provides high-speed pulse output, indicating the values of internal running parameters. The highest pulse frequency is 50 kHz. For details, see the description of F3-05.

The relay output terminals are TA/TB/TC, where TA is the common terminal, TB is a normally

closed (NC) terminal, and TC is a normally open (NO) terminal.

You can define the functions of the DO terminals by setting F3-01 and F3-02 to indicate the running state and alarm information of the AC drive. There are a total of 20 functions. For details, see the descriptions of group F3.

Terminal	Corresponding Function Code	Output Feature Description
FM-COM	F3-05 when F3-00 = 0	Transistor, able to output high-speed pulses of 50 KHz; drive capacity: 24 VDC, 50 mA
	F3-04 when F3-00 = 1	Transistor; drive capacity: 24 VDC, 50 mA
	F3-05 when F3-00 = 2	Output voltage: 0–10 V Output current: 0–20 mA
TA-TB-TC	F3-01	Relay; drive capacity: 250 VAC, 3 A
DO1-COM	F3-02	Transistor; drive capacity: 24 VDC, 50 mA

When F5-00 = 0, the FM terminal is high-speed pulse output. The frequency of output pulses indicates the value of the internal running parameters. The greater the value is, the higher the output pulse frequency is. The 100% value corresponds to 100 kHz. The property of the indicated internal parameter is defined by F5-06.

4.10 Use of AI Terminals

The AC drive supports a total of two AI terminals. The AI can provide the voltage or current for frequency source setting, torque setting, PID setting or feedback source, and can also be used as DI. The relationship between the physical quantities and the voltage corresponding setting or current corresponding setting is set in F2-08 to F2-19.

Terminal	Input Signal Characteristic
AI1-GND	It receives the signal of 0–10 VDC.
AI2-GND	If J1 is connected to the position with "V" mark, it receives the signal of 0–10 VDC. If J8 is connected to the position with "I" mark, it receives the signal of 4–20 mA.

Figure 4-29 Relationship between analog input and corresponding setting

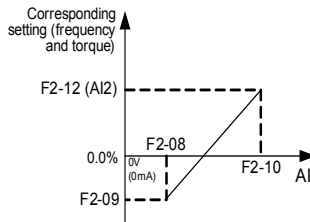

4.11 Use of AO Terminals

The AC drive provides a multi-function FM terminal, which can be defined as the AO terminal in F3-00.

Terminal	Output Signal Characteristic
AO-GND	If J3 is connected to the position with "V" mark, it outputs the signal of 0-10 VDC. If J3 is connected to the position with "I" mark, it outputs the signal of 0-20 mA.

The AO can be used to indicate the internal running parameters in the analog mode. The property of indicated parameters can be defined in F3-05.

The designated running parameters can be rectified before output. The rectification feature is $Y = kX + b$, among which "X" indicates the running parameters to be output, and "k" and "b" of the AO can be set by F3-06 and F3-07.

Figure 4-30 Setting of "k" and "b" of AO1

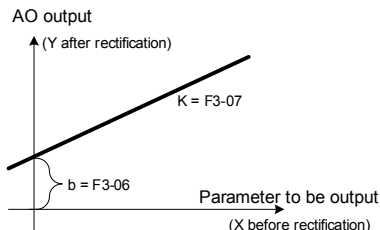

4.12 Use of Serial Communication

The MD280 provides the RS485 communication port for interaction with the host computer (PC or PLC). If the communication port of the external device is RS232, you need to add a RS232/RS485 converter.

The communication parameters are set in group FA. The setting of the communication parameters in the AC drive must be consistent with that in the host computer; otherwise, communication fails.

The serial communication port supports the Modbus-RTU slave protocol. On the host computer, you can send the running command to the AC drive, set function codes, and read the working state and fault information of the AC drive by means of communication.

Figure 4-31 Communication control mode of the AC drive

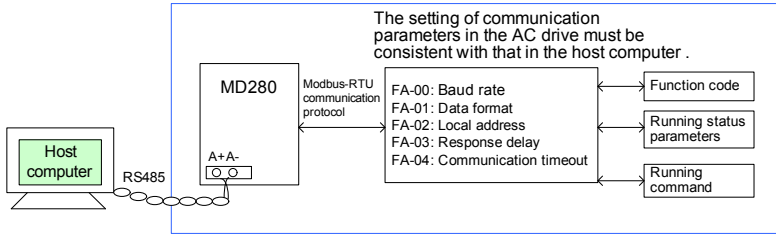

The MD280 arranges the function codes, running state parameters and running commands in the "register parameter address" mode. The host computer can define the protocol for communication data interaction.

4.13 Password Setting

The AC drive provides the user password protection function. When FP-00 is set to a non-zero value, the value is the user password. The password takes effect after you exit the function code editing state. When you press **PRG** again, "-----" will be displayed, and you must enter the correct user password to enter the menu.

To cancel the password protection function, enter with password and set FP-00 to 00000.

4.14 Default Initialization

After a function code is modified on the operation panel, the modification will be saved in the register of the AC drive and remain effective at next power-on.

The AC drive also provides the retentive function on alarm information and accumulative running time.

You can restore default settings of the function codes or clear the running data through FP-01. For details, see the description of FP-01.

Figure 4-32 Parameter saving and default parameter restoring

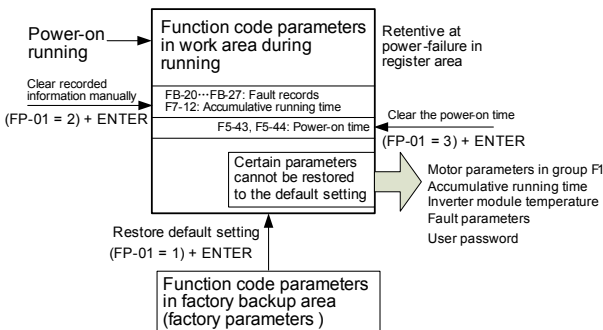



Function Code Table

Chapter 5 Function Code Table

If FP-00 is set to a non-zero number, parameter protection is enabled. You must enter the correct user password to enter the menu.

To cancel the password protection function, enter with password and set FP-00 to 0.

The symbols in the function code table are described as follows:

"☆": The parameter can be modified when the AC drive is in either stop or running state.

"★": The parameter cannot be modified when the AC drive is in the running state.

"●": The parameter is the actually measured value and cannot be modified.

"***": The parameter is factory parameter and can be set only by the manufacturer.

Function Code	Parameter Name	Setting Range	Min. Unit	Default	Property
Group F0: Basic Parameters					
F0-00	Command source selection	0: Operation panel control (indicator OFF) 1: Terminal control (indicator ON) 2: Communication control (indicator blinking)	1	0	☆
F0-01	Main frequency source X selection	0: Digital setting (UP/DOWN modification) 1: A11 2: A12 3: Pulse setting (DI5) 4: Multi-reference 5: Simple PLC 6: PID 7: A11+A12 8: Communication setting 9: PID+A11 10: PID+A12	1	0	★
F0-02	Retentive of digital setting frequency	0: Not retentive 1: Retentive at power failure 2: Retentive at stop 3: Retentive at both power failure and stop	1	0	☆
F0-03	Preset frequency	0.00 to maximum frequency (F0-04)	0.01 Hz	50.00 Hz	☆

Function Code	Parameter Name	Setting Range	Min. Unit	Default	Property
F0-04	Maximum frequency	50.00–630.00 Hz	0.01 Hz	50.00 Hz	★
F0-05	Source of frequency upper limit	0: Set by F0-06 1: AI1 2: AI2 3: Pulse setting (DI5)	1	0	★
F0-06	Frequency upper limit	F0-07 to F0-04	0.01 Hz	50.00 Hz	☆
F0-07	Frequency lower limit	0.00 Hz to F0-06	0.01 Hz	0.00 Hz	☆
F0-08	Acceleration/Deceleration time unit	0: s (second) 1: m (minute)	1	0	★
F0-09	Acceleration time 1	0.00–300.00s (m)	0.01s (m)	Model dependent	☆
F0-10	Deceleration time 1	0.00–300.00s (m)	0.01s (m)	Model dependent	☆
F0-11	Carrier frequency	0.5–16.0 kHz	0.1 kHz	Model dependent	☆
F0-12	Rotation direction	0: Same direction 1: Reverse direction	1	0	☆
F0-13	Acceleration/Deceleration time base frequency	0: Maximum frequency (F0-04) 1: Set frequency	1	0	★
F0-14	Base frequency for UP/DOWN modification during running	0: Running frequency 1: Set frequency	1	0	☆
F0-15	Auxiliary frequency source Y selection	0: Digital setting (UP/DOWN modification) 1: AI1 2: AI2 3: Pulse setting (DI5) 4: Multi-reference 5: Simple PLC 6: PID 7: AI1+AI2 8: Communication setting	1	0	★
F0-16	Base of auxiliary frequency Y	0: Relative to maximum frequency 1: Relative to main frequency X	1	0	☆

Function Code	Parameter Name	Setting Range	Min. Unit	Default	Property
F0-17	Range of auxiliary frequency Y	0%–150%	1%	100%	☆
F0-18	Frequency source superposition	0: Main frequency source X 1: X and Y superposition 2: Switchover between X and Y 3: Switchover between X and "X and Y superposition" 4: Switchover between Y and "X and Y superposition"	1	0	☆
F0-20	Frequency offset of auxiliary frequency source for X and Y superposition	0.00 Hz to maximum frequency (F0-04)	0.01 Hz	0.00 Hz	☆
F0-21	Carrier frequency adjustment with temperature	0: No 1: Yes	1	1	☆
F0-22	Binding command source to frequency source	Unit's digit (Binding operation panel command to frequency source): 0: No binding 1: Frequency source by digital setting 2: AI1 3: AI2 4: Pulse setting (DI5) 5: Multi-reference 6: Simple PLC 7: PID 8: AI1+AI2 9: Communication setting Ten's digit (Binding terminal command to frequency source): 0–9, same as unit's digit Hundred's digit (Binding communication command to frequency source): same as unit's digit	1	000	☆
Group F1: Motor Parameters and V/F Control Parameters					
F1-00	Rated motor power	0.2–1000.0 kW	0.1 kW	Model dependent	★
F1-01	Rated motor voltage	1–480 V	1 V	Model dependent	★

Function Code	Parameter Name	Setting Range	Min. Unit	Default	Property
F1-02	Rated motor current	0.1–6553.5 A	0.1 A	Model dependent	★
F1-03	Rated motor frequency	0.00 Hz to maximum frequency (F0-04)	0.01 Hz	Model dependent	★
F1-04	V/F curve setting	0: Linear V/F 1: Multi-point V/F 2: Square V/F	1	0	★
F1-05	Torque boost	0.0%–30.0% 0.0%: Fixed	0.1%	Model dependent	☆
F1-06	Cut-off frequency of torque boost	0.00 Hz to maximum frequency (F0-04)	0.01 Hz	50.00 Hz	★
F1-07	Multi-point V/F frequency 1 (f1)	0.00 Hz to F1-09	0.01 Hz	0.00 Hz	★
F1-08	Multi-point V/F voltage 1 (v1)	0.0%–100.0%	0.1%	0.0%	★
F1-09	Multi-point V/F frequency 2 (f2)	F1-07 to F1-11	0.01 Hz	0.00 Hz	★
F1-10	Multi-point V/F voltage 2 (v2)	0.0%–100.0%	0.1%	0.0%	★
F1-11	Multi-point V/F frequency 3 (f3)	F1-09 to F1-03	0.01 Hz	0.00 Hz	★
F1-12	Multi-point V/F voltage 3 (v3)	0.0%–100.0%	0.1%	0.0%	★
F1-13	Slip compensation coefficient	0%–200.0%	0.1%	0.0%	☆
F1-14	Over-excitation gain	0–200	1	64	☆
F1-15	No-load current	0.1 A to F1-02	0.1 A	Model dependent	☆
F1-16	Stator resistance	0.001–65.535 Ω	0.001 Ω	Model dependent	☆
F1-17	Oscillation suppression gain	0–100	1	Model dependent	☆
F1-18	Auto-tuning selection	0: No auto-tuning 1: Static auto-tuning	1	0	★
F1-19	Oscillation suppression mode	0–4	1	1	☆

Function Code	Parameter Name	Setting Range	Min. Unit	Default	Property
Group F2: Input Terminals					
F2-00	DI1 function selection	0: No function 1: Forward RUN (FWD) 2: Reverse RUN (REV) 3: Three-line control 4: Forward JOG (FJOG) 5: Reverse JOG (RJOG) 6: Terminal UP 7: Terminal DOWN 8: Coast to stop 9: Fault reset (RESET) 10: RUN pause 11: Normally open (NO) input of external fault	1	1	★
F2-01	DI2 function selection	12: Normally closed (NC) input of external fault 13: Multi-reference terminal 1 14: Multi-reference terminal 2 15: Multi-reference terminal 3 16: Terminal for acceleration/ deceleration time selection 17: UP and DOWN setting clear 18: DC braking 19: Acceleration/Deceleration prohibited 20: PID pause	1	2	★
F2-02	DI3 function selection	21: PLC status reset 22: Swing pause 23: Counter input 24: Counter reset 25: Length count input 26: Length reset 27: Exchange of AI1 and AI2 settings 28: Frequency source switched over to AI1 29: DC braking at stop enabled (To be continued)	1	4	★

Function Code	Parameter Name	Setting Range	Min. Unit	Default	Property
F2-03	DI4 function selection	30: Command source switchover to operation panel control 31: Command source switchover to terminal control 32: Motor switchover 33: Frequency source switchover 34: Lock running frequency	1	8	★
F2-04	DI5 function selection	35: Select main frequency source 36: Select auxiliary frequency source 37: Motor switchover during running (End)	1	0	★
F2-05	DI filter time	0–10	1	4	☆
F2-06	Terminal command mode	0: Two-line mode 1 1: Two-line mode 2 2: Three-line mode 1 3: Three-line mode 2	1	0	★
F2-07	Terminal UP/DOWN rate	0.01–100.00 Hz/s	0.01 Hz/s	1.00 Hz/s	☆
F2-08	AI1 minimum input	0.00 V to F2-10	0.01 V	0.02 V	☆
F2-09	Corresponding setting of AI1 minimum input	-100.00%–100.0%	0.1%	0.0%	☆
F2-10	AI1 maximum input	F2-08 to 10.00 V	0.01 V	10.00 V	☆
F2-11	Corresponding setting mode of AI1 maximum input	0: F2-12 1: Determined by AI2	1	0	★
F2-12	Corresponding setting of AI1 maximum input	-100.00%–100.0%	0.1%	100.0%	☆
F2-13	AI1 filter time	0.00–10.00s	0.01s	0.10s	☆
F2-14	AI2 minimum input	0.00 V to F2-16	0.01 V	0.02 V	☆
F2-15	Corresponding setting of AI2 minimum input	-100.00%–100.0%	0.1%	0.0%	☆
F2-16	AI2 maximum input	F2-14 to 10.00 V	0.01 V	10.00 V	☆

Function Code	Parameter Name	Setting Range	Min. Unit	Default	Property
F2-17	Corresponding setting mode of AI2 maximum input	0: F2-18 1: Determined by AI1	1	0	★
F2-18	Corresponding setting of AI2 maximum input	-100.00%–100.0%	0.1%	100.0%	☆
F2-19	AI2 filter time	0.00–10.00s	0.01s	0.10s	☆
F2-20	Pulse minimum input	0.00 kHz to F2-22	0.01 kHz	0.00 kHz	☆
F2-21	Corresponding setting of pulse minimum input	-100.00%–100.0%	0.1%	0.0%	☆
F2-22	Pulse maximum input	F2-20 to 50.00 kHz	0.01 kHz	50.00 kHz	☆
F2-23	Corresponding setting mode of pulse maximum input	0: F2-24 1: Determined by AI1 2: Determined by AI2	1	0	★
F2-24	Corresponding setting of pulse maximum input	-100.00%–100.0%	0.1%	100.0%	☆
F2-25	Pulse filter time	0.00–10.00s	0.01s	0.10s	☆
F2-26	DI valid state selection	0–127	1	0	☆
F2-27	Function selection of AI1 used as DI6	Same as F2-00	1	0	★
F2-28	Function selection of AI1 used as DI7	Same as F2-00	1	0	★
Group F3: Output Terminals					
F3-00	FM terminal output mode	0: Pulse output (FMP) 1: DO3 output output (FMR) 2: AO output	1	2	☆
F3-01	Relay function selection	0: No output 1: AC drive running 2: Fault output 1 3: Frequency-level detection FDT output 4: Frequency reached 5: Upper limit frequency reached 6: Lower limit frequency reached (To be continued)	1	2	☆

Function Code	Parameter Name	Setting Range	Min. Unit	Default	Property
F3-02	DO1 function selection	7: Zero-speed running (no output at stop) 8: Motor overload pre-warning 9: AC drive overload pre-warning 10: Set count value reached 11: Designated count value reached	1	1	☆
F3-03	DO2 function selection	12: Length reached 13: PLC cycle complete 14: Accumulative running time reached 15: Communication setting 16: Ready for run 17: AI1 > AI2 18: Detecting zero current	1	4	☆
F3-04	FM (DO3) function selection	19: External braking signal 20: Software overcurrent 21: Fault output 2 22: Zero-speed running 2 23: Fault output 3 24: Motor switchover output (End)	1	0	☆
F3-05	FMP/AO function selection	0: Running frequency 1: Set frequency 2: Output current 3: Output power 4: Pulse input 5: AI1 6: AI2 7: Length 8: Count value 9: Communication setting	1	0	☆
F3-06	AO1 offset coefficient	-100.0%–100.0%	0.1%	0.0%	☆
F3-07	AO gain	-10.00–10.00	0.01	1.00	☆
F3-08	Maximum FMP output frequency	0.1–50.00 kHz	0.1 kHz	50.0 kHz	☆
F3-09	Relay output delay time	0.0–3600.0s	0.1s	0.0s	☆

Function Code	Parameter Name	Setting Range	Min. Unit	Default	Property
F3-10	DO1 output delay time	0.0–3600.0s	0.1s	0.0s	☆
F3-11	DO2 output delay time	0.0–3600.0s	0.1s	0.0s	☆
F3-12	DO3 output delay time	0.0–3600.0s	0.1s	0.0s	☆
F3-13	DO valid state selection	0–15	1	0	☆
F3-14	Motor switchover delay	0.1–32.0s	0.1s	0.1s	☆
F3-15	Startup delay after motor switchover	0.1–32.0s	0.1s	0.2s	☆
Group F4: Start/Stop Control					
F4-00	Start mode	0: Direct start 1: Rotational speed tracking restart	1	0	★
F4-01	Rotational speed tracking mode	0: From frequency at stop 1: From zero speed 2: From maximum frequency	1	0	☆
F4-02	Rotational speed tracking speed	1–100	1	20	☆
F4-03	Startup frequency	0.00 Hz to maximum frequency (F0-04)	0.01 Hz	0.00 Hz	★
F4-04	Startup frequency holding time	0.0–36.0s	0.1s	0.0s	★
F4-05	Startup DC braking current	0%–100%	1%	0%	★
F4-06	Startup DC braking time	0.0–36.0s	0.1s	0.0s	★
F4-07	Acceleration/Deceleration mode	0: Linear acceleration/ deceleration 1: S-curve acceleration/ deceleration A 2: S-curve acceleration/ deceleration B	1	0	★
F4-08	Time proportion of S-curve start segment	0.0% to 100.0%	0.1%	20.0%	★
F4-09	Time proportion of S-curve end segment	0.0% to 100.0%	0.1%	20.0%	★

Function Code	Parameter Name	Setting Range	Min. Unit	Default	Property
F4-10	Stop mode	0: Decelerate to stop 1: Coast to stop	1	0	☆
F4-11	Initial frequency of stop DC braking	0.00 Hz to maximum frequency (F0-04)	0.01 Hz	0.00 Hz	☆
F4-12	Waiting time of stop DC braking	0.0–36.0s	0.1s	0.0s	☆
F4-13	Stop DC braking current	0%–100%	1%	0%	☆
F4-14	Stop DC braking time	0.0–36.0s	0.1s	0.0s	☆
F4-15	Brake use ratio	0%–100%	1%	100%	☆
Group F5: Auxiliary Functions					
F5-00	JOG running frequency	0.00 Hz to maximum frequency (F0-04)	0.01 Hz	2.00 Hz	☆
F5-01	JOG acceleration time	0.0–300.0s	0.01s	20.00s	☆
F5-02	JOG deceleration time	0.0–300.0s	0.01s	20.00s	☆
F5-03	JOG during running	0: Disabled 1: Enabled	1	0	☆
F5-04	Acceleration time 2	0.0–300.0s (m)	0.01s (m)	Model dependent	☆
F5-05	Deceleration time 2	0.0–300.0s (m)	0.01s (m)	Model dependent	☆
F5-06	Jump frequency	0.00 Hz to maximum frequency (F0-04)	0.01 Hz	0.00 Hz	☆
F5-07	Frequency jump amplitude	0.00 Hz to maximum frequency (F0-04)	0.01 Hz	0.00 Hz	☆
F5-08	Forward/Reverse rotation dead-zone time	0.0–100.0s	0.1s	0.0s	☆
F5-09	Reverse control	0: Enabled 1: Disabled	1	0	☆
F5-10	Running mode when set frequency lower than frequency lower limit	0: Run at frequency lower limit 1: Stop 2: Run at zero speed	1	0	☆
F5-11	Delay for stop when set frequency lower than frequency lower limit	0.00–3600.00s	0.1s	0.0s	☆

Function Code	Parameter Name	Setting Range	Min. Unit	Default	Property
F5-12	Accumulative running time threshold	0–65535 h	1 h	0 h	☆
F5-13	Action when set accumulative power-on time reached	0: Continue to run 1: Stop	1	0	☆
F5-14	Startup protection	0: Disabled 1: Enabled	1	0	☆
F5-15	Frequency detection value	0.00 Hz to maximum frequency (F0-04)	0.01 Hz	50.00 Hz	☆
F5-16	Frequency detection hysteresis	0.0%–100.0% (FDT level)	0.1%	5.0%	☆
F5-17	Detection range of frequency reached	0.00–100%	0.1%	0.0%	☆
F5-18	Random PWM gain	0: Random PWM invalid 1–10	1	0	☆
F5-19	PWM modulation mode	0: Asynchronous modulation 1: Synchronous modulation	1	0	★
F5-20	Rapid current limit	0: Disabled 1: Enabled	1	1	★
F5-21	Wakeup frequency	F5-23 to F0-04	0.01 Hz	0.00 Hz	☆
F5-22	Wakeup delay time	0.0–6500.0s	0.1s	0.0s	☆
F5-23	Dormant frequency	0.00 Hz to F5-21	0.01 Hz	0.00 Hz	☆
F5-24	Dormant delay time	0.0–6500.0s	0.1s	0.0s	☆
F5-25	Software overcurrent threshold	0.0%–300.0% (rated motor current)	0.1%	200.0%	☆
F5-26	Software overcurrent detection delay	0.00s (no detection) 0.01–6500.0s	0.01s	0.00s	☆
F5-27	Overcurrent detection delay (for DO output)	0.00s (no detection) 0.01–6500.0s	0.01s	0.00s	☆
F5-37	Dead zone compensation	0: Disabled 1: Enabled	1	1	★
F5-38	Cooling fan control	0: Fan working during running 1: Fan working continuously after power-on	1	0	☆
F5-39	External braking startup frequency	0.00 Hz to maximum frequency (F0-04)	0.01 Hz	0.00 Hz	☆

Function Code	Parameter Name	Setting Range	Min. Unit	Default	Property
F5-40	External braking time	0.0–3600.0s	0.1s	0.0s	☆
F5-41	Jump frequency execution mode	0: Not execute during acceleration/deceleration 1: Execute during acceleration/deceleration	1	0	☆
F5-43	Power-on time (in second)	0.00–3599s	1s	0s	●
F5-44	Power-on time (in hour)	0–65535 h	1 h	0 h	●
Group F6: PID Function					
F6-00	PID setting source	0: F6-01 1: AI1 2: AI2 3: Pulse setting (DI5) 4: Multi-reference	1	0	☆
F6-01	PID digital setting	0.0%–100.0%	0.1%	50.0%	☆
F6-02	PID setting change time	0.0–3000.0s	0.1s	0.0s	☆
F6-03	PID feedback source	0: AI1 1: AI2 2: Pulse setting (DI5) 3: AI1 – AI2	1	0	☆
F6-04	PID action direction	0: Forward action 1: Reverse action	1	0	☆
F6-05	PID setting feedback range	0–65535	1	1000	☆
F6-06	Proportional gain Kp1	0.0–100.0	0.1	20.0	☆
F6-07	Integral time Ti1	0.01–10.00s	0.01s	2.00s	☆
F6-08	Differential time Td1	0.00–10.000	0.001s	0.000s	☆
F6-09	PID deviation limit	0.0%–100.0%	0.1%	0.0%	☆
F6-10	PID operation at stop	0: No PID operation at stop 1: PID operation at stop	1	0	☆
F6-11	Cut-off frequency of PID reverse rotation	0.00 to maximum frequency (F0-04)	0.01 Hz	0.00 Hz	☆
F6-12	PID mode hibernation	0: Disabled 1: Enabled	1	0	☆

Function Code	Parameter Name	Setting Range	Min. Unit	Default	Property
F6-13	Wakeup tolerance	.0.1%–100.0%	0.1%	10.0%	☆
F6-14	Wakeup delay	0.1–6500.0s	0.1s	0s	☆
F6-15	Hibernation tolerance	0.0%–100.0%	0.1%	10.0%	☆
F6-16	Hibernation frequency	0.00 Hz to maximum frequency (F0-04)	0.01 Hz	20.00 Hz	☆
F6-17	Hibernation delay	0.1–6500.0s	0.1s	0s	☆
Group F7: Swing Frequency, Fixed Length and Count					
F7-00	Swing frequency setting mode	0: Relative to the central frequency 1: Relative to the maximum frequency	1	0	☆
F7-01	Swing frequency amplitude	0.0%–100.0%	0.1%	0.0%	☆
F7-02	Jump frequency amplitude	0.0%–50.0%	0.1%	0.0%	☆
F7-03	Swing frequency cycle	0.0–3000.0s	0.01s	10.00s	☆
F7-04	Triangular wave rising time coefficient	0.0%–100.0%	0.1%	50.0%	☆
F7-05	Set length	0–65535 m	1 m	1000 m	☆
F7-06	Actual length	0–65535 m	1 m	0 m	☆
F7-07	Number of pulses per meter	0.1–6553.5	0.1	100.0	☆
F7-08	Set count value	Set count value	1	1000	☆
F7-09	Designated count value	Designated count value	1	1000	☆
F7-10	Load speed display coefficient	0.0001–6.5000	0.0001	1.0000	☆
F7-11	Number of decimal places for load speed display	0: 0 decimal place 1: 1 decimal place 2: 2 decimal places 3: 3 decimal places	1	1	☆
F7-12	Accumulative running time	0–65535 h	1 h	-	●
F7-13	LED display running parameters	1–65535	1	799	☆
F7-14	LED display stop parameters	1–511	1	51	☆

Function Code	Parameter Name	Setting Range	Min. Unit	Default	Property
F7-15	MF.K Key function selection	0: MF.K key disabled 1: Switchover between operation panel control and remote command control (terminal or communication) 2: Switchover between forward rotation and reverse rotation 3: Forward JOG	1	0	★
F7-16	STOP/RESET key function	0: Stop function enabled only in operation panel control 1: Stop function enabled in any control mode	1	0	☆
F7-17	Software version	-	-	-	●
Group F8: Multi-Reference and Simple PLC Function					
F8-00	Reference 0 setting source	0: Set by F8-01 1: AI1 2: AI2 3: Pulse setting 4: PID 5: Preset frequency (F0-03) with UP/DOWN modification	1	0	★
F8-01	Reference 0	-100.0%–100.0%	0.1%	0.0%	☆
F8-02	Reference 1	-100.0%–100.0%	0.1%	0.0%	☆
F8-03	Reference 2	-100.0%–100.0%	0.1%	0.0%	☆
F8-04	Reference 3	-100.0%–100.0%	0.1%	0.0%	☆
F8-05	Reference 4	-100.0%–100.0%	0.1%	0.0%	☆
F8-06	Reference 5	-100.0%–100.0%	0.1%	0.0%	☆
F8-07	Reference 6	-100.0%–100.0%	0.1%	0.0%	☆
F8-08	Reference 7	-100.0%–100.0%	0.1%	0.0%	☆
F8-09	Simple PLC running mode	0: Stop after the AC drive runs one cycle 1: Keep final values after the AC drive runs one cycle 2: Repeat after the AC drive runs one cycle	1	0	☆
F8-10	Simple PLC retentive at power failure	0: No 1: Yes	1	0	☆
F8-11	Unit of PLC running time	0: s (second) 1: h (hour)	1	0	☆

Function Code	Parameter Name	Setting Range	Min. Unit	Default	Property
F8-12	Running time of simple PLC reference 0	0.0–6553.5s (h)	0.1s (h)	0.0s (h)	☆
F8-13	Acceleration/Deceleration time of simple PLC reference 0	0–1	1	0	☆
F8-14	Running time of simple PLC reference 1	0.0–6553.5s (h)	0.1s (h)	0.0s (h)	☆
F8-15	Acceleration/Deceleration time of simple PLC reference 1	0–1	1	0	☆
F8-16	Running time of simple PLC reference 2	0.0–6553.5s (h)	0.1s (h)	0.0s (h)	☆
F8-17	Acceleration/Deceleration time of simple PLC reference 2	0–1	1	0	☆
F8-18	Running time of simple PLC reference 3	0.0–6553.5s (h)	0.1s (h)	0.0s (h)	☆
F8-19	Acceleration/Deceleration time of simple PLC reference 3	0–1	1	0	☆
F8-20	Running time of simple PLC reference 4	0.0–6553.5s (h)	0.1s (h)	0.0s (h)	☆
F8-21	Acceleration/Deceleration time of simple PLC reference 4	0–1	1	0	☆
F8-22	Running time of simple PLC reference 5	0.0–6553.5s (h)	0.1s (h)	0.0s (h)	☆
F8-23	Acceleration/Deceleration time of simple PLC reference 5	0–1	1	0	☆
F8-24	Running time of simple PLC reference 6	0.0–6553.5s (h)	0.1s (h)	0.0s (h)	☆

Function Code	Parameter Name	Setting Range	Min. Unit	Default	Property
F8-25	Acceleration/ Deceleration time of simple PLC reference 6	0–1	1	0	☆
F8-26	Running time of simple PLC reference 7	0.0–6553.5s (h)	0.1s (h)	0.0s (h)	☆
F8-27	Acceleration/ Deceleration time of simple PLC reference 7	0–1	1	0	☆
Group F9: Reserved					
F9-00	Reserved				
Group FA: Communication Parameters					
FA-00	Baud rate	1: 600 bps 2: 1200 bps 3: 2400 bps 4: 4800 bps 5: 9600 bps 6: 19200 bps 7: 38400 bps	1	5	☆
FA-01	Data format	0: No check 1: Even parity check 2: Odd Parity check	1	0	☆
FA-02	Local address	0–247 0: Broadcast address	1	1	☆
FA-03	Response delay	0–20 ms	1 ms	2 ms	☆
FA-04	Communication timeout	0.0–60.0s 0.0s: invalid	0.1s	0.0s	☆
Group FB: Overload and Protection					
FB-00	Motor overload protection selection	0: Disabled 1: Enabled	1	1	☆
FB-01	Motor overload protection gain	0.20–10.00	0.01	1.00	☆
FB-02	Motor overload pre- warning coefficient	50%–100%	1%	80%	☆
FB-03	Overvoltage stall gain	0–100	1	0	☆
FB-04	Overvoltage stall protective threshold	120%–150%	1%	130%	☆

Function Code	Parameter Name	Setting Range	Min. Unit	Default	Property
FB-05	Overcurrent stall gain	0–100	1	20	☆
FB-06	Overcurrent stall protective current	100%–200%	1%	150%	☆
FB-07	Short-circuit to ground upon power-on	0: Disabled 1: Enabled	1	1	☆
FB-08	Protection upon off-load	0: Disabled 1: Enabled	1	0	☆
FB-09	Power dip ride-through function	0: Disabled 1: Enabled	1	0	☆
FB-10	Power dip ride-through frequency decline rate	0.00 Hz/s to maximum frequency (F0-04)/s	0.01 Hz/s	10.00 Hz/s	☆
FB-11	Voltage rise judging time of power dip ride-through	0.00–100.00s	0.01s	0.50s	☆
FB-12	Judging voltage of power dip ride-through action	60.0%–100.0%	1%	80.0%	☆
FB-13	Fault auto reset times	0–10	1	0	☆
FB-14	DO action during fault auto reset	0: No 1: Yes	1	0	☆
FB-15	Time interval of fault auto reset	0.1–60.0s	0.1s	1.0s	☆
FB-16	Clear time of fault auto reset times	0.1–1000.0 h	0.1 h	1.0 h	☆
FB-17	Input phase loss protectio	0: Disabled 1: Enabled	1	1	☆
FB-18	Output phase loss protection	0: Disabled 1: Enabled	1	1	☆
FB-19	Heatsink temperature of inverter module	-10 to 100.0°C	1°C	-	●
FB-20	1st fault type	0: No fault 1: Reserved 2: Overcurrent during acceleration (ERR02) 3: Overcurrent during deceleration (ERR03) (To be continued)	-	-	●

Function Code	Parameter Name	Setting Range	Min. Unit	Default	Property
FB-21	2nd fault type	7: Overvoltage at constant speed (ERR07)	-	-	●
		8: Control power supply fault (ERR08)			
FB-22	3rd (latest) fault type	9: Undervoltage (ERR09)	-	-	●
		10: AC drive overload (ERR10)			
		11: Motor overload (ERR11)			
		12: Power input phase loss (ERR12)			
		13: Power output phase loss (ERR13)			
		14: Module overheat (ERR14)			
		15: External equipment fault (ERR15)			
		16: Communication fault (ERR16)			
		17: Contactor fault (ERR17)			
		18: Current detection fault (ERR18)			
		19: Motor auto-tuning fault (ERR19)			
		20: Reserved (ERR20)			
		21: EEPROM read-write fault (ERR21)			
		22: Reserved (ERR22)			
23: Short circuit to ground (ERR23)					
24: Reserved (ERR24)					
25: Reserved (ERR25)					
26: Accumulative running time reached (ERR26)					
31: Software overcurrent (ERR31)					
40: Fast current limit timeout (ERR40)					
41: Motor switchover fault during running (ERR41)					
(End)					
FB-23	Frequency upon 3rd fault	-	-	-	●
FB-24	Current upon 3rd fault	-	-	-	●

Function Code	Parameter Name	Setting Range	Min. Unit	Default	Property
FB-25	Bus voltage upon 3rd fault	-	-	-	●
FB-26	DI status upon 3rd fault	-	-	-	●
FB-27	DO status upon 3rd fault	-	-	-	●
FB-28	Undervoltage threshold	60.0%–140.0%	0.1%	100.0%	☆
FB-29	Zero current detection level	0.0%–300.0% (100.0% corresponds to the rated motor current)	0.1%	5.0%	☆
FB-30	Zero current detection delay	0.00–600.00s	0.01s	0.10s	☆
Group FC: Motor 2 Parameters					
FC-00	Rated motor power	0.2–1000.0 kW	0.1 kW	Model dependent	★
FC-01	Rated motor voltage	0–480 V	1 V	Model dependent	★
FC-02	Rated motor current	0.1–6553.5 A	0.1 A	Model dependent	★
FC-03	Rated motor frequency	0.01 Hz to maximum frequency (F0-04)	0.01 Hz	Model dependent	★
FC-04	No-load current	0.1–6500.0 A	0.1 A	Model dependent	☆
FC-05	Stator resistance	0.001–65.535 Ω	0.001 Ω	Model dependent	☆
FC-06	Torque boost	0.0%–30.0% 0.0%: Fixed	0.1%	Model dependent	☆
FC-07	Slip compensation coefficient	0%–200.0%	0.1%	0.0%	☆
FC-08	Oscillation suppression gain	0–100	1	Model dependent	☆
FC-09	Motor 2 acceleration/ deceleration time	0: Same as motor 1 1: Acceleration/Deceleration time 1 (F0-09 and F0-10) 2: Acceleration/Deceleration time 2 (F5-04 and F5-05)	1	0	☆
Group FD: AI Correction					
FD-00	AI1 measured voltage 1	0.50–4.00 V	0.01 V	2.00 V	☆
FD-01	AI1 sampled voltage 1	0.50–4.00 V	0.01 V	2.00 V	☆

Function Code	Parameter Name	Setting Range	Min. Unit	Default	Property
FD-02	AI1 measured voltage 2	6.00–9.99 V	0.01 V	8.00 V	☆
FD-03	AI1 sampled voltage 2	6.00–9.99 V	0.01 V	8.00 V	☆
FD-04	AI2 measured voltage 1	0.50–4.00 V	0.01 V	2.00 V	☆
FD-05	AI2 sampled voltage 1	0.50–4.00 V	0.01 V	2.00 V	☆
FD-06	AI2 measured voltage 2	6.00–9.99 V	0.01 V	8.00 V	☆
FD-07	AI2 sampled voltage 2	6.00–9.99 V	0.01V	8.00V	☆
Group FF: Factory Parameters (Reserved)					
FF-00	Factory password	Reserved			*
Group FP: User Password					
FP-00	User password	0–65535	1	0	☆
FP-01	Restore default settings	0: No operation 1: Restore factory settings 2: Clear records 4: Clear power-on time	1	0	★
FP-02	Power-on time correction coefficient	0.6–1.50	0.01	1.00	★



Description of Function Codes



Chapter 6 Description of Function Codes

Group F0: Basic Parameters

Function Code	Parameter Name	Setting Range	Default
F0-00	Command source selection	0: Operation panel control 1: Terminal control 2: Communication control	0

It is used to determine the input channel of the AC drive control commands, such as run, stop, forward rotation, reverse rotation and jog operation. You can input the commands in the following three channels:

- 0: Operation panel control (LOCAL/REMOT indicator OFF)

Commands are given by pressing key  ,  , or  on the operation panel.

- 1: Terminal control (LOCAL/REMOT indicator ON)

Commands are given by means of multifunctional input terminals with functions such as FWD, REV, FJOG, and RJOG.

- 2: Communication control (LOCAL/REMOT indicator blinking)



Commands are given from the host computer.

Function Code	Parameter Name	Setting Range	Default
F0-01	Main frequency source X selection	0: Digital setting (UP/DOWN modification) 1: AI1 2: AI2 3: Pulse setting (DI5) 4: Multi-reference 5: Simple PLC 6: PID 7: AI1+AI2 8: Communication setting 9: PID+AI1 10: PID+AI2	0

It is used to select the setting channel of the main frequency. You can set the main frequency in the following 10 channels:

- 0: Digital setting (UP/DOWN modification)

The initial value of the set frequency is the value of F0-03 (Preset frequency). You can

change the set frequency by pressing  and  on the operation panel (or using the UP/DOWN function of input terminals).

The base frequency to be modified on the operation panel or by terminal UP/DOWN is the running frequency of the AC drive in the running state or current set frequency of the AC drive in the stop state.

- 1: AI1 (0–10 V voltage input)
- 2: AI2 (0–10 V voltage input or 4–20 mA current input, determined by jumper J1)

The frequency is set by analog input. The potentiometer and AI2 on the control board must not be enabled at the same time, and whether the potentiometer or AI2 is enabled is determined by jumper J2. The corresponding setting of AI1 and AI2 are defined in F2-08 to F2-19.

- 3: Pulse setting (DI5)

The frequency is set by DI5 (high-speed pulse). The signal specification of pulse setting is 9–30 V (voltage range) and 0–50 kHz (frequency range).

When the frequency source is “Pulse setting (DI5)”, DI5 provides the pulses for frequency setting by default. You need to specify the function of DI5 to 0 (No function) to prevent malfunction.

- 4: Multi-reference

In multi-reference mode, combinations of different DI terminal states correspond to different set frequencies. To define the relationship between the terminal states and set frequencies, set the functions of input terminals in F2-00 to F2-04 and multi-reference parameters in F8-00 to F8-08.

- 5: Simple PLC

When the simple programmable logic controller (PLC) mode is used as the frequency source, the running frequency of the AC drive can be switched over among multiple frequencies. The frequencies of each stage are defined in the related parameters in group F8.

- 6: PID

The output of PID control is used as the running frequency.

When applying PID as the frequency source, you need to set parameters of PID function in group F6.

- 7: AI1+AI2

The frequency is set by superposition of AI1 input and AI2 input. For details, see the descriptions of F2-08 to F2-19.

- 8: Communication setting

The frequency is set by means of communication. For details, see the description of the communication protocol.

- 9: PID+AI1

The frequency is set by means of superposition of PID and AI1.

Note that the PID setting source (F6-00) and PID feedback source (F6-03) must not be set to AI1.

- 10: PID+AI2

The frequency is set by means of superposition of PID and AI2.

Note that the PID setting source (F6-00) and PID feedback source (F6-03) must not be set to AI2.

Function Code	Parameter Name	Setting Range	Default
F0-02	Retentive of digital setting frequency	0: Not retentive 1: Retentive at power failure 2: Retentive at stop 3: Retentive at both power failure and stop	0

This parameter is valid only when the frequency source is digital setting.

- 0: Not retentive

After the AC drive is powered on again after stop or power-failure, the frequency is restored to the value of F0-03 (Preset frequency).

- 1: Retentive at power failure

After the AC drive is powered on again after power failure (at stop or during running), the frequency is the value before power-failure.

- 2: Retentive at stop

After the AC drive stops and is powered-on again, the frequency is the value at stop.

- 3: Retentive at both power failure and stop

After the AC drive is powered on again at power failure, the set frequency is the value before power failure. After the AC drive stops and is powered on again, the frequency is the value at stop.

Function Code	Parameter Name	Setting Range	Default
F0-03	Preset frequency	0.00 to maximum frequency (F0-04)	50 Hz

When F0-01 is set to 0 (Digital setting), this parameter is valid and the value is the initial frequency of the AC drive (digital setting).

Function Code	Parameter Name	Setting Range	Default
F0-04	Maximum frequency	50.00–630.00 Hz	50.00 Hz

It is used to set the maximum output frequency of the AC drive.

Function Code	Parameter Name	Setting Range	Default
F0-05	Source of frequency upper limit	0: Set by F0-06 1: AI1 2: AI2 3: Pulse setting (DI5)	0

It is used to set the source of the frequency upper limit, including digital setting (F0-06), AI, and pulse setting.

Function Code	Parameter Name	Setting Range	Default
F0-06	Frequency upper limit	F0-07 to F0-04	50.00 Hz

This parameter is used to set the frequency upper limit.

Function Code	Parameter Name	Setting Range	Default
F0-07	Frequency lower limit	0.00 Hz to frequency upper limit (F0-06)	0.00 Hz

If the frequency reference is lower than the value of this parameter, the AC drive can stop after a delay or run at the frequency lower limit. For details, see the description of F5-10 and F5-11.

Function Code	Parameter Name	Setting Range	Default
F0-08	Acceleration/Deceleration time unit	0: s (second) 1: m (minute)	0

It is used to set the unit of acceleration or deceleration time. This parameter is valid to F0-09 (Acceleration time 1), F0-10 (Deceleration time 1), F5-04 (Acceleration time 2), and F5-05 (Deceleration time 2).

Function Code	Parameter Name	Setting Range	Default
F0-09	Acceleration time 1	0.00–300.00s (m)	Model dependent
F0-10	Deceleration time 1	0.00–300.00s (m)	Model dependent

Acceleration time indicates the time required by the AC drive to accelerate from 0 Hz to "Acceleration/Deceleration base frequency" (F0-13), that is, t_1 in the following figure.

Deceleration time indicates the time required by the AC drive to decelerate from "Acceleration/Deceleration base frequency" (F0-13) to 0 Hz, that is, t_2 in the following figure.

Figure 6-1 Acceleration/Deceleration time

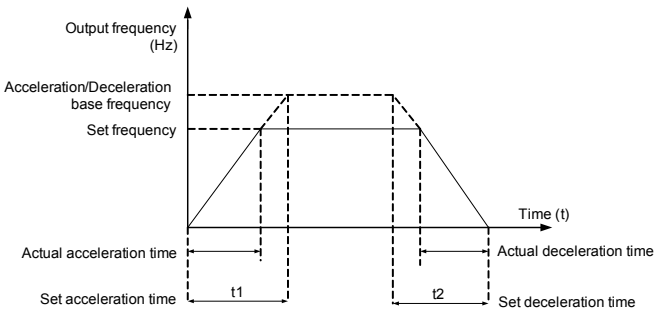

The MD280 provides totally two groups of acceleration/deceleration time for selection. You can perform switchover by using a DI terminal.

- Group 1: F0-09, F0-10
- Group 2: F5-04, F5-05

Function Code	Parameter Name	Setting Range	Default
F0-11	Carrier frequency	0.5–16.0 kHz	Model dependent

It is used to adjust the carrier frequency of the AC drive, helping to reduce the motor noise, avoiding the resonance of the mechanical system, and reducing the leakage current to the earth and interference generated by the AC drive.

If the carrier frequency is low, output current has high harmonics, and the power loss and temperature rise of the motor increase.

If the carrier frequency is high, power loss and temperature rise of the motor declines. However, the AC drive has an increase in power loss, temperature rise and interference.

Adjusting the carrier frequency will exert influences on the aspects listed in the following table.

Table 6-1 Influences of carrier frequency rise

Carrier frequency	Low → High
Motor noise	Large → Small
Output current waveform	Bad → Good
Motor temperature rise	High → Low
AC drive temperature rise	Low → High
Leakage current	Small → Large
External radiation interference	Small → Large

The factory setting of carrier frequency varies with the AC drive power. If you need to modify the carrier frequency, note that if the set carrier frequency is higher than factory setting, it will lead to an increase in temperature rise of the AC drive's heatsink. In this case, you need to de-rate the AC drive. Otherwise, the AC drive may overheat and alarm.

Function Code	Parameter Name	Setting Range	Default
F0-12	Rotation direction	0: Same direction 1: Reverse direction	0

You can change the rotation direction of the motor just by modifying this parameter without changing the motor wiring. Modifying this parameter is equivalent to exchanging any two of the motor's U, V, W wires.

Note

The motor will resume running in the original direction after parameter initialization. Do not use this function in applications where changing the rotating direction of the motor is prohibited after system commissioning is complete.



Function Code	Parameter Name	Setting Range	Default
F0-13	Acceleration/Deceleration time base frequency	0: Maximum frequency (F0-04) 1: Set frequency	0

When this parameter is set to 0, the acceleration/deceleration time indicates the time for the AC drive to increase from 0 Hz to the maximum frequency set in F0-04 or decrease from the maximum frequency set in F0-04 to 0 Hz.

If this parameter is set to 1, the acceleration/deceleration time indicates the time for the AC drive to increase from 0 Hz to the set frequency or decrease from the set frequency to 0 Hz.

Function Code	Parameter Name	Setting Range	Default
F0-14	Base frequency for UP/DOWN modification during running	0: Running frequency 1: Set frequency	0



This parameter is valid only when the frequency source is digital setting.

It is used to set the base frequency to be modified by using keys  and  or the terminal UP/DOWN function.

Function Code	Parameter Name	Setting Range	Default
F0-15	Auxiliary frequency source Y selection	0: Digital setting (UP/DOWN modification) 1: AI1 2: AI2 3: Pulse setting (DI5) 4: Multi-reference 5: Simple PLC 6: PID 7: AI1+AI2 8: Communication setting	0

When used as an independent frequency input channel (frequency source switched over from X to Y), the auxiliary frequency source Y is used in the same way as the main frequency source X (refer to F0-03).

When the auxiliary frequency source is used for superposition (frequency source is "X and Y superposition" or X switched over to "X and Y superposition"), pay attention to the following aspects:

1. If the auxiliary frequency source Y is digital setting, the preset frequency (F0-03) does not take effect. You can directly adjust the set main frequency by pressing keys  and  on the operation panel (or using the terminal UP/DOWN function).
2. If the auxiliary frequency source is analog input (AI1, AI2) or pulse setting, 100% of the input corresponds to the range of the auxiliary frequency Y (set in F0-16 and F0-17). The modification range can be set to -n% to +n% (F2-08 to F2-19).

If the auxiliary frequency source is pulse setting, it is similar to analog input.

Note

The main frequency source X and auxiliary frequency source Y must not use the same channel. That is, F0-01 and F0-15 cannot be set to the same value.

Function Code	Parameter Name	Setting Range	Default
F0-16	Base of auxiliary frequency Y	0: Relative to maximum frequency 1: Relative to main frequency X	0
F0-17	Range of auxiliary frequency Y	0%–150%	100%

If X and Y superposition (F0-18 = 1 or 3) is used, these two parameters are used to set the modification range of the auxiliary frequency source.

You can set the auxiliary frequency to be relative to either maximum frequency or main frequency X. If relative to main frequency X, the setting range of the auxiliary frequency Y varies according to the main frequency X.

Function Code	Parameter Name	Setting Range	Default
F0-18	Frequency source superposition	0: Main frequency source X 1: X and Y superposition 2: Switchover between X and Y 3: Switchover between X and "X and Y superposition" 4: Switchover between Y and "X and Y superposition"	0

It is used to select the frequency setting channel.

When this parameter is set to the value other than 2, 3, or 4, the switchover can be implemented by the DI with the frequency source switchover function.

Function Code	Parameter Name	Setting Range	Default
F0-20	Frequency offset of auxiliary frequency source for X and Y superposition	0.00 Hz to maximum frequency (F0-04)	0.00 Hz

This parameter is valid only when the frequency source is set to "X and Y superposition". The final frequency is obtained by adding the frequency offset set in this parameter to the X and Y superposition result.

Function Code	Parameter Name	Setting Range	Default
F0-21	Carrier frequency adjustment with temperature	0: No 1: Yes	1

It is used to set whether the carrier frequency is adjusted based on the temperature. The AC drive automatically reduces the carrier frequency when detecting that the heatsink

temperature is high. The AC drive resumes the carrier frequency to the set value when the heatsink temperature becomes normal. This function reduces the overheat alarms.

Function Code	Parameter Name	Setting Range	Default
F0-22	Binding command source to frequency source	Unit's digit (Binding operation panel command to frequency source)	000
		0: No binding 1: Frequency source by digital setting 2: AI1 3: AI2 4: Pulse setting (DI5) 5: Multi-reference 6: Simple PLC 7: PID 8: AI1+AI2 9: Communication setting	
		Ten's digit (Binding terminal command to frequency source)	
		0-9, same as unit's digit	
		Hundred's digit (Binding communication command to frequency source)	
		0-9, same as unit's digit	

It is used to bind the three running command sources with the nine frequency sources, facilitating to implement synchronous switchover.

For details on the frequency sources, see the description of F0-01 (Main frequency source X selection). Different running command sources can be bound to the same frequency source.

Group F1: Motor Parameters and V/F Control Parameters

Function Code	Parameter Name	Setting Range	Default
F1-00	Rated motor power	0.2-1000.0 kW	Model dependent
F1-01	Rated motor voltage	0-480 V	Model dependent
F1-03	Rated motor current	0.1-6553.5 A	Model dependent
F1-04	Rated motor frequency	0.00 Hz to maximum frequency (F0-04)	Model dependent

Set the parameters according to the motor nameplate.

Use a standard motor adaptable to the AC drive. If the power of the selected motor has a large difference with that of the standard adaptable motor, the control performance of the AC

drive may degrade.

After the rated motor power is changed, the AC drive calculates the rated current, no-load current, and stator resistance accordingly. Set the rated motor power first, and then rated current, no-load current, and stator resistance.

Function Code	Parameter Name	Setting Range	Default
F1-04	V/F curve setting	0: Linear V/F 1: Multi-point V/F 2: Square V/F	0

- 0: Linear V/F

It is applicable to common constant torque load.

- 1: Multi-point V/F

It is applicable to special load such as dehydrator and centrifuge. Any such V/F curve can be obtained by setting parameters of F1-03 to F1-08.

- 2: Square V/F

It is applicable to centrifugal loads such as fan and pump.

Function Code	Parameter Name	Setting Range	Default
F1-05	Torque boost	0.0%–30.0% 0.0%: Fixed	1.0%
F1-06	Cut-off frequency of torque boost	0.00 Hz to maximum frequency (F0-04)	50.00 Hz

To compensate the low frequency torque characteristics of V/F control, you can boost the output voltage of the AC drive at low frequency by modifying F1-05.

If the torque boost is set to too large, the motor may overheat, and the AC drive may suffer overcurrent.

If the load is large and the motor startup torque is insufficient, increase the value of F1-05. If the load is small, decrease the value of F1-05. If it is set to 0.0, the AC drive performs automatic torque boost. In this case, the AC drive automatically calculates the torque boost value based on motor parameters including the stator resistance.

F1-06 specifies the frequency under which torque boost is valid. Torque boost becomes invalid when this frequency is exceeded, as shown in the following figure.

Figure 6-2 Manual torque boost

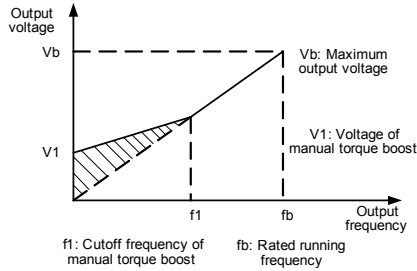

Function Code	Parameter Name	Setting Range	Default
F1-07	Multi-point V/F frequency 1 (f_1)	0.00 Hz to F1-09	0.00 Hz
F1-08	Multi-point V/F voltage 1 (v_1)	0.0%–100.0%	0.0%
F1-09	Multi-point V/F frequency 2 (f_2)	F1-07 to F1-11	0.00 Hz
F1-10	Multi-point V/F voltage 2 (v_2)	0.0%–100.0%	0.0%
F1-11	Multi-point V/F frequency 3 (f_3)	F1-09 to F1-03	0.00 Hz
F1-12	Multi-point V/F voltage 3 (v_3)	0.0%–100.0%	0.0%

These six parameters are used to define the multi-point V/F curve.

The frequency range corresponds to 0.00 Hz to the rated motor frequency, and the voltage range 0.0%–100.0% corresponds to 0 V to the rated motor voltage.

The multi-point V/F curve is set based on the motor’s load characteristic. Pay attention to the following aspects during the setting:

- $v_1 < v_2 < v_3$, $f_1 < f_2 < f_3$. To ensure correct setting, set F1-11 first, and then F1-09 and F1-07.
- At low frequency, higher voltage may cause overheat or even burnt out of the motor and overcurrent stall or overcurrent protection of the AC drive.

Figure 6-3 Setting of multi-point V/F curve

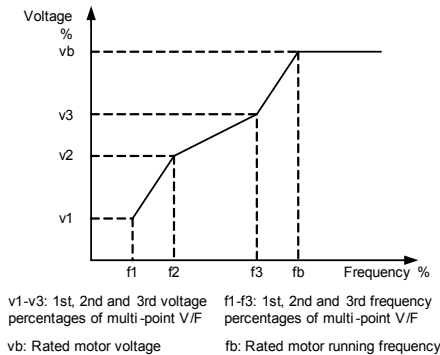

v_1 - v_3 : 1st, 2nd and 3rd voltage percentages of multi-point V/F
 f_1 - f_3 : 1st, 2nd and 3rd frequency percentages of multi-point V/F
 v_b : Rated motor voltage
 f_b : Rated motor running frequency

Function Code	Parameter Name	Setting Range	Default
F1-13	Slip compensation coefficient	0%–200.0%	0.0%

It can compensate the rotational speed slip of the asynchronous motor when the load of the motor increases, stabilizing the motor speed in case of load change.

If this parameter is set to 100%, it indicates that the compensation when the motor bears rated load is the rated motor slip.

When the motor bears the rated load and this parameter is set to 100%, the rotational speed of the motor is close to the set speed. Modify this parameter based on such a principle.

Before performing automatic torque boost or slip compensation, carry out motor auto-tuning to guarantee the control effect. Follow the precautions:

- When this parameter is set to a large value, the motor may oscillate. In this case, decrease the value of this parameter.
- Do not use the automatic torque boost and slip compensation functions simultaneously.

Function Code	Parameter Name	Setting Range	Default
F1-14	Over-excitation gain	0–200	64

During deceleration of the AC drive, over-excitation can restrain rise of the bus voltage, preventing the overvoltage fault. The larger the over-excitation is, the better the restraining result is.

Set the over-excitation gain to 0 in the applications where the inertia is small and the bus voltage will not rise during motor deceleration or where there is a braking resistor.

Increase the over-excitation gain properly when the inertia is large.

Function Code	Parameter Name	Setting Range	Default
F1-15	No-load current	0.1 A to F1-02	Model dependent
F1-16	Stator resistance	0.001–65.535 Ω	Model dependent

Set these parameters based on the motor parameters. If these parameters are set incorrectly, the control performance will be affected. If you are sure about the values, perform motor auto-tuning, or contact the manufacturer of the motor.

Function Code	Parameter Name	Setting Range	Default
F1-17	Oscillation suppression gain	0–100	Model dependent

Set this parameter to a value as small as possible in the prerequisite of efficient oscillation suppression to avoid influence on V/F control.

Set this parameter to 0 if the motor has no oscillation. Increase the value properly only when the motor has obvious oscillation. The larger the value is, the better the oscillation suppression result will be.

When the oscillation suppression function is enabled, the rated motor current and no-load current must be correct. Otherwise, the V/F oscillation suppression effect will not be satisfactory.

Function Code	Parameter Name	Setting Range	Default
F1-18	Auto-tuning selection	0: No auto-tuning 1: Static auto-tuning	0

Note that the motor parameters F1-00 to F1-03 must be set correctly before performing auto-tuning.

- 0: No auto-tuning

The AC drive does not perform auto-tuning.

- 1: Static auto-tuning

The AC drive performs static auto-tuning and detects the stator resistance of the motor.



The procedure of auto-tuning is as follows:

1. Set F0-00 (Command source selection) to 0 (Operation panel control).

Note that auto-tuning is valid only in operation panel control mode.

2. Set the motor parameters correctly (F1-00 to F1-03).

3. Set F1-18 to 1 and press . The operation panel displays "TUNE" in blinking mode.

Then, press ; the operation displays "TUNE" without blinking, and the AC drive starts motor auto-tuning. After the motor auto-tuning is completed, the operation panel returns to the normal parameter display state. You can press  during auto-tuning to stop motor auto-tuning.

4. The value of this parameter is restored to 0 automatically after the auto-tuning is completed.

Function Code	Parameter Name	Setting Range	Default
F1-19	Oscillation suppression mode	0-4	1

- 0: Not dependent on the no-load current, valid at below 15 Hz
- 1: Not dependent on the no-load current, always valid (by default)
- 2: Dependent on the no-load current, valid at below 15 Hz
- 3: Dependent on the no-load current, always valid
- 4: Always valid

Group F2: Input Terminals

The MD280 provides five DI terminals (DI5 can be used for high-speed pulse input) and two analog input (AI) terminals.

- When DI5 is used for high-speed pulse input, specify the function of DI5 to 0 (No function) to prevent malfunction. Being used for high-speed pulse input, DI5 can provides the input of the frequency source, upper limit frequency source, PID setting

source, PID feedback source, and reference 0 in the multi-reference function.

- When the pulse frequency for the counter input and length counting input is high, use DI5; otherwise, use DI1 to DI4.

Function Code	Parameter Name	Default
F2-00	DI1 function selection	1: Forward RUN (FWD)
F2-01	DI2 function selection	2: Reverse RUN (REV)
F2-02	DI3 function selection	4: Forward JOG (FJOG)
F2-03	DI4 function selection	8: Coast to stop
F2-04	DI5 function selection	0: No function

The following table lists the functions available for the DI terminals. Note that except function 0, the same function must not be allocated to multiple DI terminals. If a function cannot be selected, check whether this function has been allocated to other terminals, or is being used.

Table 6-2 Functions of DI terminals

Value	Function	Description
0	No function	Set 0 for reserved terminals to avoid malfunction.
1	Forward RUN (FWD)	When F0-00 is set to 1 (Terminal control), the terminals are used to control forward or reverse RUN of the AC drive. For details, see the description of F2-06.
2	Reverse RUN (REV)	
3	Three-line control	
4	Forward JOG (FJOG)	FJOG indicates forward JOG running, while RJOG indicates reverse JOG running. The JOG frequency, acceleration time and deceleration time are described respectively in F5-00, F5-01 and F5-02.
5	Reverse JOG (RJOG)	
6	Terminal UP	When F0-01 is set to 0 (Digital setting), the terminals with the two functions are used as increment and decrement commands for frequency modification. The terminal UP/DOWN rate is determined in F2-07.
7	Terminal DOWN	
8	Coast to stop	When the terminal with this function becomes ON, the AC drive blocks its output, and the motor coasts to rest and is not controlled by the AC drive.
9	Fault reset (RESET)	The terminal is used for fault reset function, the same as the function of RESET key on the operation panel. This function is implemented by pulse input.
10	RUN pause	When the terminal with this function becomes ON, the AC drive stops in the mode set in F4-10. If the PLC controls the AC drive at this time, the PLC memorizes the frequency and running time at the pause moment and does not count the pause time.

Value	Function	Description
11	Normally open (NO) input of external fault	External fault signals are input to the terminal, and then the AC drive reports Err15 and performs the fault protection action.
12	Normally closed (NC) input of external fault	For function 11, when the terminal becomes ON, the fault signal is send to the AC drive. For function 12, when the terminal becomes OFF, the fault signal is send to the AC drive.
13	Multi-reference terminal 1	When F0-01 is set to 4 (Multi-reference), eight speeds or other references can be implemented through state combinations of these three terminals. For details, see Table 6-3. Reference 0 is determined by F8-00.
14	Multi-reference terminal 2	
15	Multi-reference terminal 3	
16	Terminal for acceleration/ deceleration time selection	This terminal is used to switch over the two groups of acceleration/deceleration time. When this terminal is OFF, group 1 acceleration/deceleration time is used. When this terminal is ON, group 2 acceleration/deceleration time is used. This function is also valid on the PLC.
17	UP and DOWN setting clear (terminal, operation panel)	When F0-01 is set to 0 (Digital setting), the terminal is used to clear the modification by using the UP/DOWN function or the increment/decrement key on the operation panel, returning the set frequency to the value of F0-03.
18	DC braking	After this terminal becomes ON, the AC drive immediately performs DC braking based on the stop braking current set in F4-13. At this moment, the RUN indicator becomes ON and the output frequency is 0 Hz.
19	Acceleration/ Deceleration prohibited	It enables the AC drive to maintain the current frequency output without being affected by external signals (except the STOP command). This function is also valid for JOG.
20	PID pause	PID is invalid temporarily. The AC drive maintains the current frequency output without supporting PID adjustment of frequency source.
21	PLC status reset	The terminal is used to restore the original status of PLC control for the AC drive when PLC control is started again after a pause.
22	Swing pause	The AC drive outputs the central frequency, and the swing frequency function pauses.
23	Counter input	This terminal is used to count pulses.
24	Counter reset	This terminal is used to clear the counter status. For details, see the descriptions of F7-08 and F7-09.
25	Length count input	This terminal is used to count the length.
26	Length reset	This terminal is used to clear the length.

Value	Function	Description															
27	Exchange of AI1 and AI2 settings	When this terminal becomes ON, the setting values of AI1 and AI2 are exchanged, but the corresponding setting of AI1 maximum input (F2-11) and the corresponding setting of AI2 maximum input (F2-17) remain unchanged.															
28	Frequency source switched over to AI1	When this terminal becomes ON, the current frequency source is switched over to AI1 setting. This function is valid only when F0-18 is set to 0.															
29	DC braking at stop enabled	When this terminal is ON, the AC drive performs DC braking to stop based on the initial frequency, waiting time, braking current, and braking time set in F4-11 to F4-14. This function is valid by default.															
30	Command source switchover to operation panel control	When this terminal is ON, the current command source is switched over to "operation panel control".															
31	Command source switchover to terminal control	When this terminal is ON, the current command source is switched over to "terminal control".															
32	Motor switchover	When this terminal becomes ON, motor 1 is switched over to motor 2. This function is valid only at stop, and the AC drive reports Err41 when you perform switchover during running.															
33	Frequency source switchover	When F0-18 is set to 2, this terminal is used to perform switchover between main frequency source X and auxiliary frequency source Y. When F0-18 is set to 3, this terminal is used to perform switchover between main frequency source X and X+Y. When F0-18 is set to 2, this terminal is used to perform switchover between auxiliary frequency source Y and X+Y.															
34	Lock running frequency	When this terminal is ON, the current running frequency is locked, and remains valid at power-failure.															
35	Select main frequency source	<table border="1"> <thead> <tr> <th>Terminal with Function 36</th> <th>Terminal with Function 35</th> <th>Frequency Source</th> </tr> </thead> <tbody> <tr> <td>0</td> <td>0</td> <td>Setting of F0-18</td> </tr> <tr> <td>0</td> <td>1</td> <td>Main frequency source</td> </tr> <tr> <td>1</td> <td>0</td> <td>Auxiliary frequency source</td> </tr> <tr> <td>1</td> <td>1</td> <td>Setting of F0-18</td> </tr> </tbody> </table>	Terminal with Function 36	Terminal with Function 35	Frequency Source	0	0	Setting of F0-18	0	1	Main frequency source	1	0	Auxiliary frequency source	1	1	Setting of F0-18
Terminal with Function 36	Terminal with Function 35	Frequency Source															
0	0	Setting of F0-18															
0	1	Main frequency source															
1	0	Auxiliary frequency source															
1	1	Setting of F0-18															
36	Select auxiliary frequency source																
37	Motor switchover during running	When this terminal is ON, the AC drive controls motor 2; when this terminal is OFF, the AC drive controls motor 1. The switchover can be performed during running. After the stop delay set in F3-14, the AC drive outputs the motor switchover signal. After the delay set in F3-15, the AC drive starts again.															

- Function 30 (Command source switchover to operation panel control) takes

precedence over function 31 (Command source switchover to terminal control). When either of the two functions is valid, the function of switchover between operation panel control and remote command channel provided by the  key is disabled.

- Motor 2 parameters are set in group FC; the V/F curve of motor 2 is straight line by default; the acceleration/deceleration time is set in FC-09.

The three multi-reference terminals have 16 state combinations, corresponding to eight reference values, as listed in the following table.

Table 6-3 State combinations of the four multi-reference terminals

K3	K2	K1	Reference Setting	Corresponding Parameter
OFF	OFF	OFF	Reference 0	F8-00
OFF	OFF	ON	Reference 1	F8-01
OFF	ON	OFF	Reference 2	F8-02
OFF	ON	ON	Reference 3	F8-03
ON	OFF	OFF	Reference 4	F8-04
ON	OFF	ON	Reference 5	F8-05
ON	ON	OFF	Reference 6	F8-06
ON	ON	ON	Reference 7	F8-07

Function Code	Parameter Name	Setting Range	Default
F2-05	DI filter time	0–10	4

It is used to set the software filter time of DI terminal status. If DI terminals are liable to interference and may cause malfunction, increase the value of this parameter to enhance the anti-interference capability. However, increase of DI filter time will reduce the response of DI terminals.

Function Code	Parameter Name	Setting Range	Default
F2-06	Terminal command mode	0: Two-line mode 1 1: Two-line mode 2 2: Three-line mode 1 3: Three-line mode 2	0

This parameter is used to set the mode in which the AC drive is controlled by external terminals. The following uses DI1, DI2 and DI3 among DI1 to DI5 as an example, with allocating functions of DI1, DI2 and DI3 by setting F2-00 to F4-02.

- 0: Two-line mode 1

It is the most commonly used two-line mode, in which the forward/reverse rotation of the motor is decided by DI1 and DI2. The parameters are set as below:

Function Code	Parameter Name	Value	Function Description
F2-06	Terminal command mode	0	Two-line 1
F2-00	DI1 function selection	1	Forward RUN (FWD)
F2-01	DI2 function selection	2	Reverse RUN (REV)

Figure 6-4 Setting of two-line mode 1

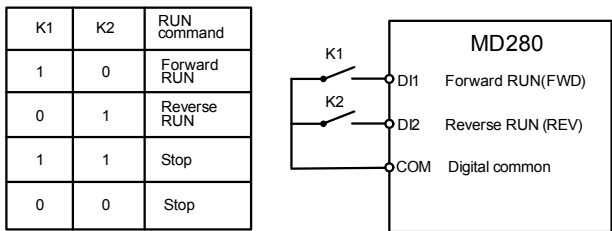

As shown in the preceding figure, when only K1 is ON, the AC drive instructs forward rotation. When only K2 is ON, the AC drive instructs reverse rotation. When K1 and K2 are ON or OFF simultaneously, the AC drive stops.

- 1: Two-line mode 2

In this mode, DI1 is RUN enabled terminal, and DI2 determines the running direction. The parameters are set as below:

Function Code	Parameter Name	Value	Function Description
F2-06	Terminal command mode	1	Two-line 2
F2-00	DI1 function selection	1	RUN enabled
F2-01	DI2 function selection	2	Forward or reverse direction

Figure 6-5 Setting of two-line mode 2

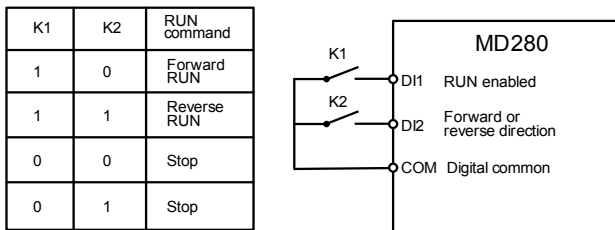

As shown in the preceding figure, if K1 is ON, the AC drive instructs forward rotation when K2 is OFF, and instructs reverse rotation when K2 is ON. If K1 is OFF, the AC drive stops.

- 2: Three-line mode 1

In this mode, DI3 is RUN enabled terminal, and the direction is decided by DI1 and DI2. The parameters are set as below:

Function Code	Parameter Name	Value	Function Description
F2-06	Terminal command mode	2	Three-line 1
F2-00	DI1 function selection	1	Forward RUN (FWD)
F2-01	DI2 function selection	2	Reverse RUN (REV)
F2-02	DI3 function selection	3	Three-line control

Figure 6-6 Setting of three-line mode 1

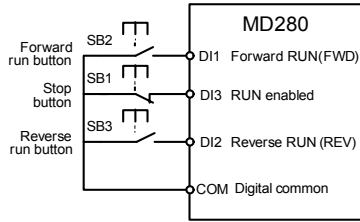

As shown in the preceding figure, if SB1 is ON, the AC drive instructs forward rotation when SB2 is pressed to be ON and instructs reverse rotation when SB3 is pressed to be ON. The AC drive stops immediately after SB1 becomes OFF. During normal startup and running, SB1 must remain ON. The AC drive's running state is determined by the final actions on SB1, SB2 and SB3.

- 3: Three-line mode 2

In this mode, DI3 is RUN enabled terminal. The RUN command is given by DI1 and the direction is decided by DI2. The parameters are set as below:

Function Code	Parameter Name	Value	Function Description
F2-06	Terminal command mode	3	Three-line 2
F2-00	DI1 function selection	1	RUN enabled
F2-01	DI2 function selection	2	Forward or reverse direction
F2-02	DI3 function selection	3	Three-line control

Figure 6-7 Setting of three-line mode 2

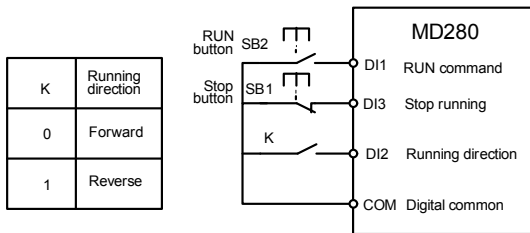

As shown in the preceding figure, if SB1 is ON, the AC drive starts running when SB2 is pressed to be ON; the AC drive instructs forward rotation when K is OFF and instructs reverse rotation when K is ON. The AC drive stops immediately after SB1 becomes OFF. During normal startup and running, SB1 must remain ON. The AC drive's running state is determined by the final actions of SB1, SB2 and K.

Function Code	Parameter Name	Setting Range	Default
F2-07	Terminal UP/DOWN rate	0.01–100.00 Hz/s	1.00 Hz/s

It is used to adjust the rate of change of frequency when the frequency is adjusted by means of terminal UP/DOWN.

Function Code	Parameter Name	Setting Range	Default
F2-08	AI1 minimum input	0.00 V to F2-10	0.02 V
F2-09	Corresponding setting of AI1 minimum input	-100.00%–100.0%	0.0%
F2-10	AI1 maximum input	F2-08 to 10.00 V	10.00 V
F2-11	Corresponding setting mode of AI1 maximum input	0: F2-12 1: Determined by AI2	0
F2-12	Corresponding setting of AI1 maximum input	-100.00%–100.0%	100.0%
F2-13	AI1 filter time	0.00–10.00s	0.10s

These parameters are used to define the relationship between the analog input voltage and the corresponding setting. When the analog input voltage exceeds the maximum value, the maximum value is used. When the analog input voltage is less than the minimum value, the minimum value is used.

When the analog input is current input, 1 mA current corresponds to 0.5 V voltage.

F2-13 (AI1 filter time) is used to set the software filter time of AI1. If the analog input is liable to interference, increase the value of this parameter to stabilize the detected analog input. However, increase of the AI filter time will slow the response of analog detection. Set this parameter properly based on actual conditions.

In different applications, 100% of analog input corresponds to different nominal values. For details, refer to the description of different applications.

Figure 6-8 Relationship between analog input and corresponding setting

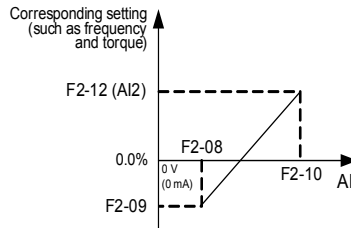

Function Code	Parameter Name	Setting Range	Default
F2-14	AI2 minimum input	0.00 V to F2-16	0.02 V
F2-15	Corresponding setting of AI2 minimum input	-100.00%–100.0%	0.0%
F2-16	AI2 maximum input	F2-14 to 10.00 V	10.00 V
F2-17	Corresponding setting mode of AI2 maximum input	0: F2-18 1: Determined by AI1	0
F2-18	Corresponding setting of AI2 maximum input	-100.00%–100.0%	100.0%

Function Code	Parameter Name	Setting Range	Default
F2-19	AI2 filter time	0.00–10.00s	0.10s

The method of setting AI2 is similar to that of setting AI1.

When AI2 provides the current input, the current 0–20 mA corresponds to the voltage 0–10 V. If the input current is 4–20 mA, 4 mA corresponds to 2 V. If it is required that 4–20 mA corresponds to 0%–100%, set the corresponding setting of voltage input to 2–10 V.

Note that F2-11 and F2-17 must not be set to 1 at the same time. Otherwise, AI1 and AI2 will become invalid due to the setting conflict.

Function Code	Parameter Name	Setting Range	Default
F2-20	Pulse minimum input	0.00 kHz to F2-22	0.00 kHz
F2-21	Corresponding setting of pulse minimum input	-100.00%–100.0%	0.0%
F2-22	Pulse maximum input	F2-20 to 50.00 kHz	50.00 kHz
F2-23	Corresponding setting mode of pulse maximum input	0: F2-24 1: Determined by AI1 2: Determined by AI2	0
F2-24	Corresponding setting of pulse maximum input	-100.00%–100.0%	100.0%
F2-25	Pulse filter time	0.00–10.00s	0.10s

These parameters are used to set the relationship between DI5 pulse input and corresponding settings. The pulses can only be input by DI5. The method of setting this function is similar to that of setting AI1 function.

Note that when F0-01 is set to 3 (Pulse setting), F3-00 must not be set to 0 (FMP pulse output), and vice versa.

Function Code	Parameter Name	Setting Range	Default
F2-26	DI valid state selection	0–127	0

This parameter defines the valid state of DI terminals by bit.

- 0: Positive logic

The terminal is valid when being connected with COM, and invalid when being disconnected from COM.

- 1: Negative logic

The terminal is invalid when being connected with COM, and valid when being disconnected from COM.

Bit	BIT6	BIT5	BIT4	BIT3	BIT2	BIT1	BIT0
Terminal	AI2	AI1	DI5	DI4	DI3	DI2	DI1

To set a DI as the negative logic, set the corresponding bit to 1, convert the binary value to a decimal value, and then set the decimal value in this function code.

Function Code	Parameter Name	Setting Range	Default
F2-27	Function selection of AI1 used as DI6	Same as F2-00	0
F2-28	Function selection of AI1 used as DI7	Same as F2-00	0

AI1 can be used as the DI, but ensure that the ground of AI (GND) and the ground of DI (COM) must not be connected.

Group F3: Output Terminals

The MD280 provides a multi-function FM terminal (FMP, AO or DO3), a relay output terminal, and two DO terminals (DO1 and DO2). The FM function and AO function share the same terminal and cannot be used at the same time. The FM terminal provides the pulse output or digital output (DO3), determined by F3-00.

Function Code	Parameter Name	Setting Range	Default
F3-00	FM terminal output mode	0: FMP pulse output 1: DO3 output 2: AO output	2

The FM terminal is programmable multiplexing terminal. It can be used for high-speed pulse output (FMP), with maximum frequency of 50 kHz. Refer to F3-06 for relevant functions of FMP. It can also be used as open collector switch signal output (FMR).

Function Code	Parameter Name	Default
F3-01	Relay function selection	2
F3-02	DO1 function selection	1
F3-03	DO2 function selection	4
F3-04	FM (DO3) function selection	0

These five parameters are used to select the functions of the digital output terminals.

The functions of the output terminals are described in the following table.

Table 6-4 Functions of output terminals

Value	Function	Description
0	No output	The terminal has no function.
1	AC drive running	When the AC drive is running (or in braking state) and has output frequency (can be zero), the terminal becomes ON.
2	Fault output 1	When a fault (except the undervoltage fault) occurs on the AC drive, the terminal becomes ON.
3	Frequency-level detection FDT output	Refer to the descriptions of F5-15 and F5-16.
4	Frequency reached	Refer to the descriptions of F5-17.

Value	Function	Description
5	Upper limit frequency reached	When the set frequency and running frequency are equal to or larger than the upper limit frequency, the terminal becomes ON.
6	Lower limit frequency reached	When the set frequency and running frequency are lower than or equal to the lower limit frequency, the terminal becomes ON.
7	Zero-speed running (no output at stop)	If the AC drive runs with the output frequency of zero or stops, the terminal becomes ON.
8	Motor overload pre-warning	The AC drive judges whether the motor load exceeds the overload pre-warning threshold before performing the protection action. If the pre-warning threshold is exceeded, the terminal becomes ON. For motor overload parameters, see the descriptions of FB-00 to FB-02.
9	AC drive overload pre-warning	The terminal becomes ON before the AC drive overload protection action is performed.
10	Set count value reached	The terminal becomes ON when the count value reaches the value set in F7-08.
11	Designated count value reached	The terminal becomes ON when the count value reaches the value set in F7-09.
12	Length reached	The terminal becomes ON when the detected actual length exceeds the value set in F7-05.
13	PLC cycle complete	When simple PLC completes one cycle, the terminal outputs a pulse signal with width of 250 ms.
14	Accumulative running time reached	If the accumulative running time (F7-12) of the AC drive exceeds the time set in F5-12, the terminal becomes ON.
15	Communication setting	Refer to the communication protocol.
16	Ready for run	When there is no fault, the bus voltage is normal, the terminal with the function of coast to stop is disabled, and the AC drive can be running, the terminal becomes ON.
17	AI1 > AI2	When the absolute value of AI1 setting is larger than that of AI2, the terminal becomes ON.
18	Detecting zero current	When the AC drive detects zero current, the terminal becomes ON.
19	External braking signal	See the descriptions of F5-39 and F5-40.
20	Software overcurrent	See the description of F5-27.
21	Fault output 2	When a fault (including the undervoltage fault) occurs on the AC drive, the terminal becomes ON.
22	Zero-speed running 2	If the AC drive runs with the output frequency of 0 (except the stop state), the terminal becomes ON.

Value	Function	Description
23	Fault output 3	When a fault occurs on the AC drive, the terminal becomes ON. For the undervoltage fault, the ON signal is output only during running.
24	Motor switchover output	It controls the contactor for switching over motors. When the terminal becomes OFF, motor 1 is controller, and when the terminal becomes ON, motor 2 is controller.

Function Code	Parameter Name	Default
F3-05	FMP/AO function selection	0

The standard analog output range (offset 0, gain 1) is 0–20 mA (or 0–10 V). The FMP output pulse frequency ranges from 0.01 kHz to "Maximum FMP output frequency" (F3-08).

The relationship between pulse and analog output ranges and corresponding functions is listed in the following table.

Table 6-5 Relationship between pulse and analog output ranges and corresponding functions

Value	Function	Range (Corresponding to Pulse or Analog Output Range 0.0%–100.0%)
0	Running frequency	0 to maximum output frequency (F0-04)
1	Set frequency	0 to maximum output frequency
2	Output current	0 to 2 times of rated motor current
3	Output power	0 to 2 times of rated motor power
4	Pulse input	1.0–50.00 kHz
5	AI1	0–10 V
6	AI2	0–10 V (or 0–20 mA)
7	Length	0 to maximum set length (F7-05)
8	Count value	0 to maximum count value (F7-08)
12	Communication setting	0.0%–100.0%

Function Code	Parameter Name	Setting Range	Default
F3-06	AO1 offset coefficient	-100.0%–100.0%	0.0%
F3-07	AO gain	-10.00–10.00	1.00

These parameters are used to correct the zero offset of analog output and the output amplitude deviation. They can also be used to define the desired AO curve.

If "b" represents zero offset, "k" represents gain, "Y" represents actual output, and "X" represents standard output, the actual output is: $Y = kX + b$.

The zero offset coefficient 100% of AO corresponds to 10 V (or 20 mA). The standard output refers to the value corresponding to the analog output of 0 to 10 V (or 0 to 20 mA) with no zero offset or gain adjustment.

For example, if the analog output is used as the running frequency, and it is expected that

the output is 8 V when the frequency is 0 and 3 V (6 mA) at the maximum frequency, the gain shall be set to -0.50, and the zero offset shall be set to 80%.

Function Code	Parameter Name	Setting Range	Default
F3-08	Maximum FMP output frequency	0.1–50.00 kHz	50.00 kHz

If the FM terminal (F3-00) is used for pulse output, this parameter is used to set the maximum frequency of pulse output.

Function Code	Parameter Name	Setting Range	Default
F3-09	Relay output delay time	0.0–3600.0s	0.0s
F3-10	DO1 output delay time	0.0–3600.0s	0.0s
F3-11	DO2 output delay time	0.0–3600.0s	0.0s
F3-12	DO3 output delay time	0.0–3600.0s	0.0s

These parameters are used to set the delay time of output terminals DOx from status change to actual output. The DOx signal can be recognized only when the width of the signal is larger than the value of the corresponding parameter.

Figure 6-9 DOx output delay

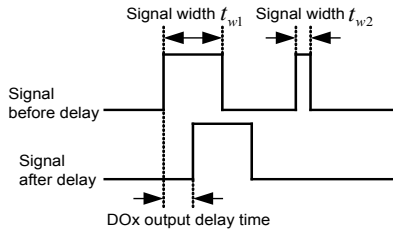

Function Code	Parameter Name	Setting Range	Default
F3-13	DO valid state selection	0–15	0

This parameter defines the valid state of DO terminals by bit.

- 0: Positive logic
The terminal is valid when being connected with COM, and invalid when being disconnected from COM.
- 1: Negative logic
The terminal is invalid when being connected with COM, and valid when being disconnected from COM.

Bit	BIT2	BIT2	BIT1	BIT0
Terminal	DO3	DO2	DO1	Relay

To set a DI as the negative logic, set the corresponding bit to 1, convert the binary value to a decimal value, and then set the decimal value in this function code.

Function Code	Parameter Name	Setting Range	Default
F3-14	Motor switchover delay	0.1–32.0s	0.1s
F3-15	Startup delay after motor switchover	0.1–32.0s	0.2s

F3-14 is used to set the delay from stop of the AC drive to the time of outputting the contactor control signal.

F3-15 is used to set the delay from the time when the contactor control signal becomes valid to the time when the AC drive starts up.

Group F4: Start/Stop Control

Function Code	Parameter Name	Setting Range	Default
F4-00	Start mode	0: Direct start 1: Rotational speed tracking restart	0

- 0: Direct start
 - If the DC braking time is set to 0, the AC drive starts to run at the startup frequency.
 - If the DC braking time is not 0, the AC drive performs DC braking first and then starts to run at the startup frequency. It is applicable to small-inertia load application where the motor is likely to rotate at startup.

- 1: Rotational speed tracking restart

The AC drive judges the rotational speed and direction of the motor first and then starts at the tracked frequency. Such smooth start has no impact on the rotating motor. It is applicable to the restart upon instantaneous power failure of large-inertia load. To ensure the performance of rotational speed tracking restart, set the motor parameters in group F1 correctly.

Function Code	Parameter Name	Setting Range	Default
F4-01	Rotational speed tracking mode	0: From frequency at stop 1: From zero speed 2: From maximum frequency	0

To complete the rotational speed tracking process within the shortest time, select the proper mode in which the AC drive tracks the motor rotational speed.

- 0: From frequency at stop
It is the commonly selected mode.
- 1: From zero frequency
It is applicable to restart after a long time of power failure.
- 2: From the maximum frequency
It is applicable to the power-generating load.

Function Code	Parameter Name	Setting Range	Default
F4-02	Rotational speed tracking speed	1–100	20

In the rotational speed tracking restart mode, select the rotational speed tracking speed. The larger the value is, the faster the tracking is. However, too large value may cause unreliable tracking.

Function Code	Parameter Name	Setting Range	Default
F4-03	Startup frequency	0.00 to maximum frequency (F0-04)	0.00 Hz
F4-04	Startup frequency holding time	0.0–36.0s	0.0s

To ensure the motor torque at AC drive startup, set a proper startup frequency. In addition, to build excitation when the motor starts up, the AC drive remains at the startup frequency for a certain period and then accelerates to the set frequency.

If the set target frequency is lower than the startup frequency, the AC drive will not start and stays in the standby state.

Example 1:

F0-03 = 0	The frequency source is digital setting.
F0-08 = 2.00 Hz	The digital setting frequency is 2.00 Hz.
F4-03 = 5.00 Hz	The startup frequency is 5.00 Hz.
F4-04 = 2.0s	The startup frequency holding time is 2.0s.

In this example, the AC drive stays in the standby state and the output frequency is 0.00 Hz.

Example 2:

F0-03 = 0	The frequency source is digital setting.
F0-08 = 10.0 0 Hz	The digital setting frequency is 10.00 Hz.
F4-03 = 5.00 Hz	The startup frequency is 5.00 Hz.
F4-04 = 2.0s	The startup frequency holding time is 2.0s.

In this example, the AC drive starts up at 5.00 Hz, holds the frequency for 2s, and then accelerates to the set frequency 10.00 Hz.

- The startup frequency (F6-03) is not restricted by the frequency lower limit.
- During switchover between forward rotation and reverse rotation, the startup frequency holding time is disabled.
- The holding time is not included in the acceleration time but in the running time of simple PLC.

Figure 6-10 Startup frequency and startup holding time

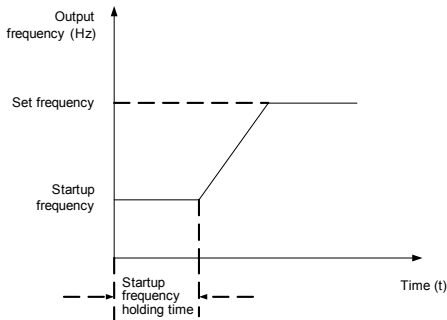

Function Code	Parameter Name	Setting Range	Default
F4-05	Startup DC braking current	0%–100%	0%
F4-06	Startup DC braking time	0.0–36.0s	0.0s

Startup DC braking is generally used during restart of the AC drive after the rotating motor stops.

Startup DC braking is valid only for direct start (F4-00 = 0). In this case, the AC drive performs DC braking at the set startup DC braking current. After the startup DC braking time, the AC drive starts to run. The larger the startup DC braking current is, the larger the braking force is.

The startup DC braking current is a percentage relative to the base value. If the startup DC braking time is 0, the AC drive starts directly without DC braking.

Figure 6-11 Startup DC braking

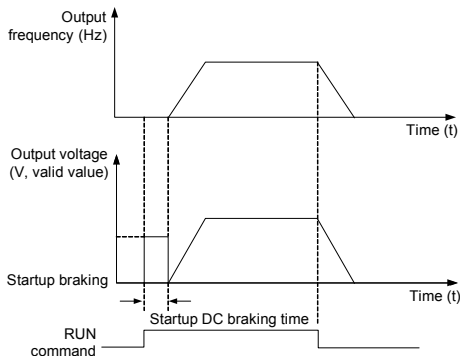

Function Code	Parameter Name	Setting Range	Default
F4-07	Acceleration/ Deceleration mode	0: Linear acceleration/deceleration 1: S-curve acceleration/deceleration A 2: S-curve acceleration/deceleration B	0

It is used to set the frequency change mode during the AC drive start and stop process.

- 0: Linear acceleration/deceleration

The output frequency increases or decreases in linear mode. The MD280 provides two group of acceleration/deceleration time, which can be selected by using F2-00 to F2-04.

- 1: S-curve acceleration/deceleration A

The output frequency increases or decreases along the S curve. This mode is generally used in the applications where start and stop processes are relatively smooth, such as elevator and conveyor belt. F4-08 and F4-09 respectively define the time proportions of the start segment and the end segment.

- 2: S-curve acceleration/deceleration B

In this curve, the rated motor frequency f_b is always the inflexion point. This mode is usually used in applications where acceleration/deceleration is required at the speed higher than the rated frequency.

When the set frequency is higher than the rated frequency, the acceleration/ deceleration time is:

$$t = \left(\frac{4}{9} \times \left(\frac{f}{f_b} \right)^2 + \frac{5}{9} \right) \times T$$

In the formula, f is the set frequency, f_b is the rated motor frequency and T is the acceleration time from 0 Hz to f_b .

Function Code	Parameter Name	Setting Range	Default
F4-08	Time proportion of S-curve start segment	0.0% to 100.0%	20.0%
F4-09	Time proportion of S-curve end segment	0.0% to 100.0%	20.0%

These two parameters respectively define the time proportions of the start segment and the end segment of S-curve acceleration/deceleration. They must satisfy the requirement: F4-08 + F4-09 ≤ 100.0%.

In Figure 6-12, t1 is the time defined in F4-08, within which the slope of the output frequency change increases gradually. t2 is the time defined in F4-09, within which the slope of the output frequency change gradually decreases to 0. Within the time between t1 and t2, the slope of the output frequency change remains unchanged, that is, linear acceleration/ deceleration.

Figure 6-12 S-curve acceleration/deceleration A

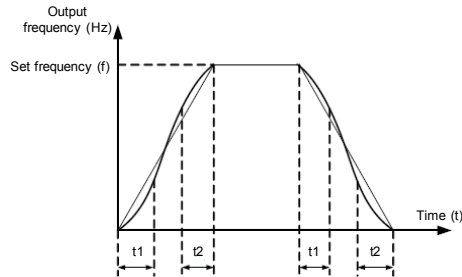
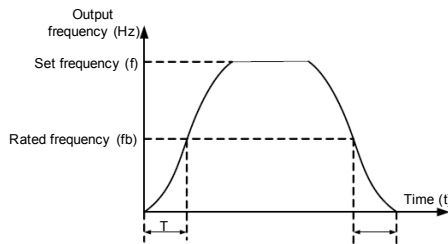

Figure 6-13 S-curve acceleration/deceleration B



Function Code	Parameter Name	Setting Range	Default
F4-10	Stop mode	0: Decelerate to stop 1: Coast to stop	0

- 0: Decelerate to stop

After the stop command is enabled, the AC drive decreases the output frequency according to the deceleration time and stops when the frequency decreases to zero.

- 1: Coast to stop

After the stop command is enabled, the AC drive immediately stops the output. The motor will coast to stop based on the mechanical inertia.

Function Code	Parameter Name	Setting Range	Default
F4-11	Initial frequency of stop DC braking	0.00 Hz to maximum frequency (F0-04)	0.00 Hz
F4-12	Waiting time of stop DC braking	0.0–36.0s	0.0s
F4-13	Stop DC braking current	0%–100%	0%
F4-14	Stop DC braking time	0.0–36.0s	0.0s

- F4-11 (Initial frequency of stop DC braking)

During the process of decelerating to stop, the AC drive starts DC braking when the running frequency is lower than the value set in F4-11.

- F4-12 (Waiting time of stop DC braking)

When the running frequency decreases to the initial frequency of stop DC braking, the AC drive stops output for a certain period and then starts DC braking. This prevents faults such as overcurrent caused due to DC braking at high speed.
- F4-13 (Stop DC braking current)

This parameter specifies the output current at DC braking and is a percentage relative to the base value.
- F4-14 (Stop DC braking time)

This parameter specifies the holding time of DC braking. If it is set to 0, DC braking is cancelled.

The stop DC braking process is shown in the following figure.

Figure 6-14 Stop DC braking process

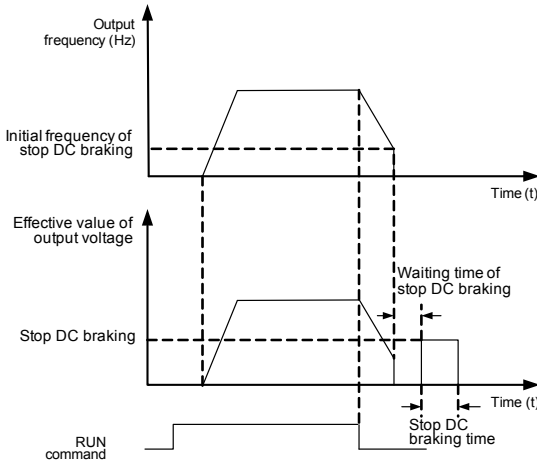

Function Code	Parameter Name	Setting Range	Default
F4-15	Brake use ratio	0%–100%	100%

It is valid only for the AC drive with internal braking unit and used to adjust the duty ratio of the braking unit. The larger the value of this parameter is, the better the braking result will be. However, too larger value causes great fluctuation of the AC drive bus voltage during the braking process.

Group F5: Auxiliary Functions

Function Code	Parameter Name	Setting Range	Default
F5-00	JOG running frequency	0.00 Hz to maximum frequency (F0-04)	2.00 Hz
F5-01	JOG acceleration time	0.0–300.0s	20.0s

Function Code	Parameter Name	Setting Range	Default
F5-02	JOG deceleration time	0.0–300.0s	20.0s

These parameters are used to define the set frequency and acceleration/deceleration time of the AC drive when jogging. The startup mode is "Direct start" (F4-00 = 0) and the stop mode is "Decelerate to stop" (F4-10 = 0) during jogging.

F5-01 (JOG acceleration time) specifies the time for the AC drive to accelerate from 0 Hz to the maximum output frequency (F0-04). F5-02 (JOG deceleration time) specifies the time for the AC drive to decelerate from the maximum output frequency (F0-04) to 0 Hz.

Forward JOG and reverse JOG are valid regardless of the setting of F0-00.

Note that the JOG running frequency is not limited by the frequency lower limit and jump frequency.

Function Code	Parameter Name	Setting Range	Default
F5-03	JOG during running	0: Disabled 1: Enabled	0

It is used to set whether JOG is allowed during running.

If the JOG function is enabled during running, the AC drive executes the active JOG command first and then restores to the running state before the JOG operation.

Note that this function is disabled during DC braking.

If the PLC is used, it memorizes the running stage and accumulative running time at the JOG moment. After the JOG operation is completed, the AC drive restores to the running stage and continues to run for the rest time in this stage.

Function Code	Parameter Name	Setting Range	Default
F5-04	Acceleration time 2	0.0–300.0s (m)	Model dependent
F5-05	Deceleration time 2	0.0–300.0s (m)	Model dependent

This group of acceleration/deceleration time is set in the same way as acceleration/deceleration 1 in F0-09 and F0-10. You can switch over between the four groups of acceleration/deceleration time through a DI. For more details, see the descriptions of F2-00 to F2-04.

Function Code	Parameter Name	Setting Range	Default
F5-06	Jump frequency	0.00 Hz to maximum frequency (F0-04)	0.00 Hz
F5-07	Frequency jump amplitude	0.00 Hz to maximum frequency (F0-04)	0.00 Hz

If the set frequency is within the frequency jump range, the actual running frequency is the jump frequency close to the set frequency. Setting the jump frequency helps to avoid the mechanical resonance point of the load.

If the jump frequency is set to 0, the frequency jump function is disabled. The principle of the jump frequencies and jump amplitude is shown in the following figure.

Figure 6-15 Principle of the jump frequencies and jump amplitude

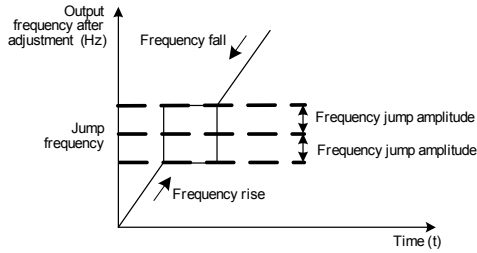

Function Code	Parameter Name	Setting Range	Default
F5-08	Forward/Reverse rotation dead-zone time	0.0–100.0s	0.0s

It is used to set the time when the output is 0 Hz at transition of the AC drive forward rotation and reverse rotation, as shown in the following figure.

Figure 6-16 Forward/Reverse rotation dead-zone time

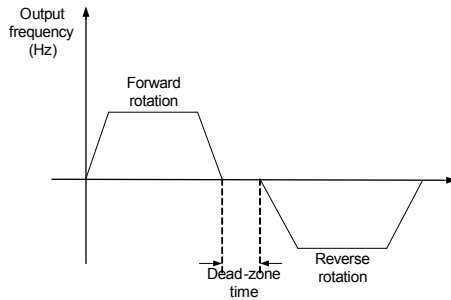

Function Code	Parameter Name	Setting Range	Default
F5-09	Reverse control	0: Enabled 1: Disabled	0

It is used to set whether the AC drive allows reverse rotation. In the applications where reverse rotation is prohibited, set this parameter to 1.

This function is valid to the JOG running.

Function Code	Parameter Name	Setting Range	Default
F5-10	Running mode when set frequency lower than frequency lower limit	0: Run at frequency lower limit 1: Stop 2: Run at zero speed	0

It is used to set the AC drive running mode when the set frequency is lower than the frequency lower limit. The MD280 provides three running modes to satisfy requirements of various applications.

Function Code	Parameter Name	Setting Range	Default
F5-11	Delay for stop when set frequency lower than frequency lower limit	0.00–3600.00s	0.0s

If F5-10 is set to 1, when the set frequency is lower than the frequency lower limit, the AC drive decelerates to the frequency lower limit, stays running at the frequency lower limit for the time set in this parameter, and then stops.

Function Code	Parameter Name	Setting Range	Default
F5-12	Accumulative running time threshold	0–65535h	0 h

It is used to set the accumulative running time threshold of the AC drive. If the accumulative running time (F7-12) reaches the value set in this parameter, the corresponding DO terminal becomes ON.

When this parameter is set to 0, this timing function is disabled.

Function Code	Parameter Name	Setting Range	Default
F5-13	Action when set accumulative power-on time reached	0: Continue to run 1: Stop	0

It is used to select the action when the accumulative running time (F7-12) reaches the value set in F5-12.

If this parameter is set to 1, when the accumulative running time reaches the set threshold, the AC drive reports fault ERR26 and stops. This fault can be cleared only by using one of the following methods:

1. Change the setting of this parameter to 0 (Continue to run).
2. Set F5-12 to 0 h to disable the function.
3. Set F5-12 to a value larger than that of F7-12 to continue the timing function.

If the timing function is not required, set this parameter to 0 (Continue to run).

Function Code	Parameter Name	Setting Range	Default
F5-14	Startup protection	0: Disabled 1: Enabled	0

This parameter is used to set whether to enable the safety protection. If it is set to 1, the AC drive does not respond to the run command valid upon AC drive power-on (for example, an input terminal is ON before power-on). The AC drive responds only after the run command is cancelled and becomes valid again.

In addition, the AC drive does not respond to the run command valid upon fault reset of the AC drive. The run protection can be disabled only after the run command has been cancelled.

In this way, the motor can be protected from responding to run commands upon power-on or fault reset in unexpected conditions.

Function Code	Parameter Name	Setting Range	Default
F5-15	Frequency detection value	0.00 Hz to maximum frequency (F0-04)	50.00 Hz
F5-16	Frequency detection hysteresis	0.0%–100.0%	5.0%

If the running frequency is higher than the value of F5-15, the corresponding DO terminal becomes ON. If the running frequency is lower than a certain frequency (FDT level – F5-15 x F5-16), the DO terminal goes OFF, as shown in the following figure.

Figure 6-17 FDT level detection

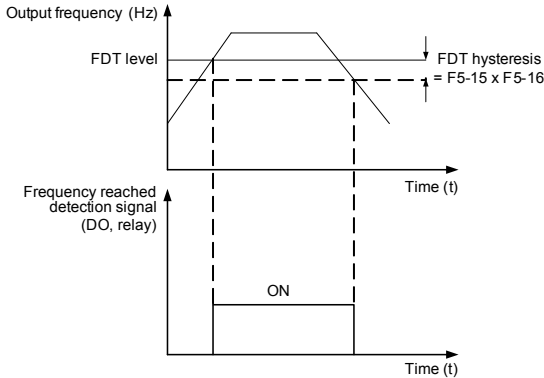

Function Code	Parameter Name	Setting Range	Default
F5-17	Detection range of frequency reached	0.00–100% (maximum frequency in F0-04)	0.0%

If the AC drive running frequency is within the certain range of the set frequency, the corresponding DO terminal becomes ON.

This parameter is used to set the range within which the output frequency is detected to reach the set frequency.

Figure 6-18 Detection range of frequency reached

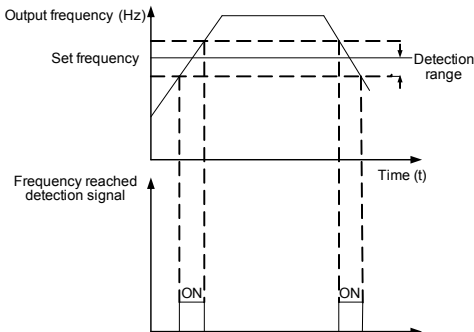

Function Code	Parameter Name	Setting Range	Default
F5-18	Random PWM gain	0: Random PWM invalid 1–10	0

The setting of random PWM depth can make the shrill motor noise softer and reduce the electromagnetic interference. If this parameter is set to 0, random PWM is invalid.

Function Code	Parameter Name	Setting Range	Default
F5-19	PWM modulation mode	0: Asynchronous modulation 1: Synchronous modulation	0

Synchronous modulation is generally used at medium output frequency, which helps improve the output voltage quality. This mode reduces the current ripple and electromagnetic noise but increases the loss to switches.

Synchronous modulation takes effect only when the running frequency is higher than 85 Hz.

Function Code	Parameter Name	Setting Range	Default
F5-20	Rapid current limit	0: Disabled 1: Enabled	1

The rapid current limit function can reduce the AC drive's overcurrent faults at maximum, guaranteeing uninterrupted running of the AC drive.

However, long-time rapid current limit may cause the AC drive to overheat, which is not allowed. In this case, the AC drive will report Err40, indicating the AC drive is overloaded and needs to stop.

Do not use this function for the hoist load.

Function Code	Parameter Name	Setting Range	Default
F5-21	Wakeup frequency	Dormant frequency (F5-23) to maximum frequency (F0-04)	0.00 Hz
F5-22	Wakeup delay time	0.0–6500.0s	0.0s
F5-23	Dormant frequency	0.00 Hz to wakeup frequency (F5-21)	0.00 Hz
F5-24	Dormant delay time	0.0–6500.0s	0.0s

These parameters are used to implement the dormant and wakeup functions in the water supply application.

When the AC drive is in running state, the AC drive enters the dormant state and stops automatically after the dormant delay time (F5-22) if the set frequency is lower than or equal to the dormant frequency (F5-21).

When the AC drive is in dormant state and the current running command is effective, the AC drive starts up after the wakeup delay time (F5-24) if the set frequency is higher than or equal to the wakeup frequency (F5-23).

Generally, set the wakeup frequency equal to or higher than the dormant frequency. If the wakeup frequency and dormant frequency are set to 0, the dormant and wakeup functions are disabled.

When the dormant function is enabled, if the frequency source is PID, whether PID operation is performed in the dormant state is determined by F6-10. In this case, select PID operation enabled in the stop state (F6-10 = 1).

Function Code	Parameter Name	Setting Range	Default
F5-25	Software overcurrent threshold	0.0%–300.0% (rated motor current)	200.0%
F5-26	Software overcurrent detection delay	0.00s (no detection) 0.01–6500.0s	0.0s

If the output current of the AC drive reaches the overcurrent threshold and the duration exceeds the detection delay time, the AC drive reports ERR31.

Function Code	Parameter Name	Setting Range	Default
F5-27	Overcurrent detection delay (for DO output)	0.00s (no detection) 0.01–6500.0s	0.00s

If the output current of the AC drive reaches the overcurrent threshold and the duration exceeds the detection delay time, the DO terminal with function 20 becomes ON.

Function Code	Parameter Name	Setting Range	Default
F5-37	Dead zone compensation	0: Disabled 1: Enabled	1

If the frequency is lower than 200 Hz, set this parameter to 0; otherwise, set this parameter to 1.

Function Code	Parameter Name	Setting Range	Default
F5-38	Cooling fan control	0: Fan working during running 1: Fan working continuously after power-on	0

Function Code	Parameter Name	Setting Range	Default
F5-39	External braking startup frequency	0.00 Hz to maximum frequency (F0-04)	0.00 Hz
F5-40	External braking time	0.0–3600.0s	0.0s

At stop, when the running frequency is lower than the value of F5-39, the braking signal is active. The braking signal becomes invalid after lasting the time set in F5-40.

The braking signal is inactive during startup.

Function Code	Parameter Name	Setting Range	Default
F5-41	Jump frequency execution mode	0: Not execute during acceleration/ deceleration 1: Execute during acceleration/ deceleration	0

Function Code	Parameter Name	Setting Range	Default
F5-43	Power-on time (in second)	0.00–3599s	0s

Function Code	Parameter Name	Setting Range	Default
F5-44	Power-on time (in hour)	0–65535 h	0 h

Accumulative power-on time = F5-44 + F5-43

Group F6: Process Control PID Function

PID control is a general process control method. By performing proportional, integral and differential operations on the difference between the feedback signal and the target signal, it adjusts the output frequency and constitutes a feedback system to stabilize the controlled counter around the target value.

It is applied to process control such as flow control, pressure control and temperature control. The following figure shows the principle block diagram of PID control.

Figure 6-19 Principle block diagram of PID control

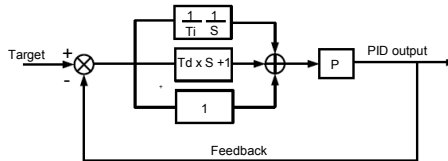

Function Code	Parameter Name	Setting Range	Default
F6-00	PID setting source	0: F6-01 1: AI1 2: AI2 3: Pulse setting (DI5) 4: Multi-reference	0
F6-01	PID digital setting	0.0%–100.0%	50.0%

F6-00 is used to select the channel of target process PID setting. The PID setting is a relative value and ranges from 0.0% to 100.0%. The PID feedback is also a relative value.

When F6-00 is set to 4 (Multi-reference), F8-00 must not be set to 4 (PID setting).

When F6-00 is set to 0, you need to set the value of F6-01.

Function Code	Parameter Name	Setting Range	Default
F6-02	PID setting change time	0.0–3000.0s	0.0s

It is used to set the time for the PID setting to change from 0% to 100%.

Function Code	Parameter Name	Setting Range	Default
F6-03	PID feedback source	0: AI1 1: AI2 2: Pulse setting (DI5) 3: AI1 – AI2	0

This parameter is used to select the feedback signal channel of process PID.

Function Code	Parameter Name	Setting Range	Default
F6-04	PID action direction	0: Forward action 1: Reverse action	0

- 0: Forward action
When the feedback value is smaller than the PID setting, the AC drive's output frequency rises. For example, the winding tension control requires forward PID action.
- 1: Reverse action
When the feedback value is smaller than the PID setting, the AC drive's output frequency reduces. For example, the unwinding tension control requires reverse PID action.

Function Code	Parameter Name	Setting Range	Default
F6-05	PID setting feedback range	0–65535	1000

This parameter is a non-dimensional unit. It is used for PID setting display and PID feedback display.

If this parameter is set to 1000, PID setting and PID feedback 0% to 100.0% corresponds to 0 to 1000 in linear mode.

Function Code	Parameter Name	Setting Range	Default
F6-06	Proportional gain Kp1	0.0–100.0	20.0
F6-07	Integral time Ti1	0.01–10.00s	2.00s
F6-08	Differential time Td1	0.00–10.000	0.000s

- F6-06 (Proportional gain Kp1)
It decides the regulating intensity of the PID regulator. The higher the Kp1 is, the larger the regulating intensity is. The value 100.0 indicates when the deviation between PID feedback and PID setting is 100.0%, the adjustment amplitude of the PID regulator on the output frequency reference is the maximum frequency.
- F6-07 (Integral time Ti1)
It decides the integral regulating intensity. The shorter the integral time is, the larger the regulating intensity is. When the deviation between PID feedback and PID setting is 100.0%, the integral regulator performs continuous adjustment for the time set in F6-07. Then the adjustment amplitude reaches the maximum frequency.
- F6-08 (Differential time Td1)
It decides the regulating intensity of the PID regulator on the deviation change. The longer the differential time is, the larger the regulating intensity is. Differential time is the time within which the feedback value change reaches 100.0%, and then the adjustment amplitude reaches the maximum frequency.

Function Code	Parameter Name	Setting Range	Default
F6-09	PID deviation limit	0.0%–100.0%	0.0%

If the deviation between PID feedback and PID setting is smaller than the value of F6-09, PID control stops. The small deviation between PID feedback and PID setting will make the

output frequency stabilize, effective for some closed-loop control applications.

Figure 6-20 PID deviation limit

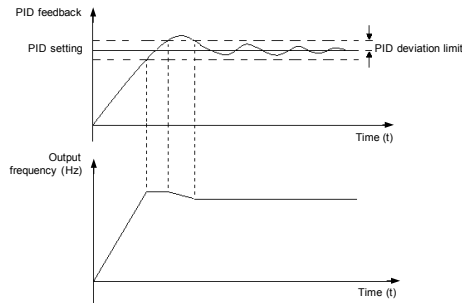

Function Code	Parameter Name	Setting Range	Default
F6-10	PID operation at stop	0: No PID operation at stop 1: PID operation at stop	0

It is used to select whether to continue PID operation in the state of stop. Generally, the PID operation stops when the AC drive stops.

Function Code	Parameter Name	Setting Range	Default
F6-11	Cut-off frequency of PID reverse rotation	0.00 to maximum frequency (F0-04)	2.00 Hz

Too high reverse rotation frequency is prohibited in some applications, and this parameter is used to determine the reverse rotation frequency upper limit.

Function Code	Parameter Name	Setting Range	Default
F6-12	PID mode hibernation	0: Disabled 1: Enabled	0
F6-13	Wakeup tolerance	0.1%–100.0%	10.0%
F6-14	Wakeup delay	0.1–6500.0s	0s
F6-15	Hibernation tolerance	0.0%–100.0%	10.0%
F6-16	Hibernation frequency	0.00 Hz to maximum frequency (F0-04)	20.00 Hz
F6-17	Hibernation delay	0.1–6500.0s	0s

F6-12: When this parameter is set to 1, the functions defined in F5-21 to F5-24 are replaced.

F6-13: The value 100.0% corresponds to the PID setting value.

F6-14: wakeup conditions:

When $\text{PID feedback} \leq \text{PID setting} \times (100\% - \text{F6-13})$, the counting is started.

When counting time $\geq \text{F6-14}$, the AC drive is waken up.

F6-15: same as F6-13

F6-17: hibernation conditions:

When the PID feedback \geq PID setting \times (100% + F6-15) and target frequency \leq F6-16, the counting is started.

When counting time \geq F6-17, the AC drive enters the hibernation state.

Group F7: Swing Frequency, Fixed Length and Count

The swing frequency function is applied to the textile and chemical fiber fields and the applications where traversing and winding functions are required.

The swing frequency function indicates that the output frequency of the AC drive swings up and down with the set frequency as the center. The trace of running frequency at the time axis is shown in the following figure.

The swing amplitude is set in F7-00 and F7-01. When F7-01 is set to 0, the swing amplitude is 0 and the swing frequency does not take effect.

Figure 6-21 Swing frequency control

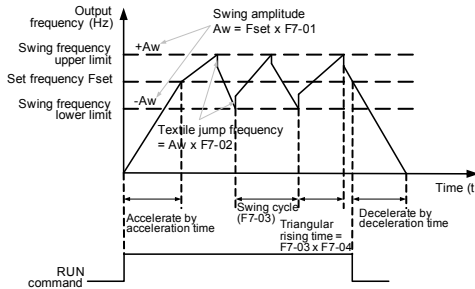

Function Code	Parameter Name	Setting Range	Default
F7-00	Swing frequency setting mode	0: Relative to the central frequency 1: Relative to the maximum frequency	0

This parameter is used to select the base value of the swing amplitude.

- 0: Relative to the central frequency (F0-03 "Frequency source selection")

It is variable swing amplitude system. The swing amplitude varies with the central frequency (set frequency).

- 1: Relative to the maximum frequency (F0-04 "Maximum frequency")

It is fixed swing amplitude system. The swing amplitude is fixed.

Function Code	Parameter Name	Setting Range	Default
F7-01	Swing frequency amplitude	0.0%–100.0%	0.0%
F7-02	Jump frequency amplitude	0.0%–50.0%	0.0%

These parameters are used to determine the swing amplitude and jump frequency amplitude. The swing frequency is limited by the frequency upper limit and frequency lower limit.

- If relative to the central frequency (F7-00 = 0), AW (swing amplitude) = F0-01 x F7-01.
- If relative to the maximum frequency (F7-00 = 1), AW = F0-04 x F7-01.
Jump frequency = AW x F7-02.
- If relative to the central frequency (F7-00=0), the jump frequency is a variable value.
- If relative to the maximum frequency (F7-00 = 1), the jump frequency is a fixed value.

The swing frequency is limited by the frequency upper limit and frequency lower limit.

Function Code	Parameter Name	Setting Range	Default
F7-03	Swing frequency cycle	0.0–3000.0s	10.0s
F7-04	Triangular wave rising time coefficient	0.0%–100.0%	50.0%

F7-03 specifies the time of a complete swing frequency cycle.

F7-04 specifies the time percentage of triangular wave rising time to F7-03 (Swing frequency cycle).

- Triangular wave rising time = F7-03 x F7-04 (unit: s)
- Triangular wave falling time = F7-03 x (1 – F7-04) (unit: s)

When the AC drive runs at the swing frequency, if the central frequency changes, the AC drive stops swing, and starts swing again only after running from the current central frequency to the modified value.

Function Code	Parameter Name	Setting Range	Default
F7-05	Set length	0–65535 m	1000 m
F7-06	Actual length	0–65535 m	0 m
F7-07	Number of pulses per meter	0.1–6553.5	100.0

The preceding parameters are used for fixed length control.

The length information is collected by means of the pulse signal of a DI terminal allocated with function 12 (Length reached). When the pulse frequency is high, DI5 must be used.

F7-06 (Actual length) records the count length. Set this parameter before length counting as the initial value.

Actual length = Initial length value + Number of pulses/F7-07

When the actual length F7-06 exceeds the set length in F7-05, the DO terminal allocated with function 12 (Length reached) becomes ON.

The actual length can be viewed in real time. For details, see the descriptions of F7-13 and F7-14.

Function Code	Parameter Name	Setting Range	Default
F7-08	Set count value	1–65535	1000
F7-09	Designated count value	1–65535	1000

When the count value reaches the set count value (F7-08), the DO terminal allocated with function 10 (Set count value reached) becomes ON. Then the counter continues the counting.

When the counting value reaches the designated counting value (F7-09), the DO terminal allocated with function 11 (Designated count value reached) becomes ON. Then the counter continues to count.

Figure 6-22 Reaching the set count value and designated count value

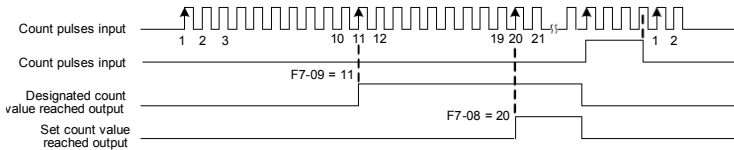

Function Code	Parameter Name	Setting Range	Default
F7-10	Load speed display coefficient	0.0001–6.5000	1.0000
F7-11	Number of decimal places for load speed display	0: 0 decimal place 1: 1 decimal place 2: 2 decimal places 3: 3 decimal places	1

F7-10 is used to adjust the relationship between the output frequency of the AC drive and the load speed.

F7-11 is used to set the number of decimal places for load speed display. The following gives an example to explain how to calculate the load speed:

Assume that F7-10 (Load speed display coefficient) is 2.000 and F7-11 is 2 (2 decimal places). When the running frequency of the AC drive is 40.00 Hz, the load speed is $40.00 \times 2.000 = 80.00$ (display of 2 decimal places).

Function Code	Parameter Name	Setting Range	Default
F7-12	Accumulative running time	0–65535 h	-

It is used to display the accumulative running time of the AC drive. After the accumulative running time reaches the value set in F5-12, the corresponding terminal becomes ON.

You can clear the record of this parameter by setting FP-01.

Function Code	Parameter Name	Setting Range	Default
F7-13	LED display running parameters	1-65535 	799

In stop state, a total of eight status parameters can be displayed, as listed in the following table.

Function Code	Parameter Name	Setting Range	Default
F7-14	LED display stop parameters	1-511 	51

Function Code	Parameter Name	Setting Range	Default
F7-15	MF.K Key function selection	0: MF.K key disabled 1: Switchover between operation panel control and remote command control (terminal or communication) 2: Switchover between forward rotation and reverse rotation 3: Forward JOG	0

MF.K key refers to multifunctional key. You can set the function of the MF.K key by using this parameter. You can perform switchover by using this key both in stop or running state.

- 0: MF.K key disabled

This key is disabled.

- 1: Switchover between operation panel control and remote command control (terminal or communication)

You can perform switchover from the current command source to the operation panel control (local operation). If the current command source is operation panel control, this key is invalid.

If a DI terminal is used to perform such switchover, this function of the MF.K key is disabled.

- 2: Switchover between forward rotation and reverse rotation

You can change the direction of the frequency reference by using the MF.K key. It is valid only when the current command source is operation panel control.

- 3: Forward JOG

You can perform forward JOG (FJOG) by using the MF.K key.

- 4: Reverse JOG

You can perform reverse JOG (FJOG) by using the MF.K key.

Function Code	Parameter Name	Setting Range	Default
F7-16	STOP/RESET key function	0: Stop function enabled only in operation panel control 1: Stop function enabled in any control mode	0

- 0: Enabled only in operation panel control

The stop function of this key is enabled only when F0-00 is set to 0 (Operation panel control).

- 1: Enabled in any control mode

The stop function of this key is enabled in any control mode, and is valid for the JOG operation.

Note that the fault reset function of this key is enabled in any control mode.

Function Code	Parameter Name	Setting Range	Default
F7-17	Software version	-	-

Group F8: Multi-Reference and Simple PLC Function

The MD280 has a built-in PLC to implement automatic control on multi-reference logics.

This function supports setting of the running time, running direction, and running frequency.

The MD280 supports eight references and two groups of acceleration/deceleration time.

When the PLC completes a cycle, the corresponding DO terminal or relay becomes ON. For

details, see the output terminal functions described in group F3.

When F0-01 is set to 4 (Multi-reference), set F8-00 and F8-08 to determine the required speeds.

Function Code	Parameter Name	Setting Range	Default
F8-00	Reference 0 setting source	0: Set by F8-01 1: AI1 2: AI2 3: Pulse setting 4: PID 5: Preset frequency (F0-03) with UP/DOWN modification	0

It is used to set the setting source of reference 0.

Note that when F8-00 is set to 4, F6-00 (PID setting source) cannot be set to 4 (Multi-reference).

Function Code	Parameter Name	Setting Range	Default
F8-01	Reference 0	-100.0%–100.0%	0.0%
F8-02	Reference 1	-100.0%–100.0%	0.0%
F8-03	Reference 2	-100.0%–100.0%	0.0%
F8-04	Reference 3	-100.0%–100.0%	0.0%
F8-05	Reference 4	-100.0%–100.0%	0.0%
F8-06	Reference 5	-100.0%–100.0%	0.0%
F8-07	Reference 6	-100.0%–100.0%	0.0%
F8-08	Reference 7	-100.0%–100.0%	0.0%

When F0-01 is set to 5 (PLC), you need to set the PLC running parameters F8-00 to F8-27. The negative/positive mark of values of F8-00 to F8-08 determines the simple PLC running direction: The positive mark indicates the forward direction, and the negative mark indicates the reverse direction.

Figure 6-23 Simple PLC running

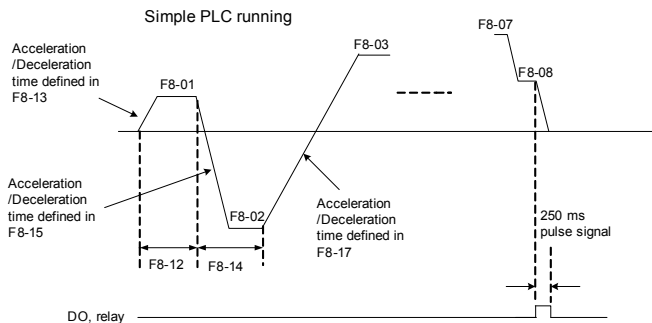

Function Code	Parameter Name	Setting Range	Default
F8-09	Simple PLC running mode	0: Stop after the AC drive runs one cycle 1: Keep final values after the AC drive runs one cycle 2: Repeat after the AC drive runs one cycle	0

- 0: Stop after the AC drive runs one cycle
The AC drive stops after running one cycle, and will not start up until receiving another command.
- 1: Keep final values after the AC drive runs one cycle
The AC drive keeps the final running frequency and direction after running one cycle.
- 2: Repeat after the AC drive runs one cycle
The AC drive automatically starts another cycle after running one cycle, and will not stop until receiving the stop command.

Function Code	Parameter Name	Setting Range	Default
F8-10	Simple PLC retentive at power failure	0: No 1: Yes	00

PLC retentive upon power failure indicates that the AC drive memorizes the PLC running moment and running frequency before power failure and will continue to run from the memorized moment after it is powered on again. If the unit's digit is set to 0, the AC drive restarts the PLC process after it is powered on again.

Retentive at stop is not supported.

Function Code	Parameter Name	Setting Range	Default
F8-11	Unit of PLC running time	0: s (second) 1: h (hour)	0

Function Code	Parameter Name	Setting Range	Default
F8-12	Running time of simple PLC reference 0	0.0–6553.5s (h)	0.0s (h)
F8-13	Acceleration/Deceleration time of simple PLC reference 0	0–1	0
F8-14	Running time of simple PLC reference 1	0.0–6553.5s (h)	0.0s (h)
F8-15	Acceleration/Deceleration time of simple PLC reference 1	0–1	0
F8-16	Running time of simple PLC reference 2	0.0–6553.5s (h)	0.0s (h)
F8-17	Acceleration/Deceleration time of simple PLC reference 2	0–1	0
F8-18	Running time of simple PLC reference 3	0.0–6553.5s (h)	0.0s (h)

Function Code	Parameter Name	Setting Range	Default
F8-19	Acceleration/Deceleration time of simple PLC reference 3	0–1	0
F8-20	Running time of simple PLC reference 4	0.0–6553.5s (h)	0.0s (h)
F8-21	Acceleration/Deceleration time of simple PLC reference 4	0–1	0
F8-22	Running time of simple PLC reference 5	0.0–6553.5s (h)	0.0s (h)
F8-23	Acceleration/Deceleration time of simple PLC reference 5	0–1	0
F8-24	Running time of simple PLC reference 6	0.0–6553.5s (h)	0.0s (h)
F8-25	Acceleration/Deceleration time of simple PLC reference 6	0–1	0
F8-26	Running time of simple PLC reference 7	0.0–6553.5s (h)	0.0s (h)
F8-27	Acceleration/Deceleration time of simple PLC reference 7	0–1	0

Group F9: Reserved

Group FA: Communication Parameters

For details, see the description of the communication protocol.

Group FB: Overload and Protection

Function Code	Parameter Name	Setting Range	Default
FB-00	Motor overload protection selection	0: Disabled 1: Enabled	1
FB-01	Motor overload protection gain	0.20–10.00	1.00

- FB-00 = 0

The motor overload protective function is disabled. The motor is exposed to potential damage due to overheating. A thermal relay is suggested to be installed between the AC drive and the motor.

- FB-00 = 1

The AC drive judges whether the motor is overloaded according to the inverse time-lag curve of the motor overload protection.

The inverse time-lag curve of the motor overload protection is:

155% x FB-01 x rated motor current (if the load remains at this value for two minutes, the AC drive reports motor overload fault Err11), or

115% x FB-01 x rated motor current (if the load remains at this value for 80 minutes, the AC drive reports motor overload fault Err11)

Set FB-01 properly based on the actual overload capacity. If the value of FB-01 is set too

large, damage to the motor may result because the motor overheats but the AC drive does not report the alarm.

Figure 6-24 Inverse time-lag curve of the motor overload protection

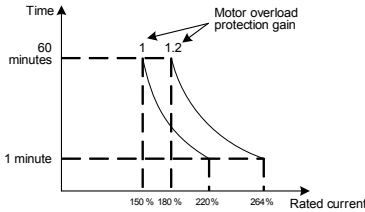

Function Code	Parameter Name	Setting Range	Default
FB-02	Motor overload pre-warning coefficient	50%–100%	80%

This function is used to give a warning signal to the control system via a DO before motor overload protection. This parameter is used to determine the percentage at which pre-warning is performed before motor overload. The larger the value is, the less advanced the pre-warning will be.

If FB-01 is set to 1, and FB-02 is set to 80%, when the motor runs for four minutes (80% x 5 minutes) at 145% of the rated motor current, the DO terminal on the AC drive allocated with function 8 (Motor overload pre-warning) or the fault relay becomes ON.

Function Code	Parameter Name	Setting Range	Default
FB-03	Overvoltage stall gain	0 (no stall overvoltage)–100	0
FB-04	Overvoltage stall protective threshold	120%–150%	130%

FB-03 (Overvoltage stall gain) is used to adjust the overvoltage suppression capacity of the AC drive. The larger the value is, the greater the overvoltage suppression capacity will be. In the prerequisite of no overvoltage occurrence, set FB-03 to a small value.

For small-inertia load, the value should be small. Otherwise, the system dynamic response will be slow. For large-inertia load, the value should be large. Otherwise, the suppression result will be poor and an overvoltage fault may occur.

Set the value to 10 only in applications with very small inertia.

FB-04 specifies the voltage threshold from which the AC drive starts to perform voltage stall protection.

Function Code	Parameter Name	Setting Range	Default
FB-05	Overcurrent stall gain	0–100	20
FB-06	Overcurrent stall protective current	100%–200%	150%

When the output current exceeds the value of FB-06 (Overcurrent stall protective current), the AC drive stops acceleration during acceleration, reduces the output frequency at constant-speed running, or reduces the deceleration frequency during deceleration. After the output current declines to smaller than the value of FB-06, the AC drive continues to run.

The value of FB-06 is a percentage relative to the rated motor current.

FB-05 (Overcurrent stall gain) is used to adjust the overcurrent suppression capacity of the AC drive. The larger the value is, the greater the overcurrent suppression capacity will be. In the prerequisite of no overcurrent occurrence, set FB-05 to a small value. When the inertia is very small, set this parameter to a value smaller than 20.

For small-inertia load, the value should be small. Otherwise, the system dynamic response will be slow. For large-inertia load, the value should be large. Otherwise, the suppression result will be poor and overcurrent fault may occur.

If the overcurrent stall gain is set to 0, the overcurrent stall function is disabled.

Figure 6-25 Diagram of the overcurrent stall protection function

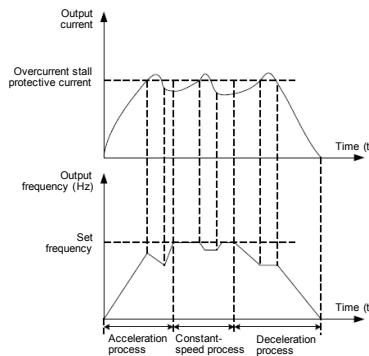

Function Code	Parameter Name	Setting Range	Default
FB-07	Short-circuit to ground upon power-on	0: Disabled 1: Enabled	1

It is used to determine whether to check the motor is short-circuited to ground at power-on of the AC drive. If this function is enabled, the AC drive's UVW will have voltage output a while after power-on.

Function Code	Parameter Name	Setting Range	Default
FB-08	Protection upon off-load	0: Disabled 1: Enabled	0

If this function is enabled, the output frequency of the AC drive is 7% of the rated motor frequency after the load the AC drive becomes 0. After the load restores, the AC drive run at the set frequency.

Function Code	Parameter Name	Setting Range	Default
FB-09	Power dip ride-through function	0: Disabled 1: Enabled	0
FB-10	Power dip ride-through frequency decline rate	0.00 Hz/s to F0-04/s	10.00 Hz/s
FB-11	Voltage rise judging time of power dip ride-through	0.00–100.00s	0.50s

Function Code	Parameter Name	Setting Range	Default
FB-12	Judging voltage of power dip ride-through action	60.0%–100.0%	80.0%

If the power dip ride-through function is enabled, when the bus voltage is lower than the value of FB-12, the AC drive reduces the running frequency based on the power dip ride-through frequency decline rate set in FB-10. When the bus voltage rises to the value of FB-12 and remains such state for the time set in FB-11, the AC drive restores to the set frequency.

If the bus voltage does not rise to the value of FB-12, the AC drive keeps reducing the running frequency to 0 and then stops.

If FB-10 is set to a small value, the load feedback energy is small and the low-voltage compensation is not effective. If FB-10 is set to a very large value, the load feedback energy is large, which may cause overvoltage protection. Set this parameter properly based on the inertia and load.

Figure 6-26 Power dip ride-through running

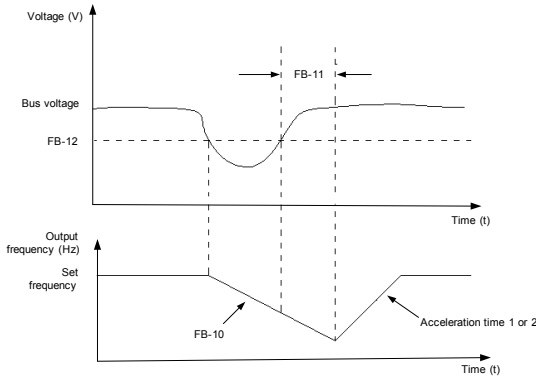

Function Code	Parameter Name	Setting Range	Default
FB-13	Fault auto reset times	0–10	0

It is used to set the times of fault auto resets if this function is used. After the value is exceeded, the AC drive will remain in the fault state.

- The fault auto reset does not take effect for the external faults and the fault of running time reached.
- If manual reset is performed, the fault auto reset time is cleared to 0.
- The auto reset times of undervoltage faults are not counted in this parameter.

Function Code	Parameter Name	Setting Range	Default
FB-14	DO action during fault auto reset	0: No 1: Yes	0

It is used to decide whether the DO acts during the fault auto reset if the fault auto reset function is selected.

Function Code	Parameter Name	Setting Range	Default
FB-15	Time interval of fault auto reset	0.1–60.0s	1.0s

It is used to set the waiting time from the alarm of the AC drive to fault auto reset.

Function Code	Parameter Name	Setting Range	Default
FB-16	Clear time of fault auto reset times	0.1–1000.0 h	1.0 h

When the running time of the AC drive reaches the value of this parameter, the existing fault auto reset times is cleared to 0.

Function Code	Parameter Name	Setting Range	Default
FB-17	Input phase loss protection	0: Disabled 1: Enabled	1

Only the MD280 of above 18.6 kW provides the input phase loss function.

Function Code	Parameter Name	Setting Range	Default
FB-18	Output phase loss protection	0: Disabled 1: Enabled	1

It is used to determine whether to perform output phase loss protection.

Function Code	Parameter Name	Setting Range	Default
FB-19	Heatsink temperature of inverter module	-10 to 100.0°C	-

It is used to display the insulated gate bipolar transistor (IGBT) temperature of the inverter module.

Function Code	Name	Setting Range
FB-20	1st fault type	0–41
FB-21	2nd fault type	
FB-22	3rd (latest) fault type	

These parameters are used to record the types of the most recent three faults of the AC drive. The value 0 indicates no fault. For possible causes and solution of each fault, refer to Chapter 8.

Function Code	Parameter Name	Description
FB-23	Frequency upon 3rd fault	It displays the frequency when the latest fault occurs.
FB-24	Current upon 3rd fault	It displays the current when the latest fault occurs.
FB-25	Bus voltage upon 3rd fault	It displays the bus voltage when the latest fault occurs.

Function Code	Parameter Name	Description
FB-26	DI status upon 3rd fault	It displays the state of all DI terminals when the latest fault occurs. If a DI is ON, the corresponding bit is set to 1. If the DI is OFF, the corresponding bit is set to 0. The value is the equivalent decimal number converted from the binary value.
FB-27	DO status upon 3rd fault	It displays the status of all output terminals when the latest fault occurs. If a DI is ON, the corresponding bit is set to 1. If the DI is OFF, the corresponding bit is set to 0. The value is the equivalent decimal number converted from the binary value.

Function Code	Parameter Name	Setting Range	Default
FB-28	Undervoltage threshold	60.0%–140.0%	100.0%

It is used to set the undervoltage threshold.

For the three-phase AC drive, 100.0% corresponds to 350.0 V, which means that when the bus voltage is lower than 350.0 V, the AC drive enters the undervoltage state.

For the two-phase AC drive, 100.0% corresponds to 200.0 V, which means that when the bus voltage is lower than 200.0 V, the AC drive enters the undervoltage state.

Function Code	Parameter Name	Setting Range	Default
FB-29	Zero current detection level	0.0%–300.0% (100.0% corresponds to the rated motor current)	5.0%
FB-30	Zero current detection delay	0.00–600.00s	0.10s

If the output current of the AC drive is equal to or less than the value of FB-29 and the duration exceeds the time set in FB-30, the corresponding DO becomes ON.

Group FC: Motor 2 Parameters

Function Code	Parameter Name	Setting Range	Default
FC-00	Rated motor power	0.2–1000.0 kW	Model dependent
FC-01	Rated motor voltage	0–480 V	Model dependent
FC-02	Rated motor current	0.1–6553.5 A	Model dependent
FC-03	Rated motor frequency	0.01 Hz to maximum frequency (F0-04)	Model dependent
FC-04	No-load current	0.1–6500.0 A	Model dependent
FC-05	Stator resistance	0.001–65.535 Ω	Model dependent

For descriptions of these motor 2 parameters, see F1-00 to F1-03, F1-15, and F1-16.

Motor parameter groups can be switched by the DI with function 32.

The V/F curve of motor 2 is a straight line by default.

Function Code	Parameter Name	Setting Range	Default
FC-06	Torque boost	0.0%–30.0% 0.0%: Fixed	1.0%

See the description of F1-05.

Function Code	Parameter Name	Setting Range	Default
FC-07	Slip compensation coefficient	0%–200.0%	0.0%

See the description of F1-13.

Function Code	Parameter Name	Setting Range	Default
FC-08	Oscillation suppression gain	0–100	Model dependent

See the description of F1-17.

Function Code	Parameter Name	Setting Range	Default
FC-09	Motor 2 acceleration/ deceleration time	0: Same as motor 1 1: Acceleration/Deceleration time 1 (F0-09 and F0-10) 2: Acceleration/Deceleration time 2 (F5-04 and F5-05)	0

Group FD: AI Correction

Function Code	Parameter Name	Setting Range	Default
FD-00	AI1 measured voltage 1	0.50–4.00 V	Factory-corrected
FD-01	AI1 sampled voltage 1	0.50–4.00 V	Factory-corrected
FD-02	AI1 measured voltage 2	6.00–9.99 V	Factory-corrected
FD-03	AI1 sampled voltage 2	6.00–9.99 V	Factory-corrected
FD-04	AI2 measured voltage 1	0.50–4.00 V	Factory-corrected
FD-05	AI2 sampled voltage 1	0.50–4.00 V	Factory-corrected
FD-06	AI2 measured voltage 2	6.00–9.99 V	Factory-corrected
FD-07	AI2 sampled voltage 2	6.00–9.99 V	Factory-corrected

These parameters are used to correct the AI to eliminate the impact of AI zero offset and gain.

The on-site correction is as follows:

1. Modify these parameters to the default setting manually or directly restore all default settings by setting FP-01.
2. Send a voltage signal (approximately 2 V) to AI1. Measure the AI1 voltage and view the displayed sampled value.
3. Send a voltage signal (approximately 8 V) to AI1. Measure AI1 voltage and view the displayed sampled value.

4. Enter the obtained values in FD-00 to FD-03.

Then, the correction is completed, and you can check whether the actually input voltage is the same as the value displayed by the AC drive.

The method of correcting AI2 is the same.

Group FF: Factory Parameters (Reserved)

Group FP: User Password

Function Code	Parameter Name	Setting Range	Default
FP-00	User password	0–65535	0

If it is set to any non-zero number, the password protection function is enabled. After a password has been set and taken effect, you must enter the correct password in order to enter the menu. If the entered password is incorrect you cannot view or modify parameters.

If FP-00 is set to 00000, the previously set user password is cleared, and the password protection function is disabled.

Function Code	Parameter Name	Setting Range	Default
FP-01	Restore default settings	0: No operation 1: Restore factory settings 2: Clear records 4: Clear power-on time	0

- 1: Restore default settings

If FP-01 is set to 1, most function codes are restored to the default settings except motor parameters (F1-00 to F1-03, F1-15 and F1-16), accumulative running time (F7-12), heatsink temperature of inverter module (FB-19), fault parameters (FB-20 to FB-27), and user password (FP-00).

- 2: Clear records

If FP-01 is set to 2, the fault records (FB-20 to FB-27) and accumulative running time (F7-12) are cleared.

- 3: Clear power-on time

The records of F5-43 and F5-44 are cleared.

Function Code	Parameter Name	Setting Range	Default
FP-02	Power-on time correction coefficient	0.6–1.50	1.00

Displayed time (F5-43, F5-44) = Actual time x FP-02



EMC

Chapter 7 EMC

7.1 Definition

Electromagnetic compatibility (EMC) is the ability of the electric equipment to run in the electromagnetic interference environment and implement its functions stably without interfering with the electromagnetic environment.

7.2 Introduction to EMC Standard

In accordance with the requirements of China's national standard GB/T12668.3, the AC drive must comply with the electromagnetic interference and anti-electromagnetic interference requirements.

The CS500 applies the latest international standard IEC/EN 61800-3: 2004 (Adjustable speed electrical power drive systems part 3: EMC requirements and specific test methods), which is equivalent to China's national standard GB/T12668.3.

IEC/EN61800-3 assesses the AC drive in terms of electromagnetic interference and anti-electronic interference. Electromagnetic interference mainly tests the radiation interference, conduction interference and harmonics interference on the AC drive (required if the AC drive is applied for civil use). Anti-electromagnetic interference mainly tests the conduction interference rejection, radiation interference rejection, surge interference rejection, fast and mutable pulse group interference rejection, electronic static discharge (ESD) interference rejection and power low-frequency end interference rejection. The specific test items involve:

1. Interference rejection tests of input voltage sag, interrupt and change
2. Commutation notch interference rejection test
3. Harmonic input interference rejection test
4. Input frequency change test
5. Input voltage unbalance test
6. Input voltage fluctuation test

Being tested strictly in accordance with the above requirements of IEC/EN61800-3 and used according to section 7.3, the CS500 has good EMC capability in general industry environment.

7.3 EMC Guideline

7.3.1 Harmonic Effect

Higher harmonics of power supply may damage the AC drive. Thus, at some places where mains quality is rather poor, it is recommended to install an AC input reactor.

7.3.2 Electromagnetic Interference and Installation Precautions

■ Electromagnetic Interference

There are two types of electromagnetic interference, interference of electromagnetic noise

in the surrounding environment on the AC drive, and interference of the AC drive on the surrounding equipment.

■ Installation Precautions

1. The grounding cables of the AC drive and other electric products must be well grounded.
2. The power input and output power cables of the AC drive and weak current signal cables (for example, control line) must not be arranged in parallel and vertical arrangement is preferable.
3. It is recommended that the output power cables of the AC drive use shielded cables or the power cables be shielded by steel pipes and that the shielding layer be grounded reliably. It is also recommended that the lead cables of the equipment suffering interference use twisted-pair shielded control cables, and the shielding layer be grounded reliably.
4. When the length of motor cable is longer than 100 m, an output filter or a reactor needs to be installed.

7.3.3 How to Handle Interference of Surrounding Equipment on the AC drive

The electromagnetic interference on the AC drive is generated because plenty of relays, contactors and electromagnetic brakes are installed near the AC drive. When the AC drive has error action due to the interference, the following measures can be taken:

1. Install a surge suppressor on the devices generating interference.
2. Install a filter at the input side of the AC drive. For the specific operations, see Section 7.3.6.
3. Use shielded cables as the control signal cable of the AC drive and lead cables of the detection line and ensure that the shielding layer is grounded reliably.

7.3.4 How to Handle Interference of the AC Drive on Surrounding Equipment

The interference includes two types, radiation interference and conduction interference. The two types of interference cause the surrounding electric equipment to suffer electromagnetic or electrostatic induction, resulting in error actions of the surrounding equipment. Handle different interference according to the following methods:

1. Signals of the measuring meters, receivers and sensors are generally weak. If placed nearby the AC drive or together with the AC drive in the same control cabinet, these instruments are easy to suffer interference and perform error actions. Handle such situation as follows:
 - Put these instruments in places far away from the interference source.
 - Do not arrange the signal cables with the power cables in parallel and never bind them together.
 - Use shielded cables as the signal cables and power cables and ground the shielding layer well.
 - Install a ferrite magnetic ring (with suppressing frequency of 30 to 1,000 MHz) at the output side of the AC drive and wind it 2 to 3 coils.

- Install an EMC output filter in more severe conditions.
2. When the equipment suffering interference and the AC drive use the same power supply, it may cause conduction interference. If the above handling cannot eliminate the interference, install an EMC filter between the AC drive and the power supply (for the model selection operation, see Section 7.3.6).
 3. Grounding the surrounding equipment separately can avoid the interference caused by the leakage current of the AC drive's grounding cable when common grounding mode is adopted.

7.3.5 Leakage Current and Handling

There are two forms of leakage current when the AC drive is used. One is leakage current to ground, and the other is leakage current between cables.

■ Factors Influencing the Leakage Current to Ground and Solutions

- There are distributed capacitance between lead cables and the ground. The larger the distributed capacitance is, the larger the leakage current is. The distributed capacitance can be reduced by effectively shortening the distance between the AC drive and the motor.
- The higher the carrier frequency is, the larger the leakage current will be. The leakage current can be reduced by reducing the carrier frequency.
- However, reducing the carrier frequency may result in increase of motor noise.
- To install a reactor is also an effective method to remove the leakage current.
- The leakage current may increase following increase of the circuit current. Therefore, when the motor power is high, the corresponding leakage current is large.

■ Factors of producing Leakage Current Between Cables and Solutions

There is distributed capacitance between the output cables of the AC drive. If the current passing the cables contains higher harmonic, it may cause resonance and thus result in leakage current. If a thermal relay is used in this case, error actions may result.

The solution is to reduce the carrier frequency or install an output reactor. It is recommended that a thermal relay not be installed before the motor when using the AC drive, and that electronic overcurrent protection function of the AC drive be used instead.

7.3.6 Precautions for Installing the EMC Input Filter at Input Side of Power Supply

1. Use the filter with the rated values strictly. The filter belongs to Classification I electric appliances, and the metal enclosure ground of the filter must be reliably connected to the metal ground of the installing cabinet and have good conduction continuity. Otherwise electric shock may result and the EMC effect may be greatly affected.
2. The EMC test shows that the filter and the PE end of the AC drive must be tied to the same common ground. Otherwise, the EMC effect may be greatly affected.

The filter must be installed at a place close to the power input side of the AC drive as much as possible.



Troubleshooting

Chapter 8 Troubleshooting

8.1 Faults and Solutions

The MD280 provides fault information and protective functions. After a fault occurs, the AC drive implements the protection function, and displays the fault code on the operation panel (if the operation panel is available).

Before contacting Inovance for technical support, you can first determine the fault type, analyze the causes, and perform troubleshooting according to the following tables. If the fault cannot be rectified, contact the agent or Inovance.

Table 8-1 Solutions to the faults of the MD280

Fault Name	Display	Possible Causes	Solutions
Overcurrent during acceleration	Err02	<ol style="list-style-type: none"> 1. The output circuit is grounded or short circuited. 2. The acceleration time is too short. 3. Manual torque boost or V/F curve is not appropriate. 4. The voltage is too low. 5. The startup operation is performed on the rotating motor. 6. A sudden load is added during acceleration. 7. The AC drive model is of too small power class. 	<ol style="list-style-type: none"> 1. Eliminate external faults. 2. Increase the acceleration time. 3. Adjust the manual torque boost or V/F curve. 4. Adjust the voltage to normal range. 5. Select rotational speed tracking restart or start the motor after it stops. 6. Remove the added load. 7. Select an AC drive of higher power class.
Overcurrent during deceleration	Err03	<ol style="list-style-type: none"> 1. The output circuit is grounded or short circuited. 2. The deceleration time is too short. 3. The voltage is too low. 4. A sudden load is added during deceleration. 5. The braking unit and braking resistor are not installed. 	<ol style="list-style-type: none"> 1. Eliminate external faults. 2. Increase the deceleration time. 3. Adjust the voltage to normal range. 4. Remove the added load. 5. Install the braking unit and braking resistor.
Overcurrent at constant speed	Err04	<ol style="list-style-type: none"> 1. The output circuit is grounded or short circuited. 2. A sudden load is added during operation. 3. The AC drive model is of too small power class. 	<ol style="list-style-type: none"> 1. Eliminate external faults. 2. Remove the added load. 3. Select an AC drive of higher power class.

Overvoltage during acceleration	Err05	<ol style="list-style-type: none"> 1. The input voltage is too high. 2. An external force drives the motor during acceleration. 3. The acceleration time is too short. 4. The braking unit and braking resistor are not installed. 	<ol style="list-style-type: none"> 1. Adjust the voltage to normal range. 2. Cancel the external force or install a braking resistor. 3. Increase the acceleration time. 4. Install the braking unit and braking resistor.
Overvoltage during deceleration	Err06	<ol style="list-style-type: none"> 1. The input voltage is too high. 2. An external force drives the motor during deceleration. 3. The deceleration time is too short. 4. The braking unit and braking resistor are not installed. 	<ol style="list-style-type: none"> 1. Adjust the voltage to normal range. 2. Cancel the external force or install the braking resistor. 3. Increase the deceleration time. 4. Install the braking unit and braking resistor.
Overvoltage at constant speed	Err07	<ol style="list-style-type: none"> 1. The input voltage is too high. 2. An external force drives the motor during deceleration. 	<ol style="list-style-type: none"> 1. Adjust the voltage to normal range. 2. Cancel the external force or install the braking resistor.
Control power supply fault	Err08	<ol style="list-style-type: none"> 1. The input voltage is not within the allowable range. 2. The input voltage is not stable, causing the bus voltage to jump frequently around the undervoltage threshold. 	<ol style="list-style-type: none"> 1. Adjust the input voltage to the allowable range. 2. Wait at least five minutes after power failure until the input voltage becomes normal, and then power on the AC drive again.
Undervoltage	Err09	<ol style="list-style-type: none"> 1. Instantaneous power failure occurs on the input power supply. 2. The AC drive's input voltage is not within the allowable range. 3. The bus voltage is abnormal. 4. The rectifier bridge and buffer resistor are faulty. 5. The drive board is faulty 6. The main control board is faulty. 	<ol style="list-style-type: none"> 1. Reset the fault. 2. Adjust the voltage to normal range. 3. Contact the agent or Inovance.
AC drive overload	Err10	<ol style="list-style-type: none"> 1. The load is too heavy or locked-rotor occurs on the motor. 2. The AC drive model is of too small power class. 	<ol style="list-style-type: none"> 1. Reduce the load and check the motor and mechanical conditions. 2. Select an AC drive of higher power class.

Motor overload	Err11	<ol style="list-style-type: none"> 1. FB-01 is set improperly. 2. The load is too heavy or locked-rotor occurs on the motor. 3. The AC drive model is of too small power class. 	<ol style="list-style-type: none"> 1. Set FB-01 correctly. 2. Reduce the load and check the motor and mechanical conditions. 3. Select an AC drive of larger power class.
Power input phase loss	Err12	<ol style="list-style-type: none"> 1. The three-phase power input is abnormal. 2. The drive board is faulty. 4. The main control board is faulty. 	<ol style="list-style-type: none"> 1. Eliminate external faults. 2. Contact the agent or Inovance.
Power output phase loss	Err13	<ol style="list-style-type: none"> 1. The cable connecting the AC drive and the motor is faulty. 2. The AC drive's three-phase outputs are unbalanced when the motor is running. 3. The drive board is faulty 4. The module is faulty. 	<ol style="list-style-type: none"> 1. Eliminate external faults. 2. Check whether the motor three-phase winding is normal. 3. Contact the agent or Inovance.
Module overheat	Err14	<ol style="list-style-type: none"> 1. The ambient temperature is too high. 2. The air filter is blocked. 3. The fan is damaged. 4. The thermally sensitive resistor of the module is damaged. 5. The inverter module is damaged. 	<ol style="list-style-type: none"> 1. Lower the ambient temperature. 2. Clean the air filter. 3. Replace the damaged fan. 4. Replace the damaged thermally sensitive resistor. 5. Replace the inverter module.
External equipment fault	Err15	<ol style="list-style-type: none"> 1. External fault signal is input via DI. 2. External fault signal is input via virtual I/O. 3. The stop operation is performed during stall. 	<ol style="list-style-type: none"> 1. Perform the reset operation. 2. Eliminate external faults.
Communication fault	Err16	<ol style="list-style-type: none"> 1. The host computer is in abnormal state. 2. The communication cable is faulty. 3. The communication parameters in group FA are set improperly. 	<ol style="list-style-type: none"> 1. Check the cabling of host computer. 2. Check the communication cabling. 3. Set the communication extension card type correctly. 4. Set the communication parameters properly.
Contactors fault	Err17	<ol style="list-style-type: none"> 1. The drive board and power supply are faulty. 2. The contactor is faulty. 	<ol style="list-style-type: none"> 1. Replace the faulty contactor. 2. Contact the agent or Inovance.

Current detection fault	Err18	1. The HALL device is faulty. 2. The drive board is faulty.	1. Replace the faulty HALL device. 2. Replace the faulty drive board.
Motor auto-tuning fault	Err19	1. The motor parameters are not set according to the nameplate. 2. The motor auto-tuning times out.	1. Set the motor parameters according to the nameplate properly. 2. Check the cable connecting the AC drive and the motor.
EEPROM read-write fault	Err21	1. The EEPROM chip is damaged.	Replace the main control board.
Short circuit to ground	Err23	The motor is short circuited to the ground.	Replace the cable or motor.
Accumulative running time reached	Err26	The accumulative running time reaches the setting value.	Clear the record through the parameter initialization function.
Software overcurrent	Err31	-	See the description of F5-25 (Software overcurrent).
Fast current limit timeout	Err40	1. The acceleration/deceleration time is too short. 2. Manual torque boost or V/F curve is not appropriate. 3. The startup operation is performed on the rotating motor. 6. The load is too heavy.	2. Increase the acceleration/deceleration time. 3. Adjust the manual torque boost or V/F curve. 4. Use rotational speed tracking startup or perform startup after the motor stops. 5. Use an AC drive of a higher power class.
Motor switchover fault during running	Err41	Motor switchover is performed via terminal during running of the AC drive.	Perform motor switchover after the AC drive stops.
Motor overheat	Err45	1. The cabling of the temperature sensor becomes loose. 2. The motor temperature is too high.	1. Check the temperature sensor cabling and eliminate the cabling fault. 2. Lower the carrier frequency or adopt other heat radiation measures.
Initial position fault	Err51	The motor parameters are not set based on the actual situation.	Check whether the motor parameters are set correctly and whether the setting of rated current is too small.

8.2 Common Faults and Solutions

If faults listed in the following table occur, you can perform initial fault analysis and troubleshooting according to the corresponding instruction.

Table 8-2 Solutions to common faults of the AC drive

SN	Fault	Possible Causes	Solutions
1	There is no display at power-on.	<ol style="list-style-type: none"> 1. There is no power supply to the AC drive or the power input to the AC drive is too low. 2. The cable connecting the control board and the drive board and the operation panel breaks. 3. Components inside the AC drive are damaged. 	<ol style="list-style-type: none"> 1. Check the power supply. 2. Re-connect the 8-core and 16-core cables. 3. Contact the agent or Inovance for technical support.
2	"Err23" is displayed at power-on.	<ol style="list-style-type: none"> 1. The motor or the motor output cable is short-circuited to the ground. 2. The AC drive is damaged. 	<ol style="list-style-type: none"> 1. Measure the insulation of the motor and the output cable with a megger. 2. Contact the agent or Inovance for technical support.
3	The AC drive display is normal upon power-on, but "HC" is displayed after running and the AC drive stops immediately.	The cooling fan is damaged or locked-rotor occurs.	Replace the damaged fan.
4	Err14 (module overheat) fault is reported frequently.	<ol style="list-style-type: none"> 1. The setting of carrier frequency is too high. 2. The cooling fan is damaged, or the air filter is blocked. 3. Components inside the AC drive are damaged (thermal coupler or others). 	<ol style="list-style-type: none"> 1. Reduce the carrier frequency (F0-15). 2. Replace the fan and clean the air filter. 3. Contact the agent or Inovance for technical support.
5	The motor does not rotate after the AC drive runs.	<ol style="list-style-type: none"> 1. The motor is damaged or locked-rotor occurs. 2. The motor parameters are set improperly. 	<ol style="list-style-type: none"> 1. Replace the motor or clear mechanical faults. <p>Check and re-set motor parameters.</p>

SN	Fault	Possible Causes	Solutions
6	The DI terminals are disabled.	<ol style="list-style-type: none">1. The parameters are set incorrectly.2. Cable connection is incorrect.4. The control board is faulty.	<ol style="list-style-type: none">1. Check and set related parameters correctly.2. Re-connect the external signal cables.3. Contact the agent or Inovance for technical support.
7	The AC drive reports overcurrent and overvoltage frequently.	<ol style="list-style-type: none">1. The motor parameters are set improperly.2. The acceleration/deceleration time is improper.3. The load fluctuates.	<ol style="list-style-type: none">1. Set the motor parameters in group F1 again.2. Set proper acceleration/ deceleration time.3. Contact the agent or Inovance for technical support.



Warranty Agreement

1. The warranty period of the product is 18 months (refer to the barcode on the equipment). During the warranty period, if the product fails or is damaged under the condition of normal use by following the instructions, Inovance will be responsible for free maintenance.
2. Within the warranty period, maintenance will be charged for the damages caused by the following reasons:
 - a. Improper use or repair/modification without prior permission
 - b. Fire, flood, abnormal voltage, other disasters and secondary disaster
 - c. Hardware damage caused by dropping or transportation after procurement
 - d. Improper operation
 - e. Trouble out of the equipment (for example, external device)
3. If there is any failure or damage to the product, please correctly fill out the Product Warranty Card in detail.
4. The maintenance fee is charged according to the latest Maintenance Price List of Inovance.
5. The Product Warranty Card is not re-issued. Please keep the card and present it to the maintenance personnel when asking for maintenance.
6. If there is any problem during the service, contact Inovance's agent or Inovance directly.
7. This agreement shall be interpreted by Shenzhen Inovance Technology Co., Ltd.

Service Department, Shenzhen Inovance Technology Co., Ltd.

Address: Block E, Hongwei Industry Park, Liuxian Road, Baocheng No. 70 Zone, Bao'an District, Shenzhen P.C.: 518101

Website: www.inovance.cn



Product Warranty Card

Customer information	Add. of unit:	
	Name of unit: P.C.:	Contact person:
		Tel.:
Product information	Product model:	
	Body barcode (Attach here):	
	Name of agent:	
Failure information	(Maintenance time and content):	
	Maintenance personnel:	



MD280 Series

General-purpose AC Drive

Shenzhen Inovance Technology Co.,LTD.

Address: Building E, Hongwei Industrial Park, Liuxian 2nd Road, Baocheng
70th Zone, Bao'an District, Shenzhen 518101, P.R. China

Tel: +86-755-2979 9595

Fax: +86-755-2961 9897

Technical support: 400-777-1260

<http://www.inovance.cn>