

# Automation PC 620

## User's Manual

Version: **2.68 (May 2015)**

Model number: **MAAPC620-ENG**

All information contained in this manual is current as of its creation/publication. We reserve the right to change the contents of this manual without warning. The information contained herein is believed to be accurate as of the date of publication; however, Bernecker + Rainer Industrie-Elektronik Ges.m.b.H. makes no warranty, expressed or implied, with regards to the products or the documentation contained within this book. In addition, Bernecker + Rainer Industrie-Elektronik Ges.m.b.H. shall not be liable in the event of incidental or consequential damages in connection with or resulting from the furnishing, performance, or use of these products. The software names, hardware names, and trademarks used in this manual are registered by the respective companies.





**Chapter 1: General information**

**Chapter 2: Technical Data**

**Chapter 3: Commissioning**

**Chapter 4: Software**

**Chapter 5: Standards and certifications**

**Chapter 6: Accessories**



**Chapter 7: Maintenance / Servicing**

**Appendix A**

**Figure index**

**Table index**

**Model number index**

**Index**



<b>Chapter 1: General information .....</b>	<b>23</b>
1. Manual history .....	23
2. Safety notices .....	32
2.1 Intended use .....	32
2.2 Protection against electrostatic discharges .....	32
2.2.1 Packaging .....	32
2.2.2 Guidelines for proper ESD handling .....	32
2.3 Policy and procedures .....	33
2.4 Transport and storage .....	33
2.5 Installation .....	34
2.6 Operation .....	34
2.6.1 Protection against touching electrical parts .....	34
2.6.2 Environmental conditions - dust, humidity, aggressive gases .....	34
2.6.3 Programs, viruses, and dangerous programs .....	35
2.7 Environmentally-friendly disposal .....	35
2.7.1 Separation of materials .....	35
3. Organization of safety notices .....	36
4. Directives .....	36
5. Model numbers .....	37
5.1 System units .....	37
5.2 CPU boards 815E (ETX) .....	38
5.3 CPU boards 855GME (ETX) .....	38
5.4 CPU boards 855GME (XTX) .....	39
5.5 Heat sink .....	39
5.6 Main memory .....	40
5.7 Drives .....	40
5.8 Interface options .....	42
5.9 Fan kits .....	42
5.10 AP Link cards .....	42
5.11 Accessories .....	42
5.11.1 Supply voltage connectors .....	42
5.11.2 X2X and CAN plugs .....	43
5.11.3 Batteries .....	43
5.11.4 CompactFlash cards .....	43
5.11.5 USB flash drives .....	45
5.11.6 Cables .....	45
5.11.7 UPS module + accessories .....	47
5.11.8 PCI Ethernet cards .....	47
5.11.9 Miscellaneous .....	47
5.12 Software .....	48
6. Typical topologies .....	51
6.1 APC620 embedded for central control and visualization .....	51
6.2 APC620 as visualization device .....	52
<b>Chapter 2: Technical Data .....</b>	<b>53</b>
1. Introduction .....	53

## Table of contents

1.1 Features .....	54
1.2 Structure / configuration APC620 with 1, 2, 3 and 5 PCI slots .....	55
1.2.1 Selection guide - basic system .....	56
1.2.2 Selection guide - Optional components .....	57
1.3 Structure / configuration APC620 embedded .....	59
2. Entire device .....	60
2.1 APC620, 1 PCI slot variant .....	60
2.1.1 Interfaces .....	60
2.1.2 Technical data .....	62
2.1.3 Dimensions .....	65
2.2 APC620, 2 PCI slot variant .....	66
2.2.1 Interfaces .....	66
2.2.2 Technical data .....	68
2.2.3 Dimensions .....	71
2.3 APC620, 3 PCI slot variant .....	72
2.3.1 Interfaces .....	72
2.3.2 Technical data .....	74
2.3.3 Dimensions .....	76
2.4 APC620, 5 PCI slot variant .....	77
2.4.1 Interfaces .....	77
2.4.2 Technical data .....	79
2.4.3 Dimensions .....	82
2.5 APC620 embedded variant .....	83
2.5.1 Interfaces .....	83
2.5.2 Technical data .....	85
2.5.3 Dimensions .....	88
2.6 Ambient temperatures for systems with an 815E CPU board (ETX) .....	89
2.6.1 Maximum ambient temperature .....	90
2.6.2 Minimum ambient temperature .....	91
2.6.3 How do you determine the maximum ambient temperature? .....	91
2.6.4 Temperature monitoring .....	92
2.7 Ambient temperatures for systems with an 855GME CPU board (ETX / XTX) .....	93
2.7.1 Maximum ambient temperature .....	94
2.7.2 Minimum ambient temperature .....	95
2.7.3 How do you determine the maximum ambient temperature? .....	95
2.7.4 Temperature monitoring .....	96
2.8 Power management APC620 system unit with 1 PCI slot .....	97
2.8.1 Supply voltage for the 5PC600.SX01-00 revision $\geq$ I0 .....	97
2.8.2 Power calculation with 5PC600.SX01-00 revision $\geq$ I0 .....	98
2.8.3 Supply voltage for the 5PC600.SX01-00 revision $<$ I0 .....	99
2.8.4 Power calculation with 5PC600.SX01-00 revision $<$ I0 .....	100
2.9 Power management APC620 system units with 2 PCI slots .....	101
2.9.1 Supply voltage for the 5PC600.SX02-00 revision $\geq$ H0 and 5PC600.SX02-01 revision $\geq$ K0) .....	101
2.9.2 Power calculation with 5PC600.SX02-00 revision $\geq$ H0 .....	102
2.9.3 Power calculation with 5PC600.SX02-01 revision $\geq$ K0 .....	103
2.9.4 Supply voltage for the 5PC600.SX02-00 revision $<$ H0 and 5PC600.SX02-01 revision	



< K0) .....	104
2.9.5 Power calculation with 5PC600.SX02-00 revision < H0 .....	105
2.9.6 Power calculation with 5PC600.SX02-01 revision < K0 .....	106
2.10 Power management APC620 system unit with 3 PCI slots .....	107
2.10.1 5PC600.SF03-00 supply voltage .....	107
2.10.2 Power calculation with system unit 5PC600.SF03-00 .....	108
2.11 Power management APC620 system units with 5 PCI slots .....	109
2.11.1 Supply voltage for the 5PC600.SX05-00 (revision >= H0) and 5PC600.SX05-01 (revision >= H0) .....	109
2.11.2 Power calculation with system unit 5PC600.SX05-00 (revision >= H0) .....	111
2.11.3 Power calculation with system unit 5PC600.SX05-01 (revision >= H0) .....	112
2.11.4 Supply voltage for the 5PC600.SX05-00 (revision < H0) and 5PC600.SX05-01 (revision <= H0) .....	113
2.11.5 Power calculation with system unit 5PC600.SX05-05 revision < H0 .....	115
2.11.6 Power calculation with system unit 5PC600.SX05-01 revision < H0 .....	116
2.12 Power management for the APC620 embedded system unit .....	117
2.12.1 Supply voltage for the 5PC600.SE00-00, 5PC600.SE00-01 and 5PC600.SE00-02 . 117	
2.12.2 Power calculation with 5PC600.SE00-00, 5PC600.SE00-01 and 5PC600.SE00-02 118	
2.13 Humidity specifications .....	119
2.14 Device interfaces .....	121
2.14.1 Serial interface COM1 .....	123
2.14.2 Serial interface COM2 .....	124
2.14.3 X2X (only APC620 embedded) .....	125
2.14.4 CAN (only APC620 embedded) .....	125
2.14.5 CAN node number (only APC620 embedded) .....	126
2.14.6 CAN terminating switch / LED (only APC620 embedded) .....	126
2.14.7 Status LEDs CAN / X2X (only APC620 embedded) .....	127
2.14.8 POWERLINK (only APC620 embedded) .....	127
2.14.9 POWERLINK station number (only APC620 embedded) .....	129
2.14.10 Ethernet connection ETH (only APC620 embedded) .....	129
2.14.11 Ethernet connection ETH1 .....	130
2.14.12 Ethernet connection ETH2 .....	132
2.14.13 USB port .....	133
2.14.14 USB connection (only APC620 embedded) .....	134
2.14.15 +24 VDC supply voltage .....	135
2.14.16 Monitor / Panel connection .....	138
2.14.17 MIC, Line IN and Line OUT ports .....	144
2.14.18 Add-on interface slot .....	145
2.14.19 Add-on UPS module slot .....	146
2.14.20 AP Link Slot .....	147
2.14.21 PCI slots .....	147
2.14.22 Status LEDs .....	150
2.14.23 Status LEDs Power, CF, Link (only APC620 embedded) .....	151
2.14.24 CompactFlash slot (CF1) .....	152
2.14.25 Hard disk / CompactFlash slot (HDD/CF2) .....	153

## Table of contents

2.14.26 CompactFlash slots (only APC620 embedded) .....	155
2.14.27 Power button .....	156
2.14.28 Reset button .....	156
2.14.29 PS/2 keyboard/mouse .....	157
2.14.30 Battery .....	158
2.14.31 Hardware Security Key .....	160
2.14.32 Slide-in slot 1 drive slot .....	161
2.14.33 Slide-in slot 2 drive slot .....	162
2.15 Serial number sticker .....	163
2.16 Block diagram .....	165
2.16.1 Entire device with system unit 5PC600.SX01-00 .....	165
2.16.2 Entire device with system unit 5PC600.SX02-00 .....	166
2.16.3 Entire device with system unit 5PC600.SX02-01 .....	167
2.16.4 Entire device with system unit 5PC600.SF03-00 .....	168
2.16.5 Entire device with system unit 5PC600.SX05-00 .....	169
2.16.6 Entire device with system unit 5PC600.SX05-01 .....	170
2.16.7 Entire device with system unit 5PC600.SE00-00 .....	171
2.16.8 Entire device with system unit 5PC600.SE00-01 .....	172
2.16.9 Entire device with system unit 5PC600.SE00-02 .....	173
3. Individual components .....	174
3.1 System units .....	174
3.1.1 APC620 with 1, 2, 3 and 5 PCI slots .....	174
3.1.2 APC620 embedded variations .....	176
3.2 CPU boards 815E (ETX) .....	179
3.3 CPU boards 855GME (ETX) .....	181
3.4 CPU boards 855GME (XTX) .....	183
3.5 Heat sink .....	185
3.6 Main memory .....	186
3.7 Drives .....	187
3.7.1 Add-on Solid State Drive 128 GB 24x7 ET - 5AC600.SSDI-00 .....	187
3.7.2 Replacement Solid State Drive 128 GB 24x7 ET - 5MMSSD.0128-00 .....	191
3.7.3 Add-on hard disk 30 GB 24x7 - 5AC600.HDDI-00 .....	195
3.7.4 Add-on hard disk 20 GB ET - 5AC600.HDDI-01 .....	198
3.7.5 Add-on hard disk 40 GB 24x7 - 5AC600.HDDI-02 .....	201
3.7.6 Add-on hard disk 60 GB 24x7 - 5AC600.HDDI-03 .....	204
3.7.7 Add-on hard disk 80 GB 24x7 - 5AC600.HDDI-04 .....	207
3.7.8 Add-on hard disk 40 GB 24x7 ET - 5AC600.HDDI-05 .....	210
3.7.9 Add-on hard disk 80 GB 24x7 ET - 5AC600.HDDI-06 .....	213
3.7.10 Add-on CompactFlash slot - 5AC600.CFSI-00 .....	216
3.7.11 Slide-in CD-ROM - 5AC600.CDXS-00 .....	217
3.7.12 Slide-in DVD-ROM/CD-RW - 5AC600.DVDS-00 .....	220
3.7.13 Slide-in DVD-R/RW, DVD+R/RW - 5AC600.DVRS-00 .....	223
3.7.14 Slide-in CF 2 slot - 5AC600.CFSS-00 .....	228
3.7.15 Slide-in USB FDD - 5AC600.FDDS-00 .....	230
3.7.16 Slide-in hard disk 30 GB 24x7 - 5AC600.HDDS-00 .....	233
3.7.17 Slide-in hard disk 20 GB ET - 5AC600.HDDS-01 .....	236
3.7.18 Slide-in hard disk 40 GB ET - 5AC600.HDDS-02 .....	239

3.8 RAID system .....	242
3.8.1 PCI RAID Controller ATA/100 - 5ACPCI.RAIC-00 .....	243
3.8.2 PCI RAID storage 2 x 40 GB 24x7 - 5ACPCI.RAIS-00 .....	245
3.8.3 PCI RAID storage 2 x 60 GB 24x7 - 5ACPCI.RAIS-01 .....	248
3.8.4 PCI SATA RAID 2 x 60 GB 24x7 - 5ACPCI.RAIC-01 .....	251
3.8.5 Replacement SATA HDD 60 GB - 5ACPCI.RAIC-02 .....	256
3.8.6 PCI SATA RAID 2 x 160 GB 24x7 ET - 5ACPCI.RAIC-03 .....	259
3.8.7 Replacement SATA HDD 160 GB - 5ACPCI.RAIC-04 .....	264
3.8.8 PCI SATA RAID 2 x 250 GB - 5ACPCI.RAIC-05 .....	267
3.8.9 Replacement SATA HDD 250 GB - 5MMHDD.0250-00 .....	271
3.9 Interface options .....	274
3.9.1 Add-on CAN interface - 5AC600.CANI-00 .....	274
3.9.2 Add-on RS232/422/485 interface - 5AC600.485I-00 .....	278
3.10 Fan kits .....	282
3.10.1 Fan kit 1 PCI - 5PC600.FA01-00 .....	282
3.10.2 Fan kit 2 PCI - 5PC600.FA02-00 .....	283
3.10.3 Fan kit 3PCI - 5PC600.FA03-00 .....	285
3.10.4 Fan kit 5 PCI - 5PC600.FA05-00 .....	286
3.11 AP Link cards .....	288
3.11.1 AP Link SDL transmitter - 5AC600.SDL0-00 .....	288

## **Chapter 3: Commissioning ..... 293**

1. Installation .....	293
1.1 Important mounting information .....	293
1.2 Drilling templates .....	294
1.3 Mounting orientation .....	297
1.3.1 Standard mounting .....	297
1.3.2 Optional mounting orientations .....	299
2. Cable connections .....	306
2.1 Ethernet cable lengths for ETH1 .....	306
3. Grounding concept .....	307
4. Connection examples .....	308
4.1 Selecting the display units .....	309
4.2 One Automation Panel 900 via DVI (onboard) .....	310
4.2.1 Basic system requirements .....	310
4.2.2 Link modules .....	311
4.2.3 Cables .....	311
4.2.4 Possible Automation Panel units, resolutions und segment lengths .....	311
4.2.5 BIOS settings .....	312
4.2.6 Windows graphics driver settings .....	312
4.2.7 Windows touch screen driver settings .....	312
4.3 An Automation Panel 900 via SDL (onboard) .....	313
4.3.1 Basic system requirements .....	313
4.3.2 Link modules .....	314
4.3.3 Cables .....	314
4.3.4 BIOS settings .....	316

## Table of contents

4.3.5 Windows graphics driver settings .....	316
4.3.6 Windows touch screen driver settings .....	316
4.4 An Automation Panel 800 via SDL (onboard) .....	317
4.4.1 Basic system requirements .....	317
4.4.2 Cables .....	318
4.4.3 BIOS settings .....	319
4.4.4 Windows graphics driver settings .....	319
4.4.5 Windows touch screen driver settings .....	319
4.5 An AP900 and an AP800 via SDL (onboard) .....	320
4.5.1 Basic system requirements .....	320
4.5.2 Cables .....	321
4.5.3 BIOS settings .....	322
4.5.4 Windows graphics driver settings .....	322
4.5.5 Windows touch screen driver settings .....	322
4.6 Four Automation Panel 900 units via SDL (onboard) .....	323
4.6.1 Basic system requirements .....	323
4.6.2 Link modules .....	324
4.6.3 Cables .....	324
4.6.4 BIOS settings .....	327
4.6.5 Windows graphics driver settings .....	327
4.6.6 Windows touch screen driver settings .....	327
4.7 One Automation Panel 900 unit via SDL (AP Link) .....	328
4.7.1 Basic system requirements .....	328
4.7.2 Link modules .....	329
4.7.3 Cables .....	329
4.7.4 BIOS settings .....	331
4.7.5 Windows graphics driver settings .....	331
4.7.6 Windows touch screen driver settings .....	331
4.8 Four Automation Panel 900 units via SDL (AP Link) .....	332
4.8.1 Basic system requirements .....	332
4.8.2 Link modules .....	333
4.8.3 Cables .....	333
4.8.4 BIOS settings .....	336
4.8.5 Windows graphics driver settings .....	336
4.8.6 Windows touch screen driver settings .....	336
4.9 Two Automation Panel 900 units via SDL (onboard) and SDL (AP Link) .....	337
4.9.1 Basic system requirements .....	337
4.9.2 Link modules .....	338
4.9.3 Cables .....	338
4.9.4 BIOS settings .....	340
4.9.5 Windows graphics driver settings .....	340
4.9.6 Windows touch screen driver settings .....	340
4.10 Eight Automation Panel 900 units via SDL (onboard) and SDL (AP Link) .....	341
4.10.1 Basic system requirements .....	342
4.10.2 Link modules .....	342
4.10.3 Cables .....	343
4.10.4 BIOS settings .....	345

4.10.5 Windows graphics driver settings .....	345
4.10.6 Windows touch screen driver settings .....	345
4.11 Six AP900 and two AP800 devices via SDL (onboard) and SDL (AP Link) .....	346
4.11.1 Basic system requirements .....	347
4.11.2 Link modules .....	347
4.11.3 Cables .....	347
4.11.4 BIOS settings .....	349
4.11.5 Windows graphics driver settings .....	349
4.11.6 Windows touch screen driver settings .....	349
4.12 Internal numbering of extension units in AP800 devices .....	350
5. Configuration of a SATA RAID array .....	351
5.1 Create RAID set .....	352
5.1.1 Create RAID set - Striped .....	353
5.1.2 Create RAID set - Mirrored .....	354
5.2 Delete RAID set .....	355
5.3 Rebuild mirrored set .....	356
5.4 Resolve conflicts .....	357
5.5 Low level format .....	358
6. Connection of USB peripheral devices .....	359
6.1 Local on the APC620 .....	359
6.2 Remote connection to Automation Panel 900 via DVI .....	360
6.3 Remote connection to Automation Panel 800/900 via SDL .....	361
7. General instructions for performing temperature tests .....	362
7.1 Procedure .....	362
7.2 Evaluating the temperatures in Windows operating systems .....	362
7.2.1 Evaluation using B&R Control Center .....	362
7.2.2 Evaluation using the BurnIn tool from Passmark .....	364
7.3 Evaluating the temperatures in an operating system other than Windows .....	366
7.4 Evaluating the measurement results .....	366
7.4.1 Example using an APC810 2-slot .....	367
8. Compatibility / improvement from 855GME (XTX) to 855GME (ETX) .....	368
9. Known problems / issues .....	369

## **Chapter 4: Software ..... 371**

1. BIOS options .....	371
1.1 815E (ETX) BIOS description .....	371
1.1.1 General information .....	371
1.1.2 BIOS setup and boot procedure .....	371
1.1.3 BIOS setup keys .....	373
1.1.4 Main .....	375
1.1.5 Advanced .....	384
1.1.6 Security .....	407
1.1.7 Power .....	409
1.1.8 Boot .....	414
1.1.9 Exit .....	415
1.1.10 Profile overview - BIOS default settings - 815E (ETX) .....	416

## Table of contents

1.2 855GME (ETX) BIOS description .....	425
1.2.1 General information .....	425
1.2.2 BIOS setup and boot procedure .....	425
1.2.3 BIOS setup keys .....	427
1.2.4 Main .....	428
1.2.5 Advanced .....	438
1.2.6 Security .....	463
1.2.7 Power .....	465
1.2.8 Boot .....	469
1.2.9 Exit .....	470
1.2.10 Profile overview - BIOS default settings - 855GME (ETX) .....	472
1.3 855GME (XTX) BIOS description .....	481
1.3.1 General information .....	481
1.3.2 BIOS setup and boot procedure .....	481
1.3.3 BIOS setup keys .....	482
1.3.4 Main .....	484
1.3.5 Advanced .....	485
1.3.6 Boot .....	518
1.3.7 Security .....	520
1.3.8 Power .....	523
1.3.9 Exit .....	525
1.3.10 Profile overview - BIOS default settings - 855GME (XTX) .....	527
1.4 BIOS Error signals (beep codes) .....	537
1.4.1 BIOS 815E (ETX) and 855GME (ETX) .....	537
1.4.2 BIOS 855GME (XTX) .....	537
1.5 Distribution of resources .....	539
1.5.1 RAM address assignment .....	539
1.5.2 DMA channel assignment .....	539
1.5.3 I/O address assignment .....	540
1.5.4 Interrupt assignments in PCI mode .....	541
1.5.5 Interrupt assignments in APIC mode .....	542
1.5.6 Inter-IC (I <sup>2</sup> C) bus .....	545
1.5.7 System Management (SM) bus .....	545
1.6 Location of the DIP switch in APC620 system units .....	546
2. Upgrade information .....	547
2.1 BIOS upgrade .....	547
2.1.1 What information do I need? .....	547
2.1.2 Upgrade BIOS for 815E (ETX) .....	551
2.1.3 Upgrade BIOS for 855GME (ETX) .....	552
2.1.4 Upgrade BIOS for 855GME (XTX) .....	553
2.1.5 Windows XP Embedded and BIOS upgrade .....	554
2.2 Upgrade the firmware .....	555
2.2.1 Procedure .....	555
2.3 Creating an MS-DOS boot diskette in Windows XP .....	558
2.4 Creating a bootable USB flash drive for B&R upgrade files .....	560
2.4.1 Requirements .....	560
2.4.2 Procedure .....	560

2.4.3	Where do I get MS-DOS? .....	561
2.5	Creating a bootable CompactFlash card for B&R upgrade files .....	562
2.5.1	Requirements .....	562
2.5.2	Procedure .....	562
2.5.3	Where do I get MS-DOS? .....	563
2.6	Upgrade problems .....	563
3.	Automation PC 620 with Automation Runtime .....	564
3.1	General information .....	564
3.2	Support for Automation PC 620 embedded .....	564
3.2.1	ARwin .....	564
3.2.2	ARemb .....	564
3.3	Selection of devices .....	564
3.4	Visual Components graphic engine support .....	565
4.	Automation PC 620 with MS-DOS .....	566
4.1	Known problems .....	566
5.	Automation PC 620 with Windows XP Professional .....	568
5.1	Installation .....	569
5.1.1	FAQ .....	569
5.2	Graphics drivers .....	570
5.2.1	Installing the graphics driver for 815E (ETX) CPU boards .....	570
5.2.2	Graphics driver installation - 855GME (ETX / XTX) CPU boards .....	572
5.2.3	Graphics settings for Extended Desktop .....	573
5.2.4	Graphics settings for Dual Display Clone .....	575
5.2.5	FAQ .....	576
5.3	Touch screen driver .....	578
5.3.1	Installation for Extended Desktop .....	578
5.3.2	Installation for Dual Display Clone .....	580
5.3.3	FAQ .....	582
5.4	Audio driver .....	582
5.4.1	Installation .....	582
5.5	Network driver .....	583
5.5.1	Installation ETH1 .....	583
5.5.2	Installation ETH2 .....	583
5.6	Automation PC 620 embedded .....	583
6.	Automation PC 620 with Windows XP embedded .....	584
6.1	General information .....	584
6.2	Features with FP2007 (Feature Pack 2007) .....	585
6.3	Installation .....	586
6.4	Graphics drivers .....	586
6.5	Touch screen driver .....	586
6.6	Audio driver .....	586
6.6.1	After a BIOS upgrade .....	586
6.7	Network driver .....	587
6.8	FAQ .....	587
6.8.1	Why does the B&R device restart when shutdown? .....	587
7.	Automation PC 620 with Windows Embedded Standard 2009 .....	588
7.1	General information .....	588

## Table of contents

7.2 Features with WES2009 (Windows Embedded Standard 2009) .....	589
7.3 Installation .....	590
7.4 Drivers .....	590
7.4.1 Touch screen driver .....	590
8. Automation PC 620 with Windows CE .....	591
8.1 General information .....	591
8.2 Windows CE 5.0 features .....	592
8.3 Windows CE 6.0 features .....	593
8.4 Differences between Windows CE 6.0 and Windows CE 5.0 .....	593
8.5 Requirements .....	594
8.6 Installation .....	594
8.6.1 B&R Embedded OS Installer .....	594
9. B&R Automation Device Interface (ADI) driver - Control Center .....	595
9.1 Features .....	596
9.2 Installation .....	597
9.3 SDL equalizer setting .....	598
9.4 UPS configuration .....	599
9.4.1 Installing the UPS service for the B&R APC add-on UPS .....	599
9.4.2 Displaying UPS status values .....	600
9.4.3 Changing UPS battery settings .....	601
9.4.4 Updating UPS battery settings .....	603
9.4.5 Saving UPS battery settings .....	604
9.4.6 Configuring UPS system settings .....	604
9.4.7 Changing additional UPS settings .....	606
9.4.8 Procedure following power failure .....	608
<b>Chapter 5: Standards and certifications .....</b>	<b>609</b>
1. Applicable European directives .....	609
2. Overview of standards .....	609
3. Emission requirements (emission) .....	611
3.1 Network-related emissions .....	612
3.2 Emissions, electromagnetic emissions .....	613
4. Requirements for immunity to disturbances (immunity) .....	614
4.1 Electrostatic discharge (ESD) .....	615
4.2 High-frequency electromagnetic fields (HF field) .....	615
4.3 High-speed transient electrical disturbances (burst) .....	616
4.4 Surges (surge) .....	616
4.5 Conducted disturbances .....	616
4.6 Magnetic fields with electrical frequencies .....	617
4.7 Voltage dips, fluctuations and short-term interruptions .....	618
4.8 Damped vibration .....	618
5. Mechanical conditions .....	619
5.1 Vibration operation .....	619
5.2 Vibration during transport (packaged) .....	620
5.3 Shock during operation .....	620
5.4 Shock during transport (packaged) .....	620



5.5 Toppling .....	620
5.6 Free fall (packaged) .....	621
6. Climate conditions .....	622
6.1 Worst case operation .....	622
6.2 Dry heat .....	622
6.3 Dry cold .....	622
6.4 Large temperature fluctuations .....	623
6.5 Temperature fluctuations in operation .....	623
6.6 Humid heat, cyclic .....	623
6.7 Humid heat, constant (storage) .....	623
7. Safety .....	624
7.1 Ground resistance .....	625
7.2 Insulation resistance .....	625
7.3 High voltage .....	626
7.4 Residual voltage .....	626
7.5 Leakage current .....	626
7.6 Overload .....	627
7.7 Defective component .....	627
7.8 Voltage range .....	627
8. Other tests .....	628
8.1 Protection type .....	628
8.2 Degree of pollution .....	628
9. SDL flex cable - test description .....	629
9.1 Torsion .....	629
9.1.1 Test structure .....	629
9.1.2 Test conditions .....	629
9.1.3 Individual tests .....	629
9.2 Cable drag chain .....	630
9.2.1 Test structure .....	630
9.2.2 Test conditions .....	630
9.2.3 Individual tests: .....	630
10. International certifications .....	631

## **Chapter 6: Accessories ..... 633**

1. Overview .....	633
2. Supply voltage connector (TB103 3-pin) .....	638
2.1 General information .....	638
2.2 Order data .....	638
2.3 Technical data .....	638
3. X2X and CAN plugs (4-pin) .....	640
3.1 General information .....	640
3.2 Order data .....	640
3.3 Technical data .....	640
4. Replacement CMOS batteries .....	641
4.1 Order data .....	641
4.2 Technical data .....	641

## Table of contents

5. Interface covers 5AC600.ICOV-00 .....	643
5.1 Order data .....	643
5.2 Contents of delivery .....	643
6. DVI - monitor adapter 5AC900.1000-00 .....	644
6.1 Order data .....	644
7. CompactFlash cards 5CFCRD.xxxx-06 .....	645
7.1 General information .....	645
7.2 Order data .....	645
7.3 Technical data .....	646
7.3.1 Temperature humidity diagram .....	648
7.4 Dimensions .....	648
7.5 Benchmark .....	649
8. CompactFlash cards 5CFCRD.xxxx-04 .....	650
8.1 General information .....	650
8.2 Order data .....	650
8.3 Technical data .....	651
8.3.1 Temperature humidity diagram .....	653
8.4 Dimensions .....	653
8.5 Benchmark .....	654
9. CompactFlash cards - 5CFCRD.xxxx-03 .....	655
9.1 General information .....	655
9.2 Order data .....	655
9.3 Technical data .....	656
9.3.1 Temperature humidity diagram .....	658
9.4 Dimensions .....	658
10. CompactFlash cards 5CFCRD.xxxx-02 .....	659
10.1 General information .....	659
10.2 Order data .....	659
10.3 Technical data .....	659
10.4 Dimensions .....	661
10.5 Calculating the lifespan .....	662
11. USB Media Drive 5MD900.USB2-00 .....	668
11.1 Features .....	668
11.2 Technical data .....	669
11.3 Dimensions .....	671
11.4 Dimensions with front cover .....	672
11.5 Contents of delivery .....	672
11.6 Interfaces .....	672
11.7 Installation .....	673
11.7.1 Mounting orientation .....	673
11.8 Front cover 5A5003.03 for the USB Media Drive .....	673
11.8.1 Technical data .....	673
11.8.2 Dimensions .....	674
11.8.3 Installation .....	674
12. USB Media Drive - 5MD900.USB2-01 .....	675
12.1 Features .....	675
12.2 Technical data .....	676

12.3 Dimensions .....	678
12.4 Dimensions with front cover .....	679
12.5 Contents of delivery .....	679
12.6 Interfaces .....	679
12.7 Installation .....	680
12.7.1 Mounting orientation .....	680
12.8 Front cover 5A5003.03 for the USB Media Drive .....	680
12.8.1 Technical data .....	680
12.8.2 Dimensions .....	681
12.8.3 Installation .....	681
13. USB flash drive .....	682
13.1 General information .....	682
13.2 Order data .....	682
13.3 Technical data - 5MMUSB.xxxx-00 .....	683
13.3.1 Temperature humidity diagram .....	684
13.4 Technical data - 5MMUSB.2048-01 .....	685
13.4.1 Temperature humidity diagram .....	686
14. HMI Drivers & Utilities DVD 5SWHMI.0000-00 .....	687
15. Cables .....	692
15.1 APC620 internal supply cable 5CAMSC.0001-00 .....	692
15.1.1 Order data .....	692
15.1.2 Technical data .....	692
15.2 DVI cable 5CADVI.0xxx-00 .....	693
15.2.1 Order data .....	693
15.2.2 Technical data .....	694
15.2.3 Flex radius specification .....	694
15.2.4 Cable specifications .....	695
15.3 SDL cable 5CASDL.0xxx-00 .....	696
15.3.1 Order data .....	696
15.3.2 Technical data .....	697
15.3.3 Flex radius specification .....	697
15.3.4 Cable specifications .....	698
15.4 SDL cable with 45° plug 5CASDL.0xxx-01 .....	699
15.4.1 Order data .....	699
15.4.2 Technical data .....	700
15.4.3 Flex radius specification .....	700
15.4.4 Cable specifications .....	701
15.5 SDL cable with extender 5CASDL.0x00-10 .....	702
15.5.1 Order data .....	702
15.5.2 Technical data .....	703
15.5.3 Flex radius specification .....	703
15.5.4 Cable connection .....	704
15.5.5 Cable specifications .....	705
15.6 SDL flex cable 5CASDL.0xxx-03 .....	706
15.6.1 Order data .....	706
15.6.2 Technical data .....	707
15.6.3 Flex radius specification .....	708

## Table of contents

15.6.4 Dimensions .....	708
15.6.5 Structure .....	709
15.6.6 Cable specifications .....	710
15.7 SDL flex cable with extender 5CASDL.0x00-13 .....	711
15.7.1 Order data .....	711
15.7.2 Technical data .....	712
15.7.3 Flex radius specification .....	713
15.7.4 Dimensions .....	713
15.7.5 Cable connection .....	714
15.7.6 Cable specifications .....	715
15.8 RS232 cable 9A0014-xx .....	716
15.8.1 Order data .....	716
15.8.2 Technical data .....	716
15.8.3 Cable specifications .....	717
15.9 USB cable 5CAUSB.00xx-00 .....	718
15.9.1 Order data .....	718
15.9.2 Technical data .....	718
15.9.3 Cable specifications .....	719
16. Uninterruptible power supply .....	720
16.1 Order data .....	721
16.2 Features .....	721
16.3 Requirements .....	721
16.4 Individual components .....	724
16.4.1 Add-on UPS module 5AC600.UPSI-00 .....	724
16.4.2 Battery unit 5AC600.UPSB-00 .....	726
16.4.3 UPS connection cable .....	730
17. External UPS .....	731
17.1 General information .....	731
17.2 Order data .....	732
18. PCI Ethernet cards .....	733
18.1 PCI Ethernet card 10/100 - 5ACPCI.ETH1-01 .....	733
18.1.1 Technical data .....	733
18.1.2 Driver support .....	734
18.1.3 Dimensions .....	734
18.2 PCI Ethernet card 10/100 - 5ACPCI.ETH3-01 .....	735
18.2.1 Technical data .....	735
18.2.2 Driver support .....	736
18.2.3 Dimensions .....	736
19. Replacement fan .....	737
20. SRAM module - 5AC600.SRAM-00 .....	738
20.1 Technical data .....	738
20.2 Driver support .....	739
20.3 Installation .....	740
21. Power supplies .....	741
21.1 Model numbers and brief technical overview .....	742
21.1.1 Single-phase power supplies .....	742
21.1.2 Three-phase power supplies .....	742

<b>Chapter 7: Maintenance / Servicing .....</b>	<b>743</b>
1. Changing the battery .....	743
1.1 Battery status evaluation .....	744
1.2 Procedure .....	744
2. Changing the CompactFlash .....	746
3. Fan kit installation and replacement .....	747
3.1 Procedure for APC620 with 1 PCI slot .....	747
3.2 Procedure for APC620 with 2 PCI slot .....	750
3.3 Procedure for APC620 with 3 PCI slot .....	753
3.4 Procedure for APC620 with 5 PCI slot .....	757
4. Slide-in drive - installation and exchange .....	762
4.1 Installation procedure .....	762
4.2 Exchange procedure .....	763
5. Installing the UPS module .....	765
5.1 Automation PC 620 without add-on interface module .....	765
5.1.1 APC620, 1 PCI slot .....	765
5.1.2 APC620, 2 PCI slot .....	768
5.1.3 APC620, 5 PCI slot .....	771
5.2 Automation PC 620 with add-on interface module .....	774
5.2.1 APC620, 1 PCI slot .....	774
5.2.2 APC620, 2 PCI slot .....	776
5.2.3 APC620, 5 PCI slot .....	778
6. Mounting the side cover .....	781
6.1 APC620 with 1 PCI slot .....	781
6.2 APC620 with 2 PCI slot .....	782
6.3 APC620 with 3 PCI slot .....	783
6.4 APC620 with 5 PCI slot .....	784
7. Exchanging a PCI SATA RAID hard disk .....	785
8. Replacing the front cover .....	787
8.1 Variation A - Front cover screwed-in .....	787
8.2 Variation B - Front cover attached without screws .....	789
<b>Appendix A .....</b>	<b>791</b>
1. Temperature sensor locations .....	791
2. Connection of an external device to the main board .....	792
3. Maintenance Controller Extended (MTCX) .....	793
3.1 SDL timing .....	794
3.2 Temperature monitoring - Fan control .....	796
4. B&R Key Editor information .....	797
5. B&R Automation Device Interface (ADI) development kit .....	799
6. B&R Automation Device Interface (ADI) .NET SDK .....	801
7. Glossary .....	803



# Chapter 1 • General information

## Information:

B&R does its best to keep the printed versions of its user's manuals as current as possible. However, any newer versions of the User's Manual can always be downloaded in electronic form (pdf) from the B&R homepage [www.br-automation.com](http://www.br-automation.com).

## 1. Manual history

Version	Date	Change
1.0 Preliminary	2004-07-21	- First version
1.1 Preliminary	2004-11-12	<ul style="list-style-type: none"> <li>- Drilling templates for the APC620 1 and 2 PCI slot variations added.</li> <li>- New overview images added for the APC620 1 and 2 PCI slot variations.</li> <li>- New dimension diagrams added for the APC620 1 and 2 PCI slot variations.</li> <li>- Model number overview revised.</li> <li>- Interface descriptions added (behind the front cover).</li> <li>- "Software" chapter has been updated.</li> <li>- "Accessories" chapter has been updated.</li> <li>- System unit with 5 PCI slots added.</li> <li>- Technical data for all individual components was expanded.</li> </ul>
1.2 Preliminary	2004-11-23	<ul style="list-style-type: none"> <li>- Pictures of the interfaces from the front have been updated.</li> <li>- General descriptions of device interfaces have been revised.</li> <li>- New CPU boards and system units added.</li> <li>- USB media device and fitting front cover added.</li> </ul>
1.3 Preliminary	2004-12-27	<ul style="list-style-type: none"> <li>- New column "My settings" (815E and 855GME BIOS) added to the BIOS profile settings table.</li> <li>- Chapter 7 "Maintenance / Servicing", on page 609 updated.</li> <li>- APC620 interface cover 5AC600.ICOV-00 updated (see section "Interface cover 5AC600.ICOV-00", on page 528).</li> <li>- Information for the maximum color depth for the CPU board added.</li> <li>- Error correction in the BIOS description for Legacy Devices Com D, COM E, LPT.</li> </ul>
1.4 Preliminary	2005-03-07	<ul style="list-style-type: none"> <li>- Cover for the slide-in USB disk drive updated (see figure 65 "Slide-in USB FDD - 5AC600.FDDS-00", on page 160).</li> <li>- Chapter 4 (Software) updated for new BIOS versions. (815E BIOS Version 1.15, 855GME BIOS Version V1.14).</li> <li>- Fan kit (5PC600.HS05-00) for APC620 system with 5 PCI slots (see section "Fan kit 5 PCI - 5PC600.FA05-00", on page 203) and installation (see section 2.4 "Procedure for APC620 with 5 PCI slot", on page 623) updated.</li> <li>- Mounting orientations more precisely specified, see the "Commissioning" chapter, section 1.3 "Mounting orientation", on page 214.</li> <li>- Temperature specifications for the 815E CPU boards added.</li> <li>- Temperature specifications for the 855GME CPU boards added.</li> </ul>

Table 1: Manual history

## General information • Manual history

Version	Date	Change
		<ul style="list-style-type: none"> <li>- Power management for the APC620 systems updated (see the section "Power management for APC620 systems 1 and 2 PCI slots", on page 76).</li> <li>- RAID System updated (see the section "RAID System", on page 172).</li> </ul>
1.5 Preliminary	2005-03-16	<ul style="list-style-type: none"> <li>- Temperature and performance table design changed.</li> <li>- Mounting orientation more precisely specified.</li> </ul>
1.6 Preliminary	2005-07-04	<ul style="list-style-type: none"> <li>- System unit weights added.</li> <li>- Add-on interface cards CAN (5AC600.CANI-00) and RS232/422/485 (5AC600.485I-00) added.</li> <li>- Model numbers for Microsoft Windows XP Embedded with SP2 added.</li> <li>- Cables (DVI, SDL, USB, RS232) added to accessories chapter.</li> <li>- AP Link cards added.</li> <li>- Slide-in CF 2-slot 5AC600.CFSS-00 added.</li> <li>- Configuration and selection guide for APC620 systems added (see chapter "Technical data", section 1.2 "Structure / configuration", on page 44).</li> <li>- Key Editor brief info section added (see Appendix A, "B&amp;R Key Editor Information" section on page 658).</li> <li>- Automation Device Interface (ADI), Control Center, and Development Kit: brief info section added (see "Software" chapter, from page 486).</li> <li>- Information added: battery compartment, real-time clock (RTC).</li> <li>- Temperature sensor locations for APC620 devices added (see Appendix A, "Temperature sensor positions" section, on page 653).</li> <li>- Ambient temperatures for PM 1600 (5PC600.E855-01) and PM 1800 (5PC600.E855-03) added.</li> <li>- "Appendix A" chapter updated.</li> <li>- Real-time clock (RTC) specifications about the system unit added.</li> <li>- Index modifications.</li> </ul>
1.70	2006-03-08	<ul style="list-style-type: none"> <li>- Conductor cross section and AWG change for the supply plug.</li> <li>- Meaning of standard and 24-hour hard disk operation specified more precisely.</li> <li>- Procedure for creating a bootable USB flash drive (see section "Creating a bootable USB flash drive", on page 568).</li> <li>- Slide-in DVD-R/RW, DVD+R/RW drive 5AC600.DVRS-00 updated (see section "Slide-in DVD-R/RW, DVD+R/RW - 5AC600.DVRS-00", on page 153).</li> <li>- Maintenance Controller Extended (MTCX) information added (see the section "Maintenance Controller Extended (MTCX)", on page 655).</li> <li>- Technical data about the SDL cable (flex radius, AWG) modified due to new specifications.</li> <li>- Information about general tolerances according to DIN ISO 2768 medium added to dimension diagrams.</li> <li>- BIOS distribution of resources added (see section "Resource distribution", on page 437).</li> <li>- Testing conditions added for the determined ambient temperature specifications.</li> <li>- Slide-in drive installation and exchange description updated (see the section "Slide-in drive installation and exchange", on page 628).</li> <li>- 5CAMSC.0001-00 cable for connecting external devices updated (see the section "APC620 internal supply cable 5CAMSC.0001-00", on page 574).</li> <li>- Information about connecting an external device updated (see the section "Connection of an external device to the main board", on page 654).</li> <li>- Filter clasp information added for the fan kits for 2 and 5 PCI system units.</li> <li>- Safety guidelines revised (EBG information).</li> <li>- Supply voltage fuse (type change to "non self healing").</li> <li>- Environmental temperature adjustments for systems with 815E and 855GME CPU boards (temperature limits for slide-in DVD-R/RW and 24-hour hard disk).</li> <li>- Firmware upgrade information updated (see the section "Firmware upgrade", on page 453).</li> <li>- Intel 815E CPU boards (5PC600.E815-0x) canceled.</li> <li>- BIOS function "Max CPU frequency" described.</li> <li>- Description of the SDL timing for communication between display unit and MTCX added (see the section "SDL timing", page 656).</li> <li>- APC620 with 5 PCI slots with orange front cover (previously light gray) - photos modified.</li> <li>- Information about changing the battery revised (see the section "Changing the battery", on page 609).</li> <li>- Pin assignments for the monitor / panel plug and the optional AP Link plug-in card added.</li> <li>- Important information added for installation of the touch screen driver (located under Software</li> </ul>

Table 1: Manual history (Forts.)



Version	Date	Change
		<ul style="list-style-type: none"> <li>- Touch screen driver installation).</li> <li>- 1 GB flash drive (5MMUSB.1024-00) added (128 MB - 5MMUSB.0128-00 cancelled).</li> <li>- Silicon Systems CompactFlash cards 5CFCRD.xxxx-03 updated (see the section "USB flash drive 5MMUSB.0xxx-00", on page 564).</li> <li>- Serial number sticker information updated (see the section "Serial number sticker", on page 119).</li> <li>- Additional technical data about the PCI bus added.</li> <li>- A general device interface photo (version with 5 PCI slots) added (see the section "Device interfaces", on page 90).</li> <li>- Information about the minimum ambient temperature added (component-dependent).</li> <li>- Block diagrams of entire device for all system units with 855GME CPU boards added.</li> <li>- SDL cable with 45° plug 5CASDL.0018-01, 5CASDL.0050-01, 5CASDL.0100-01, 5CASDL.0150-01 added (see the section "SDL cable with 45° plug 5CASDL.0xxx-01", on page 578).</li> <li>- SDL cable with extender 5CASD.0300-10 and 5CASDL.0400-10 added (see the section "SDL cable with extender 5CASDL.0x00-10", on page 581).</li> <li>- System unit support for buffering (10 ms) with Automation Runtime added (see the section "Automation PC 620 with Automation Runtime", on page 461).</li> <li>- Explanation of terminology added in the form of a glossary (see the "Glossary" section, on page 662).</li> <li>- "855GME (ETX) BIOS description" section on page 325 adapted to BIOS version 1.21.</li> <li>- "Firmware upgrade" section on page 453 adapted to the APC620 / Panel PC Firmware upgrade (MTCX, SDLR, SDLT) version 1.13.</li> <li>- Humidity table according to the individual components added (see the "Humidity specifications" section, on page 89).</li> <li>- Information about starting current added.</li> <li>- Section Automation PC 620 with Windows CE (9S0001.29-020) updated (see section "Automation PC 620 with Windows CE", on page 483).</li> <li>- New chapter "Standards and specifications", on page 497" updated.</li> <li>- Known problems using MS-DOS added (see the "Known problems" section, on page 462).</li> <li>- Automation Panel 900 connection examples expanded (see "Automation Panel 900 connection examples" on page 194).</li> <li>- Technical data table for all device versions (1, 2 and 5 PCI slots) added.</li> <li>- Progress information about the BIOS boot procedure added.</li> <li>- Topic "Power options and touch screen" added.</li> </ul>
1.80	2006-04-21	<ul style="list-style-type: none"> <li>- Corrections to chapter "Standards and Certifications".</li> <li>- The footnote "Depending on the process or batch, there may be visual deviations in the color and surface structure." was added for housing and color specifications.</li> <li>- PCI RAID hard disk 5ACPCI.RAIS-01 (60 GB) added.</li> <li>- Information regarding the new 512 MB and 1 GB SanDisk Cruzer Micro flash drives added.</li> <li>- Temperature specifications for the PCI RAID hard disk 5ACPCI.RAIS-00 added.</li> <li>- HMI Drivers &amp; Utilities DVD 5SWHMI.0000-00 added.</li> </ul>
1.90	2006-08-29	<ul style="list-style-type: none"> <li>- Corrections to chapter "Standards and Certifications" - section "Emission requirements" - standards were listed twice.</li> <li>- The manual history has been corrected.</li> <li>- Vibration values were switched for 'continuous' and 'occasional' operation.</li> <li>- "Cable connections" section on page 223 (flex radius) updated.</li> <li>- Name change for CompactFlash short text.</li> <li>- Name change of chapter "Installation" to "Commissioning".</li> <li>- Restructuring of section "Automation Panel 900 - connection examples" - it is now located in chapter "Commissioning".</li> <li>- BIOS postcode messages added.</li> <li>- USB Media Drive 5MD900.USB2-00 added.</li> <li>- New technical data added for slide-in drive 5AC600.DVRS-00 revision D0 and later.</li> <li>- New image for PCI routing.</li> <li>- List of delivery contents removed for some components (e.g. cable).</li> <li>- Vibration and shock values changed for the PCI RAID controller hard discs.</li> </ul>

Table 1: Manual history (Forts.)

## General information • Manual history

Version	Date	Change
2.00	2006-12-13	<ul style="list-style-type: none"> <li>- New configuration diagrams for Automation Panel 900 connection examples (USB information added).</li> <li>- Panel locking time information modified.</li> <li>- New model number for the APC620 documentation MAAPC620-ENG</li> <li>- Nominal current specification for 1, 2 and 5 PCI systems added.</li> <li>- Font symbol assigned to the character format symbol.</li> <li>- Description of the BIOS function "Legacy USB Support" updated.</li> <li>- Information about Ethernet cable length support for ETH1 added.</li> <li>- Name modifications               <ul style="list-style-type: none"> <li>SDLT FPGA: from "Firmware on the AP Link SDL transceiver" to "SDLT FPGA Firmware on the AP Link SDL transmitter".</li> <li>SDLR FPGA: from "Firmware on the AP Link SDL receiver" to "Firmware on the AP Link SDL receiver and transceiver"</li> </ul> </li> <li>- USB flash drive 2 GB SanDisk 5MMUSB.2048-00 added.</li> <li>- PCI SATA RAID controller 5ACPCI.RAIC-01 added (adjustment made to the ambient temperature determination with 855GME boards).</li> <li>- Add-on hard disk 40 GB ET, 24x7 - 5AC600.HDDI-05 added (adjustment made to the ambient temperature determination with 855GME boards).</li> <li>- Slide-in hard disk 40 GB ET, 24x7 - 5AC600.HDDS-02 added (adjustment made to the ambient temperature determination with 855GME boards).</li> </ul>
2.10	2007-01-23	<ul style="list-style-type: none"> <li>- New dimension diagram for the APC620 1 PCI variant with add-on UPS module (see the section 6 "APC620 1 PCI slot variant dimensions", on page 52) updated.</li> <li>- New dimension diagram for the APC620 2 PCI variant with add-on UPS module (see the section 9 "APC620 2 PCI slot variant dimensions", on page 57) updated.</li> <li>- New dimension diagram for the APC620 5 PCI variant with add-on UPS module (see the section 15 "APC620 5 PCI slot variant dimensions", on page 67) updated.</li> <li>- SDL cable flex 5CASDL.0xxx-03 added (see section "SDL cable flex 5CASDL.0xxx-03", on page 584).</li> <li>- SDL cable flex with extender 5CASDL.0xxx-13 added (see the section "SDL cable with extender 5CASDL.0x00-13", on page 588).</li> <li>- 8 GB CompactFlash card 5CFCRD.8192-03 added.</li> <li>- 5A5003.03 front cover description added to the 5MD900.USB2-00 and 5M900.USB2-01 product descriptions.</li> <li>- Document now includes the chm tag "Filename".</li> <li>- New Windows CE 5.0 model numbers added.</li> <li>- APC620 UPS model numbers added (UPS module, battery, cable).</li> <li>- APC620 overview images updated (with slot for UPS add-on module).</li> <li>- Descriptions of interfaces updated to include slot for add-on UPS module (see "Add-on UPS module slot", on page 106).</li> <li>- SATA RAID description updated (new image + new footnote for vibration and shock data (performance problems) + known limitations).</li> <li>- Figure "Selection guide - Optional components", on page 46 updated.</li> </ul>
2.10	2007-01-22	<ul style="list-style-type: none"> <li>- Graphics in the section "Power management for APC620 systems 1 and 2 PCI slots", on page 76 and "Power management for APC620 systems 5 PCI slots", on page 83 updated (add-on UPS module).</li> <li>- Status LED description on page 109 updated (battery operation).</li> <li>- Section "Firmware upgrade", on page 453 updated (new APC620 / Panel PC Firmware upgrade V1.16).</li> <li>- Section "B&amp;R Automation Device Interface (ADI) driver - Control Center" moved from "Appendix A" to chapter 4 "Software" (see page 486).</li> <li>- Configuration of UPS with B&amp;R Control Center added (see the "UPS configuration" section on page 488).</li> </ul>
2.20	2007-02-12	<ul style="list-style-type: none"> <li>- Figure "ADI Control Center UPS settings", on page 488 updated.</li> </ul>

Table 1: Manual history (Forts.)

Version	Date	Change
2.30	2007-09-10	<ul style="list-style-type: none"> <li>- USB Memory Sticks 256 MB (5MMUSB.0256-00) and 1 GB (5MMUSB.1024-00) cancelled.</li> <li>- UPS module + accessories short descriptions changed (page 47).</li> <li>Description of UPS configuration revised beginning on page 599.</li> <li>- Section "SDL flex cable - test description", on page 629 expanded (cable drag chain and torsion test).</li> <li>- Section "USB flash drive", on page 682 updated.</li> <li>- General information in section "Automation PC 620 with Automation Runtime", on page 564 updated.</li> <li>- Section "Automation Panel 900 connection examples" changed to "Connection examples" and expanded to include Automation Panel 800 connection examples</li> <li>- Section "Grounding concept", on page 307 added</li> <li>- Section "Configuration of a SATA RAID array", on page 351 added</li> <li>- Section "B&amp;R Automation Device Interface (ADI) driver - Control Center", on page 595 updated (screenshots, UL compliant operation)</li> <li>- Section "Uninterruptible power supply", on page 720 updated (description, technical data, temperature lifespan diagram up to 20% battery capacity, deep discharge cycles added).</li> <li>- New model numbers for Windows CE and Windows XPe expanded.</li> <li>- Section "Automation PC 620 with Windows XP embedded", on page 584 updated.</li> <li>. System unit 5PC600.SF03-00 expanded.</li> <li>- Fan kit 5PC600.FA03-00 expanded.</li> <li>- Replacement fan filters 5AC600.FA01-00, 5AC600.FA02-00, 5AC600.FA03-00, 5AC600.FA05-00 (see section "Replacement fan", on page 737) updated.</li> <li>- Maintenance interval information for the UPS battery (5AC600.UPSB-00) updated.</li> <li>- 855GME CPU board 5PC600.E855-05 (1 GHz Celeron) L2 cache entry changed from 1MB to 512 kB.</li> <li>- Standard Full-size PCI card size expanded (see section "PCI slots", on page 147).</li> <li>- The optional UPS module added to all block diagrams for the entire device (see Section "Block diagram", on page 165).</li> <li>- Drilling template for 5PC600.SF03-00 expanded (see section "Drilling templates", on page 294).</li> <li>- 815E CPU boards BIOS description updated to version 1.23 (see "Software" chapter, section "815E (ETX) BIOS description", on page 371).</li> <li>- 855GME CPU boards BIOS description updated to version 1.26 (see "Software" chapter, section "855GME (ETX) BIOS description", on page 425).</li> <li>- Name change from 815E to 815E (ETX) and 855GME to 855GME (ETX).</li> <li>- CPU boards 855GME (XTX) model numbers expanded (see Section "CPU boards 855GME (XTX)", on page 39).</li> <li>- Safety guidelines updated to include "Environmental conditions - dust, humidity, aggressive gases", on page 34.</li> <li>- 855GME (XTX) CPU boards (BIOS Version 1.14) BIOS description updated (see "Software" chapter, section 1.3 "855GME (XTX) BIOS description", on page 481).</li> <li>- Add-On UPS module pin assignments and UPS battery unit updated (see Section "Uninterruptible power supply", on page 720).</li> <li>- UPS battery unit deep discharge cycle diagram updated (see image 374 "Deep discharge cycles", on page 727).</li> <li>- SRAM module 5AC600.SRAM-00 added (see section "SRAM module - 5AC600.SRAM-00", on page 738).</li> <li>- Battery and real-time clock entries (RTC) revised.</li> <li>- Power consumption values adjusted in the revision of the system units.</li> <li>- Number added to information on interface numbering.</li> </ul>

Table 1: Manual history (Forts.)

## General information • Manual history

Version	Date	Change
2.40	2008-02-25	<ul style="list-style-type: none"> <li>- CAN interface description added.</li> <li>- Ethernet interface description added.</li> <li>- Description of the "Advanced USB Configuration USB" for 855GME (XTX) changed.</li> <li>- Replacement SATA RAID HDD 5PCPCI.RAIC-02 (see section "Replacement SATA HDD 60 GB - 5ACPCI.RAIC-02", on page 256) + instructions for exchanging added.</li> <li>- 855GME (XTX) BIOS description adjusted to the BIOS version 1.16.</li> <li>- Vibration and shock data for the complete devices revised.</li> <li>- Possible upgrade problems and version dependencies updated (see page 528).</li> <li>- DVI / SDL cable descriptions revised.</li> <li>- Color specifications of the orange front doors changed from Pantone 151CV to Pantone 144CV.</li> <li>- Additions to the address and data register for the CAN add-on interface (5AC600.CANI-00)</li> <li>- Section "Power management for APC620 system units" revised.</li> <li>- "SRAM module - 5AC600.SRAM-00", on page 738 description updated.</li> <li>- Information about voltage and temperature indicators in BIOS Setup and ADI Control Center pages added.</li> <li>- Text change from "Compact Flash" to "CompactFlash".</li> <li>- Automation PC 620 embedded devices 5PC600.SE00-00, 5PC600.SE00-01 and 5PC600.SE00-02 added</li> <li>- Section "Heat sink", on page 185 revised.</li> <li>- Block diagram with system unit 5PC600.SE00-00, 5PC600.SE00-01 and 5PC600.SE00-02 added.</li> <li>- Section "Compatibility / improvement from 855GME (XTX) to 855GME (ETX)", on page 368 added</li> <li>- Add-on hard disk 5AC600.HDDI-06 added (see section "Add-on hard disk 80 GB 24x7 ET - 5AC600.HDDI-06", on page 213).</li> <li>- Technical data for the hard disk 5AC600.HDDI-05 updated due to Revision D0.</li> <li>- Technical data for the hard disk 5AC600.HDDS-02 updated due to Revision D0.</li> <li>- PCI SATA RAID 2 x 160 GB - 5ACPCI.RAIC-03 (see the section "PCI SATA RAID 2 x 160 GB 24x7 ET - 5ACPCI.RAIC-03", on page 259) added.</li> <li>- Replacement SATA HDD 160 GB 5ACPCI.RAIC-04 added (see the section "Replacement SATA HDD 160 GB - 5ACPCI.RAIC-04", on page 264).</li> <li>- The section 5 "Configuration of a SATA RAID array" in the 3 "Commissioning" chapter updated.</li> <li>- The section 7 "Exchanging a PCI SATA RAID hard disk" in the 7 "Maintenance / Servicing" chapter updated.</li> </ul>
2.41	2008-08-11	<ul style="list-style-type: none"> <li>- Revision of the AP900 connection examples (cable selection tables) in Chapter 3.</li> <li>- APC620e and APC620f for UPS support expanded.</li> <li>- Compatibility note in which the Bosch CC770 CAN controller supplements Intels 82527 for the add-on CAN interface 5AC600.CANI-00.</li> <li>- Description edited for operating the add-on RS232/422/485 interface module 5AC600.485I-00 as an RS485 interface.</li> <li>- New Windows XP Pro version with SP3 - 5SWWXP.0600-DEU (German), 5SWWXP.0600-ENG (English) and 5SWWXP.0600-MUL (Multi-language) added.</li> <li>- Manual updated to include Section "Replacing the front cover", on page 787.</li> <li>- User serial ID description expanded.</li> <li>- Graphic 5 "Selection guide - APC620 optional components with 1, 2, 3, and 5 PCI slots" adjusted (cancelled products removed).</li> <li>- B&amp;R power supplies updated (see Section "Power supplies", on page 741).</li> <li>- PCI Ethernet cards 5ACPCI.ETH1-01 and 5ACPCI.ETH3-01 added (see Section 733).</li> <li>- Technical data - add-on hard disk - 5AC600.HDDI-02, 5AC600.HDDI-03 and 5AC600.HDDI-06 expanded.</li> <li>- Section "Connection of USB peripheral devices", on page 359 added</li> <li>- Section "Visual Components graphic engine support", on page 565 added</li> <li>- Graphic "Ambient temperatures for systems with an 855GME CPU board (ETX / XTX)", on page 93 updated to include the APC620e system units 5PC600.SE00-00, 5PC600.SE00-01 and 5PC600.SE00-02.</li> </ul>

Table 1: Manual history (Forts.)

Version	Date	Change
2.50	2009-04-23	<ul style="list-style-type: none"> <li>- Footnotes in section 4.3 "An Automation Panel 900 via SDL (onboard)" - "Cable lengths and resolutions for SDL transfer", on page 315 added.</li> <li>- ADI driver description -&gt; Windows 2000 removed and Automation Panel 800 added.</li> <li>- Information regarding SATA HDD exchange added.</li> <li>- Information "Required drivers can only be downloaded from the B&amp;R homepage, not from manufacturers' pages" added.</li> <li>- Temperature humidity diagram for 5AC600.CDXS-00 corrected.</li> <li>- Section 6 "Typical topologies", on page 51 in chapter 1 "General information" added.</li> <li>- 5ACPCI.RAIC-00 cancelled.</li> <li>- Fan control information expanded in Appendix A, section 3.2 "Temperature monitoring - Fan control", on page 796.</li> <li>- External UPS added to accessories - see section 17 "External UPS", on page 731.</li> <li>- B&amp;R Key Editor information updated.</li> <li>- ADI Development Kit information updated.</li> <li>- Section 2.7 "Environmentally-friendly disposal" in chapter 1 "General information" added.</li> <li>- Image of Silicon Systems CF card changed.</li> <li>- Contents of delivery for USB flash drives removed.</li> <li>- OTB704.91 and OTB704.9 added in Chapter 6 "Accessories".</li> <li>- Information about the BIOS setting in the connection examples with an AP900 via SDL (onboard) changed.</li> <li>- Information about firmware upgrade updated.</li> <li>- WinCE features updated.</li> <li>- Temperature humidity diagram for USB flash drive corrected.</li> <li>- B&amp;R CompactFlash card added.</li> <li>- Technical data for Silicon Systems CFs revised.</li> <li>- PCI routing for APC620e added to Chapter 4 "Software".</li> <li>- Maximum ambient temperature for APC620 embedded added.</li> <li>- Section "Installation on PCI SATA RAID controller - 5ACPCI.RAIC-03, 5ACPCI.RAIC-05", on page 569 added</li> </ul>

Table 1: Manual history (Forts.)

Version	Date	Change
2.60	2010-08-24	<ul style="list-style-type: none"> <li>- Model number text for the CPU board 5PC600.E855-05 corrected.</li> <li>- Processor architecture for the CPU boards 5PC600.E855-02, 5PC600.E855-03, 5PC600.X855-02 and 5PC600.X855-03 corrected.</li> <li>- CompactFlash cards 5CFCRD.xxxx-02 moved to page 659.</li> <li>- Section "Installation on PCI SATA RAID controller - 5ACPCCI.RAIC-03, 5ACPCCI.RAIC-05", on page 569 added</li> <li>- Graphic resolutions for the CPU boards added to the technical data.</li> <li>- Text change from "Compact Flash" to "CompactFlash" (in the images).</li> <li>- Table 338 "RAM address assignment", on page 539 corrected. - 6. Line - "0D0000h - 0CFFFFh VGA BIOS available." changed to "0D0000h - 0DFFFFh available."</li> <li>- Text change from "Ethernet POWERLINK" to "POWERLINK".</li> <li>- WinXP Pro SP 2c (5SWWXP.0500-DEU, 5SWWXP.0500-ENG, 5SWWXP.0500-MUL) updated.</li> <li>- WinCE Pro 6.0 (5SWWCE.0812-ENG, 5SWWCE.0813-ENG) updated.</li> <li>- Sections 8.3 "Windows CE 6.0 features", on page 593 and 8.4 "Differences between Windows CE 6.0 and Windows CE 5.0", on page 593 updated.</li> <li>- Table 29 "Overview of humidity specifications for individual components", on page 119 updated.</li> <li>- BIOS default settings for "I/O Device Configuration", on page 476 and "Boot", on page 480 corrected.</li> <li>- Height of the APC620 embedded heat sink corrected.</li> <li>- Section 2 "Upgrade information", on page 547 added</li> <li>- The section "Creating a bootable USB flash drive" removed.</li> <li>- Info text for B&amp;R CompactFlash cards updated.</li> <li>- Section 9 "Known problems / issues", on page 369 added</li> <li>- Information in section 1 "Temperature sensor locations", on page 791 expanded.</li> <li>- Table 342 "IRQ interrupt assignments in APIC mode", on page 542 corrected.</li> <li>- CompactFlash card 5CFCRD.016G-04 added.</li> <li>- Section "Automation PC 620 with BIOS" in Chapter 4 "Software" changed to "BIOS Options".</li> <li>- Section 7 "Automation PC 620 with Windows Embedded Standard 2009", on page 588 added</li> <li>- Section 9 "B&amp;R Automation Device Interface (ADI) driver - Control Center", on page 595 updated.</li> <li>- Chapter 5 "Standards and certifications", on page 609 updated.</li> <li>- B&amp;R USB flash drive added to the chapter 6 "Accessories" on page 685.</li> <li>- B&amp;R ID codes for system units added.</li> </ul>
		<ul style="list-style-type: none"> <li>- 855GME (ETX) BIOS description V1.26 updated to V1.30, see page 425 - the actions "Save Optimized Defaults" and "Load Optimized Defaults" were added to the menu item "Exit".</li> <li>- Technical data "Remanent variables for AR (Automation Runtime) in Power Fail Mode" added for the APC620 embedded system units and for the SRAM module 5AC600.SRAM-00.</li> </ul>
2.61	2011-01-27	<ul style="list-style-type: none"> <li>- The appellation „AR010" was changed to „ARwin".</li> <li>- The appellation „AR106" was changed to „ARemb".</li> </ul>
2.62	2011-03-03	<ul style="list-style-type: none"> <li>- Technical Data of the system unit 5PC600.SE00-01 was changed - the Monitor / Panel interface is a DVI-A female connector.</li> </ul>
2.63	2011-06-15	<ul style="list-style-type: none"> <li>- "Power calculation with 5PC600.SE00-00, 5PC600.SE00-01 and 5PC600.SE00-02", on page 118 added.</li> <li>- Sections</li> <li>"B&amp;R Automation Device Interface (ADI) driver - Control Center", on page 595,</li> <li>"HMI Drivers &amp; Utilities DVD 5SWHMI.0000-00", on page 687,</li> <li>"B&amp;R Key Editor information", on page 797</li> <li>and "B&amp;R Automation Device Interface (ADI) development kit", on page 799 updated.</li> <li>- Section "B&amp;R Automation Device Interface (ADI) .NET SDK", on page 801 added.</li> <li>- Table "Starting currents in the voltage supply to the system units", on page 136 and table "System unit revisions for any turn-off times", on page 137 updated to include the APC620e system units 5PC600.SE00-00, 5PC600.SE00-01 and 5PC600.SE00-02.</li> </ul>

Table 1: Manual history (Forts.)

Version	Date	Change
2.64	2011-07-28	<ul style="list-style-type: none"> <li>- „Information:“ to installation in section "Automation PC 620 with Windows XP Professional", on page 568 added.</li> <li>- Tableentra „typ. recharge time at low battery“ in table 453 "Technical data - 5AC600.UPSB-00", on page 726 added.</li> <li>- Referring to external UPS 24 VDC in Section "Uninterruptible power supply", on page 720 added.</li> <li>- Sections "B&amp;R Automation Device Interface (ADI) driver - Control Center", on page 595, "B&amp;R Automation Device Interface (ADI) development kit", on page 799 and "B&amp;R Automation Device Interface (ADI) .NET SDK", on page 801 added.</li> <li>- "PCI SATA RAID 2 x 250 GB - 5ACPCI.RAIC-05", on page 267 and "Replacement SATA HDD 250 GB - 5MMHDD.0250-00", on page 271 added</li> <li>- Section "Changing the CompactFlash", on page 746 added.</li> <li>- 5ACPCI.RAIC-05 added in figure "Ambient temperatures for systems with an 855GME CPU board (ETX / XTX)", on page 94, in figure 5 "Selection guide - APC620 optional components with 1, 2, 3, and 5 PCI slots", on page 57 in table 29 "Overview of humidity specifications for individual components", on page 119 and in headline "Installation on PCI SATA RAID controller - 5ACPCI.RAIC-03, 5ACPCI.RAIC-05", on page 569.</li> </ul>
2.65	2012-12-06	<ul style="list-style-type: none"> <li>- Ambient temperature for charging mode added to the technical data for the 5AC600.UPSB-00 battery unit, see "Battery unit 5AC600.UPSB-00", on page 726.</li> <li>- The add-on SSD drive "Add-on Solid State Drive 128 GB 24x7 ET - 5AC600.SSDI-00", on page 187 was added.</li> </ul>
2.66	2013-04-25	<ul style="list-style-type: none"> <li>- Replacement SSD drive "Replacement Solid State Drive 128 GB 24x7 ET - 5MMSSD.0128-00", on page 191 was added.</li> <li>- For "Add-on Solid State Drive 128 GB 24x7 ET - 5AC600.SSDI-00", on page 187, revision D was added.</li> <li>- The "CompactFlash cards 5CFCRD.xxxx-06", on page 645 were added.</li> <li>- Section "General instructions for performing temperature tests", on page 362 was added.</li> </ul>
2.68	2015-05-07	<ul style="list-style-type: none"> <li>- The revision E0 was added at the "Add-on Solid State Drive 128 GB 24x7 ET - 5AC600.SSDI-00", on page 187.</li> <li>- The revision E0 was added at the "Replacement Solid State Drive 128 GB 24x7 ET - 5MMSSD.0128-00", on page 191.</li> <li>- Section "Ground", on page 136 and "Grounding concept", on page 307 updated.</li> <li>- Added information about the discontinuation of support for the OS "Automation PC 620 with Windows XP Professional", on page 568.</li> </ul>

Table 1: Manual history (Forts.)

## 2. Safety notices

### 2.1 Intended use

Programmable logic controllers (PLCs), operating and monitoring devices (industrial PCs, Power Panels, Mobile Panels, etc.), and B&R uninterruptible power supplies have been designed, developed, and manufactured for conventional use in industry. They were not designed, developed, and manufactured for any use involving serious risks or hazards that could lead to death, injury, serious physical damage, or loss of any kind without the implementation of exceptionally stringent safety precautions. In particular, such risks and hazards include the use of these devices to monitor nuclear reactions in nuclear power plants, as well as flight control systems, flight safety, the control of mass transit systems, medical life support systems and the control of weapons systems.

### 2.2 Protection against electrostatic discharges

Electrical components that are vulnerable to electrostatic discharge (ESD) must be handled accordingly.

#### 2.2.1 Packaging

- Electrical components with housing  
... do not require special ESD packaging, but must be handled properly (see "Electrical components with housing").
- Electrical components without housing  
... must be protected by ESD-suitable packaging.

#### 2.2.2 Guidelines for proper ESD handling

##### Electrical components with housing

- Do not touch the connector contacts on connected cables.
- Do not touch the contact tips on the circuit boards.

##### Electrical components without housing

The following is valid in addition to "Electrical components with housing"

- Any persons handling electrical components or devices that will be installed in the electrical components must be grounded.
- Components can only be touched on the small sides or on the front plate.
- Components should always be stored in a suitable medium (ESD packaging, conductive foam, etc.).  
Metallic surfaces are not suitable storage surfaces!



- Electrostatic discharges should be avoided on the components (e.g. through charged plastics).
- A minimum distance of 10 cm must be kept from monitors and TV sets.
- Measurement devices and equipment must be grounded.
- Measurement probes on potential-free measurement devices must be discharged on sufficiently grounded surfaces before taking measurements.

### Individual components

- ESD protective measures for individual components are thoroughly integrated at B&R (conductive floors, footwear, arm bands, etc.).

The increased ESD protective measures for individual components are not necessary for our customers for handling B&R products.

## 2.3 Policy and procedures

Electronic devices are generally not failsafe. In the event of a failure on the programmable control system operating or monitoring device, or uninterruptible power supply, the user is responsible for ensuring that other devices that may be connected, e.g. motors, are in a secure state.

Both when using programmable logic controllers and when using operating and monitoring devices as control systems in conjunction with a soft PLC (e.g. B&R Automation Runtime or comparable products) or a slot PLC (e.g. B&R LS251 or comparable products), the safety precautions applying to industrial control systems (e.g. the provision of safety devices such as emergency stop circuits, etc.) must be observed in accordance with applicable national and international regulations. The same applies for all other devices connected to the system, such as drives.

All tasks such as installation, commissioning, and maintenance are only permitted to be carried out by qualified personnel. Qualified personnel are persons familiar with transport, unting, installation, commissioning, and operation of the product who also have the respective qualifications (e.g. IEC 60364). National accident prevention guidelines must be followed.

The safety guidelines, connection descriptions (type plate and documentation), and limit values listed in the technical data are to be read carefully before installation and commissioning and must be observed.

## 2.4 Transport and storage

During transport and storage, devices must be protected from excessive stress (mechanical load, temperature, humidity, aggressive atmospheres, etc.).

## **2.5 Installation**

- Installation must take place according to the documentation, using suitable equipment and tools.
- Devices must be installed without voltage applied and by qualified personnel.
- General safety regulations and nationally applicable accident prevention guidelines must be observed.
- Electrical installation must be carried out according to the relevant guidelines (e.g. line cross section, fuse, protective ground connection).

## **2.6 Operation**

### **2.6.1 Protection against touching electrical parts**

To operate programmable logic controllers, operating and monitoring devices or uninterruptible power supplies, certain components must carry dangerous voltage levels of over 42 VDC. A life-threatening electrical shock could occur if you come into contact with these parts. This could result in death, severe injury or material damage.

Before turning on the programmable logic controller, the operating and monitoring devices and the uninterruptible power supply, ensure that the housing is properly grounded (PE rail). The ground connection must be established when testing the operating and monitoring devices or the uninterruptible power supply, even when operating them for only a short time.

Before turning the device on, make sure that all parts with voltage applied are securely covered. During operation, all covers must remain closed.

### **2.6.2 Environmental conditions - dust, humidity, aggressive gases**

Use of operating and monitoring devices (e.g. industrial PCs, power panels, mobile panels, etc.) and uninterruptible power supplies in very dusty environments should be avoided. Dust collection on the devices influences their function and, especially in systems with active cooling (fans), sufficient cooling cannot be guaranteed.

The presence of aggressive gases in the environment can also lead to malfunctions. When combined with high temperature and humidity, aggressive gases - e.g. with sulfur, nitrogen and chlorine components - start chemical processes that can damage electronic components very quickly. Signs of the presence of aggressive gases are blackened copper surfaces and cable ends on existing installations.

For operation in dusty or humid conditions, correctly installed (cutout installation) operating and monitoring devices like Automation Panel or Power Panel are protected on the front side. The rear side of all devices must be protected from dust and humidity and must be cleaned at suitable intervals.

### 2.6.3 Programs, viruses, and dangerous programs

The system is subject to potential danger each time data is exchanged or software is installed from a data medium (e.g. diskette, CD-ROM, USB flash drive, etc.), a network connection, or the Internet. The user is responsible for assessing these dangers, implementing preventative measures such as virus protection programs, firewalls, etc. and obtaining software from reliable sources.

## 2.7 Environmentally-friendly disposal

All B&R programmable controllers, operating and monitoring devices, and uninterruptible power supplies are designed to inflict as little harm on the environment as possible.

### 2.7.1 Separation of materials

It is necessary to separate different materials so the device can undergo an environmentally-friendly recycling process.

Component	Disposal
Programmable logic controllers Operating and monitoring devices Uninterruptible power supply Cables	Electronics recycling
Cardboard box / paper packaging	Paper / cardboard recycling
Plastic packaging	Plastic recycling

Table 2: Environmentally-friendly separation of materials

Disposal must comply with the respective legal regulations.

### 3. Organization of safety notices

The safety notices in this manual are organized as follows:

Safety notice	Description
<b>Danger!</b>	Disregarding the safety regulations and guidelines can be life-threatening.
<b>Caution!</b>	Disregarding the safety regulations and guidelines can result in severe injury or major damage to material.
<b>Warning!</b>	Disregarding the safety regulations and guidelines can result in injury or damage to material.
<b>Information:</b>	Important information for preventing errors.

Table 3: Organization of safety notices

### 4. Directives

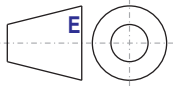

European dimension standards apply to all dimensions (e.g. dimension diagrams, etc.).

## 5. Model numbers

### 5.1 System units

Model number	Short description	Note
5PC600.SX01-00	<b>System 1 PCI</b> APC620 system unit 1 half size PCI slot, connection for 2 x RS232, 2 x USB 2.0, Short Display Link, 2 x ETH 10/100, AC97 sound, PS/2 keyboard/mouse; UPS module <sup>1)</sup> ; 24 VDC (order 0TB103.9 screw clamp or 0TB103.91 cage clamp terminals separately).	See page 60
5PC600.SX02-00	<b>System 2 PCI, 1 disk drive slot, 1 AP Link slot</b> APC620 system unit 2 half size PCI slots, 1 drive slot, 1 slot for Automation Panel link transmitter; connections for 2 x RS232, 2 x USB 2.0, Short Display Link, 2 x ETH 10/100, AC97 sound, PS/2 keyboard/mouse, UPS module <sup>2)</sup> ; 24 VDC (order 0TB103.9 screw clamp or 0TB103.91 cage clamp terminals separately).	See page 66
5PC600.SX02-01	<b>System 2 PCI, 1 disk drive slot</b> APC620 system unit 2 half size PCI slots, 1 drive slot; connections for 2 x RS232, 2 x USB 2.0, Short Display Link, 2 x ETH 10/100, AC97 sound, PS/2 keyboard/mouse, UPS module <sup>1)</sup> ; 24 VDC (0TB103.9 screw clamp or 0TB103.91 cage clamp sold separately).	See page 66
5PC600.SF03-00	<b>System 3 PCI, 1 disk drive, 1 AP Link slot</b> APC620 system unit, 3 full-size PCI slots; 1 slot for Automation Panel link transmitter; 1 drive slot; Smart Display Link / DVI / monitor, connections for 2 x RS232, 2 x USB 2.0, 2 x ETH 10/100, AC97 sound, PS/2 keyboard/mouse; 24 VDC (0TB103.9 screw clamp or 0TB103.91 cage clamp sold separately).	See page 72
5PC600.SX05-00	<b>System 5 PCI, 2 disk drive slots, 1 AP Link slot</b> APC620 system unit 5 half size PCI slots, 2 drive slot; 1 slot for Automation Panel Link Transmitter; connections for 2 x RS232, 2 x USB 2.0, Short Display Link, 2 x ETH 10/100, AC97 sound, PS/2 keyboard/mouse, UPS module <sup>3)</sup> ; 24 VDC (0TB103.9 screw clamp or 0TB103.91 cage clamp sold separately).	See page 77
5PC600.SX05-01	<b>System 5 PCI, 2 disk drive slots</b> APC620 system unit 5 half size PCI slots, 2 drive slots; connections for 2 x RS232, 2 x USB 2.0, Short Display Link, 2 x ETH 10/100, AC97 sound, PS/2 keyboard/mouse, UPS module <sup>3)</sup> ; 24 VDC (0TB103.9 screw clamp or 0TB103.91 cage clamp sold separately).	See page 77
5PC600.SE00-00	<b>APC620e System SDL EPL X2X CAN 512kB</b> APC620 embedded system unit, connections for 2x RS232, 4x USB 2.0, Smart Display Link, 1x ETH 10/100, 1x POWERLINK, 1x CAN, 1x X2X, UPS module, 512kB SRAM; (0TB103.9 screw clamp or 0TB103.91 cage clamp sold separately).	See page 83
5PC600.SE00-01	<b>APC620e System CRT EPL X2X CAN 512KB</b> APC620 embedded system unit, connections for 2x RS232, 4x USB 2.0, CRT, 1x ETH 10/100, 1x POWERLINK, 1x CAN, 1x X2X, UPS module, 512kB SRAM; (0TB103.9 screw clamp or 0TB103.91 cage clamp sold separately).	See page 83
5PC600.SE00-02	<b>APC620e System SDL EPL X2X CAN 1MB</b> APC620 embedded system unit, connections for 2x RS232, 4x USB 2.0, Smart Display Link, 1x ETH 10/100, 1x POWERLINK, 1x CAN, 1x X2X, UPS module, 1MB SRAM; (0TB103.9 screw clamp or 0TB103.91 cage clamp sold separately).	See page 83

Table 4: Model numbers - system units

- 1) Slot only available on system units with revision H0 or later.
- 2) Slot only available on system units with revision G0 or later.
- 3) Slot only available on system units with revision F0 or later.

## 5.2 CPU boards 815E (ETX)

Model number	Short description	Note
5PC600.E815-00	<b>CPU board 815E C3-400</b> CPU board Intel Celeron 3, 400 MHz, 100 MHz FSB, 256 kB L2 cache, 815E chipset; 1 socket for SO-DIMM SDRAM module.	Cancelled since 10/2005 Replaced by 855GME (ETX / XTX) CPU boards  See page 179
5PC600.E815-02	<b>CPU board 815E C3-733</b> CPU board Intel Celeron 3, 733 MHz, 133 MHz FSB, 256 kB L2 cache, 815E chipset; 1 socket for SO-DIMM SDRAM module.	
5PC600.E815-03	<b>CPU board 815E C3-1000</b> CPU board Intel Celeron 3, 1000 MHz, 133 MHz FSB, 256 kB L2 cache, 815E chipset; 1 socket for SO-DIMM SDRAM module.	

Table 5: Model numbers - 815E (ETX) CPU boards

## 5.3 CPU boards 855GME (ETX)

Model number	Short description	Note
5PC600.E855-00	<b>CPU board 855GME PM-1100</b> CPU board Intel Pentium M, 1100 MHz, 400 MHz FSB, 1 MB L2 cache; 855GME chipset; 1 socket for SO-DIMM DDR RAM module.	See page 181
5PC600.E855-01	<b>CPU board 855GME PM-1600</b> CPU board Intel Pentium M, 1600 MHz, 400 MHz FSB, 1 MB L2 cache; 855GME chipset; 1 socket for SO-DIMM DDR RAM module.	See page 181
5PC600.E855-02	<b>CPU board 855GME PM-1400</b> CPU board Intel Pentium M, 1400 MHz, 400 MHz FSB, 2 MB L2 cache; 855GME chipset; 1 socket for SO-DIMM DDR RAM module.	See page 181
5PC600.E855-03	<b>CPU board 855GME PM-1800</b> CPU board Intel Pentium M, 1800 MHz, 400 MHz FSB, 2 MB L2 cache; 855GME chipset; 1 socket for SO-DIMM DDR RAM module.	See page 181
5PC600.E855-04	<b>CPU board 855GME CM-600</b> CPU board Intel Celeron M, 600 MHz, 400 MHz FSB, 512 kB L2 cache; 855GME chipset; 1 socket for SO-DIMM DDR RAM module.	See page 181
5PC600.E855-05	<b>CPU board 855GME CM-1000</b> CPU board Intel Celeron M, 1000 MHz, 400 MHz FSB, 512 kB L2 cache; 855GME chipset; 1 socket for SO-DIMM DDR module.	See page 181

Table 6: Model numbers - 855GME (ETX) CPU boards

## 5.4 CPU boards 855GME (XTX)

Model number	Short description	Note
5PC600.X855-00	<b>CPU board 855GME PM-1100</b> CPU board Intel Pentium M, 1100 MHz, 400 MHz FSB, 1 MB L2 cache; 855GME chipset; 1 socket for SO-DIMM DDR RAM module.	See page 183
5PC600.X855-01	<b>CPU board 855GME PM-1600</b> CPU board Intel Pentium M, 1600 MHz, 400 MHz FSB, 1 MB L2 cache; 855GME chipset; 1 socket for SO-DIMM DDR RAM module.	See page 183
5PC600.X855-02	<b>CPU board 855GME PM-1400</b> CPU board Intel Pentium M, 1400 MHz, 400 MHz FSB, 2 MB L2 cache; 855GME chipset; 1 socket for SO-DIMM DDR RAM module.	See page 183
5PC600.X855-03	<b>CPU board 855GME PM-1800</b> CPU board Intel Pentium M, 1800 MHz, 400 MHz FSB, 2 MB L2 cache; 855GME chipset; 1 socket for SO-DIMM DDR RAM module.	See page 183
5PC600.X855-04	<b>CPU board 855GME CM-600</b> CPU board Intel Celeron M, 600 MHz, 400 MHz FSB, 512 kB L2 cache; 855GME chipset; 1 socket for SO-DIMM DDR RAM module.	See page 183
5PC600.X855-05	<b>CPU board 855GME CM-1000</b> CPU board Intel Pentium M, 1000 MHz, 400 MHz FSB, 512 kB L2 cache; 855GME chipset; 1 socket for SO-DIMM DDR RAM module.	See page 183

Table 7: Model numbers - 855GME (XTX) CPU boards

## 5.5 Heat sink

Model number	Short description	Note
5AC600.HS01-00	<b>APC620 heat sink 815E (ETX) 12.8mm</b> For APC620 system units with Intel 815E CPU Boards (ETX) with Celeron 3 400 MHz, Celeron 3 733 MHz, Celeron 3 1000 MHz.	Cancelled since 10/2005 Replaced by heat sinks for 855GME boards (ETX / XTX) See page 185
5AC600.HS01-01	<b>APC620 heat sink 855GME (ETX / XTX) 12.8mm</b> For APC620 system units with Intel 855GME CPU boards (ETX / XTX) with Celeron M 600 MHz, Celeron M 1000, Pentium M 1100 MHz, Pentium M 1400 MHz.	See page 185
5AC600.HS01-02	<b>APC620 heat sink 855GME (ETX / XTX) 28mm</b> for APC620 system units with Intel 855GME CPU boards (ETX / XTX) with Pentium M 1600 MHz, Pentium M 1800 MHz.	See page 185
5AC600.HS02-01	<b>APC620f heat sink 855GME (ETX / XTX) 12.8mm</b> For APC620 full-size system units with Intel 855GME CPU boards (ETX / XTX) with Celeron M 600 MHz, Celeron M 1000, Pentium M 1100 MHz, Pentium M 1400 MHz.	See page 185
5AC600.HS02-02	<b>APC620f heat sink 855GME (ETX / XTX) 28mm</b> for APC620 full-size system units with Intel 855GME CPU boards (ETX / XTX) with Pentium M 1600 MHz, Pentium M 1800 MHz.	See page 185
5AC600.HS03-01	<b>APC620 embedded heat sink (855GME XTX) 12.8 mm</b> Heat sink for APC620 embedded system units with Celeron® M 600 MHz (5PC600.X855-04), Celeron® M 1000 MHz (5PC600.X855-05), Pentium® M 1100 MHz (5PC600.X855-00) and Pentium® M 1400 MHz (5PC600.X855-02).	See page 185

Table 8: Model numbers - Heat sinks

## 5.6 Main memory

Model number	Short description	Note
5MMSDR.0128-01	<b>SO-DIMM SDRAM, 128 MB PC133</b> SO-DIMM SDRAM 128 MB PC133 for 815E CPU boards (ETX).	Cancelled since 10/2005 Replaced by main memory for 855GME boards (ETX / XTX)  See page 186
5MMSDR.0256-01	<b>SO-DIMM SDRAM, 256 MB PC133</b> SO-DIMM SDRAM 256 MB PC133 for 815E CPU boards (ETX).	
5MMSDR.0512-01	<b>SO-DIMM SDRAM, 512 MB PC133</b> SO-DIMM SDRAM 512 MB PC133 for 815E CPU boards (ETX).	
5MMDDR.0256-00	<b>SO-DIMM DDR-SDRAM 256 MB PC2700</b> SO-DIMM DDR-SDRAM 256 MB PC2700 for 855GME CPU boards (ETX / XTX).	See page 186
5MMDDR.0512-00	<b>SO-DIMM DDR-SDRAM 512 MB PC2700</b> SO-DIMM DDR-SDRAM 512 MB PC2700 for 855GME CPU boards (ETX / XTX).	See page 186
5MMDDR.1024-00	<b>SO-DIMM DDR-SDRAM 1024 MB PC2700</b> SO-DIMM DDR-SDRAM 1024 MB PC2700 for 855GME CPU boards (ETX / XTX).	See page 186

Table 9: Model numbers - Main memory

## 5.7 Drives

Model number	Short description	Note
5AC600.SSDI-00	<b>Add-on SSD 128 GB MLC</b> 128 GB Solid State Drive SATA (MLC), add-on. For installation in an APC620 or PPC700.	See page 187
5MMSSD.0128-00	<b>Replacement SSD 128 GB MLC</b> 128 GB Solid State Drive SATA (MLC), replacement SSD for 5AC600.SSDI-00	see page 191
5AC600.HDDI-00	<b>Add-on hard disk 30 GB 24x7</b> 30 GB hard disk (add-on); ideal for 24 hour operation (24x7). For installation in an APC620 or PPC700.	Cancelled since 04/2007. Replaced by: 5AC600.HDDI-05. See page 198
5AC600.HDDI-01	<b>Add-on hard disk 20 GB ET</b> 20 GB hard disk (add-on), with expanded temperature range (ET). For installation in an APC620 or PPC700.	Cancelled since 04/2007. Replaced by: 5AC600.HDDI-05. See page 198
5AC600.HDDI-02	<b>Add-on hard disk 40 GB 24x7</b> 40 GB hard disk (add-on); ideal for 24 hour operation (24x7). For installation in an APC620 or PPC700.	Cancelled since 08/2006. Replaced by: 5AC600.HDDI-05. See page 201
5AC600.HDDI-03	<b>Add-on hard disk 60 GB 24x7</b> 60 GB hard disk (add-on); ideal for 24 hour operation (24x7). For installation in an APC620 or PPC700.	Cancelled since 10/2007. Replaced by: 5AC600.HDDI-06. See page 204
5AC600.HDDI-04	<b>Add-on hard disk 80 GB 24x7</b> 80 GB hard disk (add-on); ideal for 24 hour operation (24x7). For installation in an APC620 or PPC700.	Cancelled since 10/2007. Replaced by: 5AC600.HDDI-06. See page 207
5AC600.HDDI-05	<b>Add-on hard disk 40 GB, 24x7, ET</b> 40 GB hard disk (add-on); Suitable for 24 hour operation (24x7) as well as for operation in the extended temperature range (ET). For installation in an APC620 or PPC700.	See page 210
5AC600.HDDI-06	<b>Add-on hard disk 80 GB, 24x7, ET</b> 80 GB hard disk (add-on); Suitable for 24 hour operation (24x7) as well as for operation in the extended temperature range (ET). For installation in an APC620 or PPC700.	See page 213

Table 10: Model numbers - Drives



Model number	Short description	Note
5AC600.CDXS-00	<b>Slide-in CD-ROM</b> CD-ROM drive (slide-in); for operation in a slide-in drive slot in an APC620 or PPC700 system.	See page 217
5AC600.CFSI-00	<b>Add-on CompactFlash slot</b> CompactFlash slot (add-on); for installation in an APC620 or PPC700.	See page 216
5AC600.CFSS-00	<b>Slide-in CF 2-slot</b> Slide-in CompactFlash adapter for 2 CompactFlash cards (via IDE and USB 2.0)	See page 228
5AC600.DVDS-00	<b>Slide-in DVD-ROM/CD-RW</b> DVD-ROM/CD-RW drive (slide-in); for operation in a slide-in drive slot in an APC620 or PPC700 system.	See page 220
5AC600.DVRS-00	<b>Slide-in DVD-R/RW, DVD+R/RW</b> DVD-RW drive (slide-in); for operation in a drive slot in an APC620 or PPC700 system.	See page 223
5AC600.FDDS-00	<b>Slide-in USB floppy disk drive</b> FDD drive (slide-in); for operation in a slide-in drive slot in an APC620 or PPC700 system.	See page 230
5AC600.HDDS-00	<b>30 GB 24/7 slide-in hard disk</b> 30 GB hard disk (slide-in); ideal for 24 hour operation (24x7). For use in a slide-in drive slot in an APC620 or PPC700 system.	Cancelled since 04/2007. Replaced by: 5AC600.HDDS-02. See page 233
5AC600.HDDS-01	<b>20 GB ET slide-in hard disk</b> 20 GB hard disk (slide-in); with expanded temperature range (ET). For use in a slide-in drive slot in an APC620 or PPC700 system.	Cancelled since 04/2007. Replaced by: 5AC600.HDDS-02. See page 236
5AC600.HDDS-02	<b>40 GB 24x7 ET slide-in hard disk</b> 40 GB hard disk (add-on); Suitable for 24 hour operation (24x7) as well as for operation in the extended temperature range (ET). For use in a slide-in drive slot in an APC620 or PPC700 system.	See page 239
5ACPCI.RAIC-00	<b>PCI RAID controller ATA/100</b> PCI Raid controller	Cancelled since 07/2007. Replaced by: 5ACPCI.RAIC-03. See page 243
5ACPCI.RAIC-01	<b>PCI SATA RAID system 2 x 60 GB 24x7</b> PCI Raid controller + 2 x 60 GB SATA hard disk; ideal for 24 hour operation (24x7). Requires a free PCI slot.	Cancelled since 04/2008 Replacement type 5ACPCI.RAIC-03 See page 251
5ACPCI.RAIC-02	<b>Replacement SATA-HDD 60 GB</b> 1 piece Hard disk 60 GB SATA, replacement part for 5ACPCI.RAIC-01	See page 256
5ACPCI.RAIC-03	<b>PCI SATA RAID system 2 x 160 GB 24x7, ET</b> PCI Raid controller + 2 x 160 GB SATA hard disk; Suitable for 24 hour operation (24x7) as well as for operation in the extended temperature range (ET). Requires a free PCI slot.	See page 259
5ACPCI.RAIC-04	<b>Replacement SATA-HDD 160 GB</b> 1 piece Hard disk 160 GB SATA, replacement part for 5ACPCI.RAIC-03	See page 264
5ACPCI.RAIC-05	<b>PCI RAID system SATA 2x250GB (M5400.6)</b> PCI RAID controller + 2 x 250 GB SATA hard disks; requires a free PCI slot.	See page 267
5MMHDD.0250-00	<b>Replacement SATA-HDD 250GB (M5400.6)</b> Hard disk 250 GB SATA, replacement part for 5ACPCI.RAIC-03 and 5ACPCI.RAIC-05.	See page 271
5ACPCI.RAIS-00	<b>PCI RAID storage 2 x 40 GB</b> PCI Raid hard disk 2 x 40 GB	Cancelled since 06/2006 Replacement type 5ACPCI.RAIC-03 See page 245
5ACPCI.RAIS-01	<b>PCI RAID storage 2 x 60 GB</b> PCI Raid hard disk 2 x 60 GB	Cancelled since 01/2007 Replacement type 5ACPCI.RAIC-03 See page 248

Table 10: Model numbers - Drives (Forts.)

## 5.8 Interface options

Model number	Short description	Note
5AC600.CANI-00	<b>Add-on CAN interface</b> CAN interface for installation in an APC620 or PPC700.	See page 274
5AC600.485I-00	<b>Add-on RS232/422/485 interface</b> Add-on RS232/422/485 interface for installation in an APC620 and PPC700.	See page 278

Table 11: Model numbers - Interfaces

## 5.9 Fan kits

Model number	Short description	Note
5PC600.FA01-00	<b>Fan kit 1PCI</b> APC620 fan kit, for system units with 1 PCI slot.	See page 282
5PC600.FA02-00	<b>Fan kit 2PCI</b> APC620 fan kit + filter clasp for system units with 2 PCI slots.	See page 283
5PC600.FA03-00	<b>Fan kit 3PCI</b> APC620 fan kit + filter clasp for system units with 3 PCI slots.	See page 285
5PC600.FA05-00	<b>Fan kit 5PCI</b> APC620 fan kit + filter clasp for system units with 5 PCI slots.	See page 286

Table 12: Model numbers - Fan kits

## 5.10 AP Link cards

Model number	Short description	Note
5AC600.SDL0-00	<b>AP Link SDL transmitter</b> APC620 Smart Display Link Transmitter, to connect an Automation Panel via SDL to an APC620.	See page 288

Table 13: Model numbers - AP Link graphics adapter

## 5.11 Accessories

### 5.11.1 Supply voltage connectors

Model number	Short description	Note
0TB103.9	<b>Plug 24V 5.08 3-pin screw clamps</b> 24 VDC 3-pin connector, female. Screw clamp, 3.31mm <sup>2</sup> ; protected against vibration by the screw flange.	See page 638
0TB103.91	<b>Plug 24V 5.08 3-pin cage clamps</b> 24 VDC 3-pin connector, female. cage clamps, 3.31mm <sup>2</sup> ; protected against vibration by the screw flange.	See page 638

Table 14: Model numbers - Supply voltage connectors

### 5.11.2 X2X and CAN plugs

Model number	Short description	Note
0TB704.9	<b>Terminal block, 4-pin,</b> Screw clamp, 1.5 mm <sup>2</sup>	See page 640
0TB704.91	<b>Terminal block, 4-pin,</b> cage clamps, 2.5 mm <sup>2</sup>	See page 640

Table 15: Model numbers - X2X and CAN plug

### 5.11.3 Batteries

Model number	Short description	Note
0AC201.91	<b>Lithium batteries, 4 pcs.</b> Lithium batteries, 4 pcs., 3 V / 950 mAh, button cell	See page 641
4A0006.00-000	<b>Lithium battery, 1 pc.</b> Lithium batteries, 1 pcs., 3 V / 950 mAh, button cell	See page 641

Table 16: Model numbers - Batteries

### 5.11.4 CompactFlash cards

Model number	Short description	Note
5CFCRD.0512-06	<b>CompactFlash 512 MB B&amp;R</b> CompactFlash card with 512 MB SLC NAND flash and IDE/ATA interface	see page 645
5CFCRD.1024-06	<b>CompactFlash 1024 MB B&amp;R</b> CompactFlash card with 1024 MB SLC NAND flash and IDE/ATA interface	see page 645
5CFCRD.2048-06	<b>CompactFlash 2048 MB B&amp;R</b> CompactFlash card with 2048 MB SLC NAND flash and IDE/ATA interface	see page 645
5CFCRD.4096-06	<b>CompactFlash 4096 MB B&amp;R</b> CompactFlash card with 4096 MB SLC NAND flash and IDE/ATA interface	see page 645
5CFCRD.8192-06	<b>CompactFlash 8192 MB B&amp;R</b> CompactFlash card with 8192 MB SLC NAND flash and IDE/ATA interface	see page 645
5CFCRD.016G-06	<b>CompactFlash 16 GB B&amp;R</b> CompactFlash card with 16 GB SLC NAND flash and IDE/ATA interface	see page 645
5CFCRD.032G-06	<b>CompactFlash 32 GB B&amp;R</b> CompactFlash card with 32 GB SLC NAND flash and IDE/ATA interface	see page 645
5CFCRD.0512-04	<b>CompactFlash 512 MB B&amp;R</b> CompactFlash card with 512 MB SLC NAND flash and IDE/ATA interface	See page 650
5CFCRD.1024-04	<b>CompactFlash 1024 MB B&amp;R</b> CompactFlash card with 1024 MB SLC NAND flash and IDE/ATA interface	See page 650
5CFCRD.2048-04	<b>CompactFlash 2048 MB B&amp;R</b> CompactFlash card with 2048 MB SLC NAND flash and IDE/ATA interface	See page 650
5CFCRD.4096-04	<b>CompactFlash 4096 MB B&amp;R</b> CompactFlash card with 4096 MB SLC NAND flash and IDE/ATA interface	See page 650
5CFCRD.8192-04	<b>CompactFlash 8192 MB B&amp;R</b> CompactFlash card with 8192 MB SLC NAND flash and IDE/ATA interface	See page 650

Table 17: Model numbers - CompactFlash cards

## General information • Model numbers

Model number	Short description	Note
5CFCRD.016G-04	<b>CompactFlash 16 GB B&amp;R</b> CompactFlash card with 16 GB SLC NAND flash and IDE/ATA interface	See page 650
5CFCRD.0064-03	<b>CompactFlash 64 MB SSI</b> CompactFlash card with 64 MB SLC NAND flash and IDE/ATA interface	See page 655
5CFCRD.0128-03	<b>CompactFlash 128 MB SSI</b> CompactFlash card with 128 MB SLC NAND flash and IDE/ATA interface	See page 655
5CFCRD.0256-03	<b>CompactFlash 256 MB SSI</b> CompactFlash card with 256 MB SLC NAND flash and IDE/ATA interface	See page 655
5CFCRD.0512-03	<b>CompactFlash 512 MB SSI</b> CompactFlash card with 512 MB SLC NAND flash and IDE/ATA interface	See page 655
5CFCRD.1024-03	<b>CompactFlash 1024 MB SSI</b> CompactFlash card with 1024 MB SLC NAND flash and IDE/ATA interface	See page 655
5CFCRD.2048-03	<b>CompactFlash 2048 MB SSI</b> CompactFlash card with 2048 MB SLC NAND flash and IDE/ATA interface	See page 655
5CFCRD.4096-03	<b>CompactFlash 4096 MB SSI</b> CompactFlash card with 4096 MB SLC NAND flash and IDE/ATA interface	See page 655
5CFCRD.8192-03	<b>CompactFlash 8192 MB SSI</b> CompactFlash card with 8192 MB SLC NAND flash and IDE/ATA interface	See page 655
5CFCRD.0032-02	<b>CompactFlash 32 MB SanDisk/A</b> CompactFlash card with 32 MB NAND flash and IDE/ATA interface.	Cancelled since 12/2005 Replaced by 5CFCRD.0064-03 See page 659
5CFCRD.0064-02	<b>CompactFlash 64 MB SanDisk/A</b> CompactFlash card with 64 MB NAND flash and IDE/ATA interface.	Cancelled since 12/2005 Replaced by 5CFCRD.0064-03 See page 659
5CFCRD.0128-02	<b>CompactFlash 128 MB SanDisk/A</b> CompactFlash card with 128 MB NAND flash and IDE/ATA interface	Cancelled since 12/2005 Replaced by 5CFCRD.0128-03 See page 659
5CFCRD.0256-02	<b>CompactFlash 256 MB SanDisk/A</b> CompactFlash card with 256 MB NAND flash and IDE/ATA interface	Cancelled since 12/2005 Replaced by 5CFCRD.0256-03 See page 659
5CFCRD.0512-02	<b>CompactFlash 512 MB SanDisk/A</b> CompactFlash card with 512 MB NAND flash and IDE/ATA interface	Cancelled since 12/2005 Replaced by 5CFCRD.0512-03 See page 659
5CFCRD.1024-02	<b>CompactFlash 1024 MB SanDisk/A</b> CompactFlash card with 1024 MB NAND flash and IDE/ATA interface	Cancelled since 12/2005 Replaced by 5CFCRD.1024-03 See page 659
5CFCRD.2048-02	<b>CompactFlash 2048 MB SanDisk/A</b> CompactFlash card with 2048 MB NAND flash and IDE/ATA interface	Cancelled since 12/2005 Replaced by 5CFCRD.2048-03 See page 659

Table 17: Model numbers - CompactFlash cards (Forts.)

## 5.11.5 USB flash drives

Model number	Short description	Note
5MMUSB.0128-00	<b>USB flash drive 128 MB SanDisk</b> USB 2.0 flash drive 128 MB	Cancelled since 12/2005 Replaced by 5MMUSB.2048-00 See page 682
5MMUSB.0256-00	<b>USB flash drive 256 MB SanDisk</b> USB 2.0 flash drive 256 MB	Cancelled since 03/2007 Replaced by 5MMUSB.2048-00 See page 682
5MMUSB.0512-00	<b>USB flash drive 512 MB SanDisk</b> USB 2.0 flash drive 512 MB	Cancelled since 07/2007 Replaced by 5MMUSB.2048-00 See page 682
5MMUSB.1024-00	<b>USB flash drive 1 GB SanDisk</b> USB 2.0 flash drive 1 GB	Cancelled since 03/2007 Replaced by 5MMUSB.2048-00 See page 682
5MMUSB.2048-00	<b>USB flash drive 2 GB SanDisk</b> USB 2.0 flash drive 2 GB	See page 682
5MMUSB.2048-01	<b>USB flash drive 2 GB B&amp;R</b> USB 2.0 flash drive 2 GB	See page 685

Table 18: Model numbers - USB flash drives

## 5.11.6 Cables

Model number	Description	Note
5CAMSC.0001-00	<b>APC620 internal supply cable</b>	See page 692
5CADVI.0018-00	<b>DVI-D cable 1.8 m</b> Single cable, DVI-D/m:DVI-D/m; length: 1.8 m	See page 693
5CADVI.0050-00	<b>DVI-D cable 5 m</b> Single cable, DVI-D/m:DVI-D/m; length: 5 m	See page 693
5CADVI.0100-00	<b>DVI-D cable 10 m</b> Single cable, DVI-D/m:DVI-D/m; length: 10 m	See page 693
5CASDL.0018-00	<b>SDL cable 1.8 m</b> SDL cable for a fixed type of layout; length: 1.8 m	See page 696
5CASDL.0018-01	<b>SDL cable 1.8 m 45°</b> SDL cable for fixed type of layout with one-sided 45° plug; length: 1.8 m	See page 699
5CASDL.0018-03	<b>1.8 m flex SDL cable</b> SDL cable for fixed and flexible type of layout; length: 1.8 m	See page 706
5CASDL.0050-00	<b>SDL cable 5 m</b> SDL cable for a fixed type of layout; length: 5 m	See page 696
5CASDL.0050-01	<b>SDL cable 5 m 45°</b> SDL cable for fixed type of layout with one-sided 45° plug; length: 5 m	See page 699
5CASDL.0050-03	<b>5 m flex SDL cable</b> SDL cable for fixed and flexible type of layout; length: 5 m	See page 706
5CASDL.0100-00	<b>SDL cable 10 m</b> SDL cable for a fixed type of layout; length: 10 m	See page 696

Table 19: Model numbers - Cables

## General information • Model numbers

Model number	Description	Note
5CASDL.0100-01	<b>SDL cable 10 m 45°</b> SDL cable for fixed type of layout with one-sided 45° plug; length: 10 m	See page 699
5CASDL.0100-03	<b>10 m flex SDL cable</b> SDL cable for fixed and flexible type of layout; length: 10 m	See page 706
5CASDL.0150-00	<b>SDL cable 15 m</b> SDL cable for a fixed type of layout; length: 15 m	See page 696
5CASDL.0150-01	<b>SDL cable 15 m 45°</b> SDL cable for fixed type of layout with one-sided 45° plug; length: 15 m	See page 699
5CASDL.0150-03	<b>15 m flex SDL cable</b> SDL cable for fixed and flexible type of layout; length: 15 m	See page 706
5CASDL.0200-00	<b>SDL cable 20 m</b> SDL cable for a fixed type of layout; length: 20 m	See page 696
5CASDL.0200-03	<b>20 m flex SDL cable</b> SDL cable for fixed and flexible type of layout; length: 20 m	See page 706
5CASDL.0250-00	<b>SDL cable 25 m</b> SDL cable for a fixed type of layout; length: 25 m	See page 696
5CASDL.0250-03	<b>25 m flex SDL cable</b> SDL cable for fixed and flexible type of layout; length: 25 m	See page 706
5CASDL.0300-00	<b>SDL cable 30 m</b> SDL cable for a fixed type of layout; length: 30 m	See page 696
5CASDL.0300-03	<b>30 m flex SDL cable</b> SDL cable for fixed and flexible type of layout; length: 30 m	See page 706
5CASDL.0300-10	<b>30 m SDL cable with extender</b> SDL cable with extender for a fixed type of layout; length 30 m	Cancelled since 12/2006 Replaced by 5CASDL.0300-13 See page 702
5CASDL.0300-13	<b>30 m SDL flex cable with extender</b> SDL cable with extender for fixed and flexible type of layout; length: 30 m	See page 711
5CASDL.0400-10	<b>40 m SDL cable with extender</b> SDL cable with extender for a fixed type of layout; length 40 m	Cancelled since 12/2006 Replaced by 5CASDL.0400-13 See page 702
5CASDL.0400-13	<b>40 m SDL flex cable with extender</b> SDL cable with extender for fixed and flexible type of layout; length: 40 m	See page 711
5CAUSB.0018-00	<b>USB 2.0 cable, A/m:B/m 1.8 m</b> USB 2.0 connection cable; plug type A - type B; length 1.8 m	See page 718
5CAUSB.0050-00	<b>USB 2.0 cable, A/m:B/m 5 m</b> USB 2.0 connection cable; plug type A - type B; length 5 m	See page 718
9A0014.02	<b>RS232 cable DB9/f:DB9/m 1.8 m</b> RS232 extension cable for remote operation of a display unit with touch screen, length 1.8 m.	See page 716
9A0014.05	<b>RS232 cable DB9/f:DB9/m 5 m</b> RS232 extension cable for remote operation of a display unit with touch screen, length 5 m.	See page 716
9A0014.10	<b>RS232 cable DB9/f:DB9/m 10 m</b> RS232 extension cable for remote operation of a display unit with touch screen, length 10 m.	See page 716

Table 19: Model numbers - Cables (Forts.)

## 5.11.7 UPS module + accessories

Model number	Short description	Note
5AC600.UPSI-00	<b>Add-on UPS module</b> UPS module for APC620, APC810, PPC800; for system units 5PC600.SX01-00 (starting with Rev. H0), 5PC600.SX02-00 (starting with Rev. G0), 5PC600.SX02-01 (starting with Rev. H0), 5PC600.SX05-00 (starting with Rev. F0), 5PC600.SX05-01 (starting with Rev. F0), 5PC600.SF03-00 (starting with Rev. A0), 5PC810.SX*. 5PC820.1505-00, 5PC820.1906-00 Order cable (5CAUPS.0005-00 or 5CAUPS.0030-00) and battery unit (5AC600.UPSB-00) separately.	See page 724
5AC600.UPSB-00	<b>Battery unit 5 Ah</b> Battery unit 5Ah; for APC620, APC810 or PPC800 UPS.	See page 726
5CAUPS.0005-00	<b>APC620 UPS cable 0.5 m</b> Connection cable between add-on UPS module and UPS battery unit, length 0.5 meters	See page 730
5CAUPS.0030-00	<b>APC620 UPS cable 3 m</b> Connection cable between add-on UPS module and UPS battery unit, length 3 meters	See page 730

Table 20: Model numbers - UPS module + accessories

## 5.11.8 PCI Ethernet cards

Model number	Short description	Note
5ACPCI.ETH1-01	<b>PCI Ethernet card 10/100</b> half size PCI Ethernet card, 1 Ethernet connection	See page 733
5ACPCI.ETH3-01	<b>PCI Ethernet card 10/100 3port</b> half size PCI Ethernet card, 3 Ethernet connections	See page 735

Table 21: Model numbers - PCI Ethernet cards

## 5.11.9 Miscellaneous

Model number	Short description	Note
5A5003.03	<b>Front cover</b> Front cover for the USB 2.0 Media Drive 5MD900.USB2-00.	See page 680
5AC600.ICOV-00	<b>Interface covers</b> Interface covers for APC620 and PPC700 devices; 5 pieces	See page 643
5AC900.1000-00	<b>Adapter DVI-A/m to CRT DB15HD/f</b> Adapter DVI (plug) to CRT (socket), for connecting a standard monitor to a DVI-I interface.	See page 644
5AC600.SRAM-00	<b>APC620/PPC700 SRAM module 512kB</b> SRAM module for APC620 and PPC700 512 KB.	See page 738
5MD900.USB2-00	<b>USB 2.0 drive DVD-ROM/CD-RW FDD CF USB</b> USB 2.0 drive combination, consists of DVD-ROM/CD-RW, FDD, CompactFlash slot (type II), USB connection (type A front, type B back); 24 V DC.	Cancelled since 10/2006 Replacement type 5MD900.USB2-01 See page 668
5MD900.USB2-01	<b>USB 2.0 drive DVD-RW/CD-RW FDD CF USB</b> USB 2.0 drive combination, consists of DVD-R/RW/DVD+R/RW/CD-RW, FDD, CompactFlash slot (type II), USB connection (type A front, type B back); 24 V DC.	See page 675
5AC600.FA01-00	<b>APC620 replacement fan filter 1PCI 5 piece</b> APC620 replacement fan filter for system unit with 1 PCI Slot (5PC600.SX01-00).	See page 737

Table 22: Model numbers - Other items

## General information • Model numbers

Model number	Short description	Note
5AC600.FA02-00	<b>APC620 replacement fan filter 1PCI 5 piece</b> APC620 replacement fan filter for system unit with 2 PCI slot (5PC600.SX02-00, 5PC600.SX02-01).	See page 737
5AC600.FA03-00	<b>APC620f replacement fan filter 1PCI 5 piece</b> APC620 replacement fan filter for system unit with 3 PCI Slots (5PC600.SF03-00).	See page 737
5AC600.FA05-00	<b>APC620 replacement fan filter 1PCI 5 piece</b> APC620 replacement fan filter for system units with 5 PCI slot (5PC600.SX02-00, 5PC600.SX02-01).	See page 737
0PS102.0	<b>Power supply, 1-phase, 2.1 A</b> 24 VDC power supply, 1-phase, 2.1 A, input 100-240 VAC, wide range, DIN rail mounting	See page 741
0PS104.0	<b>Power supply, 1-phase, 4.2 A</b> 24 VDC power supply, 1 phase, 4.2 A, input 115/230 VAC, auto select, DIN rail mounting	See page 741
0PS105.1	<b>Power supply, 1-phase, 5 A</b> 24 VDC power supply, 1 phase, 5 A, input 115/230 VAC, manual select, DIN rail mounting	See page 741
0PS105.2	<b>Power supply, 1-phase, 5 A, redundant</b> 24 VDC power supply, 1 phase, 5 A, redundant through parallel operation, input 115/230 VAC, manual select, DIN rail mounting	See page 741
0PS110.1	<b>Power supply, 1-phase, 10 A</b> 24 VDC power supply, 1 phase, 10 A, input 115/230 VAC, manual select, DIN rail mounting	See page 741
0PS110.2	<b>Power supply, 1-phase, 10 A, redundant</b> 24 VDC power supply, 1 phase, 10 A, redundant through parallel operation, input 115/230 VAC, manual select, DIN rail mounting	See page 741
0PS120.1	<b>Power supply, 1-phase, 20 A</b> 24 VDC power supply, 1 phase, 20 A, input 115/230 VAC, auto select, DIN rail mounting	See page 741
0PS305.1	<b>Power supply, 3-phase, 5 A</b> 24 VDC power supply, 3-phase, 5 A, input 400..500 VAC (3 phases), wide range, DIN rail mounting	See page 741
0PS310.1	<b>Power supply, 3-phase, 10 A</b> 24 VDC power supply, 3-phase, 10 A, input 400..500 VAC (3 phases), wide range, DIN rail mounting	See page 741
0PS320.1	<b>Power supply, 3-phase, 20 A</b> 24 VDC power supply, 3-phase, 20 A, input 400..500 VAC (3 phases), wide range, DIN rail mounting	See page 741
0PS340.1	<b>Power supply, 1-phase, 40 A</b> 24 VDC power supply, 3 phase, 40 A, input 115/230 VAC, auto select, DIN rail mounting	See page 741
5SWHMI.0000-00	<b>HMI Drivers &amp; Utilities DVD</b>	See page 687

Table 22: Model numbers - Other items (Forts.)

## 5.12 Software

Model number	Short description	Note
9S0000.01-010	<b>OEM MS-DOS 6.22 German (disk)</b> OEM MS-DOS 6.22 German disks Only delivered with a new PC.	See page 566

Table 23: Model numbers - Software



Model number	Short description	Note
9S0000.01-020	<b>OEM MS-DOS 6.22 English (disk)</b> OEM MS-DOS 6.22 English disks Only delivered with a new PC.	See page 566
9S0000.08-010	<b>OEM Microsoft Windows XP Professional</b> CD, German; Only delivered with a new PC.	Cancelled since 10/2008 See page 568
9S0000.08-020	<b>OEM Microsoft Windows XP Professional</b> CD, English; Only delivered with a new PC.	Cancelled since 10/2008 See page 568
9S0000.09-090	<b>OEM Microsoft Windows XP Professional Multilanguage</b> CDs; Only delivered with a new PC.	Cancelled since 10/2008 See page 568
5SWWXP.0600-GER	<b>WinXP Professional with SP3, CD German</b> Microsoft OEM Windows XP Professional Service Pack 3, CD, German. Only available with a new device.	See page 568
5SWWXP.0600-ENG	<b>WinXP Professional with SP3, CD English</b> Microsoft OEM Windows XP Professional Service Pack 3, CD, English. Only available with a new device.	See page 568
5SWWXP.0600-MUL	<b>WinXP Professional with SP3, CD, Multi-language</b> Microsoft OEM Windows XP Professional Service Pack 3, CD, multi-language. Only available with a new device.	See page 568
5SWWXP.0500-GER	<b>WinXP Professional with SP2c, CD German</b> Microsoft OEM Windows XP Professional Service Pack 2c, CD, German. Only available with a new device.	See page 568
5SWWXP.0500-ENG	<b>WinXP Professional with SP2c, CD English</b> Microsoft OEM Windows XP Professional Service Pack 2c, CD, English. Only available with a new device.	See page 568
5SWWXP.0500-MUL	<b>WinXP Professional with SP2c, CD, Multi-language</b> Microsoft OEM Windows XP Professional Service Pack 2c, CD, multi-language. Only available with a new device.	See page 568
9S0001.19-020	<b>OEM Microsoft Windows XP Embedded APC620 815E w/CF, English</b> 512 MB CompactFlash card with Windows XP Embedded image for APC620 systems with a 815E CPU board. Only delivered with a new PC.	Cancelled since 10/2005 See page 584
9S0001.20-020	<b>OEM Microsoft Windows XP Embedded APC620 855GME w/CF, English</b> 512 MB CompactFlash card with Windows XP Embedded image for APC620 systems with a 855GME CPU board. Only delivered with a new PC.	Cancelled since 10/2007 Replacement type 5SWWXP.0412.ENG See page 584
9S0001.27-020	<b>OEM Microsoft Windows XP Embedded (incl. SP2) APC620 815E w/CF, English</b> 512 MB CompactFlash card with Windows XP Embedded image including SP2 for APC620 systems with a 815E CPU board. Only delivered with a new PC.	Cancelled since 10/2005 See page 584
9S0001.28-020	<b>OEM Microsoft Windows XP Embedded (incl. SP2) APC620 855GME w/CF, English</b> 512 MB CompactFlash card with Windows XP Embedded image including SP2 for APC620 systems with a 855GME CPU board. Only delivered with a new PC.	Cancelled since 10/2007 Replacement type 5SWWXP.0412.ENG See page 584
5SWWXP.0412-ENG	<b>WinXPe FP2007 APC620 E855GME</b> Order Microsoft Windows XP Embedded English, Feature Pack 2007, for APC620 with CPU boards 5PC600.E855-00, 5PC600.E855-01, 5PC600.E855-02, 5PC600.E855-03, 5PC600.E855-04, 5PC600.E855-05; CompactFlash separately (at least 512 MB). Only delivered with a new PC.	See page 584
5SWWXP.0413-ENG <sup>1)</sup>	<b>WinXPe FP2007 APC620 X855GME</b> Order Microsoft Windows XP Embedded English, Feature Pack 2007, for APC620 with CPU boards 5PC600.X855-00, 5PC600.X855-01, 5PC600.X855-02, 5PC600.X855-03, 5PC600.X855-04, 5PC600.X855-05; CompactFlash separately (at least 512 MB). Only delivered with a new PC.	See page 584

Table 23: Model numbers - Software (Forts.)

## General information • Model numbers

Model number	Short description	Note
5SWWXP.0712-ENG	<b>Windows Embedded Standard 2009 APC620 855GME ETX</b> Microsoft OEM Windows Embedded, Standard 2009, English; for APC620 with ETX CPU board with 855GME chipset; order CompactFlash separately (at least 1 GB).	See page 588
5SWWXP.0713-ENG	<b>Windows Embedded Standard 2009 APC620 855GME XTX</b> Microsoft OEM Windows Embedded, Standard 2009, English; for APC620 with XTX CPU board with 855GME chipset; order CompactFlash separately (at least 1 GB).	See page 588
9S0001.29-020	<b>WinCE5.0 Pro license</b> OEM Microsoft Windows CE 5.0 Professional, English, license, only supplied together with a device.	Cancelled since 07/2007 See page 591
9S0001.32-020	<b>WinCE5.0 Pro APC620,PPC700</b> OEM Microsoft Windows CE 5.0 Professional; for APC620 and PPC700 with Intel 855GME chipset, English; preinstalled on 128 MB CompactFlash card.	Cancelled since 07/2007 Replacement type: 5SWWCE.0512-ENG See page 591
5SWWCE.0512-ENG	<b>WinCE5.0 Pro APC620 E855GME</b> Order Microsoft Windows CE 5.0 Professional, English, including license, for APC620 with CPU boards 5PC600.E855-00, 5PC600.E855-01, 5PC600.E855-02, 5PC600.E855-03, 5PC600.E855-04, 5PC600.E855-05; CompactFlash separately (at least 128 MB).	See page 591
5SWWCE.0513-ENG	<b>WinCE5.0 Pro APC620 X855GME</b> Order Microsoft Windows CE 5.0 Professional, English, including license, for APC620 with CPU boards 5PC600.X855-00, 5PC600.X855-01, 5PC600.X855-02, 5PC600.X855-03, 5PC600.X855-04, 5PC600.X855-05; CompactFlash separately (at least 128 MB).	See page 591
9S0001.34-020	<b>WinCE5.0 ProPlus APC620,PPC700</b> OEM Microsoft Windows CE 5.0 Professional plus; for APC620 and PPC700 with Intel 855GME chipset, English; preinstalled on 128 MB CompactFlash card.	Cancelled since 07/2007 Replacement type: 5SWWCE.0612-ENG See page 591
9S0001.36-020	<b>WinCE5.0 ProPlus license</b> OEM Microsoft Windows CE 5.0 Professional plus, English, license, only supplied together with a device.	Cancelled since 07/2007 See page 591
5SWWCE.0612-ENG	<b>WinCE5.0 ProPlus APC620 E855GME</b> Order Microsoft Windows CE 5.0 Professional Plus, English, including license, for APC620 with CPU boards 5PC600.E855-00, 5PC600.E855-01, 5PC600.E855-02, 5PC600.E855-03, 5PC600.E855-04, 5PC600.E855-05; CompactFlash separately (at least 128 MB).	See page 591
5SWWCE.0613-ENG	<b>WinCE5.0 ProPlus APC620 X855GME</b> Order Microsoft Windows CE 5.0 Professional Plus, English, including license, for APC620 with CPU boards 5PC600.X855-00, 5PC600.X855-01, 5PC600.X855-02, 5PC600.X855-03, 5PC600.X855-04, 5PC600.X855-05; CompactFlash separately (at least 128 MB).	See page 591
5SWWCE.0812-ENG	<b>WinCE6.0 Pro APC620 E855GME</b> Order Microsoft Windows CE 6.0 Professional, English, including license, for APC620 with CPU boards 5PC600.E855-00, 5PC600.E855-01, 5PC600.E855-02, 5PC600.E855-03, 5PC600.E855-04, 5PC600.E855-05; CompactFlash separately (at least 128 MB).	See page 591
5SWWCE.0813-ENG	<b>WinCE6.0 Pro APC620 X855GME</b> Order Microsoft Windows CE 6.0 Professional, English, including license, for APC620 with CPU boards 5PC600.X855-00, 5PC600.X855-01, 5PC600.X855-02, 5PC600.X855-03, 5PC600.X855-04, 5PC600.X855-05; CompactFlash separately (at least 128 MB).	See page 591

Table 23: Model numbers - Software (Forts.)

1) Support for Automation PC 620 embedded system units starting with Revision D0.

## 6. Typical topologies

### 6.1 APC620 embedded for central control and visualization

The control program runs on the APC620 embedded. The visualization project is integrated with Visual Components. A display unit is connected to the PC. The PC is networked via Ethernet TCP/IP; additional Power Panel-based operator terminals can also be connected via Ethernet. Communication to I/O systems with axes is handled via fieldbus systems (CAN bus, POWERLINK).

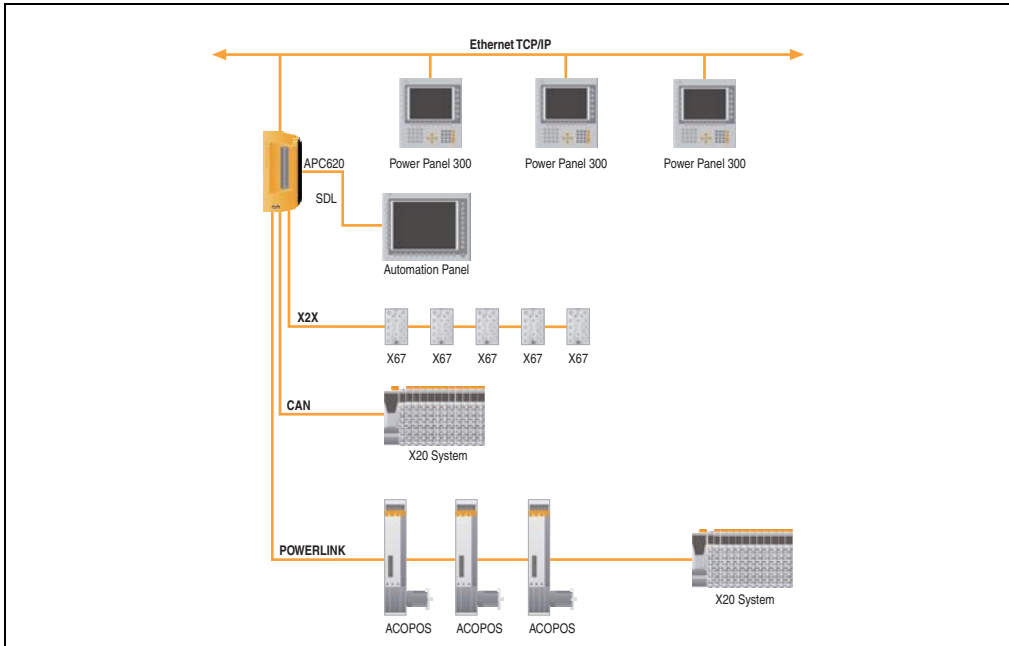

Figure 1: APC620 embedded for central control and visualization

## 6.2 APC620 as visualization device

The visualization runs on the APC620 as a SCADA application. Two display units are connected to the PC either locally or remotely. The control tasks interact with one or more underlying PLC stations where I/O systems and drives are connected locally or remotely over fieldbus systems. Additional SCADA stations can be networked via Ethernet TCP/IP.

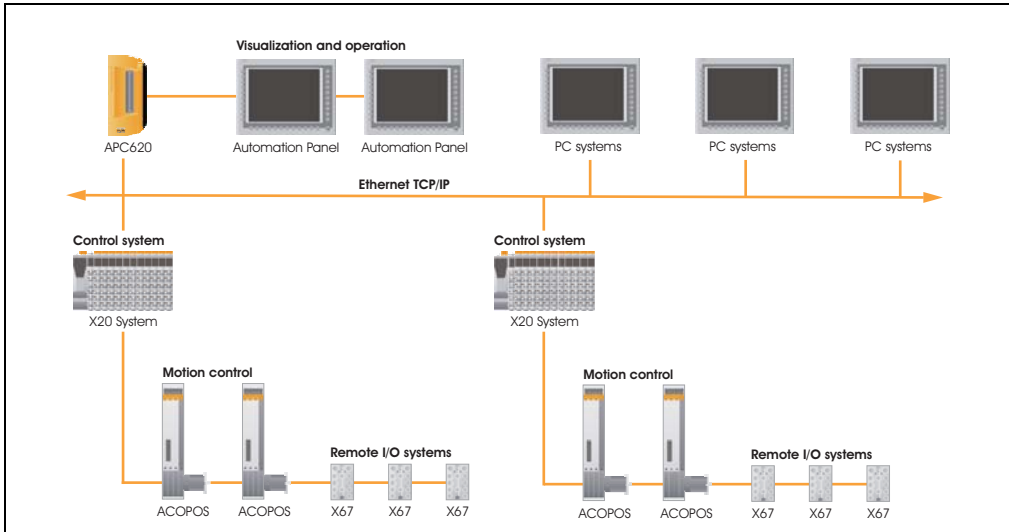

Figure 2: APC620 as visualization device

# Chapter 2 • Technical Data

## 1. Introduction

With its structure, its many slots and well thought-out placement of interfaces and drives, the APC620 provides optimal adaptability and ergonomics. The APC620 saves space in the switching cabinet. Drive inserts (HDD, CD-ROM, DVD, burner, etc.) and up to two CompactFlash slots are hidden behind a cover on the front of the device.

The APC620 embedded additionally unites the fieldbus interfaces POWERLINK, CAN and X2X in a compact housing.



Figure 3: Automation PC 620 system overview

The APC620 with an Intel® Pentium® M processor and Intel® 855GME chipset is available for high-performance applications that require a powerful processor. These processors, developed specially for mobile computing, offer many advantages for industrial applications as well. They combine high computing capacity with low power consumption. The chipset contains an integrated graphic solution which provides optimal use of memory for the system and graphics.

## 1.1 Features

- Processors up to Pentium M 1.8 GHz (APC620 embedded only possible up to 1.4 GHz)
- CompactFlash slot (type I)
- Half-size / full-size PCI slots (PCI standard 2.2, 32-bit, PCI bus speed 33 MHz)
- AC97 sound
- USB 2.0
- 24 VDC supply voltage
- 2x Ethernet 10/100 MBit interfaces
- 2x RS232 Interface, modem compatible
- PS/2 keyboard/mouse (combined)
- CAN add-on interface
- Fieldbus interfaces<sup>1)</sup> (POWERLINK, CAN and X2X)
- RS232/422/485 add-on interface
- Fan-free operation<sup>2)</sup>
- BIOS
- Real-time clock, (RTC) battery-buffered
- Up to 1 GB main memory
- Connection of various display devices to the "Monitor/Panel" video output (supports RGB, DVI, and SDL - Smart Display Link - signals)
- Optional installation of add-on UPS APC620 module<sup>3)</sup>
- Optional SRAM module<sup>4)</sup> battery backed

1) Only on APC620 embedded system units.

2) Dependent on the device configuration and the ambient temperature.

3) Installation depends on the revision of the system unit: 5PC600.SX01-00 from Rev. H0, 5PC600.SX02-00 from Rev. G0, 5PC600.SX02-01 from Rev. H0, 5PC600.SX05-00 from Rev. F0, 5PC600.SX05-01 from Rev. F0.

4) Installation depends on the revision of the system unit: 5PC600.SX01-00 from Rev. I0, 5PC600.SX02-00 from Rev. H0, 5PC600.SX02-01 from Rev. K0, 5PC600.SX05-00 from Rev. H0, 5PC600.SX05-01 from Rev. H0.

## 1.2 Structure / configuration APC620 with 1, 2, 3 and 5 PCI slots

The APC620 system can be assembled to meet individual requirements and operational conditions.

The following components are absolutely essential for operation:

- System unit
- CPU board
- Heat sink (CPU board dependent)
- Main memory (CPU board dependent)
- Drive (mass memory such as CompactFlash card or hard disk) for the operating system
- Software

1.2.1 Selection guide - basic system









Configuration - Basic system				
System unit	Select 1			
The system unit consists of the housing and base board. Variants: PCI slots (1,2, 3 or 5) Slide-in slots (0,1 or 2) AP Link slots (0 or 1) Example 2 / 1 / 1 = 2 PCI, 1 slide-in, 1 AP Link				
	5PC600.SX01-00 (1/0/0)	5PC600.SX02-01 (2/1/0) 5PC600.SX02-00 (2/1/1)	5PC600.SF03-00 (3/1/1)	5PC600.SX05-01 (5/2/0) 5PC600.SX05-00 (5/2/1)
CPU board - Main memory module - Heat sink (select 1 of each)				
System selection				
CPU board	815E CPU board (ETX)		855GME CPU board (ETX / XTX)	
	5PC600.E815-00 - C3-400 MHz 5PC600.E815-02 - C3 733 MHz 5PC600.E815-03 - C3 1000 MHz		5PC600.E855-00 / 5PC600.X855-00 - PM 1100 MHz 5PC600.E855-01 / 5PC600.X855-01 - PM 1600 MHz 5PC600.E855-02 / 5PC600.X855-02 - PM 1400 MHz 5PC600.E855-03 / 5PC600.X855-03 - PM 1800 MHz 5PC600.E855-04 / 5PC600.X855-04 - CM 600 MHz 5PC600.E855-05 / 5PC600.X855-05 - CM 1000 MHz	
Main memory	 5MMSDR.0128-01 - 128 MB 5MMSDR.0256-01 - 256 MB 5MMSDR.0512-01 - 512 MB		 5MMDDR.0256-00 - 256 MB 5MMDDR.0512-00 - 512 MB 5MMDDR.1024-00 - 1 GB	
Heat sink	 5AC600.HS01-00 5AC600.HS02-01 <sup>2)</sup> 5AC600.HS02-02 <sup>2)</sup>		 5AC600.HS01-01 5AC600.HS01-02 <sup>1)</sup> 5AC600.HS02-01 <sup>2)</sup> 5AC600.HS02-02 <sup>1)2)</sup>	
1) Is required when using 855GME CPU boards 5PC600.E855-01 / 5PC600.X855-01 and 5PC600.E855-03 / 5PC600.X855-03. 2) Is required when using system unit 5PC600.SF03-00.				

Figure 4: Selection guide - APC620 basic system with 1, 2, 3, and 5 PCI slots

Explanation:

- 1) Select a system unit.
- 2) System selection - Choose a CPU board variant (815E - ETX or 855GME - ETX / XTX).
- 3) Select one each of main memory and heat sink, based on selected CPU board.
- 4) Select optional components, based on selected system unit (see section 1.2.2 "Selection guide - Optional components", on page 57).



1.2.2 Selection guide - Optional components

















Configuration - optional	
System unit	Select 1
<p>The system unit consists of the housing and base board.</p> <p>Variants:</p> <p>PCI slots (1,2, 3 or 5)</p> <p>Slide-in slots (0,1 or 2)</p> <p>AP Link slots (0 or 1)</p> <p>Example 2 / 1 / 1 = 2 PCI, 1 slide-in, 1 AP Link</p>	 5PC600.SX01-00 (1/0/0)  5PC600.SX02-01 (2/1/0) 5PC600.SX02-00 (2/1/1)  5PC600.SF03-00 (3/1/1)  5PC600.SX05-01 (5/2/0) 5PC600.SX05-00 (5/2/1)
Fan kit (select 1)	
A fan kit may be required for some system configurations	 5PC600.FA01-00  5PC600.FA02-00  5PC600.FA03-00  5PC600.FA05-00
Add-on drive	Select 1
	5AC600.SSDI-00 (128 GB SSD) 5AC600.HDDI-05 (40 GB HDD - 24x7 operation and extended temp. range) 5AC600.CFSI-00 (CompactFlash slot)
Slide-in drives	not possible   Select max. 1   Select max. 2
	5AC600.CFSS-00 (2 CompactFlash slots) 5AC600.CDXS-00 (CD-ROM) 5AC600.DVDS-00 (DVD-ROM/CD-RW) 5AC600.DVRS-00 (DVD-R/RW DVD+R/RW) 5AC600.FDDS-00 (USB Floppy) 5AC600.HDDS-02 (40 GB HDD - 24x7 hours and extended temperature range)
AP Link insert cards	not possible   Select 1
 for a second graphics line	5AC600.SDL0-00 Only possible when using a 5PC600.SX02-00, 5PC600.SX05-00 or 5PC600.SF03-00 together with an 855GME CPU board.
RAID system	Select 1
	5ACPCI.RAIC-03 (occupies 1 PCI Slot) 5ACPCI.RAIC-05 (occupies 1 PCI Slot)
Optional interface	Select 1
	5AC600.CANI-00 (CAN) 5AC600.485I-00 (combined RS232/RS422/RS485)
UPS module	Select 1
	5AC600.UPSI-00 (Add-on UPS modul) Can only be installed starting with the following system unit revisions: 5PC600.SX01-00 Rev. H0, 5PC600.SX02 Rev. G0, 5PC600.SX02-01 Rev. H0, 5PC600.SX05-00 Rev. F0, 5PC600.SX05-01 Rev. F0
SRAM module	Select 1
	5AC600.SRAM-00 (Add-On SRAM Modul 512kB) Can only be installed starting with the following system unit revisions: 5PC600.SX01-00 Rev. I0, 5PC600.SX02 Rev. H0, 5PC600.SX02-01 Rev. K0, 5PC600.SX05-00 Rev. H0, 5PC600.SX05-01 Rev. H0
Supply voltage plugs	Select 1
	OTB103.9 (screw clamp) OTB103.91 (cage clamp)

Figure 5: Selection guide - APC620 optional components with 1, 2, 3, and 5 PCI slots

### Information:

- Depending on the system unit, a compatible fan kit can be installed in the APC620. Required for certain system configurations and ambient temperatures (see also sections 2.6 "Ambient temperatures for systems with an 815E CPU board (ETX)", on page 89 and 2.7 "Ambient temperatures for systems with an 855GME CPU board (ETX / XTX)", on page 93).
- Select optional drive(s) (add-on / slide-in), based on the system unit. One add-on drive can be installed in each system unit. Slide-in drives (1 or 2) are only available in certain system units.
- AP Link cards create a second graphics line (possibility of extended desktop or display clone operation) on the APC620. Only possible with system units 5PC600.SX02-00, 5PC600.SX05-00, 5PC600.SF03-00 and with an 855GME CPU board.
- An add-on interface adds an optional connection possibility.
- Depending on the revision of the system unit (see graphic), an optional integrated UPS add-on module can be installed.
- Depending on the revision of the system unit (see graphic), an optional integrated SRAM module (battery backed) can be installed.
- The appropriate power supply plugs ensure simple connection to the power supply.

### 1.3 Structure / configuration APC620 embedded

The following components are absolutely essential for operation: System unit, CPU board, main memory and heat sink.







Configuration - APC620 embedded base system	
System unit	Select 1
	5PC600.SE00-00 - SDL - 512 kB SRAM 5PC600.SE00-01 - CRT 512 kB SRAM 5PC600.SE00-02 - SDL 1 MB SRAM
CPU board - main memory - heat sink, choose 1 of each component	
855GME CPU board (XTX)	
	5PC600.X855-00 - PM 1100 MHz 5PC600.X855-02 - PM 1400 MHz 5PC600.X855-04 - CM 600 MHz 5PC600.X855-05 - CM 1000 MHz
Main memory	↓
	5MMDDR.0256-00 - 256 MB 5MMDDR.0512-00 - 512 MB 5MMDDR.1024-00 - 1 GB
Heat sink	↓
	5AC600.HS03-01
Configuration - optional APC620 embedded	
UPS module	
	5AC600.UPSI-00 (Add-on UPS module)
Supply voltage connector	Select 1
	0TB103.9 (screw clamp) 0TB103.91 (cage clamp)

Figure 6: Selection guide - Basic system and optional components APC620 embedded

Explanation:

- 1) Select a system unit.
- 2) Select CPU board (select 1).
- 3) Select main memory and heat sink (selection 1 each).
- 4) Select optional components.

## 2. Entire device

### 2.1 APC620, 1 PCI slot variant

#### 2.1.1 Interfaces

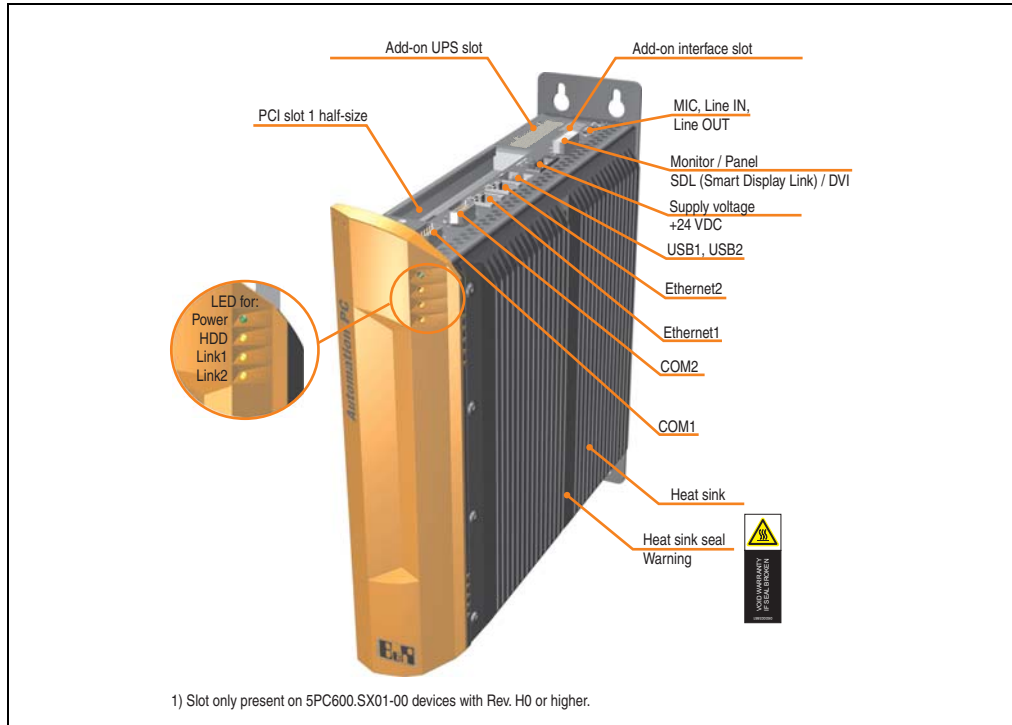

Figure 7: Interface overview - APC620, 1 PCI slot variant (top)

## Warning!

Do not remove the mounting screws from the heat sink, as it is connected to the processor and chipset by a thermal coupling. Should this connection be broken, the APC620 must be sent for repair. Removal of the mounting screws, which can be determined by a broken seal, voids all warranty.

During operation, surface temperatures of the heat sink may reach 70°C (warning "hot surface").

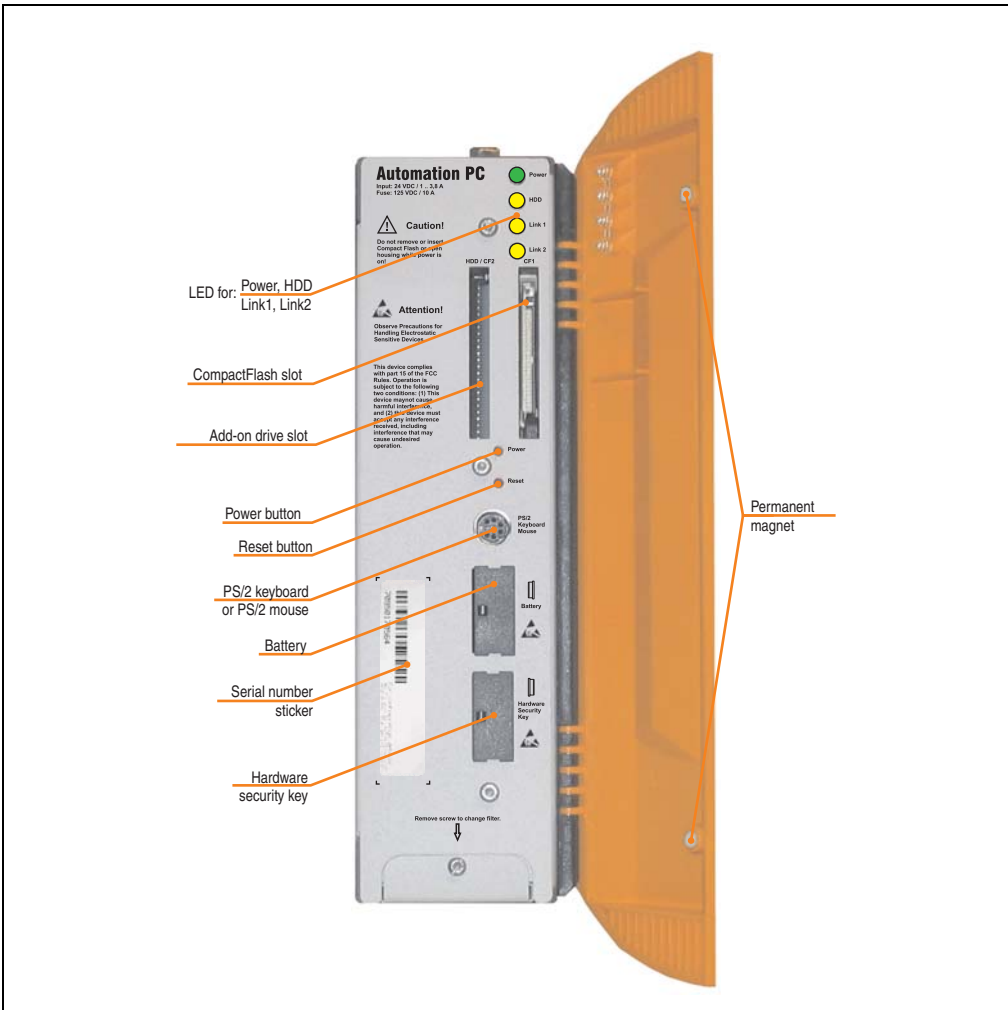

Figure 8: Interface overview - APC620, 1 PCI slot variant (front)

## Information:

The orange front doors contain two permanent magnets. Contact between a data carrier that saves data magnetically (hard disk, diskette, the magnetic strip of a credit card, etc.) and a magnet can cause loss of data.

2.1.2 Technical data

Features	APC620, 1 PCI slot variant
B&R ID code	Component-dependent, see 3.1 "System units", on page 174
Boot loader / Operating system	BIOS / see the chapter 4 "Software", on page 371
Processor	Component-dependent, see technical data for the CPU board
Cooling Method	Passive via heat sink and optionally supported with an active fan kit
Main memory	max. 512 MB with 815E CPU board, max. 1 GB with 855GME CPU board
Graphics Controller	Component-dependent, see technical data for the CPU board
Power failure logic Controller	MTCX <sup>1)</sup> (see also page 793)
Buffer time	10 ms, dependent on the system unit revision (see page 564)
Real-time clock	Yes
Battery-buffered Accuracy	Component-dependent, see technical data for the CPU board
Battery Type	See also page 158 Renata 950 mAh
Removable Lifespan	Yes, accessible behind the orange cover 4 years <sup>2) 3)</sup>
Ethernet Controller	See also page 130 or page 132
Amount	2
CAN bus	Optional using add-on interface (5AC600.CANI-00)
CompactFlash Type	See also page 152 or page 153 Type I
Amount	1 (max. 4 using optional components)
Serial interface	See also page 123 or page 124
Amount	2
Type	RS232, modem-capable, not electrically isolated
UART	16550 compatible, 16 byte FIFO
Transfer rate	Max. 115 kBaud
Connection	9-pin DSUB
USB interface	See also section "USB port", on page 133
Type	USB 2.0
Amount	2
Transfer rate	Low speed (1.5 MBit/s), full speed (12 MBit/s), to high speed (480 Mbit/s)
Connection	Type A
Current load	Max. 500 mA per connection
Reset button	Yes, accessible behind the orange cover
LEDs	4 directed outwards via fiber optic lines, also see section "Status LEDs", on page 150
PCI slots	See also section "PCI slots", on page 147
half-size	1
full-size	-
Add-on UPS internal slot	Yes 5PC600.SX01-00 starting with revision H0 See also section "Add-on UPS module slot", on page 146

Table 24: Technical data - APC620, 1 PCI slot variant

## Technical Data • Entire device

Features	APC620, 1 PCI slot variant
SRAM internal slot options	Yes 5PC600.SX01-00 starting with revision I0
Electrical characteristics	
Power supply	
Rated voltage	24 VDC ±25%
Rated current	3.8 A
Starting current	Typ. 7 A, max. 40 A for < 300 µs
Power consumption	Component-dependent, see section 2.8 "Power management APC620 system unit with 1 PCI slot"
Mechanical characteristics	
Housing <sup>4)</sup>	
Item	Galvanized plate, plastic
Paint	Light gray (similar to Pantone 427CV), dark gray (similar to Pantone 432CV)
Front cover	Colored orange plastic (similar to Pantone 144CV)
Outer dimensions	See "Dimensions", on page 65
Weight	Approx. 3.4 kg (component-dependent)
Environmental characteristics	
Ambient temperature	
Operation	Component-dependent, see the section about ambient temperature on page 89 and page 93
Bearings	-20 to 60°C
Transport	-20 to 60°C
Relative humidity	
Operation	Component-dependent, see section "Humidity specifications", on page 119
Bearings	Component-dependent, see section "Humidity specifications", on page 119
Transport	Component-dependent, see section "Humidity specifications", on page 119
Vibration <sup>5)</sup>	
Operation (continuous)	2 - 9 Hz: 1.75 mm amplitude / 9 - 200 Hz: 0.5 g
Operation (occasional)	2 - 9 Hz: 3.5 mm amplitude / 9 - 200 Hz: 1 g
Bearings	2 - 8 Hz: 7.5 mm amplitude / 8 - 200 Hz: 2 g / 200 - 500 Hz: 4 g
Transport	2 - 8 Hz: 7.5 mm amplitude / 8 - 200 Hz: 2 g / 200 - 500 Hz: 4 g
Shock <sup>3)</sup>	
Operation	15 g, 11 ms
Bearings	30 g, 15 ms
Transport	30 g, 15 ms
Protection type	IP20
Altitude	
Operation	max. 3000 m <sup>6)</sup> (component-dependent)
Electromagnetic compatibility	
Emissions	
Network-related emissions	EN 61000-6-4, EN 55022 A
Emissions	EN 61000-6-4, EN 55011 class A, EN 55022 class A, EN 61131-2, 47 CFR Part 15

Table 24: Technical data - APC620, 1 PCI slot variant (Forts.)

## Technical Data • Entire device

Electromagnetic compatibility	APC620, 1 PCI slot variant
Immunity Electrostatic discharge (ESD) High-frequency electromagnetic fields High-speed transient disturbances (Burst) Surges Conducted values Magnetic fields with electrical frequencies Voltage dips, interruptions Damped vibration	EN 61000-6-2, EN 61131-2, EN 55024 EN 61000-6-2, EN 61131-2, EN 55024 EN 61000-6-2, EN 61131-2, EN 55024 EN 61000-6-2, EN 61131-2, EN 55024 EN 61000-6-2, EN 61131-2, EN 55024 EN 61000-6-2, EN 61131-2, EN 55024 EN 61000-6-2, EN 61131-2, EN 55024

Table 24: Technical data - APC620, 1 PCI slot variant (Forts.)

- 1) Maintenance controller extended.
- 2) At 50°C, 8.5 µA of the supplied components and a self discharge of 40%.
- 3) If an SRAM module (Mod. No. 5AC600.SRAM-00) is installed, the buffer duration is 2½ years.
- 4) Depending on the process or batch, there may be visible deviations in the color and surface structure.
- 5) Maximum values, as long as no other individual component specifies any other.
- 6) Derating the maximum ambient temperature - typically 1°C per 1000 meters (from 500 meters above sea level).



2.1.3 Dimensions

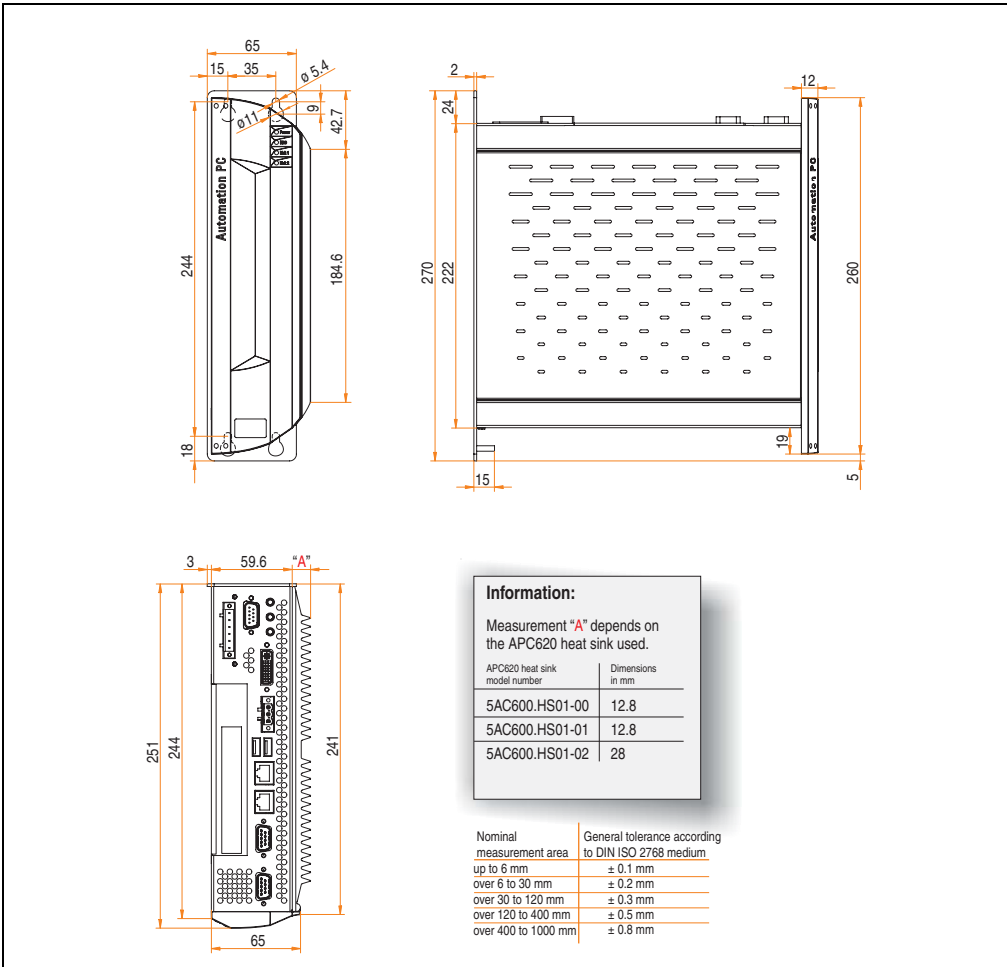

Figure 9: Dimensions - APC620, 1 PCI slot variant

## 2.2 APC620, 2 PCI slot variant

### 2.2.1 Interfaces

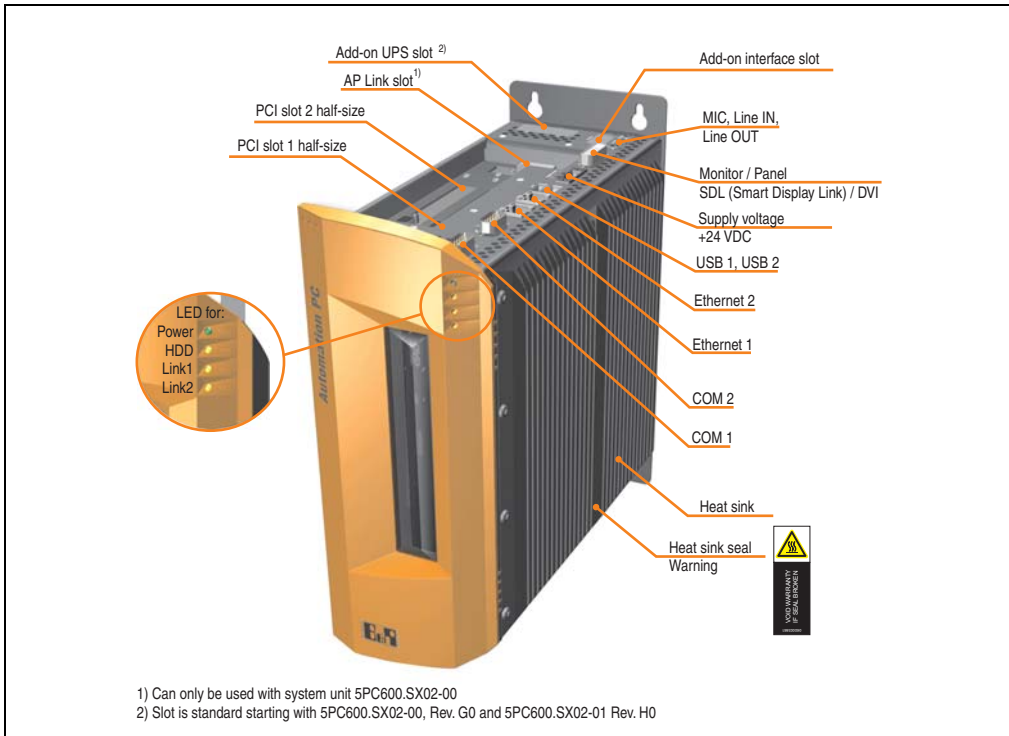
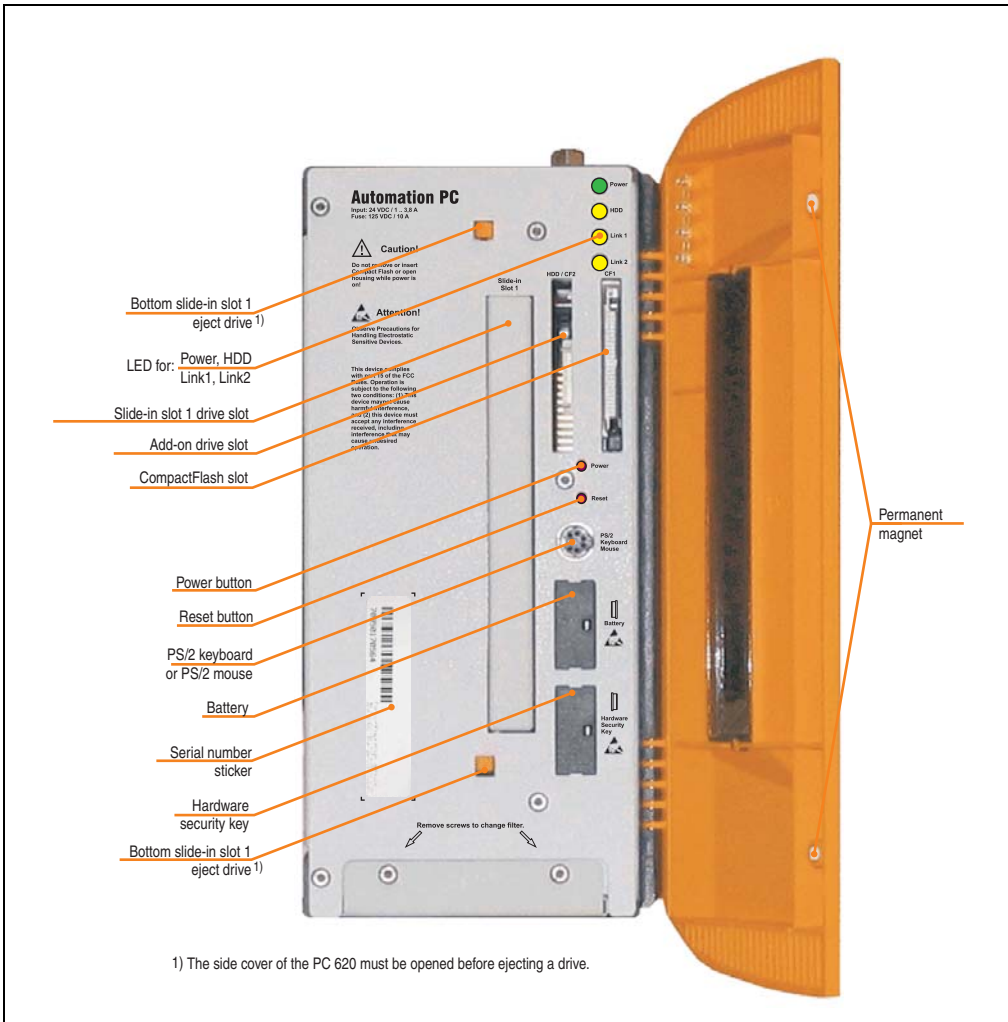

Figure 10: Interface overview - APC620, 2 PCI slot variant (top)

## Warning!

Do not remove mounting screws from the heat sink, as it is connected to the processor and chipset by a thermal coupling. Should this connection be broken, the APC620 must be sent for repair. Removal of the mounting screws, which can be determined by a broken seal, voids all warranty.

During operation, surface temperatures of the heat sink may reach 70°C (warning "hot surface").



1) The side cover of the PC 620 must be opened before ejecting a drive.

Figure 11: Interface overview - APC620, 2 PCI slot variant (front)

## Information:

The orange front doors contain two permanent magnets. Contact between a data carrier that saves data magnetically (hard disk, diskette, the magnetic strip of a credit card, etc.) and a magnet can cause loss of data.

2.2.2 Technical data

Features	APC620, 2 PCI slot variant
B&R ID code	Component-dependent, see 3.1 "System units", on page 174
Boot loader / Operating system	BIOS / see the chapter 4 "Software", on page 371
Processor	Component-dependent, see technical data for the CPU board
Cooling Method	Passive via heat sink and optionally supported with an active fan kit
Main memory	Max. 512 MB with 815E CPU board, max. 1 GB with 855GME CPU board
Graphics Controller	Component-dependent, see technical data for the CPU board
Power failure logic Controller	MTCX <sup>1)</sup> (see also page 793)
Buffer time	10 ms, dependent on the system unit revision (see page 564)
Real-time clock	Yes
Battery-buffered Accuracy	Component-dependent, see technical data for the CPU board
Battery Type	See also page 158 Renata 950 mAh
Removable Lifespan	Yes, accessible behind the orange cover 4 years <sup>2) 3)</sup>
Ethernet Controller	See also page 130 or page 132
Amount	2
CAN bus	Optional using add-on interface (5AC600.CANI-00)
CompactFlash Type	See also page 152 or page 153 Type I
Amount	2 (max. 4 using optional components)
Serial interface	See also page 123 or page 124
Amount	2
Type	RS232, modem-capable, not electrically isolated
UART	16550 compatible, 16 byte FIFO
Transfer rate	Max. 115 kBaud
Connection	9-pin DSUB
USB interface	See also section "USB port", on page 133
Type	USB 2.0
Amount	2
Transfer rate	Low speed (1.5 MBit/s), full speed (12 MBit/s), to high speed (480 Mbit/s)
Connection	Type A
Current load	Max. 500 mA per connection
Reset button	Yes, accessible behind the orange cover
LEDs	4 directed outwards via fiber optic lines, also see section "Status LEDs", on page 150
PCI slots	See also section "PCI slots", on page 147
half-size	2
full-size	-
Add-on UPS internal slot	Yes 5PC600.SX02-00 starting with revision G0, 5PC600.SX02-01 starting with revision H0 present See also section "Add-on UPS module slot", on page 146

Table 25: Technical data - APC620, 2 PCI slot variant

## Technical Data • Entire device

Features	APC620, 2 PCI slot variant
SRAM internal slot options	Yes 5PC600.SX02-00 starting with revision H0, 5PC600.SX02-01 starting with revision K0 present
Electrical characteristics	
Power supply	
Rated voltage	24 VDC ±25%
Rated current	3.8 A
Starting current	Typ. 7 A, max. 40 A for < 300 µs
Power consumption	Component-dependent, see section 2.8 "Power management APC620 system unit with 1 PCI slot"
Mechanical characteristics	
Housing <sup>4)</sup>	
Item	Galvanized plate, plastic
Paint	Light gray (similar to Pantone 427CV), dark gray (similar to Pantone 432CV)
Front cover	Colored orange plastic (similar to Pantone 144CV)
Outer dimensions	See "Dimensions", on page 71
Weight	Approx. 4.5 kg (component-dependent)
Environmental characteristics	
Ambient temperature	
Operation	Component-dependent, see the section about ambient temperature on page 89 and page 93
Bearings	-20 to 60°C
Transport	-20 to 60°C
Relative humidity	
Operation	Component-dependent, see section "Humidity specifications", on page 119
Bearings	Component-dependent, see section "Humidity specifications", on page 119
Transport	Component-dependent, see section "Humidity specifications", on page 119
Vibration <sup>5)</sup>	
Operation (continuous)	2 - 9 Hz: 1.75 mm amplitude / 9 - 200 Hz: 0.5 g
Operation (occasional)	2 - 9 Hz: 3.5 mm amplitude / 9 - 200 Hz: 1 g
Bearings	2 - 8 Hz: 7.5 mm amplitude / 8 - 200 Hz: 2 g / 200 - 500 Hz: 4 g
Transport	2 - 8 Hz: 7.5 mm amplitude / 8 - 200 Hz: 2 g / 200 - 500 Hz: 4 g
Shock <sup>3)</sup>	
Operation	15 g, 11 ms
Bearings	30 g, 15 ms
Transport	30 g, 15 ms
Protection type	IP20
Altitude	
Operation	max. 3000 m <sup>6)</sup> (component-dependent)
Electromagnetic compatibility	
Emissions	
Network-related emissions	EN 61000-6-4, EN 55022 A
Emissions	EN 61000-6-4, EN 55011 class A, EN 55022 class A, EN 61131-2, 47 CFR Part 15

Table 25: Technical data - APC620, 2 PCI slot variant (Forts.)

## Technical Data • Entire device

Electromagnetic compatibility	APC620, 2 PCI slot variant
Immunity Electrostatic discharge (ESD) High-frequency electromagnetic fields High-speed transient disturbances (Burst) Surges Conducted values Magnetic fields with electrical frequencies Voltage dips, interruptions Damped vibration	EN 61000-6-2, EN 61131-2, EN 55024 EN 61000-6-2, EN 61131-2, EN 55024 EN 61000-6-2, EN 61131-2, EN 55024 EN 61000-6-2, EN 61131-2, EN 55024 EN 61000-6-2, EN 61131-2, EN 55024 EN 61000-6-2, EN 61131-2, EN 55024 EN 61000-6-2, EN 61131-2, EN 55024

Table 25: Technical data - APC620, 2 PCI slot variant (Forts.)

- 1) Maintenance controller extended.
- 2) At 50°C, 8.5 µA of the supplied components and a self discharge of 40%.
- 3) If an SRAM module (Mod. No. 5AC600.SRAM-00) is installed, the buffer duration is 2½ years.
- 4) Depending on the process or batch, there may be visible deviations in the color and surface structure.
- 5) Maximum values, as long as no other individual component specifies any other.
- 6) Derating the maximum ambient temperature - typically 1°C per 1000 meters (from 500 meters above sea level).

2.2.3 Dimensions

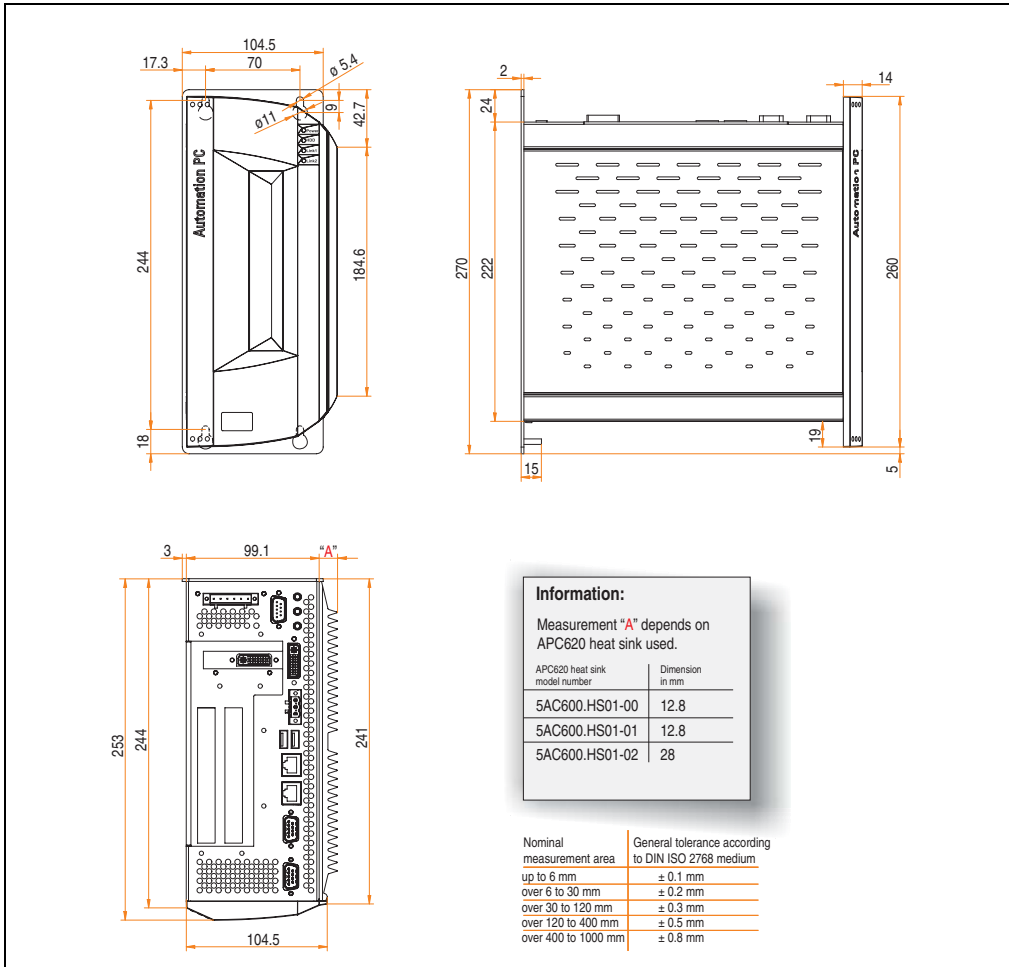

Figure 12: Dimensions - APC620, 2 PCI slot variant

## 2.3 APC620, 3 PCI slot variant

### 2.3.1 Interfaces



Figure 13: Interface overview - APC620, 3 PCI slot variant (top)

## Warning!

Do not remove mounting screws from the heat sink, as it is connected to the processor and chipset by a thermal coupling. Should this connection be broken, the APC620 must be sent for repair. Removal of the mounting screws, which can be determined by a broken seal, voids all warranty.

During operation, surface temperatures of the heat sink may reach 70°C (warning "hot surface").





Figure 14: Interface overview - APC620, 3 PCI slot variant (front)

## Information:

The orange front doors contain three permanent magnets. Contact between a data carrier that saves data magnetically (hard disk, diskette, the magnetic strip of a credit card, etc.) and a magnet can cause loss of data.

2.3.2 Technical data

Features	APC620, 3 PCI slot variant
B&R ID code	Component-dependent, see 3.1 "System units", on page 174
Boot loader / Operating system	BIOS / see the chapter 4 "Software", on page 371
Processor	Component-dependent, see technical data for the CPU board
Cooling Method	Passive via heat sink and optionally supported with an active fan kit
Main memory	Max. 1 GB with 855GME CPU board
Graphics Controller	Component-dependent, see technical data for the CPU board
Power failure logic Controller	MTCX <sup>1)</sup> (see also page 793)
Buffer time	10 ms, dependent on the system unit revision (see page 564)
Real-time clock	Yes
Battery-buffered Accuracy	Component-dependent, see technical data for the CPU board
Battery Type	See also page 158 Renata 950 mAh
Removable	Yes, accessible behind the orange cover
Lifespan	4 years <sup>2) 3)</sup>
Ethernet Controller	See also page 130 or page 132
Amount	2
CAN bus	Optional using add-on interface (5AC600.CANI-00)
CompactFlash Type	See also page 152 or page 153 Type I
Amount	2 (max. 4 using optional components)
Serial interface Amount	See also page 123 or page 124 2
Type	RS232, modem-capable, not electrically isolated
UART	16550 compatible, 16 byte FIFO
Transfer rate	Max. 115 kBaud
Connection	9-pin DSUB
USB interface Type	See also section "USB port", on page 133 USB 2.0
Amount	2
Transfer rate	Low speed (1.5 MBit/s), full speed (12 MBit/s), to high speed (480 Mbit/s)
Connection	Type A
Current load	Max. 500 mA per connection
Reset button	Yes, accessible behind the orange cover
LEDs	4 directed outwards via fiber optic lines, also see section "Status LEDs", on page 150
PCI slots half-size	See also section "PCI slots", on page 147 -
full-size	3
Add-on UPS internal slot	Yes See also section "Add-on UPS module slot", on page 146
SRAM internal slot options	Yes

Table 26: Technical data - APC620, 3 PCI slot variant

Electrical characteristics	APC620, 3 PCI slot variant
Power supply Rated voltage Rated current Starting current Power consumption	24 VDC ±25% 5 A Typ. 10 A, max. 40 A for < 300 µs Component-dependent, see section 2.10 "Power management APC620 system unit with 3 PCI slots"
Mechanical characteristics	
Housing <sup>4)</sup> Item Paint Front cover	Galvanized plate, plastic Light gray (similar to Pantone 427CV), dark gray (similar to Pantone 432CV) Colored orange plastic (similar to Pantone 144CV)
Outer dimensions	See "Dimensions", on page 76
Weight	Approx. 4.5 kg (component-dependent)
Environmental characteristics	
Ambient temperature Operation Bearings Transport	Component-dependent, see the section about ambient temperature on page 93 -20 to +60°C -20 to +60°C
Relative humidity Operation Bearings Transport	Component-dependent, see section "Humidity specifications", on page 119 Component-dependent, see section "Humidity specifications", on page 119 Component-dependent, see section "Humidity specifications", on page 119
Vibration <sup>5)</sup> Operation (continuous) Operation (occasional) Bearings Transport	2 - 9 Hz: 1.75 mm amplitude / 9 - 200 Hz: 0.5 g 2 - 9 Hz: 3.5 mm amplitude / 9 - 200 Hz: 1 g 2 - 8 Hz: 7.5 mm amplitude / 8 - 200 Hz: 2 g / 200 - 500 Hz: 4 g 2 - 8 Hz: 7.5 mm amplitude / 8 - 200 Hz: 2 g / 200 - 500 Hz: 4 g
Shock <sup>5)</sup> Operation Bearings Transport	15 g, 11 ms 30 g, 15 ms 30 g, 15 ms
Protection type	IP20
Altitude Operation	max. 3000 m <sup>6)</sup> (component-dependent)
Electromagnetic compatibility	
Emissions Network-related emissions Emissions	EN 61000-6-4, EN 55022 A EN 61000-6-4, EN 55011 class A, EN 55022 class A, EN 61131-2, 47 CFR Part 15
Immunity Electrostatic discharge (ESD) High-frequency electromagnetic fields High-speed transient disturbances (Burst) Surges Conducted values Magnetic fields with electrical frequencies Voltage dips, interruptions Damped vibration	EN 61000-6-2, EN 61131-2, EN 55024 EN 61000-6-2, EN 61131-2, EN 55024 EN 61000-6-2, EN 61131-2, EN 55024 EN 61000-6-2, EN 61131-2, EN 55024 EN 61000-6-2, EN 61131-2, EN 55024 EN 61000-6-2, EN 61131-2, EN 55024 EN 61000-6-2, EN 61131-2, EN 55024

Table 26: Technical data - APC620, 3 PCI slot variant (Forts.)

1) Maintenance controller extended.

## Technical Data • Entire device

- 2) At 50°C, 8.5  $\mu$ A of the supplied components and a self discharge of 40%.
- 3) If an SRAM module (Mod. No. 5AC600.SRAM-00) is installed, the buffer duration is 2½ years.
- 4) Depending on the process or batch, there may be visible deviations in the color and surface structure.
- 5) Maximum values, as long as no other individual component specifies any other.
- 6) Derating the maximum ambient temperature - typically 1°C per 1000 meters (from 500 meters above sea level).

### 2.3.3 Dimensions

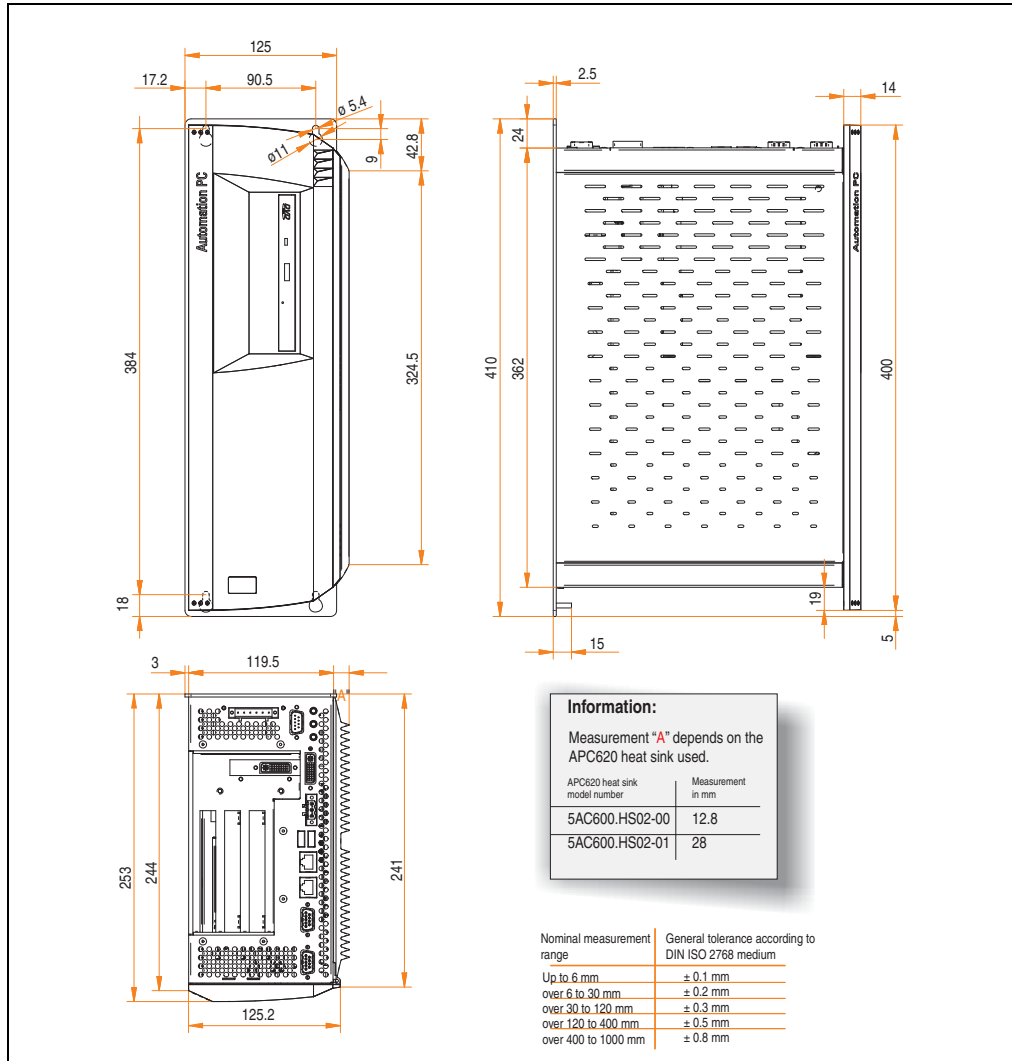

Figure 15: Dimensions - APC620, 3 PCI slot variant

## 2.4 APC620, 5 PCI slot variant

### 2.4.1 Interfaces

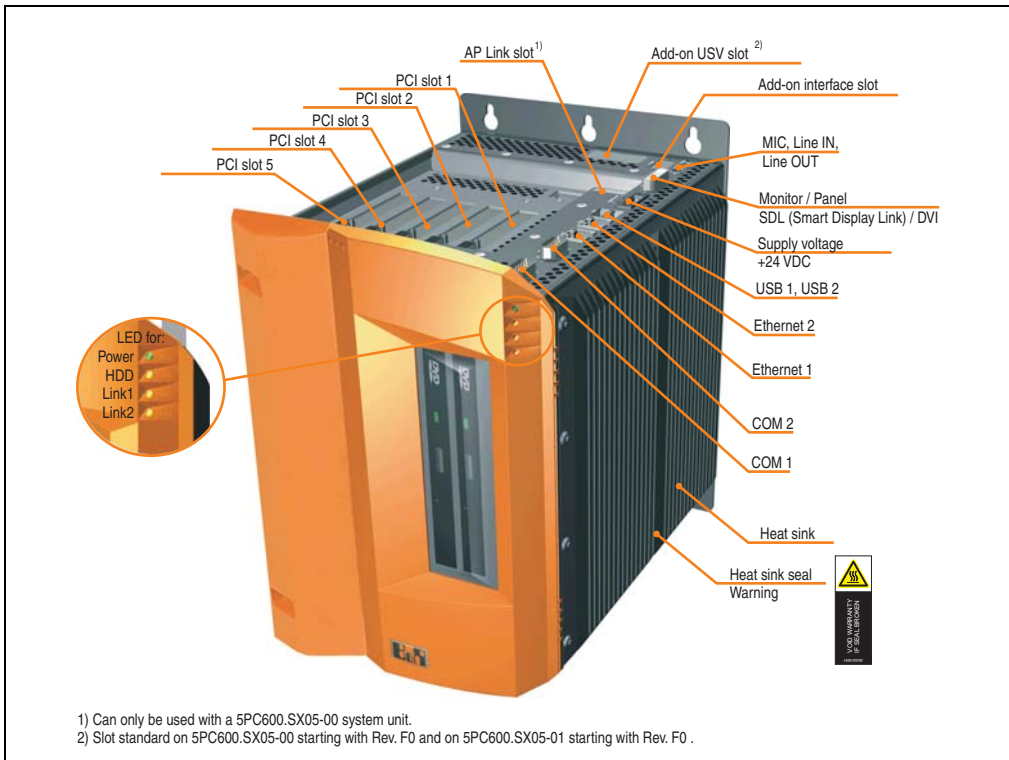

Figure 16: Interface overview - APC620, 5 PCI slot variant (top)

## Warning!

Do not remove the mounting screws from the heat sink, as it is connected to the processor and chipset by a thermal coupling. Should this connection be broken, the APC620 must be sent for repair. Removal of the mounting screws, which can be determined by a broken seal, voids all warranty.

During operation, surface temperatures of the heat sink may reach 70°C (warning "hot surface").

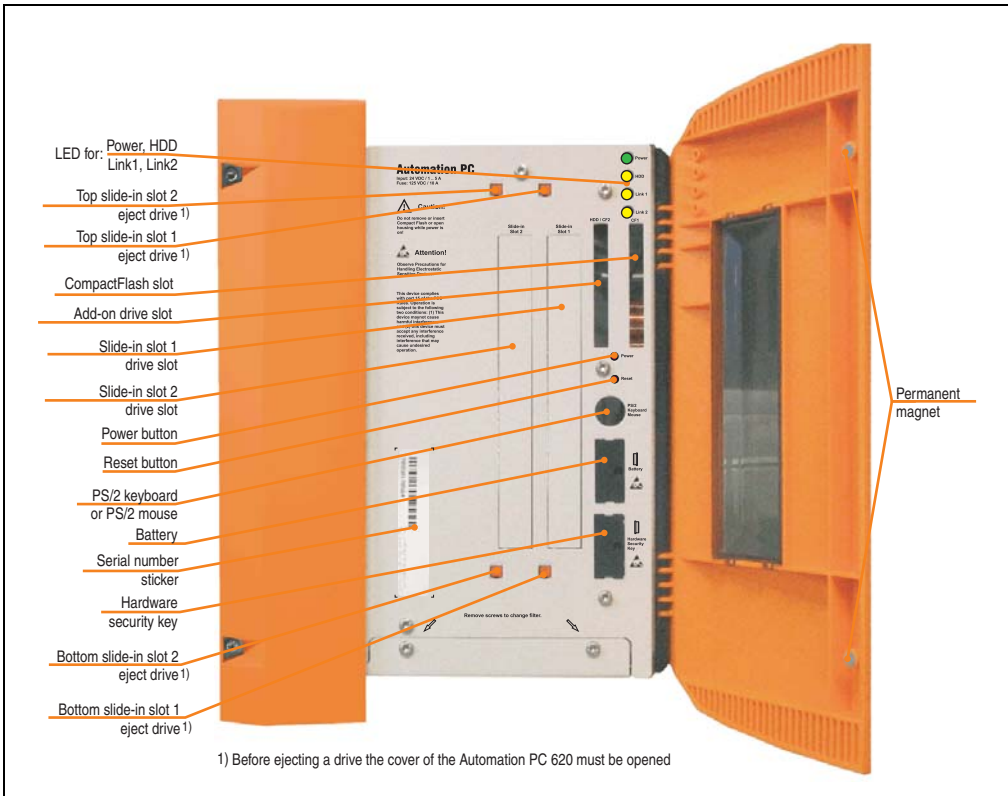

Figure 17: Interface overview - APC620, 5 PCI slot variant (front)

## Information:

The orange front doors contain two permanent magnets. Contact between a data carrier that saves data magnetically (hard disk, diskette, the magnetic strip of a credit card, etc.) and a magnet can cause loss of data.

2.4.2 Technical data

Features	APC620, 5 PCI slot variant
B&R ID code	Component-dependent, see 3.1 "System units", on page 174
Boot loader / Operating system	BIOS / see the chapter 4 "Software", on page 371
Processor	Component-dependent, see technical data for the CPU board
Cooling Method	Passive via heat sink and optionally supported with an active fan kit
Main memory	Max. 512 MB with 815E CPU board, max. 1 GB with 855GME CPU board
Graphics Controller	Component-dependent, see technical data for the CPU board
Power failure logic Controller	MTCX <sup>1)</sup> (see also page 793)
Buffer time	10 ms, dependent on the system unit revision (see page 564)
Real-time clock	Yes
Battery-buffered Accuracy	Component-dependent, see technical data for the CPU board
Battery Type	See also page 158 Renata 950 mAh
Removable Lifespan	Yes, accessible behind the orange cover 4 years <sup>2) 3)</sup>
Ethernet Controller	See also page 130 or page 132
Amount	2
CAN bus	Optional using add-on interface (5AC600.CANI-00)
CompactFlash Type	See also page 152 or page 153 Type I
Amount	2 (max. 4 using optional components)
Serial interface Amount	See also page 123 or page 124 2
Type	RS232, modem-capable, not electrically isolated
UART	16550 compatible, 16 byte FIFO
Transfer rate	Max. 115 kBaud
Connection	9-pin DSUB
USB interface Type	See also section "USB port", on page 133 USB 2.0
Amount	2
Transfer rate	Low speed (1.5 MBit/s), full speed (12 MBit/s), to high speed (480 Mbit/s)
Connection	Type A
Current load	Max. 500 mA per connection
Reset button	Yes, accessible behind the orange cover
LEDs	4 directed outwards via fiber optic lines, also see section "Status LEDs", on page 150
PCI slots half-size	See also section "PCI slots", on page 147 5
full-size	-
Add-on UPS internal slot	Yes 5PC600.SX05-00 starting with revision F0, 5PC600.SX05-01 starting with revision F0 present See also section "Add-on UPS module slot", on page 146

Table 27: Technical data - APC620, 5 PCI slot variant

## Technical Data • Entire device

Features	APC620, 5 PCI slot variant
SRAM internal slot options	Yes 5PC600.SX05-00 starting with revision H0, 5PC600.SX05-01 starting with revision H0 present
<b>Electrical characteristics</b>	
Power supply	
Rated voltage	24 VDC ±25%
Rated current	5 A
Starting current	Typ. 10 A, max. 40 A for < 300 µs
Power consumption	Component-dependent, see section 2.11 "Power management APC620 system units with 5 PCI slots"
<b>Mechanical characteristics</b>	
Housing <sup>4)</sup>	
Item	Galvanized plate, plastic
Paint	Light gray (similar to Pantone 427CV), dark gray (similar to Pantone 432CV)
Front cover	Colored orange plastic (similar to Pantone 144CV)
Outer dimensions	See "Dimensions", on page 82
Weight	Approx. 5.7 kg (component-dependent)
<b>Environmental characteristics</b>	
Ambient temperature	
Operation	Component-dependent, see the section about ambient temperature on page 89 and page 93
Bearings	-20 to 60°C
Transport	-20 to 60°C
Relative humidity	
Operation	Component-dependent, see section "Humidity specifications", on page 119
Bearings	Component-dependent, see section "Humidity specifications", on page 119
Transport	Component-dependent, see section "Humidity specifications", on page 119
Vibration <sup>5)</sup>	
Operation (continuous)	2 - 9 Hz: 1.75 mm amplitude / 9 - 200 Hz: 0.5 g
Operation (occasional)	2 - 9 Hz: 3.5 mm amplitude / 9 - 200 Hz: 1 g
Bearings	2 - 8 Hz: 7.5 mm amplitude / 8 - 200 Hz: 2 g / 200 - 500 Hz: 4 g
Transport	2 - 8 Hz: 7.5 mm amplitude / 8 - 200 Hz: 2 g / 200 - 500 Hz: 4 g
Shock <sup>6)</sup>	
Operation	15 g, 11 ms
Bearings	30 g, 15 ms
Transport	30 g, 15 ms
Protection type	IP20
Altitude	
Operation	max. 3000 m <sup>6)</sup> (component-dependent)
<b>Electromagnetic compatibility</b>	
Emissions	
Network-related emissions	EN 61000-6-4, EN 55022 A
Emissions	EN 61000-6-4, EN 55011 class A, EN 55022 class A, EN 61131-2, 47 CFR Part 15

Table 27: Technical data - APC620, 5 PCI slot variant (Forts.)



Electromagnetic compatibility	APC620, 5 PCI slot variant
Immunity	
Electrostatic discharge (ESD)	EN 61000-6-2, EN 61131-2, EN 55024
High-frequency electromagnetic fields	EN 61000-6-2, EN 61131-2, EN 55024
High-speed transient disturbances (Burst)	EN 61000-6-2, EN 61131-2, EN 55024
Surges	EN 61000-6-2, EN 61131-2, EN 55024
Conducted values	EN 61000-6-2, EN 61131-2, EN 55024
Magnetic fields with electrical frequencies	EN 61000-6-2, EN 61131-2, EN 55024
Voltage dips, interruptions	EN 61000-6-2, EN 61131-2, EN 55024
Damped vibration	EN 61000-6-2, EN 61131-2, EN 55024

Table 27: Technical data - APC620, 5 PCI slot variant (Forts.)

- 1) Maintenance controller extended.
- 2) At 50°C, 8.5 µA of the supplied components and a self discharge of 40%.
- 3) If an SRAM module (Mod. No. 5AC600.SRAM-00) is installed, the buffer duration is 2½ years.
- 4) Depending on the process or batch, there may be visible deviations in the color and surface structure.
- 5) Maximum values, as long as no other individual component specifies any other.
- 6) Derating the maximum ambient temperature - typically 1°C per 1000 meters (from 500 meters above sea level).

### 2.4.3 Dimensions

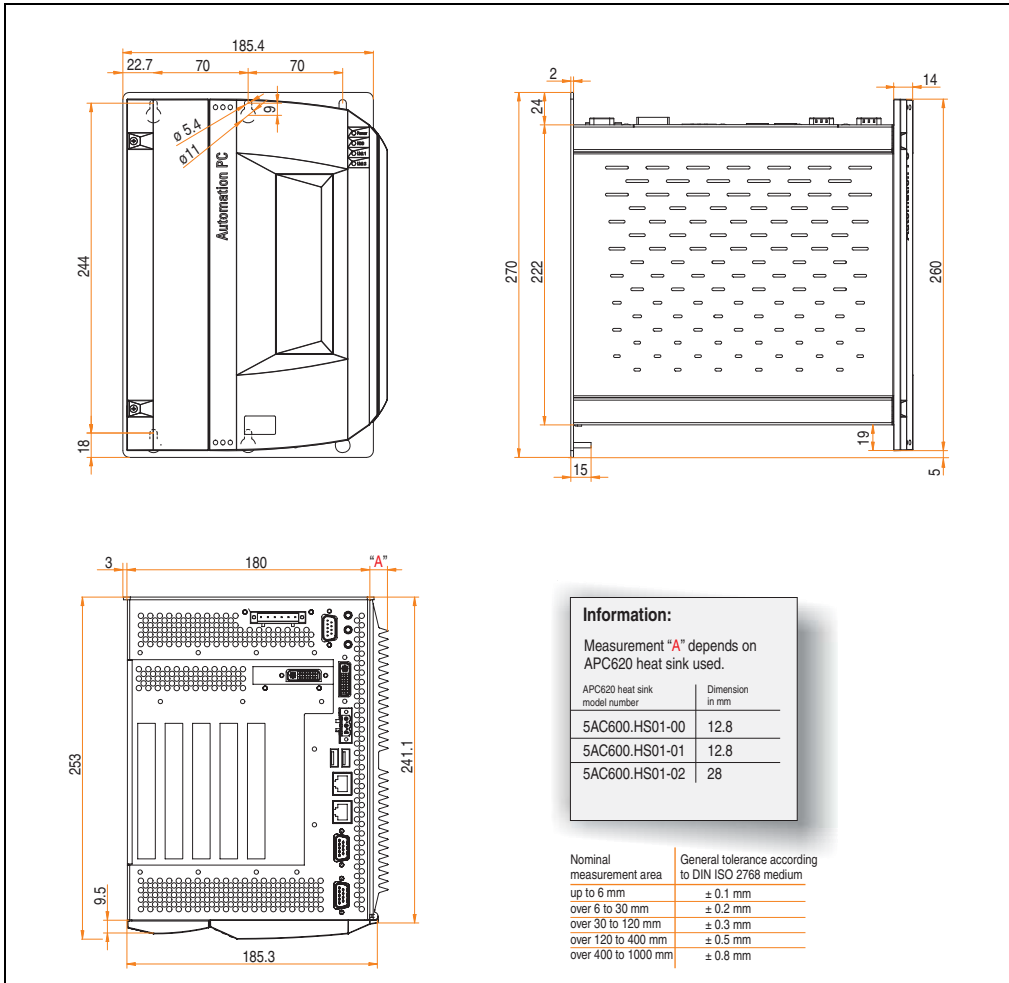

Figure 18: Dimensions - APC620, 5 PCI slot variant

## 2.5 APC620 embedded variant

### 2.5.1 Interfaces

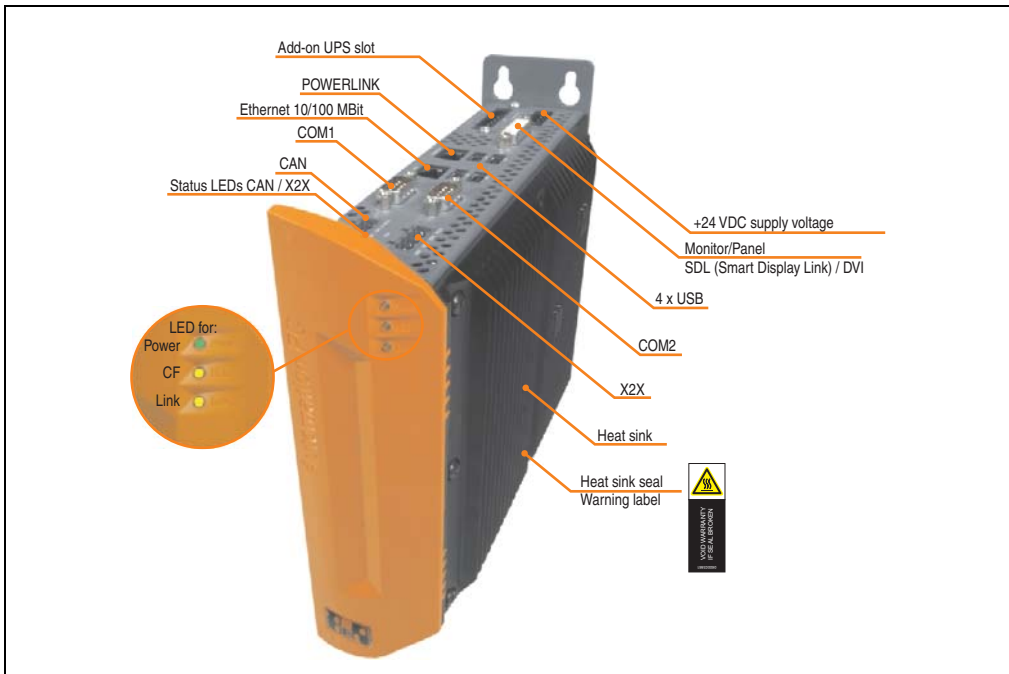

Figure 19: APC620 embedded variant interface overview - top side

## Warning!

Do not remove the mounting screws from the heat sink, as it is connected to the processor and chipset by a thermal coupling. Should this connection be broken, the APC620 embedded must be sent for repair. Removal of the mounting screws, which can be determined by a broken seal, voids all warranty.

During operation, surface temperatures of the heat sink may reach 70°C (warning "hot surface").

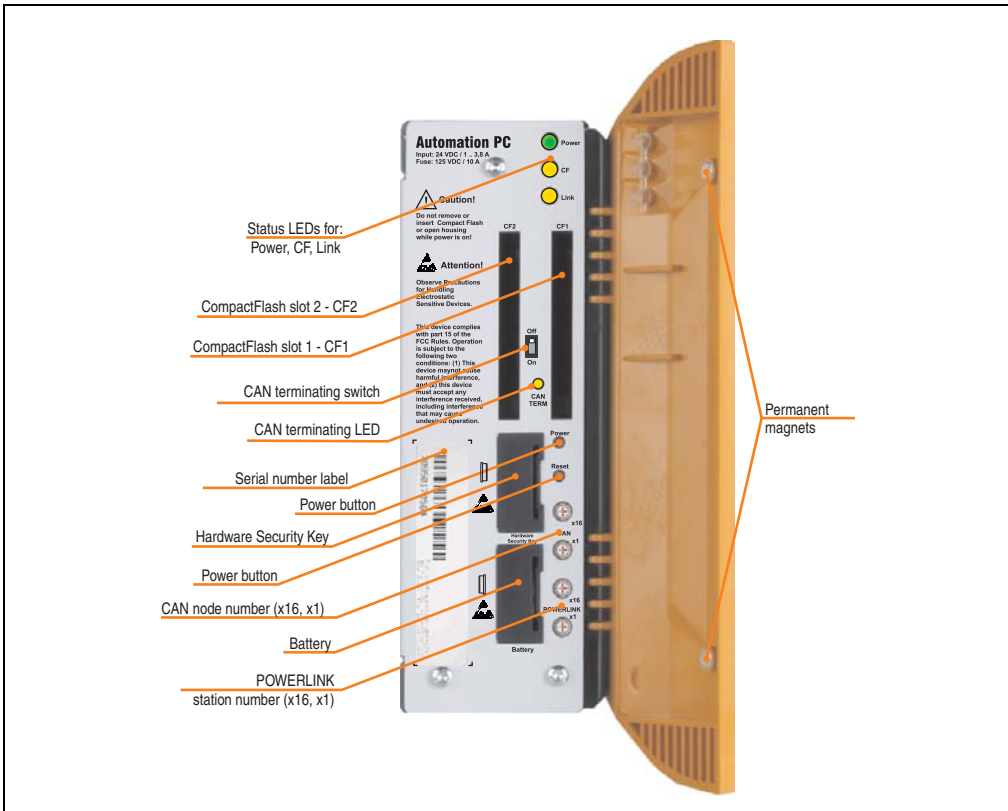

Figure 20: APC620 embedded variant interface overview - front side

## Information:

The orange front doors contain two permanent magnets. Contact between a data carrier that saves data magnetically (hard disk, diskette, the magnetic strip of a credit card, etc.) and a magnet can cause loss of data.

2.5.2 Technical data

Features	APC620 embedded variant
B&R ID code	Component-dependent, see 3.1 "System units", on page 174
Boot loader / Operating system	BIOS / see the chapter 4 "Software", on page 371
Processor	Component-dependent, see technical data for the CPU board
Cooling Method	Passive via heat sink
Main memory	Max. 1 GB with 855GME CPU board
Graphics Controller	Component-dependent, see technical data for the CPU board on page 183
Power failure logic Controller	MTCX <sup>1)</sup> (see also page 793)
Buffer time	10 ms, dependent on the system unit revision (see page 564)
Real-time clock	Yes
Battery-buffered Accuracy	Component-dependent, see technical data for the 855GME (XTX) CPU board
Battery Type	See also page 158 Renata 950 mAh
Removable Lifespan	Yes, accessible behind the orange cover 2½ years <sup>2)</sup>
Ethernet Controller	Yes
Amount	See also page 129 1
POWERLINK Amount	Yes, also see page 127 1
Station Number Dial	2 pcs.
X2X Link	Yes, also see page 125
Amount	1
Status LED	Yes, see page 127
CAN bus	See also page 125
Amount	1
Transfer rate	Max. 500 kBit/s
Node switch	Yes
Terminating resistor	Yes, can be activated using a switch
Status LED	Yes, see page 127
CompactFlash	See also page 155
Type	Type I
Amount	2
Serial interface	See also page 123 or page 124
Amount	2
Type	RS232, modem-capable, not electrically isolated
UART	16550-compatible, 16-byte FIFO
Transfer rate	Max. 115 kBaud
Connection	9-pin DSUB
USB interface	See also page 134
Type	USB 2.0
Amount	4
Transfer rate	Low speed (1.5 MBit/s), full speed (12 MBit/s), to high speed (480 Mbit/s)
Connection	Type A
Current load	Max. 500 mA or 1 A per connection

Table 28: Technical data - APC620 embedded variant

## Technical Data • Entire device

Features	APC620 embedded variant
Reset button	Yes, accessible behind the orange cover
LEDs	3 directed outwards via fiber optic lines, also see section "Status LEDs Power, CF, Link (only APC620 embedded)", on page 151
Add-on UPS slot	Yes
Electrical characteristics	
Power supply Rated voltage Rated current Starting current Power consumption	24 VDC $\pm$ 25% 3.8 A Typ. 7 A, max. 40 A for < 300 $\mu$ s Component-dependent, see section 2.12 "Power management for the APC620 embedded system unit"
Mechanical characteristics	
Housing <sup>3)</sup> Item Paint Front cover	Galvanized plate, plastic Light gray (similar to Pantone 427CV), dark gray (similar to Pantone 432CV) Colored orange plastic (similar to Pantone 144CV)
Outer dimensions	See "Dimensions", on page 88
Weight	Approx. 1.4 kg (component-dependent)
Environmental characteristics	
Ambient temperature Operation Bearings Transport	Component-dependent, see the section about ambient temperature on page 93 -20 to 60°C -20 to 60°C
Relative humidity Operation Bearings Transport	Component-dependent, see section "Humidity specifications", on page 119 Component-dependent, see section "Humidity specifications", on page 119 Component-dependent, see section "Humidity specifications", on page 119
Vibration <sup>4)</sup> Operation (continuous) Operation (occasional) Bearings Transport	2 - 9 Hz: 1.75 mm amplitude / 9 - 200 Hz: 0.5 g 2 - 9 Hz: 3.5 mm amplitude / 9 - 200 Hz: 1 g 2 - 8 Hz: 7.5 mm amplitude / 8 - 200 Hz: 2 g / 200 - 500 Hz: 4 g 2 - 8 Hz: 7.5 mm amplitude / 8 - 200 Hz: 2 g / 200 - 500 Hz: 4 g
Shock <sup>5)</sup> Operation Bearings Transport	15 g, 11 ms 30 g, 15 ms 30 g, 15 ms
Protection type	IP20
Altitude Operation	max. 3000 m <sup>5)</sup> (component-dependent)
Electromagnetic compatibility	
Emissions Network-related emissions Emissions	EN 61000-6-4, EN 55022 A EN 61000-6-4, EN 55011 class A, EN 55022 class A, EN 61131-2, 47 CFR Part 15

Table 28: Technical data - APC620 embedded variant (Forts.)

Electromagnetic compatibility	APC620 embedded variant
Immunity	
Electrostatic discharge (ESD)	EN 61000-6-2, EN 61131-2, EN 55024
High-frequency electromagnetic fields	EN 61000-6-2, EN 61131-2, EN 55024
High-speed transient disturbances (Burst)	EN 61000-6-2, EN 61131-2, EN 55024
Surges	EN 61000-6-2, EN 61131-2, EN 55024
Conducted values	EN 61000-6-2, EN 61131-2, EN 55024
Magnetic fields with electrical frequencies	EN 61000-6-2, EN 61131-2, EN 55024
Voltage dips, interruptions	EN 61000-6-2, EN 61131-2, EN 55024
Damped vibration	EN 61000-6-2, EN 61131-2, EN 55024

Table 28: Technical data - APC620 embedded variant (Forts.)

- 1) Maintenance controller extended.
- 2) At 50°C, 8.5 µA of the supplied components and a self discharge of 40%.
- 3) Depending on the process or batch, there may be visible deviations in the color and surface structure.
- 4) Maximum values, as long as no other individual component specifies any other.
- 5) Derating the maximum ambient temperature - typically 1°C per 1000 meters (from 500 meters above sea level).

2.5.3 Dimensions

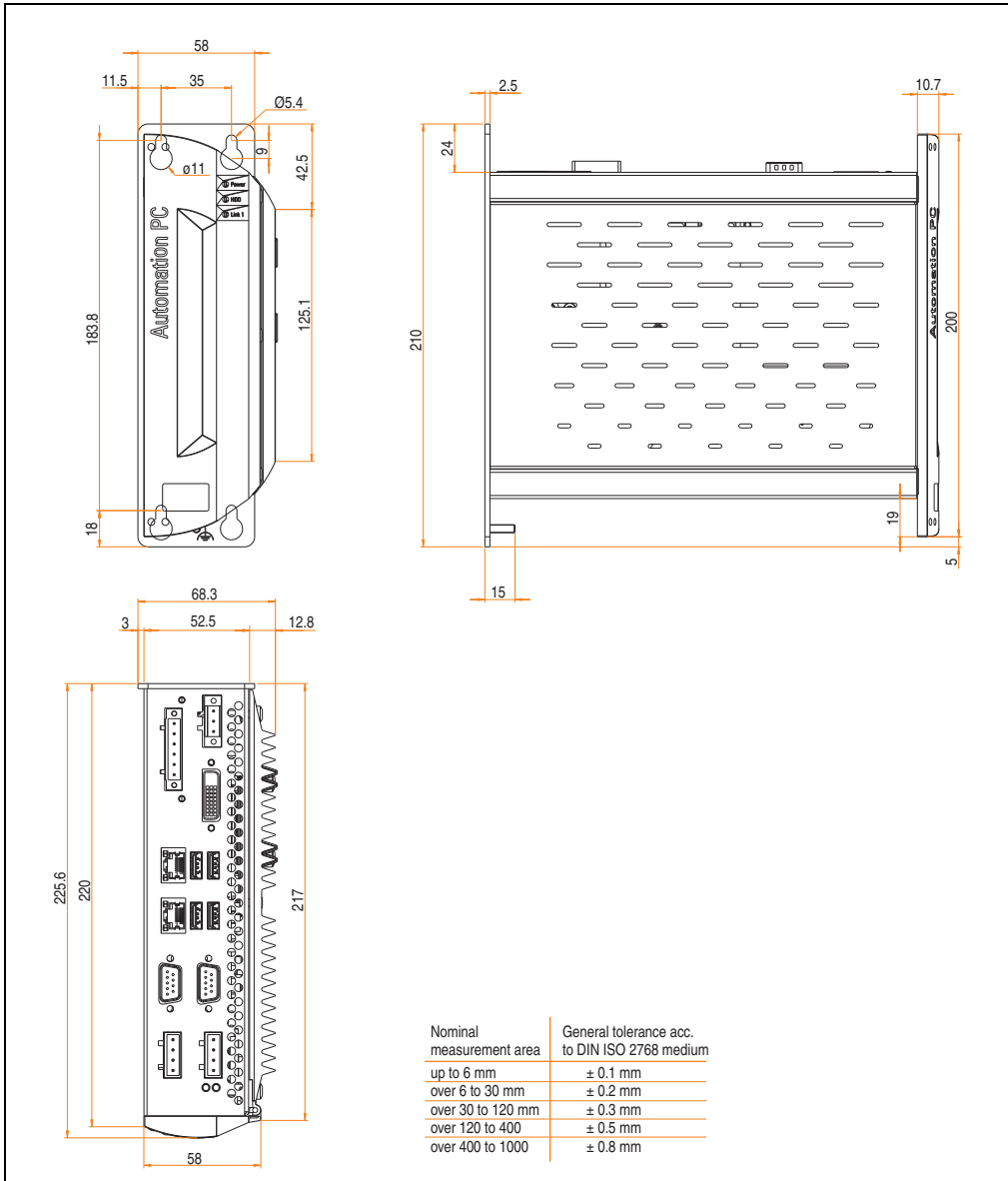

Figure 21: APC620 embedded variant - dimensions



## 2.6 Ambient temperatures for systems with an 815E CPU board (ETX)

It is possible to combine CPU boards with various other components, such as drives, main memory, additional insert cards, etc. dependent on system unit and fan kit. The various configurations result in varying maximum possible ambient temperatures, which can be seen in the following graphic (see figure 23 "Ambient temperatures for systems with an 815E CPU board (ETX)", on page 90).

### Information:

**The maximum specified ambient temperatures were determined under worst-case conditions.**

Experience has shown that higher ambient temperatures can be reached under typical conditions, e.g. using Microsoft Windows. The testing and evaluation is to be done on-site by the user (temperatures can be read in BIOS or using the B&R Control Center, see the chapter 4 "Software", on page 371).

#### Worst-case conditions for systems with an 815E CPU board (ETX)

- HiPower V3.0 from Intel for simulating 100% processor load.
- BurnIn testing tool (BurnIn V4.0 Pro from Passmark Software) to simulate a 100% load on the interface via loop-back adapters (serial interfaces, add-on and slide-in drives, USB interfaces, audio outputs).
- Maximum system extension and power consumption.

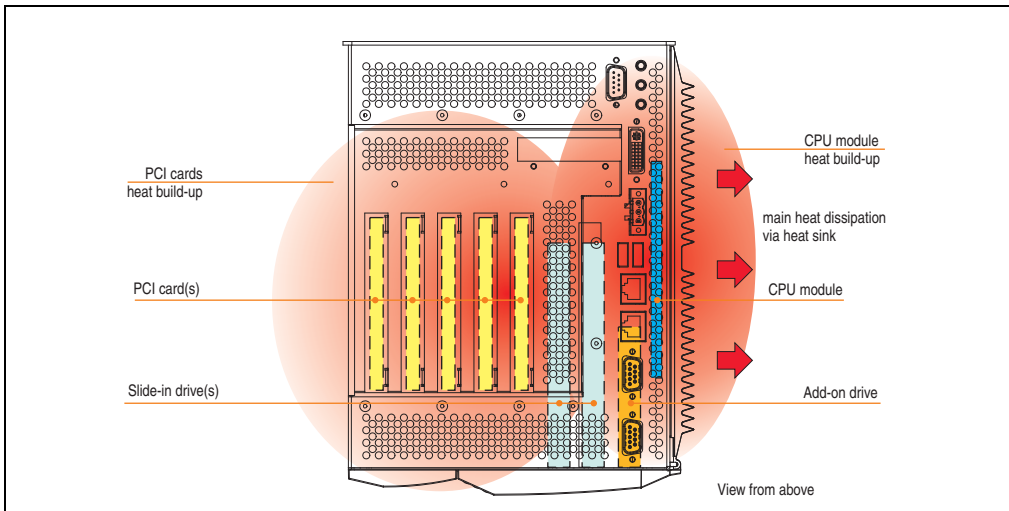



Figure 22: Example of worst-case conditions for temperature measurement

2.6.1 Maximum ambient temperature

All temperature values in degrees celsius (°C) at 500 meters above sea level.

Derating of the maximum ambient temperature, generally 1°C per 1000 meters starting at 500 meters above sea level.

		① 815E CPU board without fan kit and heat sink (5AC600.HS01-00)			① 815E CPU board with fan kit and heat sink (5AC600.HS01-00)				
		C3 400	C3 733	C3 1000	C3 400	C3 733	C3 1000		
		5PC600.EB15-00	5PC600.EB15-02	5PC600.EB15-03	5PC600.EB15-00	5PC600.EB15-02	5PC600.EB15-03		
② Max. environmental temperature		50	45	30	55	55	55		
What can still be operated at max. env. temp., and what limits are there?									
 									
Add-on drive	On-board CompactFlash <sup>1)</sup>	✓	✓	✓	✓	✓	✓		80
	5AC600.CFSI-00 <sup>1)</sup>	✓	✓	✓	✓	✓	✓		80
	5AC600.HDDI-01	✓	✓	✓	✓	✓	✓		80
	5AC600.HDDI-00 (24-hour / standard)	*/30	*/25	*/25				35/45	45/55
Slide-in drive	5AC600.CFSS-00 <sup>1)</sup>	✓	✓	✓	✓	✓	✓		80
	5AC600.CDXS-00	45	✓	✓	50	50	50		55
	5AC600.DVDS-00	35	35	✓	40	40	40		45
	5AC600.DVRS-00	35	35	✓	40	40	40		45
	5AC600.FDDS-00	35	35	✓	40	40	40		50
	5AC600.HDDS-01	✓	✓	✓	✓	✓	✓		80
	5AC600.HDDS-00 (24-hour / standard)	30/35	30/35	30/35	40/50	40/50	40/50		45/55
Main memory	5MMSDR.0128-01	✓	✓	✓	✓	✓	✓		-
	5MMSDR.0256-01	✓	✓	✓	✓	✓	✓		-
	5MMSDR.0512-01	✓	✓	✓	✓	✓	✓		-
System units	5PC600.SX01-00	✓	✓	✓	✓	✓	✓		95
	5PC600.SX02-01	✓	✓	✓	✓	✓	✓		95
	5PC600.SX02-00	✓	✓	✓	✓	✓	✓		95
	5PC600.SX05-01	✓	✓	✓	✓	✓	✓		95
	5PC600.SX05-00	✓	✓	✓	✓	✓	✓		95
Additional I/F cards	5AC600.CANI-00	✓	✓	✓	✓	✓	✓		-
	5AC600.485I-00	✓	✓	✓	✓	✓	✓		-
	5ACPCI.RAIS-00 (24-hour / standard)	30/35	30/35	30/35	40/50	40/50	40/50		-
	5ACPCI.RAIS-01 (24-hour / standard)	30/35	30/35	30/35	40/50	40/50	40/50		-

Temperature monitored by sensor(s) in these locations

I/O

Slide-in drive 1 and 2

Power supply

① Only possible with a CompactFlash card 5CFCRD.xxxx-06, 5CFCRD.xxxx-04 or 5CFCRD.xxxx-03 from B&R

Figure 23: Ambient temperatures for systems with an 815E CPU board (ETX)

See the following page for a description of the graphic.

## 2.6.2 Minimum ambient temperature

For systems containing one of the following components, the minimum ambient temperature is +5°C: 5AC600.HDDI-00, 5AC600.CDXS-00, 5AC600.DVDS-00, 5AC600.DVRS-00, 5AC600.FDDS-00, 5AC600.HDDS-00, 5ACPCI.RAIS-00, 5ACPCI.RAIS-01.

If none of these components are used, then the minimum ambient temperature is 0°C.

## 2.6.3 How do you determine the maximum ambient temperature?

- 1) Selection of the CPU board (use **with** or **without** fan kit).
- 2) The "maximum ambient temperature" line shows the maximum ambient temperature for the entire system when using this CPU board.

### Information:

**Maximum temperature data is for operation at 500 meters. Derating the maximum ambient temperature - typically 1°C per 1000 meters (from 500 meters above sea level).**

3) Incorporating additional drives (add-on, slide-in), main memory, additional insert cards, etc. can change the temperature limits of an APC620 system.

If there is a ✓ (checkmark) next to the component, it can be used at the maximum ambient temperature of the whole system without problems.

If there is a specific temperature, for example "35", next to the component, then the ambient temperature of the whole APC620 system cannot exceed this temperature.

### Special case: 5AC600.HDDI-00, 5AC600.HDDS-00 and RAID hard disks

For these hard disks, the limits will depend on whether the system is intended for 24-hour<sup>1)</sup> or standard<sup>1)</sup> operation.

Example 1: A temperature limit of "30/35" means 30°C for 24-hour operation and 35°C for standard operation.

Example 2: A temperature limit of "-/25" means not intended for 24-hour operation and 25°C for standard operation.

### Information:

**It is generally recommended to use a fan kit when using hard disks 5AC600.HDDI-00, 5AC600.HDDS-00 and the RAID hard disks.**

<sup>1)</sup> 24-hour operation = 732 POH (Power On Hours) per month, standard operation = 250 POH or 333 POH (Power On Hours) per month.

## 2.6.4 Temperature monitoring

The APC620 has temperature sensors in various places (I/O, power supply, slide-in drive 1, slide-in drive 2). The locations of the temperature sensors can be found in the figure "Temperature sensor locations", on page 791. The value listed in the table represents the defined maximum temperature for this measurement point<sup>1)</sup>. An alarm is not triggered when this temperature is exceeded. The temperatures<sup>1)</sup> can be read in BIOS (menu item "Advanced" - Main board/panel features - Main board monitor) or in Microsoft Windows XP/embedded, using the B&R Control Center.

Additionally, the hard disks for APC620 systems available from B&R are equipped with S.M.A.R.T, or Self Monitoring, Analysis, and Reporting Technology. This makes it possible to read various parameters, for example the temperature, using software (e.g. HDD thermometer - freeware) in Microsoft Windows XP/embedded.

<sup>1)</sup> The measured temperature is a guideline for the immediate ambient temperature, but can be influenced by neighboring components.

## 2.7 Ambient temperatures for systems with an 855GME CPU board (ETX / XTX)

It is possible to combine CPU boards with various other components, such as drives, main memory, additional insert cards, etc. dependent on system unit and fan kit. The various configurations result in varying maximum possible ambient temperatures, which can be seen in the following graphic (see figure 25 "Ambient temperatures for systems with an 855GME CPU board (ETX / XTX)", on page 94).

### Information:

**The maximum specified ambient temperatures were determined under worst-case conditions.**

Experience has shown that higher ambient temperatures can be reached under typical conditions, e.g. using Microsoft Windows. The testing and evaluation is to be done on-site by the user (temperatures can be read in BIOS or using the B&R Control Center, see the chapter 4 "Software", on page 371).

### Worst-case conditions for systems with an 855GME CPU board (ETX / XTX)

- Thermal Analysis Tool V1.4 from Intel for simulating 100% processor load.
- BurnIn testing tool (BurnIn V4.0 Pro from Passmark Software) to simulate a 100% load on the interface via loop-back adapters (serial interfaces, add-on and slide-in drives, USB interfaces, audio outputs)
- Maximum system extension and power consumption.

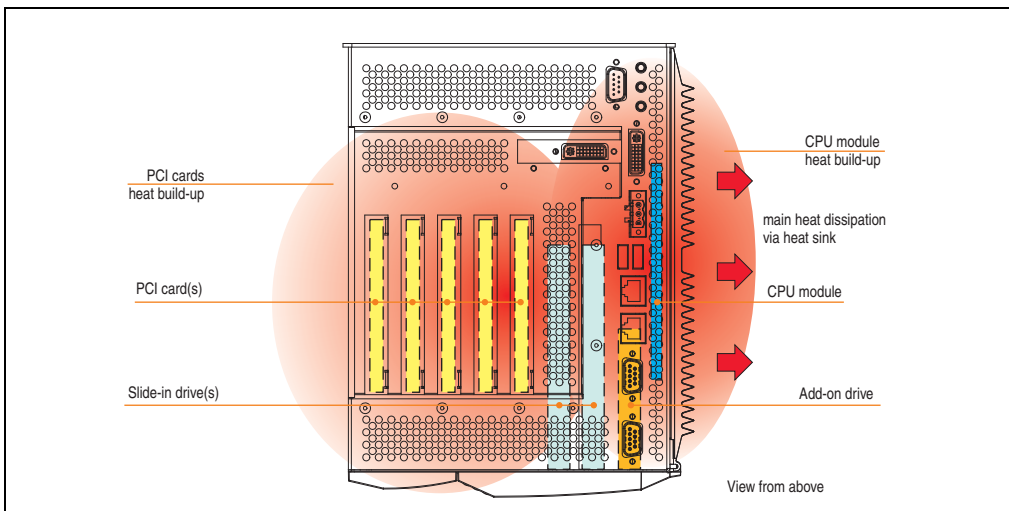

Figure 24: Example of worst-case conditions for temperature measurement

2.7.1 Maximum ambient temperature

All temperatures in °C at 500 m above sea level

Derating of the maximum ambient temperature typically 1°C per 1000 m after 500 m above sea level

	① 855GME CPU board (ETX / XTX) without fan kit and heat sink								① 855GME CPU board (ETX / XTX) with fan kit and heat sink								Temp. Monitored by sensors located in
	SAC600.HS01-01				SAC600.HS01-02				SAC600.HS01-01				SAC600.HS01-02				
	CM 600	CM 1000	PM 1100	PM 1400	PM 1600	PM 1800			CM 600	CM 1000	PM 1100	PM 1400	PM 1600	PM 1800			
② Maximum ambient temperature	50	45	45	45	/	/			55	55	55	55	45	45			
③ What can still be operated at max. ambient temp.? What are the limitations?																	
Add-on drive	Onboard CompactFlash <sup>1)</sup>	✓	✓	✓	✓				✓	✓	✓	✓	✓	✓		80	
	5AC600.CFSI-00 <sup>1)</sup>	✓	✓	✓	✓				✓	✓	✓	✓	✓	✓		80	
	5AC600.HDDI-01	✓	✓	✓	✓				✓	✓	✓	✓	✓	✓		80	
	5AC600.HDDI-00 (24-hour/Standard)	*/30	*/25	*/25	*/25				30/40	30/40	30/40	30/40	*/35	*/35		45/55	
	5AC600.HDDI-05	✓	✓	✓	✓				✓	✓	✓	✓	✓	✓		80	
	5AC600.HDDI-06	✓	✓	✓	✓				✓	✓	✓	✓	✓	✓		80	
	5AC600.SSDI-00 ≤ D0	✓	✓	✓	✓				✓	✓	✓	✓	✓	✓		75	
	5AC600.SSDI-00 ≥ E0	✓	✓	✓	✓				✓	✓	✓	✓	✓	✓		80	
Slide-in drive	5AC600.CFSS-00 <sup>1)</sup>	✓	✓	✓	✓				✓	✓	✓	✓	✓	✓		55	
	5AC600.CDXS-00	45	40	40	40				50	50	50	50	40	40		45	
	5AC600.DVDS-00	30	30	30	30				40	40	40	40	30	30		45	
	5AC600.DVRS-00	30	30	30	30				40	40	40	40	30	30		50	
	5AC600.FDDS-00	40	35	35	35				45	45	45	45	35	35		80	
	5AC600.HDDS-01	✓	✓	✓	✓				✓	✓	✓	✓	✓	✓		45/55	
	5AC600.HDDS-00 (24-hour/Standard)	35/45	30/40	30/40	30/40				40/50	40/50	40/50	40/50	30/40	30/40		80	
	5AC600.HDDS-02	✓	✓	✓	✓				✓	✓	✓	✓	✓	✓		-	
Main memory	5MMDDR.0256-00	✓	✓	✓	✓				✓	✓	✓	✓	✓	✓		-	
	5MMDDR.0512-00	✓	✓	✓	✓				✓	✓	✓	✓	✓	✓		-	
	5MMDDR.1024-00	✓	✓	✓	✓				✓	✓	✓	✓	✓	✓		95	
System units	5PC600.SX01-00	✓	✓	✓	✓				✓	✓	✓	✓	✓	✓		95	
	5PC600.SX02-00 / -01	✓	✓	✓	✓				✓	✓	✓	✓	✓	✓		95	
	5PC600.SF03-00	✓	✓	✓	✓				✓	✓	✓	✓	✓	✓		95	
	5PC600.SX05-00 / -01	✓	✓	✓	✓				✓	✓	✓	✓	✓	✓		-	
Additional Input Cards Interfaces / API Links	5AC600.CANI-00	✓	✓	✓	✓				✓	✓	✓	✓	✓	✓		-	
	5AC600.485I-00	✓	✓	✓	✓				✓	✓	✓	✓	✓	✓		-	
	5AC600.SDL0-00	✓	✓	✓	✓				✓	✓	✓	✓	✓	✓		-	
	5ACPCI.RAIS-00 (24-hour/Standard)	35/45	30/40	30/40	30/40				40/50	40/50	40/50	40/50	30/40	30/40		-	
	5ACPCI.RAIS-01 (24-hour/Standard)	35/45	30/40	30/40	30/40				40/50	40/50	40/50	40/50	30/40	30/40		-	
	5ACPCI.RAIC-01 (24-hour/Standard)	35/45	30/40	30/40	30/40				40/50	40/50	40/50	40/50	30/40	30/40		-	
	5ACPCI.RAIC-03 (24-hour/Standard)	✓	✓	✓	✓				✓	✓	✓	✓	✓	✓		-	
	5ACPCI.RAIC-05 (24-hour/Standard)	45	✓	✓	✓				50	50	50	50	✓	✓		-	

1) Only possible with a CompactFlash card 5CFCRD.xxxx-06, 5CFCRD.xxxx-04 or 5CFCRD.xxxx-03 from B&R

Figure 25: Ambient temperatures for systems with an 855GME CPU board (ETX / XTX)

All temperatures in °C  
at 500 m above sea level

Derating of the maximum  
ambient temperature typically 1°C  
per 1000 m after 500 m above sea level

		1 855GME CPU board (ETX / XTX) without fan kit and heat sink									
		5AC600.HS03-01					5AC600.HS03-01				
		CM 600	CM 1000	PM 1100	PM 1400	CM 600	CM 1000	PM 1100	PM 1400	CM 600	CM 1000
		5PC600.X885-04	5PC600.X885-05	5PC600.X885-05	5PC600.X885-00	5PC600.X885-02	5PC600.X885-04	5PC600.X885-05	5PC600.X885-00	5PC600.X885-00	5PC600.X885-00
2 Maximum ambient temperature		50	45	45	45						
3 What can still be operated at max. ambient temp.? What are the limitations?											
System units embedded	5PC600.SE00-00 < Rev C0	45	40	40	40						95
	5PC600.SE00-01 < Rev D0	45	40	40	40						95
	5PC600.SE00-02 < Rev D0	45	40	40	40						95
	5PC600.SE00-00 ≥ Rev C0	✓	✓	✓	✓						95
	5PC600.SE00-01 ≥ Rev D0	✓	✓	✓	✓						95
	5PC600.SE00-02 ≥ Rev D0	✓	✓	✓	✓						95

Temp. Monitored by sensors located in

Power Supply

Figure 26: Ambient temperatures for embedded systems with an 855GME CPU board (ETX / XTX)

### 2.7.2 Minimum ambient temperature

For systems containing one of the following components, the minimum ambient temperature is +5°C: 5AC600.HDDI-00, 5AC600.CDXS-00, 5AC600.DVDS-00, 5AC600.DVRS-00, 5AC600.FDDS-00, 5AC600.HDDS-00, 5ACPCI.RAIS-00, 5ACPCI.RAIS-01, 5ACPCI.RAIC-01. If none of these components are used, then the minimum ambient temperature is 0°C.

### 2.7.3 How do you determine the maximum ambient temperature?

- 1) Selection of the CPU board (use **with** or **without** fan kit).
- 2) The "maximum ambient temperature" line shows the maximum ambient temperature for the entire system when using this CPU board.

## Information:

**Maximum temperature data is for operation at 500 meters. Derating the maximum ambient temperature - typically 1°C per 1000 meters (from 500 meters above sea level).**

3) Incorporating additional drives (add-on, slide-in), main memory, additional insert cards, etc. can change the temperature limits of an APC620 system.

If there is a ✓ (checkmark) next to the component, it can be used at the maximum ambient temperature of the whole system without problems.

If there is a specific temperature, for example "35", next to the component, then the ambient temperature of the whole APC620 system cannot exceed this temperature.

### Special case: 5AC600.HDDI-00, 5AC600.HDDS-00 and RAID hard disks

For these hard disks, the limits will depend on whether the system is intended for 24-hour<sup>1)</sup> or standard<sup>1)</sup> operation.

Example 1: A temperature limit of "30/35" means 30°C for 24-hour operation and 35°C for standard operation.

Example 2: A temperature limit of "-/25" means not intended for 24-hour operation and 25°C for standard operation.

## Information:

**It is generally recommended to use a fan kit when using hard disks 5AC600.HDDI-00, 5AC600.HDDS-00 and the RAID hard disks 5ACPCI.RAIS-00, 5ACPCI.RAIS-01, 5ACPCI.RAIC-01 and 5ACPCI.RAIC-03.**

### 2.7.4 Temperature monitoring

The APC620 has temperature sensors in various places (I/O, power supply, slide-in drive 1, slide-in drive 2). The locations of the temperature sensors can be found in the figure "Temperature sensor locations", on page 791. The value listed in the table represents the defined maximum temperature for this measurement point<sup>2)</sup>. An alarm is not triggered when this temperature is exceeded. The temperatures<sup>2)</sup> can be read in BIOS (menu item "Advanced" - Baseboard/panel features - Baseboard monitor) or in Microsoft Windows XP/Embedded, using the B&R Control Center.

Additionally, the hard disks for APC620 systems available from B&R are equipped with S.M.A.R.T, or Self Monitoring, Analysis, and Reporting Technology. This makes it possible to read various parameters, for example the temperature, using software (e.g. HDD thermometer - freeware) in Microsoft Windows XP/Embedded.

1) 24-hour operation = 732 POH (Power On Hours) per month, standard operation = 250 POH or 333 POH (Power On Hours) per month.

2) The measured temperature is a guideline for the immediate ambient temperature, but can be influenced by neighboring components.



## 2.8 Power management APC620 system unit with 1 PCI slot

### 2.8.1 Supply voltage for the 5PC600.SX01-00 revision $\geq$ I0

The following block diagram presents the simplified structure of the APC620 supply voltage for 5PC600.SX01-00 system units starting with revision I0.

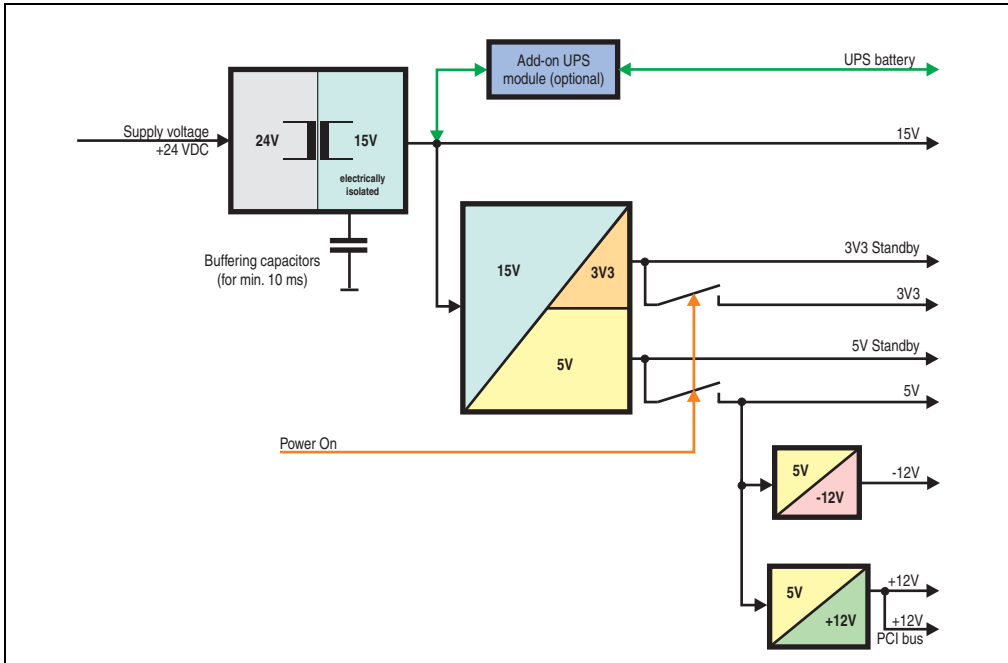

Figure 27: Supply voltage for the 5PC600.SX01-00 revision  $\geq$  I0

#### **Explanation:**

The supply voltage is converted to 15 V with a DC/DC converter. These electrically isolated 15 V feed four further DC/DC converters, which generate the remaining voltages.

After the system is turned on (e.g. using the power button), the voltages 3V3 and 5 V are placed on the bus. Two additional DC/DC converters at the 5 V output generate -12 V and +12 V, which is then applied to the bus.

The optional APC620 add-on UPS and battery unit is supplied with 15 V and provides an uninterrupted power supply from the 15 V bus during power failures.

2.8.2 Power calculation with 5PC600.SX01-00 revision >= I0

Information:		APC620 System unit 5PC600.SX01-00										This system					
		C3 400	C3 723	C3 1000	CM 600	CM 1000	PM 1100	PM 1400	PM 1600	PM 1800	Enter values in this column 						
All entries in watts The entries for the Generator are maximum values. Entries for the Device are determined maximum values, but not peak values.		5PC600.EI1540	5PC600.EI1502	5PC600.EI1503	5PC600.EI85504	5PC600.XI85504	5PC600.EI85505	5PC600.XI85505	5PC600.EI85500	5PC600.XI85500	5PC600.EI85502	5PC600.XI85502	5PC600.EI85501	5PC600.XI85501	5PC600.EI85503	5PC600.XI85503	
<b>Total power supply (max.)</b>															<b>70</b>		
Add-on UPS module, optional		7.5	7.5	7.5	7.5	7.5	7.5	7.5	7.5	7.5	7.5	7.5	7.5	7.5	7.5		
<b>max. possible at 5V</b>															<b>70</b>		
Total power supply	5V	CPU Board, fixed device	14	18	25	17	21	23	23	37	37						
		per CompactFlash, optional (add-on, slide-in)	1	1	1	1	1	1	1	1	1	1					
		Hard Disk, optional (add-on, slide-in)	4	4	4	4	4	4	4	4	4	4					
		External keyboard PS/2, optional	1	1	1	1	1	1	1	1	1	1					
		USB Peripheral, optional (max. 2.5 watts per USB1 and USB2 connection)	5	5	5	5	5	5	5	5	5	5					
		Interface option (add-on interface), optional	0.5	0.5	0.5	0.5	0.5	0.5	0.5	0.5	0.5	0.5					
		PCI card manufacturer limit, optional (max. 3 watts without fan kit, max. 17 watts with fan kit) <sup>1)</sup>															
		External consumer, optional (via BaseBoard)	5	5	5	5	5	5	5	5	5	5					
		<b>Devices 5V ∑</b>															
		<b>max. possible at +12V</b>															<b>12</b>
	+12V	Fan kit, optional	2.5	2.5	2.5	2.5	2.5	2.5	2.5	2.5	2.5						
		External consumer, optional (via BaseBoard)	10	10	10	10	10	10	10	10	10						
		PCI card manufacturer limit, optional (max. 3 watts without fan kit, max. 12 watts with fan kit) <sup>1)</sup>															
	<b>Devices total +12V ∑</b>																
	<b>max. possible at -12V</b>															<b>1.2</b>	
-12V	PCI card manufacturer limit, optional (max. 1.2 watts without and with fan kit) <sup>1)</sup>																
	<b>Devices total -12V ∑</b>																
<b>Devices total 5V ∑</b>																	
<b>max. possible at 3V3</b>															<b>23</b>		
3V3	System unit, fixed device	4	4	4	4	4	4	4	4	4							
	Interface option (add-on interface), optional	0.25	0.25	0.25	0.25	0.25	0.25	0.25	0.25	0.25							
	PCI card manufacturer limit, optional (max. 3 watts without fan kit, max. 17 watts with fan kit) <sup>1)</sup>																
<b>Devices 3V3 ∑</b>																	
<b>Devices total ∑</b>																	

<sup>1)</sup> The total performance of one PCI card per PCI slot (= sum of power consumptions for each voltage area) may not exceed the limits stated for operation with or without a fan kit.

See section "Starting current", on page 136 for starting current values.

### 2.8.3 Supply voltage for the 5PC600.SX01-00 revision < I0

The following block diagram presents the simplified structure of the APC620 supply voltage for 5PC600.SX01-00 system units starting with revision < I0.

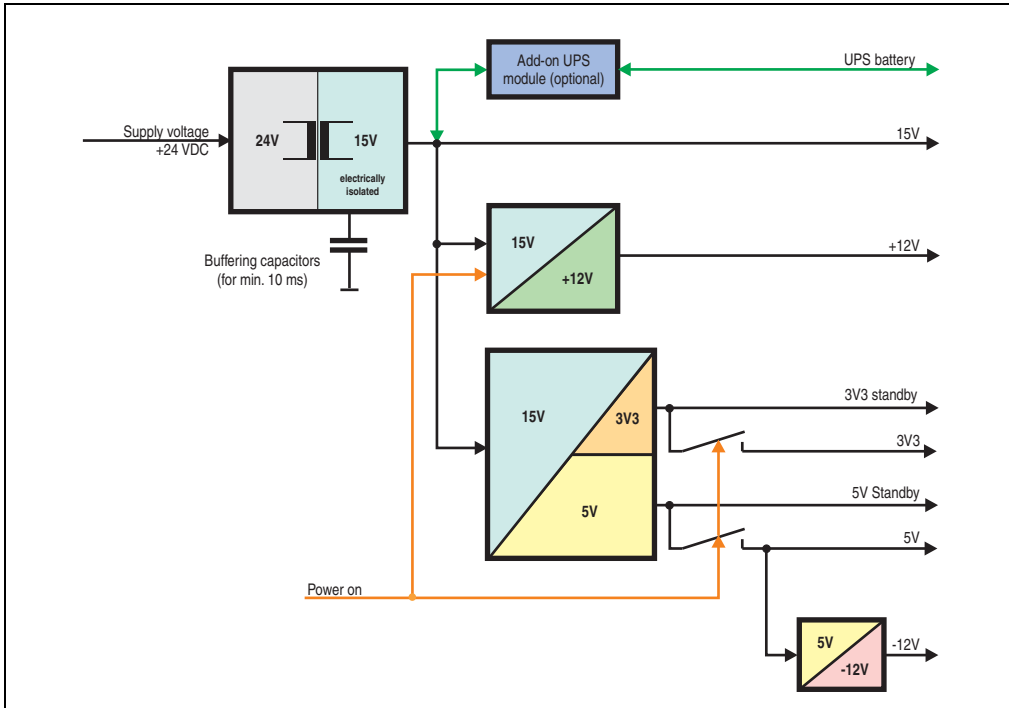

Figure 28: Supply voltage for the 5PC600.SX01-00 revision < I0

#### **Explanation:**

The supply voltage is converted to 15 V with a DC/DC converter. These electrically isolated 15 volts feed two further DC/DC converters. One generates +12 V, and the other 3V3 and 5V standby.

After the system is turned on (e.g. using the power button), the voltages 3V3, 5 V, +12 V are placed on the bus. At the 5 V output, yet another DC/DC converter generates -12 V, and places these on the bus.

The optional APC620 add-on UPS and battery unit is supplied with 15 V and provides an uninterrupted power supply from the 15 V bus during power failures.

2.8.4 Power calculation with 5PC600.SX01-00 revision < I0

Information:		APC620 System unit 5PC600.SX01-00										This system				
		C3 400	C3 733	C3 1000	CM 600	CM 1000	PM 1100	PM 1400	PM 1600	PM 1800						
All entries in watts The entries for the <b>Generator</b> are maximum values. Entries for the <b>Device</b> are determined maximum values, but not peak values.		5PC600.E815-00	5PC600.E815-02	5PC600.E815-03	5PC600.E885-04	5PC600.X885-04	5PC600.E885-05	5PC600.X885-05	5PC600.E885-00	5PC600.E885-02	5PC600.X885-02	5PC600.E885-01	5PC600.E885-03	5PC600.X885-03	Enter values in this columns 	
		Total power supply (max.)										70				
Add-on UPS module, optional		7.5	7.5	7.5	7.5	7.5	7.5	7.5	7.5	7.5	7.5	7.5	7.5			
<b>max. possible at 5V</b>												<b>70</b>				
Total power supply	5V	CPU Board, fixed device	14	18	25	17	21	23	23	37	37					
		per CompactFlash, optional (add-on, slide-in)	1	1	1	1	1	1	1	1	1	1				
		Hard Disk, optional (add-on, slide-in)	4	4	4	4	4	4	4	4	4	4				
		External keyboard PS/2, optional	1	1	1	1	1	1	1	1	1	1				
		USB Peripheral, optional (max. 2.5 watts per USB1 and USB2 connection)	5	5	5	5	5	5	5	5	5	5				
		Interface option (add-on interface), optional	0.5	0.5	0.5	0.5	0.5	0.5	0.5	0.5	0.5	0.5				
		PCI card manufacturer limit, optional (max. 3 watts without fan kit, max. 17 watts with fan kit) <sup>1)</sup>														
		External consumer, optional (via BaseBoard)	5	5	5	5	5	5	5	5	5	5				
		Devices 5V $\Sigma$														
		<b>max. possible at -12V</b>												<b>1.2</b>		
Total power supply	-12V	PCI card manufacturer limit, optional (max. 1.2 watts without and with fan kit) <sup>1)</sup>														
		Devices -12V $\Sigma$														
		Devices total 5V $\Sigma$														
		<b>max. possible at 3V3</b>												<b>23</b>		
		Total power supply	3V3	System unit, fixed device	4	4	4	4	4	4	4	4	4			
				Interface option (add-on interface), optional	0.25	0.25	0.25	0.25	0.25	0.25	0.25	0.25	0.25	0.25		
				PCI card manufacturer limit, optional (max. 3 watts without fan kit, max. 17 watts with fan kit) <sup>1)</sup>												
				Devices 3V3 $\Sigma$												
				<b>max. possible at +12V</b>												<b>12</b>
				Total power supply	+12V	Fan kit, optional	2.5	2.5	2.5	2.5	2.5	2.5	2.5	2.5	2.5	
External consumer, optional (via BaseBoard)	10					10	10	10	10	10	10	10	10	10		
PCI card manufacturer limit, optional (max. 3 watts without fan kit, max. 12 watts with fan kit) <sup>1)</sup>																
Devices +12V $\Sigma$																
Devices total $\Sigma$																

<sup>1)</sup> The total performance of one PCI card per PCI slot (= sum of power consumptions for each voltage area) may not exceed the limits stated for operation with or without a fan kit.

See section "Starting current", on page 136 for starting current values.

## 2.9 Power management APC620 system units with 2 PCI slots

### 2.9.1 Supply voltage for the 5PC600.SX02-00 revision $\geq$ H0 and 5PC600.SX02-01 revision $\geq$ K0)

The following block diagram presents the simplified structure of the APC620 supply voltage for system units 5PC600.SX02-00 (revision H0 and higher), 5PC600.SX02-01 (revision K0 and higher).

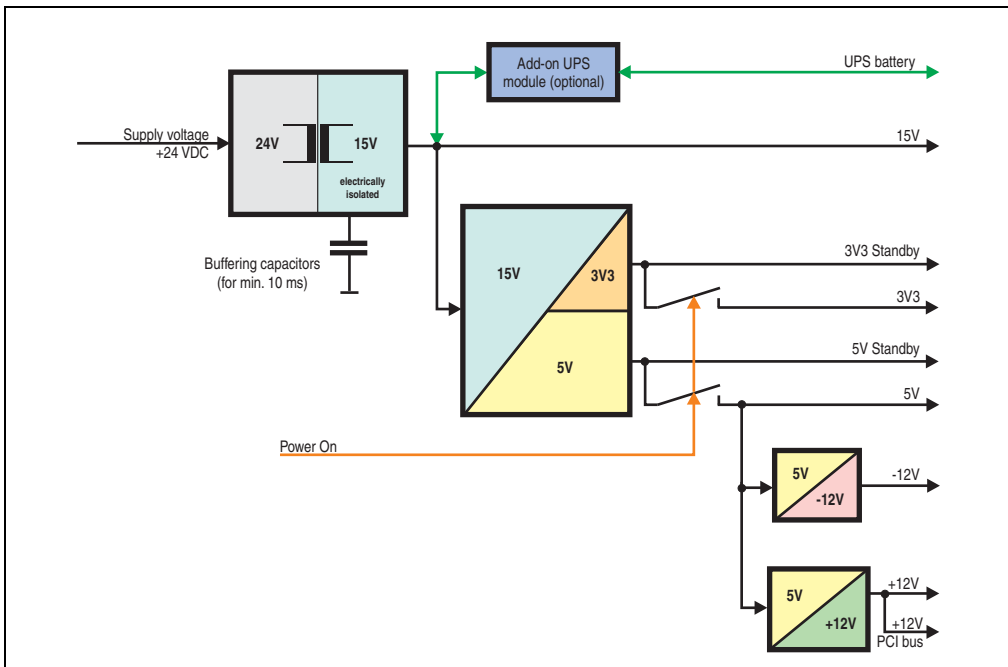

Figure 29: Supply voltage for the 2 PCI slots (dependent on system unit version)

#### **Explanation:**

The supply voltage is converted to 15 V with a DC/DC converter. These electrically isolated 15 V feed four further DC/DC converters, which generate the remaining voltages.

After the system is turned on (e.g. using the power button), the voltages 3V3 and 5 V are placed on the bus. Two additional DC/DC converters at the 5 V output generate -12 V and +12 V, which is then applied to the bus.

The optional APC620 add-on UPS and battery unit is supplied with 15 V and provides an uninterrupted power supply from the 15 V bus during power failures.

2.9.2 Power calculation with 5PC600.SX02-00 revision >= H0

Information:		APC620 System unit 5PC600.SX02-00										This system	
		C3 400	C3 723	C3 1000	CM 600	CM 1000	PM 1100	PM 1400	PM 1600	PM 1800	Enter values in this columns 		
All entries in watts The entries for the <b>Generator</b> are maximum values. Entries for the <b>Device</b> are determined maximum values, but not peak values.		5PC600.E815-00	5PC600.E815-02	5PC600.E815-03	5PC600.E885-04	5PC600.E885-05	5PC600.E885-06	5PC600.E885-07	5PC600.E885-08	5PC600.E885-09	5PC600.X885-01	5PC600.X885-03	5PC600.X885-03
		<b>Total power supply (max.)</b>										<b>70</b>	
Add-on UPS module, optional		7.5	7.5	7.5	7.5	7.5	7.5	7.5	7.5	7.5	7.5	7.5	
		<b>max. possible at 5V</b>										<b>70</b>	
Total power supply	5V	CPU Board, fixed device	14	18	25	17	21	23	23	37	37		
		per CompactFlash, optional (add-on, slide-in)	1	1	1	1	1	1	1	1	1		
		Hard Disk, optional (add-on, slide-in)	4	4	4	4	4	4	4	4	4		
		per drive, optional (slide-in CD,DVD CD-RW)	4	4	4	4	4	4	4	4	4		
		External keyboard PS/2, optional	1	1	1	1	1	1	1	1	1		
		USB Peripheral, optional (max. 2.5 watts per USB1 and USB2 connection)	5	5	5	5	5	5	5	5	5		
		Interface option (add-on interface), optional	0.5	0.5	0.5	0.5	0.5	0.5	0.5	0.5	0.5		
		Graphics adapter (AP Link), optional	5	5	5	5	5	5	5	5	5		
		PCI card manufacturer limit, optional (max. 3 watts without fan kit, max. 17 watts with fan kit) <sup>1)</sup>											
		External consumer, optional (via BaseBoard)	5	5	5	5	5	5	5	5	5		
			<b>Devices 5V ∑</b>										
			<b>max. possible at +12V</b>										<b>12</b>
	+12V	Fan kit, optional	2.5	2.5	2.5	2.5	2.5	2.5	2.5	2.5	2.5		
		External consumer, optional (via BaseBoard)	10	10	10	10	10	10	10	10	10		
		PCI card manufacturer limit, optional (max. 3 watts without fan kit, max. 12 watts with fan kit) <sup>1)</sup>											
		<b>Devices total +12V ∑</b>											
		<b>max. possible at -12V</b>										<b>1.2</b>	
	-12V	PCI card manufacturer limit, optional (max. 1.2 watts without and with fan kit) <sup>1)</sup>											
		<b>Devices total -12V ∑</b>											
		<b>Devices total 5V ∑</b>											
		<b>max. possible at 3V3</b>										<b>23</b>	
	3V3	System unit, fixed device	4	4	4	4	4	4	4	4	4		
		Graphics adapter (AP Link), optional	5	5	5	5	5	5	5	5	5		
		Interface option (add-on interface), optional	0.25	0.25	0.25	0.25	0.25	0.25	0.25	0.25	0.25		
		PCI card manufacturer limit, optional (max. 3 watts without fan kit, max. 17 watts with fan kit) <sup>1)</sup>											
		<b>Devices 3V3 ∑</b>											
		<b>Devices total ∑</b>											

<sup>1)</sup> The total performance of one PCI card per PCI slot (= sum of power consumptions for each voltage area) may not exceed the limits stated for operation with or without a fan kit.

See section "Starting current", on page 136 for starting current values.

2.9.3 Power calculation with 5PC600.SX02-01 revision >= K0

Information:		APC620 System unit 5PC600.SX02-01										This system													
		C3 400	C3 723	C3 1000	CM 600	CM 1000	PM 1100	PM 1400	PM 1600	PM 1800															
<b>All entries in watts</b> The entries for the <b>Generator</b> are maximum values. Entries for the <b>Device</b> are determined maximum values, but not peak values.		5PC600.E815-00	5PC600.E815-02	5PC600.E815-03	5PC600.E885-04	5PC600.X885-04	5PC600.E885-05	5PC600.X885-05	5PC600.E885-00	5PC600.X885-02	5PC600.X885-02	5PC600.X885-01	5PC600.E885-03	5PC600.X885-03	Enter values in this columns 										
		<b>Total power supply (max.)</b>											<b>70</b>												
<b>Total power supply</b>		Add-on UPS module, optional											7.5	7.5	7.5	7.5	7.5	7.5	7.5	7.5	7.5	7.5			
		<b>max. possible at 5V</b>											<b>70</b>												
		<b>5V</b>		CPU Board, fixed device											14	18	25	17	21	23	23	37	37		
				per CompactFlash, optional (add-on, slide-in)											1	1	1	1	1	1	1	1	1		
				Hard Disk, optional (add-on, slide-in)											4	4	4	4	4	4	4	4	4		
				per Drive, optional (slide-in CD,DVD CD-RW)											4	4	4	4	4	4	4	4	4		
				External keyboard PS/2, optional											1	1	1	1	1	1	1	1	1		
				USB Peripheral, optional (max. 2.5 watts per USB1 and USB2 connection)											5	5	5	5	5	5	5	5	5		
				Interface option (add-on interface), optional											0.5	0.5	0.5	0.5	0.5	0.5	0.5	0.5	0.5		
				PCI card manufacturer limit, optional (max. 3 watts without fan kit, max. 17 watts with fan kit) <sup>1)</sup>																					
				External consumer, optional (via BaseBoard)											5	5	5	5	5	5	5	5	5		
				<b>Devices 5V ∑</b>																					
		<b>-12V</b>		<b>max. possible at -12V</b>											<b>1.2</b>										
				PCI card manufacturer limit, optional (max. 1.2 watts without and with fan kit) <sup>1)</sup>																					
				<b>Devices -12V ∑</b>																					
<b>Devices total 5V ∑</b>																									
<b>3V3</b>		<b>max. possible at 3V3</b>											<b>23</b>												
		System unit, fixed device											4	4	4	4	4	4	4	4	4				
		Interface option (add-on interface), optional											0.25	0.25	0.25	0.25	0.25	0.25	0.25	0.25	0.25				
		PCI card manufacturer limit, optional (max. 3 watts without fan kit, max. 17 watts with fan kit) <sup>1)</sup>																							
<b>Devices 3V3 ∑</b>																									
<b>+12V</b>		<b>max. possible at +12V</b>											<b>12</b>												
		Fan kit, optional											2.5	2.5	2.5	2.5	2.5	2.5	2.5	2.5	2.5				
		External consumer, optional (via BaseBoard)											10	10	10	10	10	10	10	10	10				
		PCI card manufacturer limit, optional (max. 3 watts without fan kit, max. 12 watts with fan kit) <sup>1)</sup>																							
<b>Devices +12V ∑</b>																									
<b>Devices total ∑</b>																									

<sup>1)</sup> The total performance of one PCI card per PCI slot (= sum of power consumptions for each voltage area) may not exceed the limits stated for operation with or without a fan kit.

See section "Starting current", on page 136 for starting current values.

### 2.9.4 Supply voltage for the 5PC600.SX02-00 revision < H0 and 5PC600.SX02-01 revision < K0)

The following block diagram presents the simplified structure of the APC620 supply voltage for system units 5PC600.SX02-00 (revision < H0 and higher), 5PC600.SX02-01 (revision < K0 and higher).

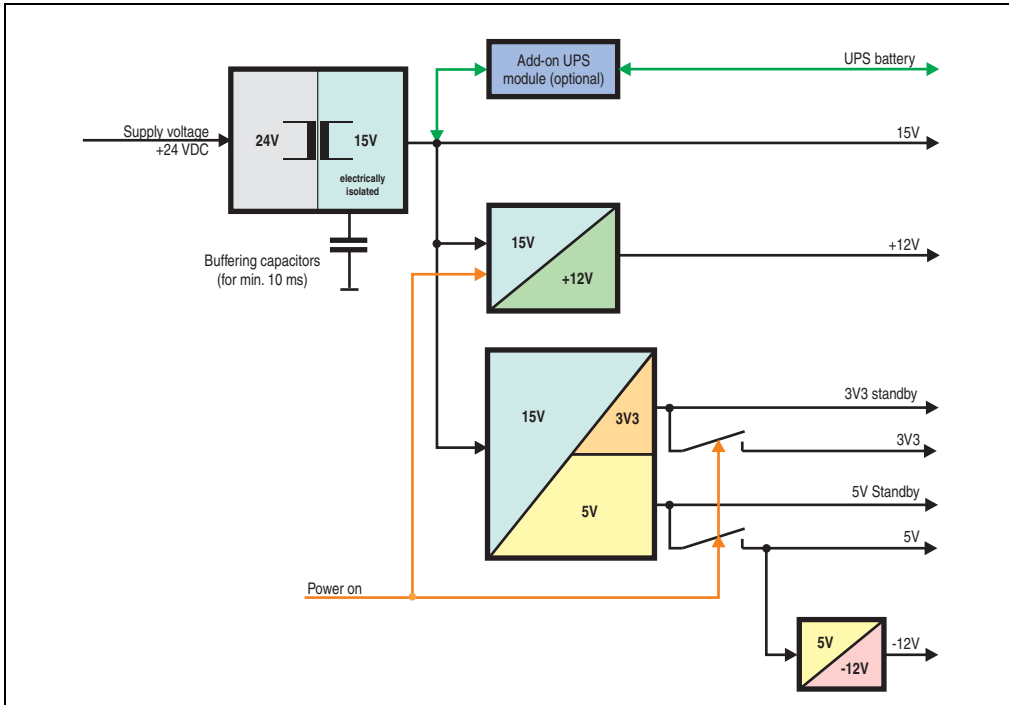

Figure 30: Supply voltage for the 2 PCI slots (dependent on system unit version)

#### **Explanation:**

The supply voltage is converted to 15 V with a DC/DC converter. These electrically isolated 15 volts feed two further DC/DC converters. One generates +12 V, and the other 3V3 and 5V standby.

After the system is turned on (e.g. using the power button), the voltages 3V3, 5 V, +12 V are placed on the bus. At the 5 V output, yet another DC/DC converter generates -12 V, and places these on the bus.

The optional APC620 add-on UPS and battery unit is supplied with 15 V and provides an uninterrupted power supply from the 15 V bus during power failures.



2.9.5 Power calculation with 5PC600.SX02-00 revision < H0

Information:		APC620 System unit 5PC600.SX02-00										This system										
		C3 400	C3 723	C3 1000	CM 600	CM 1000	PM 1000	PM 1400	PM 1600	PM 1800			Enter values in this columns 									
All entries in watts The entries for the <b>Generator</b> are maximum values. Entries for the <b>Device</b> are determined maximum values, but not peak values.		5PC600.E815-00	5PC600.E815-02	5PC600.E815-03	5PC600.E885-04	5PC600.X885-04	5PC600.E885-05	5PC600.X885-05	5PC600.E885-00	5PC600.E885-02	5PC600.X885-02	5PC600.E885-01		5PC600.X885-03	5PC600.X885-03							
<b>Total power supply (max.)</b>												<b>70</b>										
Add-on UPS module, optional												7.5	7.5	7.5	7.5	7.5	7.5	7.5	7.5	7.5		
<b>max. possible at 5V</b>												<b>55</b>										
5V	CPU Board, fixed device											14	18	25	17	21	23	23	37	37		
	per CompactFlash, optional (add-on, slide-in)											1	1	1	1	1	1	1	1	1		
	Hard Disk, optional (add-on, slide-in)											4	4	4	4	4	4	4	4	4		
	per Drive, optional (slide-in CD,DVD CD-RW)											4	4	4	4	4	4	4	4	4		
	External keyboard PS/2, optional											1	1	1	1	1	1	1	1	1		
	USB Peripheral, optional (max. 2.5 watts per USB1 and USB2 connection)											5	5	5	5	5	5	5	5	5		
	Interface option (add-on interface), optional											0.5	0.5	0.5	0.5	0.5	0.5	0.5	0.5	0.5		
	Graphics adapter (AP Link), optional											5	5	5	5	5	5	5	5	5		
	PCI card manufacturer limit, optional (max. 3 watts without fan kit, max. 17 watts with fan kit) <sup>1)</sup>																					
	External consumer, optional (via BaseBoard)											5	5	5	5	5	5	5	5	5		
<b>Devices 5V ∑</b>																						
<b>max. possible at -12V</b>												<b>1.2</b>										
-12V	PCI card manufacturer limit, optional (max. 1.2 watts without and with fan kit) <sup>1)</sup>																					
	<b>Devices -12V ∑</b>																					
<b>Devices total 5V ∑</b>																						
<b>max. possible at 3V3</b>												<b>23</b>										
3V3	System unit, fixed device											4	4	4	4	4	4	4	4	4		
	Graphics adapter (AP Link), optional											5	5	5	5	5	5	5	5	5		
	Interface option (add-on interface), optional											0.25	0.25	0.25	0.25	0.25	0.25	0.25	0.25	0.25		
	PCI card manufacturer limit, optional (max. 3 watts without fan kit, max. 17 watts with fan kit) <sup>1)</sup>																					
<b>Devices 3V3 ∑</b>																						
<b>max. possible at +12V</b>												<b>12</b>										
+12V	Fan kit, optional											2.5	2.5	2.5	2.5	2.5	2.5	2.5	2.5	2.5		
	External consumer, optional (via BaseBoard)											10	10	10	10	10	10	10	10	10		
	PCI card manufacturer limit, optional (max. 3 watts without fan kit, max. 12 watts with fan kit) <sup>1)</sup>																					
<b>Devices +12V ∑</b>																						
<b>Devices total ∑</b>																						

1) The total performance of one PCI card per PCI slot (= sum of power consumptions for each voltage area) may not exceed the limits stated for operation with or without a fan kit.

See section "Starting current", on page 136 for starting current values.

2.9.6 Power calculation with 5PC600.SX02-01 revision < K0

Information:		APC620 System unit 5PC600.SX02-01										This system												
		C3 400	C3 733	C3 1000	CM 600	CM 1000	PM 1100	PM 1400	PM 1600	PM 1800														
<b>All entries in watts</b> The entries for the <b>Generator</b> are maximum values. Entries for the <b>Device</b> are determined maximum values, but not peak values.		5PC600.E815-00	5PC600.E815-02	5PC600.E815-03	5PC600.E885-04	5PC600.X885-04	5PC600.E885-05	5PC600.X885-05	5PC600.E885-00	5PC600.X885-02	5PC600.E885-02	5PC600.X885-02	5PC600.X885-01	5PC600.E885-03	5PC600.X885-03	Enter values in this columns 								
		<b>Total power supply (max.)</b>													<b>70</b>									
<b>Total power supply</b>		Add-on UPS module, optional										7.5	7.5	7.5	7.5	7.5	7.5	7.5	7.5	7.5	7.5			
		<b>max. possible at 5V</b>													<b>55</b>									
		<b>5V</b>		CPU Board, fixed device										14	18	25	17	21	23	23	37	37		
				per CompactFlash, optional (add-on, slide-in)										1	1	1	1	1	1	1	1	1	1	
				Hard Disk, optional (add-on, slide-in)										4	4	4	4	4	4	4	4	4	4	
				per Drive, optional (slide-in CD,DVD CD-RW)										4	4	4	4	4	4	4	4	4	4	
				External keyboard PS/2, optional										1	1	1	1	1	1	1	1	1	1	
				USB Peripheral, optional (max. 2.5 watts per USB1 and USB2 connection)										5	5	5	5	5	5	5	5	5	5	
				Interface option (add-on interface), optional										0.5	0.5	0.5	0.5	0.5	0.5	0.5	0.5	0.5	0.5	
				PCI card manufacturer limit, optional (max. 3 watts without fan kit, max. 17 watts with fan kit) <sup>1)</sup>																				
				External consumer, optional (via BaseBoard)										5	5	5	5	5	5	5	5	5	5	
														<b>Devices 5V ∑</b>										
		<b>max. possible at -12V</b>													<b>1.2</b>									
		<b>-12V</b>		PCI card manufacturer limit, optional (max. 1.2 watts without and with fan kit) <sup>1)</sup>																				
														<b>Devices -12V ∑</b>										
												<b>Devices total 5V ∑</b>												
		<b>max. possible at 3V3</b>													<b>23</b>									
		<b>3V3</b>		System unit, fixed device										4	4	4	4	4	4	4	4	4	4	
				Interface option (add-on interface), optional										0.25	0.25	0.25	0.25	0.25	0.25	0.25	0.25	0.25	0.25	
				PCI card manufacturer limit, optional (max. 3 watts without fan kit, max. 17 watts with fan kit) <sup>1)</sup>																				
										<b>Devices 3V3 ∑</b>														
<b>max. possible at +12V</b>													<b>12</b>											
<b>+12V</b>		Fan kit, optional										2.5	2.5	2.5	2.5	2.5	2.5	2.5	2.5	2.5	2.5			
		External consumer, optional (via BaseBoard)										10	10	10	10	10	10	10	10	10	10			
		PCI card manufacturer limit, optional (max. 3 watts without fan kit, max. 12 watts with fan kit) <sup>1)</sup>																						
										<b>Devices +12V ∑</b>														
										<b>Devices total ∑</b>														

<sup>1)</sup> The total performance of one PCI card per PCI slot (= sum of power consumptions for each voltage area) may not exceed the limits stated for operation with or without a fan kit.

See section "Starting current", on page 136 for starting current values.

## 2.10 Power management APC620 system unit with 3 PCI slots

### 2.10.1 5PC600.SF03-00 supply voltage

The following block diagram presents the simplified structure of the APC620 supply voltage for system units 5PC600.SF03-00.

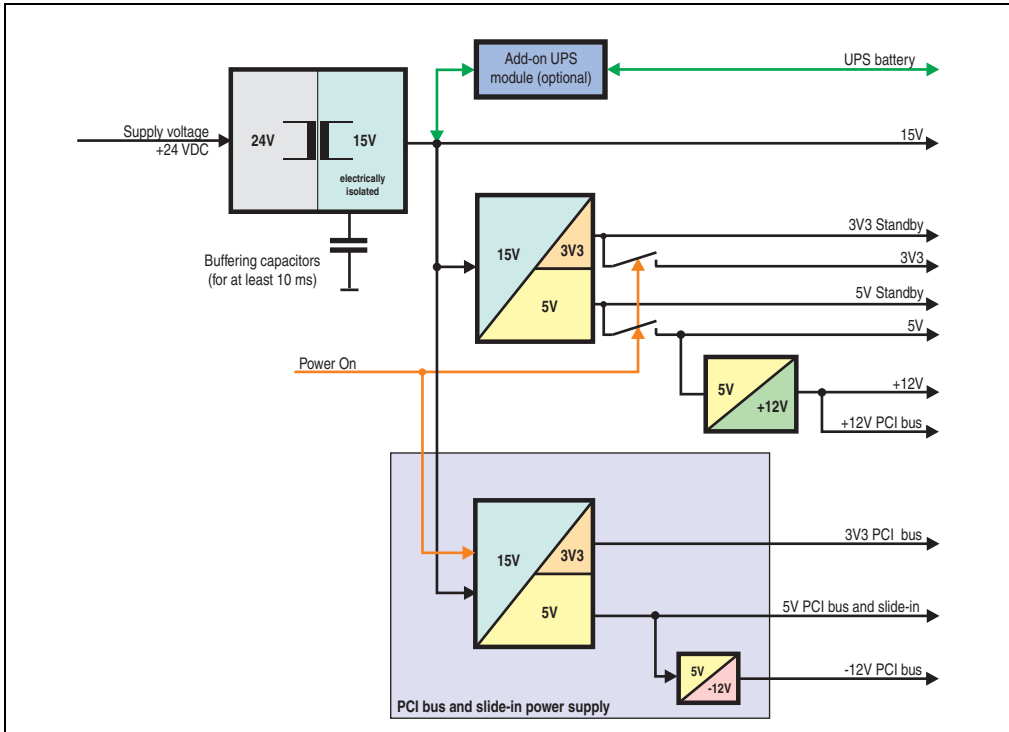

Figure 31: Supply voltage block diagram 3 PCI slots

#### **Explanation:**

Systems with 3 PCI slots have an additional power supply for the PCI buses and the slide-in drive. The supply voltage is converted to 15 V with a DC/DC converter. These electrically isolated 15 volts feed two further DC/DC converters. One generates 5 V for an additional DC/DC converter, which produces +12 V and +12V PCI bus voltage. The other DC/DC converter produces 3V3 and 5V standby.

After the system is turned on (e.g. using the power button), the voltages 3V3, 5 V, +12 V are placed on the bus. At the 5 V output, yet another DC/DC converter generates -12 V, and places these on the bus.

The optional APC620 add-on UPS and battery unit is supplied with 15 V and provides an uninterrupted power supply from the 15 V bus during power failures.

2.10.2 Power calculation with system unit 5PC600.SF03-00

Information:		APC620 System unit 5PC600.SF03-00							This system		
		CM 600 5PC600.E885-04	CM 1000 5PC600.E885-05	PM 1100 5PC600.X885-05	PM 1100 5PC600.X885-06	PM 1400 5PC600.E885-02	PM 1400 5PC600.X885-01	PM 1600 5PC600.E885-03	PM 1600 5PC600.X885-03	Enter values in this column 	
All entries in watts The entries for the <b>Generator</b> are maximum values. Entries for the <b>Device</b> are determined maximum values, but not peak values.											
		<b>Total power supply (max.)</b>							<b>110</b>		
Add-on UPS module, optional		7.5	7.5	7.5	7.5	7.5	7.5				
		<b>max. possible at 5V</b>							<b>70</b>		
5V	CPU Board, fixed device	17	21	23	23	37	37				
	per CompactFlash, optional (add-on)	1	1	1	1	1	1				
	Hard Disk, optional (add-on)	4	4	4	4	4	4				
	External keyboard PS/2, optional	1	1	1	1	1	1				
	USB Peripheral, optional (max. 2.5 watts per USB1 and USB2 connection)	5	5	5	5	5	5				
	Interface option (add-on interface), optional	0.5	0.5	0.5	0.5	0.5	0.5				
	Graphics adapter (AP Link), optional	5	5	5	5	5	5				
	External consumer, optional (via BaseBoard)	5	5	5	5	5	5				
			<b>max. possible at +12V</b>							<b>24</b>	
	+12V	Fan Kit, optional	2.5	2.5	2.5	2.5	2.5	2.5			
External consumer, optional (via BaseBoard)		10	10	10	10	10	10				
PCI manufacturer limits, optional (max. 3 watts without fan kit, max. 12 watts with fan kit) <sup>1)</sup>											
		<b>Devices total 5V <math>\Sigma</math></b>									
		<b>max. possible at 3V3</b>							<b>23</b>		
3V3	System unit, fixed device	4	4	4	4	4	4				
	Graphics adapter (AP Link), optional	5	5	5	5	5	5				
	Interface option (add-on interface), optional	0.25	0.25	0.25	0.25	0.25	0.25				
		<b>Devices <math>\Sigma</math></b>									
		<b>PCI bus and slide-in power supply (max.)</b>							<b>50</b>		
		<b>max. possible at 5V PCI bus and slide-in</b>							<b>50</b>		
5V	per CompactFlash, optional (slide-in)	1	1	1	1	1	1				
	per Hard Disk, optional (slide-in)	4	4	4	4	4	4				
	per drive, optional (slide-in - CD/DVD)	4	4	4	4	4	4				
	PCI manufacturer limits, optional (max. 3 watts without fan kit, max. 17 watts with fan kit) <sup>1)</sup>										
		<b>max. possible at -12V PCI bus and slide-in</b>							<b>1.2</b>		
-12V	PCI manufacturer limits, optional (max. 1.2 watts without and with fan kit) <sup>1)</sup>										
			<b>Devices -12V <math>\Sigma</math></b>								
		<b>Devices total 5V <math>\Sigma</math></b>									
		<b>max. possible at 3V3 PCI bus and slide-in</b>							<b>23</b>		
3V3	PCI manufacturer limits, optional (max. 3 watts without fan kit, max. 17 watts with fan kit) <sup>1)</sup>										
			<b>Devices 3V3 <math>\Sigma</math></b>								
		<b>Total PCI bus and slide-in <math>\Sigma</math></b>									
		<b>Devices total <math>\Sigma</math></b>									

<sup>1)</sup> The total performance of one PCI card per PCI slot (= sum of power consumptions for each voltage area) may not exceed the limits stated for operation with or without a fan kit.

See section "Starting current", on page 136 for starting current values.

## 2.11 Power management APC620 system units with 5 PCI slots

### 2.11.1 Supply voltage for the 5PC600.SX05-00 (revision >= H0) and 5PC600.SX05-01 (revision >= H0)

The following block diagram presents the simplified structure of the APC620 supply voltage for system units 5PC600.SX05-00 (Revision H0), 5PC600.SX05-01 (Revision H0).

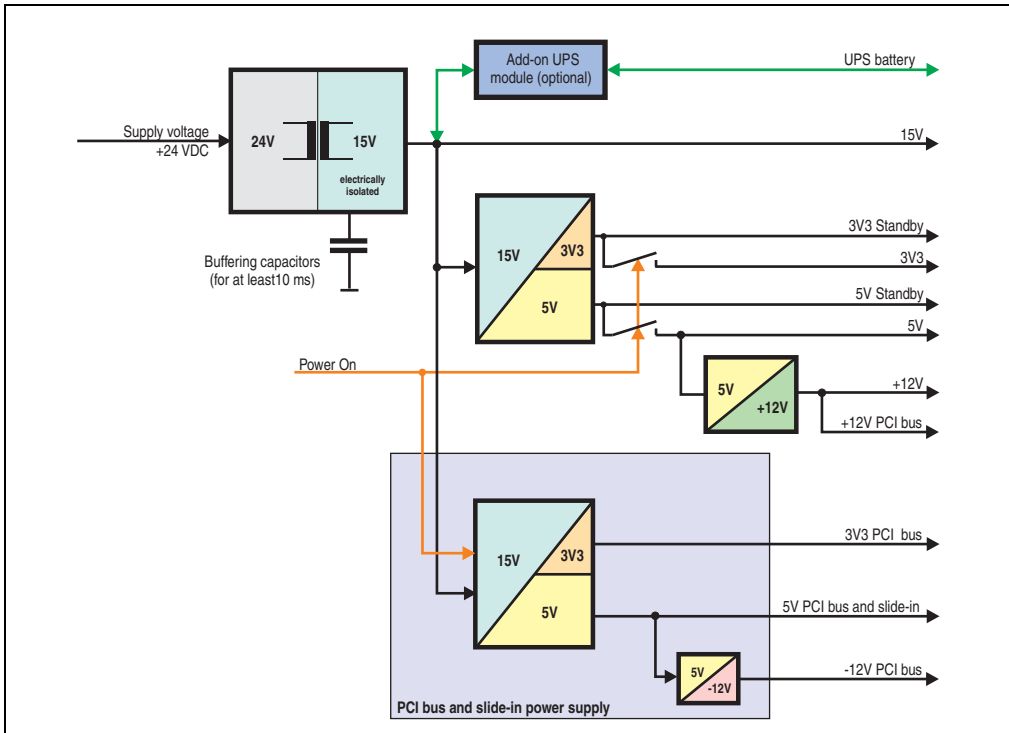

Figure 32: Supply voltage for the 5 PCI slots (dependent on system unit version)

#### **Explanation:**

Systems with 5 PCI slots have an additional power supply for the PCI buses and the slide-in drive. The supply voltage is converted to 15 V with a DC/DC converter. These electrically isolated 15 volts feed two further DC/DC converters. One generates 5 V for an additional DC/DC converter, which produces +12 V and +12V PCI bus voltage. The other DC/DC converter produces 3V3 and 5V standby.

After the system is turned on (e.g. using the power button), the voltages 3V3, 5 V, +12 V are placed on the bus. At the 5 V output, yet another DC/DC converter generates -12 V, and places these on the bus.

## **Technical Data • Entire device**

The optional APC620 add-on UPS and battery unit is supplied with 15 V and provides an uninterrupted power supply from the 15 V bus during power failures.

2.11.2 Power calculation with system unit 5PC600.SX05-00 (revision >= H0)

Information:	APC620 System unit 5PC600.SX05-00										This system											
	C3 400	C3 723	C3 1000	CM 600	CM 1000	PM 1100	PM 1400	PM 1600	PM 1800													
<b>All entries in watts</b> The entries for the <b>Generator</b> are maximum values. Entries for the <b>Device</b> are determined maximum values, but not peak values.	5PC600.E815-00	5PC600.E815-02	5PC600.E815-03	5PC600.E885-04	5PC600.X885-04	5PC600.X885-05	5PC600.X885-05	5PC600.X885-05	5PC600.X885-02	5PC600.X885-01	5PC600.X885-03	Enter values in this columns 										
<b>Total power supply (max.)</b>											<b>110</b>											
Add-on UPS module, optional											7.5											
<b>max. possible at 5V</b>											<b>70</b>											
5V	CPU Board, fixed device											14	18	25	17	21	23	23	37	37		
	per CompactFlash, optional (add-on, slide-in)											1	1	1	1	1	1	1	1	1		
	Hard Disk, optional (add-on, slide-in)											4	4	4	4	4	4	4	4	4		
	External keyboard PS/2, optional											1	1	1	1	1	1	1	1	1		
	USB Peripheral, optional (max. 2.5 watts per USB1 and USB2 connection)											5	5	5	5	5	5	5	5	5		
	Interface option (add-on interface), optional											0.5	0.5	0.5	0.5	0.5	0.5	0.5	0.5	0.5		
	Graphics adapter (AP Link), optional											5	5	5	5	5	5	5	5	5		
	External consumer, optional (via BaseBoard)											5	5	5	5	5	5	5	5	5		
	<b>max. possible at +12V</b>																					<b>24</b>
	+12V	Fan kit, optional											2.5	2.5	2.5	2.5	2.5	2.5	2.5	2.5	2.5	
External consumer, optional (via BaseBoard)											10	10	10	10	10	10	10	10	10			
PCI card manufacturer limit, optional (max. 3 watts without fan kit, max. 12 watts with fan kit) <sup>1)</sup>																						
<b>Devices total 5V ∑</b>																						
<b>max. possible at 3V3</b>																					<b>23</b>	
3V3	System unit, fixed device											4	4	4	4	4	4	4	4	4		
	Graphics adapter (AP Link), optional											5	5	5	5	5	5	5	5	5		
	Interface option (add-on interface), optional											0.25	0.25	0.25	0.25	0.25	0.25	0.25	0.25	0.25		
<b>Devices total 3V3 ∑</b>																						
<b>PCI bus and slide-in power supply (max.)</b>																					<b>50</b>	
<b>max. possible at 5V PCI bus and slide-in</b>																					<b>50</b>	
5V	per CompactFlash, optional (slide-in)											1	1	1	1	1	1	1	1	1		
	per Hard Disk, optional (slide-in)											4	4	4	4	4	4	4	4	4		
	per Drive, optional (slide-in CD,DVD)											4	4	4	4	4	4	4	4	4		
	PCI card manufacturer limit, optional (max. 3 watts without fan kit, max. 17 watts with fan kit) <sup>1)</sup>																					
	<b>Devices 5V ∑</b>																					
<b>max. possible at -12V PCI bus</b>																					<b>1.2</b>	
-12V	PCI card manufacturer limit, optional (max. 1.2 watts without and with fan kit) <sup>1)</sup>																					
	<b>Devices -12V ∑</b>																					
<b>Devices total +5V ∑</b>																						
<b>max. possible at 3V3 PCI bus</b>																					<b>23</b>	
3V3	PCI card manufacturer limit, optional (max. 3 watts without fan kit, max. 17 watts with fan kit) <sup>1)</sup>																					
	<b>Devices 3V3 ∑</b>																					
<b>Total PCI bus and slide-in ∑</b>																						
<b>Devices total ∑</b>																						

<sup>1)</sup> The total performance of one PCI card per PCI slot (= sum. of power consumptions for each voltage area) may not exceed the limits stated for operation with or without a fan kit.

Section 2  
Technical Data

See section "Starting current", on page 136 for starting current values.

2.11.3 Power calculation with system unit 5PC600.SX05-01 (revision >= H0)

Information:		APC620 System unit 5PC600.SX05-01										This system	
		C3 400	C3 723	C3 1000	CM 600	CM 1000	PM 1100	PM 1400	PM 1600	PM 1800			
<b>All entries in watts</b> The entries for the <b>Generator</b> are maximum values. Entries for the <b>Device</b> are determined maximum values, but not peak values.		5PC600.E815-00	5PC600.E815-02	5PC600.E815-03	5PC600.E885-04	5PC600.E885-05	5PC600.E885-06	5PC600.E885-07	5PC600.E885-02	5PC600.E885-02	5PC600.X885-01	5PC600.X885-03	Enter values in this columns 
		<b>Total power supply (max.)</b>										<b>110</b>	
Add-on UPS module, optional		7.5	7.5	7.5	7.5	7.5	7.5	7.5	7.5	7.5	7.5		
		<b>max. possible at 5V</b>										<b>70</b>	
5V	CPU Board, fixed device	14	18	25	17	21	23	23	37	37			
	per CompactFlash, optional (add-on, slide-in)	1	1	1	1	1	1	1	1	1			
	Hard Disk, optional (add-on, slide-in)	4	4	4	4	4	4	4	4	4			
	External keyboard PS/2, optional	1	1	1	1	1	1	1	1	1			
	USB Peripheral, optional (max. 2.5 watts per USB1 and USB2 connection)	5	5	5	5	5	5	5	5	5			
	Interface option (add-on interface), optional	0.5	0.5	0.5	0.5	0.5	0.5	0.5	0.5	0.5			
	External consumer, optional (via BaseBoard)	5	5	5	5	5	5	5	5	5			
	<b>max. possible at +12V</b>										<b>24</b>		
	+12V	Fan kit, optional	2.5	2.5	2.5	2.5	2.5	2.5	2.5	2.5	2.5		
		External consumer, optional (via BaseBoard)	10	10	10	10	10	10	10	10	10		
	PCI card manufacturer limit, optional (max. 3 watts without fan kit, max. 12 watts with fan kit) <sup>1)</sup>												
		<b>Devices total 5V ∑</b>											
		<b>max. possible at 3V3</b>										<b>23</b>	
3V3	System unit, fixed device	4	4	4	4	4	4	4	4	4			
	Interface option (add-on interface), optional	0.25	0.25	0.25	0.25	0.25	0.25	0.25	0.25	0.25			
		<b>Devices 3V3 ∑</b>											
		<b>PCI bus and slide-in power supply (max.)</b>										<b>50</b>	
		<b>max. possible at 5V PCI bus and slide-in</b>										<b>50</b>	
5V	per CompactFlash, optional (slide-in)	1	1	1	1	1	1	1	1	1			
	per Hard Disk, optional (slide-in)	4	4	4	4	4	4	4	4	4			
	per Drive, optional (slide-in CD,DVD)	4	4	4	4	4	4	4	4	4			
	PCI card manufacturer limit, optional (max. 3 watts without fan kit, max. 17 watts with fan kit) <sup>1)</sup>												
		<b>max. possible at -12V PCI bus and slide-in</b>										<b>1.2</b>	
-12V	PCI card manufacturer limit, optional (max. 1.2 watts without and with fan kit) <sup>1)</sup>												
	<b>Devices -12V ∑</b>												
		<b>Devices total +5V ∑</b>											
		<b>max. possible at 3V3 PCI bus and slide-in</b>										<b>23</b>	
3V3	PCI card manufacturer limit, optional (max. 3 watts without fan kit, max. 17 watts with fan kit) <sup>1)</sup>												
	<b>Devices 3V3 ∑</b>												
		<b>Total PCI bus and slide-in ∑</b>											
		<b>Devices total ∑</b>											

<sup>1)</sup> The total performance of one PCI card per PCI slot (= sum of power consumptions for each voltage area) may not exceed the limits stated for operation with or without a fan kit.

See section "Starting current", on page 136 for starting current values.



### 2.11.4 Supply voltage for the 5PC600.SX05-00 (revision < H0) and 5PC600.SX05-01 (revision <= H0)

The following block diagram presents the simplified structure of the APC620 supply voltage for system units 5PC600.SX05-00 (Revision < H0), 5PC600.SX05-01 (Revision < H0).

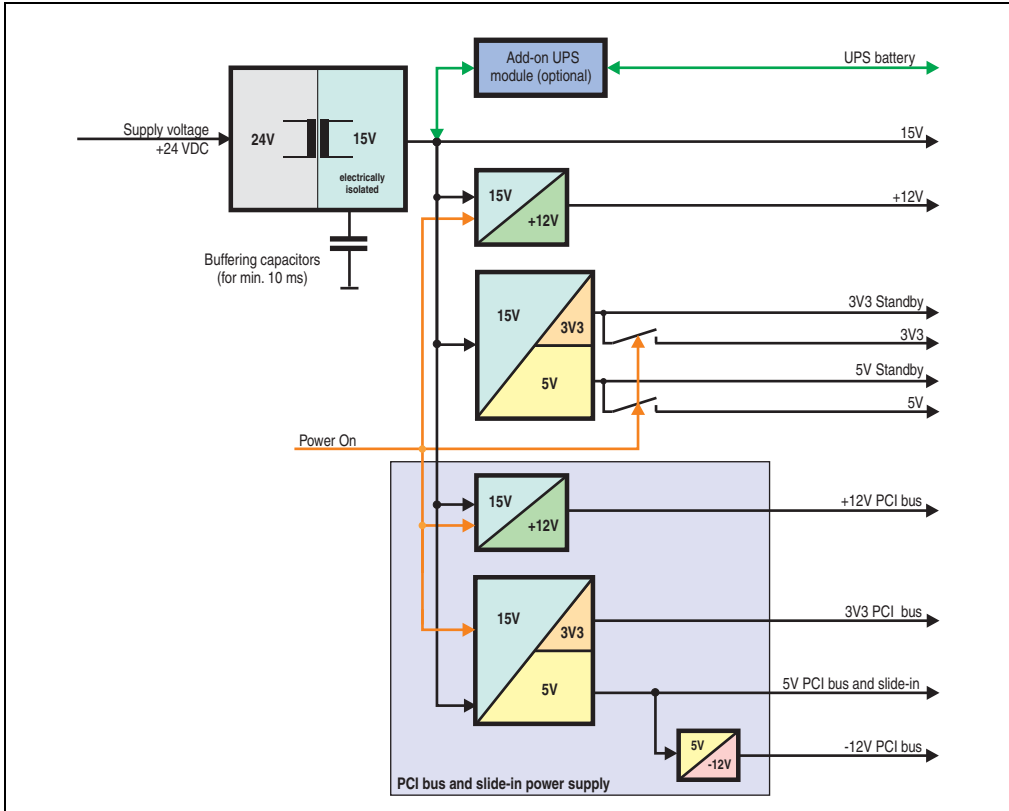

Figure 33: Supply voltage block diagram 5 PCI slots (dependent on system unit version)

#### **Explanation:**

Systems with 5 PCI slots have two additional power supplies for the PCI bus and the slide-in drives. The supply voltage is converted to 15 V with a DC/DC converter. These electrically isolated 15 V feed four further DC/DC converters. Two generate +12 V, and the others generate 3V3 and 5V standby. After the system is turned on (e.g. using the power button), the voltages 3V3, 5 V, +12 V are placed on the bus. At the 5 V output, yet another DC/DC converter generates -12 V, and places these on the bus.

## **Technical Data • Entire device**

The optional APC620 add-on UPS and battery unit is supplied with 15 V and provides an uninterrupted power supply from the 15 V bus during power failures.

2.11.5 Power calculation with system unit 5PC600.SX05-05 revision < H0

Information:		APC620 System unit 5PC600.SX05-00										This system									
		C3 400	C3 750	C3 1000	C3 1500	C3 2000	C3 2500	C3 3000	C3 3500	C3 4000	C3 4500										
<b>All entries in watts</b> The entries for the <b>Generator</b> are maximum values. Entries for the <b>Device</b> are determined maximum values, but not peak values.												Enter values in this column 									
		5PC600.EB15-00	5PC600.EB15-02	5PC600.EB15-03	5PC600.EB55-04	5PC600.XB55-04	5PC600.XB55-05	5PC600.XB55-05	5PC600.XB55-05	5PC600.XB55-02	5PC600.XB55-01	5PC600.EB55-03	5PC600.XB55-03								
		<b>Total power supply (max.)</b>										<b>110</b>									
		Add-on UPS module, optional										7.5	7.5	7.5	7.5	7.5	7.5	7.5	7.5	7.5	7.5
		<b>max. possible at 5V</b>										<b>55</b>									
5V	CPU Board, fixed device		14	18	25	17	21	23	23	37	37										
	per CompactFlash, optional (add-on, slide-in)		1	1	1	1	1	1	1	1	1	1	1								
	Hard Disk, optional (add-on, slide-in)		4	4	4	4	4	4	4	4	4	4	4								
	External keyboard PS/2, optional		1	1	1	1	1	1	1	1	1	1	1								
	USB Peripheral, optional (max. 2.5 watts per USB1 and USB2 connection)		5	5	5	5	5	5	5	5	5	5	5								
	Interface option (add-on interface), optional		0.5	0.5	0.5	0.5	0.5	0.5	0.5	0.5	0.5	0.5	0.5								
	Graphics adapter (AP Link), optional		5	5	5	5	5	5	5	5	5	5	5								
	External consumer, optional (via BaseBoard)		5	5	5	5	5	5	5	5	5	5	5								
		Devices 5V ∑																			
		<b>max. possible at 3V3</b>										<b>23</b>									
3V3	System unit, fixed device		4	4	4	4	4	4	4	4	4	4	4								
	Graphics adapter (AP Link), optional		5	5	5	5	5	5	5	5	5	5	5								
	Interface option (add-on interface), optional		0.25	0.25	0.25	0.25	0.25	0.25	0.25	0.25	0.25	0.25	0.25								
		Devices 3V3 ∑																			
		<b>max. possible at +12V</b>										<b>12</b>									
+12V	Fan kit, optional		2.5	2.5	2.5	2.5	2.5	2.5	2.5	2.5	2.5	2.5	2.5								
	External consumer, optional (via BaseBoard)		10	10	10	10	10	10	10	10	10	10	10								
		Devices +12V ∑																			
		<b>PCI bus and slide-in power supply (max.)</b>										<b>50</b>									
		<b>max. possible at 5V PCI bus and slide-in</b>										<b>50</b>									
5V	per CompactFlash, optional (slide-in)		1	1	1	1	1	1	1	1	1	1	1								
	per Hard Disk, optional (slide-in)		4	4	4	4	4	4	4	4	4	4	4								
	per Drive, optional (slide-in CD,DVD)		4	4	4	4	4	4	4	4	4	4	4								
	PCI card manufacturer limit, optional (max. 3 watts without fan kit, max. 17 watts with fan kit) <sup>1)</sup>																				
		<b>max. possible at -12V PCI bus and slide-in</b>										<b>1.2</b>									
-12V	PCI card manufacturer limit, optional (max. 1.2 watts without and with fan kit) <sup>1)</sup>																				
			Devices total 5V ∑																		
		<b>max. possible at 3V3 PCI bus and slide-in</b>										<b>23</b>									
3V3	PCI card manufacturer limit, optional (max. 3 watts without fan kit, max. 17 watts with fan kit) <sup>1)</sup>																				
			Devices 3V3 ∑																		
		<b>max. possible at +12V PCI bus and slide-in</b>										<b>12</b>									
+12V	PCI card manufacturer limit, optional (max. 3 watts without fan kit, max. 12 watts with fan kit) <sup>1)</sup>																				
			Devices +12V ∑																		
		Total PCI bus and slide-in ∑																			
		Devices total ∑																			

1) The total performance of one PCI card per PCI slot (= sum of power consumptions for each voltage area) may not exceed the limits stated for operation with or without a fan kit.

See section "Starting current", on page 136 for starting current values.

2.11.6 Power calculation with system unit 5PC600.SX05-01 revision < H0

Information:		APC620 System unit 5PC600.SX05-01										This system	
		C3 400	C3 720	C3 1000	CM 600	CM 1000	PM 1100	PM 1400	PM 1600	PM 1800			
<b>All entries in watts</b> The entries for the <b>Generator</b> are maximum values. Entries for the <b>Device</b> are determined maximum values, but not peak values.		5PC600.E815-00	5PC600.E815-02	5PC600.E815-03	5PC600.E885-04	5PC600.X885-04	5PC600.X885-05	5PC600.X885-00	5PC600.X885-02	5PC600.X885-01	5PC600.X885-03	5PC600.X885-03	Enter values in this column 
		<b>Total power supply (max.)</b>										<b>110</b>	
Add-on UPS module, optional		7.5	7.5	7.5	7.5	7.5	7.5	7.5	7.5	7.5	7.5		
		<b>max. possible at 5V</b>										<b>55</b>	
5V	CPU Board, fixed device	14	18	25	17	21	23	23	37	37			
	per CompactFlash, optional (add-on, slide-in)	1	1	1	1	1	1	1	1	1			
	Hard Disk, optional (add-on, slide-in)	4	4	4	4	4	4	4	4	4			
	External keyboard PS/2, optional	1	1	1	1	1	1	1	1	1			
	USB Peripheral, optional (max. 2.5 watts per USB1 and USB2 connection)	5	5	5	5	5	5	5	5	5			
	Interface option (add-on interface), optional	0.5	0.5	0.5	0.5	0.5	0.5	0.5	0.5	0.5			
	External consumer, optional (via BaseBoard)	5	5	5	5	5	5	5	5	5			
		<b>Devices 5V ∑</b>											
		<b>max. possible at 3V3</b>										<b>23</b>	
3V3	System unit, fixed device	4	4	4	4	4	4	4	4	4			
	Interface option (add-on interface), optional	0.25	0.25	0.25	0.25	0.25	0.25	0.25	0.25	0.25			
	<b>Devices 3V3 ∑</b>												
		<b>max. possible at +12V</b>										<b>12</b>	
+12V	Fan kit, optional	2.5	2.5	2.5	2.5	2.5	2.5	2.5	2.5	2.5			
	External consumer, optional (via BaseBoard)	10	10	10	10	10	10	10	10	10			
	<b>Devices +12V ∑</b>												
		<b>PCI bus and slide-in power supply (max.)</b>										<b>50</b>	
		<b>max. possible at 5V PCI bus and slide-in</b>										<b>50</b>	
5V	per CompactFlash, optional (slide-in)	1	1	1	1	1	1	1	1	1			
	per Hard Disk, optional (slide-in)	4	4	4	4	4	4	4	4	4			
	per Drive, optional (slide-in CD,DVD)	4	4	4	4	4	4	4	4	4			
	PCI card manufacturer limit, optional (max. 3 watts without fan kit, max. 17 watts with fan kit) <sup>1)</sup>												
-12V	<b>max. possible at -12V PCI bus and slide-in</b>										<b>1.2</b>		
	PCI card manufacturer limit, optional (max. 1.2 watts without and with fan kit) <sup>1)</sup>												
	<b>Devices total 5V ∑</b>												
		<b>max. possible at 3V3 PCI bus and slide-in</b>										<b>23</b>	
3V3	PCI card manufacturer limit, optional (max. 3 watts without fan kit, max. 17 watts with fan kit) <sup>1)</sup>												
		<b>Devices 3V3 ∑</b>											
		<b>max. possible at +12V PCI bus and slide-in</b>										<b>12</b>	
+12V	PCI card manufacturer limit, optional (max. 3 watts without fan kit, max. 12 watts with fan kit) <sup>1)</sup>												
		<b>Devices +12V ∑</b>											
	<b>Total PCI bus and slide-in ∑</b>												
	<b>Devices total ∑</b>												

1) The total performance of one PCI card per PCI slot (= sum of power consumptions for each voltage area) may not exceed the limits stated for operation with or without a fan kit.

See section "Starting current", on page 136 for starting current values.

## 2.12 Power management for the APC620 embedded system unit

### 2.12.1 Supply voltage for the 5PC600.SE00-00, 5PC600.SE00-01 and 5PC600.SE00-02

The following block diagram presents the simplified structure of the APC620 embedded supply voltage for system units 5PC600.SE00-00, 5PC600.SE00-01 and 5PC600.SE00-02.

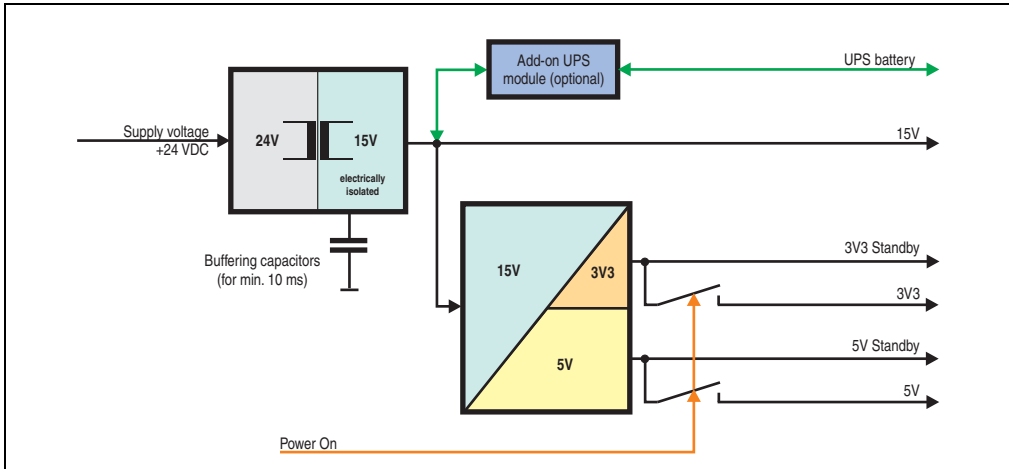

Figure 34: Supply voltage for the 5PC600.SE00-00, 5PC600.SE00-01 and 5PC600.SE00-02

#### **Explanation:**

The supply voltage is converted to 15 V with a DC/DC converter. These electrically isolated 15 V feed four further DC/DC converters, which generate the remaining voltages.

After the system is turned on (e.g. using the power button), the voltages 3V3 and 5 V are placed on the bus.

The optional APC620 add-on UPS and battery unit is supplied with 15 V and provides an uninterrupted power supply from the 15 V bus during power failures.

2.12.2 Power calculation with 5PC600.SE00-00, 5PC600.SE00-01 and 5PC600.SE00-02

Information:		APC620 embedded system unit 5PC600.SE00-00, 5PC600.SE00-01 and 5PC600.SE00-02								This system		
		CM 600 5PC600.X855-04	CM 1000 5PC600.X855-05	PM 1100 5PC600.X855-00	PM 1400 5PC600.X855-02						Enter values in this column ↓	
Total power supply		<b>Total power supply (maximum)</b>								<b>55</b>		
		Add-on UPS module, optional		7,5	7,5	7,5	7,5					
		<b>Maximum possible at 5V</b>								<b>55</b>		
		CPU board, fixed device		17	21	23	23					
		Per CompactFlash, optional (add-on, slide-in)		1	1	1	1					
		USB peripheral, optional (max. 2.5 watts per USB1 and USB3 connection)		5	5	5	5					
		USB peripheral, optional (max. 5 watts per USB2 and USB4 connection)		10	10	10	10					
		Devices 5V $\Sigma$										
		<b>Maximum possible at 3V3</b>								<b>23</b>		
		System unit, fixed device		4	4	4	4					
Devices 3V3 $\Sigma$												
Devices total $\Sigma$												

See section "Starting current", on page 136 for starting current values.

## 2.13 Humidity specifications

The following table displays the minimum and maximum humidity for the individual components that are relevant for the humidity limitations of the entire device. The lowest and highest common values are always used when establishing these limits.

Component	Operation	Storage / Transport	
CPU boards 815E (ETX)	10 to 90%	5 to 95%	
CPU boards 855GME (ETX / XTX)	10 to 90%	5 to 95%	
System units (all models)	5 to 90%	5 to 95%	
Main memory for CPU boards	10 to 90%	5 to 95%	
Add-on drives	5AC600.HDDI-00 (24 hours/default)	8 to 90%	5 to 95%
	5AC600.HDDI-01 (ET)	8 to 90%	5 to 95%
	5AC600.HDDI-02 (ET)	8 to 90%	5 to 95%
	5AC600.HDDI-03 (ET)	8 to 90%	5 to 95%
	5AC600.HDDI-04 (ET)	8 to 90%	5 to 95%
	5AC600.HDDI-05 (ET, 24x7)	5 to 90%	5 to 95%
	5AC600.HDDI-06 (ET, 24x7)	5 to 90%	5 to 95%
	5AC600.SDDI-00 ≤ D0	5 to 95%	5 to 95%
	5AC600.SDDI-00 ≥ E0	10 to 95%	10 to 95%
Slide-in drives	5AC600.CDXS-00	8 to 80%	5 to 95%
	5AC600.DVDS-00	8 to 80%	5 to 95%
	5AC600.DVRS-00	8 to 80%	5 to 95%
	5AC600.FDDS-00	20 to 80%	5 to 90%
	5AC600.HDDS-00 (ET, 24x7)	8 to 90%	5 to 95%
	5AC600.HDDS-01 (ET)	8 to 90%	5 to 95%
	5AC600.HDDS-02 (ET, 24x7)	5 to 90%	5 to 95%
Additional insert cards Interfaces AP Link	5AC600.CANI-00	5 to 90%	5 to 95%
	5AC600.485I-00	5 to 90%	5 to 95%
	5AC600.SDL0-00	5 to 90%	5 to 95%
	5ACPCI.RAIS-00 (24 hours/default)	8 to 90%	5 to 95%
	5ACPCI.RAIS-01 (24 hours/default)	8 to 90%	5 to 95%
	5ACPCI.RAIC-01 (24 hours/default)	5 to 90%	5 to 95%
	5ACPCI.RAIC-02 (24 hours/default)	5 to 90%	5 to 95%
	5ACPCI.RAIC-03 (24 hours/default)	8 to 90%	5 to 95%
	5ACPCI.RAIC-04 (24 hours/default)	8 to 90%	5 to 95%
	5ACPCI.RAIC-05 (24 hours/default)	5 to 95%	5 to 95%
	5MMHDD.0250-00 (24 hours/default)	5 to 95%	5 to 95%

Table 29: Overview of humidity specifications for individual components

Component		Operation	Storage / Transport
Accessories	CompactFlash cards 5CFCRD.xxxx-06	85%	85%
	CompactFlash cards 5CFCRD.xxxx-04	85%	85%
	CompactFlash cards - 5CFCRD.xxxx-03	8 to 95%	8 to 95%
	Flash drive 5MMUSB.xxxx-00	10 to 90%	5 to 90%
	Flash drive 5MMUSB.2048-01	10 to 90%	5 to 90%
	USB Media Drive 5MD900.USB2-00	20 to 80%	5 to 90%
	USB Media Drive 5MD900.USB2-01	20 to 80%	5 to 90%

Table 29: Overview of humidity specifications for individual components

The listed specifications correspond to the relative humidity at an ambient temperature of 30°C. More detailed information about the specific temperature-dependent humidity values can be found in the technical data for the individual components.



## 2.14 Device interfaces

The following two graphics show the general and optional device interfaces on an APC620 complete device with 5 PCI slots or an APC620 embedded device.

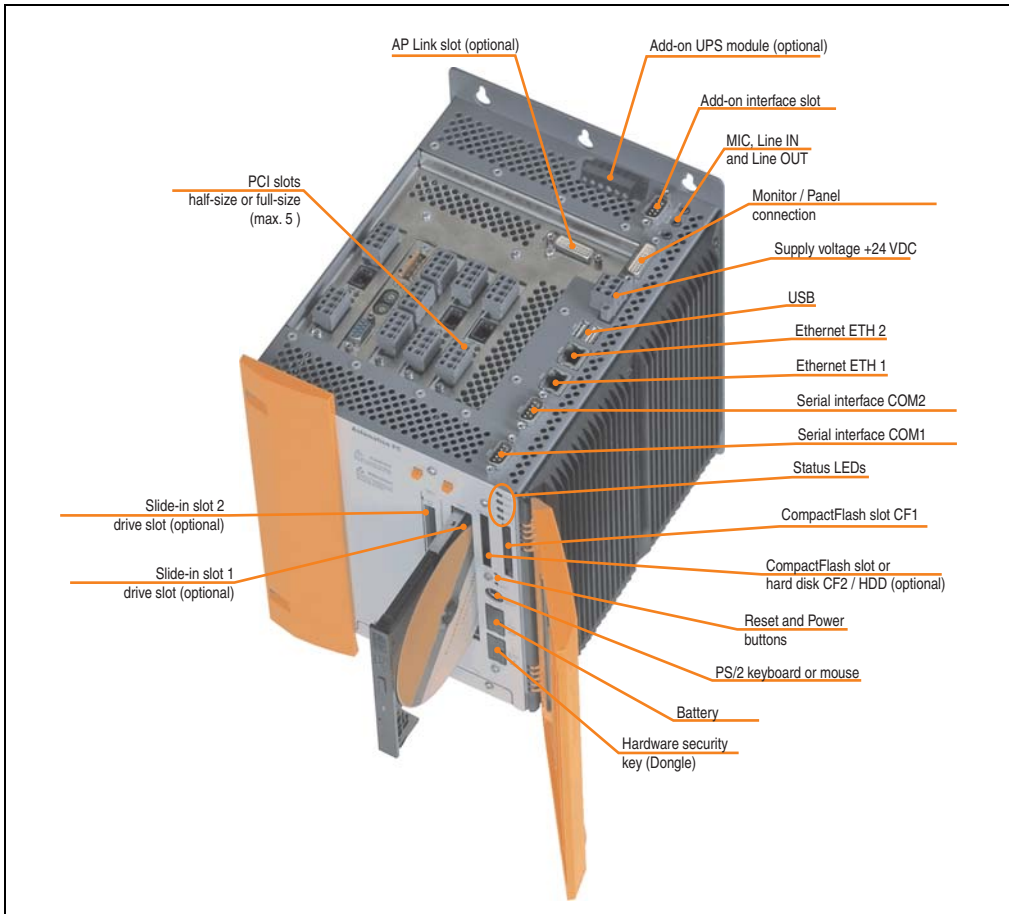

Figure 35: General device interfaces example - APC620 with 5 PCI slots

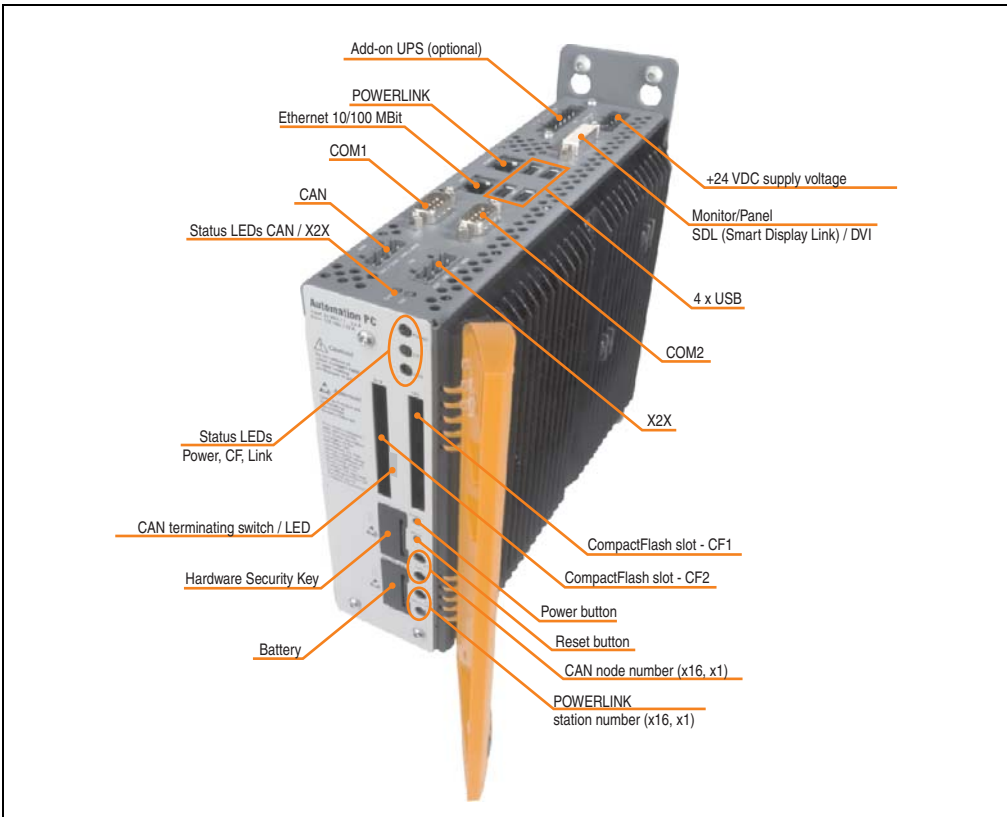

Figure 36: General device interfaces example - APC620 embedded

Each individual device interface is explained in greater detail on the following pages.

### 2.14.1 Serial interface COM1

Serial interfaces COM1 <sup>1)</sup>	
Type	RS232, modem-capable, not electrically isolated
UART	16550-compatible, 16-byte FIFO
Transfer rate	Max. 115 kBaud
Cable length	Max. 15 meters
Pin	Assignment
1	DCD
2	RXD
3	TXD
4	DTR
5	GND
6	DSR
7	RTS
8	CTS
9	RI

9-pin DSUB, male



Table 30: Pin assignments - COM1

1) The interfaces, etc. available on the device or module were numbered accordingly for easy identification. This numbering can differ from the numbering used by the particular operating system.

### I/O address and IRQ

Resource	Default setting	Additional setting options
I/O address	3F8	2F8, 3E8, 2E8
IRQ	IRQ4	IRQ3

Table 31: COM1 - I/O address and IRQ

The setting for the I/O address and the IRQ can be changed in the BIOS setup (under "Advanced" - submenu "I/O Device Configuration" setting "Serial port A"). Please note any potential conflicts with other resources when changing this setting.

### 2.14.2 Serial interface COM2

Serial interfaces COM2 <sup>1)</sup>	
Type	RS232, modem-capable, not electrically isolated
UART	16550 compatible, 16 byte FIFO
Transfer rate	Max. 115 kBaud
Cable length	Max. 15 meters
Pin	Assignment
1	DCD
2	RXD
3	TXD
4	DTR
5	GND
6	DSR
7	RTS
8	CTS
9	RI

9-pin DSUB, male



Table 32: Pin assignments - COM2

1) The interfaces, etc. available on the device or module were numbered accordingly for easy identification. This numbering can differ from the numbering used by the particular operating system.

### I/O address and IRQ

Resource	Default setting	Additional setting options
I/O address	2F8	3F8, 3E8, 2E8
IRQ	IRQ3	IRQ4

Table 33: COM2 - I/O address and IRQ

The setting for the I/O address and the IRQ can be changed in the BIOS setup (under "Advanced" - submenu "I/O Device Configuration" setting "Serial port B"). Please note any potential conflicts with other resources when changing this setting.

### 2.14.3 X2X (only APC620 embedded)

X2X Link interface (only APC620 embedded)	
The electrically isolated X2X Link is a 4-pin multipoint connector.	
Pin	X2X Link
1	X2X
2	X2X_L
3	X2X_I
4	SHLD (shield)

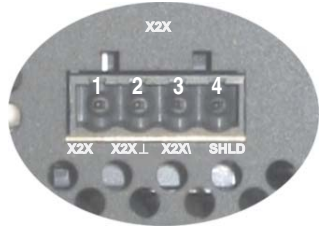

Table 34: X2X pin assignments (only APC620 embedded)

#### Driver support

The fieldbus interface X2X is only supported together with Automation Runtime (for more information, see section "Automation PC 620 with Automation Runtime", on page 564).

### 2.14.4 CAN (only APC620 embedded)

CAN	
The electrically isolated CAN bus interface is a 4-pin multipoint connector.	
Transfer rate	Max. 500 kBit/s
Bus length	Max. 1000 meters
Pin	CAN bus
1	CAN_H (CAN High)
2	CAN_L (CAN ground)
3	CAN_L (CAN Low)
4	SHLD (shield)



Table 35: CAN pin assignments (only APC620 embedded)

#### Driver support

The fieldbus interface CAN is only supported together with Automation Runtime (for more information, see section "Automation PC 620 with Automation Runtime", on page 564).

### 2.14.5 CAN node number (only APC620 embedded)

CAN node number switch (x1, x16) - only APC620 embedded		
Both of these hex switches (x16, x1) are used to configure the node number for the CAN interface.		
Switch position		
x16	x1	Description
0 ... F	0 ... F	Any

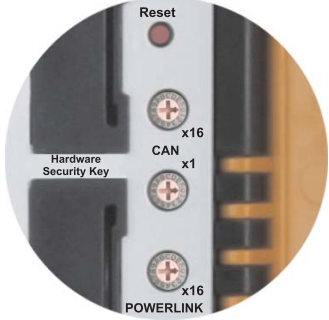

Table 36: CAN node number switch (x1, x16) - only APC620 embedded

### 2.14.6 CAN terminating switch / LED (only APC620 embedded)

CAN terminating switch / LED (only APC620 embedded)		
CAN networks are cabled using a bus structure where both ends of the bus are equipped with terminating resistors. The APC620 embedded has an integrated terminating resistor (delivery state: disabled with the setting "Off").		
LED	On	Off
Yellow	The terminating resistor integrated in the bus controller is turned on.	The terminating resistor integrated in the bus controller is turned off.
CAN terminating switch	Position Off	Position On
Can be pressed using a pointed object.	Terminating resistor is turned off.	Terminating resistor is turned on.

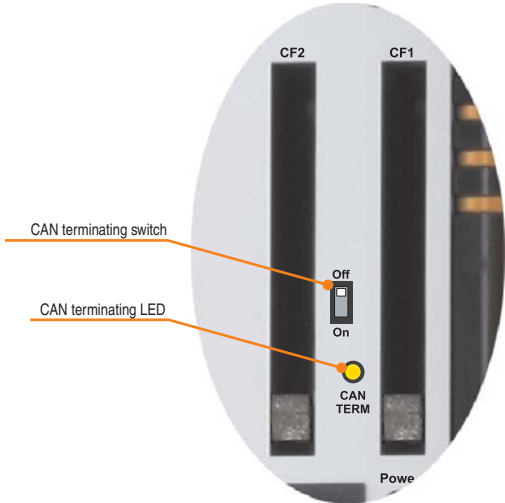

Table 37: CAN terminating switch / LED (only APC620 embedded)

### 2.14.7 Status LEDs CAN / X2X (only APC620 embedded)

Status LEDs CAN / X2X (only APC620 embedded)			
Yellow LED for	On	Off	
CAN	Sends data	Receives data	
X2X	Sends data	Receives data	

Table 38: Status LEDs CAN / X2X (only APC620 embedded)

### 2.14.8 POWERLINK (only APC620 embedded)

POWERLINK (only APC620 embedded)			
Controller			
Cabling	S/STP (Cat5e)		
Transfer rate			
Cable length	max. 100 m (min. Cat5e)		
LED color	On	Off	
Green/red	see Status / Error LED		
Green	Link (POWERLINK network connection available)	Activity (blinking) (Data transfer in progress)	

Table 39: POWERLINK (only APC620 embedded)

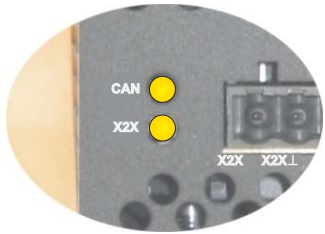
### Driver support

The fieldbus interface POWERLINK is only supported together with Automation Runtime (for more information, see section "Automation PC 620 with Automation Runtime", on page 564).

### Status / Error LED

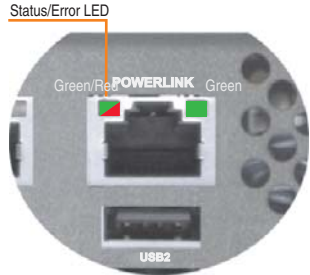
The status/error LED is a green/red dual LED. The color green (status) is superimposed on the color red (error).

Red - error	Description
On	The POWERLINK interface has encountered an error (failed Ethernet frames, increased number of collisions on the network, etc.).

Table 40: Status / Error LED as error LED - POWERLINK V2 operating mode

## Technical Data • Entire device

Green - status	Description
Off NOT_ACTIVE	<p><b>Managing Node (MN)</b> The bus is monitored for POWERLINK frames. If a frame is not received within the configured time window (timeout), the interface goes directly into PRE_OPERATIONAL_1 status (single flash). If, however, POWERLINK communication is detected before this time passes, the interface goes directly into the BASIC_ETHERNET status (flickering).</p> <p><b>Controlled Node (CN)</b> The bus is monitored for POWERLINK frames. If a frame is not received within the configured time window (timeout), the interface goes directly into BASIC_ETHERNET status (flickering). If, however, POWERLINK communication is detected during this time, the interface goes directly into the PRE_OPERATIONAL_1 status (single flash).</p>
Green flickering (approx. 10 Hz) BASIC_ETHERNET	<p>The interface is in BASIC_ETHERNET status, and is operated purely as an Ethernet TCP/IP interface.</p> <p><b>Managing Node (MN)</b> This status can only be changed by resetting the interface.</p> <p><b>Controlled Node (CN)</b> If POWERLINK communication is detected while in this status, the interface goes into the PRE_OPERATIONAL_1 state (single flash).</p>
Single flash (approx. 1 Hz) PRE_OPERATIONAL_1	<p>The interface status is PRE_OPERATIONAL_1.</p> <p><b>Managing Node (MN)</b> The MN starts the operation of the "reduced cycle". Collisions are allowed on the bus. There is not yet any cyclic communication.</p> <p><b>Controlled Node (CN)</b> The CN waits until it receives an SoC frame and then switches to PRE_OPERATIONAL_2 status (double flash).</p>
Double flash (approx. 1 Hz) PRE_OPERATIONAL_2	<p>The interface status is PRE_OPERATIONAL_2.</p> <p><b>Managing Node (MN)</b> The MN begins with the cyclic communication (cyclic input data is not yet evaluated). The CNs are configured in this status.</p> <p><b>Controlled Node (CN)</b> In this status, the interface is normally configured by the manager. After this, a command changes the status to READY_TO_OPERATE (triple flash).</p>
Triple flash (approx. 1 Hz) READY_TO_OPERATE	<p>The interface status is READY_TO_OPERATE.</p> <p><b>Managing Node (MN)</b> Normal cyclic and asynchronous communication. Received PDO data is ignored.</p> <p><b>Controlled Node (CN)</b> The configuration of the interface is complete. Normal cyclic and asynchronous communication. The PDO data sent corresponds to the PDO mapping used. However, cyclic data is not yet evaluated.</p>
On OPERATIONAL	<p>The interface status is OPERATIONAL.</p>
Blinking (approx. 2.5 Hz) STOPPED	<p>The interface status is STOPPED.</p> <p><b>Managing Node (MN)</b> This status is not possible for the MN.</p> <p><b>Controlled Node (CN)</b> No output data is produced and no input data is received. Only the appropriate command from the manager can enter or leave this state.</p>

Table 41: Status/Error LED as status LED - POWERLINK V2 operating mode



### 2.14.9 POWERLINK station number (only APC620 embedded)

POWERLINK station number (x1, x16)		
Both of these hex switches (x16, x1) are used to configure the station number for the POWERLINK. Station numbers are permitted between #00 and #FD.		
Switch position		
x16	x1	Description
0	0	Operation as managing node
0 ... F	1 ... D	station number Operation as controlled node
F	E	Reserved
F	F	Reserved



Table 42: POWERLINK station number (x1, x16) - only APC620 embedded

### 2.14.10 Ethernet connection ETH (only APC620 embedded)

This Ethernet connection is integrated in the CPU board being used.

Ethernet connection ETH (only APC620 embedded)		
Controller	Intel 82562	
Cabling	S/STP (Cat5e)	
Transfer rate	10/100 MBit/s <sup>1)</sup>	
Cable length	max. 100 m (min. Cat5e)	
LED	On	Off
Green	100 Mbit/s	10 Mbit/s
Orange	Link (Ethernet network connection available)	Activity (blinking) (Data transfer in progress)



Table 43: Ethernet connection ETH (only APC620 embedded)

1) Both operating modes possible. Change-over takes place automatically.

### 2.14.11 Ethernet connection ETH1

This Ethernet connection is integrated in the CPU board being used.

Ethernet connection (ETH1 <sup>1)</sup> )		
Controller	Intel 82562	
Cabling	S/STP (Cat5e)	
Transfer rate	10/100 MBit/s <sup>2)</sup>	
Cable length	See table45 "Ethernet cable length in conjunction with 5PC600.E855-xx CPU boards (ETX)", on page 131 and table 46 "Ethernet cable length in conjunction with 5PC600.E855-xx CPU boards", on page 131.	
<b>LED</b>	<b>On</b>	<b>Off</b>
Green	100 Mbit/s	10 Mbit/s
Orange	Link (Ethernet network connection available)	Activity (blinking) (Data transfer in progress)

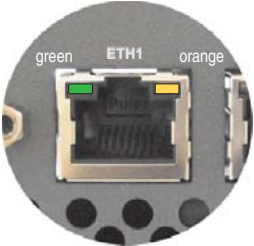

Table 44: Ethernet connection (ETH1)

- 1) The interfaces, etc. available on the device or module were numbered accordingly for easy identification. This numbering can differ from the numbering used by the particular operating system.
- 2) Both operating modes possible. Change-over takes place automatically.

### Driver support

A special driver is necessary for operating the Intel Ethernet controller 82562. Drivers for Windows XP Professional, Windows XP Embedded, Windows Embedded Standard 2009 and DOS are available for download on the B&R Homepage in the download area ([www.br-automation.com](http://www.br-automation.com)).

## Information:

**Required drivers can only be downloaded from the B&R homepage, not from manufacturers' pages.**

### Ethernet cable length when 855GME (ETX) CPU boards are used.

The supported cable length depends on the system unit revision when using Intel 855GME CPU boards (5PC600.E855-xx (ETX)).

System unit	Cable length with CAT5e cable	
	Up to 50 meters	Up to 80 meters <sup>1)</sup>
5PC600.SX01-00	Revision < H0	Starting with Revision H0
5PC600.SX02-00	Revision < F5	Starting with Revision F5
5PC600.SX02-01	Revision < G5	Starting with revision G5
5PC600.SF03-00	-	Starting with revision A0
5PC600.SX05-00	Revision < G0	Starting with revision G0
5PC600.SX05-01	Revision < G0	Starting with revision G0

Table 45: Ethernet cable length in conjunction with 5PC600.E855-xx CPU boards (ETX)

1) When higher quality cable is used (e.g.: category CAT7), greater distances are possible.

### Ethernet cable length when 855GME (XTX) CPU boards are used.

The supported cable length depends on the system unit revision when using Intel 855GME CPU boards (5PC600.E855-xx (XTX)).

System unit	Cable length with CAT5e cable	
	Up to 50 meters	Up to 100 meters
5PC600.SX01-00	Revision < H0	Starting with Revision H0
5PC600.SX02-00	Revision < F5	Starting with Revision F5
5PC600.SX02-01	Revision < G5	Starting with revision G5
5PC600.SF03-00	-	Starting with Revision A0
5PC600.SX05-00	Revision < G0	Starting with revision G0
5PC600.SX05-01	Revision < G0	Starting with revision G0

Table 46: Ethernet cable length in conjunction with 5PC600.E855-xx CPU boards

### Special features when 855GME (XTX) CPU boards are used.

The hardware supports Auto MDX, which means an integrated switch automatically determines if the connected cable is crossed or not and adjusts itself accordingly. However, Auto MDX must be supported by the Ethernet driver used by the operating system.

B&R recommends not using the Auto MDX function during cabling, and instead using it only as a diagnostics or testing feature.

### 2.14.12 Ethernet connection ETH2

This Ethernet connection is integrated in the system unit.

Ethernet connection (ETH2 <sup>1)</sup> )		
Controller	Intel 82551ER	
Cabling	S/STP (Cat5e)	
Transfer rate	10/100 MBit/s <sup>2)</sup>	
Cable length	max. 100 m (min. Cat5e)	
<b>LED</b>	<b>On</b>	<b>Off</b>
Green	100 Mbit/s	10 Mbit/s
Orange	Link (Ethernet network connection available)	Activity (blinking) (Data transfer in progress)

RJ45 twisted pair (10BaseT/100BaseT), female

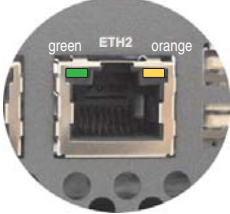

Table 47: Ethernet connection (ETH2)

- 1) The interfaces, etc. available on the device or module were numbered accordingly for easy identification. This numbering can differ from the numbering used by the particular operating system.
- 2) Both operating modes possible. Change-over takes place automatically.

### Driver support

A special driver is necessary for operating the Intel Ethernet controller 82551ER. Drivers for Windows XP Professional, Windows XP Embedded, Windows Embedded Standard 2009 and DOS are available for download on the B&R Homepage in the download area ([www.br-automation.com](http://www.br-automation.com)).

## Information:

**Required drivers can only be downloaded from the B&R homepage, not from manufacturers' pages.**

### 2.14.13 USB port

The APC620 devices have a USB 2.0 (Universal Serial Bus) host controller with multiple USB ports, two of which are on the outside for easy user access.

See the section "USB connection (only APC620 embedded)", on page 134 for a description of the USB connections on APC620 embedded devices.

Universal Serial Bus (USB1 und USB2) <sup>1)</sup>		
Transfer rate	Low speed (1.5 MBit/s), Full speed (12 MBit/s) up to High speed (480 MBit/s)	2x USB Type A, female 
Power supply	Max. 500 mA per port <sup>2)</sup>	
Maximum Cable length	5 m (without hub)	

Table 48: USB port

1) The interfaces, etc. available on the device or module were numbered accordingly for easy identification. This numbering can differ from the numbering used by the particular operating system.

2) For safety, every USB port is equipped with a maintenance free "USB current-limiting circuit breaker" (max. 500 mA)

## Warning!

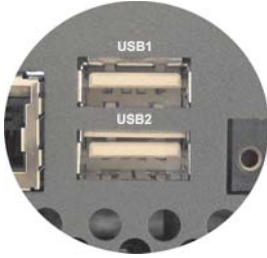
**Peripheral USB devices can be connected to the USB interfaces. Due to the vast number of USB devices available on the market, B&R cannot guarantee their performance. B&R does ensure the performance of all USB devices that they provide.**

## Warning!

**Because of general PC specifications, this interface should be handled with extreme care with regard to EMC, location of cables, etc.**

### Driver support

For optimal functionality of USB 2.0 (transfer speed up to 480 Mbit/s) with Windows XP, at least Service Pack 1 must be installed. Without Service Pack 1, Windows XP will only support USB 1.1.

USB 2.0 comes already integrated in B&R's XP embedded operating systems.

### 2.14.14 USB connection (only APC620 embedded)

The APC620 embedded devices have a USB 2.0 (Universal Serial Bus) host controller with multiple USB ports, two of which are on the outside for easy access.

Universal Serial Bus (USB1, USB2, USB3, USB4) <sup>1)</sup> - only APC620 embedded		
Transfer rate	Low speed (1.5 MBit/s), Full speed (12 MBit/s) up to High speed (480 Mbit/s)	<p>4 x USB type A, female</p> 
Power supply <sup>2)</sup> USB1, USB3 USB2, USB4	Max. 500 mA Max. 1 A	
Maximum Cable length	5 m (without hub)	

Table 49: USB connections 4 x - only APC620 embedded

- 1) The interfaces, etc. available on the device or module were numbered accordingly for easy identification. This numbering can differ from the numbering used by the particular operating system.
- 2) For safety, every USB port is equipped with a maintenance free "USB current-limiting circuit breaker" (max. 500 mA or 1 A). The sum of all 4 USB ports must not exceed the limit of 2 A.

## Warning!

**Peripheral USB devices can be connected to the USB interfaces. Due to the vast number of USB devices available on the market, B&R cannot guarantee their performance. B&R does ensure the performance of all USB devices that they provide.**

## Warning!

**Because of general PC specifications, this interface should be handled with extreme care with regard to EMC, location of cables, etc.**

### 2.14.15 +24 VDC supply voltage

The Automation PC 620 has a 24 VDC ATX compatible power supply. Depending on the system unit, the power supply provides the following maximum performances (in watts).

System unit	Max. power at + 5 V	Max. power at + 3V3	Max. power at + 12 V	Max. power at - 12 V	Max. total power
5PC600.SX01-00	55	23	12	1.2	70
5PC600.SX02-00	55	23	12	1.2	70
5PC600.SX02-01	55	23	12	1.2	70
5PC600.SF03-00	105	46	24	1.2	110
5PC600.SX05-00	105	46	24	1.2	110
5PC600.SX05-01	105	46	24	1.2	110
5PC600.SE00-00	55	23	12	1.2	55
5PC600.SE00-01	55	23	12	1.2	55
5PC600.SE00-02	55	23	12	1.2	55

Table 50: Power supply depending on the system unit

The 3-pin socket required for the supply voltage connection is not included in delivery. This can be ordered from B&R using the model number OTB103.9 (screw clamp) or OTB103.91 (cage clamp).

The pin assignments can be found either in the following table or printed on the APC620 housing. The supply voltage is internally protected (10A, fast-acting), so that the device cannot be damaged if there is an overload (fuse replacement necessary) or if the voltage supply is connected incorrectly (reverse polarity protection - fuse replacement not necessary).

Supply voltage	
Protected against reverse polarity	
Pin	Description
1	+
2	Functional ground
3	-
Accessories	
OTB103.9	Plug 24 V 5.08 3p screw clamps
OTB103.91	Plug 24 V 5.08 3p cage clamps

3-pin, male



Figure 37: Supply voltage connection

Ground

**Caution!**

**Functional ground (pin 2 of power supply and ground connection) must be kept as short as possible and connected to the largest possible wire cross section at the central grounding point (e.g. the control cabinet or system).**

The grounding connection can be found on the bottom of the APC620 systems. The M4 self-locking nut can be used, for example, to fasten a copper strip that is built into the APC620 at a central grounding point in the switching cabinet or system. The largest possible conductor cross section should be used (at least 2.5 mm<sup>2</sup>).

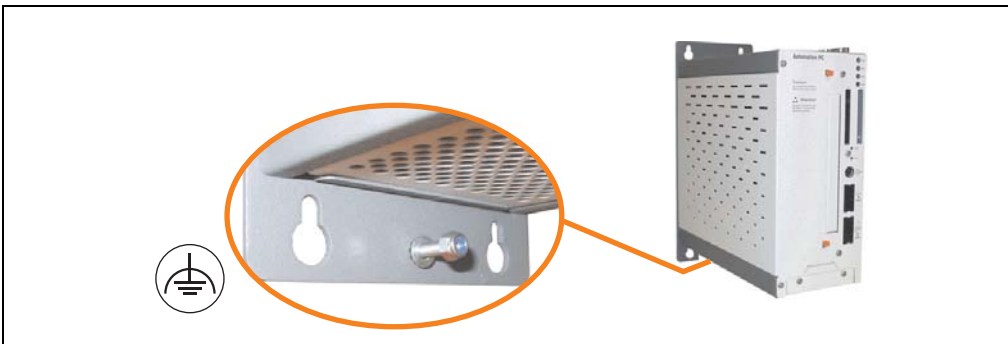

Figure 38: Ground connection

Also see the section "Grounding concept", on page 307.

Starting current

System unit	Typical	Maximum
5PC600.SX01-00	7 A	40 A (time < 300 μs)
5PC600.SX02-00	7 A	40 A (time < 300 μs)
5PC600.SX02-01	7 A	40 A (time < 300 μs)
5PC600.SF03-00	10 A	40 A (time < 300 μs)
5PC600.SX05-00	10 A	40 A (time < 300 μs)
5PC600.SX05-01	10 A	40 A (time < 300 μs)
5PC600.SE00-00	7 A	40 A (time < 300 μs)
5PC600.SE00-01	7 A	40 A (time < 300 μs)
5PC600.SE00-02	7 A	40 A (time < 300 μs)

Table 51: Starting currents in the voltage supply to the system units



### Quick switching on/off of the power supply

If the APC620 is in Standby mode (e.g. Windows XP shutdown), then buffering takes a little more time due to capacitors and low power consumption. If the "Power Loss Control" option is set to "Power On" or "Last State" in BIOS, then a system with one of the system unit revisions in table 52 "System unit revisions for at least 10 seconds turn-off time" might not restart because a Power Off/On was not detected. To make sure that these system units will restart after a Power Off/On, the turn-off time should be set to at least 10 seconds.

Model number	Description	Revision
5PC600.SX01-00	System 1 PCI	Starting with revision B0
5PC600.SX02-00	System 2 PCI, 1 disk drive slot, 1 AP Link slot	Starting with revision B0
5PC600.SX02-01	System 2 PCI, 1 disk drive slot	Starting with revision B0
5PC600.SX05-00	System 5 PCI, 2 disk drive slots, 1 AP Link slot	Starting with revision A0
5PC600.SX05-01	System 5 PCI, 2 disk drive slots	Starting with revision A0

Table 52: System unit revisions for at least 10 seconds turn-off time

Thanks to a workaround, the turn-off time can be set as needed in systems with one of the following system unit revisions or higher.

Model number	Description	Revision
5PC600.SX01-00	System 1 PCI	Starting with F0
5PC600.SX02-00	System 2 PCI, 1 disk drive slot, 1 AP Link slot	Starting with revision E0
5PC600.SX02-01	System 2 PCI, 1 disk drive slot	Starting with F0
5PC600.SF03-00	System 3 PCI, 1 disk drive slot, 1 AP Link slot	Starting with revision A0
5PC600.SX05-00	System 5 PCI, 2 disk drive slots, 1 AP Link slot	Starting with revision D0
5PC600.SX05-01	System 5 PCI, 2 disk drive slots	Starting with revision D0
5PC600.SE00-00	APC60 embedded variation, 512 KB	Starting with revision A0
5PC600.SE00-01	APC60 embedded variation, 512 KB	Starting with revision A0
5PC600.SE00-02	APC60 embedded variation, 1 MB	Starting with revision A0

Table 53: System unit revisions for any turn-off times

### 2.14.16 Monitor / Panel connection

When using this video output, understand that the video signals that are available (RGB, DVI, and SDL - Smart Display Link) will vary depending on the system unit and CPU board.

Monitor / Panel			
The following will provide an overview of the video signals available with different system units and CPU boards. For details, see technical data for the CPU board being used.			<p>24-pin DVI-I with special functions, female</p> 
System unit	815E board (ETX)	855GME board (ETX / XTX)	
5PC600.SX01-00	RGB, DVI, SDL	RGB, DVI, SDL (GE1)	
5PC600.SX02-00	RGB	RGB, DVI, SDL (GE1)	
5PC600.SX02-01	RGB, DVI, SDL	RGB, DVI, SDL (GE2)	
5PC600.SF03-00	RGB, DVI, SDL	RGB, DVI, SDL (GE2)	
5PC600.SX05-00	RGB	RGB, DVI, SDL (GE1)	
5PC600.SX05-01	RGB, DVI, SDL	RGB, DVI, SDL (GE1)	
5PC600.SE00-00	-	RGB, DVI, SDL (GE1)	
5PC600.SE00-01	-	RGB	
5PC600.SE00-02	-	RGB, DVI, SDL (GE1)	

Figure 39: Monitor / Panel connection

Hotplug for a display device is not supported in any combination. The plugs are specified for 100 connection cycles.

## Caution!

The RGB, DVI and SDL cables can only be plugged in and unplugged when the APC620 and display device (Automation Panel 900, Automation Panel 800, monitor) are turned off.

See "Definitions for RGB, DVI, SDL", on page 142 for descriptions of RGB, DVI and SDL.

Pin assignments

Pin	Assignment	Pin	Assignment
1	T.M.D.S. Data 2-	16	Hot Plug detect
2	T.M.D.S. Data 2+	17	T.M.D.S. Data 0-
3	T.M.D.S. Data 2/SDL Shield	18	T.M.D.S. Data 0+
4	SDL-	19	T.M.D.S. DATA 0/XUSB1 Shield
5	SDL+	20	XUSB1-
6	DDC clock	21	XUSB1+
7	DDC data	22	T.M.D.S. Clock Shield
8	Analog vertical sync	23	T.M.D.S. Clock +
9	T.M.D.S. DATA 1-	24	T.M.D.S. Clock -
10	T.M.D.S. DATA 1+	c1	Analog red video out
11	T.M.D.S. DATA 1/XUBS0 Shield	c2	Analog green video out
12	XUSB0-	c3	Analog blue video out
13	XUSB0+	c4	Analog horizontal sync
14	+ 5 V power <sup>1)</sup>	c5	Analog ground (analog R, G and B return)
15	Ground (return for + 5V, HSync and VSync)		

DVI-I 24 pin, female

Table 54: Pin assignments - Monitor / panel connection

1) Protected internally by a multifuse

Cable lengths and resolutions for SDL transfer

The following table shows the relationship between segment lengths and the maximum resolution according to the SDL cable used:

Cables Segment length [m]	Resolution				
	VGA 640 x 480	SVGA 800 x 600	XGA 1024 x 768	SXGA 1280 x 1024	UXGA 1600 x 1200
1.8	5CASDL.0018-00 5CASDL.0018-01 5CASDL.0018-03	5CASDL.0018-00 5CASDL.0018-01 5CASDL.0018-03	5CASDL.0018-00 5CASDL.0018-01 5CASDL.0018-03	5CASDL.0018-00 5CASDL.0018-01 5CASDL.0018-03	5CASDL.0018-00 5CASDL.0018-01 5CASDL.0018-03
5	5CASDL.0050-00 5CASDL.0050-01 5CASDL.0050-03	5CASDL.0050-00 5CASDL.0050-01 5CASDL.0050-03	5CASDL.0050-00 5CASDL.0050-01 5CASDL.0050-03	5CASDL.0050-00 5CASDL.0050-01 5CASDL.0050-03	5CASDL.0050-00 5CASDL.0050-01 5CASDL.0050-03
10	5CASDL.0100-00 5CASDL.0100-01 5CASDL.0100-03	5CASDL.0100-00 5CASDL.0100-01 5CASDL.0100-03	5CASDL.0100-00 5CASDL.0100-01 5CASDL.0100-03	5CASDL.0100-00 5CASDL.0100-01 5CASDL.0100-03	5CASDL.0100-00 <sup>1)</sup> 5CASDL.0100-01 <sup>1)</sup> 5CASDL.0100-03 <sup>1)</sup>

Table 55: Segment lengths, resolutions and SDL cables

## Technical Data • Entire device

Cables Segment length [m]	Resolution				
	VGA 640 x 480	SVGA 800 x 600	XGA 1024 x 768	SXGA 1280 x 1024	UXGA 1600 x 1200
15	5CASDL.0150-00 5CASDL.0150-01 5CASDL.0150-03	5CASDL.0150-00 5CASDL.0150-01 5CASDL.0150-03	5CASDL.0150-00 5CASDL.0150-01 5CASDL.0150-03	5CASDL.0150-00 <sup>1)</sup> 5CASDL.0150-01 <sup>1)</sup> 5CASDL.0150-03 <sup>1)</sup>	- - -
20	5CASDL.0200-00 <sup>1)</sup> 5CASDL.0200-03 <sup>1)</sup>	5CASDL.0200-00 <sup>1)</sup> 5CASDL.0200-03 <sup>1)</sup>	5CASDL.0200-00 <sup>1)</sup> 5CASDL.0200-03 <sup>1)</sup>	5CASDL.0200-00 <sup>1)</sup> 5CASDL.0200-03 <sup>1)</sup>	-
25	5CASDL.0250-00 <sup>1)</sup> 5CASDL.0250-03 <sup>1)</sup>	5CASDL.0250-00 <sup>1)</sup> 5CASDL.0250-03 <sup>1)</sup>	5CASDL.0250-00 <sup>1)</sup> 5CASDL.0250-03 <sup>1)</sup>	- -	- -
30	5CASDL.0300-00 <sup>1)</sup> 5CASDL.0300-03 <sup>1)</sup>	5CASDL.0300-00 <sup>1)</sup> 5CASDL.0300-03 <sup>1)</sup>	5CASDL.0300-10 <sup>2)</sup> 5CASDL.0300-13 <sup>2)</sup>	5CASDL.0300-10 <sup>2)</sup> 5CASDL.0300-13 <sup>2)</sup>	- -
40	5CASDL.0400-10 <sup>2)</sup> 5CASDL.0400-13 <sup>2)</sup>	5CASDL.0400-10 <sup>2)</sup> 5CASDL.0400-13 <sup>2)</sup>	5CASDL.0400-10 <sup>2)</sup> 5CASDL.0400-13 <sup>2)</sup>	5CASDL.0400-10 <sup>2)</sup> 5CASDL.0400-13 <sup>2)</sup>	- -

Table 55: Segment lengths, resolutions and SDL cables (Forts.)

- 1) See table 56 "Requirements for SDL cable with automatic cable adjustment (equalizer)", on page 140  
 2) See table 57 "Requirements for SDL cable with extender and automatic cable adjustment (equalizer)", on page 141

The cable types and resolutions shown with a footnote 1) in the previous table can only be implemented starting with the following firmware and hardware versions:

Firmware	Name	Version	Note
MTCX FPGA	Firmware on the APC620	v 01.15	The version is read from BIOS - see the BIOS description. Supported starting with the APC620 / PPC 700 Firmware upgrade (MTCX, SDLR, SDLT) <b>V01.10</b> , available in the download area of the B&R homepage.
MTCX PX32	Firmware on the APC620	v 01.55	
SDLR FPGA	Firmware on the AP Link SDL receiver and transceiver	v 01.04	
SDLT FPGA	Firmware on the AP Link SDL transmitter	v 00.02	
Hardware	Name	Revision	Note
5DLSDL.1000-00	AP Link SDL receiver	Rev. B0	
5DLSDL.1000-01	AP Link SDL transceiver	Rev. B0	

Table 56: Requirements for SDL cable with automatic cable adjustment (equalizer)

The cable types and resolutions shown with a footnote 2) in the previous table can only be implemented starting with the following firmware and hardware versions:

Firmware	Name	Version	Note
MTCX FPGA	Firmware on the APC620	v 01.15	The version is read from BIOS - see the BIOS description. Supported starting with the APC620 / PPC 700 Firmware upgrade (MTCX, SDLR, SDLT) <b>V01.10</b> , available in the download area of the B&R homepage.
MTCX PX32	Firmware on the APC620	v 01.55	
SDLR FPGA	Firmware on the AP Link SDL receiver and transceiver	v 01.04	
SDLT FPGA	Firmware on the AP Link SDL transmitter	v 00.02	
Hardware	Name	Revision	Note
5DLSDL.1000-00	AP Link SDL receiver	Rev. D0	
5DLSDL.1000-01	AP Link SDL transceiver	Rev. D0	
5AC600.SDL0-00	AP Link SDL transmitter	Rev. B3	
5PC600.SX01-00	System 1 PCI	Rev. E0	
5PC600.SX02-00	System 2 PCI, 1 disk drive slot, 1 AP Link slot	Rev. D0	
5PC600.SX02-01	System 2 PCI, 1 disk drive slot	Rev. E0	
5PC600.SF03-00	System 3 PCI, 1 disk drive slot, 1 AP Link slot	Rev. A0	
5PC600.SX05-00	System 5 PCI, 2 disk drive slots, 1 AP Link slot	Rev. C0	
5PC600.SX05-01	System 5 PCI, 2 disk drive slots	Rev. C0	

Table 57: Requirements for SDL cable with extender and automatic cable adjustment (equalizer)

## Definitions for RGB, DVI, SDL

RGB means:

- It is possible to connect RGB monitors (with adapter, model nr. 5AC900.1000-00) and office RGB TFT displays.

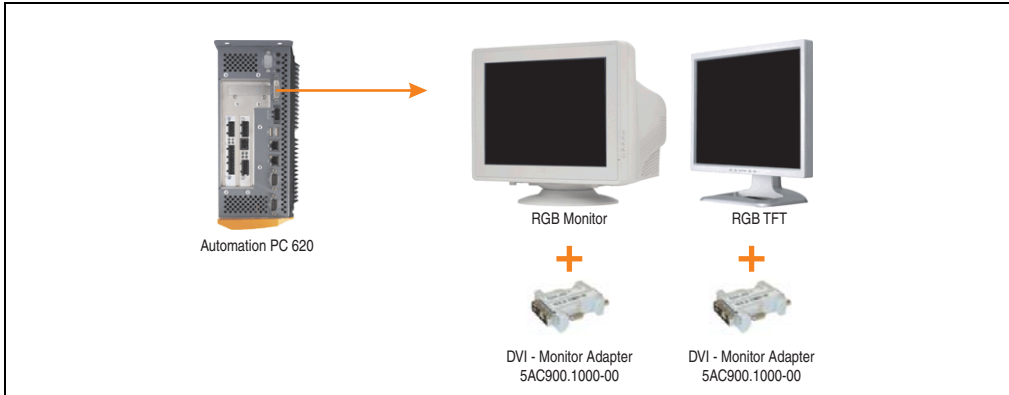

Figure 40: Monitor / Panel connection with RGB video signal

DVI means:

- Connection of B&R Automation Panel 900 display units with Automation Panel Link DVI Receiver (Model nr. 5DLDVI.1000-01), Office Digital/DVI Monitors and Office DVI TFT Displays is possible.

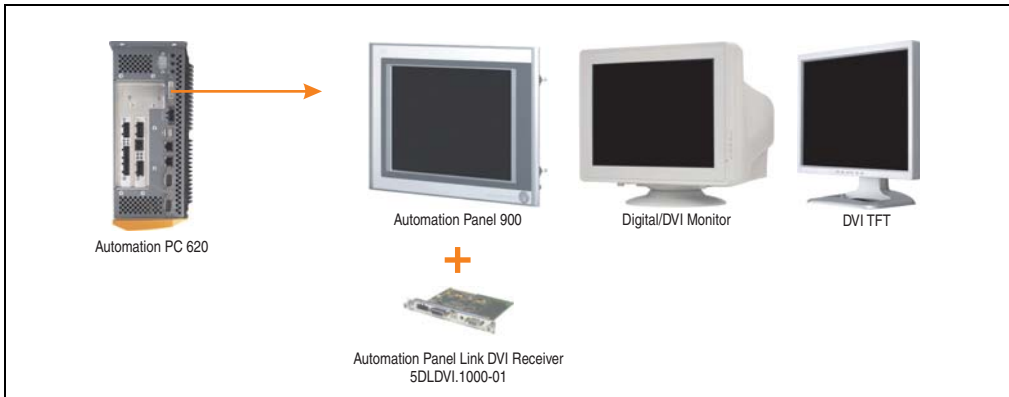

Figure 41: Monitor / Panel connection with DVI video signal

For examples and possibilities for connecting Automation Panel 900 display units via DVI, see Appendix A, chapter 3 "Commissioning", section 4 "Connection examples", starting on page 308.

SDL (Smart Display Link) means:

- Connection of B&R Automation Panel 800 and Automation Panel 900 display units with Automation Panel Link SDL receiver (Model nr. 5DLSDL.1000-01) or SDL transceiver (Model nr. 5DLSDL.1000-01).

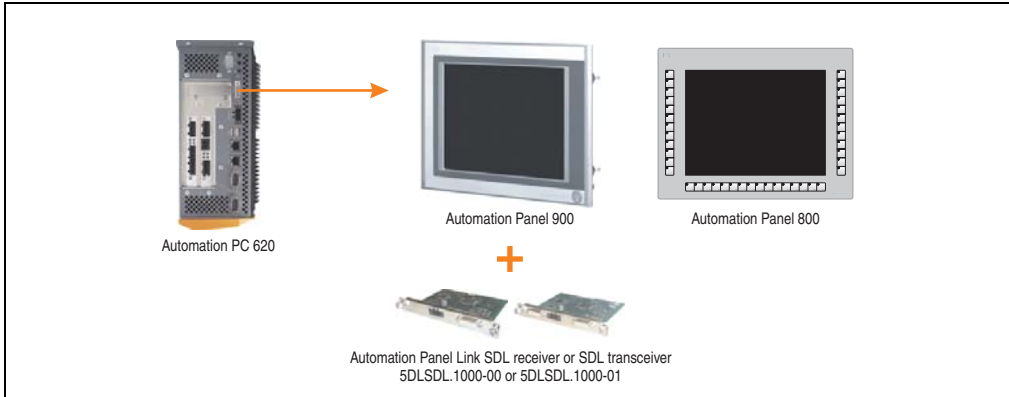

Figure 42: Monitor / Panel connection with SDL video signal

For examples and possibilities for connecting Automation Panel 900 and Automation Panel 800 display units via SDL, see Appendix A, chapter 3 "Commissioning", section 4 "Connection examples", starting on page 308.

### 2.14.17 MIC, Line IN and Line OUT ports

All APC620 systems include an AC97 (specification 2.2) compatible sound chip with access to the channels MIC, Line IN and Line OUT from the outside.

#### Information:

**APC620 embedded devices do not have these connections.**

MIC, Line IN and Line OUT		
Controller	Realtek AC97	
MIC	Connection of a mono microphone with a 3.5 mm stereo (headphone) jack.	
Line IN	Stereo Line IN signal supplied via 3.5 mm jack.	
Line OUT	Connection of a stereo sound device (e.g. amplifier) via a 3.5 mm jack.	

Table 58: Technical data - MIC, Line IN and Line OUT port

#### Driver support

A special driver is necessary for operating the AC97 sound chip (Realtek). Drivers for Windows XP Professional, Windows XP Embedded, Windows Embedded Standard 2009 are available for download on the B&R Homepage in the download area ([www.br-automation.com](http://www.br-automation.com)).

#### Information:

**Required drivers can only be downloaded from the B&R homepage, not from manufacturers' pages.**



### 2.14.18 Add-on interface slot

An optional add-on interface (e.g. CAN, RS485) can be installed here. See also section 3.9 "Interface options", on page 274.

#### Information:

**APC620 embedded devices do not have this option.**

Add-on interface slot	
<b>Available add-on interfaces</b>	
5AC600.CANI-00	Add-on CAN interface
5AC600.485I-00	Add-on RS232/422/485 interface



Table 59: Add-on interface slot

#### Information:

**An add-on interface module is only available factory-installed.**

### 2.14.19 Add-on UPS module slot

An optional APC620 add-on UPS module can be installed here.

Add-on UPS module slot	
<b>APC620 add-on UPS module + accessories</b>	
5AC600.UPSI-00	Add-on UPS module
5AC600.UPSB-00	Battery unit 5 Ah
5CAUPS.0005-00	APC620 UPS cable 0.5 m
5CAUPS.0030-00	APC620 UPS cable 3 m



The image shows a grey, oval-shaped APC620 add-on UPS module. It features a central rectangular display area with a '+' sign on the left and a '-' sign on the right. Above the display are two small vertical bars. The top of the module has a series of circular ventilation holes. The word 'Option' is printed on the left side and 'UPS' on the right side. Two screws are visible on the bottom edge.

Table 60: Add-on UPS module slot

## Information:

An add-on UPS module can be installed with the following system unit revisions or later:

- 5PC600.SX01-00 starting with H0
- 5PC600.SX02-00 starting with G0
- 5PC600.SX02-01 starting with H0
- 5PC600.SF03-00 starting with A0
- 5PC600.SX05-00 starting with F0
- 5PC600.SX05-01 starting with F0
- 5PC600.SE00-00 starting with A0
- 5PC600.SE00-01 starting with A0
- 5PC600.SE00-02 starting with A0

For more on the UPS module, see chapter 6 "Accessories", section 16 "Uninterruptible power supply", on page 720.

For info on configuring the UPS module, see chapter 4 "Software", section 9.4 "UPS configuration", on page 599.

For info on installing the UPS module, see chapter 7 "Maintenance / Servicing", section 5 "Installing the UPS module", on page 765.

### 2.14.20 AP Link Slot

The option of inserting and using an AP Link card is only possible with system units 5PC600.SX02-00, 5PC600.SF03-00 and 5PC600.SX05-00.

For more information see section 3.11 "AP Link cards", on page 288.

#### Information:

APC620 embedded devices do not have this option.

### 2.14.21 PCI slots

#### Information:

APC620 embedded devices do not have a PCI slot.

Up to 5 PCI slots are available, depending on the system unit. 5-volt cards or universal cards that comply with the PCI half-size standard 2.2, and that do not exceed the following dimensions can be inserted.

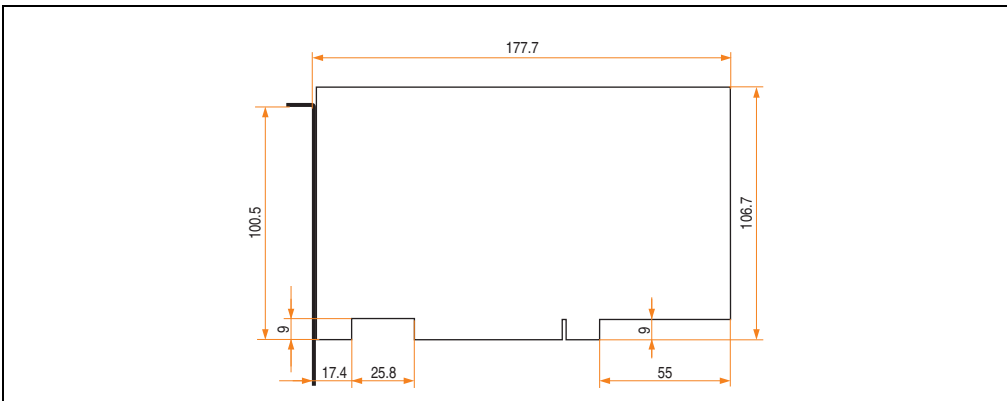

Figure 43: Dimensions - Standard half-size PCI cards

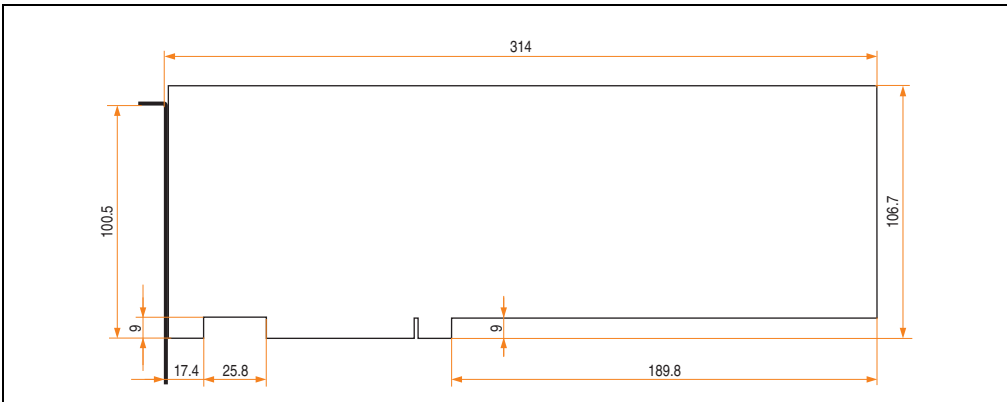

Figure 44: Dimensions - Standard full-size PCI cards

## Information:

The total performance of one PCI card per PCI slot should not exceed the limit with or without a fan kit (see section "Power management APC620 system unit with 1 PCI slot", on page 97 or section "Power management APC620 system unit with 3 PCI slots", on page 107 and "Power management APC620 system units with 5 PCI slots", on page 109).

## Technical data

Features	PCI bus properties
Default	PCI 2.2
Design	Half-size PCI or full-size PCI <sup>1)</sup> 5 Volt connector
PCI bus type	32-bit
PCI bus speed	33 MHz

Table 61: Technical data - PCI bus

1) Only in conjunction with system unit 5PC600.SF03-00.

**Voltages on the PCI slot plug (plug-in PCI cards)**

The plug design for the PCI slot is the same as the design for a 5-volt PCI plug. The supply is applied at 3.3 volts and 5 volts on the actual plug.

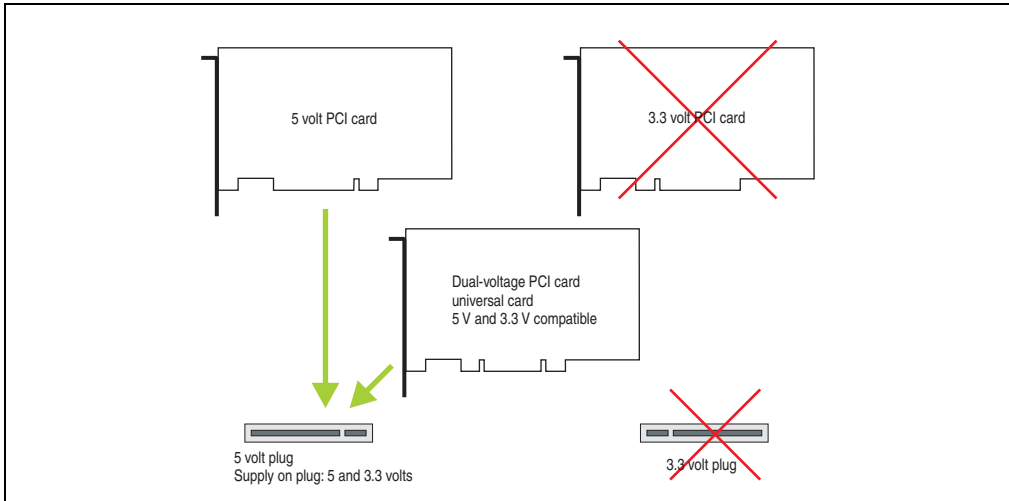

Figure 45: PCI connector type: 5 volt

### 2.14.22 Status LEDs

The status LEDs are integrated in the system unit behind the orange front cover.

See the section "Status LEDs Power, CF, Link (only APC620 embedded)", on page 151 for a description of the status LEDs on APC620 embedded devices.

Status LEDs			
LED	Color		Meaning
Power	Green	On	Supply voltage OK
	Red	On	The system is in standby mode (S5: soft-off mode or S4: Hibernate mode -Suspend-to-Disk)
	Orange <sup>1)</sup>	On	Supply voltage not OK; the system is operating on battery power.
HDD	Yellow	On	Signals IDE drive access (CF, HDD, CD, etc.)
Link 1	Yellow	On	Active SDL connection.
		blinking	An active SDL connection has been interrupted by a loss of power in the display unit.
		Off	No active SDL connection available.
Link 2	Yellow	On	Active SDL connection on the AP Link slot.
		blinking	An active SDL connection on the AP Link slot has been interrupted by a loss of power in the display unit.
		Off	No active SDL connection on the AP Link slot available.



Table 62: Technical data - Status LEDs

1) Only lit when add-on UPS module is installed.

The light for the status LEDs is fed to the front cover via fiber optic lines.



Figure 46: Front-side status LEDs

### 2.14.23 Status LEDs Power, CF, Link (only APC620 embedded)

The status LEDs are integrated in the system unit behind the orange front cover.

Status LEDs Power, CF, Link (only APC620 embedded)			
LED	Color		Meaning
Power	Green	On	Supply voltage OK
	Red	On	The system is in standby mode (S5: soft-off mode or S4: Hibernate mode -Suspend-to-Disk)
	Orange <sup>1)</sup>	On	Supply voltage not OK; the system is operating on battery power.
CF	Yellow	On	Indicates access to CompactFlash (read or write)
Link	Yellow	On	Active SDL connection on the monitor/panel connection
		blinking	An active SDL connection has been interrupted by a loss of power in the display unit.
		Off	No active SDL connection available.

Table 63: Status LEDs Power, CF, Link (only APC620 embedded)

1) Only lit when add-on UPS module is installed.

**2.14.24 CompactFlash slot (CF1)**

This CompactFlash slot is a fixed component of an APC620 system, and is defined in BIOS as the primary master IDE device. Type I CompactFlash cards are supported. Available CompactFlash cards - see table 17 "Model numbers - CompactFlash cards", on page 43.

See the section "CompactFlash slots (only APC620 embedded)", on page 155 for a description of the CompactFlash slots on APC620 embedded devices.

CompactFlash slot (CF1)	
Connection	Primary master IDE device
CompactFlash Type	Type I
Accessories	Short description
5CFCRD.0512-06	512 MB B&R CompactFlash card
5CFCRD.1024-06	1024 MB B&R CompactFlash card
5CFCRD.2048-06	2048 MB B&R CompactFlash card
5CFCRD.4096-06	4096 MB B&R CompactFlash card
5CFCRD.8192-06	8192 MB B&R CompactFlash card
5CFCRD.016G-06	16 GB B&R CompactFlash card
5CFCRD.032G-06	32 GB B&R CompactFlash card
5CFCRD.0064-03	CompactFlash 64 MB SSI
5CFCRD.0128-03	CompactFlash 128 MB SSI
5CFCRD.0256-03	CompactFlash 256 MB SSI
5CFCRD.0512-03	CompactFlash 512 MB SSI
5CFCRD.1024-03	CompactFlash 1024 MB SSI
5CFCRD.2048-03	CompactFlash 2048 MB SSI
5CFCRD.4096-03	CompactFlash 4096 MB SSI
5CFCRD.8192-03	CompactFlash 8192 MB SSI



Table 64: Technical data - CompactFlash slot (CF1)

**Warning!**

**Inserting and removing the CompactFlash card can only take place without power applied!**



### 2.14.25 Hard disk / CompactFlash slot (HDD/CF2)

This slot allows for the installation of a hard disk or a second CompactFlash slot (type I CompactFlash card) as add-on drives (see table 5.7 "Drives" for available add-on drives). The add-on drive is referred to in BIOS as the primary slave drive.

See the section "CompactFlash slots (only APC620 embedded)", on page 155 for a description of the CompactFlash slots on APC620 embedded devices.

## Information:

**Add-on drives are only available factory-installed. Therefore, they need to be requested when placing an order.**

Hard disk / CompactFlash slot (HDD/CF2)	
Connection	Primary slave IDE device
<b>Add-on hard disks 2.5" drive (internal)</b>	
5AC600.HDDI-05	Add-on hard disk 40 GB ET, 24/7
5AC600.HDDI-06	Add-on hard disk 80 GB ET, 24/7
5AC600.SSDI-00	Add-on SSD 128 GB MLC
<b>Add-on CompactFlash slot</b>	
5AC600.CFSI-00	Add-on CompactFlash slot
CompactFlash Type	Type I
<b>Accessories</b>	<b>Short description</b>
5CFCRD.0512-06	512 MB B&R CompactFlash card
5CFCRD.1024-06	1024 MB B&R CompactFlash card
5CFCRD.2048-06	2048 MB B&R CompactFlash card
5CFCRD.4096-06	4096 MB B&R CompactFlash card
5CFCRD.8192-06	8192 MB B&R CompactFlash card
5CFCRD.016G-06	16 GB B&R CompactFlash card
5CFCRD.032G-06	32 GB B&R CompactFlash card
5CFCRD.0064-03	CompactFlash 64 MB SSI
5CFCRD.0128-03	CompactFlash 128 MB SSI
5CFCRD.0256-03	CompactFlash 256 MB SSI
5CFCRD.0512-03	CompactFlash 512 MB SSI
5CFCRD.1024-03	CompactFlash 1024 MB SSI
5CFCRD.2048-03	CompactFlash 2048 MB SSI
5CFCRD.4096-03	CompactFlash 4096 MB SSI
5CFCRD.8192-03	CompactFlash 8192 MB SSI



Table 65: Technical data - Hard disk / CompactFlash slot (HDD/CF2)

## **Warning!**

Inserting and removing the CompactFlash card can only take place without power applied!

### 2.14.26 CompactFlash slots (only APC620 embedded)

These CompactFlash slots are a fixed part of an APC620 embedded system and are defined in the BIOS as Primary Master (CF1) and Primary Slave (CF2) drive. Type I CompactFlash cards are supported.

CompactFlash slot (CF1 / CF2)	
Connection CF1 CF2	Primary master IDE device Primary slave IDE device
CompactFlash Type	Type I
Accessories	Short description
5CFCRD.0512-06	512 MB B&R CompactFlash card
5CFCRD.1024-06	1024 MB B&R CompactFlash card
5CFCRD.2048-06	2048 MB B&R CompactFlash card
5CFCRD.4096-06	4096 MB B&R CompactFlash card
5CFCRD.8192-06	8192 MB B&R CompactFlash card
5CFCRD.016G-06	16 GB B&R CompactFlash card
5CFCRD.032G-06	32 GB B&R CompactFlash card
5CFCRD.0064-03	CompactFlash 64 MB SSI
5CFCRD.0128-03	CompactFlash 128 MB SSI
5CFCRD.0256-03	CompactFlash 256 MB SSI
5CFCRD.0512-03	CompactFlash 512 MB SSI
5CFCRD.1024-03	CompactFlash 1024 MB SSI
5CFCRD.2048-03	CompactFlash 2048 MB SSI
5CFCRD.4096-03	CompactFlash 4096 MB SSI
5CFCRD.8192-03	CompactFlash 8192 MB SSI

Table 66: CompactFlash slots (CF1 / CF2) - APC620 embedded

## Warning!

Inserting and removing the CompactFlash card can only take place without power applied!

### 2.14.27 Power button

Due to the complete ATX power supply support, the power button serves various functions. These functions can be configured either in the BIOS setup (see BIOS function "Power button function" in section "Power", on page 409 for 815E CPU boards (ETX), or section "Power", on page 465 for 855GME CPU boards (ETX) or section "Power", on page 523 for 855GME CPU boards (XTX)) or, for example, in the operating system Windows XP.

Power button	
<p>The power button can be pressed with a pointed object (i.e. paper clip or tip of a pen).</p> <p>The power button acts like the on/off switch on a normal desktop PC with ATX power supply:  <b>Press and release</b> ... Switches on APC620 or shuts down operating system and switches off the APC620.  <b>Press and hold</b> ... ATX power supply switches off without shutting down the APC620 (<b>data could be lost!</b>).</p> <p>Pressing the power button does not reset the MTCX processor.</p>	

Table 67: Technical data - Power button

### 2.14.28 Reset button

Reset button	
<p>The reset button can be pressed with a pointed object (i.e. paper clip or tip of a pen).</p> <p>Pushing the reset button results in a hardware-reset, PCI-reset. The APC620 is restarted (cold restart).</p> <p>The MTCX processor is not reset when the reset button is pressed.</p>	

Table 68: Technical data - Reset button

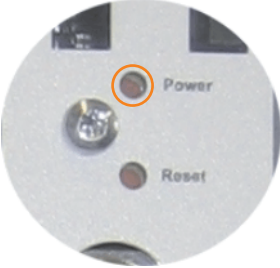
## Warning!

**A system reset can cause data to be lost!**

### 2.14.29 PS/2 keyboard/mouse

Slot for a standard PS/2 mouse or a PS/2 AT-Enhanced keyboard. BIOS automatically determines whether a mouse or a keyboard has been connected, and transfers this information to the operating system.

#### Information:

**APC620 embedded devices do not have a PS/2 interface.**

With a PS/2 Y-cable, both keyboard and mouse can be operated simultaneously. They must be connected before the system is switched on.

This interface has a Hot-Plug function for PS/2 keyboards (only when no PS/2 mouse has ever been connected and used!).

Connection for keyboard/mouse (PS/2)	
Pin	Assignment
1	DATA 0
2	DATA 1
3	GND
4	+5 V <sup>1)</sup>
5	CLK 0
6	CLK 1

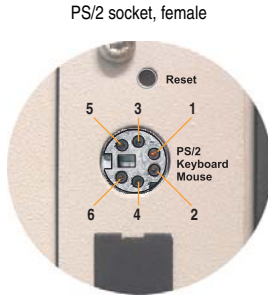

PS/2 socket, female

Reset

PS/2 Keyboard Mouse

Table 69: Technical data - PS/2 keyboard/mouse (external PS/2)

1) The PS/2 keyboard/mouse interface is protected by a multifuse (1 A).

#### Warning!

**Because of general PC specifications, this interface should be used with extreme care concerning EMC, location of cables, etc.. It should therefore only be used for service!**

#### Information:

The BIOS setup defaults only allow for the operation of a PS/2 keyboard. If a PS/2 mouse is connected, it must be activated in BIOS. In order to do this, set "PS/2 mouse" in the BIOS setup menu to "enabled" and save. (Located under Advanced - Miscellaneous - Item "PS/2 mouse").

### 2.14.30 Battery

The lithium battery (3 V, 950 mAh) buffers the internal real-time clock (RTC) as well as the individually saved BIOS settings and is located behind the black cover. The buffer duration of the battery is at least 4 years (2½ years with the SRAM module model number 5AC600.SRAM-00 or with an APC620 embedded system unit and at 50°C, 8.5 mA current requirements of the supplied components and a self discharge of 40%). The battery is subject to wear and should be replaced regularly (at least following the specified buffer duration).

Battery	
Battery Type Removable Lifespan	Renata 950 mAh Yes, accessible from the outside 4 years <sup>1) 2)</sup>
Accessories	Short description
0AC201.91	Lithium batteries, 4 pcs. Lithium batteries (4 pcs.), 3 V / 950 mAh, button cell
4A0006.00-000	Lithium battery, 1 pc. Lithium battery (1 pcs.), 3 V / 950 mAh, button cell

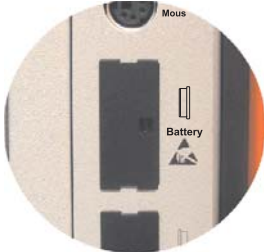

APC620 with 1, 2, 3 and 5 PCI slots

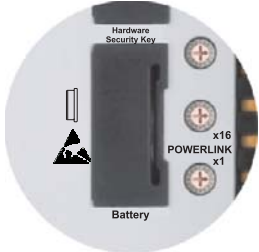

APC620 embedded

Table 70: Technical data - battery

1) At 50°C, 8.5 µA of the supplied components and a self discharge of 40%.

2) The buffer duration is 2½ years if a SRAM module (Mod.Nr. 5AC600.SRAM-00) is installed or in conjunction with an APC620 embedded system unit.

For more on changing the lithium battery, see chapter 7 "Maintenance / Servicing", section "Changing the battery", on page 743.

For technical information on the lithium battery, see chapter 6 "Accessories", section 4 "Replacement CMOS batteries", on page 641.

### Battery status evaluation

The battery status is evaluated immediately following start-up of the device and is subsequently checked by the system every 24 hours. The battery is subjected to a brief load (1 second) during the measurement and then evaluated. The evaluated battery status is displayed in the BIOS Setup pages (under Advanced - Baseboard monitor) and in the B&R Control Center (ADI driver), but can also be read in a customer application via the ADI Library.

Battery status	Meaning
N/A	Hardware, i.e. firmware used is too old and does not support read.
GOOD	Data buffering is guaranteed

Table 71: Meaning of battery status

Battery status	Meaning
BAD	Data buffering is guaranteed for approx. another 500 hours from the point in time that the battery capacity is determined to be BAD (insufficient).

Table 71: Meaning of battery status

[Hardware requirements \(system unit\)](#)

- 5PC600.SX01-00 starting with Rev I0
- 5PC600.SX01-00 starting with Rev. H0
- 5PC600.SX02-01 starting with Rev. K0
- 5PC600.SF03-00 starting with Rev. A0
- 5PC600.SX05-00 starting with Rev. H0
- 5PC600.SX05-01 starting with Rev. H0

[Firmware / BIOS requirements](#)

- APC620 / Panel PC 700 Firmware Upgrade V1.19 (MTCX PX32: V1.63, MTCX FPGA V1.19)
- BIOS 855GME (ETX) V1.26, BIOS 855GME (XTX) V1.14

### 2.14.31 Hardware Security Key

B&R recommends a hardware security key (dongle) based on the DS1425 from MAXIM (previously Dallas Semiconductors) for software copy protection.

Hardware Security Key	
<p>A hardware security key (dongle) can be inserted behind the black cover.</p>	

Table 72: Technical data - Hardware security key

## Warning!

Turn off power before removing or adding the hardware security key.

### I/O address and IRQ

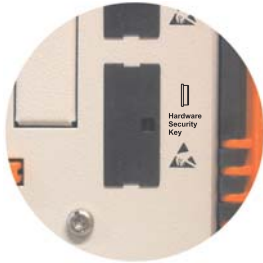
Resource	Default setting	Additional setting options
I/O address	378	278, 3BC
IRQ	-	-

Table 73: Hardware security key - I/O address and IRQ

The setting for the I/O address and the IRQ can be changed in the BIOS setup (under "Advanced" - submenu "I/O device configuration" setting "Parallel port").



### 2.14.32 Slide-in slot 1 drive slot

The "slide-in slot 1" drive slot exists only in APC620 system units with 2, 3 or 5 PCI slots. It is possible to insert a number of slide-in drives into it. See table for available slide-in drives 10 "Model numbers - Drives", on page 40.

For instructions about installing and replacing a slide-in, see chapter 7 "Maintenance / Servicing", section 4 "Slide-in drive - installation and exchange", on page 762.

The slide-in CD-ROM (5AC600.CDXS-00) and the slide-in DVD-ROM/CD-RW (5AC600.DVDS-00) and DVD-R/RW, DVD+R/RW (5AC600.DVRS-00) drive are referred to in BIOS as "secondary slave". The slide-in USB FDD drive (5AC600.FDDS-00) is referred to as USB.

#### Information:

- It is possible to add, remove, or modify the slide-in drive at any time.
- In system units with 5 PCI slots, the slide-in USB FDD (5AC600.FDDS-00) drive must be inserted in slide-in slot 1 for mechanical reasons. The slide-in drive 5AC600.CFSS-00 (slide-in CF 2-slot) should only be operated in slide-in slot 2.

#### Caution!

Turn off power before adding or removing a slide-in drive.

Slide-in slot 1	
Connection	Secondary slave IDE device
Accessories	Short description
5AC600.CDXS-00	Slide-in CD-ROM
5AC600.CFSS-00	Slide-in CF 2-slot
5AC600.DVDS-00	Slide-in DVD-ROM/CD-RW
5AC600.DVRS-00	Slide-in DVD-R/RW, DVD+R/RW
5AC600.FDDS-00	Slide-in USB FDD
5AC600.HDDS-02	40 GB 24x7 ET slide-in hard disk

Table 74: Technical data - Slide-in slot 1

### 2.14.33 Slide-in slot 2 drive slot

The "slide-in slot 2" drive slot exists only in APC620 system units with 5 PCI slots. It is possible to insert a number of slide-in drives into it. See table for available slide-in drives 10 "Model numbers - Drives", on page 40.

For instructions about installing and replacing a slide-in, see chapter 7 "Maintenance / Servicing", section 4 "Slide-in drive - installation and exchange", on page 762.

The slide-in CD-ROM (5AC600.CDXS-00) and the slide-in DVD-ROM/CD-RW (5AC600.DVDS-00) and DVD-R/RW, DVD+R/RW (5AC600.DVRS-00) drive are referred to in BIOS as "secondary master". The slide-in USB FDD drive (5AC600.FDDS-00) is referred to as USB.

## Information:

- It is possible to add or remove a slide-in drive at any time.
- In system units with 5 PCI slots, the slide-in USB FDD (5AC600.FDDS-00) drive must be inserted in slide-in slot 1 for mechanical reasons. The slide-in drive 5AC600.CFSS-00 (slide-in CF 2-slot) should only be operated in slide-in slot 2.

## Caution!

Turn off power before adding or removing a slide-in drive.

Slide-in slot 2	
Connection	Secondary master IDE device
Accessories	Short description
5AC600.CDXS-00	Slide-in CD-ROM
5AC600.CFSS-00	Slide-in CF 2-slot
5AC600.DVDS-00	Slide-in DVD-ROM/CD-RW
5AC600.DVRS-00	Slide-in DVD-R/RW, DVD+R/RW
5AC600.FDDS-00	Slide-in USB FDD
5AC600.HDDS-02	Slide-in hard disk 40 GB 24x7, ET

Table 75: Technical data - Slide-in slot 2

## 2.15 Serial number sticker

Each B&R device is assigned a unique serial number label with a bar code (type 128), which allows the device to be clearly identified.

The serial number for the entire device is located behind the front door. This serial number represents all of the components built into the system (model number, name, revision, serial number, delivery date and duration of warranty).



Figure 47: APC620 serial number sticker on front-side

A sticker with detailed information about the individual components can also be found on the back side of the mounting plate.

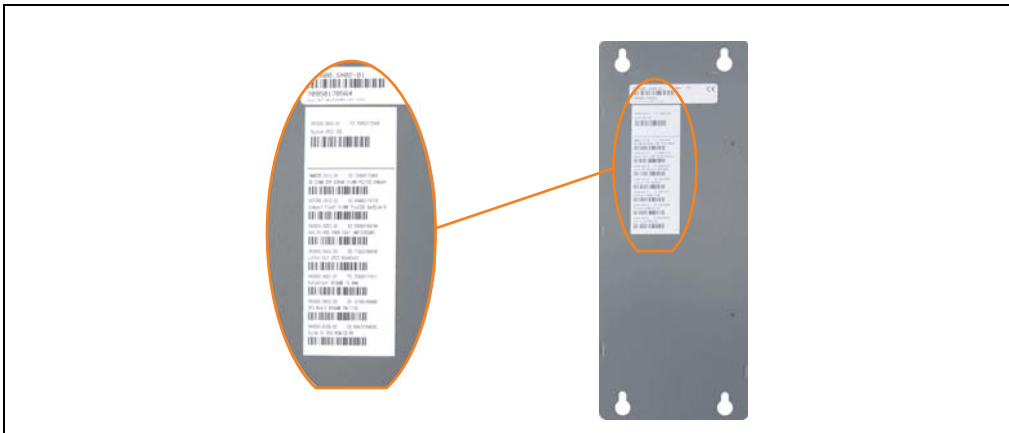

Figure 48: APC620 serial number sticker on back-side

## Technical Data • Entire device

This information can also be found on the B&R homepage. Enter the serial number of the entire device (found behind the front door) in the serial number search field on the start page [www.br-automation.com](http://www.br-automation.com). The search provides you with a detailed list of the individual components.

The screenshot shows the B&R website interface. At the top, there are navigation links: Home | Language | Contact | Login. Below that, the B&R logo and tagline 'Perfection in Automation' are visible. The main navigation bar includes Company, Products, Service, Events, News, and myPortal. The 'Products' section is expanded to show 'Industrial PCs > APC620 > System units > SPC600.SX02-01'. The 'Product Search' section has a 'Model Number' field containing '70950170564'. A 'Serial Number' field also contains '70950170564'. The search results show a detailed description of the APC620 System Unit 2 PCI Slot, including specifications like 1 drive slot, connectors for 2 x RS232, 2 x USB 2.0, Smart Display List/ DVI/ Monitor, 2 x ETH 10/100, AC/DC sound, RS232 keyboard/mouse, 24 VDC, (screen clamp STB102.9 or cage clamp STB103.91 must be ordered separately).

Below the description, there are two tables. The first table is titled 'serial number' and lists components with columns for serial number, model number, rev, delivery date, and end of warranty. The second table is titled 'Serial number' and lists components with the same columns. The serial number 70950170564 is highlighted in both tables. To the right of the tables, there are sections for 'Accessory' (mandatory and optional), 'Downloads', and 'E-mail address'.

Annotations in the image point to the 'Serial Number' field in the search section, labeled 'Serial number entry e.g. 70950170564', and the table of installed components, labeled 'List of installed components after the serial number search'.

serial number	Model number	Rev	Delivery date	End of warranty
70950170564	SPC600.SX02-01	F0	0000-00-00	0000-00-00

Serial number	Model number	Rev	Delivery date	End of warranty
70950170564	SPC600.SX02-01	F0	0000-00-00	0000-00-00
70950170564	SPC600.SX02-01	F0	0000-00-00	0000-00-00
64880118729	SPC600.SX12-00	C0	0000-00-00	0000-00-00
18000118729	SAC600.HC01-00	EB	0000-00-00	0000-00-00
71920118729	SPC600.FA02-00	D0	0000-00-00	0000-00-00
70430121811	SAC600.MC01-01	F0	0000-00-00	0000-00-00
71180118928	SPC600.EB05-00	C5	0000-00-00	0000-00-00
83810118928	SAC600.DV05-00	C0	0000-00-00	0000-00-00

Figure 49: Example of serial number search: 70950170564

## 2.16 Block diagram

The following block diagrams show the simplified structure according to the system unit being used with a 855GME CPU board (ETX / XTX).

### 2.16.1 Entire device with system unit 5PC600.SX01-00

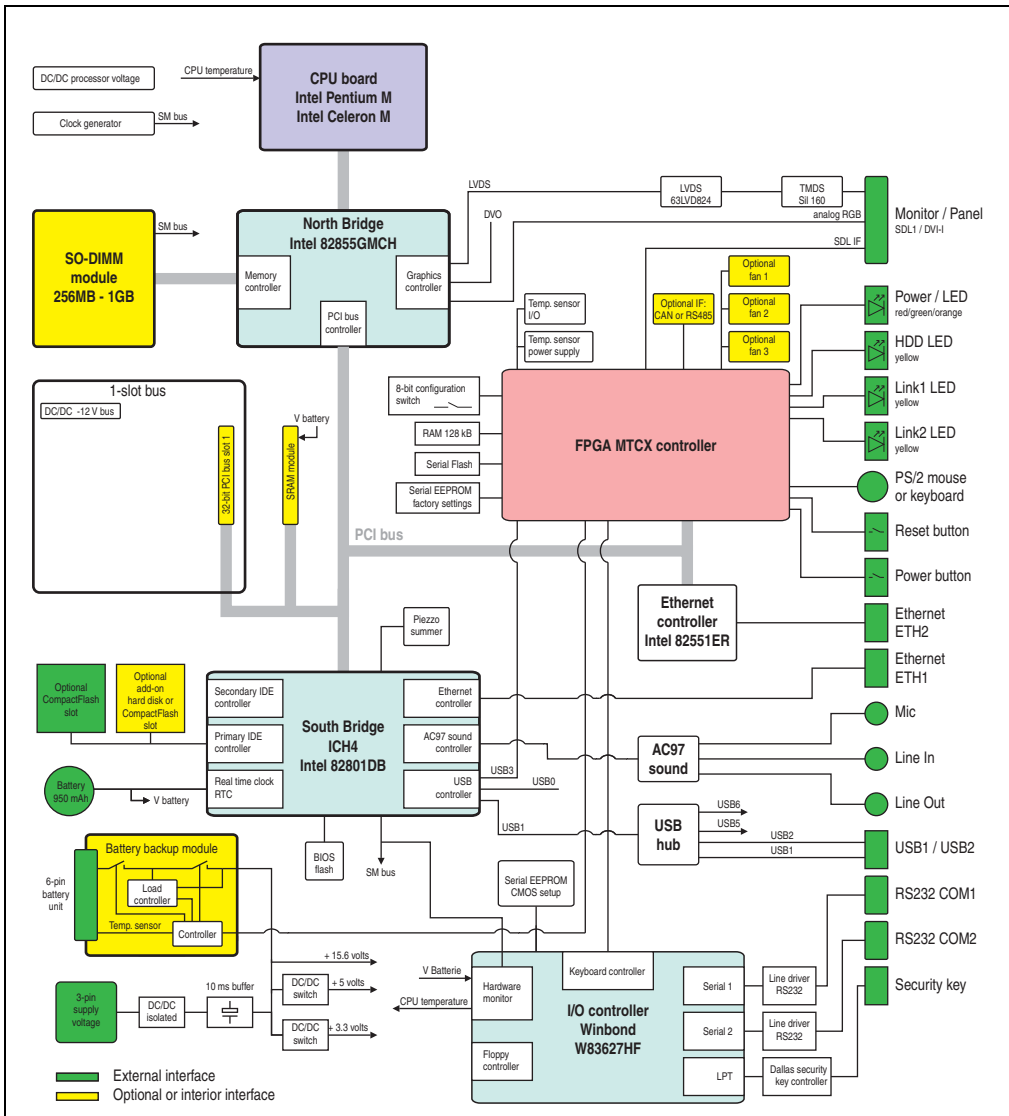

Figure 50: Block diagram of entire device with system unit 5PC600.SX01-00 and 855GME CPU board

Section 2  
Technical Data

2.16.2 Entire device with system unit 5PC600.SX02-00

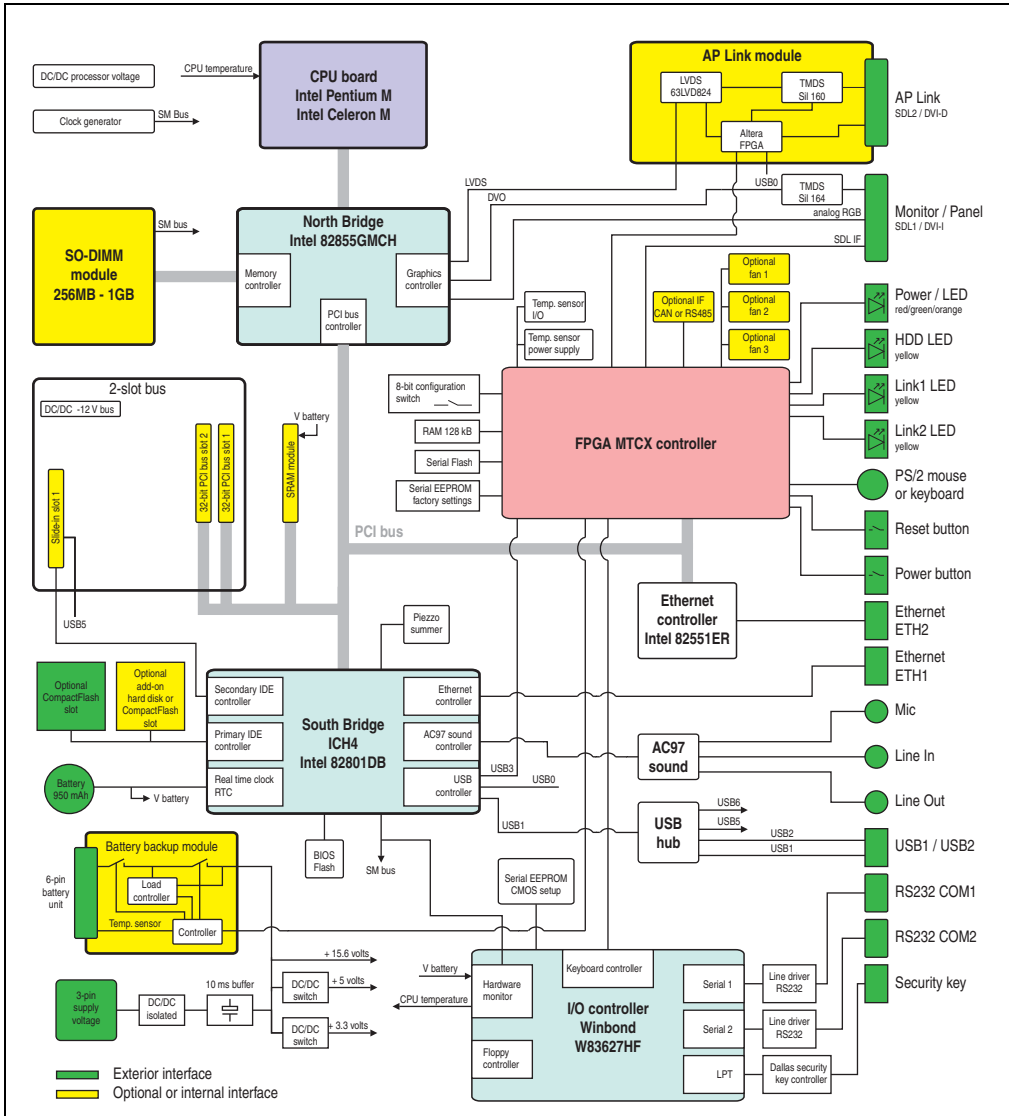

Figure 51: Block diagram of entire device with system unit 5PC600.SX02-00 and 855GME CPU board







2.16.5 Entire device with system unit 5PC600.SX05-00

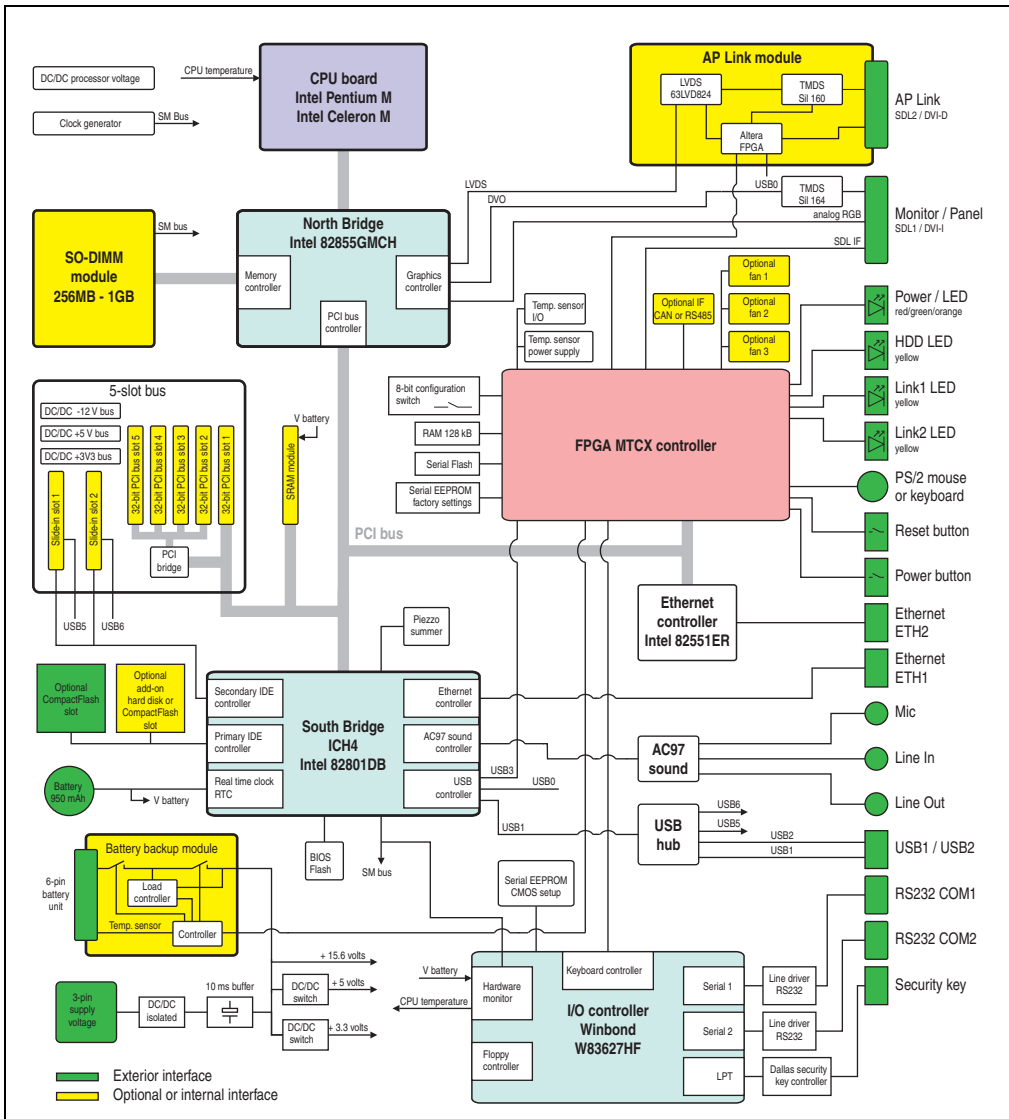

Figure 54: Block diagram of entire device with system unit 5PC600.SX05-00 and 855GME CPU board

Section 2  
Technical Data

2.16.6 Entire device with system unit 5PC600.SX05-01

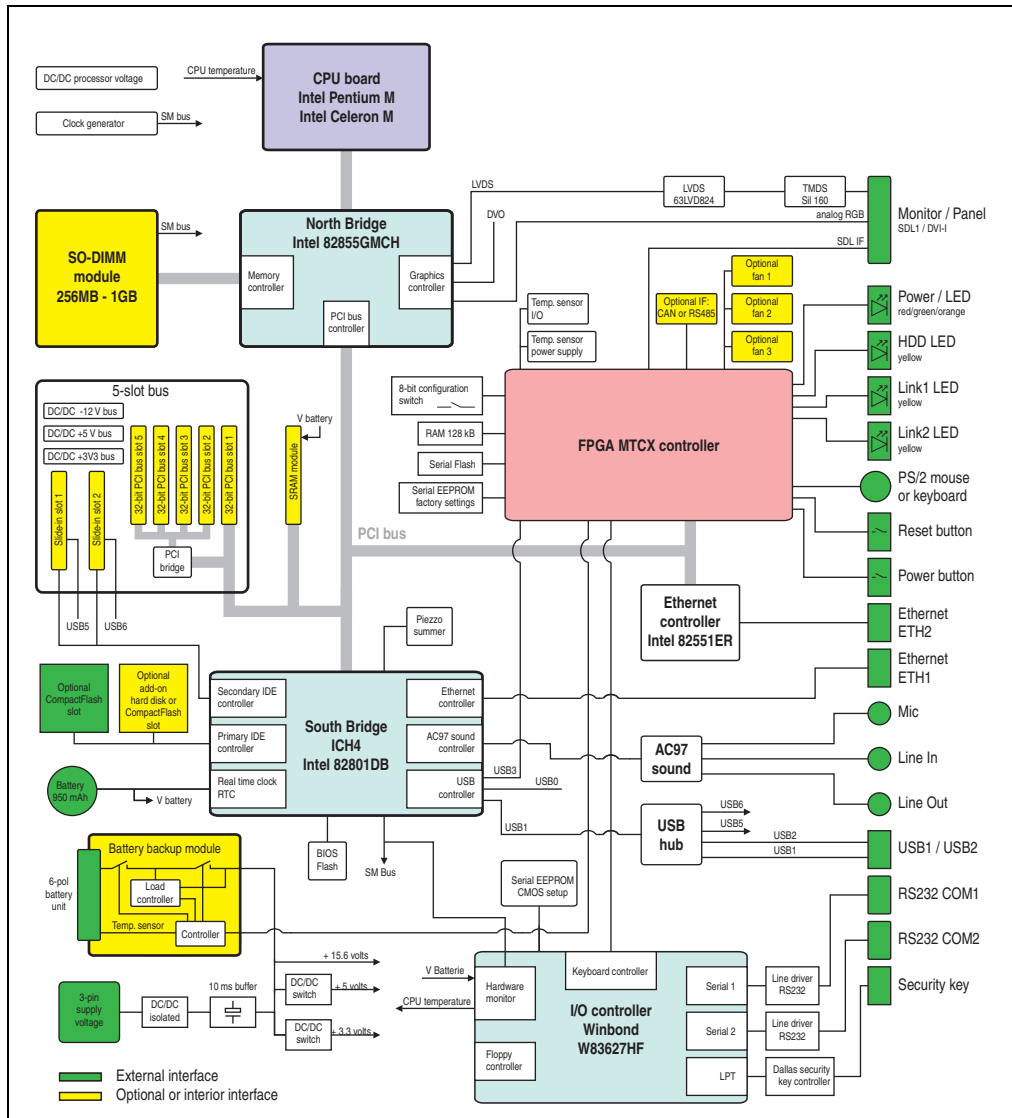

Figure 55: Block diagram of entire device with system unit 5PC600.SX05-01 and 855GME CPU board

2.16.7 Entire device with system unit 5PC600.SE00-00

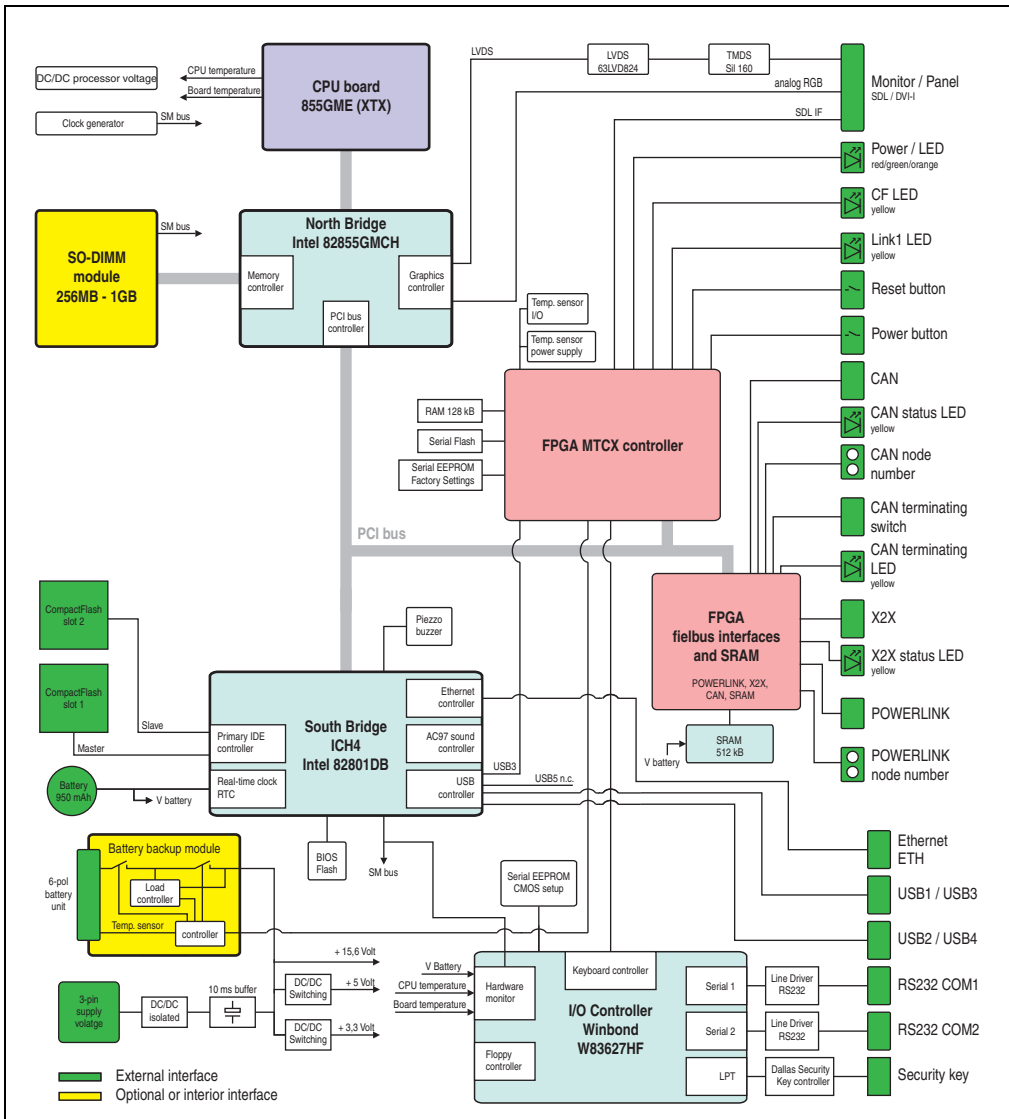

Figure 56: Block diagram of entire device with system unit 5PC600.SE00-00 and 855GME CPU board

2.16.8 Entire device with system unit 5PC600.SE00-01

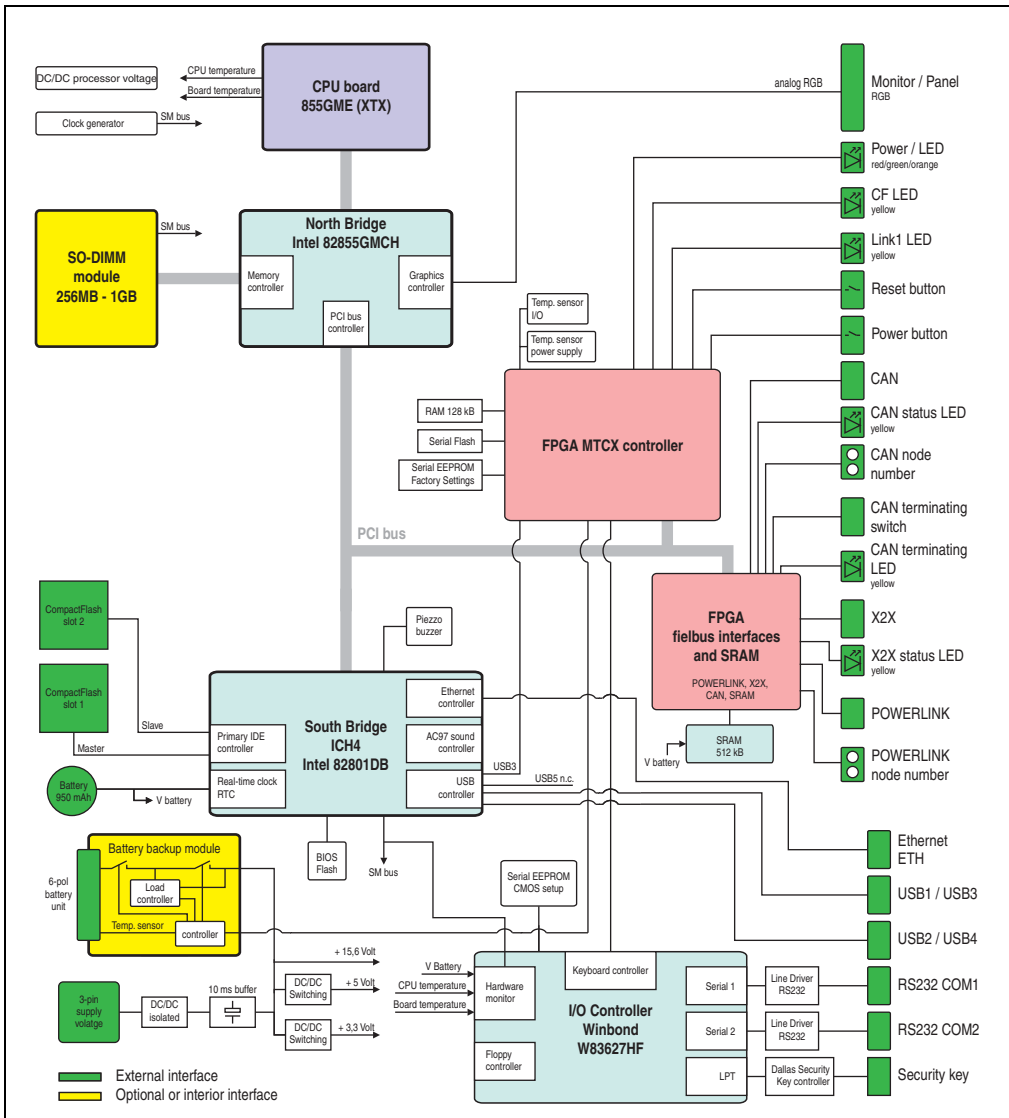

Figure 57: Block diagram of entire device with system unit 5PC600.SE00-01 and 855GME CPU board

2.16.9 Entire device with system unit 5PC600.SE00-02

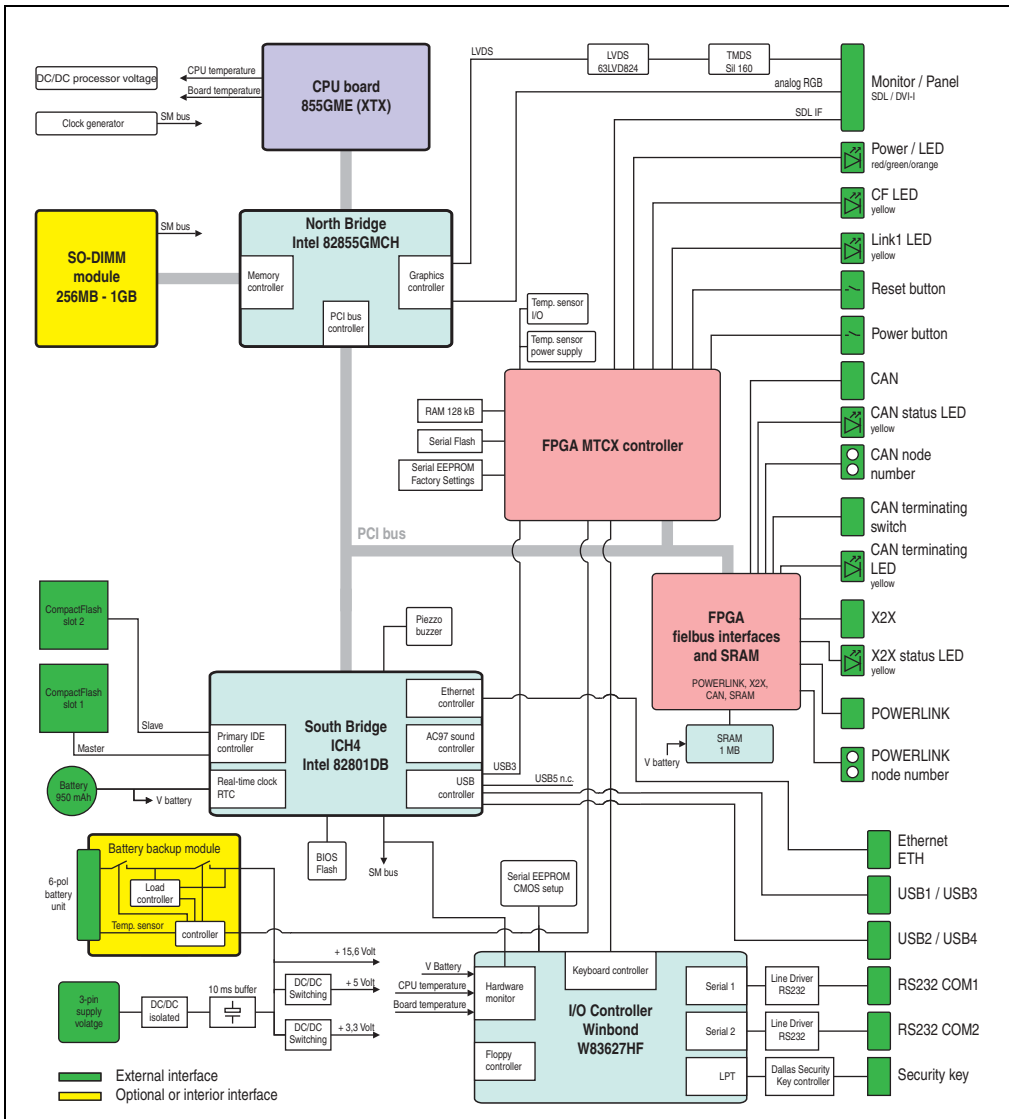

Figure 58: Block diagram of entire device with system unit 5PC600.SE00-02 and 855GME CPU board

### 3. Individual components

#### 3.1 System units

All of the individual components of the Automation PC620 system come together inside the system unit. The system unit consists of an APC620 housing with an integrated main board. The housing units are available in variations with 1, 2, 3 and 5 PCI slots and in APC620 embedded. Units with 2, 3 or 5 PCI slots have an additional 1 or 2 slide-in drives, respectively.

##### 3.1.1 APC620 with 1, 2, 3 and 5 PCI slots





Features	5PC600.SX01-00	5PC600.SX02-00	5PC600.SX02-01	5PC600.SF03-00	5PC600.SX05-00	5PC600.SX05-01
Photo						
B&R ID code	\$1B7D	\$1BB6	\$1BB7	\$A0B7	\$1D13	\$1D14
Serial interfaces Type Amount UART Transfer rate Connection	RS232, modem capable 2 16550 compatible, 16 byte FIFO Max. 115 kBaud 9-pin DSUB, male					
Ethernet Controller Transfer rate Connection	See "Ethernet connection ETH1", on page 130 and "Ethernet connection ETH2", on page 132 10/100 Mbit/s RJ45 twisted pair (10 Base T / 100 Base T)					
USB interface Type Amount Transfer rate Connection	USB 2.0 2 Up to 480 MBit (high speed) Type A					
Monitor / Panel	DVI-I, female					
AC97 sound	Mic., line in, line out					
IF optional slot	1					
PCI slots half-size full-size PCI standard Bus speed	1 - 2.2 33 MHz	2 - 2.2 33 MHz	- 3 2.2 33 MHz	- 3 2.2 33 MHz	5 - 2.2 33 MHz	
CompactFlash slot 1 (CF1) Internal organization	integrated Primary master					

Table 76: Technical data - 1, 2, 3 and 5 PCI slot types

## Technical Data • Individual components

Features	5PC600.SX01-00	5PC600.SX02-00	5PC600.SX02-01	5PC600.SF03-00	5PC600.SX05-00	5PC600.SX05-01
Combined CompactFlash slot 2 / hard disk (HDD/CF2) Internal organization	Yes, optional add-on CompactFlash slot or add-on hard disk Primary slave					
Insert for slide-in drive 1 Internal organization	-	Yes Secondary slave				
Insert for slide-in drive 2 Internal organization	-	-	-	-	Yes Secondary master	
APC620 UPS module optional	Yes, starting with Rev. H0	Yes, starting with Rev. G0	Yes, starting with Rev. H0	Yes	Yes, starting with Rev. F0	Yes, starting with Rev. H0
SRAM module optional	Yes, starting with Rev. I0	Yes, starting with Rev. H0	Yes, starting with Rev. K0	Yes	Yes, starting with Rev. H0	Yes, starting with Rev. H0
Reset button	Yes					
Power button	Yes					
PS/2 keyboard / mouse	Yes, combined, will be automatically detected					
Battery slot	Yes					
Hardware security key slot	Yes (DS1425 from MAXIM/Dallas)					
Fan slot	Yes					
Automation Panel link slot	-	1	-	1	1	-
Status LEDs	Power, HDD, Link1, Link2					
Real-time clock (RTC) Battery-buffered Accuracy	Yes See the technical data for CPU boards					
MTCX <sup>1)</sup>	Yes					
<b>Electrical characteristics</b>						
Power supply Rated voltage Starting current  Power consumption	24 VDC ±25% Typically 7A Maximum 40 A for < 300 µs See 2.8 "Power management APC620 system unit with 1 PCI slot"			24 VDC ±25% Typically 10 A Maximum 40 A for < 300 µs See section 2.10 "Power management APC620 system unit with 3 PCI slots" or 2.11 "Power management APC620 system units with 5 PCI slots"		
<b>Mechanical characteristics</b>						
Housing <sup>2)</sup> Item Paint Front cover	Galvanized steel plate Light gray (similar to Pantone 427CV), dark gray (similar to Pantone 432CV) Colored plastic (similar to Pantone 144CV)					
Outer dimensions Width Length Height	65 mm 251 mm 270 mm	104.5 mm 253 mm 270 mm		125 mm 253 mm 410 mm	185.4 mm 253 mm 270 mm	
Weight	Approx. 1.5 kg	Approx. 2.6 kg		Approx. 4.5 kg	Approx. 3.8 kg	
Mounting plates (for M4 screws)	4			4	6	
Drilling templates for mounting	(see chapter 3 "Commissioning", section 1.2 "Drilling templates")					

Table 76: Technical data - 1, 2, 3 and 5 PCI slot types (Forts.)

- 1) Maintenance Controller Extended, for more information, see the section "Maintenance Controller Extended (MTCX)", on page 793.
- 2) Depending on the process or batch, there may be visible deviations in the color and surface structure.

**3.1.2 APC620 embedded variations**

Features	5PC600.SE00-00	5PC600.SE00-01	5PC600.SE00-02
Photo			
B&R ID code	\$A3BA	\$A3BB	\$A52B
Serial interfaces Type Amount UART Transfer rate Connection	RS232, modem capable 2 16550-compatible, 16-byte FIFO Max. 115 kBaud 9-pin DSUB, male		
Ethernet Controller Transfer rate Connection	See "Ethernet connection ETH (only APC620 embedded)", on page 129 10/100 Mbit/s RJ45 twisted pair (10 Base T / 100 Base T)		
POWERLINK Amount Station Number Dial	1 2 pcs.		
X2X Link Amount Status LED	1 Yes, see page 127		
CAN bus Amount Transfer rate Node switch Terminating resistor Status LED	See also page 125 1 Max. 500 kBit/s Yes Yes, can be activated using a switch Yes, see page 127		
USB interface Type Amount Transfer rate Connection	USB 2.0 4 Up to 480 MBit (high speed) Type A		
Monitor / Panel	DVI-I, female	DVI-A, female	DVI-I, female
AC97 sound	-		
IF optional slot	-		
PCI slots half-size full-size PCI standard Bus speed	-		
CompactFlash slot 1 (CF1) Internal organization	integrated Primary master		

Table 77: Technical data - APC620 embedded variations



## Technical Data • Individual components

Features	5PC600.SE00-00	5PC600.SE00-01	5PC600.SE00-02
CompactFlash slot 2 (CF2) Internal organization	integrated Primary slave		
Insert for slide-in drive 1 Internal organization	-		
Insert for slide-in drive 2 Internal organization	-		
APC620 UPS module optional	Yes		
SRAM Quantity Remanent variables for AR (Automation Runtime) in power fail mode	Yes 512 kB  256 kB with CPU board 5PC600.X855-xx 192 kB with CPU board 5PC600.X945-00	Yes 1 MB  256 kB with CPU board 5PC600.X855-xx 192 kB with CPU board 5PC600.X945-00	
Reset button	Yes		
Power button	Yes		
PS/2 keyboard / mouse	-		
Battery slot	Yes		
Hardware security key slot	Yes (DS1425 from MAXIM/Dallas)		
Fan slot	-		
Automation Panel link slot	-		
Status LEDs	Power, HDD, Link1		
Real-time clock (RTC) Battery-buffered Accuracy	Yes See the technical data for the CPU board		
MTCX <sup>1)</sup>	Yes		
<b>Electrical characteristics</b>			
Power supply Rated voltage Starting current  Power consumption	24 VDC ±25% Typically 7 A maximum 40 A for < 300 µs See 2.12 "Power management for the APC620 embedded system unit"		
<b>Mechanical characteristics</b>			
Housing <sup>2)</sup> Item Paint Front cover	Galvanized steel plate Light gray (similar to Pantone 427CV), dark gray (similar to Pantone 432CV) Colored plastic (similar to Pantone 144CV)		
Outer dimensions Width Length Height	68.3 mm 225.6 mm 210 mm		
Weight	Approx. 1.3 kg		
Mounting plates (for M4 screws)	4		
Drilling templates for mounting	(see chapter 3 "Commissioning", section 1.2 "Drilling templates")		

Table 77: Technical data - APC620 embedded variations (Forts.)

1) Maintenance Controller Extended, for more information, see the section "Maintenance Controller Extended (MTCX)", on page 793.

- 2) Depending on the process or batch, there may be visible deviations in the color and surface structure.

### 3.2 CPU boards 815E (ETX)

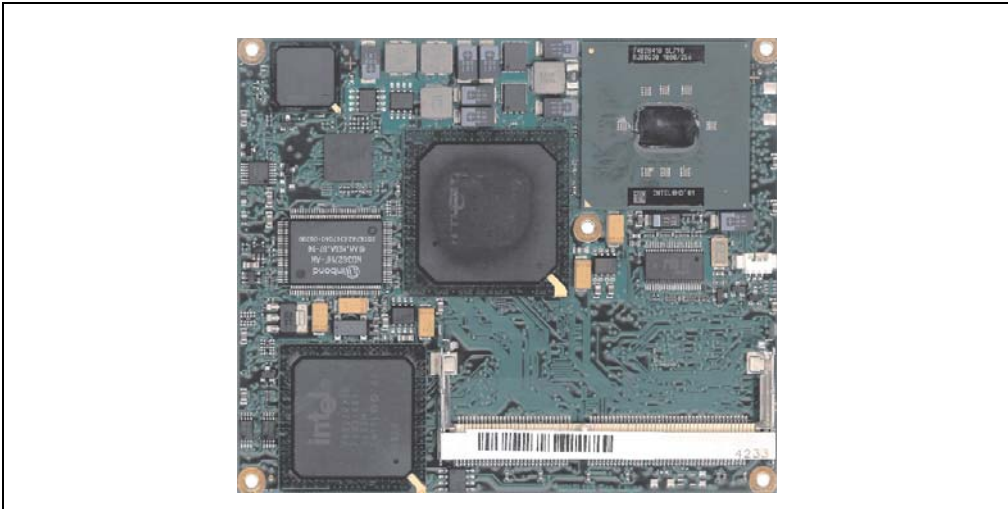

Figure 59: CPU boards 815E (ETX)

## Information:

The following characteristics, features, and limit values only apply to this individual component and can deviate from those specified for the entire device. For the entire device in which this individual component is used, refer to the data given specifically for the entire device.

Features	5PC600.E815-00	5PC600.E815-02	5PC600.E815-03
Boot loader / Operating system	BIOS Phoenix (see section "815E (ETX) BIOS description", on page 371)		
Processor			
Architectures	0.13 μm	0.13 μm	0.13 μm
Type	Intel Celeron 3	Intel Celeron 3	Intel Celeron
Clock frequency	400 MHz	733 MHz	1 GHz
Expanded command set	MMX technology, streaming SIMD extension	MMX technology, streaming SIMD extension	MMX technology, streaming SIMD extension
L1 cache	16 kB	16 kB	16 kB
L2 cache	256 kB	256 kB	256 kB
Floating point unit (FPU)	Yes	Yes	Yes
Chipset	Intel 82815E (GMCH) Intel 82801DB (ICH4)		
Real-time clock (RTC)	Yes		
Battery-buffered	at 25°C typ. 24 ppm (2 seconds) <sup>1)</sup> per day		
Accuracy			
Front side bus	100 Mhz	133 Mhz	133 MHz

Table 78: Technical data - 815E CPU boards (ETX)

## Technical Data • Individual components

Features	5PC600.E815-00	5PC600.E815-02	5PC600.E815-03
Mass memory management	2 IDE ports, UDMA 100		
Memory Type Quantity Socket	SDRAM Max. 512 MB SO-DIMM 144-pin		
Graphics Controller Memory Color depth Resolution RGB GE <sup>1)2)</sup>	Support up to SXGA display units Intel 82815 (integrated in the Chipset) 32 MB shared memory (reserved in the main memory) Max. 24 bit  up to 1280 x 1024 @ 85 Hz 24 bit, up to 1600 x 1200 @ 75 Hz 8 bit up to 1280 x 1024 @ 85 Hz 24 bit		

Table 78: Technical data - 815E CPU boards (ETX) (Forts.)

1) At max. specified ambient temperature: typically 70 ppm (6 seconds) - worst-case 220 ppm (19 seconds).

2) GE = Graphics Engine

### Driver support

In order for the CPU board with the Intel 82815E chipset to work properly, it is necessary to install the Intel chipset driver (e.g. special USB driver) and the graphics chip. The necessary software can be downloaded from the download area on the B&R homepage ([www.br-automation.com](http://www.br-automation.com)).

### Information:

**Required drivers can only be downloaded from the B&R homepage, not from manufacturers' pages.**

### 3.3 CPU boards 855GME (ETX)

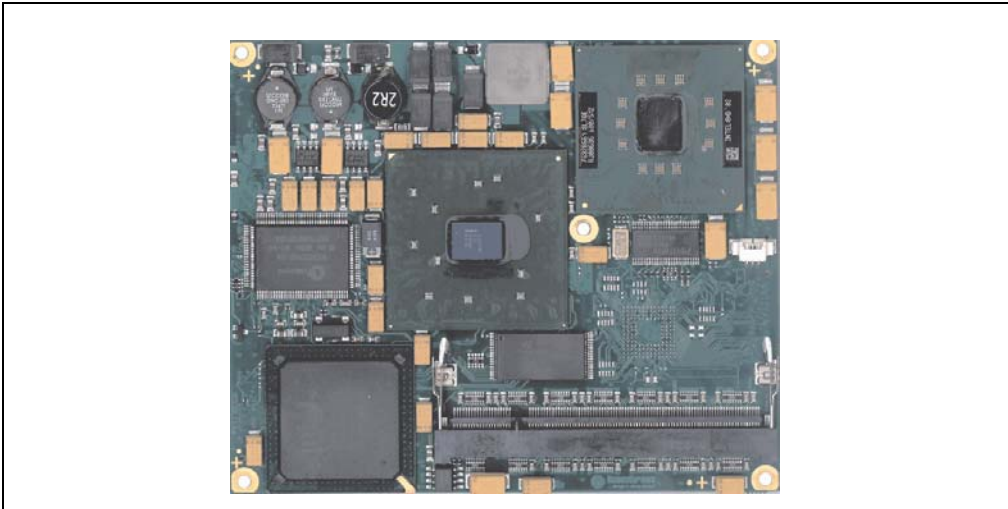

Figure 60: CPU boards 855GME (ETX)

## Information:

The following characteristics, features, and limit values only apply to this individual component and can deviate from those specified for the entire device. For the entire device in which this individual component is used, refer to the data given specifically for the entire device.

Features	5PC600.E855-00	5PC600.E855-01	5PC600.E855-02	5PC600.E855-03	5PC600.E855-04	5PC600.E855-05
Boot loader / Operating system	BIOS Phoenix (see BIOS section "855GME (ETX) BIOS description", on page 425)					
Processor Architectures	0.13 µm	0.13 µm	90 nm	90 nm	0.13 µm	0.13 µm
Type	Intel Pentium M	Intel Pentium M	Intel Pentium M	Intel Pentium M	Intel Celeron M	Intel Celeron M
Clock frequency	1.1 GHz	1.6 GHz	1.4 GHz	1.8 GHz	600 MHz	1000 MHz
Expanded command set	MMX technology, streaming SIMD extension	MMX technology, streaming SIMD extension	MMX technology, streaming SIMD extension	MMX technology, streaming SIMD extension	MMX technology, streaming SIMD extension	MMX technology, streaming SIMD extension
L1 cache	2	2	2	2	2	2
L2 cache	32 kB	32 kB	32 kB	32 kB	32 kB	32 kB
Floating point unit (FPU)	1 MB	1 MB	2 MB	2 MB	512 kB	512 kB
	Yes	Yes	Yes	Yes	Yes	Yes
Chipset	Intel 82855GME (GMHC) Intel 82801DB (ICH4)					

Table 79: Technical data - CPU boards 855GME (ETX)

## Technical Data • Individual components

Features	5PC600.E855-00	5PC600.E855-01	5PC600.E855-02	5PC600.E855-03	5PC600.E855-04	5PC600.E855-05
Real-time clock (RTC) Battery-buffered Accuracy	Yes At 25°C typ. 12 ppm (1 second) <sup>1)</sup> per day					
Front side bus	400 Mhz					
Mass memory management	2 IDE ports, UDMA 100					
Memory Type Quantity Socket	DDRAM Max. 1 GB SO-DIMM 200-pin					
Graphics Controller Memory Color depth Resolution RGB GE1 <sup>2)</sup> = LVDS GE2 <sup>2)</sup> = DVO	Intel Extreme Graphics 2 (integrated in the chipset) 64 MB shared memory (reserved in the main memory) Max. 32 bit  350 MHz RAMDAC, up to 2048 x 1536 @ 60 Hz (QXGA) including 1920 x 1080 @ 85 Hz (HDTV) 2x 112 MHz LVDS transmitter, from 640 x 480 up to 1600 x 1200 (Embedded Panel interface based on VESA EDID™ 1.3) Intel compliant DVO 2.0 port (12-bit DDR) supports external DVI transmitters with a bandwidth up to 165 MHz, 1600 x 1200 (UXGA)					

Table 79: Technical data - CPU boards 855GME (ETX) (Forts.)

1) At max. specified ambient temperature: typically 58 ppm (5 seconds) - worst-case 220 ppm (19 seconds).

2) GE = Graphics Engine

### Driver support

In order for the CPU board with the Intel 82855GME chipset to work properly, it is necessary to install the Intel chipset driver (e.g. special USB driver) and the graphics chip. The necessary software can be downloaded from the download area on the B&R homepage ([www.br-automation.com](http://www.br-automation.com)).

### Information:

**Required drivers can only be downloaded from the B&R homepage, not from manufacturers' pages.**

### 3.4 CPU boards 855GME (XTX)

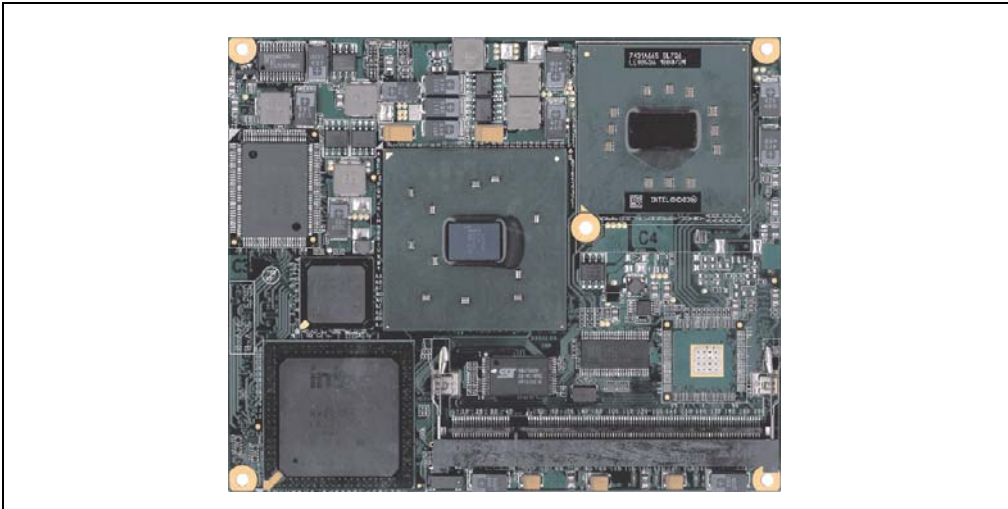

Figure 61: CPU boards 855GME (XTX)

## Information:

The following characteristics, features, and limit values only apply to this individual component and can deviate from those specified for the entire device. For the entire device in which this individual component is used, refer to the data given specifically for the entire device.

Features	5PC600.X855-00	5PC600.X855-01	5PC600.X855-02	5PC600.X855-03	5PC600.X855-04	5PC600.X855-05
Boot loader / Operating system	BIOS AMI (see BIOS section "855GME (XTX) BIOS description", on page 481)					
Processor	0.13 µm	0.13 µm	90 nm	90 nm	0.13 µm	0.13 µm
Architectures	Intel Pentium M	Intel Pentium M	Intel Pentium M	Intel Pentium M	Intel Celeron M	Intel Celeron M
Type	1.1 GHz	1.6 GHz	1.4 GHz	1.8 GHz	600 MHz	1000 MHz
Clock frequency	MMX	MMX	MMX	MMX	MMX	MMX
Expanded command set	technology, streaming	technology, streaming	technology, streaming	technology, streaming	technology, streaming	technology, streaming
	SIMD extension	SIMD extension	SIMD extension	SIMD extension	SIMD extension	SIMD extension
L1 cache	2	2	2	2	2	2
L2 cache	32 kB	32 kB	32 kB	32 kB	32 kB	32 kB
Floating point unit (FPU)	1 MB	1 MB	2 MB	2 MB	512 kB	512 kB
	Yes	Yes	Yes	Yes	Yes	Yes
Chipset	Intel 82855GME (GMHC) Intel 82801DB (ICH4)					

Table 80: Technical data - CPU boards 855GME (XTX)

## Technical Data • Individual components

Features	5PC600.X855-00	5PC600.X855-01	5PC600.X855-02	5PC600.X855-03	5PC600.X855-04	5PC600.X855-05
Real-time clock (RTC) Battery-buffered Accuracy	Yes At 25°C typ. 12 ppm (1 second) <sup>1)</sup> per day					
Front side bus	400 Mhz					
Mass memory management	2 IDE ports, UDMA 100					
Memory Type Quantity Socket	DDRAM Max. 1 GB SO-DIMM 200-pin					
Graphics Controller Memory Color depth Resolution RGB GE1 <sup>2)</sup> = LVDS GE2 <sup>2)</sup> = DVO	Intel Extreme Graphics 2 (integrated in the chipset) Up to 64 MB shared memory (reserved in the main memory) Max. 32 bit  350 MHz RAMDAC, up to 2048 x 1536 @ 60 Hz (QXGA) including 1920 x 1080 @ 85 Hz (HDTV) 2x 112 MHz LVDS transmitter, from 640 x 480 up to 1600 x 1200 (Embedded Panel interface based on VESA EDID™ 1.3)  Intel compliant DVO 2.0 port (12-bit DDR) supports external DVI transmitters with a bandwidth up to 165 MHz, 1600 x 1200 (UXGA)					

Table 80: Technical data - CPU boards 855GME (XTX) (Forts.)

1) At max. specified ambient temperature: typically 58 ppm (5 seconds) - worst-case 220 ppm (19 seconds).

2) GE = Graphics Engine

### Driver support

In order for the CPU board with the Intel 82855GME chipset to work properly, it is necessary to install the Intel chipset driver (e.g. special USB driver) and the graphics chip. The necessary software can be downloaded from the download area on the B&R homepage ([www.br-automation.com](http://www.br-automation.com)).

### Information:

**Required drivers can only be downloaded from the B&R homepage, not from manufacturers' pages.**



### 3.5 Heat sink

There are a number of heat sink variants available to be used with different CPU boards.

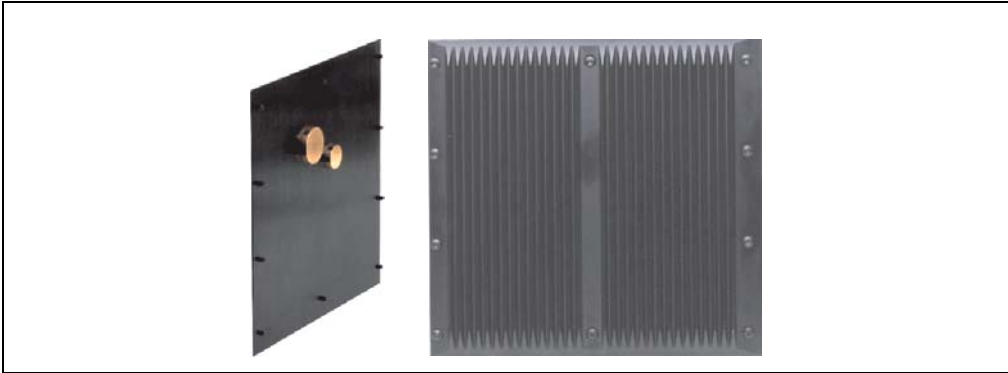

Figure 62: Heat sink

#### Information:

**A heat sink can only be replaced at the B&R plant.**

Mechanical characteristics	5AC600.HS01-00	5AC600.HS01-01	5AC600.HS01-02	5AC600.HS02-01	5AC600.HS02-02	5AC600.HS03-01
Ideal for CPU boards	5PC600.E815-00 5PC600.E815-02 5PC600.E815-03	5PC600.E855-00 5PC600.E855-02 5PC600.E855-04 5PC600.E855-05 5PC600.X855-00 5PC600.X855-02 5PC600.X855-04 5PC600.X855-05	5PC600.E855-01 5PC600.E855-03 5PC600.X855-01 5PC600.X855-03	5PC600.E855-00 5PC600.E855-02 5PC600.E855-04 5PC600.E855-05 5PC600.X855-00 5PC600.X855-02 5PC600.X855-04 5PC600.X855-05	5PC600.E855-01 5PC600.E855-03 5PC600.X855-01 5PC600.X855-03	5PC600.X855-04 5PC600.X855-05 5PC600.X855-00 5PC600.X855-02
Suitable for the following system units	5PC600.SX01-00 5PC600.SX02-00 5PC600.SX02-01 5PC600.SX05-00 5PC600.SX05-01	5PC600.SX01-00 5PC600.SX02-00 5PC600.SX02-01 5PC600.SX05-00 5PC600.SX05-01	5PC600.SX01-00 5PC600.SX02-00 5PC600.SX02-01 5PC600.SX05-00 5PC600.SX05-01	5PC600.SF03-00	5PC600.SF03-00	5PC600.SE00-00 5PC600.SE00-01 5PC600.SE00-02
Item	Black-coated aluminum					
Outer dimensions						
Width						
Height	228.7 mm		228.7 mm	228.7 mm	228.7 mm	203.9 mm
Depth	218 mm		218 mm	358 mm	358 mm	158 mm
	12.8 mm		28 mm	12.8 mm	28 mm	12.8 mm
Weight	Approx. 1340 g		Approx. 1640 g	Approx. 2000 g	Approx. 3200 g	Approx. 900 g

Table 81: Technical data - Heat sink

### 3.6 Main memory

The CPU boards (815E, 855GME) are each equipped with a socket for memory modules. When choosing a main memory, it is important to consider both the maximum memory capacity (for 815E (ETX) CPU Boards 512 MB, and for 855GME (ETX or XTX) CPU Boards 1 GB) and the correct type.

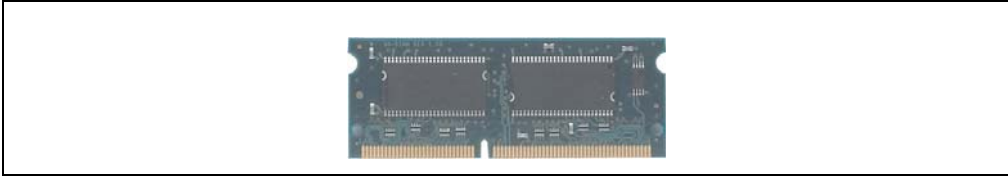

Figure 63: Main memory module

## Information:

**A main memory module can only be replaced at the B&R plant.**

Features	5MMSDR.0128-01	5MMSDR.0256-01	5MMSDR.0512-01	5MMDDR.0256-00	5MMDDR.0512-00	5MMDDR.1024-00
Ideal for CPU boards	815E (ETX)			855GME (ETX / XTX)		
Quantity	128 MB	256 MB	512 MB	256 MB	512 MB	1 GB
Construction	144-pin	144-pin	144-pin	200-pin	200-pin	200-pin
Type	SO-DIMM	SO-DIMM	SO-DIMM	SO-DIMM	SO-DIMM	SO-DIMM
Type	SDRAM	SDRAM	SDRAM	DDR-SDRAM	DDR-SDRAM	DDR-SDRAM
Organization	16Mx64	32x64	64Mx64	32Mx64	64Mx64	128Mx64

Table 82: Technical data - Main memory

## 3.7 Drives

### 3.7.1 Add-on Solid State Drive 128 GB 24x7 ET - 5AC600.SSDI-00

This 128 GB add-on SSD (Solid State Drive) is based on Multi Level Cell (MLC) technology and is ATA/ATAPI compatible. The add-on drive is referred to internally as the primary slave drive.

#### Information:

Add-on drives are only available factory-installed. Therefore, they need to be requested when placing an order.



Figure 64: Add-on SSD 128 GB - 5AC600.SSDI-00 ≤ D0



Figure 65: Add-on SSD 128 GB - 5AC600.SSDI-00 ≥ E0

## Technical data

**Information:**

A sudden loss of power may result in data loss! In very rare cases, mass memory may also be damaged.

To prevent damage and loss of data, the use of a UPS device is recommended.

**Information:**

The following characteristics, features and limit values only apply to this individual component and can deviate from those specified for the fully assembled device. For the assembled device in which this individual component is used, refer to the data given specifically for that device.

Features	5AC600.SSDI-00 Revision ≤ C0	5AC600.SSDI-00 Revision ≥ D0	5AC600.SSDI-00 Revision ≥ E0 <sup>1)</sup>
Manufacturer	Transcend		Innodisk
Manufacturer's product ID	TS128GPSD320	TS128GPSD330	DEP25-A28D06SWH88
Formatted capacity	128 GB		
Data reliability	< 1 unrecoverable error in 10 <sup>16</sup> bit read accesses		
Interface	PATA		
S.M.A.R.T. Support	Yes		
MTBF	1,000,000 hours		3,000,000 hours
Continuous reading	Max. 103.7 MB/s	Max. 118.4 MB/s	Max. 90 MB/s
Continuous writing	Max. 93.15 MB/s	Max. 92.75 MB/s	Max. 90 MB/s
IOPS <sup>2)</sup>			
4k read	7.733 MB/s	13.09 MB/s	-
4k write	0.722 MB/s	1.225 MB/s	-
<b>Endurance</b>			
MLC flash	Yes		
Compatibility	PATA (ATA/ATAPI 8) SSD Enhanced SMART ATA feature set Ultra DMA Mode 0-6 Multi-Word DMA Mode 0-2 PIO Mode 0-4		
Data volume	80 TBW <sup>3)</sup>		345,6 TBW <sup>3)</sup>
<b>Mechanical characteristics</b>			
Add-on mounting	Fixed		

Table 83: Technical data - Add-on SSD - 5AC600.SSDI-00

## Technical Data • Individual components

Features	5AC600.SSDI-00 Revision ≤ C0	5AC600.SSDI-00 Revision ≥ D0	5AC600.SSDI-00 Revision ≥ E0 <sup>1)</sup>
Outer dimensions <sup>4)</sup>			
Width	69.85 mm		69.85 mm
Height	7.40 mm		7.20 mm
Depth	100.3 mm		99.85 mm
Weight <sup>5)</sup>	55 g		100 g
<b>Environmental characteristics</b>			
Ambient temperature			
Operation	0 to 70°C		-40 to 85°C
Storage	-40 to 85°C		-55 to 95°C
Transport	-40 to 85°C		-55 to 95°C
Relative humidity			
Operation	0 to 95%, non-condensing		10 to 95%, non-condensing
Storage	0 to 95%, non-condensing		10 to 95%, non-condensing
Transport	0 to 95%, non-condensing		10 to 95%, non-condensing
Vibration			
Operation	20 to 2000 Hz: 20 g		7 to 2000 Hz: 20 g
Storage	20 to 2000 Hz: 20 g		7 to 2000 Hz: 20 g
Transport	20 to 2000 Hz: 20 g		7 to 2000 Hz: 20 g
Shock (pulse with a sine half-wave)			
Operation	1500 g, 0.5 ms		
Storage	1500 g, 0.5 ms		
Transport	1500 g, 0.5 ms		
Altitude			
Operation	- 300 to 12192 meters		
Storage	- 300 to 12192 meters		
Transport	- 300 to 12192 meters		

Table 83: Technical data - Add-on SSD - 5AC600.SSDI-00 (Forts.)

- 1) The simultaneous operation with a CompactFlash card in the CompactFlash1 slot is no longer recommended.
- 2) IOPS: Random read and write input/output operations per second.
- 3) TBW: Terabyte written
- 4) Dimensions without add-on
- 5) Weight without add-on

Temperature humidity diagram

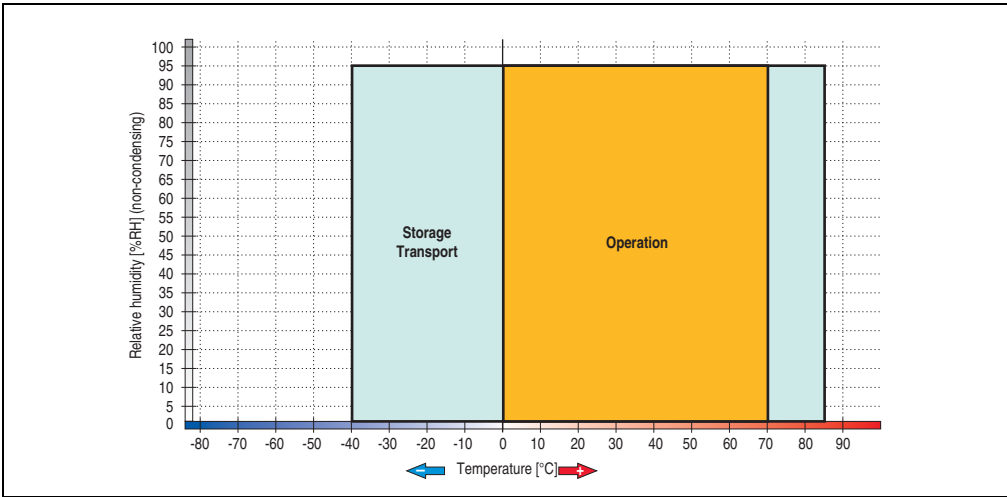

Figure 66: Temperature humidity diagram - Add-on SSD 128 GB - 5AC600.SSDI-00 ≤ D0

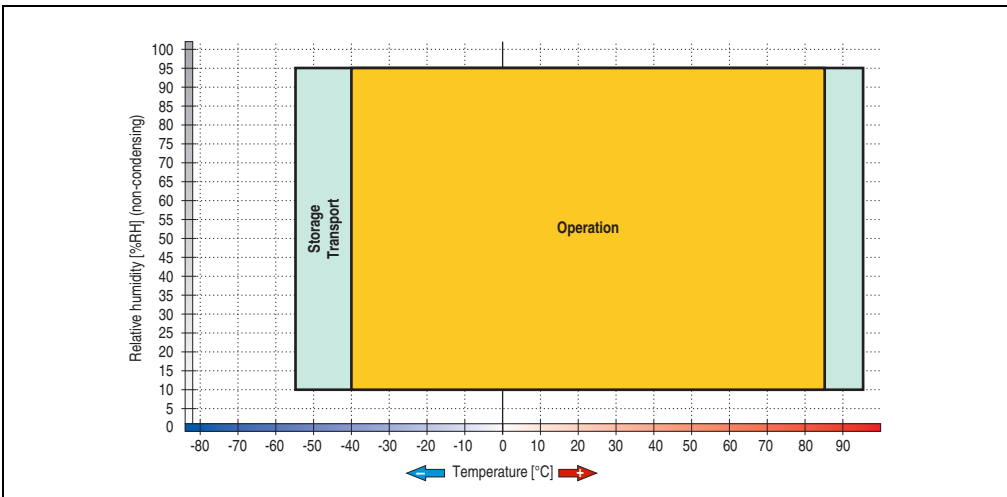

Figure 67: Temperature humidity diagram - Add-on SSD 128 GB - 5AC600.SSDI-00 ≥ E0

### 3.7.2 Replacement Solid State Drive 128 GB 24x7 ET - 5MMSSD.0128-00

This 128 GB Solid State Drive can be used as a replacement part for the 5AC600.SSDI-00 SSD.



Figure 68: Replacement SSD 128 GB - 5MMSSD.0128-00 ≤ D0



Figure 69: Replacement SSD 128 GB - 5MMSSD.0128-00 ≥ E0

#### Technical data

##### Information:

A sudden loss of power may result in data loss! In very rare cases, mass memory may also be damaged.

To prevent damage and loss of data, the use of a UPS device is recommended.

##### Information:

The following characteristics, features, and limit values only apply to this individual component and can deviate from those specified for the fully assembled device. For the assembled device in which this individual component is used, refer to the data given specifically for that device.

## Technical Data • Individual components

Features	5MMSSD.0128-00 Revision ≤ C0	5MMSSD.0128-00 Revision ≥ D0	5MMSSD.0128-00 Revision ≥ E0
Manufacturer	Transcend		Innodisk
Manufacturer's product ID	TS128GPSD320	TS128GPSD330	DEP25-A28D06SWH88
Formatted capacity	128 GB		
Data reliability	< 1 unrecoverable error in 10 <sup>16</sup> bit read accesses		
Interface	PATA		
S.M.A.R.T. Support	Yes		
MTBF	1,000,000 hours		3,000,000 hours
Continuous reading	Max. 103.7 MB/s	Max. 118.4 MB/s	Max. 90 MB/s
Continuous writing	Max. 93.15 MB/s	Max. 92.75 MB/s	Max. 90 MB/s
IOPS <sup>1)</sup>			
4k read	7.733 MB/s	13.09 MB/s	-
4k write	0.722 MB/s	1.225 MB/s	-
<b>Endurance</b>			
MLC flash	Yes		
Compatibility	PATA (ATA/ATAPI 8) SSD Enhanced SMART ATA feature set Ultra DMA Mode 0-6 Multi-Word DMA Mode 0-2 PIO Mode 0-4		
Data volume	80 TBW <sup>2)</sup>		345,6 TBW <sup>2)</sup>
<b>Mechanical characteristics</b>			
Outer dimensions			
Width	69.85 mm		69.85 mm
Height	7.40 mm		9.20 mm
Depth	100.3 mm		99.85 mm
Weight	55 g		100 g
<b>Environmental characteristics</b>			
Ambient temperature			
Operation	0 to 70°C		-40 to 85°C
Storage	-40 to 85°C		-55 to 95°C
Transport	-40 to 85°C		-55 to 95°C
Relative humidity			
Operation	0 to 95%, non-condensing		10 to 95%, non-condensing
Storage	0 to 95%, non-condensing		10 to 95%, non-condensing
Transport	0 to 95%, non-condensing		10 to 95%, non-condensing
Vibration			
Operation	20 to 2000 Hz: 20 g		7 to 2000 Hz: 20 g
Storage	20 to 2000 Hz: 20 g		7 to 2000 Hz: 20 g
Transport	20 to 2000 Hz: 20 g		7 to 2000 Hz: 20 g
Shock (pulse with a sine half-wave)			
Operation	1500 g, 0.5 ms		1500 g, 0.5 ms
Storage	1500 g, 0.5 ms		1500 g, 0.5 ms
Transport	1500 g, 0.5 ms		1500 g, 0.5 ms

Table 84: Technical data - Replacement SSD - 5MMSSD.0128-00



Features	5MMSSD.0128-00 Revision ≤ C0	5MMSSD.0128-00 Revision ≥ D0	5MMSSD.0128-00 Revision ≥ E0
Altitude Operation Storage Transport		- 300 to 12192 meters - 300 to 12192 meters - 300 to 12192 meters	

Table 84: Technical data - Replacement SSD - 5MMSSD.0128-00 (Forts.)

- 1) IOPS: Random read and write input/output operations per second.
- 2) TBW: Terabyte written

### Temperature humidity diagram

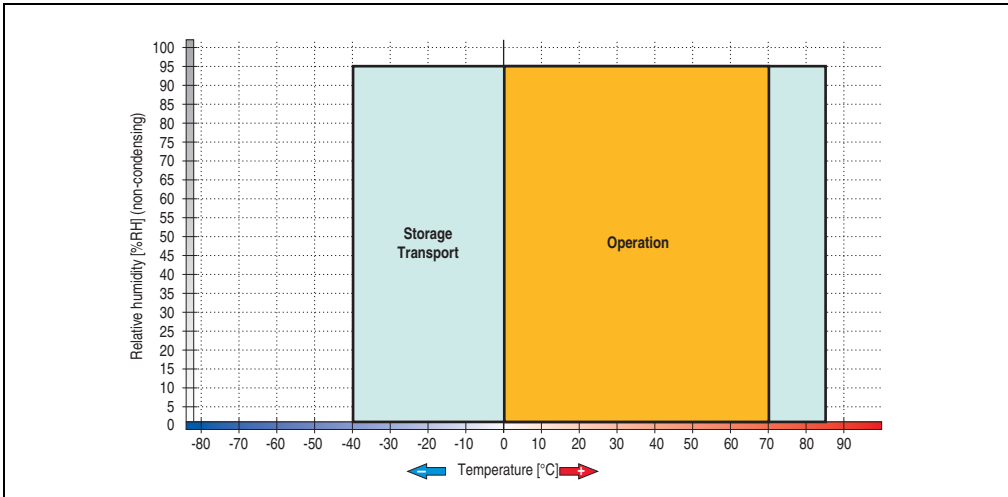

Figure 70: Temperature humidity diagram - Replacement SSD 128 GB - 5MMSSD.0128-00 ≤ D0

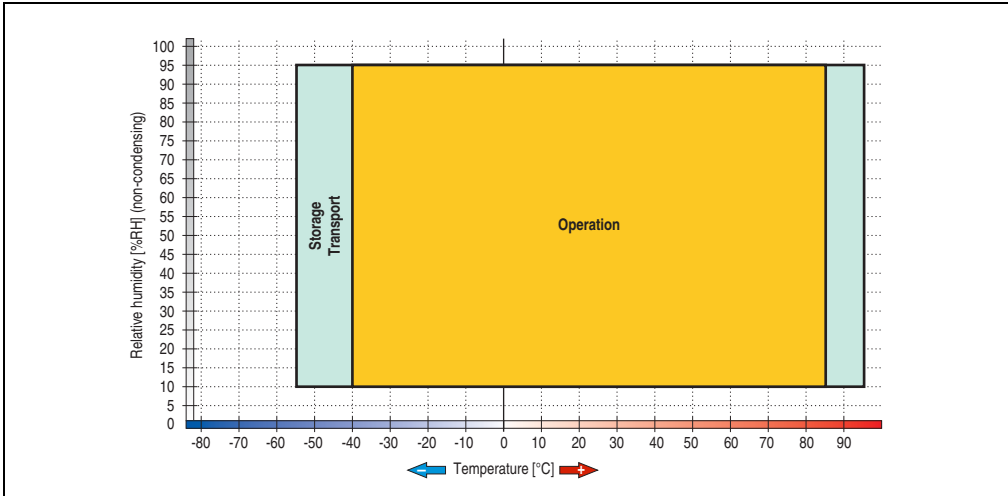

Figure 71: Temperature humidity diagram - Replacement SSD 128 GB - 5MMSSD.0128-00 ≥ E0

### 3.7.3 Add-on hard disk 30 GB 24x7 - 5AC600.HDDI-00

This hard disk is specified for 24-hour operation (24x7). The add-on drive is referred to internally as the primary slave drive.

#### Information:

Add-on drives are only available factory-installed. Therefore, they need to be requested when placing an order.



Figure 72: Add-on hard disk 30 GB 24x7 - 5AC600.HDDI-00

#### Technical data

#### Information:

The following characteristics, features, and limit values only apply to this individual component and can deviate from those specified for the entire device. For the entire device in which this individual component is used, refer to the data given specifically for the entire device.

Features	5AC600.HDDI-00
Manufacturer's product ID	Fujitsu MHT2030AR
Formatted capacity	30 GB
Number of heads	2
Number of sectors (user)	58,605,120
Bytes per sector	512
Revolution speed	4200 rpm $\pm$ 1%
Access time (average)	7.14 ms

Table 85: Technical data - Add-on hard disk 5AC600.HDDI-00

## Technical Data • Individual components

Features	5AC600.HDDI-00
Positioning time (seek, typical values) Minimum (track to track) Average (read access) Maximum	1.5 ms 12 ms 22 ms
Starting time (0 rpm to read access)	5 seconds (typically)
Interface	ATA-6
Data transfer rate On the medium To/from host	26.1 to 36.2 MB/s Max. 100 MB/s (ultra-DMA mode 5)
Cache	2 MB
Noise level (idle mode)	Approx. 24 dBA at 30 cm
<b>Electrical characteristics</b>	
Lifespan	5 years or 20,000 POH (Power-On Hours)
MTBF	300,000 hours
<b>Mechanical characteristics</b>	
Add-on mounting	Fixed
Outer dimensions (without slide-in) Width Length Height	70 mm 100 mm 9.5 mm
Weight	120 g
<b>Environmental characteristics</b>	
Ambient temperature <sup>1)</sup> Operation - standard <sup>2)</sup> Operation - 24-hour <sup>3)</sup> Bearings Transport	5 to 55°C 5 to 44°C -40 to 65°C -40 to 65°C
Relative humidity Operation Bearings Transport	8 to 90%, non-condensing 5 to 95%, non-condensing 5 to 95%, non-condensing
Vibration Operation Bearings	No non-recovered errors at max. 5 - 500 Hz and 1 g (9,8 m/s <sup>2</sup> 0-peak) No damage at max. 5 - 500 Hz and 5 g (49 m/s <sup>2</sup> 0-peak)
Shock (pulse with a sine half-wave) Operation Bearings	No non-recovered errors at max. 225 g (2207 m/s <sup>2</sup> 0-peak) and 2 ms duration No damage at max. 900 g (8820 m/s <sup>2</sup> 0-peak) and 1 ms duration No damage at max. 120 g (1176 m/s <sup>2</sup> 0-peak) and 11 ms duration
Altitude Operation Bearings	- 300 to 3000 meters - 300 to 12000 meters

Table 85: Technical data - Add-on hard disk 5AC600.HDDI-00 (Forts.)

- 1) Temperature data is for operation at 500 meters. Derating the max. ambient temperature - typically 1°C per 1000 meters (from 500 meters above sea level).
- 2) Standard operation means 250 POH (power-on hours) per month.
- 3) 24-hour operation means 732 POH (power-on hours) per month.

Temperature humidity diagram

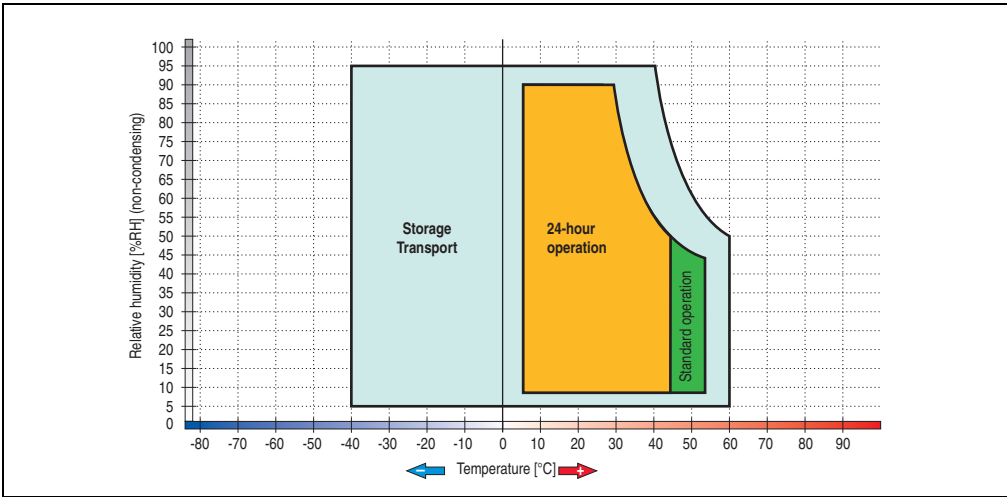

Figure 73: Temperature humidity diagram - Add-on hard disk 5AC600.HDDI-00

### 3.7.4 Add-on hard disk 20 GB ET - 5AC600.HDDI-01

This hard disk has an extended temperature specification (ET), but is not permitted for 24 hour operation. The add-on drive is referred to internally as the primary slave drive.

#### Information:

**Add-on drives are only available factory-installed. Therefore, they need to be requested when placing an order.**



Figure 74: Add-on hard disk 20 GB - 5AC600.HDDI-01

#### Technical data

#### Information:

**The following characteristics, features, and limit values only apply to this individual component and can deviate from those specified for the entire device. For the entire device in which this individual component is used, refer to the data given specifically for the entire device.**

Features	5AC600.HDDI-01
Manufacturer's product ID	Fujitsu MHT2020AC
Formatted capacity	20 GB
Number of heads	2
Number of sectors (user)	39,070,080
Bytes per sector	512
Revolution speed	4200 rpm $\pm$ 1%
Access time (average)	7.14 ms

Table 86: Technical data - Add-on hard disk 5AC600.HDDI-01

Features	5AC600.HDDI-01
Positioning time (seek, typical values) Minimum (track to track) Average (read access) Maximum	1.5 ms 12 ms 22 ms
Starting time (0 rpm to read access)	5 seconds (typically)
Interface	ATA-6
Data transfer rate On the medium To/from host	Up to 28.9 MB/s Max. 100 MB/s (ultra-DMA mode 5)
Cache	2 MB
Noise level (idle mode)	Approx. 22 dBA at 30 cm
Electrical characteristics	
Lifespan	5 years or 20,000 POH (Power-On Hours)
MTBF	300,000 hours
Mechanical characteristics	
Add-on mounting	Fixed
Outer dimensions (without slide-in) Width Length Height	70 mm 100 mm 9.5 mm
Weight	120 g
Environmental characteristics	
Ambient temperature <sup>1)</sup> Operation <sup>2)</sup> Bearings Transport	-20 to 80°C -40 to 85°C -40 to 85°C
Relative humidity Operation Bearings Transport	8 to 90%, non-condensing 5 to 95%, non-condensing 5 to 95%, non-condensing
Vibration Operation Bearings	No non-recovered errors at max. 5 - 500 Hz and 1 g (9.8 m/s <sup>2</sup> 0-peak) No damage at max. 5 - 500 Hz and 5 g (49 m/s <sup>2</sup> 0-peak)
Shock (pulse with a sine half-wave) Operation Bearings	No non-recovered errors at max. 225 g (2207 m/s <sup>2</sup> 0-peak) and 2 ms duration No damage at max. 900 g (8820 m/s <sup>2</sup> 0-peak) and 1 ms duration No damage at max. 120 g (1176 m/s <sup>2</sup> 0-peak) and 11 ms duration
Altitude Operation Bearings	- 300 to 3000 meters - 300 to 12000 meters

Table 86: Technical data - Add-on hard disk 5AC600.HDDI-01 (Forts.)

- 1) Temperature data is for operation at 500 meters. Derating the max. ambient temperature - typically 1°C per 1000 meters (from 500 meters above sea level).
- 2) Standard operation means 250 POH (power-on hours) per month.

Temperature humidity diagram

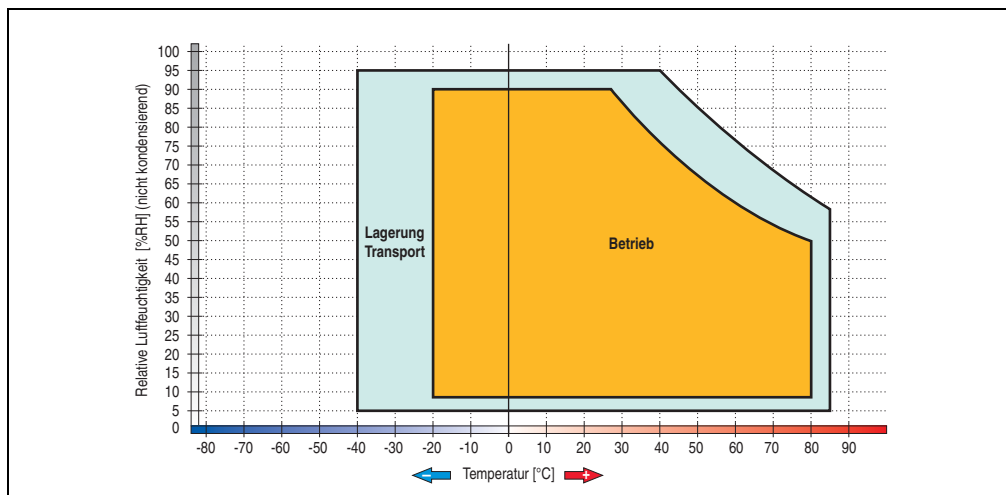

Figure 75: Temperature humidity diagram - Add-on hard disk 5AC600.HDDI-01



### 3.7.5 Add-on hard disk 40 GB 24x7 - 5AC600.HDDI-02

This hard disk is specified for 24-hour operation (24x7). The add-on drive is referred to internally as the primary slave drive.

#### Information:

**Add-on drives are only available factory-installed. Therefore, they need to be requested when placing an order.**



Figure 76: Add-on hard disk 40 GB - 5AC600.HDDI-02

#### Technical data

#### Information:

**The following characteristics, features, and limit values only apply to this individual component and can deviate from those specified for the entire device. For the entire device in which this individual component is used, refer to the data given specifically for the entire device.**

Features	5AC600.HDDI-02
Manufacturer's product ID	Hitachi HTE726040M9AT00
Formatted capacity	40 GB
Number of heads	4
Number of sectors (user)	78,140,160
Bytes per sector	512
Revolution speed	7200 rpm $\pm$ 1%
Access time (average)	10 ms

Table 87: Technical data - add-on hard disk - 5AC600.HDDI-02

## Technical Data • Individual components

Features	5AC600.HDDI-02
Positioning time (seek, typical values)	
Minimum (track to track)	1 ms
Average (read access)	10 ms
Maximum (read access)	16 ms
Starting time (0 rpm to read access)	4 seconds (typically)
Interface	ATA-6
Data transfer rate	
On the medium	236 to 507 MBit/s
To/from host	Max. 100 MB/s (ultra-DMA mode 5)
Cache	8 MB
<b>Electrical characteristics</b>	
Lifespan	5 years or 30,000 POH (Power-On Hours)
MTBF	477,000 hours <sup>1)</sup>
<b>Mechanical characteristics</b>	
Add-on mounting	Fixed
Outer dimensions (without slide-in)	
Width	70 mm
Length	100 mm
Height	9.5 mm
Weight	120 g
<b>Environmental characteristics</b>	
Ambient temperature <sup>2)</sup>	
Operation - standard <sup>3)</sup>	5 to 55°C
Operation - 24-hour <sup>4)</sup>	5 to 40°C
Bearings	-40 to 65°C
Transport	-40 to 65°C
Relative humidity	
Operation	8 to 90%, non-condensing
Bearings	5 to 95%, non-condensing
Transport	5 to 95%, non-condensing
Vibration	
Operation	5 - 500 Hz: 1 g (9.8 m/s <sup>2</sup> 0-peak) duration 2 octaves per minute; no non-recovered errors
Bearings	5 - 500 Hz: 5 g (49 m/s <sup>2</sup> 0-peak) duration 0.5 oct./min.; no damage
Shock (pulse with a sine half-wave)	
Operation	No non-recovered errors at max. 200 g (1960 m/s <sup>2</sup> 0-peak) and 2 ms duration
Bearings	No non-recovered errors at max. 15 g (147 m/s <sup>2</sup> 0-peak) and 11 ms duration No damage at max. 980 g (9800 m/s <sup>2</sup> 0-peak) and 1 ms duration No damage at max. 120 g (1176 m/s <sup>2</sup> 0-peak) and 11 ms duration
Altitude	
Operation	- 300 to 3048 meters
Bearings	- 300 to 12192 meters

Table 87: Technical data - add-on hard disk - 5AC600.HDDI-02 (Forts.)

- 1) Manufacturer specification at + 40°C ambient temperature.
- 2) Temperature data is for operation at 500 meters. Derating the max. ambient temperature - typically 1°C per 1000 meters (from 500 meters above sea level).
- 3) Standard operation means 333 POH (power-on hours) per month.
- 4) 24-hour operation means 732 POH (power-on hours) per month.

Temperature humidity diagram

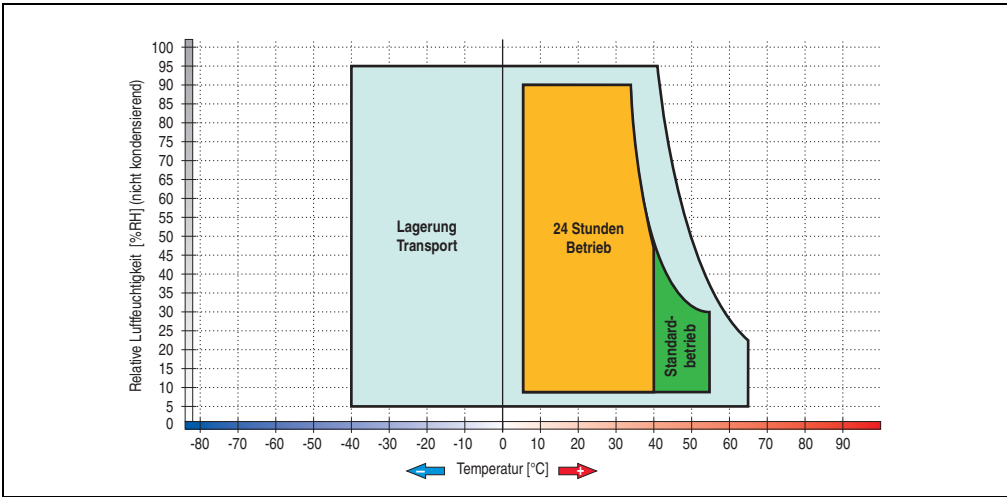

Figure 77: Temperature humidity diagram - Add-on hard disk 5AC600.HDDI-02

### 3.7.6 Add-on hard disk 60 GB 24x7 - 5AC600.HDDI-03

This hard disk is specified for 24-hour operation (24x7). The add-on drive is referred to internally as the primary slave drive.

#### Information:

**Add-on drives are only available factory-installed. Therefore, they need to be requested when placing an order.**



Figure 78: Add-on hard disk 60 GB - 5AC600.HDDI-03

#### Technical data

#### Information:

**The following characteristics, features, and limit values only apply to this individual component and can deviate from those specified for the entire device. For the entire device in which this individual component is used, refer to the data given specifically for the entire device.**

Features	5AC600.HDDI-03
Manufacturer's product ID	Hitachi HTE721060G9AT00
Formatted capacity	60 GB
Number of heads	3
Number of sectors (user)	117,210,240
Bytes per sector	512
Revolution speed	7200 rpm $\pm$ 1%
Access time (average)	10 ms

Table 88: Technical data - add-on hard disk - 5AC600.HDDI-03

Features	5AC600.HDDI-03
Positioning time (seek, typical values) Minimum (track to track) Average (read access) Maximum (read access)	1 ms 10 ms 16 ms
Starting time (0 rpm to read access)	4 seconds (typically)
Interface	ATA-6
Data transfer rate On the medium To/from host	267 to 629 MBit/s Max. 100 MB/s (ultra-DMA mode 5)
Cache	8 MB
<b>Electrical characteristics</b>	
Lifespan	5 years or 30,000 POH (Power-On Hours)
MTBF	550,000 hours <sup>1)</sup>
<b>Mechanical characteristics</b>	
Add-on mounting	Fixed
Outer dimensions (without slide-in) Width Length Height	70 mm 100 mm 9.5 mm
Weight	120 g
<b>Environmental characteristics</b>	
Ambient temperature <sup>2)</sup> Operation - standard <sup>3)</sup> Operation - 24-hour <sup>4)</sup> Bearings Transport	5 to 55°C 5 to 40°C -40 to 65°C -40 to 65°C
Relative humidity Operation Bearings Transport	8 to 90%, non-condensing 5 to 95%, non-condensing 5 to 95%, non-condensing
Vibration Operation Bearings	5 - 500 Hz: 1 g (9.8 m/s <sup>2</sup> 0-peak) duration 1 octave per minute; no non-recovered errors 10 - 500 Hz: 5 g (49 m/s <sup>2</sup> 0-peak) duration 0.5 oct./min.; no damage
Shock (pulse with a sine half-wave) Operation  Bearings	No non-recovered errors at max. 160 g (1568 m/s <sup>2</sup> 0-peak) and 1 ms duration No non-recovered errors at max. 300 g (2900 m/s <sup>2</sup> 0-peak) and 2 ms duration No non-recovered errors at max. 15 g (147 m/s <sup>2</sup> 0-peak) and 11 ms duration No damage at max. 1000 g (9800 m/s <sup>2</sup> 0-peak) and 1 ms duration No damage at max. 120 g (1176 m/s <sup>2</sup> 0-peak) and 11 ms duration
Altitude Operation Bearings	- 300 to 3048 meters - 300 to 12192 meters

Table 88: Technical data - add-on hard disk - 5AC600.HDDI-03 (Forts.)

- 1) Manufacturer specification at + 40°C ambient temperature.
- 2) Temperature data is for operation at 500 meters. Derating the max. ambient temperature - typically 1°C per 1000 meters (from 500 meters above sea level).
- 3) Standard operation means 333 POH (power-on hours) per month.
- 4) 24-hour operation means 732 POH (power-on hours) per month.

Temperature humidity diagram

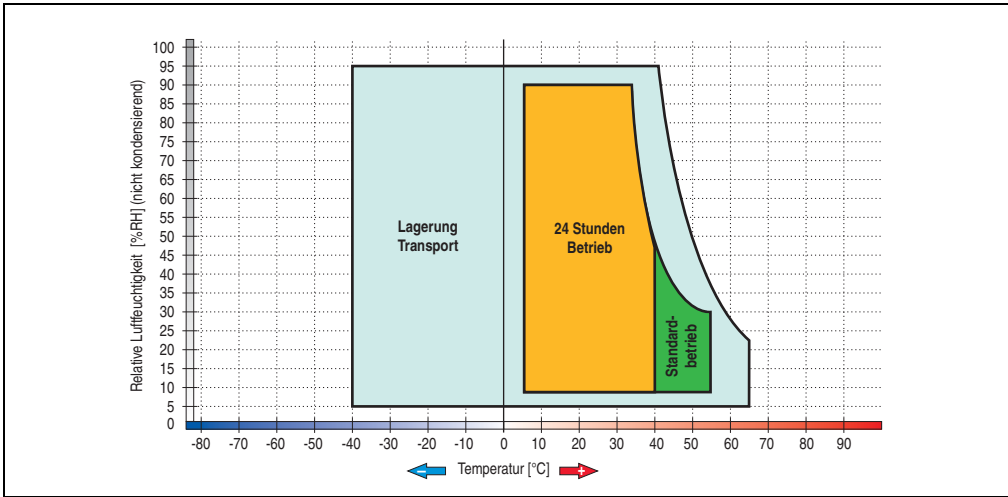

Figure 79: Temperature humidity diagram - Add-on hard disk 5AC600.HDDI-03

### 3.7.7 Add-on hard disk 80 GB 24x7 - 5AC600.HDDI-04

This hard disk is specified for 24-hour operation (24x7). The add-on drive is referred to internally as the primary slave drive.

#### Information:

Add-on drives are only available factory-installed. Therefore, they need to be requested when placing an order.



Figure 80: Add-on hard disk 80 GB - 5AC600.HDDI-04

#### Technical data

#### Information:

The following characteristics, features, and limit values only apply to this individual component and can deviate from those specified for the entire device. For the entire device in which this individual component is used, refer to the data given specifically for the entire device.

Features	5AC600.HDDI-04
Manufacturer's product ID	Hitachi HTE721080G9AT00
Formatted capacity	80 GB
Number of heads	4
Number of sectors (user)	156,301,488
Bytes per sector	512
Revolution speed	7200 rpm $\pm$ 1%
Access time (average)	10 ms

Table 89: Technical data - add-on hard disk - 5AC600.HDDI-04

## Technical Data • Individual components

Features	5AC600.HDDI-04
Positioning time (seek, typical values)	
Minimum (track to track)	1 ms
Average (read access)	10 ms
Maximum (read access)	16 ms
Starting time (0 rpm to read access)	4 seconds (typically)
Interface	ATA-6
Data transfer rate	
On the medium	267 to 629 MBit/s
To/from host	Max. 100 MB/s (ultra-DMA mode 5)
Cache	8 MB
Electrical characteristics	
Lifespan	5 years or 30,000 POH (Power-On Hours)
MTBF	550,000 hours <sup>1)</sup>
Mechanical characteristics	
Add-on mounting	Fixed
Outer dimensions (without slide-in)	
Width	70 mm
Length	100 mm
Height	9.5 mm
Weight	120 g
Environmental characteristics	
Ambient temperature <sup>2)</sup>	
Operation - standard <sup>3)</sup>	5 to 55°C
Operation - 24-hour <sup>4)</sup>	5 to 40°C
Bearings	-40 to 65°C
Transport	-40 to 65°C
Relative humidity	
Operation	8 to 90%, non-condensing
Bearings	5 to 95%, non-condensing
Transport	5 to 95%, non-condensing
Vibration	
Operation	5 - 500 Hz: 1 g (9.8 m/s <sup>2</sup> 0-peak) duration 1 octave per minute; no non-recovered errors
Bearings	10 - 500 Hz: 5 g (49 m/s <sup>2</sup> 0-peak) duration 0.5 oct./min.; no damage
Shock (pulse with a sine half-wave)	
Operation	No non-recovered errors at max. 160 g (1568 m/s <sup>2</sup> 0-peak) and 1 ms duration No non-recovered errors at max. 300 g (2900 m/s <sup>2</sup> 0-peak) and 2 ms duration No non-recovered errors at max. 15 g (147 m/s <sup>2</sup> 0-peak) and 11 ms duration
Bearings	No damage at max. 1000 g (9800 m/s <sup>2</sup> 0-peak) and 1 ms duration No damage at max. 120 g (1176 m/s <sup>2</sup> 0-peak) and 11 ms duration
Altitude	
Operation	- 300 to 3048 meters
Bearings	- 300 to 12192 meters

Table 89: Technical data - add-on hard disk - 5AC600.HDDI-04 (Forts.)

- 1) Manufacturer specification at + 40°C ambient temperature.
- 2) Temperature data is for operation at 500 meters. Derating the max. ambient temperature - typically 1°C per 1000 meters (from 500 meters above sea level).
- 3) Standard operation means 333 POH (power-on hours) per month.
- 4) 24-hour operation means 732 POH (power-on hours) per month.



Temperature humidity diagram

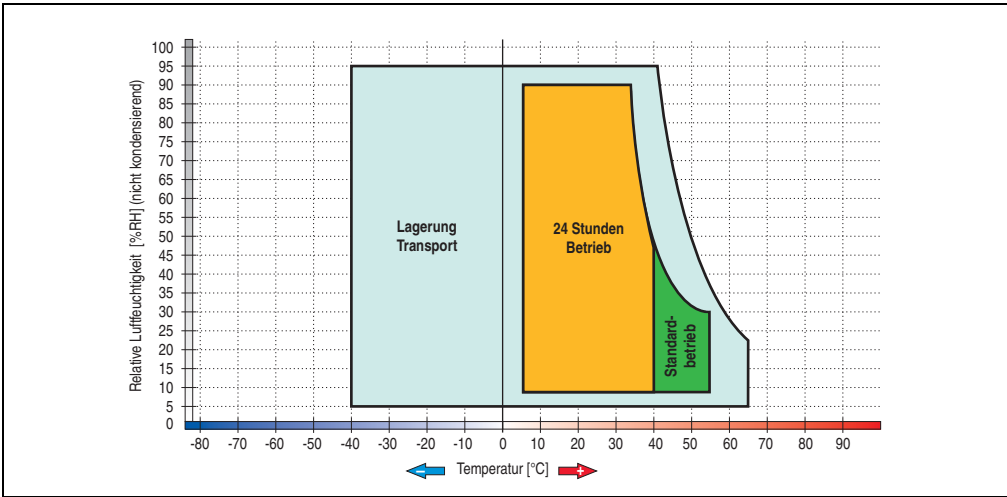

Figure 81: Temperature humidity diagram - Add-on hard disk 5AC600.HDDI-04

### 3.7.8 Add-on hard disk 40 GB 24x7 ET - 5AC600.HDDI-05

This hard disk is specified for 24-hour operation (24x7) and also provides an extended temperature specification (ET). The add-on drive is referred to internally as the primary slave drive.

#### Information:

**Add-on drives are only available factory-installed. Therefore, they need to be requested when placing an order.**



Figure 82: Add-on hard disk 40 GB - 5AC600.HDDI-05

#### Technical data

#### Information:

**The following characteristics, features, and limit values only apply to this individual component and can deviate from those specified for the entire device. For the entire device in which this individual component is used, refer to the data given specifically for the entire device.**

Features	5AC600.HDDI-05 < Revision D0	5AC600.HDDI-05 Revision D0
Manufacturer's product ID	Seagate ST940813AM	Seagate ST940817AM
Formatted capacity	40 GB	
Number of heads	2	
Number of sectors (user)	78,140,160	
Bytes per sector	512	
Revolution speed	5400 rpm $\pm$ 1%	
Access time (average)	12.5 ms	

Table 90: Technical data - Add-on hard disk 5AC600.HDDI-05

## Technical Data • Individual components

Features	5AC600.HDDI-05 < Revision D0	5AC600.HDDI-05 Revision D0
Positioning time (seek, typical values) Minimum (track to track) Average (read access) Maximum (read access)	1 ms 12.5 ms 22 ms	
Starting time (0 rpm to read access)	3 seconds (typically)	
Interface	ATA-6	
Data transfer rate On the medium To/from host	Max. 321 MBit/s Max. 100 MB/s (Ultra-DMA Mode 5)	Max. 450 MBit/s Max. 100 MB/s (Ultra-DMA Mode 5)
Cache	8 MB	
S.M.A.R.T. Support	Yes	
MTBF	550,000 hours <sup>1)</sup>	750,000 hours <sup>1)</sup>
Mechanical characteristics		
Add-on mounting	Fixed	
Outer dimensions (without slide-in) Width Length Height	70 mm 100 mm 9.5 mm	
Weight	100 g	
Environmental characteristics		
Ambient temperature <sup>2)</sup> Operation - Standard / 24-hour Bearings Transport	-30 to 85°C -40 to 95°C -40 to 95°C	
Relative humidity Operation Bearings Transport	5 to 90%, non-condensing 5 to 95%, non-condensing 5 to 95%, non-condensing	
Vibration Operation Bearings	10 - 500 Hz: 1 g; no non-recovered errors 5 - 500 Hz: 5 g; no non-recovered errors	5 - 500 Hz: 2 g; no non-recovered errors 5 - 500 Hz: 5 g; no non-recovered errors
Shock (pulse with a sine half-wave) Operation Bearings	Max. 200 g, 2 ms; no non-recovered errors Max. 110 g, 11 ms; no non-recovered errors Max. 800 g, 2 ms; no damage Max. 400 g, 0.5 ms; no damage	Max. 300 g, 2 ms; no non-recovered errors Max. 150 g, 11 ms; no non-recovered errors Max. 800 g, 2 ms; no damage Max. 400 g, 0.5 ms; no damage
Altitude Operation Bearings	- 300 to 4419 meters - 300 to 12192 meters	- 300 to 5000 meters - 300 to 12192 meters

Table 90: Technical data - Add-on hard disk 5AC600.HDDI-05 (Forts.)

- 1) With 8760 POH (Power On Hours) per year and 70°C surface temperature.
- 2) Temperature values for 305 meter altitude. The temperature specification must be reduced linearly by 1°C every 305 meters. The temperature increase and decrease can be a maximum of 3°C per minute.

Temperature humidity diagram

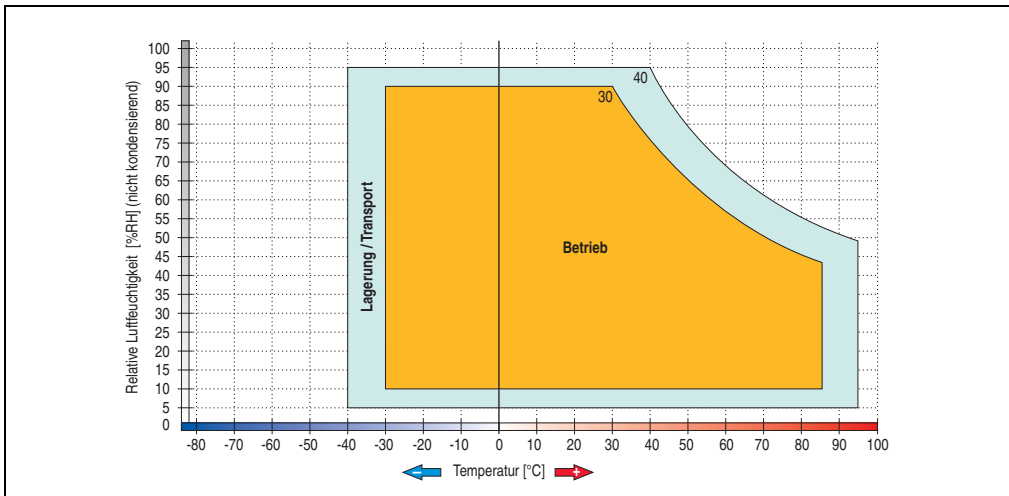

Figure 83: Temperature humidity diagram - Add-on hard disk 5AC600.HDDI-05

Temperature values for 305 meter altitude. The temperature specification must be reduced linearly by 1°C every 305 meters. The temperature increase and decrease can be a maximum of 3°C per minute.

### 3.7.9 Add-on hard disk 80 GB 24x7 ET - 5AC600.HDDI-06

This hard disk is specified for 24-hour operation (24x7) and also provides an extended temperature specification (ET). The add-on drive is referred to internally as the primary slave drive.

#### Information:

**Add-on drives are only available factory-installed. Therefore, they need to be requested when placing an order.**



Figure 84: Add-on hard disk 80 GB - 5AC600.HDDI-06

#### Technical data

#### Information:

**The following characteristics, features, and limit values only apply to this individual component and can deviate from those specified for the entire device. For the entire device in which this individual component is used, refer to the data given specifically for the entire device.**

Features	5AC600.HDDI-06
Manufacturer's product ID	Seagate ST980817AM
Formatted capacity	80 GB
Number of heads	2
Number of sectors (user)	156,301,488
Bytes per sector	512
Revolution speed	5400 rpm ±1%
Access time (average)	10 ms

Table 91: Technical data - add-on hard disk - 5AC600.HDDI-06

## Technical Data • Individual components

Features	5AC600.HDDI-06
Positioning time (seek, typical values) Minimum (track to track) Average (read access) Maximum (read access)	1 ms 12.5 ms 22 ms
Starting time (0 rpm to read access)	4 seconds (typically)
Interface	ATA-6
Data transfer rate On the medium To/from host	Max. 450 MBit/s Max. 100 MB/s (Ultra-DMA Mode 5)
S.M.A.R.T. Support	Yes
Cache	8 MB
MTBF	750,000 hours <sup>1)</sup>
Mechanical characteristics	
Add-on mounting	Fixed
Outer dimensions (without slide-in) Width Length Height	70 mm 100 mm 9.5 mm
Weight	120 g
Environmental characteristics	
Ambient temperature <sup>2)</sup> Operation - Standard / 24-hour Bearings Transport	-30 to 85°C -40 to 95°C -40 to 95°C
Relative humidity Operation Bearings Transport	5 to 90%, non-condensing 5 to 95%, non-condensing 5 to 95%, non-condensing
Vibration Operation Bearings	5 - 500 Hz: 2 g; no non-recovered errors 5 - 500 Hz: 5 g; no non-recovered errors
Shock (pulse with a sine half-wave) Operation Bearings	Max. 300 g, 2 ms; no non-recovered errors Max. 150 g, 11 ms; no non-recovered errors Max. 800 g, 2 ms; no damage Max. 400 g, 0.5 ms; no damage
Altitude Operation Bearings	- 300 to 5000 meters - 300 to 12192 meters

Table 91: Technical data - add-on hard disk - 5AC600.HDDI-06 (Forts.)

- 1) With 8760 POH (Power On Hours) per year and 70°C surface temperature.
- 2) Temperature values for 305 meter altitude. The temperature specification must be reduced linearly by 1°C every 305 meters. The temperature increase and decrease can be a maximum of 3°C per minute.

Temperature humidity diagram

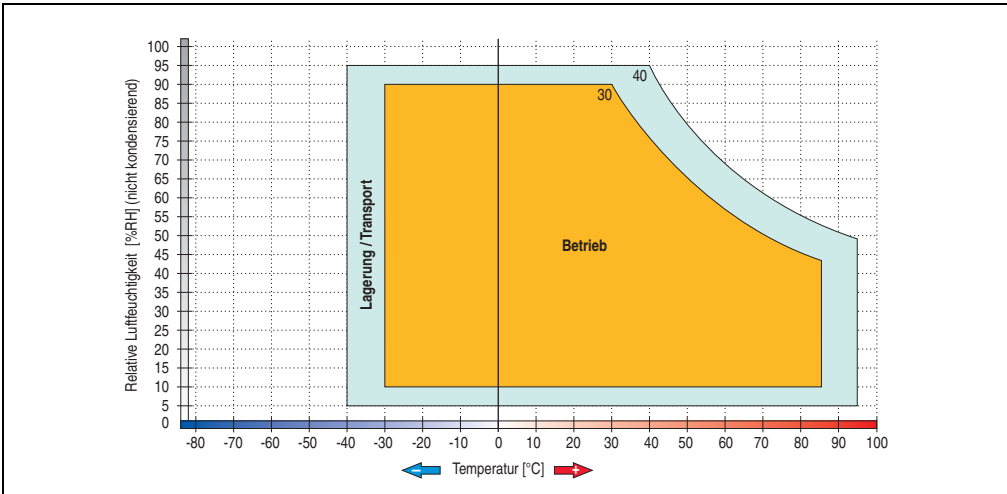

Figure 85: Temperature humidity diagram - Add-on hard disk 5AC600.HDDI-06

Temperature values for 305 meter altitude. The temperature specification must be reduced linearly by 1°C every 305 meters. The temperature increase and decrease can be a maximum of 3°C per minute.

### 3.7.10 Add-on CompactFlash slot - 5AC600.CFSI-00

A CompactFlash card inserted in the add-on drive is referred to internally as the "primary slave drive."

#### Information:

Add-on drives are only available factory-installed. Therefore, they need to be requested when placing an order.

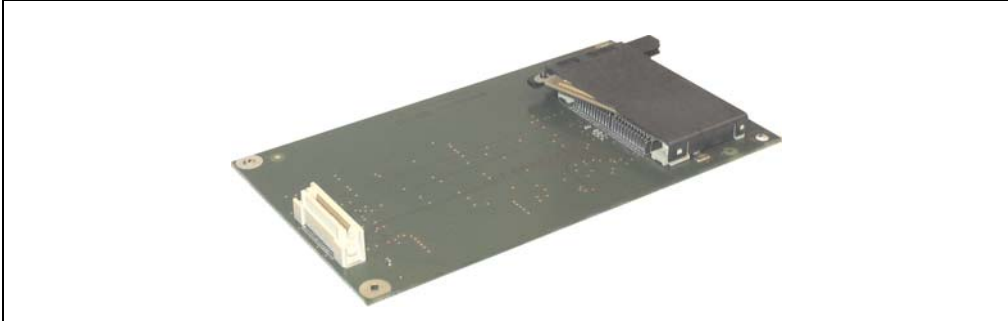

Figure 86: Add-on CompactFlash slot - 5AC600.CFSI-00

#### Technical data

Features	5AC600.CFSI-00
CompactFlash Type Amount Connection	Type I 1 slot Primary slave
Weight	100 g

Table 92: Technical data - Add-on CompactFlash slot 5AC600.CFSI-00

#### Warning!

Inserting and removing the CompactFlash card can only take place without power applied!



### 3.7.11 Slide-in CD-ROM - 5AC600.CDXS-00

The slide-in drive can be used in system units with 2, 3 or 5 PCI slots. When inserted in slide-in slot 1 it is referred to internally as "secondary slave" and when in slide-in slot 2 as "secondary master."

#### Information:

It is possible to add or remove a slide-in drive at any time.

#### Caution!

Turn off power before adding or removing a slide-in drive.



Figure 87: Slide-in CD-ROM - 5AC600.CDXS-00

#### Technical data

#### Information:

The following characteristics, features, and limit values only apply to this individual component and can deviate from those specified for the entire device. For the entire device in which this individual component is used, refer to the data given specifically for the entire device.

## Technical Data • Individual components

Features	5AC600.CDXS-00
Reading rate	24x
Data transfer rate	Max. 33.3 MB/s
Access time (average)	115 ms
Revolution speed	Max. 5136 rpm $\pm$ 1%
Starting time (0 rpm to read access)	10 seconds (maximum)
Host interface	IDE (ATAPI)
Readable CD media	CD/CD-ROM (12 cm, 8 cm), CD-R, CD-RW
Compatible formats	CD-DA, CD-ROM mode 1/mode 2 CD-ROM XA mode 2 (form 1, form 2) Photo CD (single/multi-session) Enhanced CD
Cache	128 kB
Noise level (complete read access)	Approx. 45 dBA at 50 cm
Lifespan Opening/closing the drawer	60,000 POH (Power-On Hours) > 10,000 times
Environmental characteristics	
Ambient temperature <sup>1)</sup> Operation Bearings Transport	-5 to 60°C <sup>2)</sup> -20 to 60°C -40 to 65°C
Relative humidity Operation Bearings Transport	8 to 80%, non-condensing 5 to 95%, non-condensing 5 to 95%, non-condensing
Vibration Operation Bearings Transport	At max. 5 - 500 Hz and 0.3 g At max. 5 - 500 Hz and 2 g At max. 5 - 500 Hz and 5 g
Shock (pulse with a sine half-wave) Operation Bearings Transport	At max. 7 g for 11 ms At max. 60 g for 11 ms At max. 200 g for 2 ms At max. 60 g for 11 ms At max. 200 g for 2 ms

Table 93: Technical data - Slide-in CD-ROM 5AC600.CDXS-00

- 1) Temperature data is for operation at 500 meters. Derating the max. ambient temperature - typically 1°C per 1000 meters (from 500 meters above sea level).
- 2) Drive surface temperature

Temperature humidity diagram

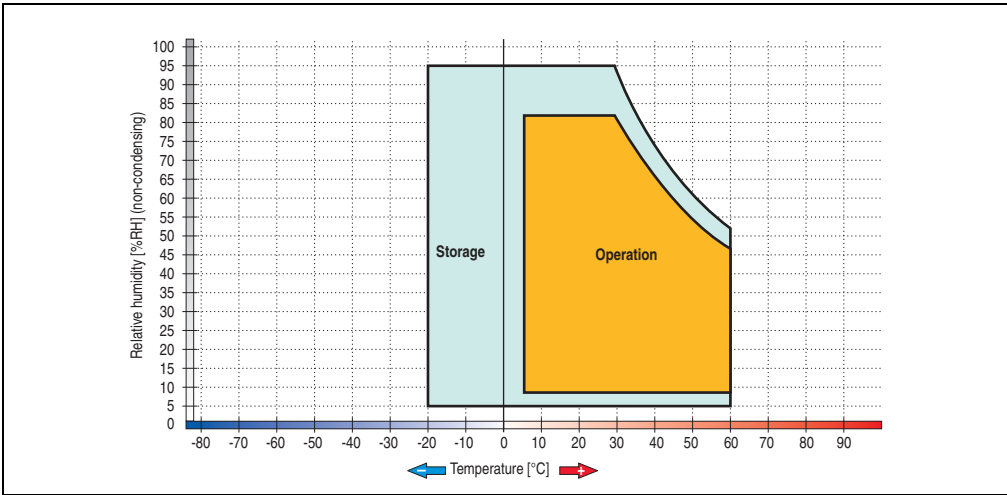

Figure 88: Temperature humidity diagram - Slide-in CD-ROM 5AC600.CDXS-00

### 3.7.12 Slide-in DVD-ROM/CD-RW - 5AC600.DVDS-00

The slide-in drive can be used in system units with 2, 3 or 5 PCI slots. When inserted in slide-in slot 1 it is referred to internally as "secondary slave" and when in slide-in slot 2 as "secondary master."

#### Information:

It is possible to add or remove a slide-in drive at any time.

#### Caution!

Turn off power before adding or removing a slide-in drive.



Figure 89: Slide-in DVD-ROM/CD-RW - 5AC600.DVDS-00

#### Technical data

#### Information:

The following characteristics, features, and limit values only apply to this individual component and can deviate from those specified for the entire device. For the entire device in which this individual component is used, refer to the data given specifically for the entire device.

## Technical Data • Individual components

Features	5AC600.DVDS-00
Write speed CD-R CD-RW	24x, 16x, 10x and 4x 10x and 4x
Reading rate CD DVD	24x 8x
Data transfer rate	Max. 33.3 MB/s
Access time (average) CD DVD	85 ms 110 ms
Revolution speed	Max. 5136 rpm ±1%
Starting time (0 rpm to read access)	19 seconds (maximum)
Host interface	IDE (ATAPI)
Readable media CD DVD	CD/CD-ROM (12 cm, 8 cm), CD-R, CD-RW DVD-ROM, DVD-R, DVD-RW, DVD-RAM
Non-write protected media CD	CD-R, CD-RW
Compatible formats	CD-DA, CD-ROM mode 1/mode 2 CD-ROM XA mode 2 (form 1, form 2) Photo CD (single/multi-session) Enhanced CD, CD text DVD-ROM, DVD-R, DVD-Video (double layer) DVD-RAM (4.7 GB, 2.6 GB)
Write-methods	Disk at once, session at once, packet write, track at once
Laser class	Class 1 laser
Data buffer capacity	2 MB
Noise level (complete read access)	Approx. 45 dBA at 50 cm
Lifespan Opening/closing the drawer	60,000 POH (Power-On Hours) > 10,000 times
<b>Environmental characteristics</b>	
Ambient temperature <sup>1)</sup> Operation Bearings Transport	+5 to +50°C <sup>2)</sup> -20 to +60°C -40 to +65°C
Relative humidity Operation Bearings Transport	8 to 80%, non-condensing 5 to 95%, non-condensing 5 to 95%, non-condensing
Vibration Operation Bearings Transport	At max. 5 - 500 Hz and 0.2 g At max. 5 - 500 Hz and 2 g At max. 5 - 500 Hz and 2 g

Table 94: Technical data - Slide-in DVD-ROM/CD-RW 5AC600.DVDS-00

## Technical Data • Individual components

Features	5AC600.DVDS-00
Shock (pulse with a sine half-wave)	
Operation	At max. 5 g for 11 ms
Bearings	At max. 60 g for 11 ms
	At max. 200 g for 2 ms
Transport	At max. 60 g for 11 ms
	At max. 200 g for 2 ms

Table 94: Technical data - Slide-in DVD-ROM/CD-RW 5AC600.DVDS-00 (Forts.)

- 1) Temperature data is for operation at 500 meters. Derating the max. ambient temperature - typically 1°C per 1000 meters (from 500 meters above sea level).
- 2) Drive surface temperature

### Temperature humidity diagram

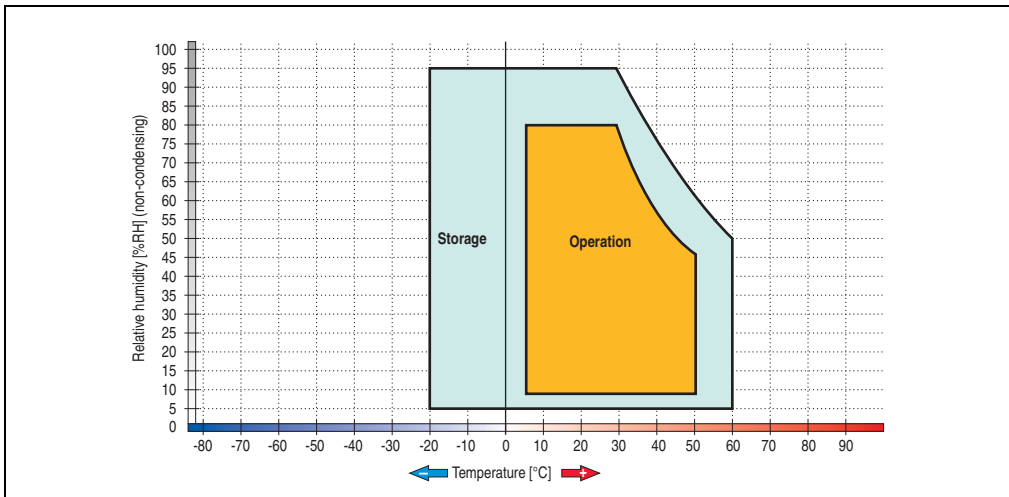

Figure 90: Temperature humidity diagram - Slide-in DVD-ROM/CD-RW 5AC600.DVDS-00

### 3.7.13 Slide-in DVD-R/RW, DVD+R/RW - 5AC600.DVRS-00

The slide-in drive can be used in system units with 2, 3 or 5 PCI slots. When inserted in slide-in slot 1 it is referred to internally as "secondary slave" and when in slide-in slot 2 as "secondary master."

#### Information:

It is possible to add or remove a slide-in drive at any time.

#### Caution!

Turn off power before adding or removing a slide-in drive.



Figure 91: Slide-in DVD-R/RW, DVD+R/RW - 5AC600.DVRS-00

#### Technical data - Revision D0 and higher

#### Information:

The following characteristics, features, and limit values only apply to this individual component and can deviate from those specified for the entire device. For the entire device in which this individual component is used, refer to the data given specifically for the entire device.

## Technical Data • Individual components

Features	5AC600.DVRS-00 revision D0 and higher
Write speed CD-R CD-RW DVD-R DVD-RW DVD-RAM <sup>1)</sup> DVD+R DVD+R (double layer) DVD+RW	24x, 16x, 10x and 4x 10x and 4x 8x, 4x and 2x 4x and 2x 3x and 2x 8x, 4x and 2x 2x, 4x 4x and 2x
Reading rate CD DVD	24x 8x
Data transfer rate	Max. 33.3 MB/s
Access time (average) CD DVD	130 ms (24x) 130 ms (8x)
Revolution speed	Max. 5090 rpm $\pm$ 1%
Starting time (0 rpm to read access) CD DVD	14 seconds (maximum) 15 seconds (maximum)
Host interface	IDE (ATAPI)
Readable media CD DVD	CD/CD-ROM (12 cm, 8 cm), CD-R, CD-RW DVD-ROM, DVD-R, DVD-RW, DVD-RAM, DVD+R, DVD+R (double layer), DVD+RW
Non-write protected media CD DVD	CD-R, CD-RW DVD-R/RW, DVD-RAM (4.7 GB), DVD+R/RW, DVD+R (double layer)
Compatible formats	CD-DA, CD-ROM mode 1/mode 2 CD-ROM XA mode 2 (form 1, form 2) Photo CD (single/multi-session), Enhanced CD, CD text DVD-ROM, DVD-R, DVD-RW, DVD-Video DVD-RAM (4.7 GB, 2.6 GB) DVD+R, DVD+R (double layer), DVD+RW
Write-methods CD DVD	Disk at once, session at once, packet write, track at once Disk at once, incremental, over-write, sequential, multi-session
Laser class	Class 1 laser
Data buffer capacity	8 MB
Noise level (complete read access)	Approx. 48 dBA at 50 cm
Lifespan Opening/closing the drawer	60,000 POH (Power-On Hours) > 10,000 times
<b>Environmental characteristics</b>	
Ambient temperature <sup>2)</sup> Operation Bearings Transport	5 to 55°C <sup>3)</sup> -20 to 60°C -40 to 65°C

Table 95: Technical data - slide-in DVD-R/RW, DVD+R/RW - 5AC600.DVRS-00 revision D0 and higher



Features	5AC600.DVRS-00 revision D0 and higher
Relative humidity Operation Bearings Transport	8 to 80%, non-condensing 5 to 95%, non-condensing 5 to 95%, non-condensing
Vibration Operation Bearings Transport	At max. 5 - 500 Hz and 0.2 g At max. 5 - 500 Hz and 2 g At max. 5 - 500 Hz and 2 g
Shock (pulse with a sine half-wave) Operation Bearings Transport	At max. 5 g for 11 ms At max. 60 g for 11 ms At max. 200 g for 2 ms At max. 60 g for 11 ms At max. 200 g for 2 ms

Table 95: Technical data - slide-in DVD-R/RW, DVD+R/RW - 5AC600.DVRS-00 revision D0 and higher (Forts.)

- 1) RAM drivers are not provided by the manufacturer. Support of RAM function by the burning software "Nero" (model number 5SWUT1.0000-00) or other burning software packages and drivers from third party providers.
- 2) Temperature data is for operation at 500 meters. Derating the max. ambient temperature - typically 1°C per 1000 meters (from 500 meters above sea level).
- 3) Drive surface temperature

### Technical data - revision D0 or lower

Features	5AC600.DVRS-00 revision D0 and lower
Write speed CD-R CD-RW DVD-R DVD-RW DVD+R DVD+RW	24x, 16x, 10x and 4x 10x and 4x 8x, 4x and 2x 4x and 2x 8x, 4x and 2x 4x and 2x
Reading rate CD DVD	24x 8x
Data transfer rate	Max. 33.3 MB/s
Access time (average) CD DVD	130 ms (24x) 130 ms (8x)
Revolution speed	Max. 5090 rpm ±1%
Starting time (0 rpm to read access) CD DVD	14 seconds (maximum) 15 seconds (maximum)
Host interface	IDE (ATAPI)
Readable media CD DVD	CD/CD-ROM (12 cm, 8 cm), CD-R, CD-RW DVD-ROM, DVD-R, DVD-RW

Table 96: Technical data - slide-in DVD-R/RW, DVD+R/RW - 5AC600.DVRS-00 revision D0 and lower

## Technical Data • Individual components

Features	5AC600.DVRS-00 revision D0 and lower
Non-write protected media CD DVD	CD-R, CD-RW DVD-R/RW, DVD+R/RW
Compatible formats	CD-DA, CD-ROM mode 1/mode 2 CD-ROM XA mode 2 (form 1, form 2) Photo CD (single/multi-session) Enhanced CD, CD text DVD-ROM, DVD-R, DVD-Video (double layer), DVD-RW DVD+R, DVD+R (double layer), DVD+RW
Write-methods CD DVD	Disk at once, session at once, packet write, track at once Disk at once, incremental, over-write, sequential, multi-session
Laser class	Class 1 laser
Data buffer capacity	8 MB
Noise level (complete read access)	Approx. 48 dBA at 50 cm
Lifespan Opening/closing the drawer	60,000 POH (Power-On Hours) > 10,000 times
Environmental characteristics	
Ambient temperature <sup>1)</sup> Operation Bearings Transport	5 to 55°C <sup>2)</sup> -20 to 60°C -40 to 65°C
Relative humidity Operation Bearings Transport	8 to 80%, non-condensing 5 to 95%, non-condensing 5 to 95%, non-condensing
Vibration Operation Bearings Transport	At max. 5 - 500 Hz and 0.2 g At max. 5 - 500 Hz and 2 g At max. 5 - 500 Hz and 2 g
Shock (pulse with a sine half-wave) Operation Bearings Transport	At max. 5 g for 11 ms At max. 60 g for 11 ms At max. 200 g for 2 ms At max. 60 g for 11 ms At max. 200 g for 2 ms

Table 96: Technical data - slide-in DVD-R/RW, DVD+R/RW - 5AC600.DVRS-00 revision D0 and lower  
(Forts.)

- 1) Temperature data is for operation at 500 meters. Derating the max. ambient temperature - typically 1°C per 1000 meters (from 500 meters above sea level).
- 2) Drive surface temperature

Temperature humidity diagram

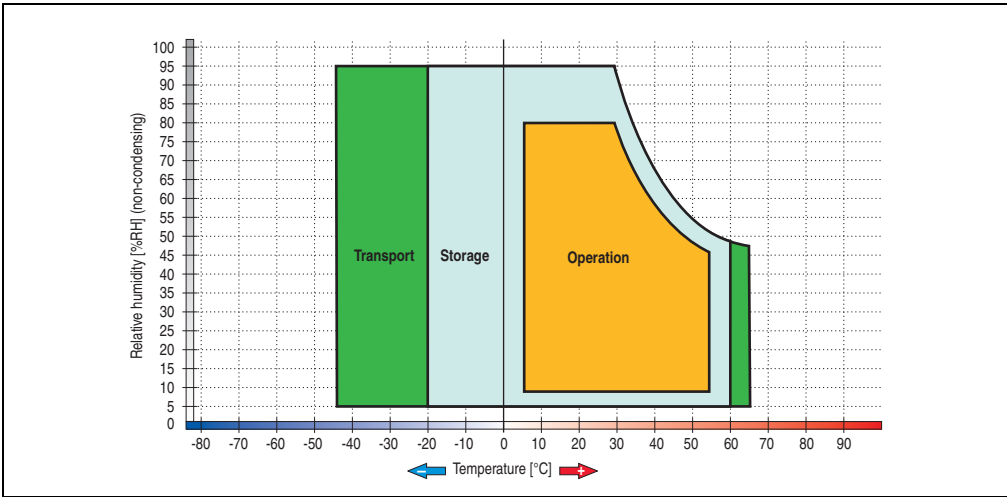

Figure 92: Temperature humidity diagram - Slide-in DVD-R/RW, DVD+R/RW 5AC600.DVRS-00

### 3.7.14 Slide-in CF 2 slot - 5AC600.CFSS-00

The slide-in drive can be used in system units with 2, 3 or 5 PCI slots. When inserted in slide-in slot 1, the CompactFlash slot CF3 is referred to internally as "secondary slave" and when in slide-in slot 2 as "secondary master." CompactFlash slot CF4 is always accessed via USB.

#### Information:

- It is possible to add or remove a slide-in drive at any time.
- In system units with 5 PCI slots, the slide-in USB FDD drive (5AC600.FDDS-00) must be inserted in slide-in slot 1. The double CompactFlash slide-in drive (5AC600.CFSS-00) should only be used in slide-in slot 2.

#### Caution!

Turn off power before adding or removing a slide-in drive.

#### Warning!

The CompactFlash card can only be inserted in and removed from the CF3 IDE CompactFlash slot can only take place without power applied to the APC620!

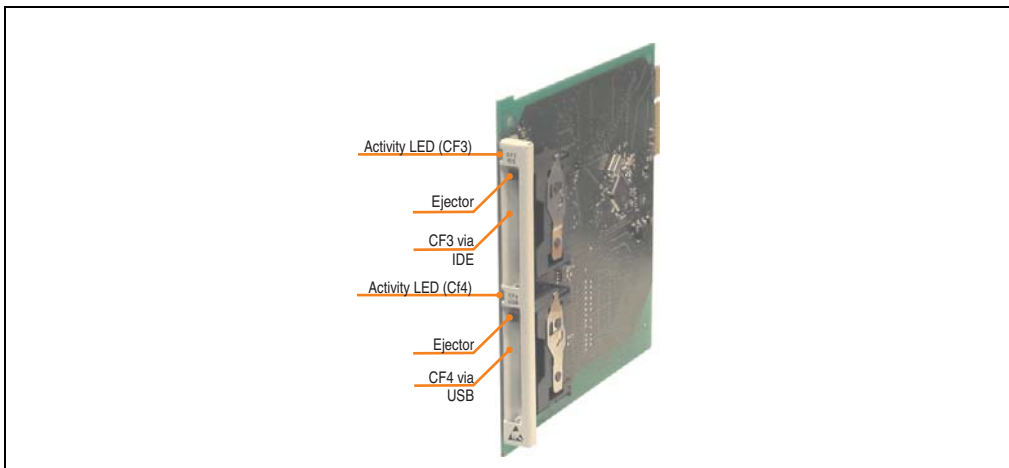

Figure 93: Slide-in CF 2-slot - 5AC600.CFSS-00

Technical data

Features	5AC600.CFSS-00
CompactFlash (CF3) Type Amount Connection  Activity LED	 Type I and II 1 slot IDE - Secondary slave in slide-in slot 1 IDE - Secondary master in slide-in slot 2 Yes
CompactFlash (CF4) Type Amount Connection Activity LED	Type I and II 1 slot Via USB 2.0 Yes

Table 97: Technical data - Slide-in CF slot 2 - 5AC600.CFSS-00

### 3.7.15 Slide-in USB FDD - 5AC600.FDDS-00

The slide-in drive can be used in system units with 2, 3 or 5 PCI slots. In these units it is connected to the system via USB.

#### Information:

- It is possible to add, remove, or modify the slide-in drive at any time.
- In system units with 5 PCI slots, the slide-in USB FDD drive must be inserted in slide-in slot 1 for mechanical reasons.

#### Caution!

Turn off power before adding or removing a slide-in drive.



Figure 94: Slide-in USB FDD - 5AC600.FDDS-00

Technical data

**Information:**

The following characteristics, features, and limit values only apply to this individual component and can deviate from those specified for the entire device. For the entire device in which this individual component is used, refer to the data given specifically for the entire device.

Features	5AC600.FDDS-00
Data capacity	720 KB / 1.25 MB / 1.44 MB (formatted)
USB transfer rate	Full speed (12 Mbps)
Data transfer rate	250 kbits (720 KB) or 500 kbits (1.25 MB and 1.44 MB)
Rotation speed	Up to 360 rpm
Diskette media	High density (2HD) or normal density (2DD) 3.5" diskettes
MTBF	30,000 POH (Power-On Hours)
Environmental characteristics	
Ambient temperature <sup>1)</sup>	
Operation	4 to 50°C
Bearings	-20 to 60°C
Transport	-20 to 60°C
Relative humidity	
Operation	20 to 80%, non-condensing
Bearings	5 to 90%, non-condensing
Transport	5 to 90%, non-condensing
Vibration	
Operation	At max. 5 - 500 Hz and 0.3 g
Bearings	At max. 10 - 100 Hz and 2 g
Transport	At max. 10 - 100 Hz and 2 g
Shock (pulse with a sine half-wave)	
Operation	At max. 5 g for 11 ms
Bearings	At max. 60 g for 11 ms
Transport	At max. 60 g for 11 ms
Altitude	Max. 3000 meters

Table 98: Technical data - Slide-in USB diskette drive - 5AC600.FDDS-00

1) Temperature data is for operation at 500 meters. Derating the max. ambient temperature - typically 1°C per 1000 meters (from 500 meters above sea level).

Temperature humidity diagram

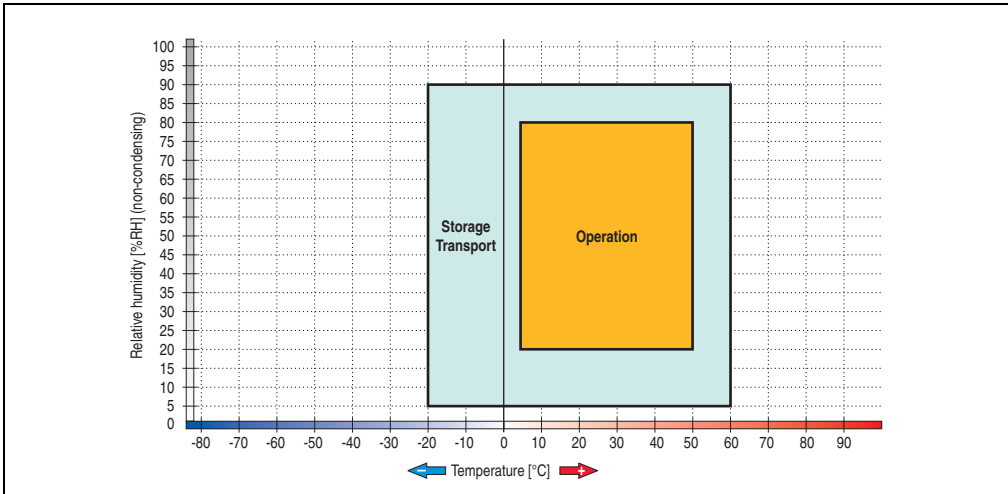

Figure 95: Temperature humidity diagram - Slide-in USB diskette drive 5AC600.FDDS-00



### 3.7.16 Slide-in hard disk 30 GB 24x7 - 5AC600.HDDS-00

This hard disk is specified for 24-hour operation (24x7). The slide-in drive can be used in system units with 2, 3 or 5 PCI slots. When inserted in slide-in slot 1 it is referred to internally as "secondary slave" and when in slide-in slot 2 as "secondary master."

#### Information:

It is possible to add or remove a slide-in drive at any time.

#### Caution!

Turn off power before adding or removing a slide-in drive.



Figure 96: Slide-in hard disk 30 GB - 5AC600.HDDS-00

#### Technical data

#### Information:

The following characteristics, features, and limit values only apply to this individual component and can deviate from those specified for the entire device. For the entire device in which this individual component is used, refer to the data given specifically for the entire device.

## Technical Data • Individual components

Features	5AC600.HDDS-00
Manufacturer's product ID	Fujitsu MHT2030AR
Formatted capacity	30 GB
Number of heads	2
Number of sectors (user)	58,605,120
Bytes per sector	512
Revolution speed	4200 rpm $\pm$ 1%
Access time (average)	7.14 ms
Positioning time (seek, typical values)	
Minimum (track to track)	1.5 ms
Average (read access)	12 ms
Maximum	22 ms
Starting time (0 rpm to read access)	5 seconds (typically)
Interface	ATA-6
Data transfer rate	
On the medium	26.1 to 36.2 MB/s
To/from host	Max. 100 MB/s (ultra-DMA mode 5)
Cache	2 MB
Noise level (idle mode)	Approx. 24 dBA at 30 cm
<b>Electrical characteristics</b>	
Lifespan	5 years or 20,000 POH (Power-On Hours)
MTBF	300,000 hours
<b>Mechanical characteristics</b>	
Slide-in mounting	Fixed
Outer dimensions (without slide-in)	
Width	70 mm
Length	100 mm
Height	9.5 mm
Weight	120 g
<b>Environmental characteristics</b>	
Ambient temperature <sup>1)</sup>	
Operation - standard <sup>2)</sup>	5 to 55°C
Operation - 24-hour <sup>3)</sup>	5 to 44°C
Bearings	-40 to 60°C
Transport	-40 to 60°C
Relative humidity	
Operation	8 to 90%, non-condensing
Bearings	5 to 95%, non-condensing
Transport	5 to 95%, non-condensing
Vibration	
Operation	No non-recovered errors at max. 5 - 500 Hz and 1 g (9.8 m/s <sup>2</sup> 0-peak)
Bearings	No damage at max. 5 - 500 Hz and 5 g (49 m/s <sup>2</sup> 0-peak)

Table 99: Technical data - Slide-in hard disk - 5AC600.HDDS-00

Environmental characteristics	5AC600.HDDS-00
Shock (pulse with a sine half-wave) Operation Bearings	No non-recovered errors at max. 225 g (2207 m/s <sup>2</sup> 0-peak) and 2 ms duration No damage at max. 900 g (8820 m/s <sup>2</sup> 0-peak) and 1 ms duration No damage at max. 120 g (1176 m/s <sup>2</sup> 0-peak) and 11 ms duration
Altitude Operation Bearings	- 300 to 3000 meters - 300 to 12000 meters

Table 99: Technical data - Slide-in hard disk - 5AC600.HDDS-00 (Forts.)

- 1) Temperature data is for operation at 500 meters. Derating the max. ambient temperature - typically 1°C per 1000 meters (from 500 meters above sea level).
- 2) Standard operation means 250 POH (power-on hours) per month.
- 3) 24-hour operation means 732 POH (power-on hours) per month.

### Temperature humidity diagram

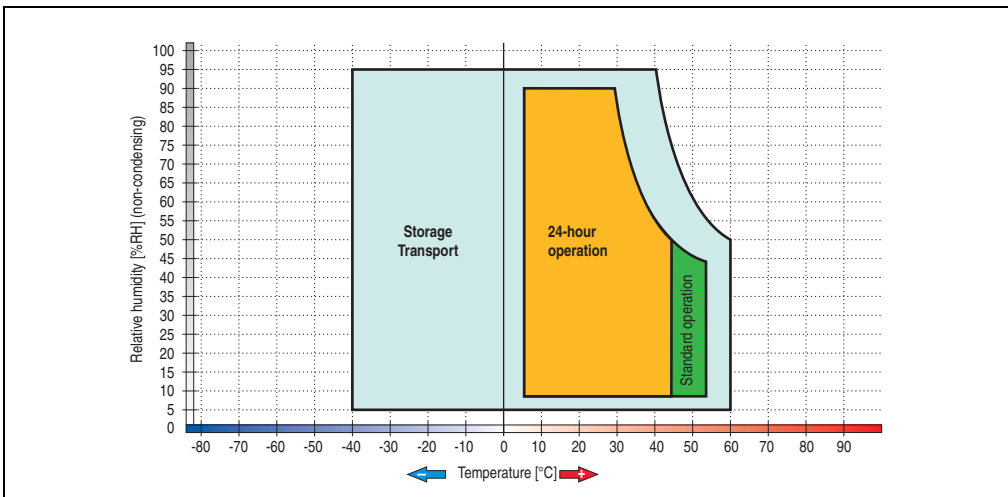

Figure 97: Temperature humidity diagram - Slide-in hard disk 5AC600.HDDS-00

### 3.7.17 Slide-in hard disk 20 GB ET - 5AC600.HDDS-01

This hard disk has an extended temperature specification (ET), but is not permitted for 24 hour operation. The slide-in drive can be used in system units with 2, 3 or 5 PCI slots. When inserted in slide-in slot 1 it is referred to internally as "secondary slave" and when in slide-in slot 2 as "secondary master."

#### Information:

It is possible to add or remove a slide-in drive at any time.

#### Caution!

Turn off power before adding or removing a slide-in drive.



Figure 98: Slide-in hard disk 20 GB - 5AC600.HDDS-01

#### Technical data

#### Information:

The following characteristics, features, and limit values only apply to this individual component and can deviate from those specified for the entire device. For the entire device in which this individual component is used, refer to the data given specifically for the entire device.

## Technical Data • Individual components

Features	5AC600.HDDS-01
Manufacturer's product ID	Fujitsu MHT2020AC
Formatted capacity	20 GB
Number of heads	2
Number of sectors (user)	39,070,080
Bytes per sector	512
Revolution speed	4200 rpm $\pm$ 1%
Access time (average)	7.14 ms
Positioning time (seek, typical values)	
Minimum (track to track)	1.5 ms
Average (read access)	12 ms
Maximum	22 ms
Starting time (0 rpm to read access)	5 seconds (typically)
Interface	ATA-6
Data transfer rate	
On the medium	Up to 28.9 MB/s
To/from host	Max. 100 MB/s (ultra-DMA mode 5)
Cache	2 MB
Noise level (idle mode)	Approx. 22 dBA at 30 cm
Electrical characteristics	
Lifespan	5 years or 20,000 POH (Power-On Hours)
MTBF	300,000 hours
Mechanical characteristics	
Slide-in mounting	Fixed
Outer dimensions (without slide-in)	
Width	70 mm
Length	100 mm
Height	9.5 mm
Weight	120 g
Environmental characteristics	
Ambient temperature <sup>1)</sup>	
Operation <sup>2)</sup>	-20 to +80°C
Bearings	-40 to +85°C
Transport	-40 to +85°C
Relative humidity	
Operation	8 to 90%, non-condensing
Bearings	5 to 95%, non-condensing
Transport	5 to 95%, non-condensing
Vibration	
Operation	No non-recovered errors at max. 5 - 500 Hz and 1 g (9.8 m/s <sup>2</sup> 0-peak)
Bearings	No damage at max. 5 - 500 Hz and 5 g (49 m/s <sup>2</sup> 0-peak)
Shock (pulse with a sine half-wave)	
Operation	No non-recovered errors at max. 225 g (2207 m/s <sup>2</sup> 0-peak) and 2 ms duration
Bearings	No damage at max. 900 g (8820 m/s <sup>2</sup> 0-peak) and 1 ms duration No damage at max. 120 g (1176 m/s <sup>2</sup> 0-peak) and 11 ms duration

Table 100: Technical data - Slide-in hard disk - 5AC600.HDDS-01

## Technical Data • Individual components

Features	5AC600.HDDS-01
Altitude	
Operation	- 300 to 3000 meters
Bearings	- 300 to 12000 meters

Table 100: Technical data - Slide-in hard disk - 5AC600.HDDS-01 (Forts.)

- 1) Temperature data is for operation at 500 meters. Derating the max. ambient temperature - typically 1°C per 1000 meters (from 500 meters above sea level).
- 2) Standard operation means 250 POH (power-on hours) per month.

### Temperature humidity diagram

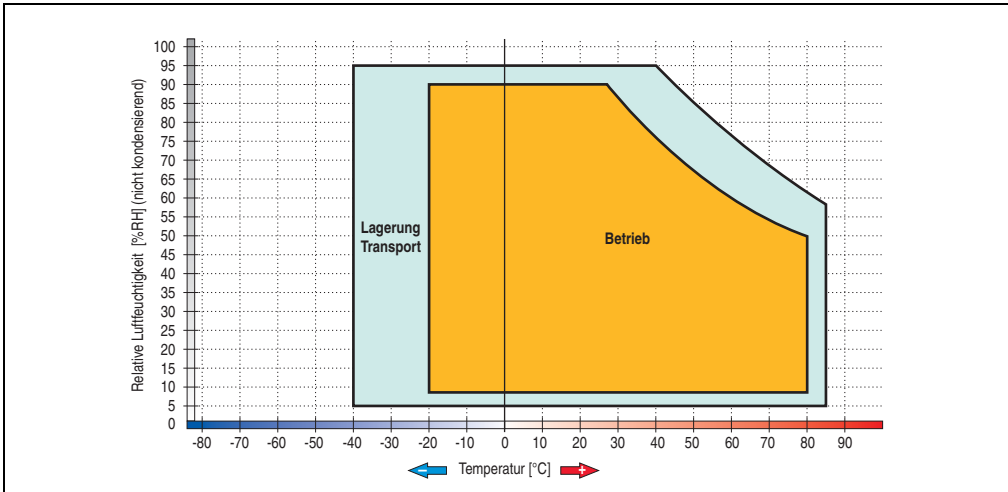

Figure 99: Temperature humidity diagram - Slide-in hard disk 5AC600.HDDS-01

### 3.7.18 Slide-in hard disk 40 GB ET - 5AC600.HDDS-02

This hard disk is specified for 24-hour operation (24x7) and also provides an extended temperature specification (ET). The slide-in drive can be used in system units with 2, 3 or 5 PCI slots. When inserted in slide-in slot 1 it is referred to internally as "secondary slave" and when in slide-in slot 2 as "secondary master."

#### **Information:**

It is possible to add or remove a slide-in drive at any time.

#### **Caution!**

Turn off power before adding or removing a slide-in drive.



Figure 100: Slide-in hard disk 40 GB - 5AC600.HDDS-02

## Technical data

**Information:**

The following characteristics, features, and limit values only apply to this individual component and can deviate from those specified for the entire device. For the entire device in which this individual component is used, refer to the data given specifically for the entire device.

Features	5AC600.HDDS-02 < Revision D0	5AC600.HDDS-02 Revision D0
Manufacturer's product ID	Seagate ST940813AM	Seagate ST940817AM
Formatted capacity	40 GB	
Number of heads	2	
Number of sectors (user)	78,140,160	
Bytes per sector	512	
Revolution speed	5400 rpm $\pm$ 1%	
Access time (average)	12.5 ms	
Positioning time (seek, typical values)		
Minimum (track to track)	1 ms	
Average (read access)	12.5 ms	
Maximum (read access)	22 ms	
Starting time (0 rpm to read access)	3 seconds (typically)	
Interface	ATA-6	
Data transfer rate		
On the medium	Max. 321 MBit/s	Max. 450 MBit/s
To/from host	Max. 100 MB/s (Ultra-DMA Mode 5)	Max. 100 MB/s (Ultra-DMA Mode 5)
Cache	8 MB	
S.M.A.R.T. Support	Yes	
MTBF	550,000 hours <sup>1)</sup>	750,000 hours <sup>1)</sup>
<b>Mechanical characteristics</b>		
Slide-in mounting	Fixed	
Outer dimensions (without slide-in)		
Width	70 mm	
Length	100 mm	
Height	9.5 mm	
Weight	100 g	
<b>Environmental characteristics</b>		
Ambient temperature <sup>2)</sup>		
Operation - Standard / 24-hour	-30 to 85°C	
Bearings	-40 to 95°C	
Transport	-40 to 95°C	

Table 101: Technical data - Slide-in hard disk - 5AC600.HDDS-02



Environmental characteristics	5AC600.HDDS-02 < Revision D0	5AC600.HDDS-02 Revision D0
Relative humidity Operation Bearings Transport	5 to 90%, non-condensing 5 to 95%, non-condensing 5 to 95%, non-condensing	
Vibration Operation Bearings	10 - 500 Hz: 1 g; no non-recovered errors 5 - 500 Hz: 5 g; no non-recovered errors	5 - 500 Hz: 2 g; no non-recovered errors 5 - 500 Hz: 5 g; no non-recovered errors
Shock (pulse with a sine half-wave) Operation Bearings	Max. 200 g, 2 ms; no non-recovered errors Max. 110 g, 11 ms; no non-recovered errors Max. 800 g, 2 ms; no damage Max. 400 g, 0.5 ms; no damage	Max. 300 g, 2 ms; no non-recovered errors Max. 150 g, 11 ms; no non-recovered errors Max. 800 g, 2 ms; no damage Max. 400 g, 0.5 ms; no damage
Altitude Operation Bearings	- 300 to 4419 meters - 300 to 12192 meters	- 300 to 5000 meters - 300 to 12192 meters

Table 101: Technical data - Slide-in hard disk - 5AC600.HDDS-02 (Forts.)

- 1) With 8760 POH (Power On Hours) per year and 70°C surface temperature.
- 2) Temperature values for 305 meter altitude. The temperature specification must be reduced linearly by 1°C every 305 meters. The temperature increase and decrease can be a maximum of 3°C per minute.

### Temperature humidity diagram

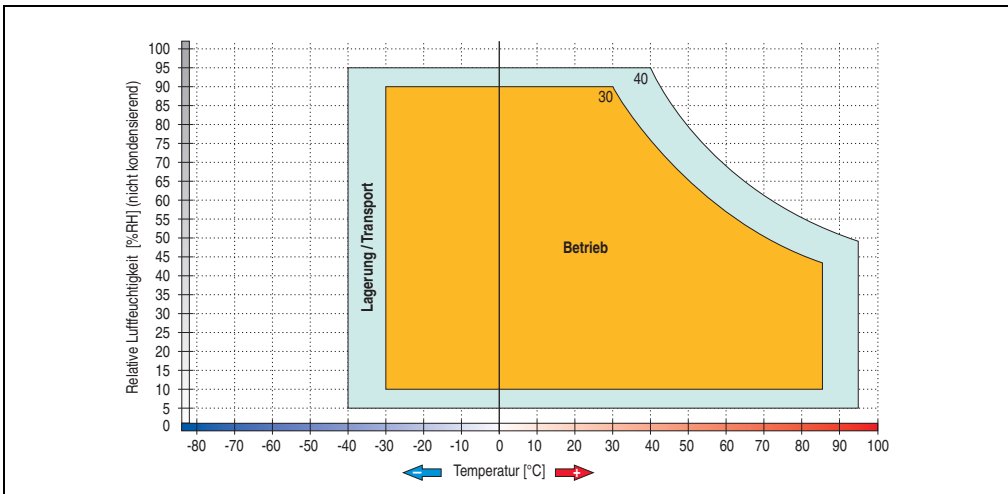

Figure 101: Temperature humidity diagram - Slide-in hard disk 5AC600.HDDS-02

Temperature values for 305 meter altitude. The temperature specification must be reduced linearly by 1°C every 305 meters. The temperature increase and decrease can be a maximum of 3°C per minute.

### 3.8 RAID system

Sometimes it is simply not possible to avoid using hard disks due to the amount of data that needs to be saved. In this case, a RAID provides high system availability. All data is simultaneously and automatically stored on two hard drives. This double data storage means that when one hard disk fails, the system will continue to run on the second hard disk.

Advantages for the user:

- No data loss when hard drive fails.
- The system continues to run with a hard disk.
- Data redundancy is automatically restored by the system when the faulty hard disk has been replaced.

Depending on the type, the RAID 1 system is designed in the form of 1 or 2 PCI cards.

**1 PCI slot:** PCI SATA RAID controller 5ACPCI.RAIC-01 (2x60GB) or 5ACPCI.RAIC-03 (2x160GB)

**2 PCI slot:** PCI RAID controller (5ACPCI.RAIC-00) and PCI card with two hard disks (5ACPCI.RAIS-00 or 5ACPCI.RAIS-01)

The system can be flexibly implemented in all APC620 und PPC700s with 1 free PCI slot (depending on the RAID system design). The system also supports RAID 0 applications. As a result, parallel access to two hard drives with a relatively high data throughput is the main focus, in addition to the high availability.

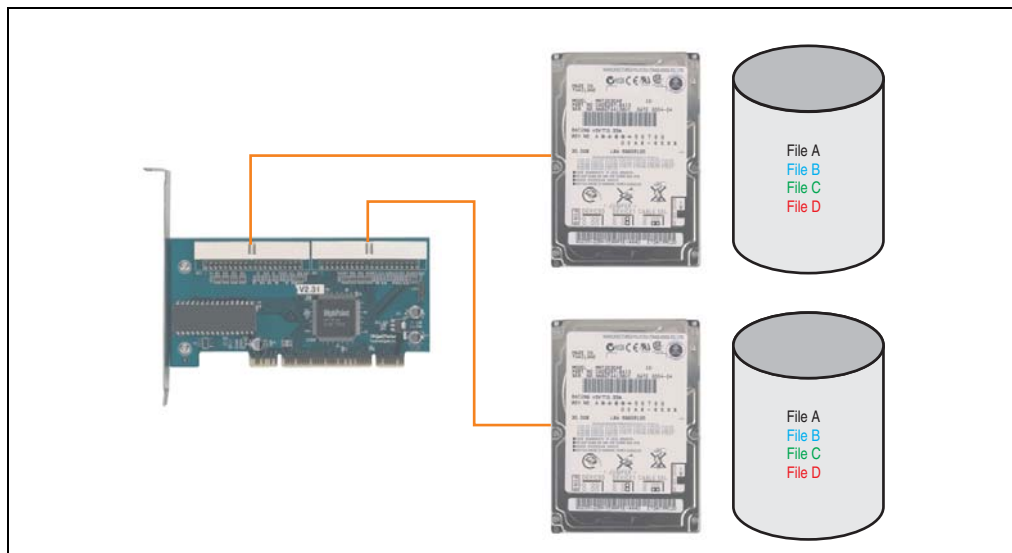

Figure 102: RAID 1 system schematic

### 3.8.1 PCI RAID Controller ATA/100 - 5ACPCI.RAIC-00

#### Information:

PCI RAID controllers are only available factory-installed. Therefore, this needs to be requested when placing the order.

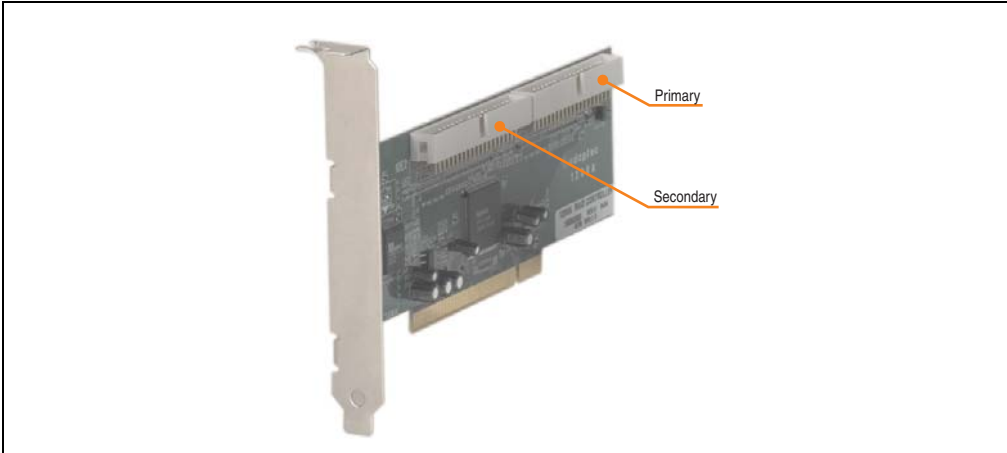

Figure 103: RAID controller - 5ACPCI.RAIC-00

#### Technical data

#### Information:

The following characteristics, features, and limit values only apply to this individual component and can deviate from those specified for the entire device. For the entire device in which this individual component is used, refer to the data given specifically for the entire device.

Features	5ACPCI.RAIC-00
Manufacturer's product ID	Adaptec ATA RAID 1200A
Data transfer rate	up to 100 MB/s per channel
RAID level	Supports RAID 0, 1, 0/1 and JBOD
Internal connections	Two 40-pin connections
Electrical characteristics	
Power consumption	0.15 A at 5 V (PCI bus)

Table 102: Technical data - RAID controller - 5ACPCI.RAIC-00

## Technical Data • Individual components

Mechanical characteristics	5ACPCI.RAIC-00
Outer dimensions	
Length	168 mm
Height	64 mm
Environmental characteristics	
Ambient temperature	
Operation	0 to 55°C
Bearings	-20 to 60°C
Transport	-20 to 60°C

Table 102: Technical data - RAID controller - 5ACPCI.RAIC-00 (Forts.)

### Driver support

Drivers for the approved operating systems can be downloaded from the download area on the B&R homepage ([www.br-automation.com](http://www.br-automation.com)).

### Information:

Required drivers can only be downloaded from the B&R homepage, not from manufacturers' pages.

### Contents of delivery

Amount	Component
1	Adaptec ATA RAID 1200A controller
2	ATA RAID connection cable (length 130 mm)

Table 103: Contents of delivery - 5ACPCI.RAIC-00

### 3.8.2 PCI RAID storage 2 x 40 GB 24x7 - 5ACPCI.RAIS-00

The hard disks that are used are specified for 24-hour operation (24x7).

#### Information:

PCI RAID storage drives are only available factory-installed. Therefore, this needs to be requested when placing the order.

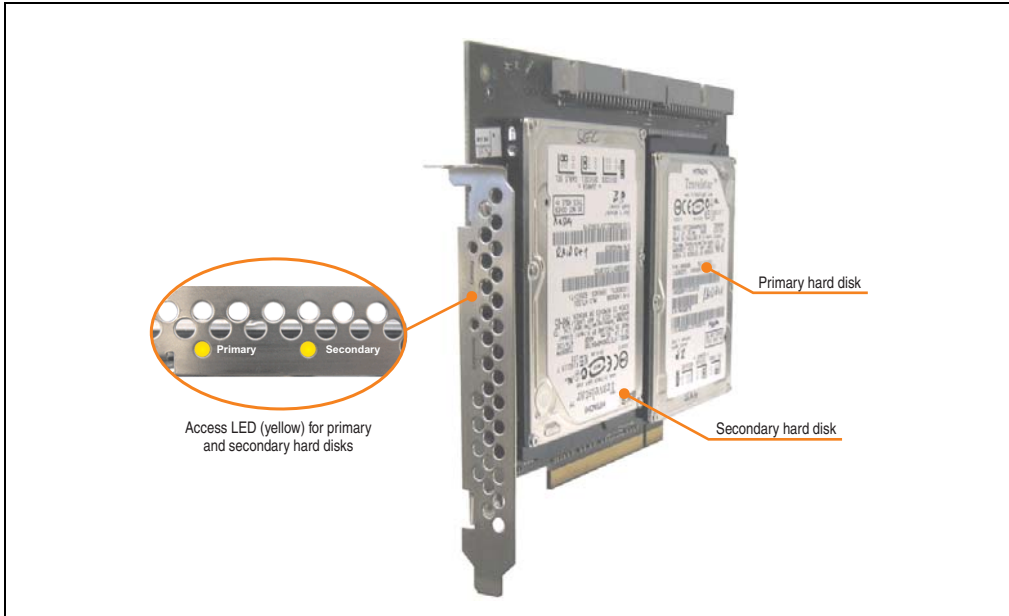

Figure 104: PCI RAID storage - 5ACPCI.RAIS-00

## Technical data

**Information:**

The following characteristics, features, and limit values only apply to this individual component and can deviate from those specified for the entire device. For the entire device in which this individual component is used, refer to the data given specifically for the entire device.

Features	5ACPCI.RAIS-00
Manufacturer's product ID	Hitachi Travelstar HTE726040M9AT00
Formatted capacity	40 GB
Number of heads	4
Number of sectors (user)	78,140,160
Bytes per sector	512
Revolution speed	7200 rpm $\pm$ 1%
Access time (average)	4.2 ms
Positioning time (seek, typical values)	
Minimum (track to track)	1 ms
Average (read access)	10 ms
Maximum (read access)	16 ms
Starting time (0 rpm to read access)	4 seconds (typically)
Interface	ATA-6
Data transfer rate	
On the medium	236 to 507 MBit/s
To/from host	Max. 100 MB/s (ultra-DMA mode 5)
Cache	8 MB
<b>Electrical characteristics</b>	
Lifespan	5 years or 30,000 POH (Power-On Hours)
MTBF	477,000 hours <sup>1)</sup>
<b>Mechanical characteristics</b>	
Mounted on PCI insert	Fixed
Outer dimensions (without PCI card)	
Width	70 mm
Length	100 mm
Height	9.5 mm
Weight	350 g
<b>Environmental characteristics</b>	
Ambient temperature <sup>2)</sup>	
Operation - standard <sup>3)</sup>	+5 to +55°C
Operation - 24-hour <sup>4)</sup>	+5 to +40°C
Bearings	-40 to +65°C
Transport	-40 to +65°C

Table 104: Technical data - RAID hard disk - 5ACPCI.RAIS-00

Environmental characteristics	5ACPCI.RAIS-00
Relative humidity Operation Bearings Transport	8 to 90%, non-condensing 5 to 95%, non-condensing 5 to 95%, non-condensing
Vibration Operation (continuous) Operation (occasional) Bearings Transport	No damage at max. 5 - 500 Hz and 0.125 g (1.225 m/s <sup>2</sup> 0-peak) duration 1 oct/min No damage at max. 5 - 500 Hz and 0.25 g (2.45 m/s <sup>2</sup> 0-peak) duration 1 oct/min No damage at max. 10 - 500 Hz and 5 g (49 m/s <sup>2</sup> 0-peak) duration 0.5 oct/min No damage at max. 10 - 500 Hz and 5 g (49 m/s <sup>2</sup> 0-peak) duration 0.5 oct/min
Shock (pulse with a sine half-wave) Operation  Bearings	No non-recovered errors at max. 80 g (784 m/s <sup>2</sup> 0-peak) and 1 ms duration No non-recovered errors at max. 150 g (1450 m/s <sup>2</sup> 0-peak) and 2 ms duration No non-recovered errors at max. 7 g (68 m/s <sup>2</sup> 0-peak) and 11 ms duration No damage at max. 500 g (4900 m/s <sup>2</sup> 0-peak) and 1 ms duration No damage at max. 60 g (588 m/s <sup>2</sup> 0-peak) and 11 ms duration
Altitude Operation Bearings	- 300 to 3048 meters - 300 to 12192 meters

Table 104: Technical data - RAID hard disk - 5ACPCI.RAIS-00 (Forts.)

- 1) Manufacturer specification at + 40°C ambient temperature.
- 2) Temperature data is for operation at 500 meters. Derating the max. ambient temperature - typically 1°C per 1000 meters (from 500 meters above sea level).
- 3) Standard operation means 333 POH (power-on hours) per month.
- 4) 24-hour operation means 732 POH (power-on hours) per month.

### Temperature humidity diagram

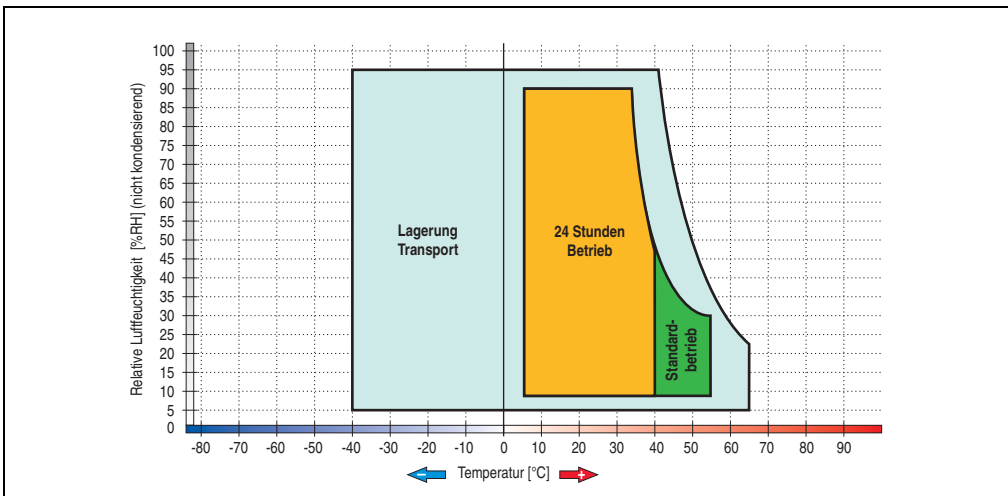

Figure 105: Temperature humidity diagram - RAID hard disk 5ACPCI.RAIS-00

### 3.8.3 PCI RAID storage 2 x 60 GB 24x7 - 5ACPCI.RAIS-01

The hard disks that are used are specified for 24-hour operation (24x7).

#### Information:

PCI RAID storage drives are only available factory-installed. Therefore, this needs to be requested when placing the order.

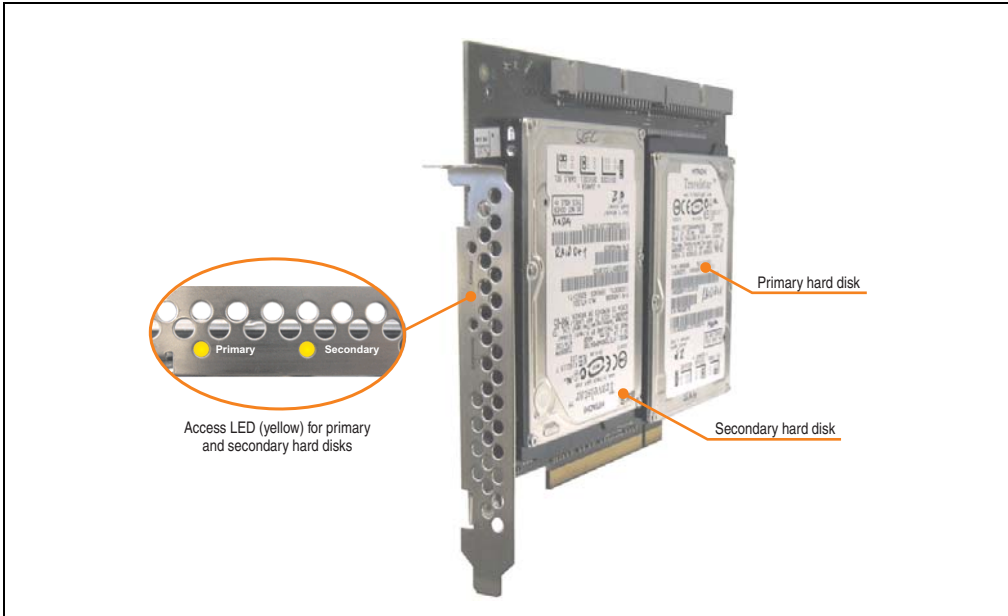

Figure 106: PCI RAID storage - 5ACPCI.RAIS-01



Technical data

**Information:**

The following characteristics, features, and limit values only apply to this individual component and can deviate from those specified for the entire device. For the entire device in which this individual component is used, refer to the data given specifically for the entire device.

Features	5ACPCI.RAIS-01
Manufacturer's product ID	Hitachi HTE721060G9AT00
Formatted capacity	60 GB
Number of heads	3
Number of sectors (user)	117,210,240
Bytes per sector	512
Revolution speed	7200 rpm ±1%
Access time (average)	10 ms
Positioning time (seek, typical values)	
Minimum (track to track)	1 ms
Average (read access)	10 ms
Maximum (read access)	16 ms
Starting time (0 rpm to read access)	4 seconds (typically)
Interface	ATA-6
Data transfer rate	
On the medium	267 to 629 MBit/s
To/from host	Max. 100 MB/s (ultra-DMA mode 5)
Cache	8 MB
<b>Electrical characteristics</b>	
Lifespan	5 years or 30,000 POH (Power-On Hours)
MTBF	550,000 hours <sup>1)</sup>
<b>Mechanical characteristics</b>	
Mounted on PCI insert	Fixed
Outer dimensions (without PCI card)	
Width	70 mm
Length	100 mm
Height	9.5 mm
Weight	120 g
<b>Environmental characteristics</b>	
Ambient temperature <sup>2)</sup>	
Operation - standard <sup>3)</sup>	5 to 55°C
Operation - 24-hour <sup>4)</sup>	5 to 40°C
Bearings	-40 to 65°C
Transport	-40 to 65°C

Table 105: Technical data - RAID hard disk - 5ACPCI.RAIS-01

## Technical Data • Individual components

Environmental characteristics	5ACPCI.RAIS-01
Relative humidity Operation Bearings Transport	8 to 90%, non-condensing 5 to 95%, non-condensing 5 to 95%, non-condensing
Vibration Operation (continuous) Operation (occasional) Bearings Transport	No damage at max. 5 - 500 Hz and 0.125 g (1.225 m/s <sup>2</sup> 0-peak) duration 1 oct/min No damage at max. 5 - 500 Hz and 0.25 g (2.45 m/s <sup>2</sup> 0-peak) duration 1 oct/min No damage at max. 10 - 500 Hz and 5 g (49 m/s <sup>2</sup> 0-peak) duration 0.5 oct/min No damage at max. 10 - 500 Hz and 5 g (49 m/s <sup>2</sup> 0-peak) duration 0.5 oct/min
Shock (pulse with a sine half-wave) Operation  Bearings	No non-recovered errors at max. 80 g (784 m/s <sup>2</sup> 0-peak) and 1 ms duration No non-recovered errors at max. 150 g (1450 m/s <sup>2</sup> 0-peak) and 2 ms duration No non-recovered errors at max. 7 g (68 m/s <sup>2</sup> 0-peak) and 11 ms duration No damage at max. 500 g (4900 m/s <sup>2</sup> 0-peak) and 1 ms duration No damage at max. 60 g (588 m/s <sup>2</sup> 0-peak) and 11 ms duration
Altitude Operation Bearings	- 300 to 3048 meters - 300 to 12192 meters

Table 105: Technical data - RAID hard disk - 5ACPCI.RAIS-01 (Forts.)

- 1) Manufacturer specification at + 40°C ambient temperature.
- 2) Temperature data is for operation at 500 meters. Derating the max. ambient temperature - typically 1°C per 1000 meters (from 500 meters above sea level).
- 3) Standard operation means 333 POH (power-on hours) per month.
- 4) 24-hour operation means 732 POH (power-on hours) per month.

### Temperature humidity diagram

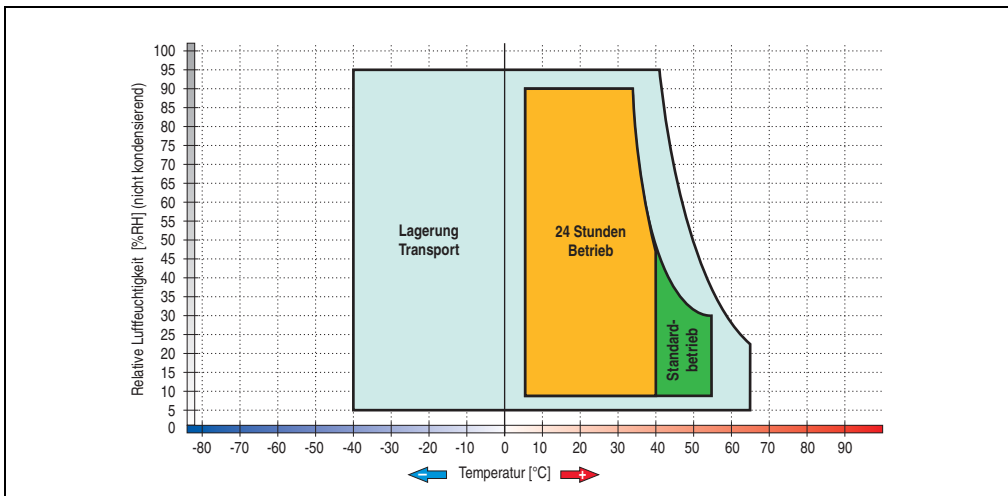

Figure 107: Temperature humidity diagram - RAID hard disk 5ACPCI.RAIS-01

### 3.8.4 PCI SATA RAID 2 x 60 GB 24x7 - 5ACPCI.RAIC-01

The hard disks that are used are specified for 24-hour operation (24x7).

#### Features

- SATA RAID controller
- RAID Level 0 (striped) and 1 (mirrored)
- 2 SATA hard disk drives (suitable for 24 hour operation)
- Only requires 1 PCI slot
- Transfer rates up to 150 MB/s

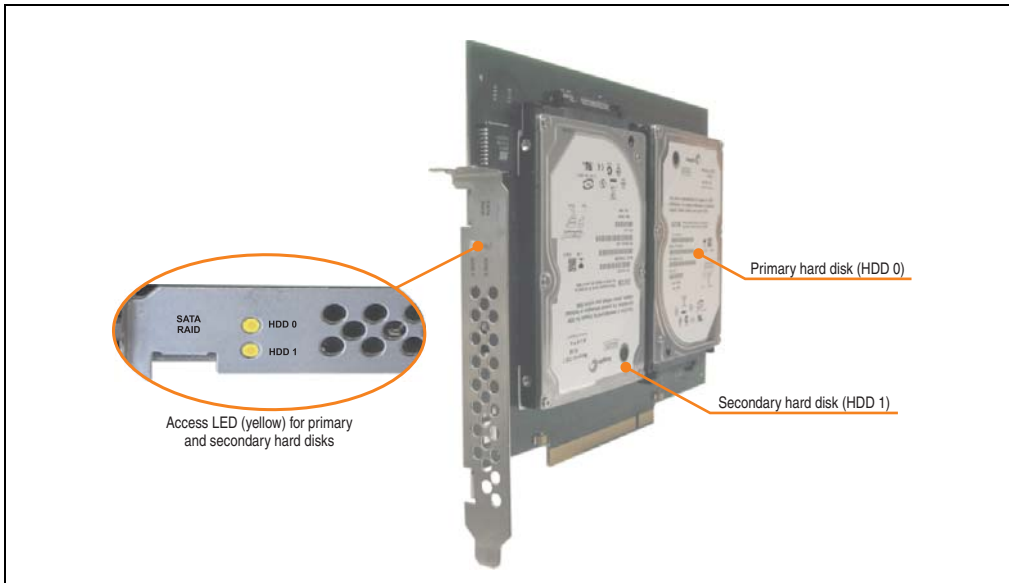

Figure 108: PCI SATA RAID controller - 5ACPCI.RAIC-01

#### Information:

The PCI SATA RAID controller can not be used in place of a Universal Power Supply (UPS). If the operating system is shut down improperly, the next time it is started it is detected as an error by the RAID 1, and a complete rebuild is executed. This generally takes at least 50 minutes (configurable) to complete.

Technical data

**Information:**

The following characteristics, features, and limit values only apply to this individual component and can deviate from those specified for the entire device. For the entire device in which this individual component is used, refer to the data given specifically for the entire device.

Features	5ACPCI.RAIC-01
SATA RAID controller Type Specifications Data transfer rate RAID level BIOS Extension ROM - requirements	Sil 3512 SATA link Serial ATA 1.0 Max. 1.5 GB/s (150 MB/s) Supports RAID 0, 1 ca. 32 KB
Hard disks Amount	Seagate Momentus 7200.1 ST96023AS 2
Formatted capacity (512 bytes/sector)	60 GB
Number of heads	3
Number of sectors (user)	117,210,240
Bytes per sector	512
Revolution speed	7200 rpm ±1%
Access time (average)	4.2 ms
Positioning time (seek, typical values) Minimum (track to track) Average (read access) Maximum (read access)	1.5 ms 10.5 ms 22 ms
Starting time (0 rpm to read access)	4 seconds (typically)
Supported transfer mode	SATA 1.0, PIO mode 0-4, multiword DMA mode 0-2, UDMA 0-5
Data transfer rate On the medium To/from host	max. 539 MBit/s Max. 150 MB/s
Cache	8 MB
S.M.A.R.T. Support	Yes
Lifespan	5 years
<b>Electrical characteristics</b>	
Power consumption	0.3 A at 3.3 V (PCI bus) 1 A at 5 V (PCI bus)
<b>Mechanical characteristics</b>	
Mounted on PCI insert	Fixed
Weight	350 g

Table 106: Technical data - RAID hard disk - 5ACPCI.RAIC-01

Environmental characteristics	5ACPCI.RAIC-01
Ambient temperature <sup>1)</sup> Operation - standard <sup>2)</sup> Operation - 24-hour <sup>3)</sup> Bearings Transport	5 to 55°C 5 to 40°C -40 to 70°C -40 to 70°C
Relative humidity Operation Bearings Transport	5 to 90%, non-condensing 5 to 95%, non-condensing 5 to 95%, non-condensing
Vibration <sup>4)</sup> Operation (continuous) Operation (occasional) Bearings Transport	No damage at max. 5 - 500 Hz and 0.125 g (1.225 m/s <sup>2</sup> 0-peak) duration 1 oct/min No damage at max. 5 - 500 Hz and 0.25 g (2.45 m/s <sup>2</sup> 0-peak) duration 1 oct/min No damage at max. 5 - 500 Hz and 5 g (49 m/s <sup>2</sup> 0-peak) duration 0.5 oct/min No damage at max. 5 - 500 Hz and 5 g (49 m/s <sup>2</sup> 0-peak) duration 0.5 oct/min
Shock <sup>4)</sup> (pulse with a sine half-wave) Operation Bearings	No non-recovered errors at max. 125 g (1226 m/s <sup>2</sup> 0-peak) and 2 ms duration No damage at max. 400 g (3924 m/s <sup>2</sup> 0-peak) and 2 ms duration No damage at max. 450 g (4424 m/s <sup>2</sup> 0-peak) and 1 ms duration No damage at max. 200 g (1962 m/s <sup>2</sup> 0-peak) and 0.5 ms duration
Altitude Operation Bearings	- 300 to 3048 meters - 300 to 12192 meters

Table 106: Technical data - RAID hard disk - 5ACPCI.RAIC-01 (Forts.)

- 1) Temperature values for 305 meter altitude. The temperature specification must be reduced linearly by 1°C every 305 meters. The temperature increase and decrease can be a maximum of 3°C per minute.
- 2) Standard operation means 333 POH (power-on hours) per month.
- 3) 24-hour operation means 732 POH (power-on hours) per month.
- 4) Operation in areas prone to vibration and shock can affect performance negatively (reduction of transfer rate).

### Temperature humidity diagram

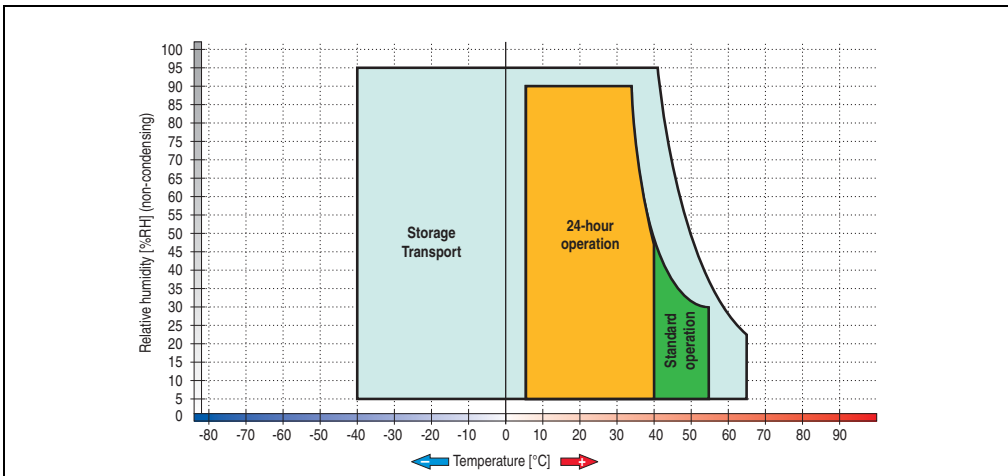

Figure 109: Temperature humidity diagram - SATA RAID hard disk 5ACPCI.RAIC-01

Temperature values for 305 meter altitude. The temperature specification must be reduced linearly by 1°C every 305 meters. The temperature increase and decrease can be a maximum of 3°C per minute.

### Driver support

Special drivers are necessary for operating the PCI SATA RAID controller. Drivers for Windows XP Professional, Windows XP Embedded and Windows Embedded Standard 2009 are available for download on the B&R Homepage in the download area ([www.br-automation.com](http://www.br-automation.com)).

The .NET-based SATARaid™ serial ATA RAID management software can also be found on the B&R homepage.

### Information:

**Required drivers can only be downloaded from the B&R homepage, not from manufacturers' pages.**

### Known limitations in a RAID 1 configuration

If one of the two hard disks is physically damaged, when the system is booted the SATA RAID BIOS displays the following error message for approx. 5 seconds: "RAID1 set is in critical status". After this time the operating system is automatically started on the functioning hard disk. The installed SATA Raid™ serial ATA RAID management software does not detect this error status. After repairing the cause of the error (e.g. replacing the hard disk) the SATARaid™ Serial ATA RAID management software automatically executes a rebuild (mirroring of the hard disk). This process takes approximately 50 minutes to complete, regardless of the amount of data and with the highest possible setting for "Rebuild rate".

A hard disk that becomes faulty during operation is detected by the SATA Raid™ Serial ATA RAID management software and indicated with an error message.

## Important notes / BIOS Extension ROM

For PCI cards with BIOS Extension ROM, there is a limited area of 64 KB available in the Phoenix BIOS. A B&R PCI SATA RAID controller requires a free area of approx. 32 KB. The remaining area can be used as desired.

If a PCI card requiring BIOS extension ROM is plugged into PCI slot 1 on an AP620 with 5 PCI slots (see figure 110 "PCI slot numbering on APC620 systems with 5 PCI slots") and the B&R PCI SATA RAID controller is plugged-in at a different position (e.g. PCI slot 4), then the BIOS menu item *Advanced - PCI/PnP Configuration - PCI Device, Slot #2* must be set from "Option ROM Scan" to "Disabled" so that this device can be used for booting. The BIOS default setting is to always attempt to load the BIOS Extension ROM from the PCI slot 1. Alternatively, the two PCI cards can be switched.

This setting does not have to be changed if a PCI card without BIOS extension ROM is plugged-in.

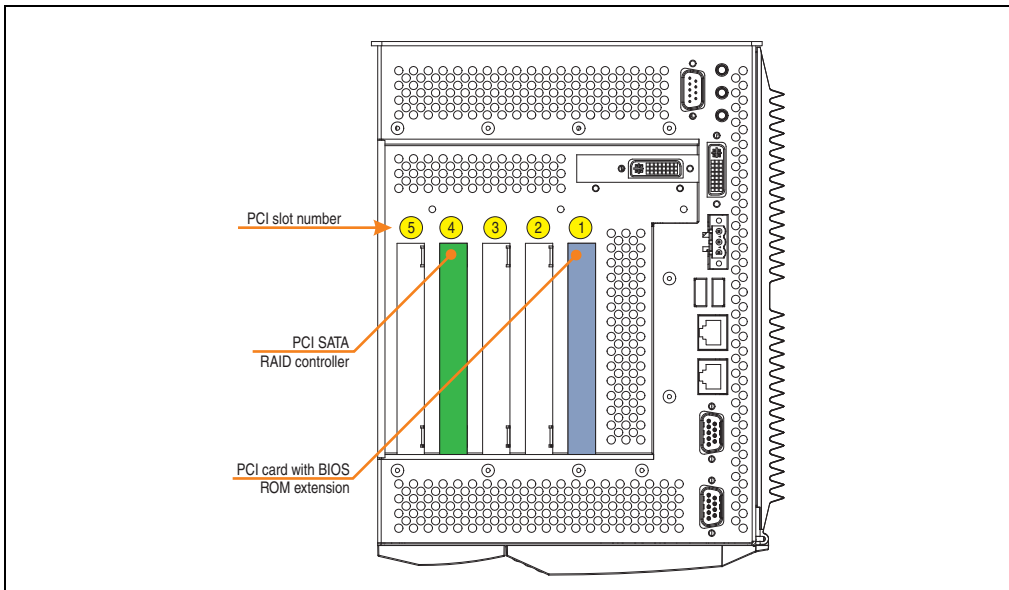

Figure 110: PCI slot numbering on APC620 systems with 5 PCI slots

## Configuration of a PCI SATA RAID array

Instructions for configuration of a PCI SATA RAID array using RAID BIOS can be found in chapter 3 "Commissioning", section "Configuration of a SATA RAID array", on page 351.

### 3.8.5 Replacement SATA HDD 60 GB - 5ACPCI.RAIC-02

The hard disk can be used as a replacement part for 5ACPCI.RAIC-01.



Figure 111: Replacement SATA HDD 60 GB - 5ACPCI.RAIC-02

#### Technical data

### Information:

The following characteristics, features, and limit values only apply to this individual component and can deviate from those specified for the entire device. For the entire device in which this individual component is used, refer to the data given specifically for the entire device.

Features	5ACPCI.RAIC-02
Hard disks Amount	Seagate Momentus 7200.1 ST96023AS 1
Formatted capacity (512 bytes/sector)	60 GB
Number of heads	3
Number of sectors (user)	117,210,240
Bytes per sector	512
Revolution speed	7200 rpm $\pm$ 1%
Access time (average)	4.2 ms
Positioning time (seek, typical values)	
Minimum (track to track)	1.5 ms
Average (read access)	10.5 ms
Maximum (read access)	22 ms
Starting time (0 rpm to read access)	4 seconds (typically)
Supported transfer mode	SATA 1.0, PIO mode 0-4, multiword DMA mode 0-2, UDMA 0-5
Data transfer rate	
On the medium	max. 539 MBit/s
To/from host	Max. 150 MB/s

Table 107: Technical data - RAID hard disk - 5ACPCI.RAIC-02



## Technical Data • Individual components

Features	5ACPCI.RAIC-02
Cache	8 MB
S.M.A.R.T. Support	Yes
Lifespan	5 years
Environmental characteristics	
Ambient temperature <sup>1)</sup> Operation - standard <sup>2)</sup> Operation - 24-hour <sup>3)</sup> Bearings Transport	5 to 55°C 5 to 40°C -40 to 70°C -40 to 70°C
Relative humidity Operation Bearings Transport	5 to 90%, non-condensing 5 to 95%, non-condensing 5 to 95%, non-condensing
Vibration <sup>4)</sup> Operation (continuous) Operation (occasional) Bearings Transport	No damage at max. 5 - 500 Hz and 0.125 g (1.225 m/s <sup>2</sup> 0-peak) duration 1 oct/min No damage at max. 5 - 500 Hz and 0.25 g (2.45 m/s <sup>2</sup> 0-peak) duration 1 oct/min No damage at max. 5 - 500 Hz and 5 g (49 m/s <sup>2</sup> 0-peak) duration 0.5 oct/min No damage at max. 5 - 500 Hz and 5 g (49 m/s <sup>2</sup> 0-peak) duration 0.5 oct/min
Shock <sup>4)</sup> (pulse with a sine half-wave) Operation Bearings	No non-recovered errors at max. 125 g (1226 m/s <sup>2</sup> 0-peak) and 2 ms duration No damage at max. 400 g (3924 m/s <sup>2</sup> 0-peak) and 2 ms duration No damage at max. 450 g (4424 m/s <sup>2</sup> 0-peak) and 1 ms duration No damage at max. 200 g (1962 m/s <sup>2</sup> 0-peak) and 0.5 ms duration
Altitude Operation Bearings	- 300 to 3048 meters - 300 to 12192 meters

Table 107: Technical data - RAID hard disk - 5ACPCI.RAIC-02 (Forts.)

- 1) Temperature values for 305 meter altitude. The temperature specification must be reduced linearly by 1°C every 305 meters. The temperature increase and decrease can be a maximum of 3°C per minute.
- 2) Standard operation means 333 POH (power-on hours) per month.
- 3) 24-hour operation means 732 POH (power-on hours) per month.
- 4) Operation in areas prone to vibration and shock can affect performance negatively (reduction of transfer rate).

Temperature humidity diagram

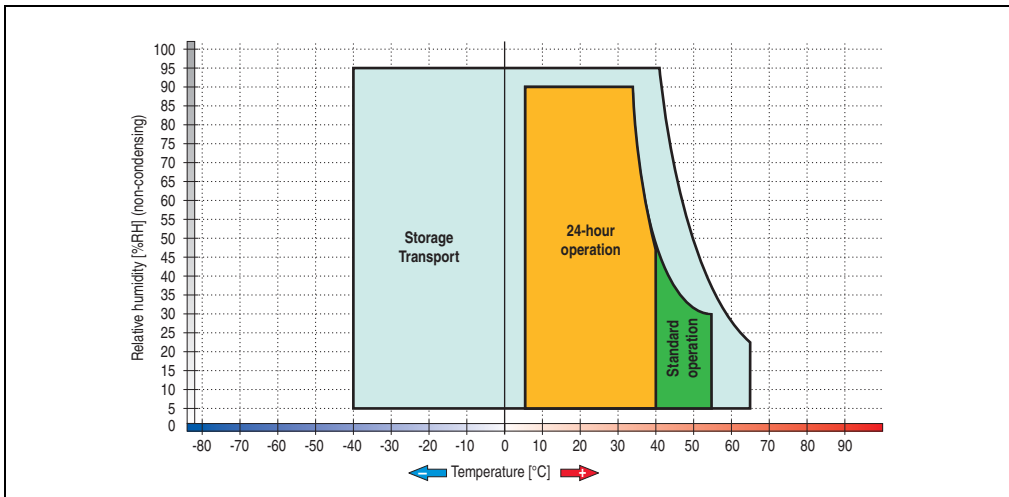

Figure 112: Temperature humidity diagram - SATA RAID hard disk 5ACPCI.RAIC-02

Exchanging a PCI SATA RAID hard disk

Instructions for exchanging a SATA hard disk can be found in chapter 7 "Maintenance / Servicing", section "Exchanging a PCI SATA RAID hard disk", on page 785.

### 3.8.6 PCI SATA RAID 2 x 160 GB 24x7 ET - 5ACPCI.RAIC-03

The hard disks being used are specified for 24-hour operation (24x7) and also provides an extended temperature specification (ET).

#### Features

- SATA RAID controller
- RAID Level 0 (striped) and 1 (mirrored)
- 2 SATA hard disk drives (suitable for 24 hour operation)
- Only requires 1 PCI slot
- Transfer rates up to 150 MB/s

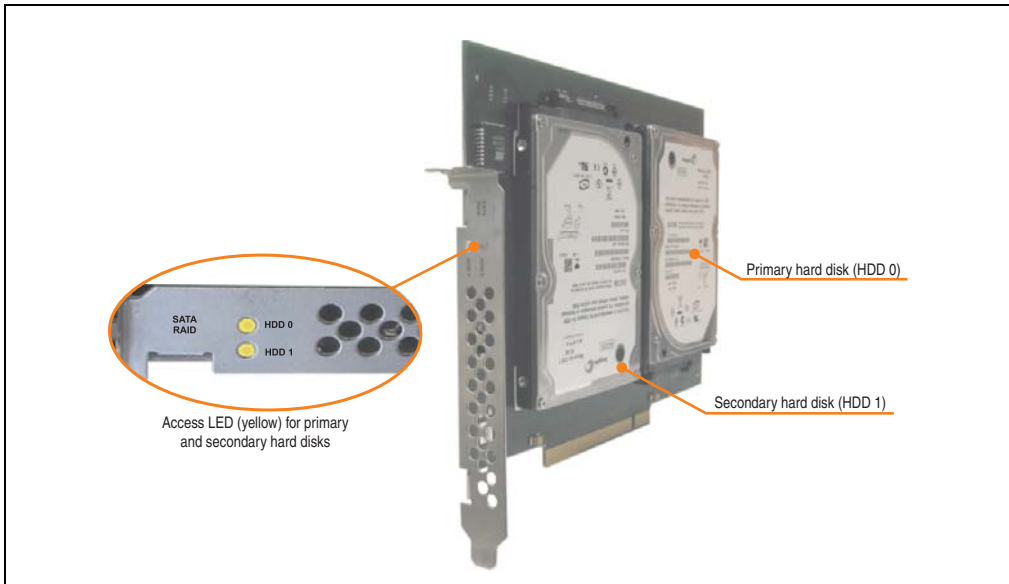

Figure 113: PCI SATA RAID controller - 5ACPCI.RAIC-03

#### Information:

The PCI SATA RAID controller can not be used in place of a Universal Power Supply (UPS). If the operating system is shut down improperly, the next time it is started it is detected as an error by the RAID 1, and a complete rebuild is executed. This generally takes at least 50 minutes (configurable) to complete.

Technical data

**Information:**

The following characteristics, features, and limit values only apply to this individual component and can deviate from those specified for the entire device. For the entire device in which this individual component is used, refer to the data given specifically for the entire device.

Features	5ACPCI.RAIC-03
SATA RAID controller Type Specifications Data transfer rate RAID level BIOS Extension ROM - requirements	Sil 3512 SATA link Serial ATA 1.0 Max. 1.5 GB/s (150 MB/s) Supports RAID 0, 1 Approx. 32 KB
Hard disks Amount	Fujitsu M120-ESW MHY2160BH-ESW 2
Formatted capacity (512 bytes/sector)	160 GB
Number of heads	3
Number of sectors (user)	312,581,808
Bytes per sector	512
Revolution speed	5400 rpm ±1%
Access time (average)	5.56 ms
Positioning time (seek, typical values) Minimum (track to track) Average (read access) Maximum (read access)	1.5 ms 12 ms 22 ms
Starting time (0 rpm to read access)	4 seconds (typically)
Supported transfer mode	SATA 1.0, PIO mode 0-4, multiword DMA mode 0-2, UDMA 0-5
Data transfer rate On the medium To/from host	Max. 84.6 MBit/s Max. 150 MB/s
Cache	8 MB
S.M.A.R.T. Support	Yes
Lifespan	5 years
<b>Electrical characteristics</b>	
Power consumption	0.3 A at 3.3 V (PCI bus) 1 A at 5 V (PCI bus)
<b>Mechanical characteristics</b>	
Mounted on PCI insert	Fixed
Weight	350 g

Table 108: Technical data - RAID hard disk - 5ACPCI.RAIC-03

Environmental characteristics	5ACPCI.RAIC-03
Ambient temperature <sup>1)</sup> Operation - Standard / 24-hour <sup>2)</sup> Bearings Transport	-15 to 80°C -40 to 95°C -40 to 95°C
Relative humidity Operation Bearings Transport	8 to 90% non-condensing (maximum humidity at +29°C) 5 to 95% non-condensing (maximum humidity at +40°C) 5 to 95% non-condensing (maximum humidity at +40°C)
Vibration <sup>3)</sup> Operation (continuous) Operation (occasional) Bearings Transport	5 - 500 Hz: max. 0.125 g; duration 1 octave per minute; no unrecoverable errors 5 - 500 Hz: max. 0.25 g; duration 1 octave per minute; no unrecoverable errors 5 - 500 Hz: max. 5 g; duration 0.5 octaves per minute; no damage 5 - 500 Hz: max. 5 g; duration 0.5 octaves per minute; no damage
Shock <sup>4)</sup> (pulse with a sine half-wave) Operation Bearings	Max. 125 g, 2 ms; no unrecoverable errors Max. 400 g, 2 ms; no damage Max. 450 g, 1 ms; no damage Max. 200 g, 0.5 ms; no damage
Altitude Operation Bearings	- 300 to 3048 meters - 300 to 12192 meters

Table 108: Technical data - RAID hard disk - 5ACPCI.RAIC-03 (Forts.)

- 1) Temperature values for 305 meter altitude. The temperature specification must be reduced linearly by 1°C every 305 meters. The temperature increase and decrease can be a maximum of 3°C per minute.
- 2) 24-hour operation means 732 POH (power-on hours) per month.
- 3) Operation in areas prone to vibration and shock can affect performance negatively (reduction of transfer rate).

### Temperature humidity diagram

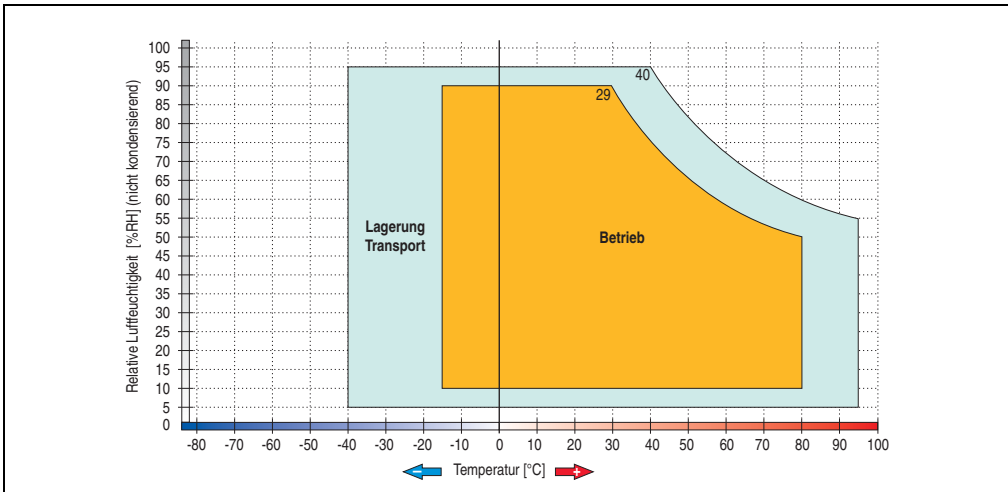

Figure 114: Temperature humidity diagram - SATA RAID hard disk 5ACPCI.RAIC-03

Temperature values for 305 meter altitude. The temperature specification must be reduced linearly by 1°C every 305 meters. The temperature increase and decrease can be a maximum of 3°C per minute.

### Driver support

Special drivers are necessary for operating the PCI SATA RAID controller. Drivers for Windows XP Professional, Windows XP Embedded and Windows Embedded Standard 2009 are available for download on the B&R Homepage in the download area ([www.br-automation.com](http://www.br-automation.com)).

The .NET-based SATARaid™ serial ATA RAID management software can also be found on the B&R homepage.

### Information:

**Required drivers can only be downloaded from the B&R homepage, not from manufacturers' pages.**

### Known limitations in a RAID 1 configuration

If one of the two hard disks is physically damaged, when the system is booted the SATA RAID BIOS displays the following error message for approx. 5 seconds: "RAID1 set is in critical status". After this time the operating system is automatically started on the functioning hard disk. The installed SATA Raid™ serial ATA RAID management software does not detect this error status. After repairing the cause of the error (e.g. replacing the hard disk) the SATARaid™ Serial ATA RAID management software automatically executes a rebuild (mirroring of the hard disk). This process takes approximately 50 minutes to complete, regardless of the amount of data and with the highest possible setting for "Rebuild rate".

A hard disk that becomes faulty during operation is detected by the SATA Raid™ Serial ATA RAID management software and indicated with an error message.

## Important notes / BIOS Extension ROM

For PCI cards with BIOS Extension ROM, there is a limited area of 64 KB available in the Phoenix BIOS. A B&R PCI SATA RAID controller requires a free area of approx. 32 KB. The remaining area can be used as desired.

If a PCI card requiring BIOS extension ROM is plugged into PCI slot 1 on an AP620 with 5 PCI slots (see figure 110 "PCI slot numbering on APC620 systems with 5 PCI slots") and the B&R PCI SATA RAID controller is plugged-in at a different position (e.g. PCI slot 4), then the BIOS menu item *Advanced - PCI/PnP Configuration - PCI Device, Slot #2* must be set from "Option ROM Scan" to "Disabled" so that this device can be used for booting. The BIOS default setting is to always attempt to load the BIOS Extension ROM from the PCI slot 1. Alternatively, the two PCI cards can be switched.

This setting does not have to be changed if a PCI card without BIOS extension ROM is plugged-in.

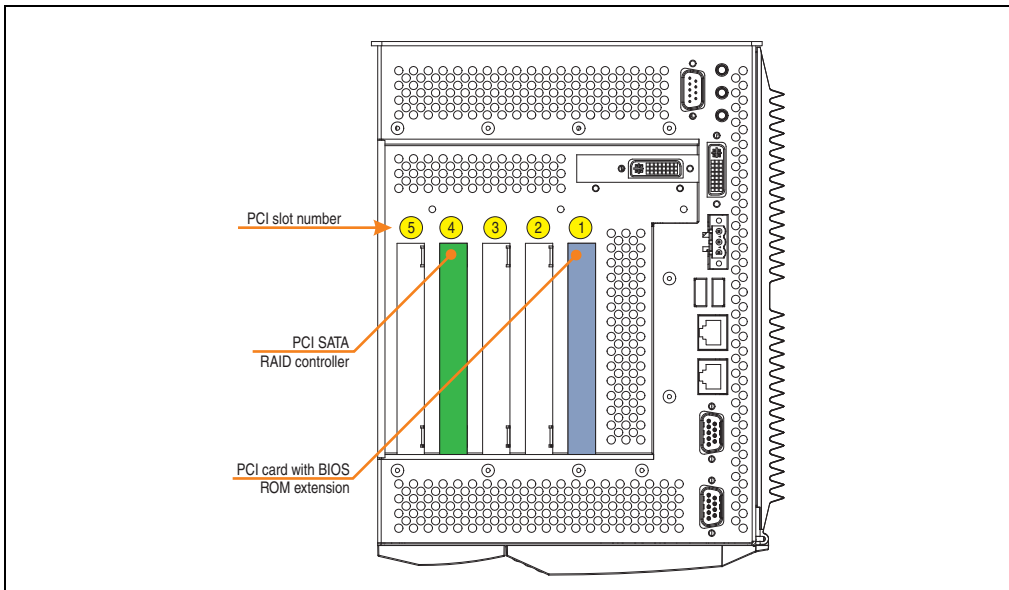

Figure 115: PCI slot numbering on APC620 systems with 5 PCI slots

## Configuration of a PCI SATA RAID array

Instructions for configuration of a PCI SATA RAID array using RAID BIOS can be found in chapter 3 "Commissioning", section "Configuration of a SATA RAID array", on page 351.

### 3.8.7 Replacement SATA HDD 160 GB - 5ACPCI.RAIC-04

The hard disk can be used as a replacement part for 5ACPCI.RAIC-03.



Figure 116: Replacement SATA HDD 160 GB - 5ACPCI.RAIC-04

#### Technical data

### Information:

The following characteristics, features, and limit values only apply to this individual component and can deviate from those specified for the entire device. For the entire device in which this individual component is used, refer to the data given specifically for the entire device.

Features	5ACPCI.RAIC-04
Hard disks Amount	Fujitsu M120-ESW MHY2160BH-ESW 1
Formatted capacity (512 bytes/sector)	160 GB
Number of heads	3
Number of sectors (user)	312,581,808
Bytes per sector	512
Revolution speed	5400 rpm $\pm$ 1%
Access time (average)	5.56 ms
Positioning time (seek, typical values)	
Minimum (track to track)	1.5 ms
Average (read access)	12 ms
Maximum (read access)	22 ms
Starting time (0 rpm to read access)	4 seconds (typically)
Supported transfer mode	SATA 1.0, PIO mode 0-4, multiword DMA mode 0-2, UDMA 0-5
Data transfer rate	
On the medium	Max. 84.6 MBit/s
To/from host	Max. 150 MB/s

Table 109: Technical data - RAID hard disk - 5ACPCI.RAIC-04



## Technical Data • Individual components

Features	5ACPCI.RAIC-04
Cache	8 MB
S.M.A.R.T. Support	Yes
Lifespan	5 years
Environmental characteristics	
Ambient temperature <sup>1)</sup> Operation - Standard / 24-hour <sup>2)</sup> Bearings Transport	-15 to 80°C -40 to 95°C -40 to 95°C
Relative humidity Operation Bearings Transport	8 to 90% non-condensing (maximum humidity at 29°C) 5 to 95% non-condensing (maximum humidity at 40°C) 5 to 95% non-condensing (maximum humidity at 40°C)
Vibration <sup>3)</sup> Operation (continuous) Operation (occasional) Bearings Transport	5 - 500 Hz: max. 0.125 g; duration 1 octave per minute; no unrecoverable errors 5 - 500 Hz: max. 0.25 g; duration 1 octave per minute; no unrecoverable errors 5 - 500 Hz: max. 5 g; duration 0.5 octaves per minute; no damage 5 - 500 Hz: max. 5 g; duration 0.5 octaves per minute; no damage
Shock <sup>4)</sup> (pulse with a sine half-wave) Operation Bearings	Max. 125 g, 2 ms; no unrecoverable errors Max. 400 g, 2 ms; no damage Max. 450 g, 1 ms; no damage Max. 200 g, 0.5 ms; no damage
Altitude Operation Bearings	- 300 to 3048 meters - 300 to 12192 meters

Table 109: Technical data - RAID hard disk - 5ACPCI.RAIC-04 (Forts.)

- 1) Temperature values for 305 meter altitude. The temperature specification must be reduced linearly by 1°C every 305 meters. The temperature increase and decrease can be a maximum of 3°C per minute.
- 2) 24-hour operation means 732 POH (power-on hours) per month.
- 3) Operation in areas prone to vibration and shock can affect performance negatively (reduction of transfer rate).

## Temperature humidity diagram

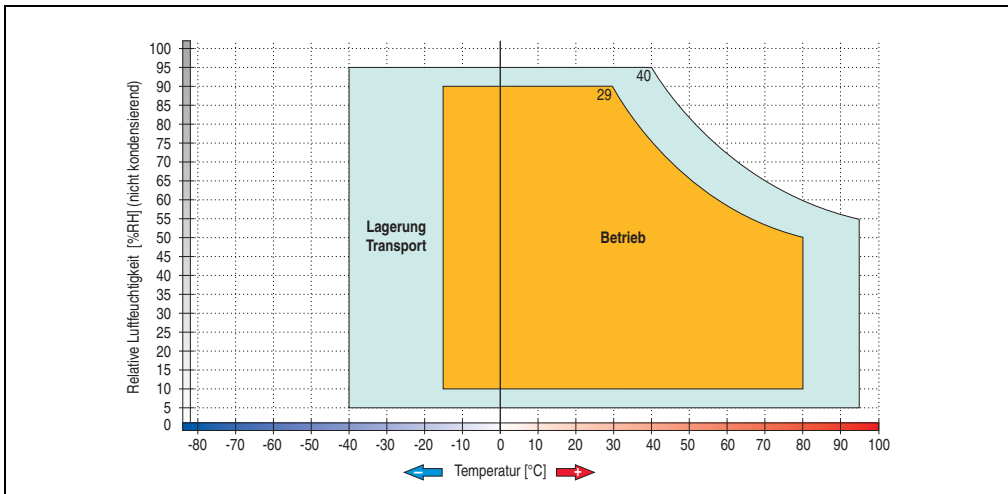

Figure 117: Temperature humidity diagram - SATA RAID hard disk 5ACPCI.RAIC-04

## Exchanging a PCI SATA RAID hard disk

Instructions for exchanging a SATA hard disk can be found in chapter 7 "Maintenance / Servicing", section "Exchanging a PCI SATA RAID hard disk", on page 785.

### 3.8.8 PCI SATA RAID 2 x 250 GB - 5ACPCI.RAIC-05

The hard disks that are used are specified for 24-hour operation (24x7).

#### Features

- SATA RAID controller
- RAID Level 0 (striped) and 1 (mirrored)
- 2 SATA hard disk drives (suitable for 24 hour operation)
- Only requires 1 PCI slot
- Transfer rates up to 150 MB/s

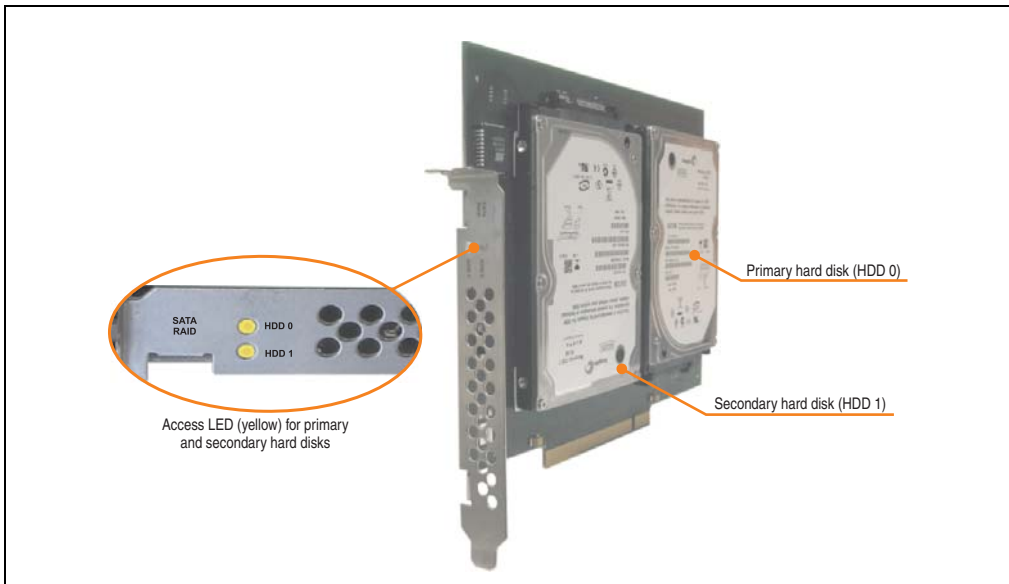

Figure 118: PCI SATA RAID controller - 5ACPCI.RAIC-05

#### Information:

The PCI SATA RAID controller can not be used in place of a Universal Power Supply (UPS). If the operating system is shut down improperly, the next time it is started it is detected as an error by the RAID 1, and a complete rebuild is executed. This generally takes at least 120 minutes (configurable) to complete.

Technical data

**Information:**

The following characteristics, features, and limit values only apply to this individual component and can deviate from those specified for the entire device. For the entire device in which this individual component is used, refer to the data given specifically for the entire device.

Features	5ACPCI.RAIC-05
SATA RAID controller Type Specifications Data transfer rate RAID level BIOS Extension ROM - requirements	Sil 3512 SATA link Serial ATA 1.0 Max. 1.5 GB/s (150 MB/s) Supports RAID 0, 1 Approx. 32 KB
Hard disks Amount	Seagate ST9250315AS 2
Formatted capacity (512 bytes/sector)	250 GB
Number of heads	1
Number of sectors (user)	488,397,168
Bytes per sector	512
Revolution speed	5400 rpm ±0.2%
Access time (average)	5.56 ms
Positioning time (seek, typical values) Minimum (track to track) Average (read access) Maximum (read access)	1 ms 14 ms 30 ms
Starting time (0 rpm to read access)	3.6 seconds (typically)
Supported transfer modes	SATA 1.0, Serial ATA Revision 2.6 PIO mode 0-4, multiword DMA mode 0-2, UDMA mode 0-6
Data transfer rate On the medium To/from host	Max. 1175 Mbits/s Max. 150 MB/s
Cache	8 MB
S.M.A.R.T. Support	Yes
<b>Electrical characteristics</b>	
Power consumption	0.3 A at 3.3 V (PCI bus) 1 A at 5 V (PCI bus)
<b>Mechanical characteristics</b>	
Mounted on PCI insert	Fixed
Weight	350 g

Table 110: Technical data - RAID Hard Disk - 5ACPCI.RAIC-05

Environmental characteristics	5ACPCI.RAIC-05
Ambient temperature <sup>1)</sup> Operation - Standard / 24-hour <sup>2)</sup> Storage Transport	0 to 60°C -40 to 70°C -40 to 70°C
Relative humidity <sup>3)</sup> Operation Storage Transport	5 to 95%, non-condensing 5 to 95%, non-condensing 5 to 95%, non-condensing
Vibration <sup>4)</sup> Operation (continuous) Operation (occasional) Storage Transport	5 - 500 Hz: max. 0.125 g; duration 1 octave per minute; no unrecoverable errors 5 - 500 Hz: max. 0.25 g; duration 1 octave per minute; no unrecoverable errors 5 - 500 Hz: max. 5 g; duration 0.5 octaves per minute; no damage 5 - 500 Hz: max. 5 g; duration 0.5 octaves per minute; no damage
Shock <sup>4)</sup> (pulse with a sine half-wave) Operation Storage	Max. 125 g, 2 ms; no unrecoverable errors Max. 400 g, 2 ms; no damage Max. 500 g, 1 ms; no damage Max. 300 g, 0.5 ms; no damage
Altitude Operation Storage	- 300 to 3048 m - 300 to 12,192 m

Table 110: Technical data - RAID Hard Disk - 5ACPCI.RAIC-05 (Forts.)

- 1) Temperature values for 305 meter altitude. The temperature specification must be reduced linearly by 1°C every 305 meters. The temperature increase and decrease can be a maximum of 20°C per hour.
- 2) 24-hour operation means 732 POH (power-on hours) per month.
- 3) Humidity gradient: Maximum 30% per hour.
- 4) Operation in areas prone to vibration and shock can affect performance negatively (reduction of transfer rate).

### Temperature humidity diagram

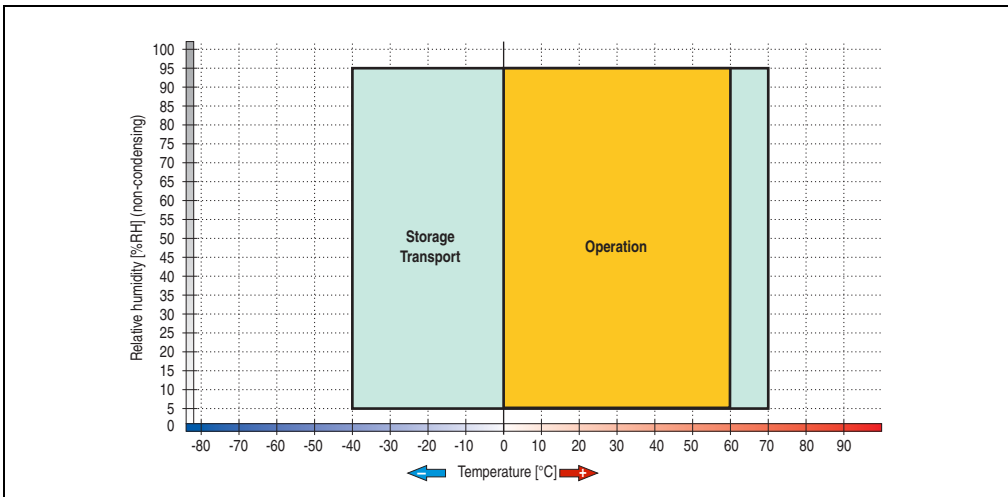

Figure 119: Temperature humidity diagram - SATA RAID Hard Disk - 5ACPCI.RAIC-05

Temperature values for 305 meter altitude. The temperature specification must be reduced linearly by 1°C every 305 meters. The temperature increase and decrease can be a maximum of 20°C per hour.

### Driver support

Special drivers are necessary for operating the PCI SATA RAID controller. Drivers for Windows XP Professional and Windows XP Embedded are available for download on the B&R Homepage in the download area ([www.br-automation.com](http://www.br-automation.com)).

The .NET-based SATARaid™ serial ATA RAID management software can also be found on the B&R homepage.

## Information:

**Required drivers can only be downloaded from the B&R homepage, not from manufacturers' pages.**

### Configuration

For configuration of a SATA RAID network, see Chapter 3 "Commissioning", section "Configuration of a SATA RAID array", on page 351.

### Exchanging a HDD

A hard drive can be easily exchanged in the event of an error when using the RAID1 (mirroring) configuration without having to re-install the system. The replacement SATA HDD 250GB 5MMHDD.0250-00 is available as a replacement part for a HDD.

For instructions on exchanging the drive, see Chapter 7 "Maintenance / Servicing", section "Mounting the side cover", on page 781.

### 3.8.9 Replacement SATA HDD 250 GB - 5MMHDD.0250-00

The hard disk can be used as a replacement part for 5ACPCI.RAIC-05.



Figure 120: Replacement SATA HDD 250 GB - 5MMHDD.0250-00

#### Technical data

### Information:

The following characteristics, features, and limit values only apply to this individual component and can deviate from those specified for the entire device. For the entire device in which this individual component is used, refer to the data given specifically for the entire device.

Features	5MMHDD.0250-00
Hard disks Amount	Seagate ST9250315AS 1
Formatted capacity (512 bytes/sector)	250 GB
Number of heads	1
Number of sectors (user)	488,397,168
Bytes per sector	512
Revolution speed	5400 rpm $\pm$ 0.2%
Access time (average)	5.56 ms
Positioning time (seek, typical values) Minimum (track to track) Average (read access) Maximum (read access)	1 ms 14 ms 30 ms
Starting time (0 rpm to read access)	3.6 seconds (typically)
Supported transfer modes	SATA 1.0, Serial ATA Revision 2.6 PIO mode 0-4, multiword DMA mode 0-2, UDMA mode 0-6
Interface	SATA

Table 111: Technical data - RAID hard disk - 5MMHDD.0250-00

## Technical Data • Individual components

Features	5MMHDD.0250-00
Data transfer rate On the medium To/from host	Max. 1175 Mbits/s Max. 150 MB/s (SATA I), max. 300 MB/s (SATA II)
Cache	8 MB
S.M.A.R.T. Support	Yes
MTBF	550,000 Power On Hours <sup>1)</sup>
Environmental characteristics	
Ambient temperature <sup>2)</sup> Operation - Standard / 24-hour <sup>3)</sup> Storage Transport	0 to 60°C -40 to 70°C -40 to 70°C
Relative humidity <sup>4)</sup> Operation Storage Transport	5 to 95%, non-condensing 5 to 95%, non-condensing 5 to 95%, non-condensing
Vibration Operation Storage	0.5 g at 5 - 500 Hz, no non-recovered errors 5 g at 5 - 500 Hz, no non-recovered errors
Shock (pulse with a sine half-wave) Operation Storage	350 g and 2 ms duration, no non-recovered errors 800 g and 2 ms duration, no non-recovered errors 1000 g and 1 ms duration, no non-recovered errors 600 g and 0.5 ms duration, no non-recovered errors
Altitude Operation Storage	- 300 to 3048 m - 300 to 12,192 m

Table 111: Technical data - RAID hard disk - 5MMHDD.0250-00 (Forts.)

- 1) With 8760 POH (Power On Hours) per year and 25°C surface temperature.
- 2) Temperature values for 305 meter altitude. The temperature specification must be reduced linearly by 1°C every 305 meters. The temperature increase and decrease can be a maximum of 20°C per hour.
- 3) 24-hour operation means 732 POH (power-on hours) per month.
- 4) Humidity gradient: Maximum 30% per hour.



Temperature humidity diagram

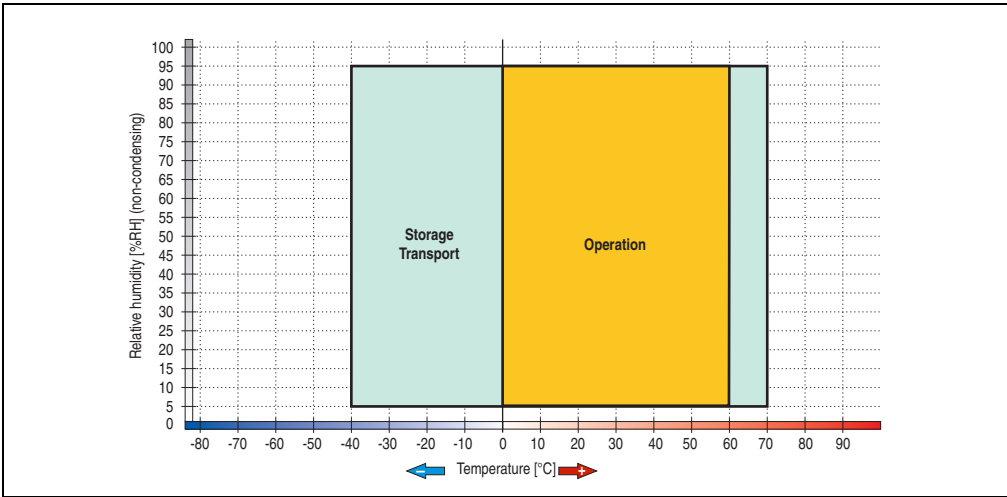

Figure 121: Temperature humidity diagram - SATA RAID hard disk - 5MMHDD.0250-00

Temperature values for 305 meter altitude. The temperature specification must be reduced linearly by 1°C every 305 meters. The temperature increase and decrease can be a maximum of 20°C per hour.

### 3.9 Interface options

An add-on interface (CAN or combined RS232/422/485) can be inserted.

#### Information:

It is possible to add or remove an add-on interface at any time.

#### Caution!

Turn off power before adding or removing an add-on interface.

#### 3.9.1 Add-on CAN interface - 5AC600.CANI-00

The add-on CAN interface is equipped with a Bosch CC770 CAN controller (compatible with an Intel 82527 CAN controller), which conforms to CAN specifications 2.0 part A/B. The CAN controller can trigger an NMI (non-maskable interrupt).

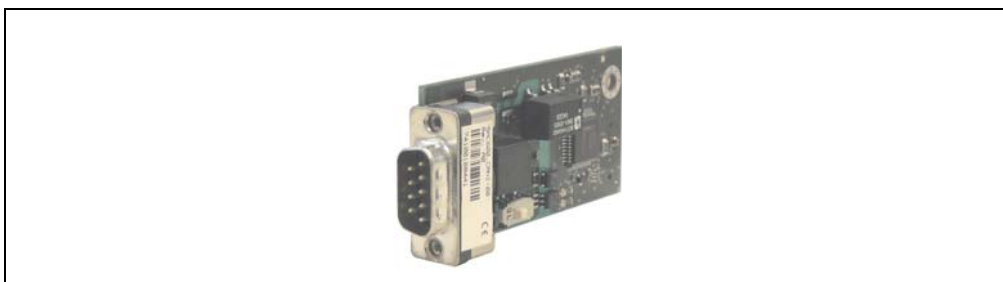

Figure 122: Add-on CAN interface - 5AC600.CANI-00

#### Technical data

Features	5AC600.CANI-00
CAN interface Controller Amount Connection	Bosch CC770 (compatible with Intel 82527 CAN controller) 1 9-pin DSUB, male
Terminating resistor Default setting	Can be activated and deactivated using a sliding switch Disabled

Table 112: Technical data - Add-on CAN interface - 5AC600.CANI-00

Pin assignments

Add-on CAN	
Type	Electrically isolated
Transfer rate	Max. 500 kBit/s
Bus length	Max. 1000 Meter
Pin	Assignment
1	n.c.
2	CAN low
3	GND
4	n.c.
5	n.c.
6	Reserved
7	CAN high
8	n.c.
9	n.c.

9-pin DSUB connector



Table 113: Pin assignments - CAN

I/O address and IRQ

Resource	Default setting	Additional setting options
I/O address	384 / 385	-
IRQ	IRQ10	NMI <sup>1)</sup>

Table 114: Add-on CAN - I/O Adresse und IRQ

1) NMI = Non Maskable Interrupt.

The setting for the IRQ can be changed in the BIOS setup (under "Advanced" - submenu "Baseboard/Panel Features" - submenu "Legacy Devices", setting "CAN"). Please note any potential conflicts with other resources when changing this setting.

I/O address	Register	Function
384h	Address register	Defines the register number to access.
385h	Data register	Access to the register defined in the address register.

Table 115: CAN address register

## Bus length and cable type

The type of cable used depends largely on the required bus length and the number of nodes. The bus length is mainly determined by the bit rate. In accordance with CiA (CAN in Automation) the maximum bus length is 1000 meters.

The following bus lengths are permitted with a maximum oscillator tolerance of 0.121%:

Distance [m]	Transfer rate [kBit/s]
≤ 1000	Typ. 50
≤ 200	Typ. 250
≤ 60	Typ. 500

Table 116: Bus length and transfer rate - CAN

The material used for the cable should preferably have all or most of the following properties in order to reach an optimal transfer rate.

CAN cable	Property
Signal lines Cable cross section Wire insulation Conductor resistance Stranding Shield	2 x 0.25 mm <sup>2</sup> (24AWG/19), tinned Cu wire PE ≤ 82 Ω / km Wires stranded in pairs Paired shield with aluminum foil
Grounding line Cable cross section Wire insulation Conductor resistance	1 x 0.34 mm <sup>2</sup> (22AWG/19), tinned Cu wire PE ≤ 59 Ω / km
Outer sheathing Item Characteristics Entire shielding	PUR mixture Halogen free From tinned cu wires

Table 117: CAN cable requirements

## Terminating resistor

CAN networks are cabled using a bus structure where both ends of the bus are equipped with terminating resistors. The add-on CAN interface has an integrated terminating resistor (delivery state: disabled with the setting "Off").

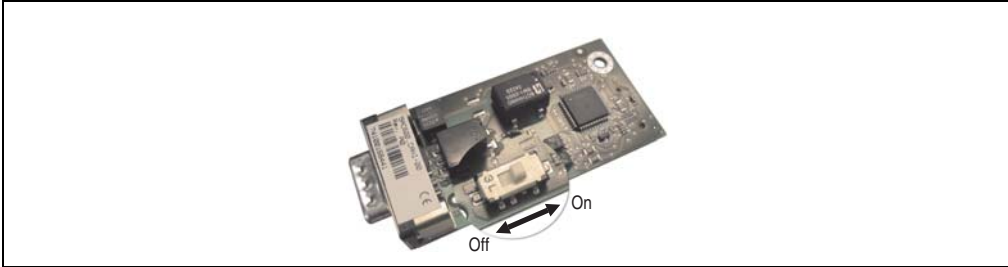

Figure 123: Terminating resistor - Add-on CAN interface 5AC600.CANI-00

## Contents of delivery

The screws included in the mounting kit are to be used for installation.



Figure 124: Contents of the delivery / mounting material - 5AC600.CANI-00

### 3.9.2 Add-on RS232/422/485 interface - 5AC600.485I-00

The serial interface is a combined RS232/RS422/RS485 interface. The operating mode (RS232/RS422/RS485) is selected automatically, depending on the electrical connection.



Figure 125: Add-on RS232/422/485 interface - 5AC600.485I-00

#### Pin assignments

Add-on RS232/422/485			
Features	RS232	RS422/485	<p>9-pin DSUB connector</p>
Type	RS232 not modem compatible; Electrically isolated		
UART	16550 compatible, 16 byte FIFO		
Transfer rate	Max. 115 kBit/s		
Bus length	Max. 15 meters	Max. 1200 meters	
Pin	Assignments (RS232)	Assignments (RS422)	
1	n.c.	TXD/	
2	RXD	n.c.	
3	TXD	n.c.	
4	n.c.	TXD	
5	GND	GND	
6	n.c.	RXD/	
7	RTS	n.c.	
8	CTS	n.c.	
9	n.c.	RXD	

Table 118: Pin assignments - RS232/RS422

#### I/O address and IRQ

Resource	Default setting	Additional setting options
I/O address	2E8	238, 2F8, 338, 3E8, 3F8
IRQ	IRQ10	IRQ 3, 4, 5, 7, 11, 12

Table 119: Add-on RS232/422/485 - I/O address and IRQ

The setting for the I/O address and the IRQ can be changed in the BIOS setup (under "Advanced" - submenu "Main board/Panel Features" - submenu "Legacy Devices", setting "COM E"). Please note any potential conflicts with other resources when changing this setting.

### Bus length and cable type RS232

The maximum transfer rate of 115 kBit/s depends on the cable type being used.

Distance [m]	Transfer rate [kBit/s]
≤ 15	Typ. 64
≤ 10	Typ. 115
≤ 5	Typ. 115

Table 120: RS232 - Bus length and transfer rate

The material used for the cable should preferably have all or most of the following properties in order to reach an optimal transfer rate.

RS232 cable	Property
Signal lines Cable cross section Wire insulation Conductor resistance Stranding Shield	4 x 0.16 mm <sup>2</sup> (26AWG), tinned Cu wire PE ≤ 82 Ω / km Wires stranded in pairs Paired shield with aluminum foil
Grounding line Cable cross section Wire insulation Conductor resistance	1 x 0.34 mm <sup>2</sup> (22AWG/19), tinned Cu wire PE ≤ 59 Ω / km
Outer sheathing Item Characteristics Entire shielding	PUR mixture Halogen free From tinned cu wires

Table 121: RS232 - Cable requirements

### RS422 - Bus length and cable type

The RTS line must be switched on to activate the sender.

The maximum transfer rate of 115 kBit/s depends on the cable type being used.

Distance [m]	Transfer rate [kBit/s]
1200	Typ. 115

Table 122: RS422 - Bus length and transfer rate

The material used for the cable should preferably have all or most of the following properties in order to reach an optimal transfer rate.

## Technical Data • Individual components

RS422 cable	Property
Signal lines Cable cross section Wire insulation Conductor resistance Stranding Shield	4 x 0.25 mm <sup>2</sup> (24AWG/19), tinned Cu wire PE ≤ 82 Ω / km Wires stranded in pairs Paired shield with aluminum foil
Grounding line Cable cross section Wire insulation Conductor resistance	1 x 0.34 mm <sup>2</sup> (22AWG/19), tinned Cu wire PE ≤ 59 Ω / km
Outer sheathing Item Characteristics Entire shielding	PUR mixture Halogen free From tinned cu wires

Table 123: RS422 - Cable requirements

### RS485 interface operation

The pins of the RS422 default interface (1,4,6 and 9) should be used for operation. The pins should be connected as shown.

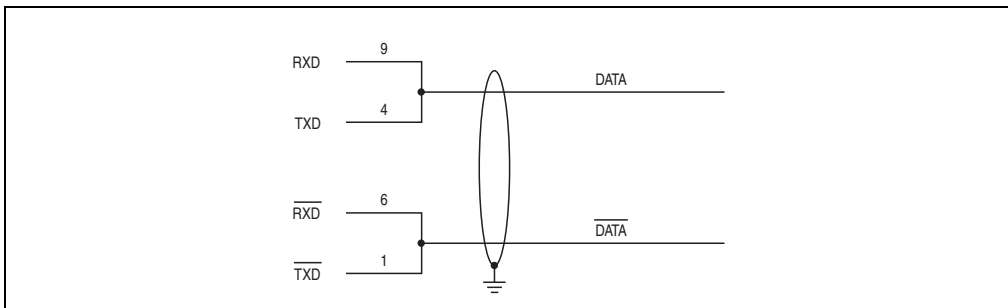

Figure 126: Add-on RS232/422/485 interface - operated in RS485 mode

The RTS line must be switched each time the driver is sent and received; there is no automatic switch back. This cannot be configured in Windows.

The voltage drop caused by long line lengths can lead to greater potential differences between the bus stations, which can hinder communication. This can be improved by running ground wire with the others.

The line ends of the RS485 interface should (at least for longer line lengths or larger transfer rates) be closed. Normally a passive terminator can be used on the bus ends by connecting each of the signal lines with 120 Ω resistance.

### RS485 - Bus length and cable type

The maximum transfer rate of 115 kBit/s depends on the cable type being used.



Distance [m]	Transfer rate [kBit/s]
1200	Typ. 115

Table 124: RS485 - Bus length and transfer rate

The material used for the cable should preferably have all or most of the following properties in order to reach an optimal transfer rate.

RS485 cable	Property
Signal lines Cable cross section Wire insulation Conductor resistance Stranding Shield	4 x 0.25 mm <sup>2</sup> (24AWG/19), tinned Cu wire PE ≤ 82 Ω / km Wires stranded in pairs Paired shield with aluminum foil
Grounding line Cable cross section Wire insulation Conductor resistance	1 x 0.34 mm <sup>2</sup> (22AWG/19), tinned Cu wire PE ≤ 59 Ω / km
Outer sheathing Item Characteristics Entire shielding	PUR mixture Halogen free From tinned cu wires

Table 125: RS485 - Cable requirements

### Contents of delivery

The screws included in the mounting kit are to be used for installation.

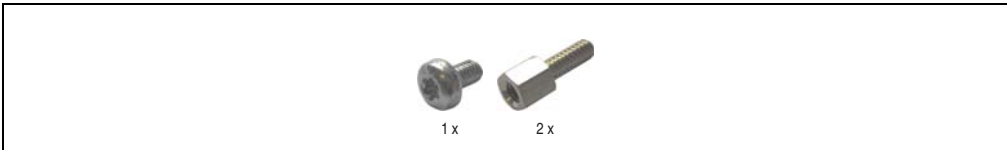

Figure 127: Contents of the delivery / mounting material - 5AC600.485I-00

### 3.10 Fan kits

#### Information:

Fans are necessary when using components which must work within certain temperature limits, e.g. hard disks, DVD combos, PCI cards, etc.

The fan and dust filter are subject to wear and must be checked with appropriate frequency and cleaned or replaced when not functioning properly (e.g. due to dirt and grime).

#### 3.10.1 Fan kit 1 PCI - 5PC600.FA01-00

This fan kit is an optional addition for system units with 1 PCI slots. For available replacement dust filters for this fan kit, see section "Replacement fan", on page 737.

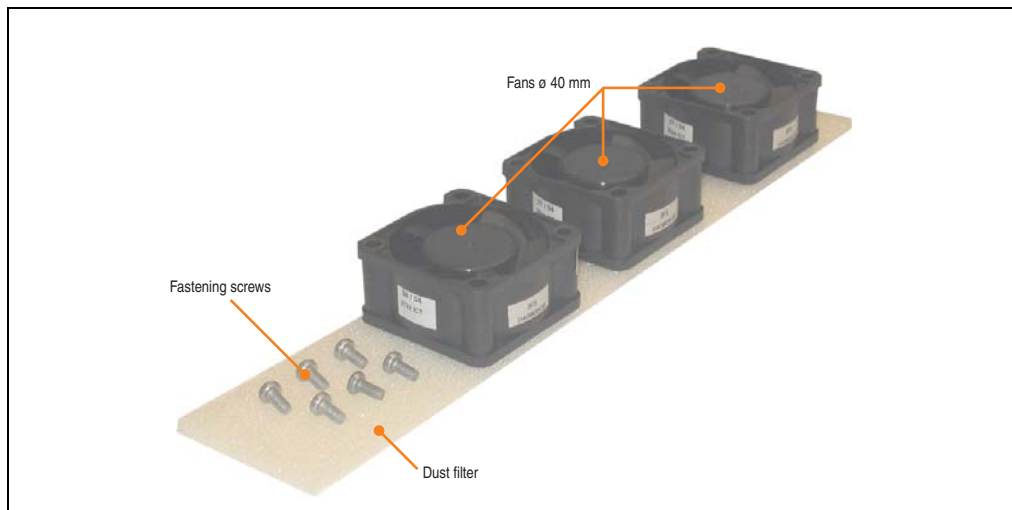

Figure 128: Fan kit - 5PC600.FA01-00

#### Technical data

Features	5PC600.FA01-00
Fan type	Double ball bearings
Width	40 mm
Length	40 mm
Height	20 mm
Revolution speed	5600 rpm $\pm$ 10%
Noise level	24 dB
Lifespan	80,000 hours at 30°C

Table 126: Technical data - 5PC600.FA01-00

Features	5PC600.FA01-00
Maintenance interval	The fans are subject to wear. Depending on the work environment, the dust filter should be checked with appropriate frequency to determine whether the air flow provides sufficient cooling. An exchange or cleaning of the filter kit is appropriate at that time.

Table 126: Technical data - 5PC600.FA01-00 (Forts.)

### Contents of delivery

Amount	Component
3	Fans with 40 mm diameter
1	Dust filter
6	Mounting screws

Table 127: Contents of delivery - 5PC600.FA01-00

### Installation

For a description of how to install the fan kit, see chapter 7 "Maintenance / Servicing", section 3 "Fan kit installation and replacement", starting on page 747.

#### 3.10.2 Fan kit 2 PCI - 5PC600.FA02-00

This fan kit is an optional addition for system units with 2 PCI slots. For available replacement dust filters for this fan kit, see section "Replacement fan", on page 737.

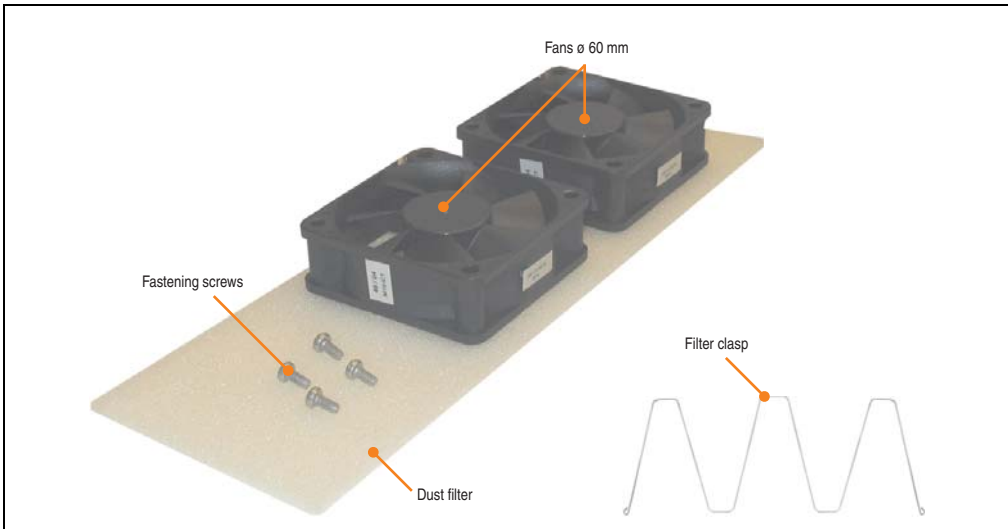

Figure 129: Fan kit - 5PC600.FA02-00

## Technical data

Features	5PC600.FA02-00
Fan type	Double ball bearings
Width	60 mm
Length	60 mm
Height	20 mm
Revolution speed	3600 rpm $\pm$ 10%
Noise level	30.5 dB
Lifespan	80,000 hours at 30°C
Maintenance interval	The fans are subject to wear. Depending on the work environment, the dust filter should be checked with appropriate frequency to determine whether the air flow provides sufficient cooling. An exchange or cleaning of the filter kit is appropriate at that time.

Table 128: Technical data - 5PC600.FA02-00

## Contents of delivery

Amount	Component
2	Fans with 60 mm diameter
1	Dust filter
1	Filter clasp
4	Mounting screws

Table 129: Contents of delivery - 5PC600.FA02-00

## Installation

For a description of how to install the fan kit, see chapter 7 "Maintenance / Servicing", section 3 "Fan kit installation and replacement", starting on page 750.

### 3.10.3 Fan kit 3PCI - 5PC600.FA03-00

This fan kit is an optional addition for system units with 3 PCI slots. For available replacement dust filters for this fan kit, see section "Replacement fan", on page 737.

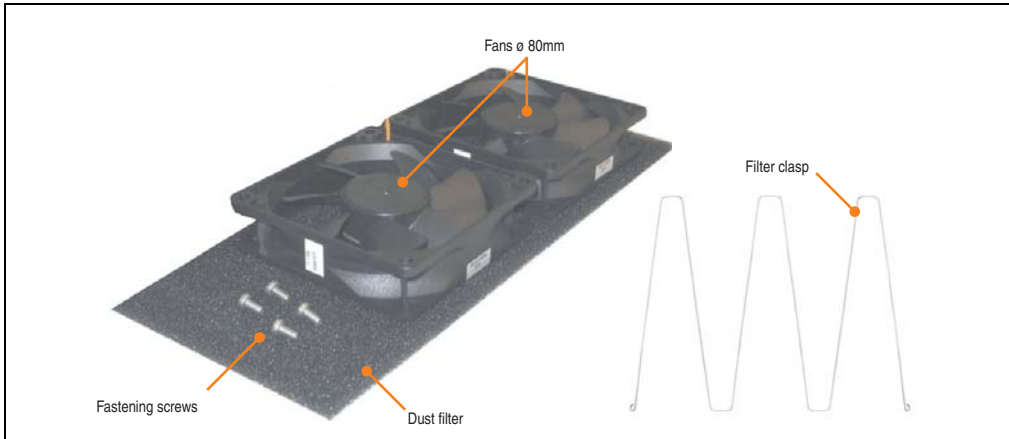

Figure 130: Fan kit - 5PC600.FA03-00

#### Technical data

Features	5PC600.FA03-00
Fan type	Double ball bearings
Amount	2
Width	80 mm
Length	80 mm
Height	20 mm
Revolution speed	2600 rpm $\pm$ 10%
Noise level	27 dB
Lifespan	80,000 hours at 30°C
Maintenance interval	The fans are subject to wear. Depending on the work environment, the dust filter should be checked with appropriate frequency to determine whether the air flow provides sufficient cooling. An exchange or cleaning of the filter kit is appropriate at that time.

Table 130: Technical data - 5PC600.FA03-00

#### Contents of delivery

Amount	Component
2	Fans with 80 mm diameter
1	Dust filter
1	Filter clasp
4	Mounting screws

Table 131: Contents of delivery - 5PC600.FA03-00

## Technical Data • Individual components

Amount	Component
2	Cable fastener

Table 131: Contents of delivery - 5PC600.FA03-00

### Installation

For a description of how to install the fan kit, see chapter 7 "Maintenance / Servicing", section 3 "Fan kit installation and replacement", starting on page 753.

#### 3.10.4 Fan kit 5 PCI - 5PC600.FA05-00

This fan kit is an optional addition for system units with 5 PCI slots. For available replacement dust filters for this fan kit, see section "Replacement fan", on page 737.

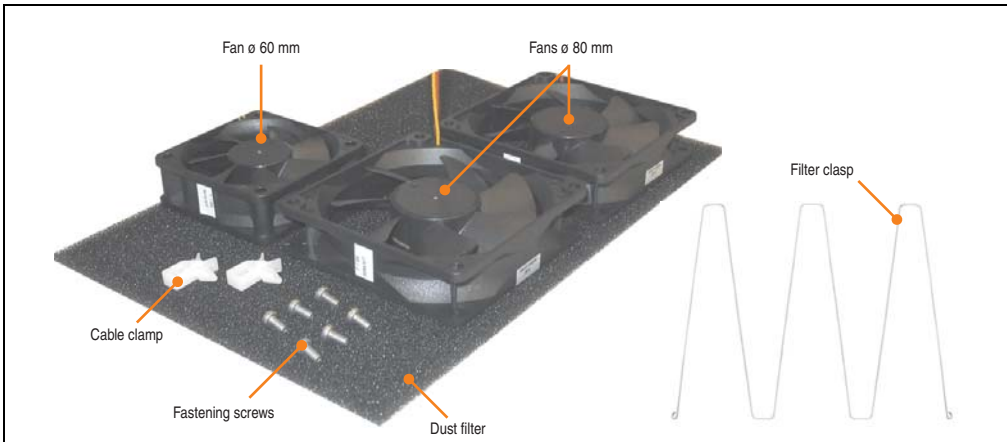

Figure 131: Fan kit - 5PC600.FA05-00

### Technical data

Features	5PC600.FA05-00	
Fan type	Double ball bearings	Double ball bearings
Amount	1	2
Width	60 mm	80 mm
Length	60 mm	80 mm
Height	20 mm	20 mm
Revolution speed	3600 rpm $\pm$ 10%	2600 rpm $\pm$ 10%
Noise level	30.5 dB	27 dB
Lifespan	80,000 hours at 30°C	
Maintenance interval	The fans are subject to wear. Depending on the work environment, the dust filter should be checked with appropriate frequency to determine whether the air flow provides sufficient cooling. An exchange or cleaning of the filter kit is appropriate at that time.	

Table 132: Technical data - 5PC600.FA05-00

## Contents of delivery

Amount	Component
1	Fans with 60 mm diameter
2	Fans with 80 mm diameter
1	Dust filter
1	Filter clasp
4	Mounting screws
2	Cable fastener

Table 133: Contents of delivery - 5PC600.FA05-00

## Installation

For a description of how to install the fan kit, see chapter 7 "Maintenance / Servicing", section 3 "Fan kit installation and replacement", starting on page 757.

### 3.11 AP Link cards

For the APC620 system units 5PC600.SX02-00, 5PC600.SF03-00 and 5PC600.SX05-00 and an 855GME CPU board, a second graphics line can be created using the AP Link graphics adapter cards.

#### 3.11.1 AP Link SDL transmitter - 5AC600.SDL0-00

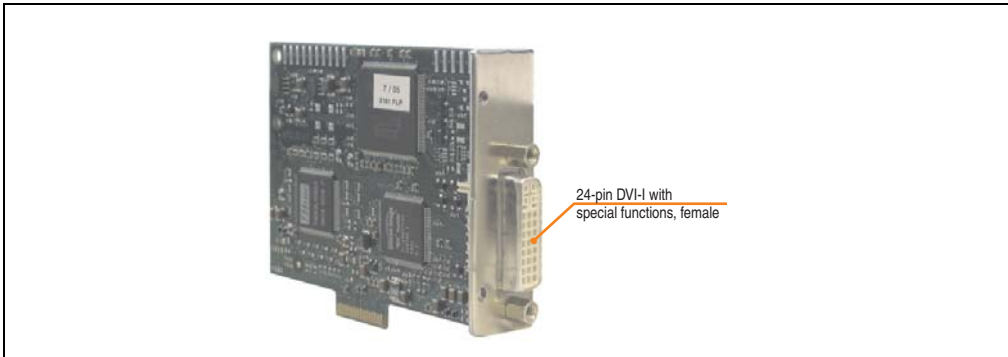

Figure 132: AP Link card

Model number	Short description	Note
5AC600.SDL0-00	AP Link SDL transmitter	

Table 134: Model numbers - AP Link graphics adapter

The following video signals are available via AP Link and monitor/panel output. The plugs are specified for 100 connection cycles.

AP Link slot (AP Link card inserted)		
For details, see technical data for the CPU board being used.		
AP Link card	Signal with 855GME (ETX / XTX) board on	
	AP Link	Monitor/Panel
5AC600.SDL0-00	DVI, SDL (GE1)	RGB, DVI, SDL (GE2)

Table 135: AP Link slot (AP Link card inserted)

Hotplug for a display device is not supported in any combination.



## Caution!

The RGB, DVI and SDL cables can only be plugged in and unplugged when the APC620 and display device (Automation Panel 900, Automation Panel 800, monitor) are turned off.

### Pin assignments

Pin	Assignment	Pin	Assignment
1	T.M.D.S. Data 2-	16	Hot Plug detect
2	T.M.D.S. Data 2+	17	T.M.D.S. Data 0-
3	T.M.D.S. Data 2/SDL Shield	18	T.M.D.S. Data 0+
4	SDL-	19	T.M.D.S. DATA 0/XUSB1 Shield
5	SDL+	20	XUSB1-
6	DDC clock	21	XUSB1+
7	DDC data	22	T.M.D.S. Clock Shield
8	n.c.	23	T.M.D.S. Clock +
9	T.M.D.S. DATA 1-	24	T.M.D.S. Clock -
10	T.M.D.S. DATA 1+	c1	n.c.
11	T.M.D.S. DATA 1/XUSB0 Shield	c2	n.c.
12	XUSB0-	c3	n.c.
13	XUSB0+	c4	n.c.
14	+ 5 V power <sup>1)</sup>	c5	n.c.
15	Ground (return for + 5V, HSync and VSync)		

DVI-I 24 pin, female

Table 136: Pin assignment for AP Link connection

1) Protected internally by a multifuse

**Cable lengths and resolutions for SDL transfer**

The following table shows the relationship between segment lengths and the maximum resolution according to the SDL cable used:

Cables Segment length [m]	Resolution				
	VGA 640 x 480	SVGA 800 x 600	XGA 1024 x 768	SXGA 1280 x 1024	UXGA 1600 x 1200
1.8	5CASDL.0018-00 5CASDL.0018-01 5CASDL.0018-03	5CASDL.0018-00 5CASDL.0018-01 5CASDL.0018-03	5CASDL.0018-00 5CASDL.0018-01 5CASDL.0018-03	5CASDL.0018-00 5CASDL.0018-01 5CASDL.0018-03	5CASDL.0018-00 5CASDL.0018-01 5CASDL.0018-03
5	5CASDL.0050-00 5CASDL.0050-01 5CASDL.0050-03	5CASDL.0050-00 5CASDL.0050-01 5CASDL.0050-03	5CASDL.0050-00 5CASDL.0050-01 5CASDL.0050-03	5CASDL.0050-00 5CASDL.0050-01 5CASDL.0050-03	5CASDL.0050-00 5CASDL.0050-01 5CASDL.0050-03
10	5CASDL.0100-00 5CASDL.0100-01 5CASDL.0100-03	5CASDL.0100-00 5CASDL.0100-01 5CASDL.0100-03	5CASDL.0100-00 5CASDL.0100-01 5CASDL.0100-03	5CASDL.0100-00 5CASDL.0100-01 5CASDL.0100-03	5CASDL.0100-00 <sup>1)</sup> 5CASDL.0100-01 <sup>1)</sup> 5CASDL.0100-03 <sup>1)</sup>
15	5CASDL.0150-00 5CASDL.0150-01 5CASDL.0150-03	5CASDL.0150-00 5CASDL.0150-01 5CASDL.0150-03	5CASDL.0150-00 5CASDL.0150-01 5CASDL.0150-03	5CASDL.0150-00 <sup>1)</sup> 5CASDL.0150-01 <sup>1)</sup> 5CASDL.0150-03 <sup>1)</sup>	- - -
20	5CASDL.0200-00 <sup>1)</sup> 5CASDL.0200-30 <sup>1)</sup>	5CASDL.0200-00 <sup>1)</sup> 5CASDL.0200-30 <sup>1)</sup>	5CASDL.0200-00 <sup>1)</sup> 5CASDL.0200-30 <sup>1)</sup>	5CASDL.0200-00 <sup>1)</sup> 5CASDL.0200-30 <sup>1)</sup>	- -
25	5CASDL.0250-00 <sup>1)</sup> 5CASDL.0250-30 <sup>1)</sup>	5CASDL.0250-00 <sup>1)</sup> 5CASDL.0250-30 <sup>1)</sup>	5CASDL.0250-00 <sup>1)</sup> 5CASDL.0250-30 <sup>1)</sup>	- -	- -
30	5CASDL.0300-00 <sup>1)</sup> 5CASDL.0300-03 <sup>1)</sup>	5CASDL.0300-00 <sup>1)</sup> 5CASDL.0300-03 <sup>1)</sup>	5CASDL.0300-10 <sup>2)</sup> 5CASDL.0300-13 <sup>2)</sup>	5CASDL.0300-10 <sup>2)</sup> 5CASDL.0300-13 <sup>2)</sup>	-
40	5CASDL.0400-10 <sup>2)</sup> 5CASDL.0400-13 <sup>2)</sup>	5CASDL.0400-10 <sup>2)</sup> 5CASDL.0400-13 <sup>2)</sup>	5CASDL.0400-10 <sup>2)</sup> 5CASDL.0400-13 <sup>2)</sup>	5CASDL.0400-10 <sup>2)</sup> 5CASDL.0400-13 <sup>2)</sup>	- -

Table 137: Segment lengths, resolutions and SDL cables

- 1) See table 138 "Requirements for SDL cable with automatic cable adjustment (equalizer)", on page 290
- 2) See table 139 "Requirements for SDL cable with extender and automatic cable adjustment (equalizer)", on page 291

The cable types and resolutions shown with a footnote 1) in the previous table can only be implemented starting with the following firmware and hardware versions:

Firmware	Name	Version	Note
MTCX FPGA	Firmware on the APC620	v 01.15	The version is read from BIOS - see the BIOS description. Supported starting with the APC620 / PPC 700 Firmware upgrade (MTCX, SDLR, SDLT) V01.10, available in the download area of the B&R homepage.
MTCX PX32	Firmware on the APC620	v 01.55	
SDLR FPGA	Firmware on the AP Link SDL receiver and transceiver	v 01.04	
SDLT FPGA	Firmware on the AP Link SDL transmitter	v 00.02	
Hardware	Name	Revision	Note
5DLSDL.1000-00	AP Link SDL receiver	Rev. B0	
5DLSDL.1000-01	AP Link SDL transceiver	Rev. B0	

Table 138: Requirements for SDL cable with automatic cable adjustment (equalizer)

The cable types and resolutions shown with a footnote 2) in the previous table can only be implemented starting with the following firmware and hardware versions:

Firmware	Name	Version	Note
MTCX FPGA	Firmware on the APC620	v 01.15	The version is read from BIOS - see the BIOS description. Supported starting with the APC620 / PPC 700 Firmware upgrade (MTCX, SDLR, SDLT) <b>V01.10</b> , available in the download area of the B&R homepage.
MTCX PX32	Firmware on the APC620	v 01.55	
SDLR FPGA	Firmware on the AP Link SDL receiver and transceiver	v 01.04	
SDLT FPGA	Firmware on the AP Link SDL transmitter	v 00.02	
Hardware	Name	Revision	Note
5DLSDL.1000-00	AP Link SDL receiver	Rev. D0	
5DLSDL.1000-01	AP Link SDL transceiver	Rev. D0	
5AC600.SDL0-00	AP Link SDL transmitter	Rev. B3	
5PC600.SX02-00	System 2 PCI, 1 disk drive slot, 1 AP Link slot	Rev. D0	
5PC600.SF03-00	System 3 PCI, 1 disk drive slot, 1 AP Link slot	Rev. A0	
5PC600.SX05-00	System 5 PCI, 2 disk drive slots, 1 AP Link slot	Rev. C0	

Table 139: Requirements for SDL cable with extender and automatic cable adjustment (equalizer)

### DVI, SDL description

DVI means:

- Connection of B&R Automation Panel 900 display units with Automation Panel Link DVI Receiver (Model nr. 5DLDMI.1000-01), Office Digital/DVI Monitors and Office DVI TFT Displays is possible.

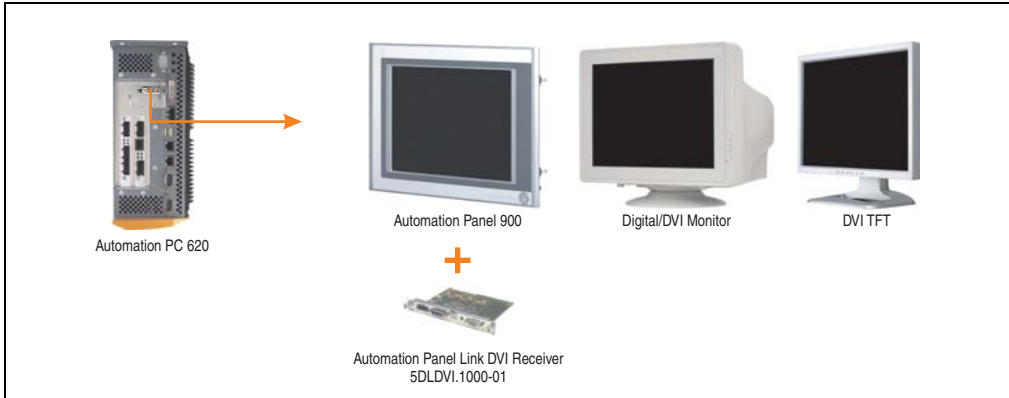

Figure 133: AP Link device connection with DVI video signal

For examples and possibilities for connecting Automation Panel 900 display units via DVI, see Appendix A, chapter 3 "Commissioning", section 4 "Connection examples", starting on page 308.

SDL (Smart Display Link) means:

- Connection of B&R Automation Panel 900 display units with Automation Panel Link SDL receiver (Model nr. 5DLSDL.1000-01) or SDL transceiver (Model nr. 5DLSDL.1000-01).

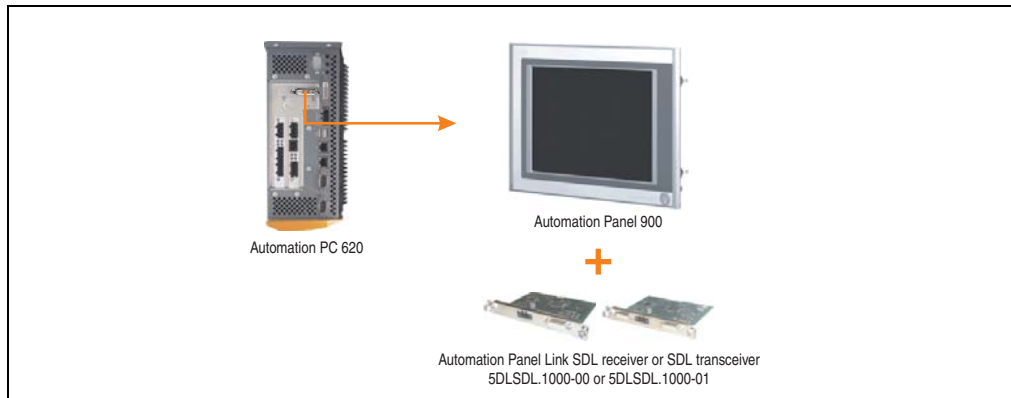

Figure 134: AP Link device connection with SDL video signal

For examples and possibilities for connecting Automation Panel 900 and Automation Panel 800 display units via SDL, see Appendix A, chapter 3 "Commissioning", section 4 "Connection examples", starting on page 308.

# Chapter 3 • Commissioning

## 1. Installation

The APC620 systems are mounted with the mounting plates found on the housing. The plates are designed for M5 screws.

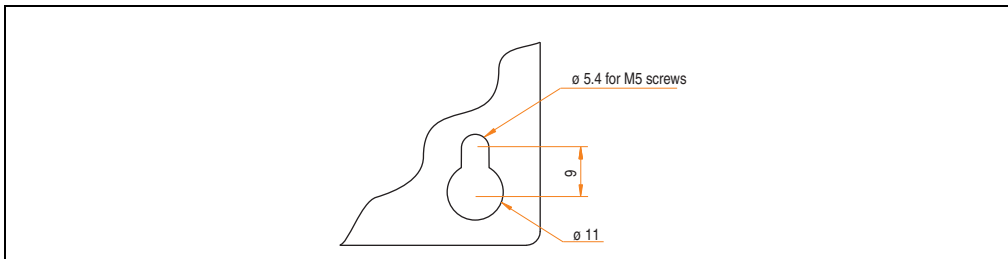

Figure 135: Mounting plates for the APC620

The exact positioning of the mounting holes can be seen in the following drilling templates.

### 1.1 Important mounting information

- The environmental conditions must be taken into consideration (see chapter 2 "Technical Data", section 2.6 "Ambient temperatures for systems with an 815E CPU board (ETX)", on page 89, and section 2.7 "Ambient temperatures for systems with an 855GME CPU board (ETX / XTX)", on page 93).
- The APC620 is only for operation in closed rooms.
- The APC620 cannot be situated in direct sunlight.
- The ventilation holes cannot be covered.
- When mounting the device, be sure to adhere to the allowable mounting orientations (see section 1.3 "Mounting orientation", on page 297).
- Be sure the wall or switching cabinet can withstand four times the total weight of the the PC620.
- When connecting certain cable types (DVI, SDL, USB, etc.), keep the flex radius in mind. (see section 2 "Cable connections", on page 306).

1.2 Drilling templates

APC620 with 1 PCI slot	APC620 with 2 PCI slots
<p>Mounting plate template (APC620)</p> <p>270 262</p> <p>18 0</p> <p>0 15 50 65</p> <p>General tolerance according to ISO 2768 medium</p>	<p>Mounting plate template (APC620)</p> <p>270 262</p> <p>18 0</p> <p>0 17.3 87.3 104.5</p> <p>General tolerance according to ISO 2768 medium</p>

Table 140: Drilling templates - 1 and 2 PCI slots

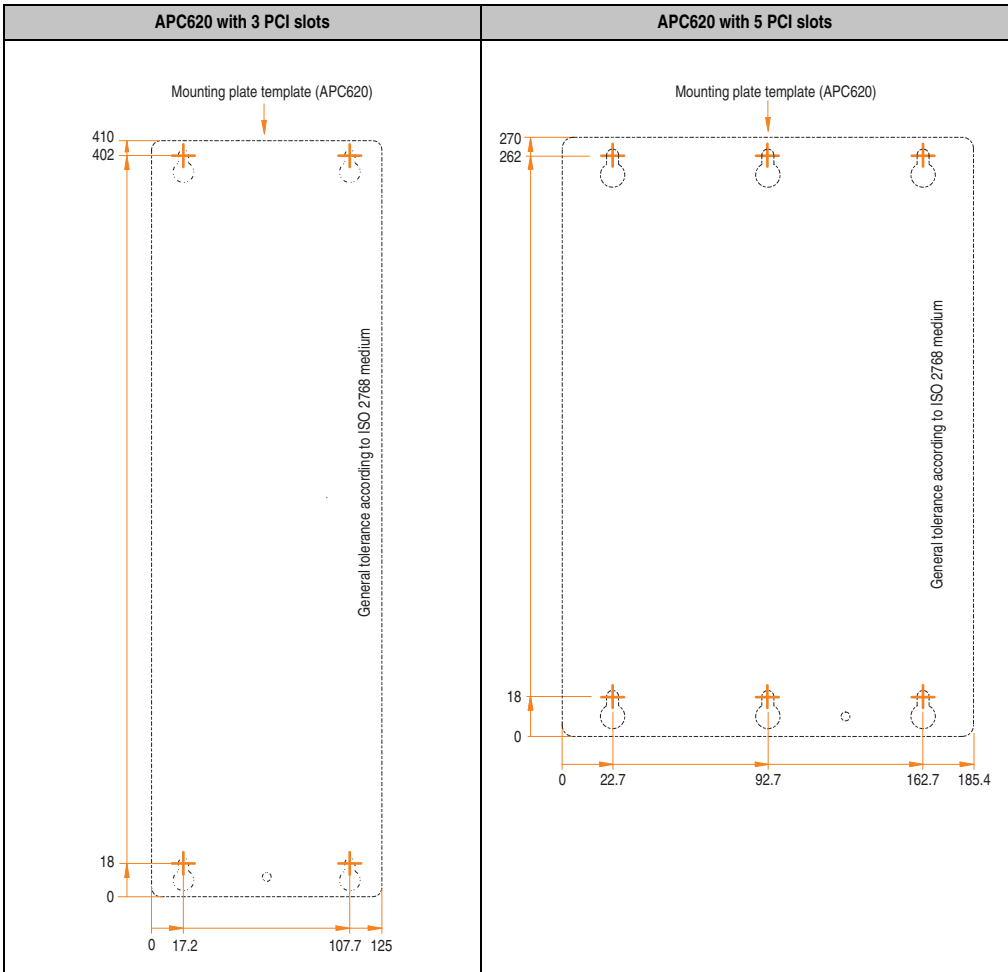

Table 141: Drilling templates - 3 and 5 PCI slots

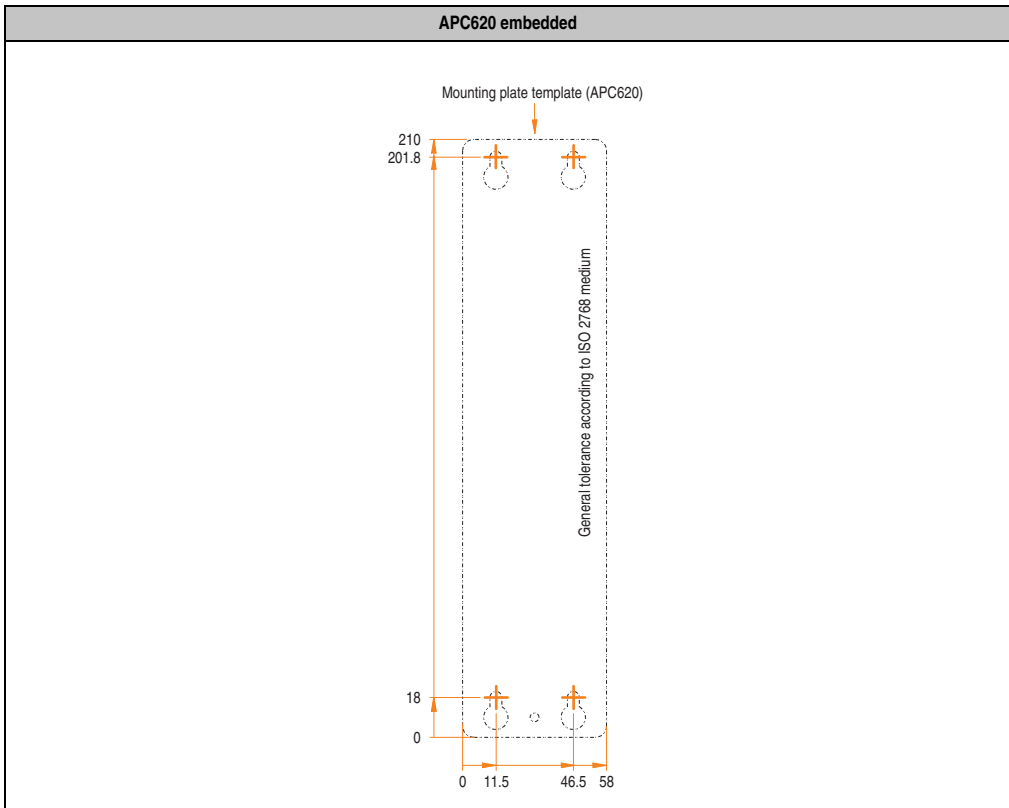

Table 142: Drilling templates - APC620 embedded



## 1.3 Mounting orientation

The Automation PC620 system must be mounted as described in the following sections.

### 1.3.1 Standard mounting

Standard mounting refers to vertical mounting orientation.

APC620 systems with and without fan kit can be mounted this way.

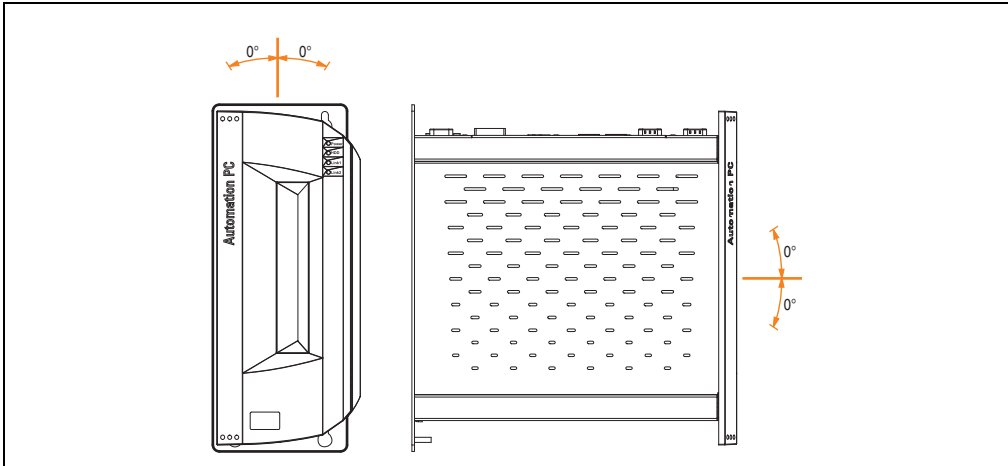

Figure 136: Mounting orientation - Standard

In order to guarantee natural air circulation, mount the system so that the spacing on the top, bottom, and sides is as follows.

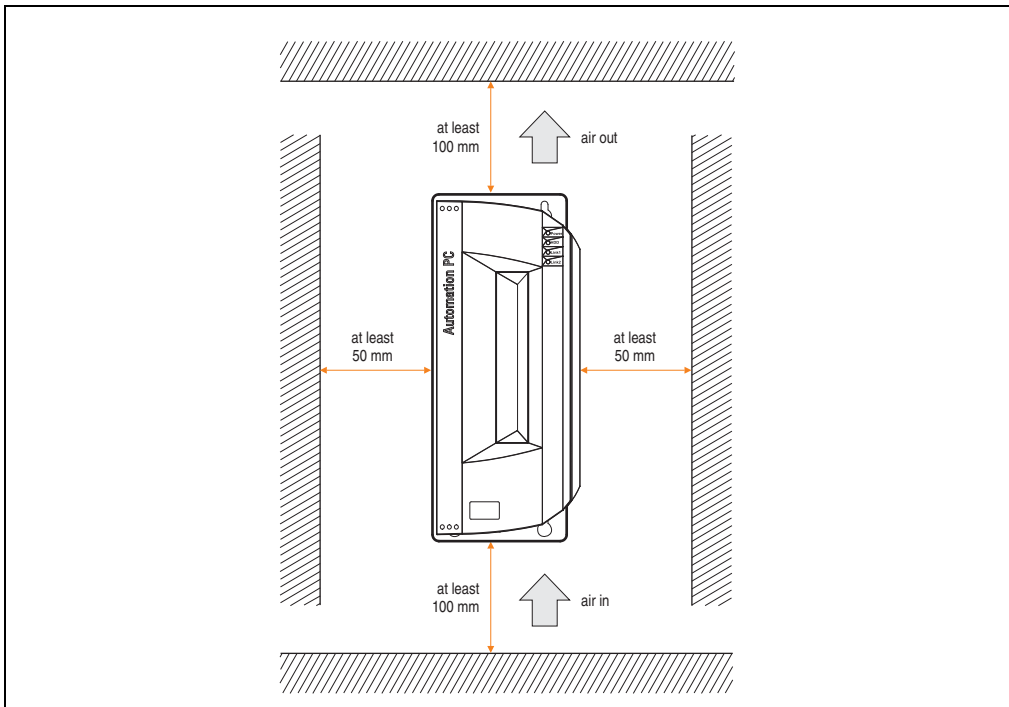

Figure 137: Air circulation spacing - Standard

### 1.3.2 Optional mounting orientations

## Caution!

A fan kit must be used if the system is mounted in the following orientations. In addition, it is important to be sure that the components used are installed in a way that complies with the specifications of the drives being used (CD-ROM, DVD/CD-RW, hard disk, etc.). See the following pages for information regarding the specifications for mounting orientation.

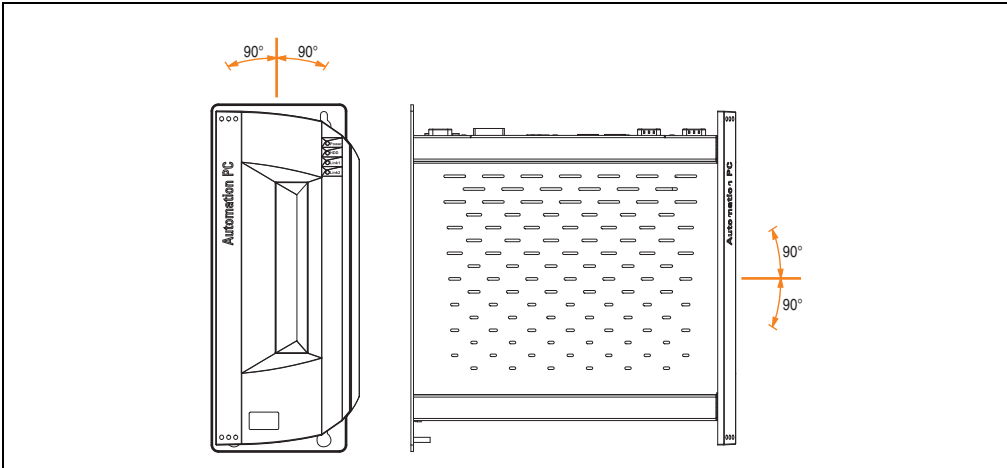

Figure 138: Mounting orientation - Optional

## Commissioning • Installation

In order to guarantee natural air circulation, mount the system so that the spacing on the top, bottom, and sides is as follows.

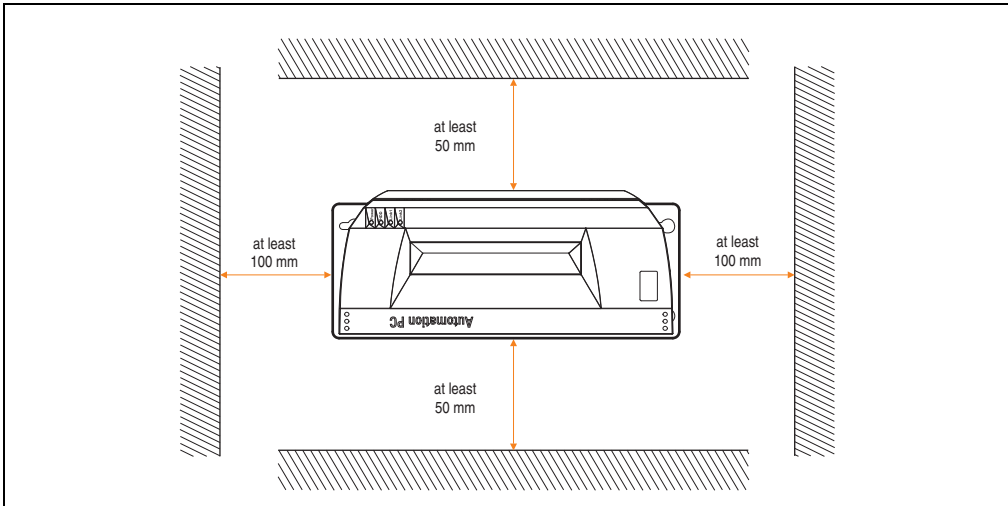

Figure 139: Optional circulation spacing

### CompactFlash slot, add-on or slide-in

No limitation on mounting orientation. Permissible mounting orientations are shown in figure 138 "Mounting orientation - Optional", on page 299.

### Add-on or slide-in hard disks 20, 30 and 40 GB.

The following figure shows the possible mounting orientations for an APC620 device with an add-on (5AC600.HDDI-00 or 5AC600.HDDI-01) or slide-in hard disk (5AC600.HDDS-00 or 5AC600.HDDS-02).

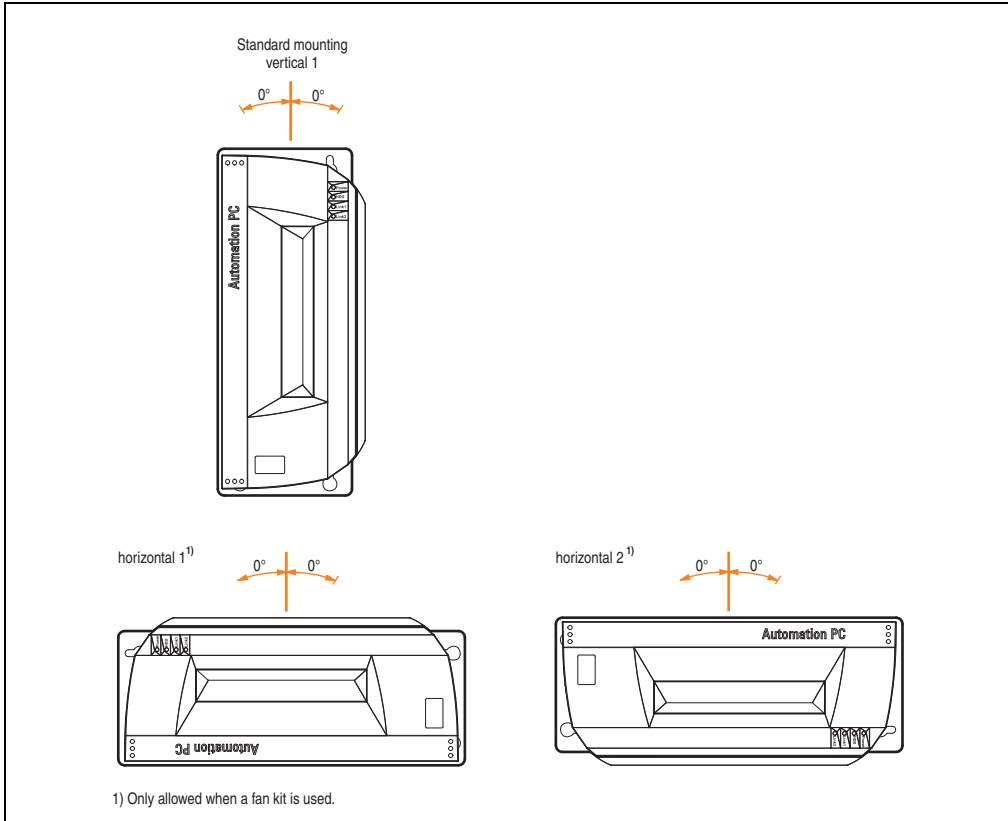

Figure 140: Mounting orientations for an APC620 with hard disk drive

The mounting orientations "horizontal 1" and "horizontal 2" require the use of a fan kit.

Slide-in CD-ROM drive

The following figure shows the possible mounting orientations for an APC620 device with a slide-in CD-ROM drive (5AC600.CDXS-00).

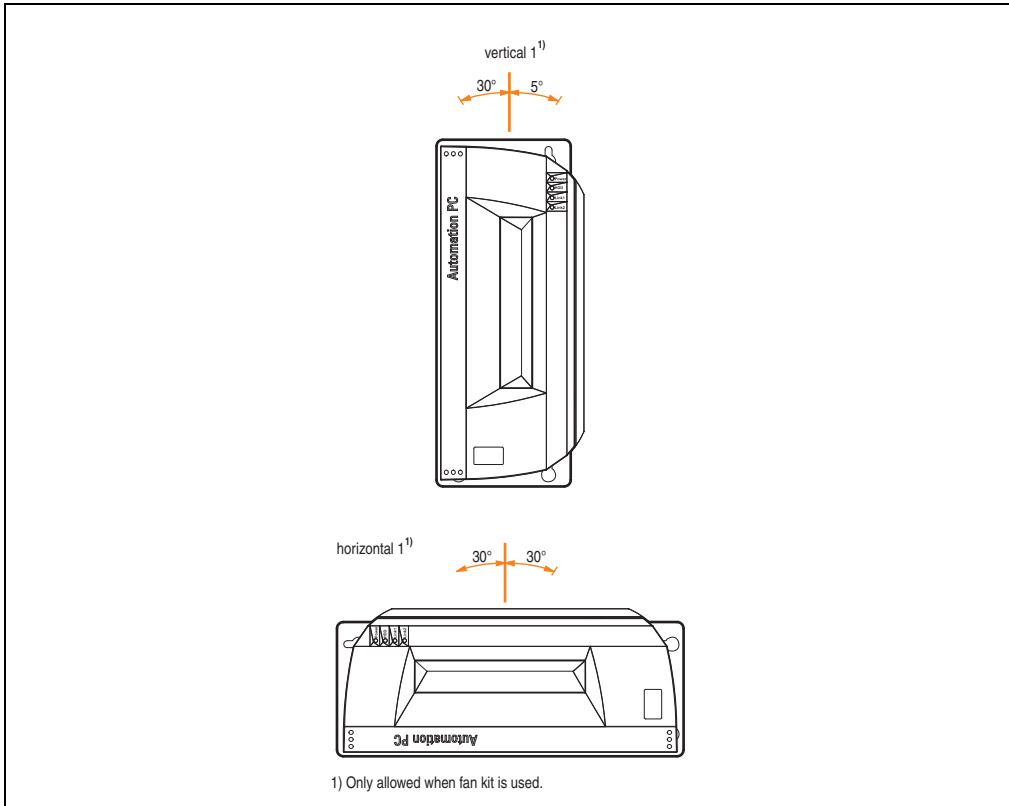

Figure 141: Mounting orientations for an APC 620 with a slide-in CD-ROM drive

The mounting orientation "horizontal 1" requires the use of a fan kit.

Mounting orientation "vertical 1" can also be used at 0° without a fan kit.

## Slide-in DVD-ROM/CD-RW drive

The following figure shows the possible mounting orientations for an APC620 device with a slide-in DVD-ROM/CD-RW drive 5AC600.DVDS-00).

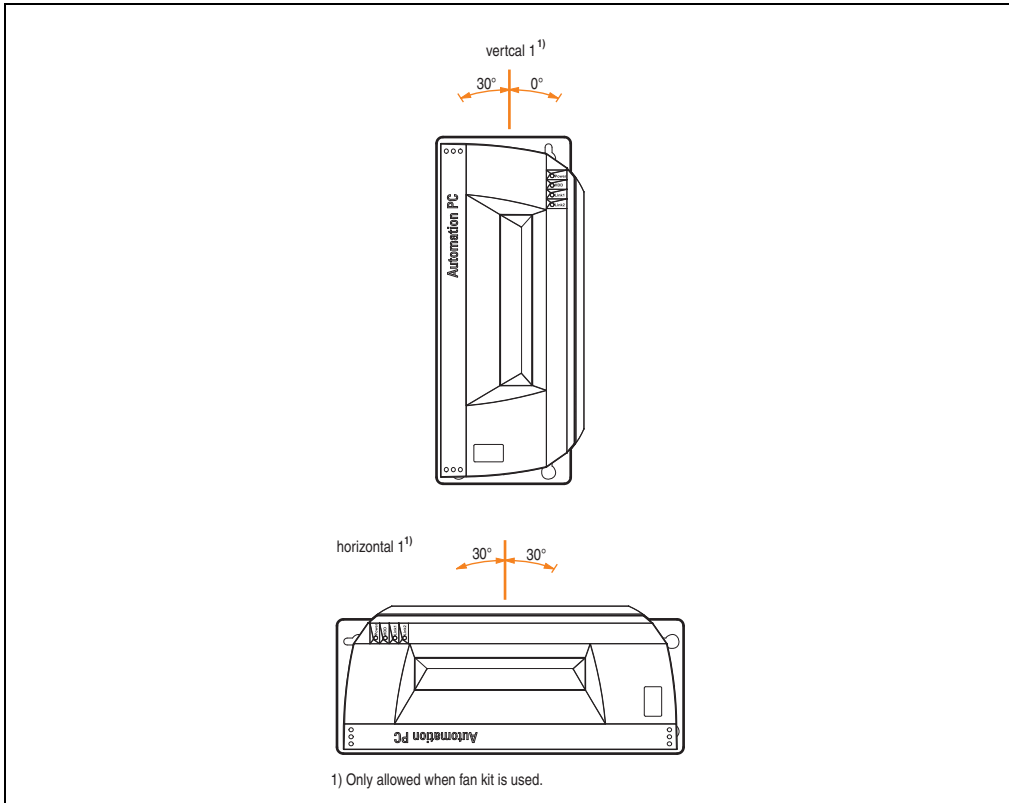

Figure 142: Mounting orientations for an APC620 with a slide-in DVD-ROM/CD-RW drive

The mounting orientation "horizontal 1" requires the use of a fan kit.

Mounting orientation "vertical 1" can also be used at 0° without a fan kit.

Slide-in DVD-R/RW/DVD+R/RW

The following figure shows the possible mounting orientations for an APC620 device with a slide-in DVD-R/RW / DVD+R/RW drive (5AC600.DVRS-00).

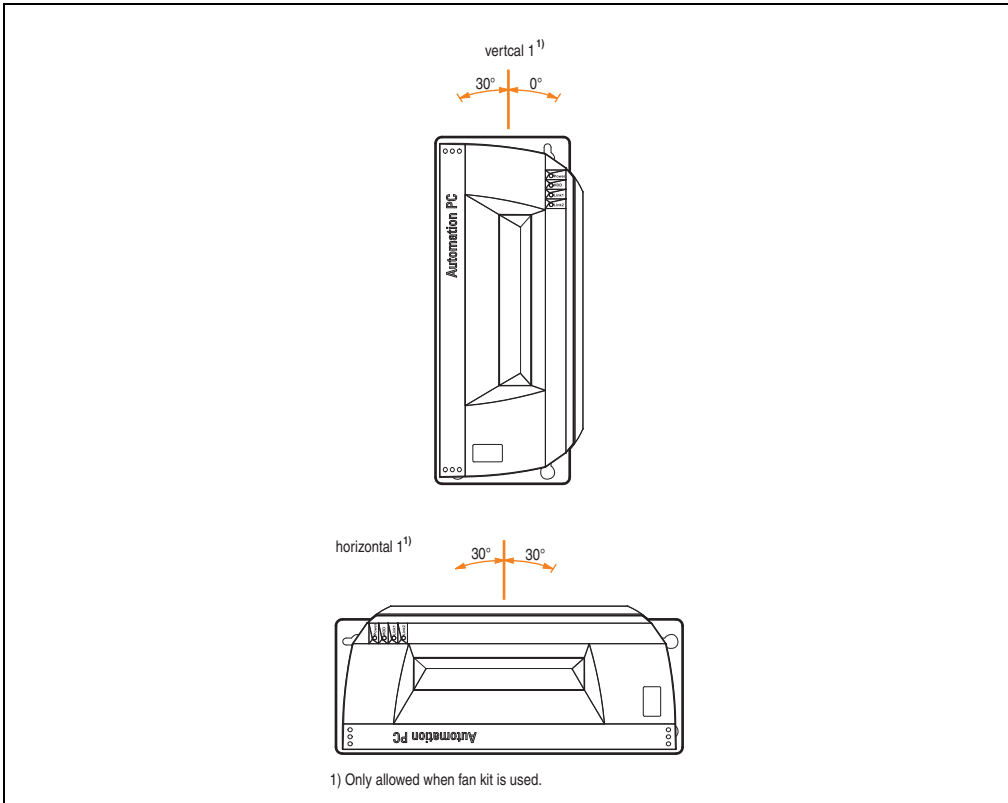

Figure 143: Mounting orientations for an APC620 with a slide-in DVD-R/RW / DVD+R/RW drive

The mounting orientation "horizontal 1" requires the use of a fan kit.

Mounting orientation "vertical 1" can also be used at 0° without a fan kit.



## Slide-in USB FDD

The following figure shows the possible mounting orientations for an APC620 device with a slide-in USB FDD drive (5AC600.FDDS-00).

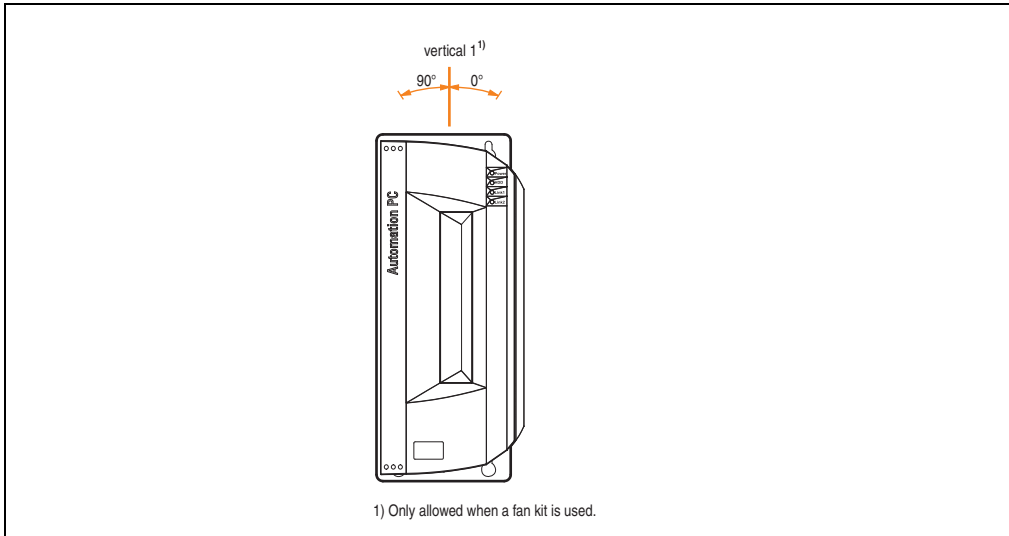

Figure 144: Mounting orientations for an APC620 with a slide-in USB FDD drive

Mounting orientation "vertical 1" can also be used at 0° without a fan kit.

## 2. Cable connections

When making cable connections and installing cables, it is not permitted to have a flex radius smaller than the minimum value specified.

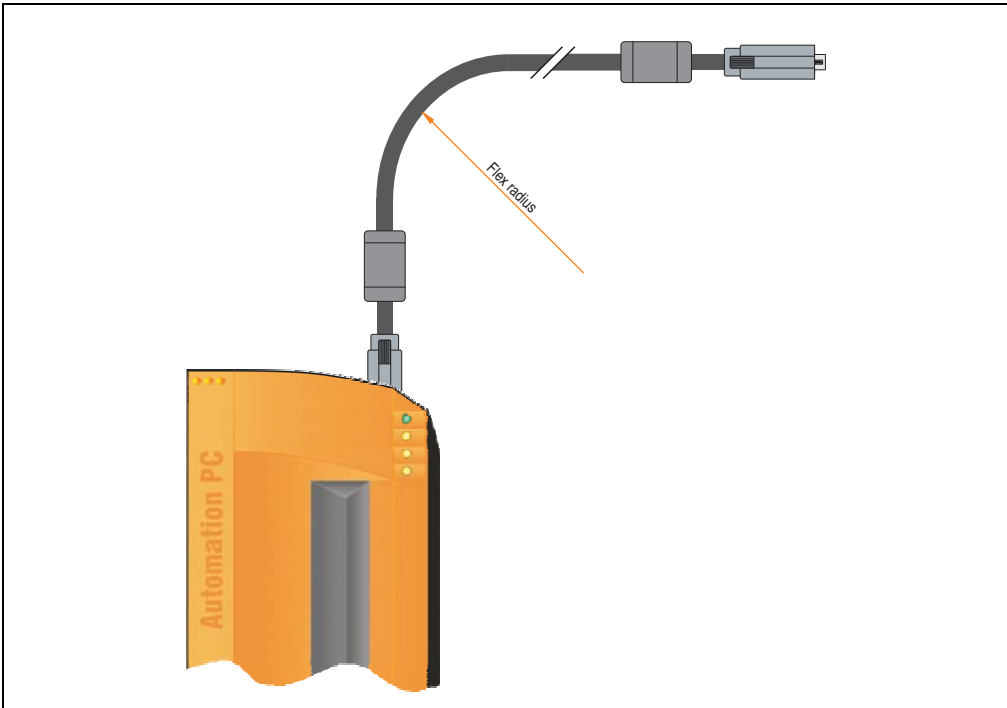

Figure 145: Flex radius - Cable connection

### Information:

The value specified for the minimum flex radius can be found in the technical data for the cable that is being used.

### 2.1 Ethernet cable lengths for ETH1

For error free data transfer, take note of the cable length information in section "Ethernet connection ETH1", on page 130.

### 3. Grounding concept

Functional ground is a current path of low impedance between electrical circuits and ground. It is used, for example, to improve immunity to disturbances and not necessarily as a protective measure. It therefore serves only to deflect disturbances, not to provide any kind of protection against electric shock.

This device comes equipped with two functional ground connections:

- Supply voltage
- Ground connection

To guarantee safe conductance of electric disturbances, the following points must be observed:

- The device must be connected to the central grounding point in the control cabinet using the shortest route possible.
- A cable with a minimum cross section of  $2.5 \text{ mm}^2$  per connection should be used. If a cable with wire end sleeves is connected to the OTB103.9 or OTB103.91 terminal block, then a cable with maximum  $1.5 \text{ mm}^2$  per connection is possible.
- Note the line shielding concept. All data cables connected to the device must be shielded.

Symbol indicating functional ground on the B&R device: 

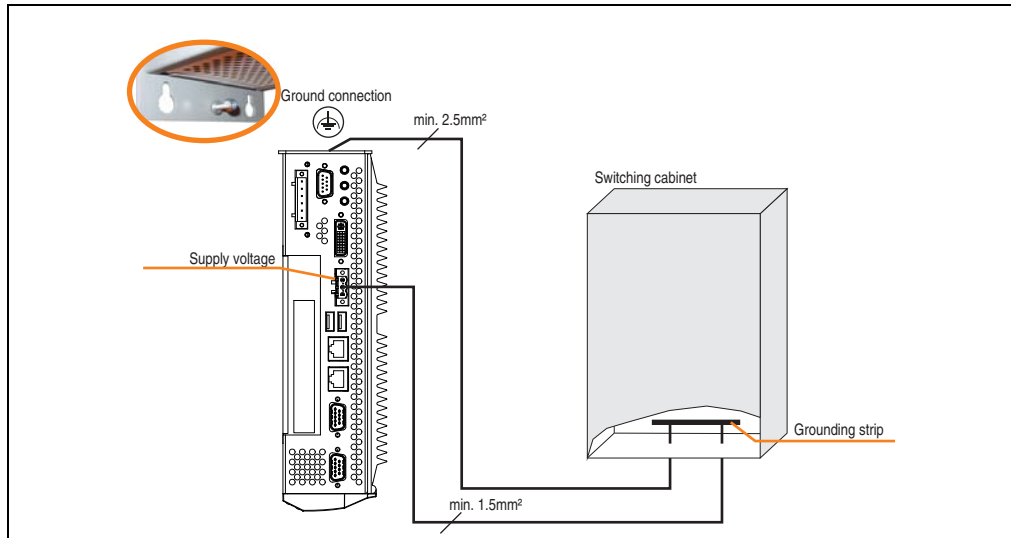

Figure 146: Grounding concept

## 4. Connection examples

The following examples provide an overview of the configuration options for connecting Automation Panel 800 and Automation Panel 900 and/or Automation Panel 800 devices with the APC620. The following questions will be answered:

- How are Automation Panel 900 devices connected to the monitor / panel output of the APC620, and what needs to be considered?
- How are Automation Panel 800 devices connected to the monitor / panel output of the APC620, and what needs to be considered?
- How are Automation Panel 900 devices connected simultaneously to the Monitor / Panel output on the optional SDL AP Link of the APC620 and what needs to be considered?
- What are "Display Clone" and "Extended Desktop" modes?
- How many Automation Panel 900 devices can be connected per line?
- How many Automation Panel 900 devices can be connected to an Automation Panel 800 device per line?
- How are the connected devices internally numbered?
- Are there limitations to the segment length and if so, what are they?
- What cables and link modules are needed?
- Do BIOS settings have to be changed for a specific configuration?

### Information:

**An RGB monitor / flat-screen can always be connected to the monitor / panel output of the APC620 (necessary DVI to CRT adapter can be ordered under the model number 5AC900.1000-00).**

## 4.1 Selecting the display units

If an Automation Panel 800 and an Automation Panel 900 should be connected on the same line, the devices must have the same display type.

The following table lists the AP900 devices that can be connected on the same line with an AP800 device.

Automation Panel 800	Automation Panel 900
5AP820.1505-00	5AP920.1505-01 5AP951.1505-01 5AP980.1505-01 5AP981.1505-01
5AP880.1505-00	5AP920.1505-01 5AP951.1505-01 5AP980.1505-01 5AP981.1505-01

Table 143: Selecting the display units

## 4.2 One Automation Panel 900 via DVI (onboard)

An Automation Panel 900 with max. SXGA resolution is connected to the integrated DVI interface (onboard). As an alternative, an office TFT with DVI interface or an analog monitor (using adapter with model no. 5AC900.1000-00) can also be operated. A separate cable is used for touch screen and USB. If USB devices are to be operated on the Automation Panel 900, the maximum distance is 5 meters. USB devices can only be connected directly to the Automation Panel (without a hub).

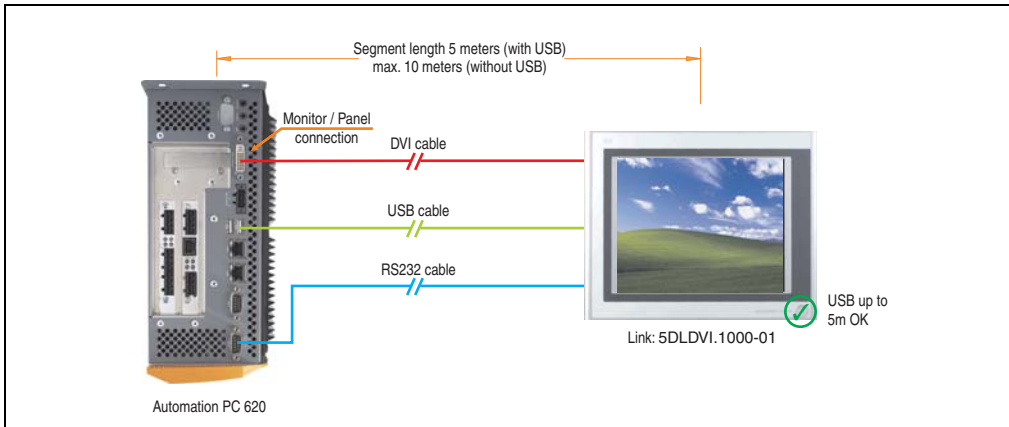

Figure 147: Configuration - One Automation Panel 900 via DVI (onboard)

### 4.2.1 Basic system requirements

The following table shows the possible combinations for the APC620 system unit with CPU board to implement the configuration shown in the figure above. If the maximum resolution is limited when making the combination then it is also shown in this table (e.g. for connecting a non-B&R Automation Panel 900 device).

CPU board	with system unit						Restriction Resolution
	5PC600.SX01-00	5PC600.SX02-00	5PC600.SX02-01	5PC600.SF03-00	5PC600.SX05-00	5PC600.SX05-01	
5PC600.E855-00 5PC600.X855-00	✓	✓	✓	✓	✓	✓	Max. SXGA
5PC600.E855-01 5PC600.X855-01	✓	✓	✓	✓	✓	✓	Max. SXGA
5PC600.E855-02 5PC600.X855-02	✓	✓	✓	✓	✓	✓	Max. SXGA
5PC600.E855-03 5PC600.X855-03	✓	✓	✓	✓	✓	✓	Max. SXGA
5PC600.E855-04 5PC600.X855-04	✓	✓	✓	✓	✓	✓	Max. SXGA
5PC600.E855-05 5PC600.X855-05	✓	✓	✓	✓	✓	✓	Max. SXGA

Table 144: Possible combinations of system unit and CPU board

## 4.2.2 Link modules

Model number	Description	Note
5DL DVI.1000-01	<b>Automation Panel Link DVI receiver</b> connections for DVI-D, RS232 and USB 2.0 (Type B); 24VDC (screw clamp 0TB103.9 or cage clamp 0TB103.91 sold separately).	For Automation Panel 900

Table 145: Link module for the configuration - One Automation Panel 900 via DVI

## 4.2.3 Cables

Select one cable each from the 3 required types.

Model number	Type	Length
5CADVI.0018-00	DVI cable	1.8 m
5CADVI.0050-00	DVI cable	5 m
5CADVI.0100-00	DVI cable	10 m <sup>1)</sup>
9A0014.02	Touch screen cable - serial	1.8 m
9A0014.05	Touch screen cable - serial	5 m
9A0014.10	Touch screen cable - serial	10 m <sup>1)</sup>
5CAUSB.0018-00	USB cable	1.8 m
5CAUSB.0050-00	USB cable	5 m

Table 146: Cables for DVI configurations

1) USB support is not possible on the Automation Panel 900 because USB is limited to 5 m.

## 4.2.4 Possible Automation Panel units, resolutions und segment lengths

The following Automation Panel 900 units can be used. In rare cases, the segment length is limited according to the resolution.

Model number	Diagonal	Resolution	Touch screen	Keys	Max. segment length
5AP920.1043-01	10.4"	VGA	✓	-	5 m / 10 m <sup>1)</sup>
5AP920.1214-01	12.1"	SVGA	✓	-	5 m / 10 m <sup>1)</sup>
5AP920.1505-01	15.0"	XGA	✓	-	5 m / 10 m <sup>1)</sup>
5AP920.1706-01	17.0"	SXGA	✓	-	5 m / 10 m <sup>1)</sup>
5AP920.1906-01	19.0"	SXGA	✓	-	5 m / 10 m <sup>1)</sup>

Table 147: Possible Automation Panel units, resolutions und segment lengths

1) USB support is not possible on the Automation Panel 900 because USB is limited to 5 m.

### Information:

The DVI transfer mode does not allow reading statistical values on Automation Panel 900 units.

### 4.2.5 BIOS settings

No special BIOS settings are necessary for operation.

### 4.2.6 Windows graphics driver settings

See chapter 4 "Software", section 5 "Automation PC 620 with Windows XP Professional", on page 568.

### 4.2.7 Windows touch screen driver settings

See chapter 4 "Software", section 5 "Automation PC 620 with Windows XP Professional", on page 568.



### 4.3 An Automation Panel 900 via SDL (onboard)

An Automation Panel 900 is connected to the integrated SDL interface (onboard) via an SDL cable. USB devices can only be connected directly to the Automation Panel (without a hub).

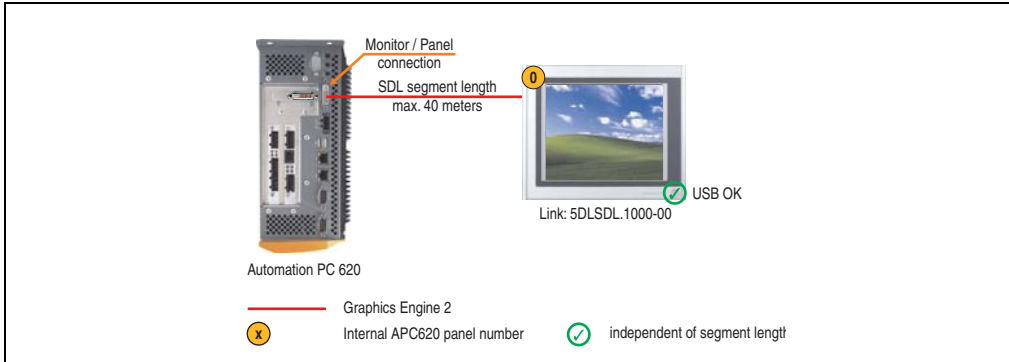

Figure 148: Configuration - An Automation Panel 900 via SDL (onboard)

#### 4.3.1 Basic system requirements

The following table shows the possible combinations for the APC620 system unit with CPU board to implement the configuration shown in the figure above. If the maximum resolution is limited when making the combination then it is also shown in this table (e.g. for connecting a non-B&R Automation Panel 900 device).

CPU board	with system unit						Restriction Resolution
	5PC600.SX01-00	5PC600.SX02-00	5PC600.SX02-01	5PC600.SF03-00	5PC600.SX05-00	5PC600.SX05-01	
5PC600.E855-00 5PC600.X855-00	✓	✓	✓	✓	✓	✓	Max. UXGA
5PC600.E855-01 5PC600.X855-01	✓	✓	✓	✓	✓	✓	Max. UXGA
5PC600.E855-02 5PC600.X855-02	✓	✓	✓	✓	✓	✓	Max. UXGA
5PC600.E855-03 5PC600.X855-03	✓	✓	✓	✓	✓	✓	Max. UXGA
5PC600.E855-04 5PC600.X855-04	✓	✓	✓	✓	✓	✓	Max. UXGA
5PC600.E855-05 5PC600.X855-05	✓	✓	✓	✓	✓	✓	Max. UXGA

Table 148: Possible combinations of system unit and CPU board

### 4.3.2 Link modules

Model number	Description	Note
5DLSDL.1000-00	<b>Automation Panel Link SDL receiver</b> Connection for SDL in, transfer of display data, touch screen, USB 1.1, matrix keys, and service data, 24 VDC (screw clamp 0TB103.9 or cage clamp 0TB103.91 sold separately).	For Automation Panel 900

Table 149: Link module for the configuration - One Automation Panel 900 via SDL

### 4.3.3 Cables

Select a cable from the following table.

Model number	Type	Length
5CASDL.0018-00	SDL cable for a fixed type of layout	1.8 m
5CASDL.0018-01	SDL cable with 45° plug for fixed type of layout	1.8 m
5CASDL.0018-03	SDL cable for fixed and flexible type of layout	1.8 m
5CASDL.0050-00	SDL cable for a fixed type of layout	5 m
5CASDL.0050-01	SDL cable with 45° plug for fixed type of layout	5 m
5CASDL.0050-03	SDL cable for fixed and flexible type of layout	5 m
5CASDL.0100-00	SDL cable for a fixed type of layout	10 m
5CASDL.0100-01	SDL cable with 45° plug for fixed type of layout	10 m
5CASDL.0100-03	SDL cable for fixed and flexible type of layout	10 m
5CASDL.0150-00	SDL cable for a fixed type of layout	15 m
5CASDL.0150-01	SDL cable with 45° plug for fixed type of layout	15 m
5CASDL.0150-03	SDL cable for fixed and flexible type of layout	15 m
5CASDL.0200-00	SDL cable for a fixed type of layout	20 m
5CASDL.0200-03	SDL cable for fixed and flexible type of layout	20 m
5CASDL.0250-00	SDL cable for a fixed type of layout	25 m
5CASDL.0250-30	SDL cable for fixed and flexible type of layout	25 m
5CASDL.0300-00	SDL cable for a fixed type of layout	30 m
5CASDL.0300-03	SDL cable for fixed and flexible type of layout	30 m
5CASDL.0300-10	SDL cable with extender for a fixed type of layout	30 m
5CASDL.0300-13	SDL cable with extender for fixed and flexible type of layout	30 m
5CASDL.0400-10	SDL cable with extender for a fixed type of layout	40 m
5CASDL.0400-13	SDL cable with extender for fixed and flexible type of layout	40 m

Table 150: Cables for SDL configurations

Cable lengths and resolutions for SDL transfer

The following table shows the relationship between segment lengths and the maximum resolution according to the SDL cable used:

Cables Segment length [m]	Resolution				
	VGA 640 x 480	SVGA 800 x 600	XGA 1024 x 768	SXGA 1280 x 1024	UXGA 1600 x 1200
1.8	5CASDL.0018-00 5CASDL.0018-01 5CASDL.0018-03	5CASDL.0018-00 5CASDL.0018-01 5CASDL.0018-03	5CASDL.0018-00 5CASDL.0018-01 5CASDL.0018-03	5CASDL.0018-00 5CASDL.0018-01 5CASDL.0018-03	5CASDL.0018-00 5CASDL.0018-01 5CASDL.0018-03
5	5CASDL.0050-00 5CASDL.0050-01 5CASDL.0050-03	5CASDL.0050-00 5CASDL.0050-01 5CASDL.0050-03	5CASDL.0050-00 5CASDL.0050-01 5CASDL.0050-03	5CASDL.0050-00 5CASDL.0050-01 5CASDL.0050-03	5CASDL.0050-00 5CASDL.0050-01 5CASDL.0050-03
10	5CASDL.0100-00 5CASDL.0100-01 5CASDL.0100-03	5CASDL.0100-00 5CASDL.0100-01 5CASDL.0100-03	5CASDL.0100-00 5CASDL.0100-01 5CASDL.0100-03	5CASDL.0100-00 5CASDL.0100-01 5CASDL.0100-03	5CASDL.0100-00 <sup>1)</sup> 5CASDL.0100-01 <sup>1)</sup> 5CASDL.0100-03 <sup>1)</sup>
15	5CASDL.0150-00 5CASDL.0150-01 5CASDL.0150-03	5CASDL.0150-00 5CASDL.0150-01 5CASDL.0150-03	5CASDL.0150-00 5CASDL.0150-01 5CASDL.0150-03	5CASDL.0150-00 <sup>1)</sup> 5CASDL.0150-01 <sup>1)</sup> 5CASDL.0150-03 <sup>1)</sup>	- - -
20	5CASDL.0200-00 <sup>1)</sup> 5CASDL.0200-03 <sup>1)</sup>	5CASDL.0200-00 <sup>1)</sup> 5CASDL.0200-03 <sup>1)</sup>	5CASDL.0200-00 <sup>1)</sup> 5CASDL.0200-03 <sup>1)</sup>	5CASDL.0200-00 <sup>1)</sup> 5CASDL.0200-03 <sup>1)</sup>	- -
25	5CASDL.0250-00 <sup>1)</sup> 5CASDL.0250-03 <sup>1)</sup>	5CASDL.0250-00 <sup>1)</sup> 5CASDL.0250-03 <sup>1)</sup>	5CASDL.0250-00 <sup>1)</sup> 5CASDL.0250-03 <sup>1)</sup>	- -	- -
30	5CASDL.0300-00 <sup>1)</sup> 5CASDL.0300-03 <sup>1)</sup>	5CASDL.0300-00 <sup>1)</sup> 5CASDL.0300-03 <sup>1)</sup>	5CASDL.0300-10 <sup>2)</sup> 5CASDL.0300-13 <sup>2)</sup>	5CASDL.0300-10 <sup>2)</sup> 5CASDL.0300-13 <sup>2)</sup>	- -
40	5CASDL.0400-10 <sup>2)</sup> 5CASDL.0400-13 <sup>2)</sup>	5CASDL.0400-10 <sup>2)</sup> 5CASDL.0400-13 <sup>2)</sup>	5CASDL.0400-10 <sup>2)</sup> 5CASDL.0400-13 <sup>2)</sup>	5CASDL.0400-10 <sup>2)</sup> 5CASDL.0400-13 <sup>2)</sup>	- -

Table 151: Segment lengths, resolutions and SDL cables

- 1) See table 152 "Requirements for SDL cable with automatic cable adjustment (equalizer)", on page 315
- 2) See table 153 "Requirements for SDL cable with extender and automatic cable adjustment (equalizer)", on page 316

The cable types and resolutions shown with a footnote 1) in the previous table can only be implemented starting with the following firmware and hardware versions:

Firmware	Name	Version	Note
MTCX FPGA	Firmware on the APC620	v 01.15	The version is read from BIOS - see the BIOS description. Supported starting with the APC620 / PPC 700 Firmware upgrade (MTCX, SDLR, SDLT) V01.10, available in the download area of the B&R homepage.
MTCX PX32	Firmware on the APC620	v 01.55	
SDLR FPGA	Firmware on the AP Link SDL receiver and transceiver	v 01.04	
SDLT FPGA	Firmware on the AP Link SDL transmitter	v 00.02	
Hardware	Name	Revision	Note
5DLSDL.1000-00	AP Link SDL receiver	Rev. B0	
5DLSDL.1000-01	AP Link SDL transceiver	Rev. B0	

Table 152: Requirements for SDL cable with automatic cable adjustment (equalizer)

## Commissioning • Connection examples

The cable types and resolutions shown with a footnote 2) in the previous table can only be implemented starting with the following firmware and hardware versions:

Firmware	Name	Version	Note
MTCX FPGA	Firmware on the APC620	v 01.15	The version is read from BIOS - see the BIOS description. Supported starting with the APC620 / PPC 700 Firmware upgrade (MTCX, SDLR, SDLT) <b>V01.10</b> , available in the download area of the B&R homepage.
MTCX PX32	Firmware on the APC620	v 01.55	
SDLR FPGA	Firmware on the AP Link SDL receiver and transceiver	v 01.04	
SDLT FPGA	Firmware on the AP Link SDL transmitter	v 00.02	
Hardware	Name	Revision	Note
5DLSDL.1000-00	AP Link SDL receiver	Rev. D0	
5DLSDL.1000-01	AP Link SDL transceiver	Rev. D0	
5AC600.SDL0-00	AP Link SDL transmitter	Rev. B3	
5PC600.SX01-00	System 1 PCI	Rev. E0	
5PC600.SX02-00	System 2 PCI, 1 disk drive slot, 1 AP Link slot	Rev. D0	
5PC600.SX02-01	System 2 PCI, 1 disk drive slot	Rev. E0	
5PC600.SF03-00	System 3 PCI, 1 disk drive slot, 1 AP Link slot	Rev. A0	
5PC600.SX05-00	System 5 PCI, 2 disk drive slots, 1 AP Link slot	Rev. C0	
5PC600.SX05-01	System 5 PCI, 2 disk drive slots	Rev. C0	

Table 153: Requirements for SDL cable with extender and automatic cable adjustment (equalizer)

### 4.3.4 BIOS settings

No special BIOS settings are necessary for operation without touch.

To operate Automation Panel 900 panels with a touch screen (Extended Desktop or Dual Display Clone), the serial interfaces COM C and COM D must be activated in BIOS (BIOS default setting = disabled).

### 4.3.5 Windows graphics driver settings

"Digital display" must be defined as output device in the graphics driver.

For more information on this, see chapter 4 "Software", section 5 "Automation PC 620 with Windows XP Professional", on page 568.

### 4.3.6 Windows touch screen driver settings

For more information on this, see chapter 4 "Software", section 5 "Automation PC 620 with Windows XP Professional", on page 568.

### 4.4 An Automation Panel 800 via SDL (onboard)

An Automation Panel 800 is connected to the integrated SDL interface (onboard) via an SDL cable. USB devices can only be connected directly to the extension keyboard (without a hub).

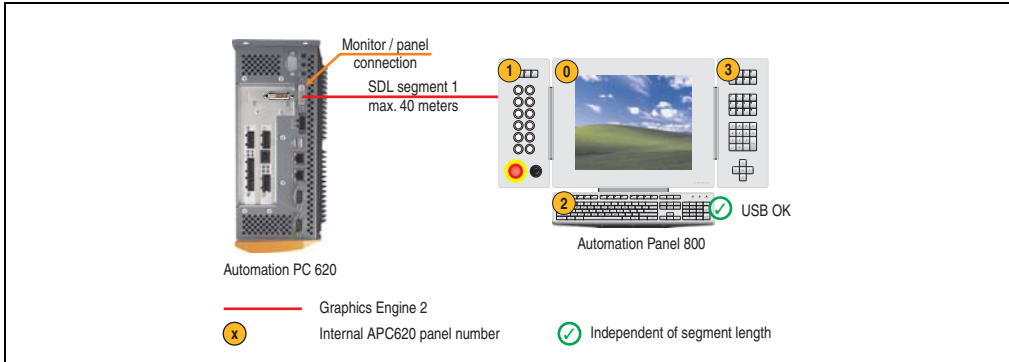

Figure 149: Configuration - An Automation Panel 800 via SDL (onboard)

#### 4.4.1 Basic system requirements

The following table shows the possible combinations for the APC620 system unit with CPU board to implement the configuration shown in the figure above. If the maximum resolution is limited when making the combination then it is also shown in this table.

CPU board	with system unit						Restriction Resolution
	5PC600.SX01-00	5PC600.SX02-00	5PC600.SX02-01	5PC600.SF03-00	5PC600.SX05-00	5PC600.SX05-01	
5PC600.E855-00 5PC600.X855-00	✓	✓	✓	✓	✓	✓	max. XGA
5PC600.E855-01 5PC600.X855-01	✓	✓	✓	✓	✓	✓	max. XGA
5PC600.E855-02 5PC600.X855-02	✓	✓	✓	✓	✓	✓	max. XGA
5PC600.E855-03 5PC600.X855-03	✓	✓	✓	✓	✓	✓	max. XGA
5PC600.E855-04 5PC600.X855-04	✓	✓	✓	✓	✓	✓	max. XGA
5PC600.E855-05 5PC600.X855-05	✓	✓	✓	✓	✓	✓	max. XGA

Table 154: Possible combinations of system unit and CPU board

#### 4.4.2 Cables

Select an SDL cable from the following table.

Model number	Type	Length
5CASDL.0018-20	SDL w/o extender	1.8 m
5CASDL.0050-20	SDL w/o extender	5 m
5CASDL.0100-20	SDL w/o extender	10 m
5CASDL.0150-20	SDL w/o extender	15 m
5CASDL.0200-20	SDL w/o extender	20 m
5CASDL.0250-20	SDL w/o extender	25 m
5CASDL.0300-30	SDL w/ extender	30 m
5CASDL.0400-30	SDL w/ extender	40 m

Table 155: Cables for SDL configurations

#### Cable lengths and resolutions for SDL transfer

The following table shows the relationship between segment lengths and the maximum resolution according to the SDL cable used:

Cables Segment length [m]	Resolution
	XGA 1024 x 768
1.8	5CASDL.0018-20
5	5CASDL.0050-20
10	5CASDL.0100-20
15	5CASDL.0150-20
20	5CASDL.0200-20 <sup>1)</sup>
25	5CASDL.0250-20 <sup>1)</sup>
30	5CASDL.0300-30 <sup>2)</sup>
40	5CASDL.0400-30 <sup>2)</sup>

Table 156: Segment lengths, resolutions and SDL cables

- 1) See table 157 "Requirements for SDL cable with automatic cable adjustment (equalizer)"
- 2) See table 158 "Requirements for SDL cable with extender and automatic cable adjustment (equalizer)"

The cable types and resolutions shown with a footnote 1) in the previous table can only be implemented starting with the following firmware and hardware versions:

Firmware	Name	Version	Note
MTCX FPGA	Firmware on the APC620	v 01.15	The version is read from BIOS - see the BIOS description. Supported starting with the APC620 / PPC 700 Firmware upgrade (MTCX, SDLR, SDLT) <b>V01.10</b> , available in the download area of the B&R homepage.
MTCX PX32	Firmware on the APC620	v 01.55	

Table 157: Requirements for SDL cable with automatic cable adjustment (equalizer)

The cable types and resolutions shown with a footnote 2) in the previous table can only be implemented starting with the following firmware and hardware versions:

Firmware	Name	Version	Note
MTCX FPGA	Firmware on the APC620	v 01.15	The version is read from BIOS - see the BIOS description. Supported starting with the APC620 / PPC 700 Firmware upgrade (MTCX, SDLR, SDLT) <b>V01.10</b> , available in the download area of the B&R homepage.
MTCX PX32	Firmware on the APC620	v 01.55	
Hardware	Name	Revision	Note
5PC600.SX01-00	System 1 PCI	Rev. E0	-
5PC600.SX02-00	System 2 PCI, 1 disk drive slot, 1 AP Link slot	Rev. D0	-
5PC600.SX02-01	System 2 PCI, 1 disk drive slot	Rev. E0	-
5PC600.SF03-00	System 3 PCI, 1 disk drive slot, 1 AP Link slot	Rev. A0	-
5PC600.SX05-00	System 5 PCI, 2 disk drive slots, 1 AP Link slot	Rev. C0	-
5PC600.SX05-01	System 5 PCI, 2 disk drive slots	Rev. C0	-

Table 158: Requirements for SDL cable with extender and automatic cable adjustment (equalizer)

### 4.4.3 BIOS settings

No special BIOS settings are necessary for operation.

### 4.4.4 Windows graphics driver settings

"Digital display" must be defined as output device in the graphics driver.

For more information on this, see chapter 4 "Software", section 5 "Automation PC 620 with Windows XP Professional", on page 568.

### 4.4.5 Windows touch screen driver settings

For more information on this, see chapter 4 "Software", section 5 "Automation PC 620 with Windows XP Professional", on page 568.

## 4.5 An AP900 and an AP800 via SDL (onboard)

An Automation Panel 900 and an Automation Panel 800 are connected to the integrated SDL interface (onboard) via SDL.

USB is supported up to a maximum distance (segment 1 + segment 2) of 30 m on the two displays. Starting at a distance of 30 m, USB is only available on the first display (front and back) up to a maximum of 40 m. USB devices can only be connected directly to the Automation Panel 900 or extension keyboard (without a hub).

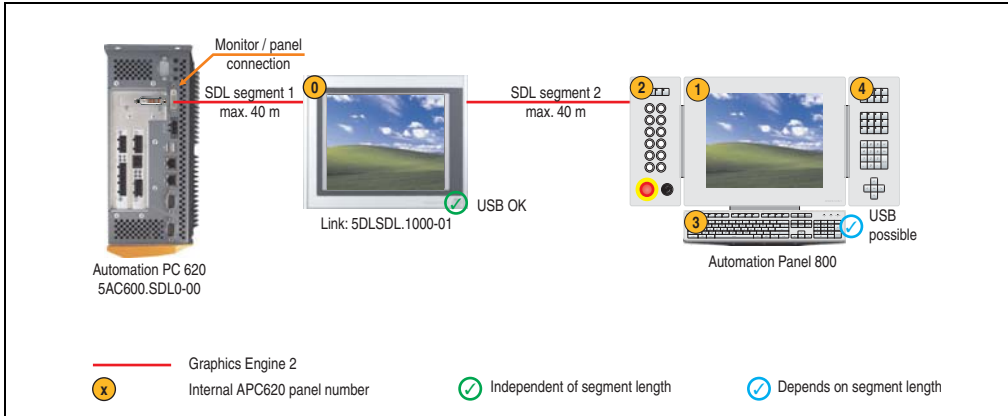

Figure 150: Configuration - One AP900 and an AP800 via SDL (onboard)

### 4.5.1 Basic system requirements

The following table shows the possible combinations for the APC620 system unit with CPU board to implement the configuration shown in the figure above. If the maximum resolution is limited when making the combination then it is also shown in this table.

CPU board	with system unit						Restriction Resolution
	5PC600.SX01-00	5PC600.SX02-00	5PC600.SX02-01	5PC600.SF03-00	5PC600.SX05-00	5PC600.SX05-01	
5PC600.E855-00 5PC600.X855-00	✓	✓	✓	✓	✓	✓	Max. UXGA
5PC600.E855-01 5PC600.X855-01	✓	✓	✓	✓	✓	✓	Max. UXGA
5PC600.E855-02 5PC600.X855-02	✓	✓	✓	✓	✓	✓	Max. UXGA
5PC600.E855-03 5PC600.X855-03	✓	✓	✓	✓	✓	✓	Max. UXGA
5PC600.E855-04 5PC600.X855-04	✓	✓	✓	✓	✓	✓	Max. UXGA
5PC600.E855-05 5PC600.X855-05	✓	✓	✓	✓	✓	✓	Max. UXGA

Table 159: Possible combinations of system unit and CPU board



### 4.5.2 Cables

How to select an SDL cable for connecting the AP900 display to the AP900 display 4.3 "An Automation Panel 900 via SDL (onboard)".

How to select an SDL cable for connecting the AP800 display to the AP900 display 4.4 "An Automation Panel 800 via SDL (onboard)".

### Cable lengths and resolutions for SDL transfer

The following table shows the relationship between segment lengths and the maximum resolution according to the SDL cable used:

Cables Segment length [m]	Resolution
	XGA 1024 x 768
1.8	5CASDL.0018-20
5	5CASDL.0050-20
10	5CASDL.0100-20
15	5CASDL.0150-20
20	5CASDL.0200-20 <sup>1)</sup>
25	5CASDL.0250-20 <sup>1)</sup>
30	5CASDL.0300-30 <sup>2)</sup>
40	5CASDL.0400-30 <sup>2)</sup>

Table 160: Segment lengths, resolutions and SDL cables

1) See table 161 "Requirements for SDL cable with automatic cable adjustment (equalizer)"

2) See table 162 "Requirements for SDL cable with extender and automatic cable adjustment (equalizer)"

The cable types and resolutions shown with a footnote 1) in the previous table can only be implemented starting with the following firmware and hardware versions:

Firmware	Name	Version	Note
MTCX FPGA	Firmware on the APC620	v 01.15	The version is read from BIOS - see the BIOS description.
MTCX PX32	Firmware on the APC620	v 01.55	Supported starting with the APC620 / PPC 700 Firmware upgrade (MTCX, SDLR, SDLT) <b>V01.10</b> , available in the download area of the B&R homepage.

Table 161: Requirements for SDL cable with automatic cable adjustment (equalizer)

## Commissioning • Connection examples

The cable types and resolutions shown with a footnote 2) in the previous table can only be implemented starting with the following firmware and hardware versions:

Firmware	Name	Version	Note
MTCX FPGA	Firmware on the APC620	v 01.15	The version is read from BIOS - see the BIOS description. Supported starting with the APC620 / PPC 700 Firmware upgrade (MTCX, SDLR, SDLT) <b>V01.10</b> , available in the download area of the B&R homepage.
MTCX PX32	Firmware on the APC620	v 01.55	
Hardware	Name	Revision	Note
5PC600.SX01-00	System 1 PCI	Rev. E0	-
5PC600.SX02-00	System 2 PCI, 1 disk drive slot, 1 AP Link slot	Rev. D0	-
5PC600.SX02-01	System 2 PCI, 1 disk drive slot	Rev. E0	-
5PC600.SF03-00	System 3 PCI, 1 disk drive slot, 1 AP Link slot	Rev. A0	-
5PC600.SX05-00	System 5 PCI, 2 disk drive slots, 1 AP Link slot	Rev. C0	-
5PC600.SX05-01	System 5 PCI, 2 disk drive slots	Rev. C0	-

Table 162: Requirements for SDL cable with extender and automatic cable adjustment (equalizer)

### 4.5.3 BIOS settings

No special BIOS settings are necessary for operation.

### 4.5.4 Windows graphics driver settings

"Digital display" must be defined as output device in the graphics driver.

For more information on this, see chapter 4 "Software", section 5 "Automation PC 620 with Windows XP Professional", on page 568.

### 4.5.5 Windows touch screen driver settings

For more information on this, see chapter 4 "Software", section 5 "Automation PC 620 with Windows XP Professional", on page 568.

## 4.6 Four Automation Panel 900 units via SDL (onboard)

An Automation Panel 900 is connected to the integrated SDL interface (onboard) via an SDL cable. Up to three other Automation Panels of the same type are connected to this Automation Panel and operated via SDL. All four panels show the same content (Display Clone).

USB is supported up to a maximum distance (SDL segment 1 + SDL segment 2) of 30 m on the first two panels (front and back side). From a distance of 30 m and longer, USB is only available for the first panel (front and back side). USB devices can only be connected directly to the Automation Panel (without a hub).

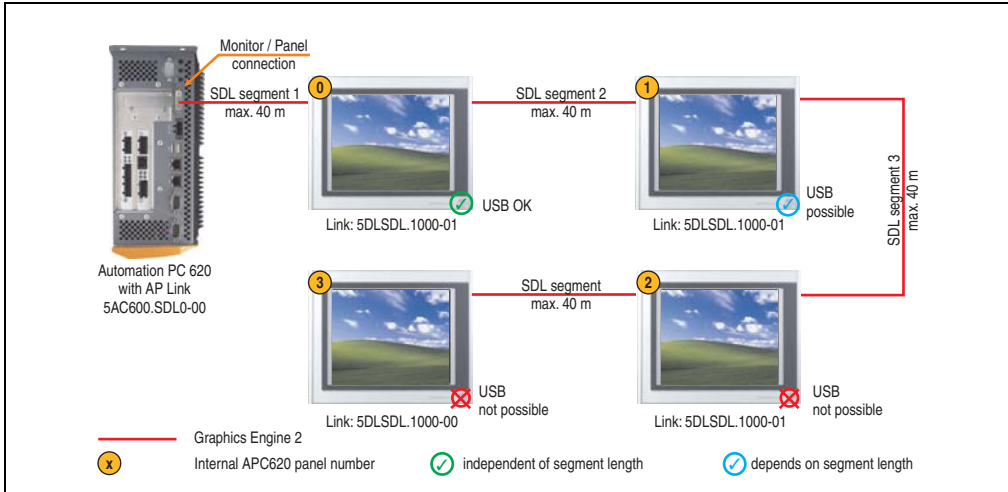

Figure 151: Configuration - Four Automation Panel 900 units via SDL (onboard)

### 4.6.1 Basic system requirements

The following table shows the possible combinations for the APC620 system unit with CPU board to implement the configuration shown in the figure above. If the maximum resolution is limited when making the combination then it is also shown in this table (e.g. for connecting a non-B&R Automation Panel 900 device).

CPU board	with system unit						Restriction Resolution
	5PC600.SX01-00	5PC600.SX02-00	5PC600.SX02-01	5PC600.SF03-00	5PC600.SX05-00	5PC600.SX05-01	
5PC600.E855-00 5PC600.X855-00	✓	✓	✓	✓	✓	✓	Max. UXGA
5PC600.E855-01 5PC600.X855-01	✓	✓	✓	✓	✓	✓	Max. UXGA
5PC600.E855-02 5PC600.X855-02	✓	✓	✓	✓	✓	✓	Max. UXGA
5PC600.E855-03 5PC600.X855-03	✓	✓	✓	✓	✓	✓	Max. UXGA

Table 163: Possible combinations of system unit and CPU board

## Commissioning • Connection examples

CPU board	with system unit						Restriction Resolution
	5PC600.SX01-00	5PC600.SX02-00	5PC600.SX02-01	5PC600.SF03-00	5PC600.SX05-00	5PC600.SX05-01	
5PC600.E855-04 5PC600.X855-04	✓	✓	✓	✓	✓	✓	Max. UXGA
5PC600.E855-05 5PC600.X855-05	✓	✓	✓	✓	✓	✓	Max. UXGA

Table 163: Possible combinations of system unit and CPU board (Forts.)

### 4.6.2 Link modules

Model number	Description	Note
5DLSDL.1000-00	<b>Automation Panel Link SDL receiver</b> Connection for SDL in, transfer of display data, touch screen, USB 1.1, matrix keys, and service data, 24 VDC (screw clamp 0TB103.9 or cage clamp 0TB103.91 sold separately).	For Automation Panel 900
5DLSDL.1000-01	<b>Automation Panel Link SDL transceiver</b> Connections for SDL in, transfer of display data, touch screen, USB 1.1, matrix keys, and service data, 24 VDC (screw clamp 0TB103.9 or cage clamp 0TB103.91 sold separately).	For Automation Panel 900 3 pieces required

Table 164: Link modules for the configuration: 4 Automation Panel 900 via SDL on 1 line

### 4.6.3 Cables

Select an Automation Panel 900 cable from the following table.

Model number	Type	Length
5CASDL.0018-00	SDL cable for a fixed type of layout	1.8 m
5CASDL.0018-01	SDL cable with 45° plug for fixed type of layout	1.8 m
5CASDL.0018-03	SDL cable for fixed and flexible type of layout	1.8 m
5CASDL.0050-00	SDL cable for a fixed type of layout	5 m
5CASDL.0050-01	SDL cable with 45° plug for fixed type of layout	5 m
5CASDL.0050-03	SDL cable for fixed and flexible type of layout	5 m
5CASDL.0100-00	SDL cable for a fixed type of layout	10 m
5CASDL.0100-01	SDL cable with 45° plug for fixed type of layout	10 m
5CASDL.0100-03	SDL cable for fixed and flexible type of layout	10 m
5CASDL.0150-00	SDL cable for a fixed type of layout	15 m
5CASDL.0150-01	SDL cable with 45° plug for fixed type of layout	15 m
5CASDL.0150-03	SDL cable for fixed and flexible type of layout	15 m
5CASDL.0200-00	SDL cable for a fixed type of layout	20 m
5CASDL.0200-03	SDL cable for fixed and flexible type of layout	20 m
5CASDL.0250-00	SDL cable for a fixed type of layout	25 m
5CASDL.0250-30	SDL cable for fixed and flexible type of layout	25 m
5CASDL.0300-00	SDL cable for a fixed type of layout	30 m
5CASDL.0300-03	SDL cable for fixed and flexible type of layout	30 m

Table 165: Cables for SDL configurations

Model number	Type	Length
5CASDL.0300-10	SDL cable with extender for a fixed type of layout	30 m
5CASDL.0300-13	SDL cable with extender for fixed and flexible type of layout	30 m
5CASDL.0400-10	SDL cable with extender for a fixed type of layout	40 m
5CASDL.0400-13	SDL cable with extender for fixed and flexible type of layout	40 m

Table 165: Cables for SDL configurations

### Cable lengths and resolutions for SDL transfer

The following table shows the relationship between segment lengths and the maximum resolution according to the SDL cable used:

Cables Segment length [m]	Resolution				
	VGA 640 x 480	SVGA 800 x 600	XGA 1024 x 768	SXGA 1280 x 1024	UXGA 1600 x 1200
1.8	5CASDL.0018-00 5CASDL.0018-01 5CASDL.0018-03	5CASDL.0018-00 5CASDL.0018-01 5CASDL.0018-03	5CASDL.0018-00 5CASDL.0018-01 5CASDL.0018-03	5CASDL.0018-00 5CASDL.0018-01 5CASDL.0018-03	5CASDL.0018-00 5CASDL.0018-01 5CASDL.0018-03
5	5CASDL.0050-00 5CASDL.0050-01 5CASDL.0050-03	5CASDL.0050-00 5CASDL.0050-01 5CASDL.0050-03	5CASDL.0050-00 5CASDL.0050-01 5CASDL.0050-03	5CASDL.0050-00 5CASDL.0050-01 5CASDL.0050-03	5CASDL.0050-00 5CASDL.0050-01 5CASDL.0050-03
10	5CASDL.0100-00 5CASDL.0100-01 5CASDL.0100-03	5CASDL.0100-00 5CASDL.0100-01 5CASDL.0100-03	5CASDL.0100-00 5CASDL.0100-01 5CASDL.0100-03	5CASDL.0100-00 5CASDL.0100-01 5CASDL.0100-03	5CASDL.0100-00 <sup>1)</sup> 5CASDL.0100-01 <sup>1)</sup> 5CASDL.0100-03 <sup>1)</sup>
15	5CASDL.0150-00 5CASDL.0150-01 5CASDL.0150-03	5CASDL.0150-00 5CASDL.0150-01 5CASDL.0150-03	5CASDL.0150-00 5CASDL.0150-01 5CASDL.0150-03	5CASDL.0150-00 <sup>1)</sup> 5CASDL.0150-01 <sup>1)</sup> 5CASDL.0150-03 <sup>1)</sup>	- - -
20	5CASDL.0200-00 <sup>1)</sup> 5CASDL.0200-03 <sup>1)</sup>	5CASDL.0200-00 <sup>1)</sup> 5CASDL.0200-03 <sup>1)</sup>	5CASDL.0200-00 <sup>1)</sup> 5CASDL.0200-03 <sup>1)</sup>	5CASDL.0200-00 <sup>1)</sup> 5CASDL.0200-03 <sup>1)</sup>	--
25	5CASDL.0250-00 <sup>1)</sup> 5CASDL.0250-03 <sup>1)</sup>	5CASDL.0250-00 <sup>1)</sup> 5CASDL.0250-03 <sup>1)</sup>	5CASDL.0250-00 <sup>1)</sup> 5CASDL.0250-03 <sup>1)</sup>	- -	- -
30	5CASDL.0300-00 <sup>1)</sup> 5CASDL.0300-03 <sup>1)</sup>	5CASDL.0300-00 <sup>1)</sup> 5CASDL.0300-03 <sup>1)</sup>	5CASDL.0300-10 <sup>2)</sup> 5CASDL.0300-13 <sup>2)</sup>	5CASDL.0300-10 <sup>2)</sup> 5CASDL.0300-13 <sup>2)</sup>	-
40	5CASDL.0400-10 <sup>2)</sup> 5CASDL.0400-13 <sup>2)</sup>	5CASDL.0400-10 <sup>2)</sup> 5CASDL.0400-13 <sup>2)</sup>	5CASDL.0400-10 <sup>2)</sup> 5CASDL.0400-13 <sup>2)</sup>	5CASDL.0400-10 <sup>2)</sup> 5CASDL.0400-13 <sup>2)</sup>	-

Table 166: Segment lengths, resolutions and SDL cables

- 1) See table 167 "Requirements for SDL cable with automatic cable adjustment (equalizer)", on page 326
- 2) See table 168 "Requirements for SDL cable with extender and automatic cable adjustment (equalizer)", on page 326

## Commissioning • Connection examples

The cable types and resolutions shown with a footnote 1) in the previous table can only be implemented starting with the following firmware and hardware versions:

Firmware	Name	Version	Note
MTCX FPGA	Firmware on the APC620	v 01.15	The version is read from BIOS - see the BIOS description. Supported starting with the APC620 / PPC 700 Firmware upgrade (MTCX, SDLR, SDLT) <b>V01.10</b> , available in the download area of the B&R homepage.
MTCX PX32	Firmware on the APC620	v 01.55	
SDLR FPGA	Firmware on the AP Link SDL receiver and transceiver	v 01.04	
SDLT FPGA	Firmware on the AP Link SDL transmitter	v 00.02	
Hardware	Name	Revision	Note
5DLSDL.1000-00	AP Link SDL receiver	Rev. B0	
5DLSDL.1000-01	AP Link SDL transceiver	Rev. B0	

Table 167: Requirements for SDL cable with automatic cable adjustment (equalizer)

The cable types and resolutions shown with a footnote 2) in the previous table can only be implemented starting with the following firmware and hardware versions:

Firmware	Name	Version	Note
MTCX FPGA	Firmware on the APC620	v 01.15	The version is read from BIOS - see the BIOS description. Supported starting with the APC620 / PPC 700 Firmware upgrade (MTCX, SDLR, SDLT) <b>V01.10</b> , available in the download area of the B&R homepage.
MTCX PX32	Firmware on the APC620	v 01.55	
SDLR FPGA	Firmware on the AP Link SDL receiver and transceiver	v 01.04	
SDLT FPGA	Firmware on the AP Link SDL transmitter	v 00.02	
Hardware	Name	Revision	Note
5DLSDL.1000-00	AP Link SDL receiver	Rev. D0	
5DLSDL.1000-01	AP Link SDL transceiver	Rev. D0	
5AC600.SDL0-00	AP Link SDL transmitter	Rev. B3	
5PC600.SX01-00	System 1 PCI	Rev. E0	
5PC600.SX02-00	System 2 PCI, 1 disk drive slot, 1 AP Link slot	Rev. D0	
5PC600.SX02-01	System 2 PCI, 1 disk drive slot	Rev. E0	
5PC600.SF03-00	System 3 PCI, 1 disk drive slot, 1 AP Link slot	Rev. A0	
5PC600.SX05-00	System 5 PCI, 2 disk drive slots, 1 AP Link slot	Rev. C0	
5PC600.SX05-01	System 5 PCI, 2 disk drive slots	Rev. C0	

Table 168: Requirements for SDL cable with extender and automatic cable adjustment (equalizer)

#### 4.6.4 BIOS settings

No special BIOS settings are necessary for operation.

#### 4.6.5 Windows graphics driver settings

"Display Clone" must be defined as output device in the graphics driver, with "Digital Display" as primary device.

For more information on this, see chapter 4 "Software", section 5 "Automation PC 620 with Windows XP Professional", on page 568.

#### 4.6.6 Windows touch screen driver settings

For more information on this, see chapter 4 "Software", section 5 "Automation PC 620 with Windows XP Professional", on page 568.

## 4.7 One Automation Panel 900 unit via SDL (AP Link)

An Automation Panel 900 unit is connected to the optional SDL transmitter (AP Link) via an SDL cable. USB devices can only be connected directly to the Automation Panel (without a hub).

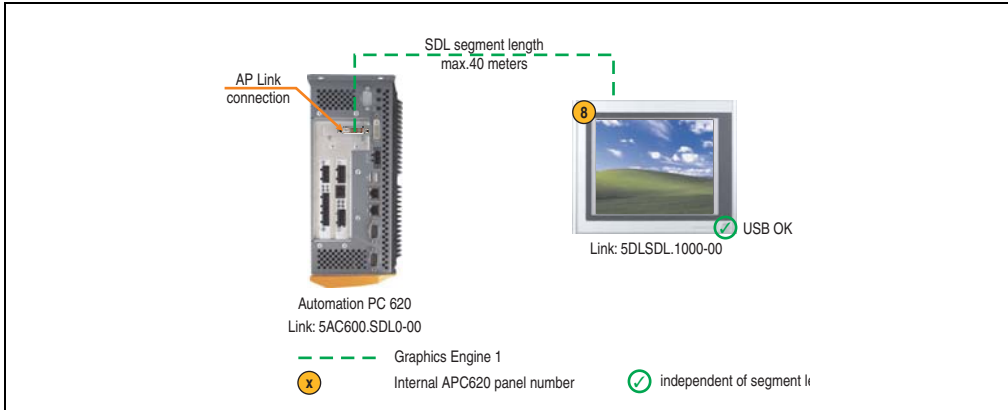

Figure 152: Configuration - One Automation Panel 900 via SDL (AP Link)

### 4.7.1 Basic system requirements

The following table shows the possible combinations for the APC620 system unit with CPU board to implement the configuration shown in the figure above. If the maximum resolution is limited when making the combination then it is also shown in this table (e.g. for connecting a non-B&R Automation Panel 900 device).

CPU board	with system unit						Restriction Resolution
	5PC600.SX01-00	5PC600.SX02-00	5PC600.SX02-01	5PC600.SF03-00	5PC600.SX05-00	5PC600.SX05-01	
5PC600.E855-00 5PC600.X855-00	-	✓	-	✓	✓	-	Max. UXGA
5PC600.E855-01 5PC600.X855-01	-	✓	-	✓	✓	-	Max. UXGA
5PC600.E855-02 5PC600.X855-02	-	✓	-	✓	✓	-	Max. UXGA
5PC600.E855-03 5PC600.X855-03	-	✓	-	✓	✓	-	Max. UXGA
5PC600.E855-04 5PC600.X855-04	-	✓	-	✓	✓	-	Max. UXGA
5PC600.E855-05 5PC600.X855-05	-	✓	-	✓	✓	-	Max. UXGA

Table 169: Possible combinations of system unit and CPU board



## 4.7.2 Link modules

Model number	Description	Note
5DLSDL.1000-00	<b>Automation Panel Link SDL receiver</b> Connection for SDL in, transfer of display data, touch screen, USB 1.1, matrix keys, and service data, 24 VDC (screw clamp 0TB103.9 or cage clamp 0TB103.91 sold separately).	For Automation Panel 900
5AC600.SDL0-00	<b>APC620 Smart Display Link transmitter</b> For connecting Automation Panels to an APC620 via SDL.	For Automation PC 620

Table 170: Link modules for the configuration: 1 Automation Panel 900 via SDL (optional)

## 4.7.3 Cables

Select a cable from the following table.

Model number	Type	Length
5CASDL.0018-00	SDL cable for a fixed type of layout	1.8 m
5CASDL.0018-01	SDL cable with 45° plug for fixed type of layout	1.8 m
5CASDL.0018-03	SDL cable for fixed and flexible type of layout	1.8 m
5CASDL.0050-00	SDL cable for a fixed type of layout	5 m
5CASDL.0050-01	SDL cable with 45° plug for fixed type of layout	5 m
5CASDL.0050-03	SDL cable for fixed and flexible type of layout	5 m
5CASDL.0100-00	SDL cable for a fixed type of layout	10 m
5CASDL.0100-01	SDL cable with 45° plug for fixed type of layout	10 m
5CASDL.0100-03	SDL cable for fixed and flexible type of layout	10 m
5CASDL.0150-00	SDL cable for a fixed type of layout	15 m
5CASDL.0150-01	SDL cable with 45° plug for fixed type of layout	15 m
5CASDL.0150-03	SDL cable for fixed and flexible type of layout	15 m
5CASDL.0200-00	SDL cable for a fixed type of layout	20 m
5CASDL.0200-03	SDL cable for fixed and flexible type of layout	20 m
5CASDL.0250-00	SDL cable for a fixed type of layout	25 m
5CASDL.0250-30	SDL cable for fixed and flexible type of layout	25 m
5CASDL.0300-00	SDL cable for a fixed type of layout	30 m
5CASDL.0300-03	SDL cable for fixed and flexible type of layout	30 m
5CASDL.0300-10	SDL cable with extender for a fixed type of layout	30 m
5CASDL.0300-13	SDL cable with extender for fixed and flexible type of layout	30 m
5CASDL.0400-10	SDL cable with extender for a fixed type of layout	40 m
5CASDL.0400-13	SDL cable with extender for fixed and flexible type of layout	40 m

Table 171: Cables for SDL configurations

Cable lengths and resolutions for SDL transfer

The following table shows the relationship between segment lengths and the maximum resolution according to the SDL cable used:

Cables Segment length [m]	Resolution				
	VGA 640 x 480	SVGA 800 x 600	XGA 1024 x 768	SXGA 1280 x 1024	UXGA 1600 x 1200
1.8	5CASDL.0018-00 5CASDL.0018-01 5CASDL.0018-03	5CASDL.0018-00 5CASDL.0018-01 5CASDL.0018-03	5CASDL.0018-00 5CASDL.0018-01 5CASDL.0018-03	5CASDL.0018-00 5CASDL.0018-01 5CASDL.0018-03	5CASDL.0018-00 5CASDL.0018-01 5CASDL.0018-03
5	5CASDL.0050-00 5CASDL.0050-01 5CASDL.0050-03	5CASDL.0050-00 5CASDL.0050-01 5CASDL.0050-03	5CASDL.0050-00 5CASDL.0050-01 5CASDL.0050-03	5CASDL.0050-00 5CASDL.0050-01 5CASDL.0050-03	5CASDL.0050-00 5CASDL.0050-01 5CASDL.0050-03
10	5CASDL.0100-00 5CASDL.0100-01 5CASDL.0100-03	5CASDL.0100-00 5CASDL.0100-01 5CASDL.0100-03	5CASDL.0100-00 5CASDL.0100-01 5CASDL.0100-03	5CASDL.0100-00 5CASDL.0100-01 5CASDL.0100-03	5CASDL.0100-00 <sup>1)</sup> 5CASDL.0100-01 <sup>1)</sup> 5CASDL.0100-03 <sup>1)</sup>
15	5CASDL.0150-00 5CASDL.0150-01 5CASDL.0150-03	5CASDL.0150-00 5CASDL.0150-01 5CASDL.0150-03	5CASDL.0150-00 5CASDL.0150-01 5CASDL.0150-03	5CASDL.0150-01 <sup>1)</sup> 5CASDL.0150-01 <sup>1)</sup> 5CASDL.0150-03 <sup>1)</sup>	- - -
20	5CASDL.0200-00 <sup>1)</sup> 5CASDL.0200-03 <sup>1)</sup>	5CASDL.0200-00 <sup>1)</sup> 5CASDL.0200-03 <sup>1)</sup>	5CASDL.0200-00 <sup>1)</sup> 5CASDL.0200-03 <sup>1)</sup>	5CASDL.0200-00 <sup>1)</sup> 5CASDL.0200-03 <sup>1)</sup>	- -
25	5CASDL.0250-00 <sup>1)</sup> 5CASDL.0250-03 <sup>1)</sup>	5CASDL.0250-00 <sup>1)</sup> 5CASDL.0250-03 <sup>1)</sup>	5CASDL.0250-00 <sup>1)</sup> 5CASDL.0250-03 <sup>1)</sup>	- -	- -
30	5CASDL.0300-00 <sup>1)</sup> 5CASDL.0300-03 <sup>1)</sup>	5CASDL.0300-00 <sup>1)</sup> 5CASDL.0300-03 <sup>1)</sup>	5CASDL.0300-10 <sup>2)</sup> 5CASDL.0300-13 <sup>2)</sup>	5CASDL.0300-10 <sup>2)</sup> 5CASDL.0300-13 <sup>2)</sup>	- -
40	5CASDL.0400-10 <sup>2)</sup> 5CASDL.0400-13 <sup>2)</sup>	5CASDL.0400-10 <sup>2)</sup> 5CASDL.0400-13 <sup>2)</sup>	5CASDL.0400-10 <sup>2)</sup> 5CASDL.0400-13 <sup>2)</sup>	5CASDL.0400-10 <sup>2)</sup> 5CASDL.0400-13 <sup>2)</sup>	- -

Table 172: Segment lengths, resolutions and SDL cables

- 1) See table 173 "Requirements for SDL cable with automatic cable adjustment (equalizer)", on page 330
- 2) See table 174 "Requirements for SDL cable with extender and automatic cable adjustment (equalizer)", on page 331

The cable types and resolutions shown with a footnote 1) in the previous table can only be implemented starting with the following firmware and hardware versions:

Firmware	Name	Version	Note
MTCX FPGA	Firmware on the APC620	v 01.15	The version is read from BIOS - see the BIOS description. Supported starting with the APC620 / PPC 700 Firmware upgrade (MTCX, SDLR, SDLT) V01.10, available in the download area of the B&R homepage.
MTCX PX32	Firmware on the APC620	v 01.55	
SDLR FPGA	Firmware on the AP Link SDL receiver and transceiver	v 01.04	
SDLT FPGA	Firmware on the AP Link SDL transmitter	v 00.02	
Hardware	Name	Revision	Note
5DLSDL.1000-00	AP Link SDL receiver	Rev. B0	
5DLSDL.1000-01	AP Link SDL transceiver	Rev. B0	

Table 173: Requirements for SDL cable with automatic cable adjustment (equalizer)

The cable types and resolutions shown with a footnote 2) in the previous table can only be implemented starting with the following firmware and hardware versions:

Firmware	Name	Version	Note
MTCX FPGA	Firmware on the APC620	v 01.15	The version is read from BIOS - see the BIOS description. Supported starting with the APC620 / PPC 700 Firmware upgrade (MTCX, SDLR, SDLT) <b>V01.10</b> , available in the download area of the B&R homepage.
MTCX PX32	Firmware on the APC620	v 01.55	
SDLR FPGA	Firmware on the AP Link SDL receiver and transceiver	v 01.04	
SDLT FPGA	Firmware on the AP Link SDL transmitter	v 00.02	
Hardware	Name	Revision	Note
5DLSDL.1000-00	AP Link SDL receiver	Rev. D0	
5DLSDL.1000-01	AP Link SDL transceiver	Rev. D0	
5AC600.SDL0-00	AP Link SDL transmitter	Rev. B3	
5PC600.SX01-00	System 1 PCI	Rev. E0	
5PC600.SX02-00	System 2 PCI, 1 disk drive slot, 1 AP Link slot	Rev. D0	
5PC600.SX02-01	System 2 PCI, 1 disk drive slot	Rev. E0	
5PC600.SF03-00	System 3 PCI, 1 disk drive slot, 1 AP Link slot	Rev. A0	
5PC600.SX05-00	System 5 PCI, 2 disk drive slots, 1 AP Link slot	Rev. C0	
5PC600.SX05-01	System 5 PCI, 2 disk drive slots	Rev. C0	

Table 174: Requirements for SDL cable with extender and automatic cable adjustment (equalizer)

#### 4.7.4 BIOS settings

No special BIOS settings are necessary for operation without touch.

To operate Automation Panel 900 panels with a touch screen (Extended Desktop or Dual Display Clone), the serial interfaces COM C and COM D must be activated in BIOS (BIOS default setting = disabled).

#### 4.7.5 Windows graphics driver settings

"Notebook" must be defined as output device in the graphics driver.

For more information on this, see chapter 4 "Software", section 5 "Automation PC 620 with Windows XP Professional", on page 568.

#### 4.7.6 Windows touch screen driver settings

For more information on this, see chapter 4 "Software", section 5 "Automation PC 620 with Windows XP Professional", on page 568.

## 4.8 Four Automation Panel 900 units via SDL (AP Link)

An Automation Panel 900 unit is connected to the optional SDL transmitter (AP Link) via an SDL cable. Three other Automation Panels of the same type are connected to this Automation Panel and operated via SDL. All four panels show the same content (Display Clone).

USB is supported up to a maximum distance (SDL segment 1 + SDL segment 2) of 30 m on the first two panels (front and back side). From a distance of 30 m and longer, USB is only available for the first panel (front and back side). USB devices can only be connected directly to the Automation Panel (without a hub).

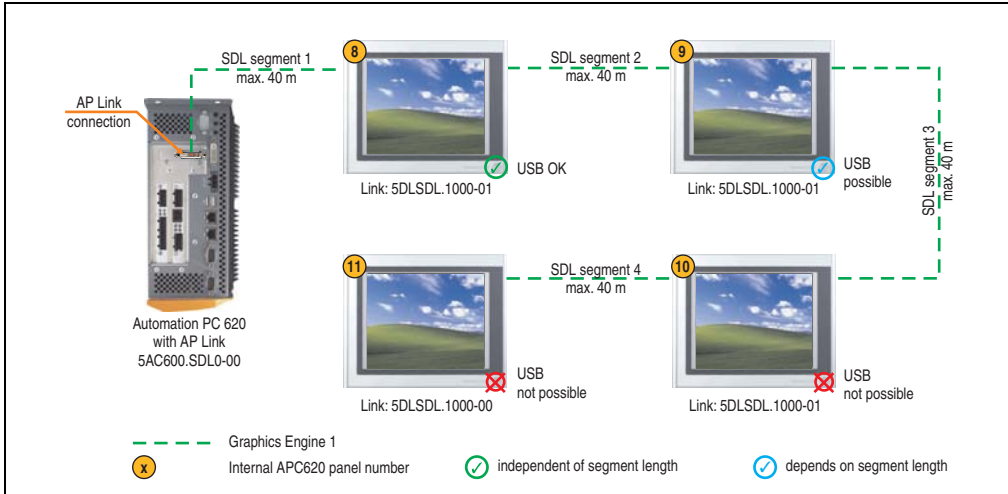

Figure 153: Configuration - 4 Automation Panel 900 units via SDL (AP Link)

### 4.8.1 Basic system requirements

The following table shows the possible combinations for the APC620 system unit with CPU board to implement the configuration shown in the figure above. If the maximum resolution is limited when making the combination then it is also shown in this table (e.g. for connecting a non-B&R Automation Panel 900 device).

CPU board	with system unit						Restriction Resolution
	5PC600.SX01-00	5PC600.SX02-00	5PC600.SX02-01	5PC600.SF03-00	5PC600.SX05-00	5PC600.SX05-01	
5PC600.E855-00 5PC600.X855-00	-	✓	-	✓	✓	-	Max. UXGA
5PC600.E855-01 5PC600.X855-01	-	✓	-	✓	✓	-	Max. UXGA
5PC600.E855-02 5PC600.X855-02	-	✓	-	✓	✓	-	Max. UXGA

Table 175: Possible combinations of system unit and CPU board

CPU board	with system unit						Restriction Resolution
	5PC600.SX01-00	5PC600.SX02-00	5PC600.SX02-01	5PC600.SF03-00	5PC600.SX05-00	5PC600.SX05-01	
5PC600.E855-03 5PC600.X855-03	-	✓	-	✓	✓	-	Max. UXGA
5PC600.E855-04 5PC600.X855-04	-	✓	-	✓	✓	-	Max. UXGA
5PC600.E855-05 5PC600.X855-05	-	✓	-	✓	✓	-	Max. UXGA

Table 175: Possible combinations of system unit and CPU board (Forts.)

#### 4.8.2 Link modules

Model number	Description	Note
5DLSDL.1000-00	<b>Automation Panel Link SDL receiver</b> Connection for SDL in, transfer of display data, touch screen, USB 1.1, matrix keys, and service data, 24 VDC (screw clamp 0TB103.9 or cage clamp 0TB103.91 sold separately).	For Automation Panel 900
5DLSDL.1000-01	<b>Automation Panel Link SDL transceiver</b> Connections for SDL in, transfer of display data, touch screen, USB 1.1, matrix keys, and service data, 24 VDC (screw clamp 0TB103.9 or cage clamp 0TB103.91 sold separately).	For Automation Panel 900 3 pieces required
5AC600.SDL0-00	<b>APC620 Smart Display Link transmitter</b> For connecting Automation Panels to an APC620 via SDL.	For Automation PC 620

Table 176: Link modules for configuration: 4 Automation Panel 900 units via SDL (optional) on 1 line

#### 4.8.3 Cables

Selection of 4 cables from the following tables.

Model number	Type	Length
5CASDL.0018-00	SDL cable for a fixed type of layout	1.8 m
5CASDL.0018-01	SDL cable with 45° plug for fixed type of layout	1.8 m
5CASDL.0018-03	SDL cable for fixed and flexible type of layout	1.8 m
5CASDL.0050-00	SDL cable for a fixed type of layout	5 m
5CASDL.0050-01	SDL cable with 45° plug for fixed type of layout	5 m
5CASDL.0050-03	SDL cable for fixed and flexible type of layout	5 m
5CASDL.0100-00	SDL cable for a fixed type of layout	10 m
5CASDL.0100-01	SDL cable with 45° plug for fixed type of layout	10 m
5CASDL.0100-03	SDL cable for fixed and flexible type of layout	10 m
5CASDL.0150-00	SDL cable for a fixed type of layout	15 m
5CASDL.0150-01	SDL cable with 45° plug for fixed type of layout	15 m
5CASDL.0150-03	SDL cable for fixed and flexible type of layout	15 m
5CASDL.0200-00	SDL cable for a fixed type of layout	20 m
5CASDL.0200-03	SDL cable for fixed and flexible type of layout	20 m
5CASDL.0250-00	SDL cable for a fixed type of layout	25 m

Table 177: Cables for SDL configurations

## Commissioning • Connection examples

Model number	Type	Length
5CASDL.0250-30	SDL cable for fixed and flexible type of layout	25 m
5CASDL.0300-00	SDL cable for a fixed type of layout	30 m
5CASDL.0300-03	SDL cable for fixed and flexible type of layout	30 m
5CASDL.0300-10	SDL cable with extender for a fixed type of layout	30 m
5CASDL.0300-13	SDL cable with extender for fixed and flexible type of layout	30 m
5CASDL.0400-10	SDL cable with extender for a fixed type of layout	40 m
5CASDL.0400-13	SDL cable with extender for fixed and flexible type of layout	40 m

Table 177: Cables for SDL configurations

### Cable lengths and resolutions for SDL transfer

The following table shows the relationship between segment lengths and the maximum resolution according to the SDL cable used:

Cables Segment length [m]	Resolution				
	VGA 640 x 480	SVGA 800 x 600	XGA 1024 x 768	SXGA 1280 x 1024	UXGA 1600 x 1200
1.8	5CASDL.0018-00 5CASDL.0018-01 5CASDL.0018-03	5CASDL.0018-00 5CASDL.0018-01 5CASDL.0018-03	5CASDL.0018-00 5CASDL.0018-01 5CASDL.0018-03	5CASDL.0018-00 5CASDL.0018-01 5CASDL.0018-03	5CASDL.0018-00 5CASDL.0018-01 5CASDL.0018-03
5	5CASDL.0050-00 5CASDL.0050-01 5CASDL.0050-03	5CASDL.0050-00 5CASDL.0050-01 5CASDL.0050-03	5CASDL.0050-00 5CASDL.0050-01 5CASDL.0050-03	5CASDL.0050-00 5CASDL.0050-01 5CASDL.0050-03	5CASDL.0050-00 5CASDL.0050-01 5CASDL.0050-03
10	5CASDL.0100-00 5CASDL.0100-01 5CASDL.0100-03	5CASDL.0100-00 5CASDL.0100-01 5CASDL.0100-03	5CASDL.0100-00 5CASDL.0100-01 5CASDL.0100-03	5CASDL.0100-00 5CASDL.0100-01 5CASDL.0100-03	5CASDL.0100-00 <sup>1)</sup> 5CASDL.0100-01 <sup>1)</sup> 5CASDL.0100-03 <sup>1)</sup>
15	5CASDL.0150-00 5CASDL.0150-01 5CASDL.0150-03	5CASDL.0150-00 5CASDL.0150-01 5CASDL.0150-03	5CASDL.0150-00 5CASDL.0150-01 5CASDL.0150-03	5CASDL.0150-00 <sup>1)</sup> 5CASDL.0150-01 <sup>1)</sup> 5CASDL.0150-03 <sup>1)</sup>	- - -
20	5CASDL.0200-00 <sup>1)</sup> 5CASDL.0200-03 <sup>1)</sup>	5CASDL.0200-00 <sup>1)</sup> 5CASDL.0200-03 <sup>1)</sup>	5CASDL.0200-00 <sup>1)</sup> 5CASDL.0200-03 <sup>1)</sup>	5CASDL.0200-00 <sup>1)</sup> 5CASDL.0200-03 <sup>1)</sup>	- -
25	5CASDL.0250-00 <sup>1)</sup> 5CASDL.0250-03 <sup>1)</sup>	5CASDL.0250-00 <sup>1)</sup> 5CASDL.0250-03 <sup>1)</sup>	5CASDL.0250-00 <sup>1)</sup> 5CASDL.0250-03 <sup>1)</sup>	- -	- -
30	5CASDL.0300-00 <sup>1)</sup> 5CASDL.0300-03 <sup>1)</sup>	5CASDL.0300-00 <sup>1)</sup> 5CASDL.0300-03 <sup>1)</sup>	5CASDL.0300-10 <sup>2)</sup> 5CASDL.0300-13 <sup>2)</sup>	5CASDL.0300-10 <sup>2)</sup> 5CASDL.0300-13 <sup>2)</sup>	-
40	5CASDL.0400-10 <sup>2)</sup> 5CASDL.0400-13 <sup>2)</sup>	5CASDL.0400-10 <sup>2)</sup> 5CASDL.0400-13 <sup>2)</sup>	5CASDL.0400-10 <sup>2)</sup> 5CASDL.0400-13 <sup>2)</sup>	5CASDL.0400-10 <sup>2)</sup> 5CASDL.0400-13 <sup>2)</sup>	-

Table 178: Segment lengths, resolutions and SDL cables

1) See table 179 "Requirements for SDL cable with automatic cable adjustment (equalizer)", on page 335

2) See table 180 "Requirements for SDL cable with extender and automatic cable adjustment (equalizer)", on page 335

## Commissioning • Connection examples

The cable types and resolutions shown with a footnote 1) in the previous table can only be implemented starting with the following firmware and hardware versions:

Firmware	Name	Version	Note
MTCX FPGA	Firmware on the APC620	v 01.15	The version is read from BIOS - see the BIOS description. Supported starting with the APC620 / PPC 700 Firmware upgrade (MTCX, SDLR, SDLT) <b>V01.10</b> , available in the download area of the B&R homepage.
MTCX PX32	Firmware on the APC620	v 01.55	
SDLR FPGA	Firmware on the AP Link SDL receiver and transceiver	v 01.04	
SDLT FPGA	Firmware on the AP Link SDL transmitter	v 00.02	
Hardware	Name	Revision	Note
5DLSDL.1000-00	AP Link SDL receiver	Rev. B0	
5DLSDL.1000-01	AP Link SDL transceiver	Rev. B0	

Table 179: Requirements for SDL cable with automatic cable adjustment (equalizer)

The cable types and resolutions shown with a footnote 2) in the previous table can only be implemented starting with the following firmware and hardware versions:

Firmware	Name	Version	Note
MTCX FPGA	Firmware on the APC620	v 01.15	The version is read from BIOS - see the BIOS description. Supported starting with the APC620 / PPC 700 Firmware upgrade (MTCX, SDLR, SDLT) <b>V01.10</b> , available in the download area of the B&R homepage.
MTCX PX32	Firmware on the APC620	v 01.55	
SDLR FPGA	Firmware on the AP Link SDL receiver and transceiver	v 01.04	
SDLT FPGA	Firmware on the AP Link SDL transmitter	v 00.02	
Hardware	Name	Revision	Note
5DLSDL.1000-00	AP Link SDL receiver	Rev. D0	
5DLSDL.1000-01	AP Link SDL transceiver	Rev. D0	
5AC600.SDL0-00	AP Link SDL transmitter	Rev. B3	
5PC600.SX01-00	System 1 PCI	Rev. E0	
5PC600.SX02-00	System 2 PCI, 1 disk drive slot, 1 AP Link slot	Rev. D0	
5PC600.SX02-01	System 2 PCI, 1 disk drive slot	Rev. E0	
5PC600.SF03-00	System 3 PCI, 1 disk drive slot, 1 AP Link slot	Rev. A0	
5PC600.SX05-00	System 5 PCI, 2 disk drive slots, 1 AP Link slot	Rev. C0	
5PC600.SX05-01	System 5 PCI, 2 disk drive slots	Rev. C0	

Table 180: Requirements for SDL cable with extender and automatic cable adjustment (equalizer)

#### **4.8.4 BIOS settings**

No special BIOS settings are necessary for operation.

#### **4.8.5 Windows graphics driver settings**

"Notebook" must be defined as output device in the graphics driver.

For more information on this, see chapter 4 "Software", section 5 "Automation PC 620 with Windows XP Professional", on page 568.

#### **4.8.6 Windows touch screen driver settings**

For more information on this, see chapter 4 "Software", section 5 "Automation PC 620 with Windows XP Professional", on page 568.



### 4.9 Two Automation Panel 900 units via SDL (onboard) and SDL (AP Link)

An Automation Panel 900 (max. UXGA) is connected to the integrated SDL interface (onboard) via an SDL cable. A second Automation Panel 900 (max. UXGA) is connected to the optional SDL transmitter (AP Link) via an SDL cable. The Automation Panels show different content (Extended Desktop) and can be different types.

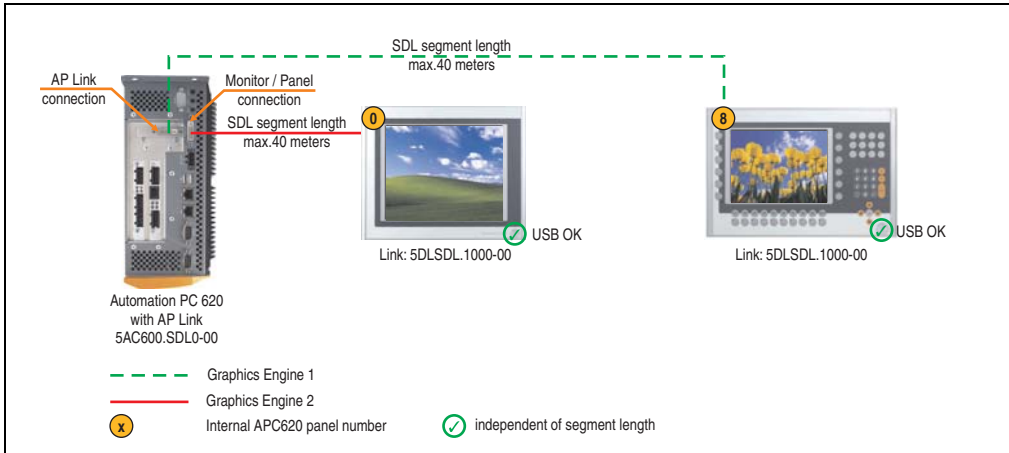

Figure 154: Configuration - Two Automation Panel 900 units via SDL (onboard) and SDL (AP Link)

#### 4.9.1 Basic system requirements

The following table shows the possible combinations for the APC620 system unit with CPU board to implement the configuration shown in the figure above. If the maximum resolution is limited when making the combination then it is also shown in this table (e.g. for connecting a non-B&R Automation Panel 900 device).

CPU board	with system unit						Restriction Resolution
	5PC600.SX01-00	5PC600.SX02-00	5PC600.SX02-01	5PC600.SF03-00	5PC600.SX05-00	5PC600.SX05-01	
5PC600.E855-00 5PC600.X855-00	-	✓	-	✓	✓	-	Max. UXGA
5PC600.E855-01 5PC600.X855-01	-	✓	-	✓	✓	-	Max. UXGA
5PC600.E855-02 5PC600.X855-02	-	✓	-	✓	✓	-	Max. UXGA
5PC600.E855-03 5PC600.X855-03	-	✓	-	✓	✓	-	Max. UXGA
5PC600.E855-04 5PC600.X855-04	-	✓	-	✓	✓	-	Max. UXGA
5PC600.E855-05 5PC600.X855-05	-	✓	-	✓	✓	-	Max. UXGA

Table 181: Possible combinations of system unit and CPU board

## 4.9.2 Link modules

Model number	Description	Note
5DLSDL.1000-00	<b>Automation Panel Link SDL receiver</b> Connection for SDL in, transfer of display data, touch screen, USB 1.1, matrix keys, and service data, 24 VDC (screw clamp 0TB103.9 or cage clamp 0TB103.91 sold separately).	For Automation Panel 900 2 pieces required
5AC600.SDL0-00	<b>APC620 Smart Display Link transmitter</b> For connecting Automation Panels to an APC620 via SDL.	For Automation PC 620

Table 182: Link modules for the configuration: 2 Automation Panel 900 units via SDL and SDL (optional)

## 4.9.3 Cables

Selection of 2 cables from the following tables.

Model number	Type	Length
5CASDL.0018-00	SDL cable for a fixed type of layout	1.8 m
5CASDL.0018-01	SDL cable with 45° plug for fixed type of layout	1.8 m
5CASDL.0018-03	SDL cable for fixed and flexible type of layout	1.8 m
5CASDL.0050-00	SDL cable for a fixed type of layout	5 m
5CASDL.0050-01	SDL cable with 45° plug for fixed type of layout	5 m
5CASDL.0050-03	SDL cable for fixed and flexible type of layout	5 m
5CASDL.0100-00	SDL cable for a fixed type of layout	10 m
5CASDL.0100-01	SDL cable with 45° plug for fixed type of layout	10 m
5CASDL.0100-03	SDL cable for fixed and flexible type of layout	10 m
5CASDL.0150-00	SDL cable for a fixed type of layout	15 m
5CASDL.0150-01	SDL cable with 45° plug for fixed type of layout	15 m
5CASDL.0150-03	SDL cable for fixed and flexible type of layout	15 m
5CASDL.0200-00	SDL cable for a fixed type of layout	20 m
5CASDL.0200-03	SDL cable for fixed and flexible type of layout	20 m
5CASDL.0250-00	SDL cable for a fixed type of layout	25 m
5CASDL.0250-30	SDL cable for fixed and flexible type of layout	25 m
5CASDL.0300-00	SDL cable for a fixed type of layout	30 m
5CASDL.0300-03	SDL cable for fixed and flexible type of layout	30 m
5CASDL.0300-10	SDL cable with extender for a fixed type of layout	30 m
5CASDL.0300-13	SDL cable with extender for fixed and flexible type of layout	30 m
5CASDL.0400-10	SDL cable with extender for a fixed type of layout	40 m
5CASDL.0400-13	SDL cable with extender for fixed and flexible type of layout	40 m

Table 183: Cables for SDL configurations

Cable lengths and resolutions for SDL transfer

The following table shows the relationship between segment lengths and the maximum resolution according to the SDL cable used:

Cables Segment length [m]	Resolution				
	VGA 640 x 480	SVGA 800 x 600	XGA 1024 x 768	SXGA 1280 x 1024	UXGA 1600 x 1200
1.8	5CASDL.0018-00 5CASDL.0018-01 5CASDL.0018-03	5CASDL.0018-00 5CASDL.0018-01 5CASDL.0018-03	5CASDL.0018-00 5CASDL.0018-01 5CASDL.0018-03	5CASDL.0018-00 5CASDL.0018-01 5CASDL.0018-03	5CASDL.0018-00 5CASDL.0018-01 5CASDL.0018-03
5	5CASDL.0050-00 5CASDL.0050-01 5CASDL.0050-03	5CASDL.0050-00 5CASDL.0050-01 5CASDL.0050-03	5CASDL.0050-00 5CASDL.0050-01 5CASDL.0050-03	5CASDL.0050-00 5CASDL.0050-01 5CASDL.0050-03	5CASDL.0050-00 5CASDL.0050-01 5CASDL.0050-03
10	5CASDL.0100-00 5CASDL.0100-01 5CASDL.0100-03	5CASDL.0100-00 5CASDL.0100-01 5CASDL.0100-03	5CASDL.0100-00 5CASDL.0100-01 5CASDL.0100-03	5CASDL.0100-00 5CASDL.0100-01 5CASDL.0100-03	5CASDL.0100-00 <sup>1)</sup> 5CASDL.0100-01 <sup>1)</sup> 5CASDL.0100-03 <sup>1)</sup>
15	5CASDL.0150-00 5CASDL.0150-01 5CASDL.0150-03	5CASDL.0150-00 5CASDL.0150-01 5CASDL.0150-03	5CASDL.0150-00 5CASDL.0150-01 5CASDL.0150-03	5CASDL.0150-00 <sup>1)</sup> 5CASDL.0150-01 <sup>1)</sup> 5CASDL.0150-03 <sup>1)</sup>	- - -
20	5CASDL.0200-00 <sup>1)</sup> 5CASDL.0200-03 <sup>1)</sup>	5CASDL.0200-00 <sup>1)</sup> 5CASDL.0200-03 <sup>1)</sup>	5CASDL.0200-00 <sup>1)</sup> 5CASDL.0200-03 <sup>1)</sup>	5CASDL.0200-00 <sup>1)</sup> 5CASDL.0200-03 <sup>1)</sup>	- -
25	5CASDL.0250-00 <sup>1)</sup> 5CASDL.0250-03 <sup>1)</sup>	5CASDL.0250-00 <sup>1)</sup> 5CASDL.0250-03 <sup>1)</sup>	5CASDL.0250-00 <sup>1)</sup> 5CASDL.0250-03 <sup>1)</sup>	- -	- -
30	5CASDL.0300-00 <sup>1)</sup> 5CASDL.0300-03 <sup>1)</sup>	5CASDL.0300-00 <sup>1)</sup> 5CASDL.0300-03 <sup>1)</sup>	5CASDL.0300-10 <sup>2)</sup> 5CASDL.0300-13 <sup>2)</sup>	5CASDL.0300-10 <sup>2)</sup> 5CASDL.0300-13 <sup>2)</sup>	- -
40	5CASDL.0400-10 <sup>2)</sup> 5CASDL.0400-13 <sup>2)</sup>	5CASDL.0400-10 <sup>2)</sup> 5CASDL.0400-13 <sup>2)</sup>	5CASDL.0400-10 <sup>2)</sup> 5CASDL.0400-13 <sup>2)</sup>	5CASDL.0400-10 <sup>2)</sup> 5CASDL.0400-13 <sup>2)</sup>	- -

Table 184: Segment lengths, resolutions and SDL cables

- 1) See table 185 "Requirements for SDL cable with automatic cable adjustment (equalizer)", on page 339
- 2) See table 186 "Requirements for SDL cable with extender and automatic cable adjustment (equalizer)", on page 340

The cable types and resolutions shown with a footnote 1) in the previous table can only be implemented starting with the following firmware and hardware versions:

Firmware	Name	Version	Note
MTCX FPGA	Firmware on the APC620	v 01.15	The version is read from BIOS - see the BIOS description. Supported starting with the APC620 / PPC 700 Firmware upgrade (MTCX, SDLR, SDLT) V01.10, & available in the download area of the B&R homepage.
MTCX PX32	Firmware on the APC620	v 01.55	
SDLR FPGA	Firmware on the AP Link SDL receiver and transceiver	v 01.04	
SDLT FPGA	Firmware on the AP Link SDL transmitter	v 00.02	
Hardware	Name	Revision	Note
5DLSDL.1000-00	AP Link SDL receiver	Rev. B0	
5DLSDL.1000-01	AP Link SDL transceiver	Rev. B0	

Table 185: Requirements for SDL cable with automatic cable adjustment (equalizer)

## Commissioning • Connection examples

The cable types and resolutions shown with a footnote 2) in the previous table can only be implemented starting with the following firmware and hardware versions:

Firmware	Name	Version	Note
MTCX FPGA	Firmware on the APC620	v 01.15	The version is read from BIOS - see the BIOS description. Supported starting with the APC620 / PPC 700 Firmware upgrade (MTCX, SDLR, SDLT) <b>V01.10</b> , available in the download area of the B&R homepage.
MTCX PX32	Firmware on the APC620	v 01.55	
SDLR FPGA	Firmware on the AP Link SDL receiver and transceiver	v 01.04	
SDLT FPGA	Firmware on the AP Link SDL transmitter	v 00.02	
Hardware	Name	Revision	Note
5DLSDL.1000-00	AP Link SDL receiver	Rev. D0	
5DLSDL.1000-01	AP Link SDL transceiver	Rev. D0	
5AC600.SDL0-00	AP Link SDL transmitter	Rev. B3	
5PC600.SX01-00	System 1 PCI	Rev. E0	
5PC600.SX02-00	System 2 PCI, 1 disk drive slot, 1 AP Link slot	Rev. D0	
5PC600.SX02-01	System 2 PCI, 1 disk drive slot	Rev. E0	
5PC600.SF03-00	System 3 PCI, 1 disk drive slot, 1 AP Link slot	Rev. A0	
5PC600.SX05-00	System 5 PCI, 2 disk drive slots, 1 AP Link slot	Rev. C0	
5PC600.SX05-01	System 5 PCI, 2 disk drive slots	Rev. C0	

Table 186: Requirements for SDL cable with extender and automatic cable adjustment (equalizer)

### 4.9.4 BIOS settings

No special BIOS settings are necessary for operation without touch.

To operate Automation Panel 900 panels with a touch screen (Extended Desktop or Dual Display Clone), the serial interfaces COM C and COM D must be activated in BIOS (BIOS default setting = disabled).

### 4.9.5 Windows graphics driver settings

See chapter 4 "Software", section 5 "Automation PC 620 with Windows XP Professional", on page 568.

If all connected Automation Panel 900 panels (line 1 + line 2) should display the same content, then "Dual Display Clone" mode must be set in the graphics driver (see chapter 4 "Software", section 5.2.4 "Graphics settings for Dual Display Clone", on page 575).

If all connected Automation Panel 900 panels (line 1 + line 2) should display the same content, then "Dual Display Clone" mode must be set in the graphics driver (see chapter 4 "Software", section 5.2.3 "Graphics settings for Extended Desktop", on page 573).

### 4.9.6 Windows touch screen driver settings

See chapter 4 "Software", section 5 "Automation PC 620 with Windows XP Professional", on page 568.

### 4.10 Eight Automation Panel 900 units via SDL (onboard) and SDL (AP Link)

Four Automation Panel 900 units (max. UXGA) are connected to the integrated SDL interface (onboard) via SDL. Four additional Automation Panel 900 units (max. UXGA) are connected to the optional SDL transmitter (AP Link). The Automation Panels in each line must be the same type. The two lines display different content (Extended Desktop), but panels in the same line show the same content (Display Clone).

USB is supported up to a maximum distance (SDL segment 1 + SDL segment 2) of 30 m on the first two panels (front and back side). From a distance of 30 m and longer, USB is only available for the first panel on each line. USB devices can only be connected directly to the Automation Panel (without hub).

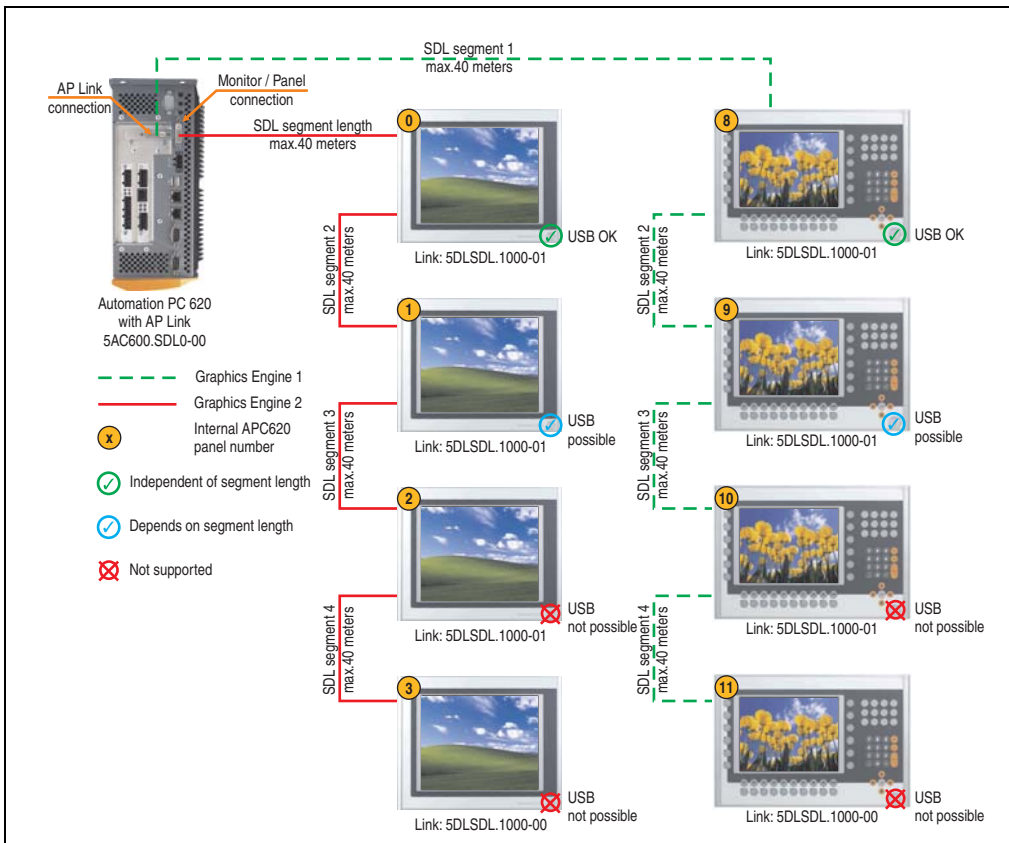

Figure 155: Configuration - Eight Automation Panel 900 units via SDL (onboard) and SDL (AP Link)

### 4.10.1 Basic system requirements

The following table shows the possible combinations for the APC620 system unit with CPU board to implement the configuration shown in the figure above. If the maximum resolution is limited when making the combination then it is also shown in this table (e.g. for connecting a non-B&R Automation Panel 900 device).

CPU board	with system unit						Restriction Resolution
	5PC600.SX01-00	5PC600.SX02-00	5PC600.SX02-01	5PC600.SF03-00	5PC600.SX05-00	5PC600.SX05-01	
5PC600.E855-00 5PC600.X855-00	-	✓	-	✓	✓	-	Max. UXGA
5PC600.E855-01 5PC600.X855-01	-	✓	-	✓	✓	-	Max. UXGA
5PC600.E855-02 5PC600.X855-02	-	✓	-	✓	✓	-	Max. UXGA
5PC600.E855-03 5PC600.X855-03	-	✓	-	✓	✓	-	Max. UXGA
5PC600.E855-04 5PC600.X855-04	-	✓	-	✓	✓	-	Max. UXGA
5PC600.E855-05 5PC600.X855-05	-	✓	-	✓	✓	-	Max. UXGA

Table 187: Possible combinations of system unit and CPU board

### 4.10.2 Link modules

Model number	Description	Note
5DLSDL.1000-00	<b>Automation Panel Link SDL receiver</b> Connection for SDL in, transfer of display data, touch screen, USB 1.1, matrix keys, and service data, 24 VDC (screw clamp 0TB103.9 or cage clamp 0TB103.91 sold separately).	For Automation Panel 900 2 pieces required
5DLSDL.1000-01	<b>Automation Panel Link SDL transceiver</b> Connections for SDL in, transfer of display data, touch screen, USB 1.1, matrix keys, and service data, 24 VDC (screw clamp 0TB103.9 or cage clamp 0TB103.91 sold separately).	For Automation Panel 900 6 pieces required
5AC600.SDL0-00	<b>APC620 Smart Display Link transmitter</b> For connecting Automation Panels to an APC620 via SDL.	For Automation PC 620 1 pieces required

Table 188: Link modules for configuration: 8 Automation Panel 900 units via SDL and SDL (optional)

### 4.10.3 Cables

Selection of 8 cables from the following tables.

Model number	Type	Length
5CASDL.0018-00	SDL cable for a fixed type of layout	1.8 m
5CASDL.0018-01	SDL cable with 45° plug for fixed type of layout	1.8 m
5CASDL.0018-03	SDL cable for fixed and flexible type of layout	1.8 m
5CASDL.0050-00	SDL cable for a fixed type of layout	5 m
5CASDL.0050-01	SDL cable with 45° plug for fixed type of layout	5 m
5CASDL.0050-03	SDL cable for fixed and flexible type of layout	5 m
5CASDL.0100-00	SDL cable for a fixed type of layout	10 m
5CASDL.0100-01	SDL cable with 45° plug for fixed type of layout	10 m
5CASDL.0100-03	SDL cable for fixed and flexible type of layout	10 m
5CASDL.0150-00	SDL cable for a fixed type of layout	15 m
5CASDL.0150-01	SDL cable with 45° plug for fixed type of layout	15 m
5CASDL.0150-03	SDL cable for fixed and flexible type of layout	15 m
5CASDL.0200-00	SDL cable for a fixed type of layout	20 m
5CASDL.0200-03	SDL cable for fixed and flexible type of layout	20 m
5CASDL.0250-00	SDL cable for a fixed type of layout	25 m
5CASDL.0250-30	SDL cable for fixed and flexible type of layout	25 m
5CASDL.0300-00	SDL cable for a fixed type of layout	30 m
5CASDL.0300-03	SDL cable for fixed and flexible type of layout	30 m
5CASDL.0300-10	SDL cable with extender for a fixed type of layout	30 m
5CASDL.0300-13	SDL cable with extender for fixed and flexible type of layout	30 m
5CASDL.0400-10	SDL cable with extender for a fixed type of layout	40 m
5CASDL.0400-13	SDL cable with extender for fixed and flexible type of layout	40 m

Table 189: Cables for SDL configurations

### Cable lengths and resolutions for SDL transfer

The following table shows the relationship between segment lengths and the maximum resolution according to the SDL cable used:

Cables Segment length [m]	Resolution				
	VGA 640 x 480	SVGA 800 x 600	XGA 1024 x 768	SXGA 1280 x 1024	UXGA 1600 x 1200
1.8	5CASDL.0018-00	5CASDL.0018-00	5CASDL.0018-00	5CASDL.0018-00	5CASDL.0018-00
	5CASDL.0018-01	5CASDL.0018-01	5CASDL.0018-01	5CASDL.0018-01	5CASDL.0018-01
	5CASDL.0018-03	5CASDL.0018-03	5CASDL.0018-03	5CASDL.0018-03	5CASDL.0018-03

Table 190: Segment lengths, resolutions and SDL cables

## Commissioning • Connection examples

Cables Segment length [m]	Resolution				
	VGA 640 x 480	SVGA 800 x 600	XGA 1024 x 768	SXGA 1280 x 1024	UXGA 1600 x 1200
5	5CASDL.0050-00 5CASDL.0050-01 5CASDL.0050-03	5CASDL.0050-00 5CASDL.0050-01 5CASDL.0050-03	5CASDL.0050-00 5CASDL.0050-01 5CASDL.0050-03	5CASDL.0050-00 5CASDL.0050-01 5CASDL.0050-03	5CASDL.0050-00 5CASDL.0050-01 5CASDL.0050-03
10	5CASDL.0100-00 5CASDL.0100-01 5CASDL.0100-03	5CASDL.0100-00 5CASDL.0100-01 5CASDL.0100-03	5CASDL.0100-00 5CASDL.0100-01 5CASDL.0100-03	5CASDL.0100-00 5CASDL.0100-01 5CASDL.0100-03	5CASDL.0100-00 <sup>1)</sup> 5CASDL.0100-01 <sup>1)</sup> 5CASDL.0100-03 <sup>1)</sup>
15	5CASDL.0150-00 5CASDL.0150-01 5CASDL.0150-03	5CASDL.0150-00 5CASDL.0150-01 5CASDL.0150-03	5CASDL.0150-00 5CASDL.0150-01 5CASDL.0150-03	5CASDL.0150-00 <sup>1)</sup> 5CASDL.0150-01 <sup>1)</sup> 5CASDL.0150-03 <sup>1)</sup>	- - -
20	5CASDL.0200-00 <sup>1)</sup> 5CASDL.0200-03 <sup>1)</sup>	5CASDL.0200-00 <sup>1)</sup> 5CASDL.0200-03 <sup>1)</sup>	5CASDL.0200-00 <sup>1)</sup> 5CASDL.0200-03 <sup>1)</sup>	5CASDL.0200-00 <sup>1)</sup> 5CASDL.0200-03 <sup>1)</sup>	- -
25	5CASDL.0250-00 <sup>1)</sup> 5CASDL.0250-03 <sup>1)</sup>	5CASDL.0250-00 <sup>1)</sup> 5CASDL.0250-03 <sup>1)</sup>	5CASDL.0250-00 <sup>1)</sup> 5CASDL.0250-03 <sup>1)</sup>	- -	- -
30	5CASDL.0300-00 <sup>1)</sup> 5CASDL.0300-03 <sup>1)</sup>	5CASDL.0300-00 <sup>1)</sup> 5CASDL.0300-03 <sup>1)</sup>	5CASDL.0300-10 <sup>2)</sup> 5CASDL.0300-13 <sup>2)</sup>	5CASDL.0300-10 <sup>2)</sup> 5CASDL.0300-13 <sup>2)</sup>	- -
40	5CASDL.0400-10 <sup>2)</sup> 5CASDL.0400-13 <sup>2)</sup>	5CASDL.0400-10 <sup>2)</sup> 5CASDL.0400-13 <sup>2)</sup>	5CASDL.0400-10 <sup>2)</sup> 5CASDL.0400-13 <sup>2)</sup>	5CASDL.0400-10 <sup>2)</sup> 5CASDL.0400-13 <sup>2)</sup>	- -

Table 190: Segment lengths, resolutions and SDL cables (Forts.)

1) See table 191 "Requirements for SDL cable with automatic cable adjustment (equalizer)", on page 344

2) See table 192 "Requirements for SDL cable with extender and automatic cable adjustment (equalizer)", on page 345

The cable types and resolutions shown with a footnote 1) in the previous table can only be implemented starting with the following firmware and hardware versions:

Firmware	Name	Version	Note
MTCX FPGA	Firmware on the APC620	v 01.15	The version is read from BIOS - see the BIOS description. Supported starting with the APC620 / PPC 700 Firmware upgrade (MTCX, SDLR, SDLT) <b>V01.10</b> , available in the download area of the B&R homepage.
MTCX PX32	Firmware on the APC620	v 01.55	
SDLR FPGA	Firmware on the AP Link SDL receiver and transceiver	v 01.04	
SDLT FPGA	Firmware on the AP Link SDL transmitter	v 00.02	
Hardware	Name	Revision	Note
5DLSL.1000-00	AP Link SDL receiver	Rev. B0	
5DLSL.1000-01	AP Link SDL transceiver	Rev. B0	

Table 191: Requirements for SDL cable with automatic cable adjustment (equalizer)



The cable types and resolutions shown with a footnote 2) in the previous table can only be implemented starting with the following firmware and hardware versions:

Firmware	Name	Version	Note
MTCX FPGA	Firmware on the APC620	v 01.15	The version is read from BIOS - see the BIOS description. Supported starting with the APC620 / PPC 700 Firmware upgrade (MTCX, SDLR, SDLT) <b>V01.10</b> , available in the download area of the B&R homepage.
MTCX PX32	Firmware on the APC620	v 01.55	
SDLR FPGA	Firmware on the AP Link SDL receiver and transceiver	v 01.04	
SDLT FPGA	Firmware on the AP Link SDL transmitter	v 00.02	
Hardware	Name	Revision	Note
5DLSDL.1000-00	AP Link SDL receiver	Rev. D0	
5DLSDL.1000-01	AP Link SDL transceiver	Rev. D0	
5AC600.SDL0-00	AP Link SDL transmitter	Rev. B3	
5PC600.SX01-00	System 1 PCI	Rev. E0	
5PC600.SX02-00	System 2 PCI, 1 disk drive slot, 1 AP Link slot	Rev. D0	
5PC600.SX02-01	System 2 PCI, 1 disk drive slot	Rev. E0	
5PC600.SF03-00	System 3 PCI, 1 disk drive slot, 1 AP Link slot	Rev. A0	
5PC600.SX05-00	System 5 PCI, 2 disk drive slots, 1 AP Link slot	Rev. C0	
5PC600.SX05-01	System 5 PCI, 2 disk drive slots	Rev. C0	

Table 192: Requirements for SDL cable with extender and automatic cable adjustment (equalizer)

#### 4.10.4 BIOS settings

No special BIOS settings are necessary for operation without touch.

To operate Automation Panel 900 panels with a touch screen (Extended Desktop or Dual Display Clone), the serial interfaces COM C and COM D must be activated in BIOS (BIOS default setting = disabled).

#### 4.10.5 Windows graphics driver settings

See chapter 4 "Software", section 5 "Automation PC 620 with Windows XP Professional", on page 568.

If all connected Automation Panel 900 panels (line 1 + line 2) should display the same content, then "Dual Display Clone" mode must be set in the graphics driver (see chapter 4 "Software", section 5.2.4 "Graphics settings for Dual Display Clone", on page 575).

#### 4.10.6 Windows touch screen driver settings

See chapter 4 "Software", section 5 "Automation PC 620 with Windows XP Professional", on page 568.

### 4.11 Six AP900 and two AP800 devices via SDL (onboard) and SDL (AP Link)

Three Automation Panel 900 (max. UXGA) units and one Automation Panel 800 are connected to the integrated SDL interface (onboard) via SDL. Additionally, three Automation Panel 900 (max. UXGA) units and one Automation Panel 800 are operated on the optional SDL transmitters. The Automation Panels in each line must be the same type. The two lines display different content (Extended Desktop), but displays in the same line show the same content (Display Clone).

USB is supported up to a maximum distance (segment 1 + segment 2) of 30 m on the first two displays. Starting at a distance of 30 m, USB is only available on the first display (front and back) up to a maximum of 40 m. USB devices can only be connected directly to Automation Panel 900 devices (without a hub).

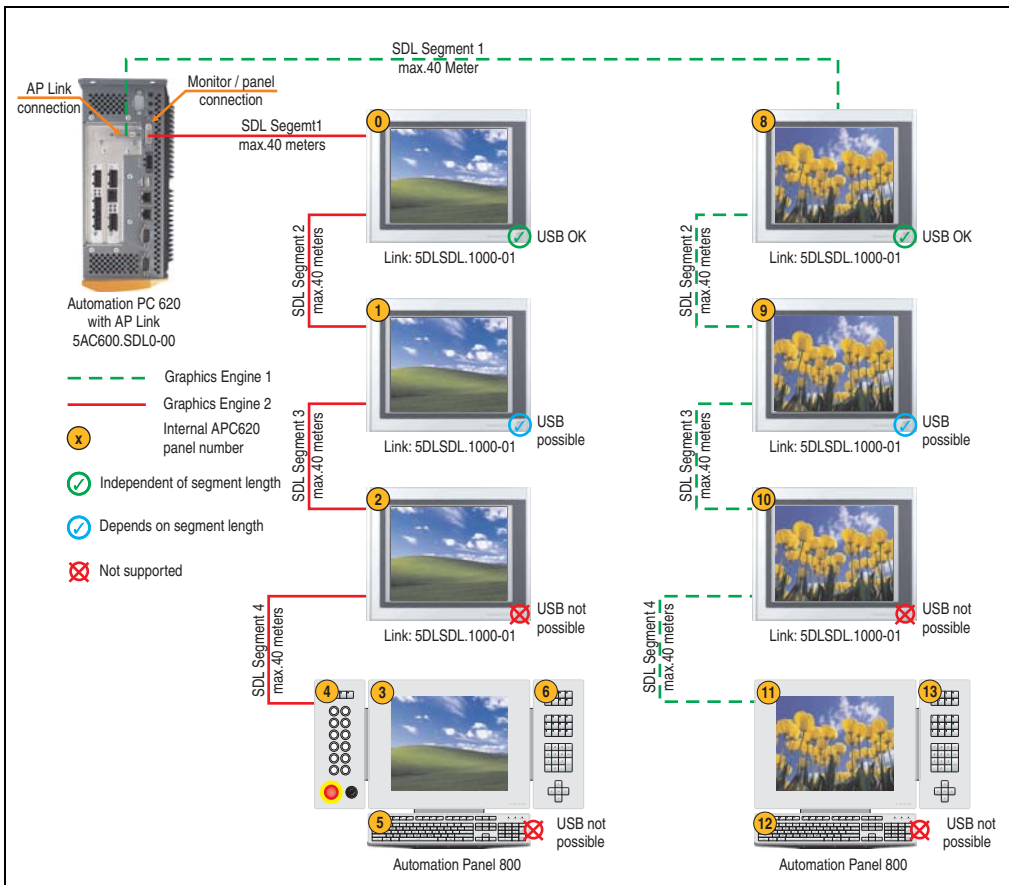

Figure 156: Configuration - Six AP900 and two AP800 devices via SDL (onboard) and SDL (AP Link)

### 4.11.1 Basic system requirements

The following table shows the possible combinations for the APC620 system unit with CPU board to implement the configuration shown in the figure above. If the maximum resolution is limited when making the combination then it is also shown in this table.

If an Automation Panel 800 and an Automation Panel 900 should be connected on the same line, the devices must have the same display type.

CPU board	with system unit						Restriction Resolution
	5PC600.SX01-00	5PC600.SX02-00	5PC600.SX02-01	5PC600.SF03-00	5PC600.SX05-00	5PC600.SX05-01	
5PC600.E855-00 5PC600.X855-00	-	✓	-	✓	✓	-	max. XGA
5PC600.E855-01 5PC600.X855-01	-	✓	-	✓	✓	-	max. XGA
5PC600.E855-02 5PC600.X855-02	-	✓	-	✓	✓	-	max. XGA
5PC600.E855-03 5PC600.X855-03	-	✓	-	✓	✓	-	max. XGA
5PC600.E855-04 5PC600.X855-04	-	✓	-	✓	✓	-	max. XGA
5PC600.E855-05 5PC600.X855-05	-	✓	-	✓	✓	-	max. XGA

Table 193: Possible combinations of system unit and CPU board

### 4.11.2 Link modules

Model number	Description	Note
5DLSDL.1000-01	<b>Automation Panel Link SDL transceiver</b> Connections for SDL in, transfer of display data, touch screen, USB 1.1, matrix keys, and service data, 24 VDC (screw clamp 0TB103.9 or cage clamp 0TB103.91 sold separately).	For Automation Panel 900 6 pieces required
5AC600.SDL0-00	<b>APC620 Smart Display Link transmitter</b> For connecting Automation Panels to an APC620 via SDL.	For Automation PC 620 1 pieces required

Table 194: Link modules for configuration: 6 Automation Panel 900 units via SDL and SDL (optional)

### 4.11.3 Cables

How to select an SDL cable for connecting the AP900 display to the AP900 display 4.3 "An Automation Panel 900 via SDL (onboard)".

How to select an SDL cable for connecting the AP800 display to the AP900 display 4.4 "An Automation Panel 800 via SDL (onboard)".

Cable lengths and resolutions for SDL transfer

The following table shows the relationship between segment lengths and the maximum resolution according to the SDL cable used:

Cables Segment length [m]	Resolution				
	VGA 640 x 480	SVGA 800 x 600	XGA 1024 x 768	SXGA 1280 x 1024	UXGA 1600 x 1200
1.8	-	-	5CASDL.0018-00 5CASDL.0018-01 5CASDL.0018-20 5CASDL.0018-03	-	-
5	-	-	5CASDL.0050-00 5CASDL.0050-01 5CASDL.0050-02 5CASDL.0050-03	-	-
10	-	-	5CASDL.0100-00 5CASDL.0100-01 5CASDL.0100-02 5CASDL.0100-03	-	-
15	-	-	5CASDL.0150-00 5CASDL.0150-01 5CASDL.0150-02 5CASDL.0150-03	-	-
20	-	-	5CASDL.0200-00 <sup>1)</sup> 5CASDL.0200-02 <sup>1)</sup> 5CASDL.0200-03 <sup>1)</sup>	-	-
25	-	-	5CASDL.0250-00 <sup>1)</sup> 5CASDL.0250-02 <sup>1)</sup> 5CASDL.0250-03 <sup>1)</sup>	-	-
30	-	-	5CASDL.0300-10 <sup>1)</sup> 5CASDL.0300-13 <sup>2)</sup> 5CASDL.0300-30 <sup>2)</sup>	-	-
40	-	-	5CASDL.0400-10 <sup>2)</sup> 5CASDL.0400-13 <sup>2)</sup> 5CASDL.0400-30 <sup>2)</sup>	-	-

Table 195: Segment lengths, resolutions and SDL cables

1) See table 196 "Requirements for SDL cable with automatic cable adjustment (equalizer)", on page 348

2) See table 197 "Requirements for SDL cable with extender and automatic cable adjustment (equalizer)", on page 349

The cable types and resolutions shown with a footnote 1) in the previous table can only be implemented starting with the following firmware and hardware versions:

Firmware	Name	Version	Note
MTCX FPGA	Firmware on the APC620	v 01.15	The version is read from BIOS - see the BIOS description. Supported starting with the APC620 / PPC 700 Firmware upgrade (MTCX, SDLR, SDLT) <b>V01.10</b> , available in the download area of the B&R homepage.
MTCX PX32	Firmware on the APC620	v 01.55	

Table 196: Requirements for SDL cable with automatic cable adjustment (equalizer)

The cable types and resolutions shown with a footnote 2) in the previous table can only be implemented starting with the following firmware and hardware versions:

Firmware	Name	Version	Note
MTCX FPGA	Firmware on the APC620	v 01.15	The version is read from BIOS - see the BIOS description. Supported starting with the APC620 / PPC 700 Firmware upgrade (MTCX, SDLR, SDLT) <b>V01.10</b> , available in the download area of the B&R homepage.
MTCX PX32	Firmware on the APC620	v 01.55	
Hardware	Name	Revision	Note
5PC600.SX01-00	System 1 PCI	Rev. E0	-
5PC600.SX02-00	System 2 PCI, 1 disk drive slot, 1 AP Link slot	Rev. D0	-
5PC600.SX02-01	System 2 PCI, 1 disk drive slot	Rev. E0	-
5PC600.SF03-00	System 3 PCI, 1 disk drive slot, 1 AP Link slot	Rev. A0	-
5PC600.SX05-00	System 5 PCI, 2 disk drive slots, 1 AP Link slot	Rev. C0	-
5PC600.SX05-01	System 5 PCI, 2 disk drive slots	Rev. C0	-

Table 197: Requirements for SDL cable with extender and automatic cable adjustment (equalizer)

#### 4.11.4 BIOS settings

No special BIOS settings are necessary for operation without touch.

To operate Automation Panel 900 panels with a touch screen (Extended Desktop or Dual Display Clone), the serial interfaces COM C and COM D must be activated in BIOS (BIOS default setting = disabled).

#### 4.11.5 Windows graphics driver settings

See chapter 4 "Software", section 5 "Automation PC 620 with Windows XP Professional", on page 568.

If all connected Automation Panel 900 panels and Automation Panel 800 panels (line 1 + line 2) should display the same content, then "Dual Display Clone" mode must be set in the graphics driver (see chapter 4 "Software", section 5.2.4 "Graphics settings for Dual Display Clone", on page 575).

#### 4.11.6 Windows touch screen driver settings

See chapter 4 "Software", section 5 "Automation PC 620 with Windows XP Professional", on page 568.

## 4.12 Internal numbering of extension units in AP800 devices

An extension unit for an AP800 device is numbered like another device. The numbering of the extension units starts from the display unit and goes in the counter-clockwise direction; all extension unit slots that are not used are left out. The following graphic shows numbering examples.

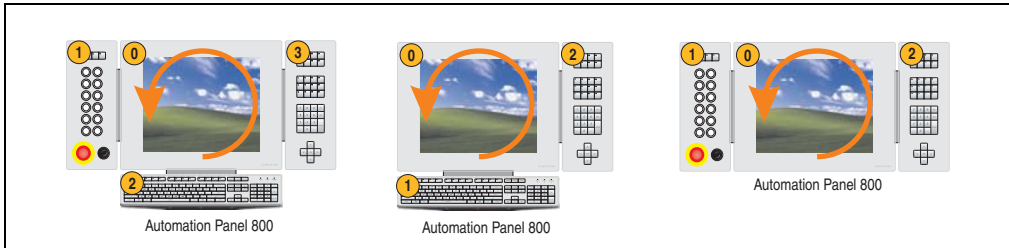

Figure 157: Examples - internal numbering of the extension units

## 5. Configuration of a SATA RAID array

You must enter the BIOS "RAID Configuration Utility" in order to make the necessary settings. After the POST, enter <Ctrl+S> or <F4> to open RAID BIOS.

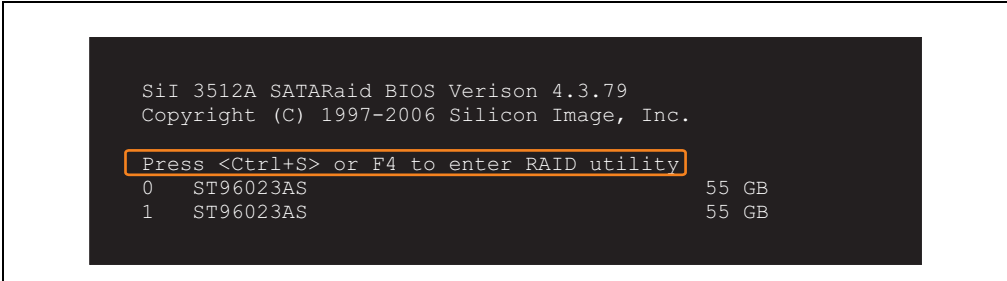

Figure 158: Open the RAID Configuration Utility

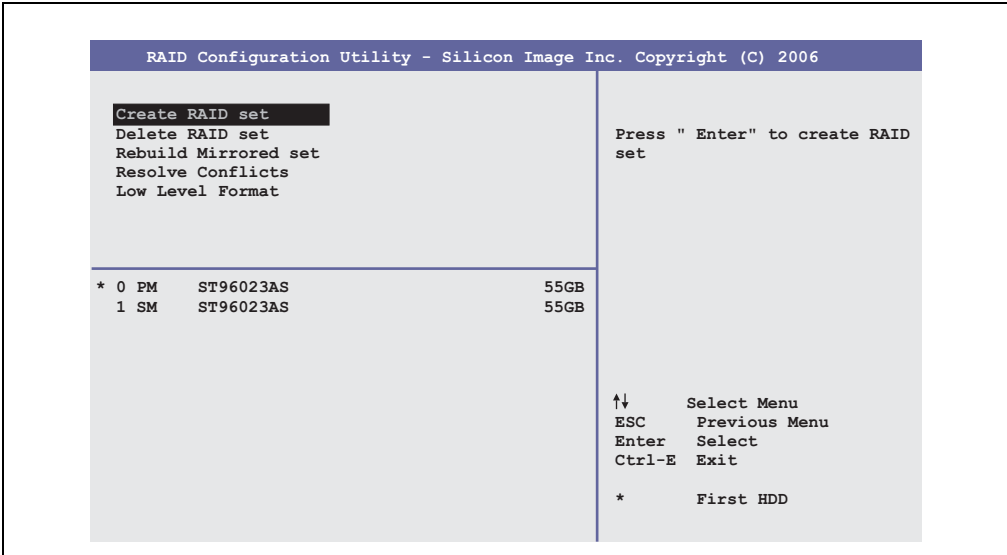

Figure 159: RAID Configuration Utility - Menu

The following keys can be used after entering the BIOS setup:

Key	Function
Cursor ↑	Go to previous item.
Cursor ↓	Go to the next item.
Enter	Select an item or open a submenu.

Table 198: BIOS-relevant keys in the RAID Configuration Utility

## Commissioning • Configuration of a SATA RAID array

Key	Function
ESC	Go back to previous menu.
Ctrl+E	Exit setup and save the changed settings.

Table 198: BIOS-relevant keys in the RAID Configuration Utility

### 5.1 Create RAID set

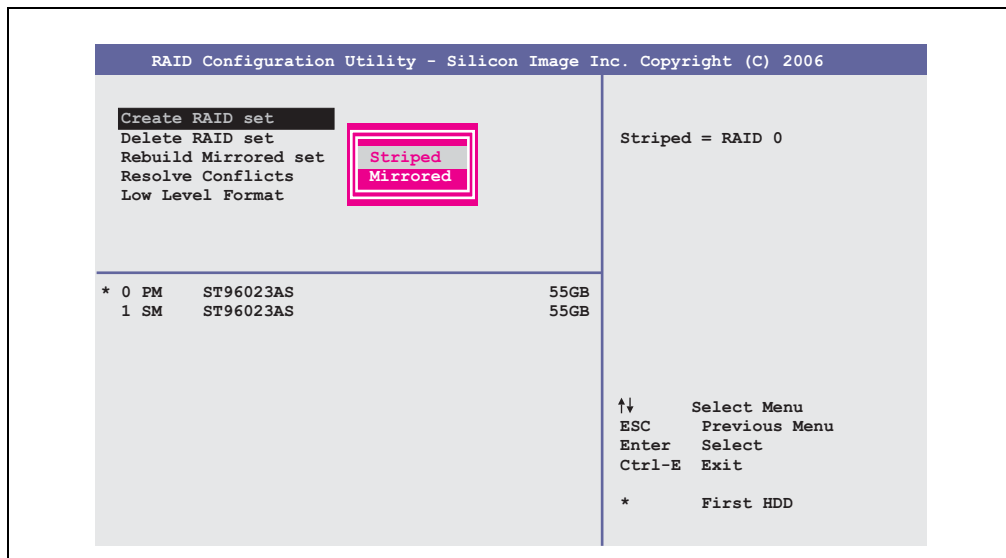

Figure 160: RAID Configuration Utility - Menu

The RAID system can be recreated as "Striped" = RAID0 or "Mirrored" = RAID1 using the menu "Create RAID set".



### 5.1.1 Create RAID set - Striped

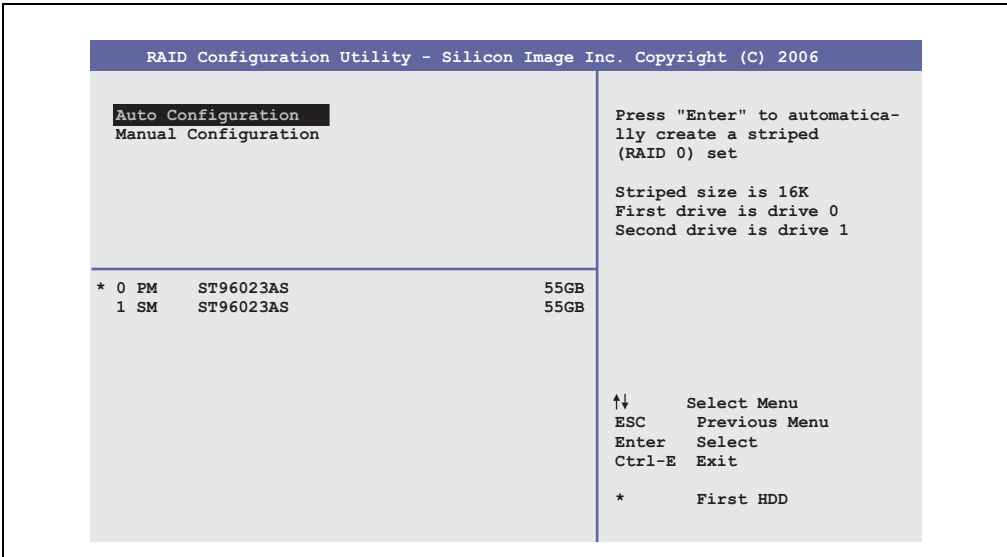

Figure 161: RAID Configuration Utility - Create RAID set - Striped

#### Auto Configuration

Auto Configuration optimizes all settings.

#### Manual Configuration

It is possible to specify the first and second HDD as well as the "Chunk Size" (= block size, application-dependent).

### 5.1.2 Create RAID set - Mirrored

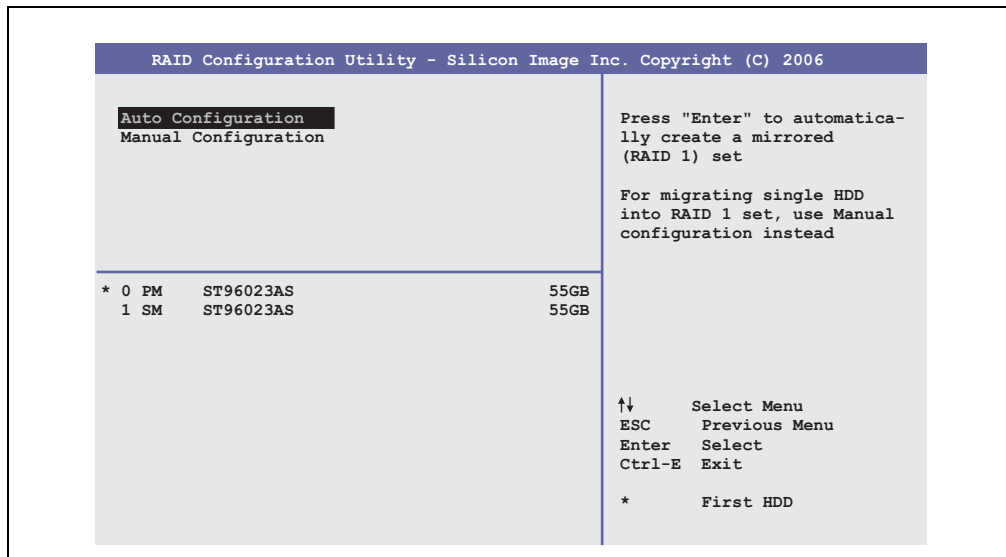

Figure 162: RAID Configuration Utility - Create RAID set - Mirrored

#### Auto Configuration

Auto Configuration optimizes all settings.

#### Manual Configuration

It is possible to specify the "Source" and "Target" HDD, and also to specify whether a rebuild (mirror) should be performed immediately (approx. 50 minutes).

## 5.2 Delete RAID set

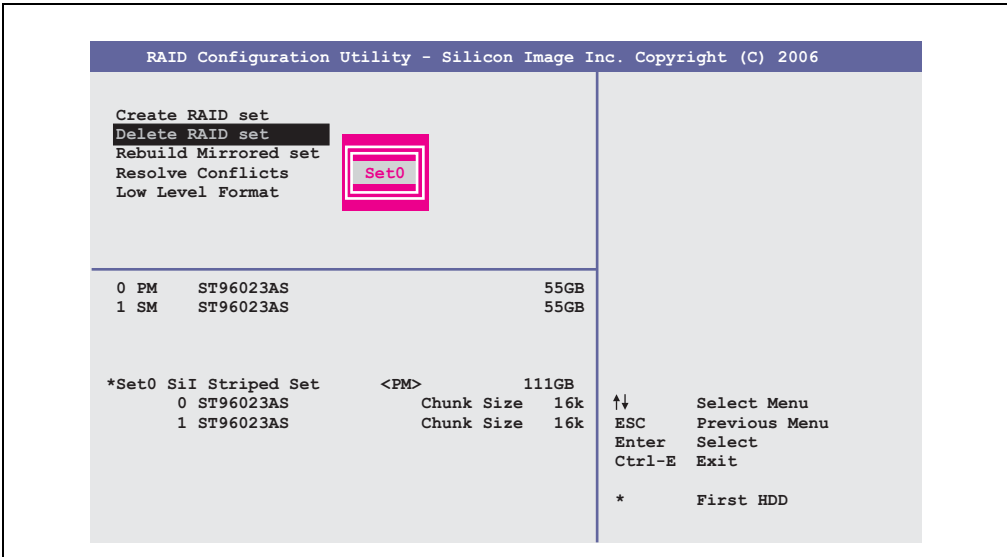

Figure 163: RAID Configuration Utility - Delete RAID set

An existing RAID set can be deleted using the menu "Delete RAID set".

### 5.3 Rebuild mirrored set

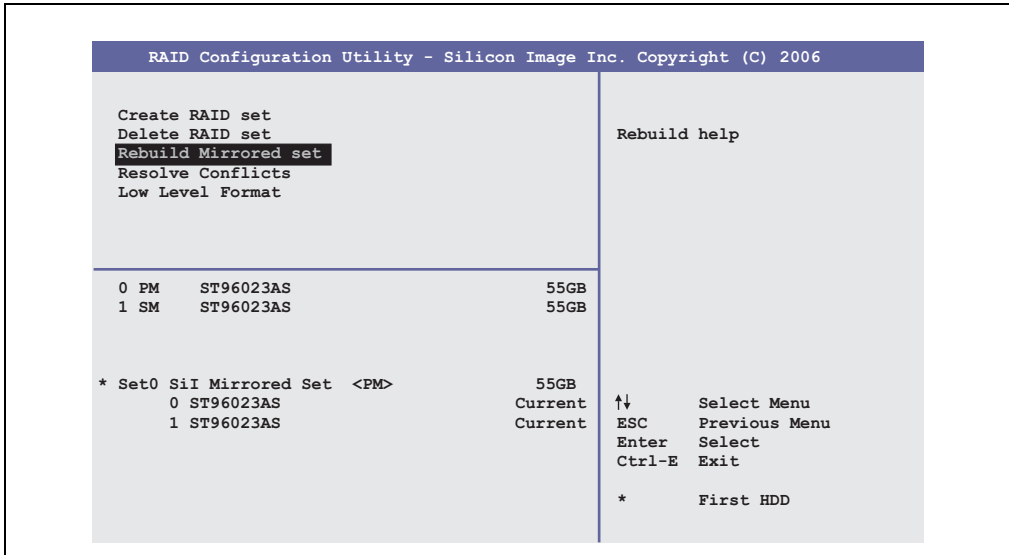

Figure 164: RAID Configuration Utility - Rebuild mirrored set

The "Rebuild mirrored set" menu can be used to restart a rebuild procedure in a RAID 1 network if an error occurs, after first interrupting the rebuild procedure or when exchanging a hard disk.

If "onlinerebuild" is selected, then the rebuild is executed during operation after the system is booted. E.g. an event pop-up is displayed by the installed SATA RAID configuration program: `SATAraid detected a new event and the rebuild is started`. The entire rebuild lasts approximately 50 minutes.

If "offlinerebuild" is selected, then a rebuild is performed immediately before starting the operating system (lasts approximately 30 minutes).

## 5.4 Resolve conflicts

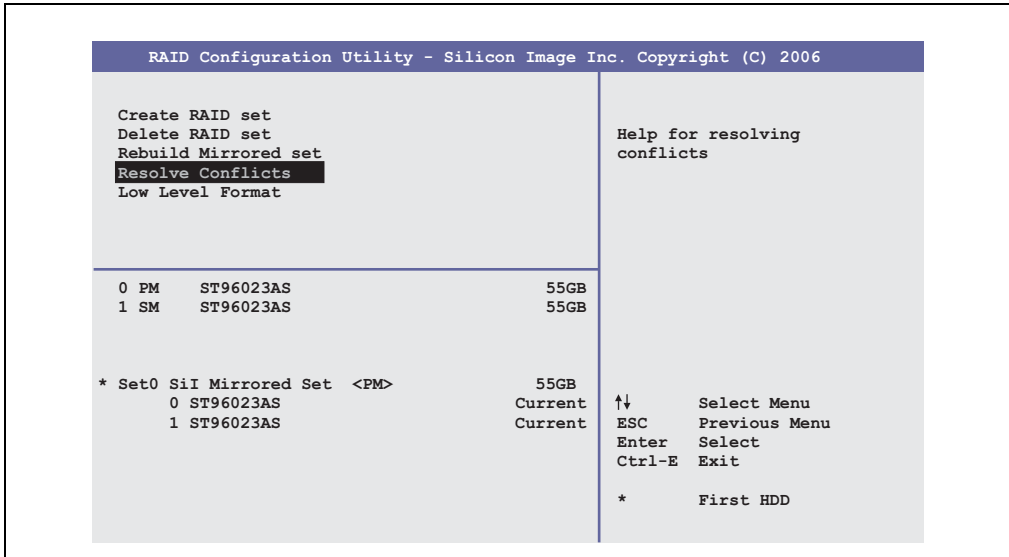

Figure 165: RAID Configuration Utility - Resolve conflicts

Conflicts in a RAID set can be resolved using the "Resolve conflicts" menu. This function is only available if the status of the hard disk is "conflict".

## 5.5 Low level format

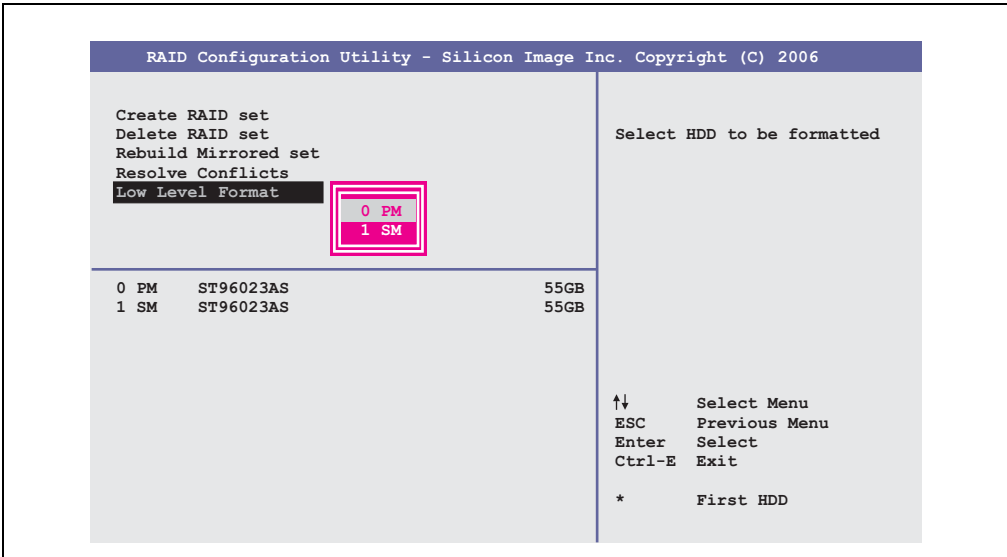

Figure 166: RAID Configuration Utility - Low level format

Individual hard disks can be configured using the "Low Level Format" menu. This can only be done if a RAID set is not configured. A low level format of a hard disk takes approx. 40 minutes.

## 6. Connection of USB peripheral devices

### Warning!

Peripheral USB devices can be connected to the USB interfaces. Due to the vast number of USB devices available on the market, B&R cannot guarantee their performance. B&R does ensure the performance of all USB devices that they provide.

### 6.1 Local on the APC620

Many different peripheral USB devices can be connected to the 2 or 4 (APC embedded) USB interfaces. The maximum current load values and transfer speeds can be found in Sections "USB port", on page 133 and "USB connection (only APC620 embedded)", on page 134.



Figure 167: Local connection of USB peripheral devices on the APC620

## 6.2 Remote connection to Automation Panel 900 via DVI

Many different peripheral USB devices can be connected to the 2 or 3 USB interfaces on the Automation Panel 900. These can each handle a load of 500 mA. The maximum transfer rate is USB 2.0.

### Information:

Only end devices (no hubs) can be connected to the Automation Panel 900.

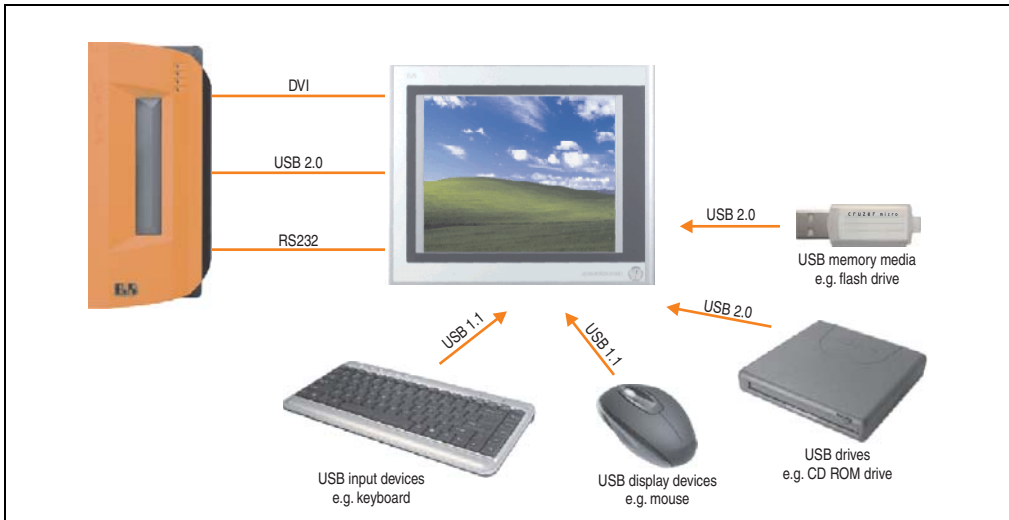

Figure 168: Remote connection of USB peripheral devices to the APC900 via DVI



### 6.3 Remote connection to Automation Panel 800/900 via SDL

Many different peripheral USB devices can be connected to the 2 or 3 USB interfaces on Automation Panel 900 and/or USB connections on the Automation Panel 800 devices. These can each handle a load of 500 mA. The maximum transfer rate is USB 1.1.

#### Information:

Only end devices (no hubs) can be connected to the Automation Panel 800/900.



Figure 169: Remote connection of USB peripheral devices to the APC800/900 via SDL

## 7. General instructions for performing temperature tests

The purpose of these instructions is to explain general procedures for performing application-specific temperature tests with B&R industrial PCs or Power Panels. However, these instructions are meant to serve only as a guideline.

### 7.1 Procedure

In order to obtain accurate results, the testing conditions should match the conditions in the field. This means that for the duration of the temperature tests, the target application should be running, the PC should be installed in the control cabinet that will be used, etc.

Additionally, a temperature sensor should be installed for the device being tested to provide live monitoring of the ambient temperature. In order to obtain accurate measurements, this sensor should be mounted at a distance of 5 to 10 cm from the B&R industrial PC, near the air intake (not near the exhaust).

All B&R industrial PCs and Power Panels are equipped with internal temperature sensors. These are installed in different locations for each series. The number of sensors and the temperature limits also vary from series to series.

Information about the locations of temperature sensors and the maximum specified values can be found in section "Temperature sensor locations", on page 791.

To ensure a reliable evaluation of the temperature situation, a minimum of 8 hours are recommended for testing.

### 7.2 Evaluating the temperatures in Windows operating systems

#### 7.2.1 Evaluation using B&R Control Center

The B&R Control Center can be used to evaluate the temperatures. The temperatures can be viewed on the "Temperatures" tab. The B&R Control Center can be downloaded at no cost from the Downloads section of the B&R website ([www.br-automation.com](http://www.br-automation.com)). The B&R Control Center uses the B&R Automation Device Interface (ADI).

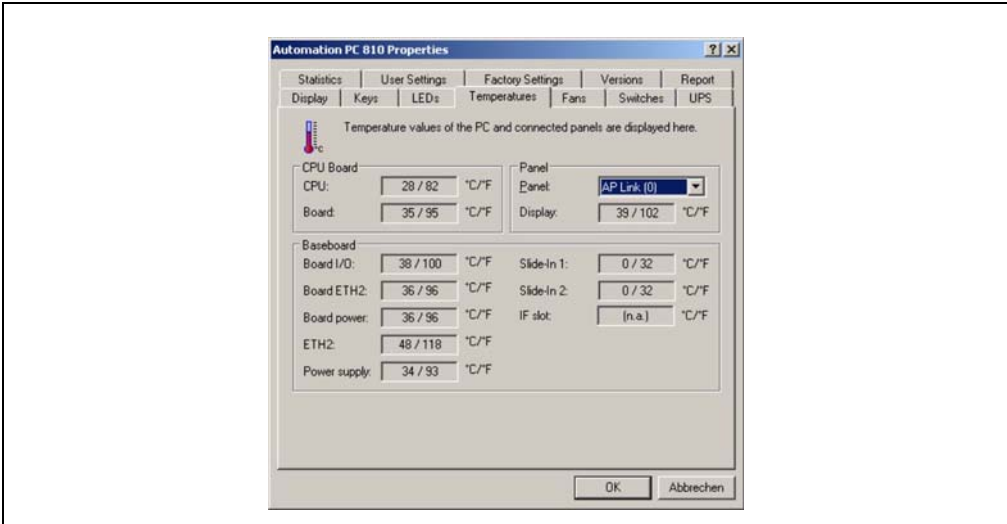

Figure 170: B&R Control Center

A new application can be created if a historic recording of the data is required.

## Information:

There are SDK's (e.g. the ADI .NET SDK) available on the B&R website ([www.br-automation.com](http://www.br-automation.com)) that can be helpful in creating a new application.

## 7.2.2 Evaluation using the BurnIn tool from Passmark

If a new application is not created for evaluating the temperatures, B&R recommends using the BurnIn Test software tool from the company Passmark.

Standard and Professional versions of the BurnIn tool are available. In addition to the software package, there are also various loopback adapters (serial, parallel, USB, etc.) and test CDs/DVDs available. The exact software and loopback adapters used will determine the corresponding load that can be generated on the system and peripheral devices.

### Information:

Loopback adapters are also available from Passmark. More information can be found at [www.passmark.com](http://www.passmark.com).

The following screenshots are based on Passmark BurnIn Pro Version V4 and an APC810 2-slot with DVD.

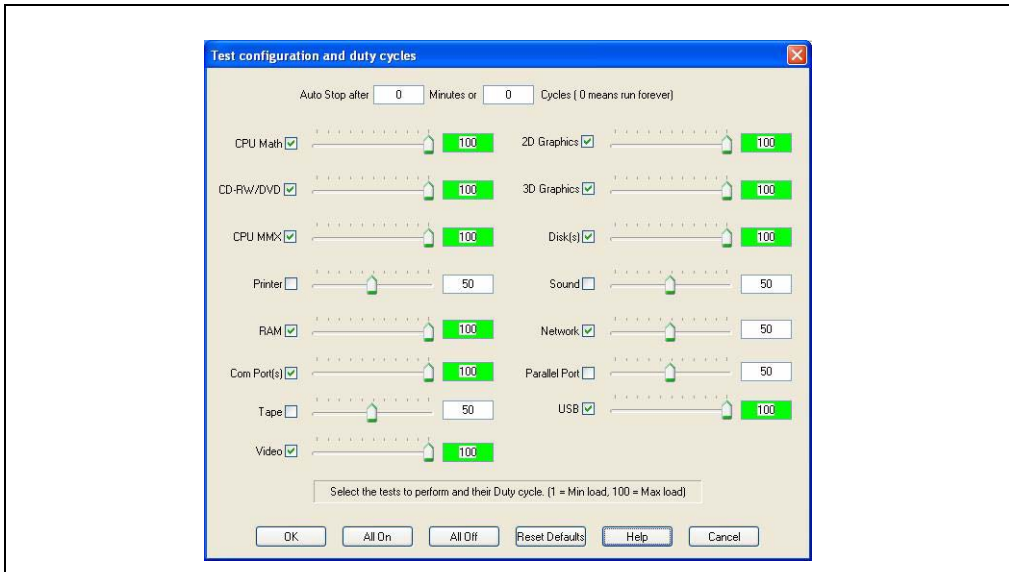

Figure 171: Settings for Passmark BurnIn Pro V4 with an APC810 2-slot with DVD

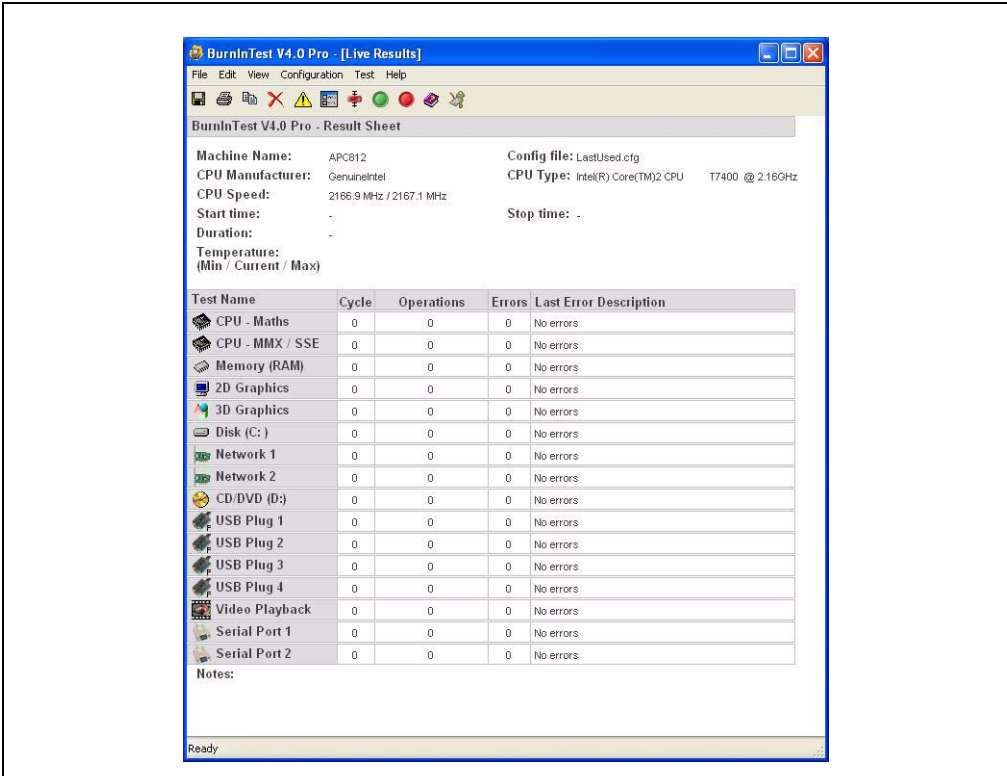

Figure 172: Test overview of an APC810 2-slot with DVD

The respective test properties may need to be fine tuned depending on the availability of a loopback adapter and DVDs.

### Information:

If there is no USB loopback adapter available, USB flash drives can also be used. The USB flash drives must be available in Windows as formatted drives. The test USB must then be deselected and the USB flash drives must be configured in the disk properties.



## Information:

Serial loopback adapters are relatively easy to create yourself. Simply connect several pins on the serial interface with wires.

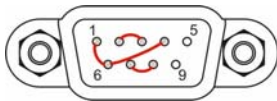

### 7.3 Evaluating the temperatures in an operating system other than Windows

For applications that don't use Windows, the temperatures can be evaluated using the B&R implementation guide. In addition to the implementation guide, there are also programs available in MS-DOS.

The implementation guide only describes the device-specific functions and not the main functions of the sample programs.

If code from the sample programs is used, please observe the notes in the implementation guide regarding the TODO statements, I/O access functions, etc.

## Information:

Sample programs and implementation guides for any B&R industrial PC or Power Panel can be downloaded free of charge from the B&R website ([www.br-automation.com](http://www.br-automation.com)).

### 7.4 Evaluating the measurement results

The maximum temperature value recorded by each sensor must not exceed the temperature limits specified in the user's manuals.

If the temperature tests cannot be performed in a climate controlled chamber, they can also be performed in an office environment. In this case, however, it is necessary to measure the ambient temperature. Experience at B&R has shown that values measured on passive systems (systems without a fan kit) can be projected linearly based on the ambient temperature. In order to be able to project the temperature values for systems with a fan kit, the fans must be running. It is also important to consider the speed, etc.

If the temperature tests are performed in a climate controlled chamber with fans, the devices will be cooled by these fans, and the results will be skewed. The measurement results for passive devices would therefore be unusable. In order to obtain accurate results in climate controlled chambers with fans, the chamber fans must be turned off and the device must be allowed to run for a sufficient amount of time (several hours) before beginning the test.

7.4.1 Example using an APC810 2-slot

The following example is only valid as long as the instructions for installation and mounting orientation provided in the user's manual are followed.

Temperature sensor	Measured temperature	Projected temperature	
Ambient temperature	20°C	35°C	45°C
CPU	48°C	63°C	73°C
CPU board	51°C	66°C	76°C
Board I/O	51°C	66°C	76°C
Board ETH2	52°C	67°C	77°C
Board power supply	51°C	66°C	76°C
ETH2	65°C	80°C	90°C
Power supply	51°C	66°C	76°C

Table 199: Evaluation example using an APC810 2-slot

## 8. Compatibility / improvement from 855GME (XTX) to 855GME (ETX)

The following table shows the compatibilities and improvements from 855GME (XTX) 5PC600.X855-0x to 855GME (ETX) 5PC600.E855-0x CPU boards.

Property	Compatibility / improvement
Hardware compatibility Power	Yes Equal to
Software compatibility Hardware driver BIOS Windows XP Professional Windows XP Embedded Windows Embedded Standard 2009 Automation Runtime	Yes No - AMI BIOS No - Reinstall required No - New image required (see model number overview) No - New image required (see model number overview) No - New version of Automation Runtime required
Improvements	No limitation of ETH1 cable length Better and more even distribution of IRQ load and distribution on the PCI bus USB 2.0 is already supported when booting Easier configuration of an "Exclusive PCI IRQ" Support for creating custom boot logos Better detection of connected display devices (e.g. Automation Panel 800, Automation Panel 900, standard TFT monitor, etc.)

Table 200: Compatibility / improvements from 855GME (XTX) to 855GME (ETX)



## 9. Known problems / issues

The following issue for the APC620 devices is known:

- Using two different types of CompactFlash cards can cause problems in Automation PCs and Panel PCs. This can result in one of the two cards not being detected during system startup. This is caused by varying startup speeds. CompactFlash cards with older technology require significantly more time during system startup than CompactFlash cards with newer technology. This behavior occurs near the limits of the time frame provided for startup. The problem described above can occur because the startup time for the CompactFlash cards fluctuates due to the variance of the components being used. Depending on the CompactFlash cards being used, this error might never, sometimes or always occur.
- During daisy chain operation of multiple AP800/AP900 devices via SDL, it's possible that the touch controller status shows a red "X" in the Control Center applet for the touch screen driver when the touch controller is detected. The functionality of the touch system is not affected by this. This can be avoided by setting a panel locking time of 50 ms. The panel locking time can be configured with the B&R Key Editor.
- Beginning with Revision E0 of the 5AC600.SSDI-00 drive, the simultaneous operation with a CompactFlash card in the CompactFlash1 slot is no longer recommended since the CompactFlash card is only operated in UDMA2 mode. Revision E0 of the 5AC600.SSDI-00 drive can only be used in standalone operation.



# Chapter 4 • Software

---

## 1. BIOS options

The available BIOS settings in various CPU boards 815E (ETX), 855GME (ETX) and 855GME (XTX) are described in the following sections.

### 1.1 815E (ETX) BIOS description

#### Information:

- The following diagrams and BIOS menu items including descriptions refer to BIOS version 1.23. It is therefore possible that these diagrams and BIOS descriptions do not correspond with the installed BIOS version.
- The setup defaults are the settings recommended by B&R. The setup defaults are dependant on the DIP switch configuration on the baseboard (see section 1.1.10 "Profile overview - BIOS default settings - 815E (ETX)", on page 416).

#### 1.1.1 General information

BIOS stands for "Basic Input Output System". It is the most basic standardized communication between the user and the system (hardware). The BIOS system used in the Automation PC 620 systems is produced by Phoenix.

The BIOS Setup Utility lets you modify basic system configuration settings. These settings are stored in CMOS and in EEPROM (as a backup).

The CMOS data is buffered by a battery, and remains in the APC620 even when the power is turned off (no 24 VDC supply) .

#### 1.1.2 BIOS setup and boot procedure

BIOS is immediately activated when switching on the power supply of the Automation PC 620 system or pressing the power button. The system checks if the setup data from the EEPROM is "OK". If the data is "OK", then it is transferred to the CMOS. If the data is "not OK", then the CMOS data is checked for validity. An error message is output if the CMOS data contains errors and the boot procedure can be continued by pressing the <F1> key. To prevent the error message from appearing at each restart, open the BIOS setup by pressing the <F2> key and re-save the settings.

## Software • BIOS options

BIOS reads the system configuration information in CMOS RAM, checks the system, and configures it using the Power On Self Test (POST).

When these "preliminaries" are finished, BIOS seeks an operating system in the data storage devices available (hard drive, floppy drive, etc.). BIOS launches the operating system and hands over control of system operations to it.

To enter BIOS setup, the F2 key must be pressed as soon as the following message appears on the lower margin of the display (during POST):

"Press <F2> to enter SETUP"



```
PhoenixBIOS 4.0 Release 6.1
Copyright 1985-2003 Phoenix Technologies Ltd.
All Rights Reserved
<1BR1R123> Bernecker + Rainer Industrie-Elektronik C1.23

CPU = Mobile Intel(R) Celeron(TM) CPU           733MHz
126M System RAM Passed
256K Cache SRAM Passed
System BIOS shadowed
Video BIOS shadowed
UMB upper limit segment address: E871

Press <F2> to enter SETUP
```

Figure 173: 815E (ETX) BIOS diagnostic screen

## Summary screen

After the POST, the summary screen displays the most important system characteristics.

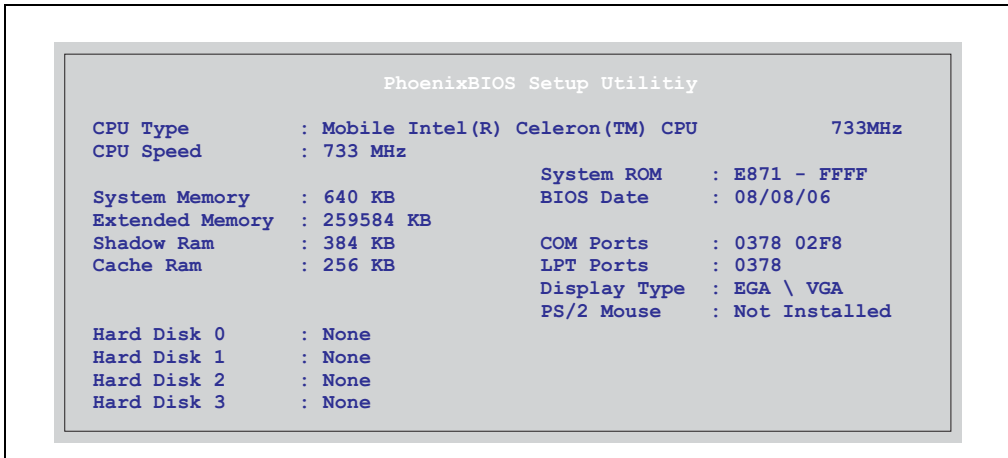

Figure 174: 815E (ETX) BIOS Summary screen

### 1.1.3 BIOS setup keys

The following keys are active during the POST:

Key	Function
F2	Enters the BIOS setup menu.
ESC	Cues the boot menu. Lists all bootable devices that are connected to the system. With cursor ↑ and cursor ↓ and by pressing <ENTER>, select the device from which will be booted.
<Spacebar>	Pressing the spacebar skips the system RAM check.
<Pause>	Pressing the <pause> key stops the POST. Press any other key to resume the POST.

Table 201: Keys relevant to 815E (ETX) BIOS during POST

The following keys can be used after entering the BIOS setup:

Key	Function
Cursor ↑	Moves to the previous item.
Cursor ↓	Go to the next item.
Cursor ←	Move to the item on the left.
Cursor →	Move to the item on the right.
<ESC>	Exits the submenu.
PageUp ↑	Moves the cursor to the top of the current BIOS setup page.
PageDown ↓	Moves the cursor to the bottom of the current BIOS setup page.

Table 202: Keys relevant to 815E (ETX) BIOS

Key	Function
<F1> or <Alt+H>	Opens a help window showing the key assignments.
<F5> or <->	Scrolls to the previous option for the selected BIOS setting.
<F6> or <+> or <spacebar>	Scrolls to the next option for the selected BIOS setting.
<F9>	Loads setup defaults for the current BIOS setup screen.
<F10>	Saves settings and closes BIOS setup.
<Enter>	Opens submenu for a BIOS setup menu item, or displays the configurable values of a BIOS setup item.

Table 202: Keys relevant to 815E (ETX) BIOS (Forts.)

The following sections explain the individual BIOS setup menu items in detail.

BIOS setup menu item	Function	From page
<b>Main</b>	The basic system configurations (e.g. time, date, hard disk parameters) can be set in this menu.	375
<b>Advanced</b>	Advanced BIOS options such as cache areas, PnP, keyboard repeat rate, as well as settings specific to B&R integrated hardware, can be configured here.	384
<b>Security</b>	For setting up the system's security functions.	407
<b>Power</b>	Setup of various APM (Advanced Power Management) options.	409
<b>Boot</b>	The boot order can be set here.	414
<b>Exit</b>	To end the BIOS setup.	415

Table 203: Overview of 815E (ETX) BIOS menu items

1.1.4 Main

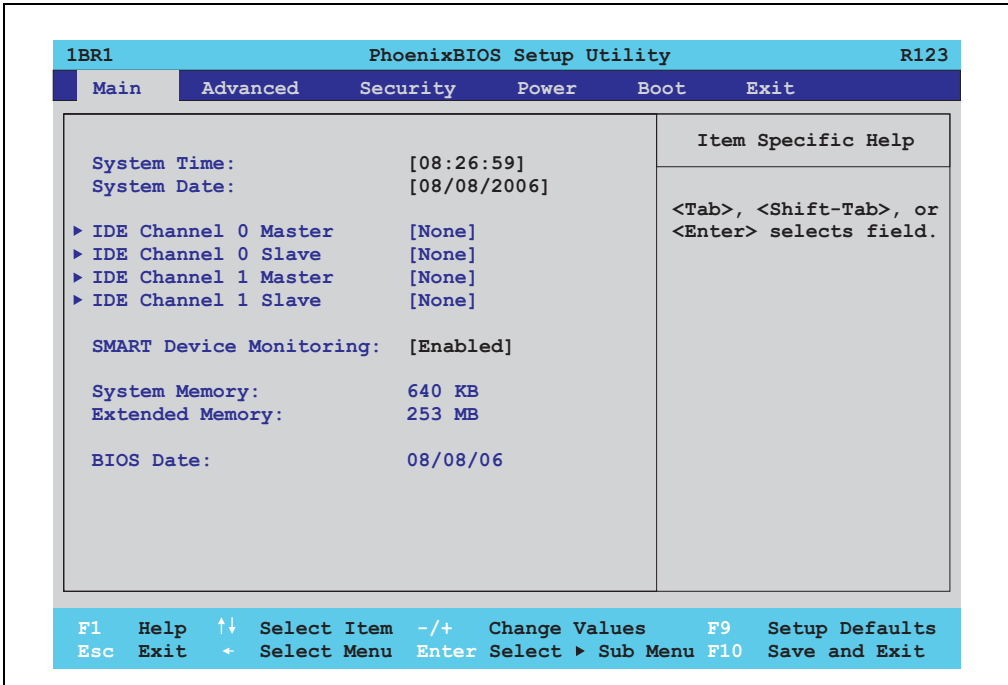

Figure 175: 815E (ETX) Main Menu

BIOS setting	Meaning	Setting options	Effect
System Time	This is the current system time setting. The time is buffered by a battery (CMOS battery) after the system has been switched off.	Changes the System time	Set the system time in the format (hh:mm:ss).
System Date	This is the current system date setting. The time is buffered by a battery (CMOS battery) after the system has been switched off.	Changes the system date	Set the system date in the format (mm:dd:yyyy).
IDE channel 0 master	The drive in the system that is connected to the IDE primary master port is configured here.	Enter	Opens the submenu See "IDE channel 0 master", on page 376.
IDE channel 0 slave	The drive in the system that is connected to the IDE primary slave port is configured here.	Enter	Opens the submenu See "IDE channel 0 slave", on page 378.
IDE channel 1 master	The drive in the system that is connected to the IDE secondary master port is configured here.	Enter	Opens the submenu See "IDE channel 1 master", on page 380.
IDE channel 1 slave	The drive in the system that is connected to the IDE secondary slave port is configured here.	Enter	Opens the submenu See "IDE channel 1 slave", on page 382.

Table 204: 815E (ETX) Main setting options

## Software • BIOS options

BIOS setting	Meaning	Setting options	Effect
Smart device monitoring	S.M.A.R.T. (Self Monitoring Analysis and Reporting Technology) is implemented in the today's hard drives. This technology allows you to detect reading or rotational problems with the hard drive, and much more.	Enabled	Activates this function. In the future, a message regarding impending errors is produced.
		Disabled	Deactivates this function.
System Memory	Displays the amount of main memory installed. Between 0 and 640 KB.	None	-
Extended memory	Displays the available main memory from the first MB to the maximum memory capacity.	None	-
BIOS Date	BIOS creation date	None	-

Table 204: 815E (ETX) Main setting options (Forts.)

### IDE channel 0 master

1BR1	PhoenixBIOS Setup Utility	R123
Main		
IDE Channel 0 Master [None]		Item Specific Help
Type: [Auto] Multi-Sector Transfers: [Disabled] LBA Mode Control: [Enabled] 32 Bit I/O: [Disabled] Transfer Mode: [Standard] Ultra DMA Mode: [Disabled] SMART Monitoring: [Disabled]	User = you enter parameters of hard-disk drive installed at this connection. Auto = autotypes hard-disk drive installed here. CD-ROM = a CD-ROM drive is installed here. ATAPI Removeable = removable disk drive is installed here.	
F1 Help	↑↓ Select Item	-/+ Change Values
Esc Exit	← Select Menu	Enter Select ▶ Sub Menu
		F9 Setup Defaults
		F10 Save and Exit

Figure 176: 815E (ETX) IDE Channel 0 Master



BIOS setting	Meaning	Setting options	Effect
Type	The type of drive connected to the primary master is configured here.	Auto	Automatic recognition of the drive and setup of appropriate values.
		User	Manual setup of the drive (number of cylinders, heads, and sectors).
		Other ATAPI	Use this option for IDE disk drives that are not mentioned here.
		CD-ROM	CD-ROM = CD-ROM drive
		ATAPI removable	The removable media drive is treated as a hard drive or floppy drive.
		IDE removable	The IDE removable drive is treated as a hard drive.
Multi-sector transfer	This option determines the number of sectors per block. Only possible when manually setting up the drive.	Disabled	Disables this function.
		2, 4, 8 or 16 sectors	Number of sectors per block.
LBA mode control	This option activates the logical block addressing for IDE. This function enables support of drives larger than 540 MB. Only possible when manually setting up the drive.	Disabled	Disables this function.
		Enabled	Enables this function.
32-bit I/O	This function enables 32-bit data transfer.	Disabled	Disables this function.
		Enabled	Enables this function.
Transfer mode	The communication path between the primary master drive and the system memory is defined here. Only possible when manually setting up the drive.	Default	Default setting.
		Fast PIO 1 - Fast PIO 4 / DMA2	Manual configuration of PIO mode.
Ultra DMA mode	The data transfer rate to and from the primary master drive is defined here. The DMA mode must be activated in the Windows device manager in order to guarantee maximum performance. Only possible when manually setting up the drive.	Disabled	Disables this function. Do not use UDMA mode.
		Mode 0 - Mode 5	Manual setting option for UDMA mode.
SMART monitoring	Indicates whether the primary master drive supports SMART technology.	Disabled	No drive support, and function is deactivated.
		Enabled	Drive support present, and function is activated.

Table 205: 815E (ETX) IDE Channel 0 Master setting options

IDE channel 0 slave

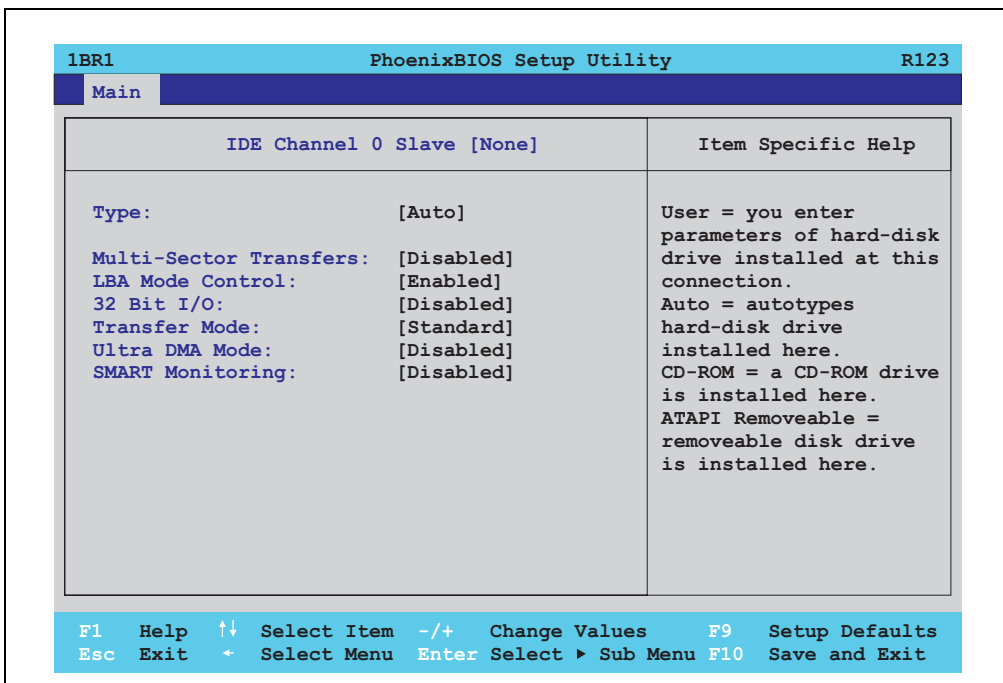

Figure 177: 815E (ETX) IDE Channel 0

BIOS setting	Meaning	Setting options	Effect
Type	The type of drive connected to the primary slave is configured here.	Auto	Automatic recognition of the drive and setup of appropriate values.
		User	Manual setup of the drive (number of cylinders, heads, and sectors).
		Other ATAPI	Use this option for IDE disk drives that are not mentioned here.
		CD-ROM	CD-ROM = CD-ROM drive
		ATAPI removable	The removable media drive is treated as a hard drive or floppy drive.
		IDE removable	The IDE removable drive is treated as a hard drive.
Multi-sector transfer	This option determines the number of sectors per block. Only possible when manually setting up the drive.	Disabled	Disables this function.
		2, 4, 8 or 16 sectors	Number of sectors per block.
LBA mode control	This option activates the logical block addressing for IDE. This function enables support of drives larger than 540 MB. Only possible when manually setting up the drive.	Disabled	Disables this function.
		Enabled	Enables this function.

Table 206: 815E (ETX) IDE Channel 0 Slave setting options

BIOS setting	Meaning	Setting options	Effect
32-bit I/O	This function enables 32-bit data transfer.	Disabled	Disables this function.
		Enabled	Enables this function.
Transfer mode	The communication path between the primary slave drive and the system memory is defined here. Only possible when manually setting up the drive.	Default	Default setting.
		Fast PIO 1 - Fast PIO 4 / DMA2	Manual configuration of PIO mode.
Ultra DMA mode	The data transfer rate to and from the primary slave drive is defined here. The DMA mode must be activated in the Windows device manager in order to guarantee maximum performance. Only possible when manually setting up the drive.	Disabled	Disables this function. Do not use UDMA mode.
		Mode 0 - Mode 5	Manual setting option for UDMA mode.
SMART monitoring	Indicates whether the primary slave drive supports SMART technology.	Disabled	No drive support, and function is deactivated.
		Enabled	Drive support present, and function is activated.

Table 206: 815E (ETX) IDE Channel 0 Slave setting options (Forts.)

IDE channel 1 master

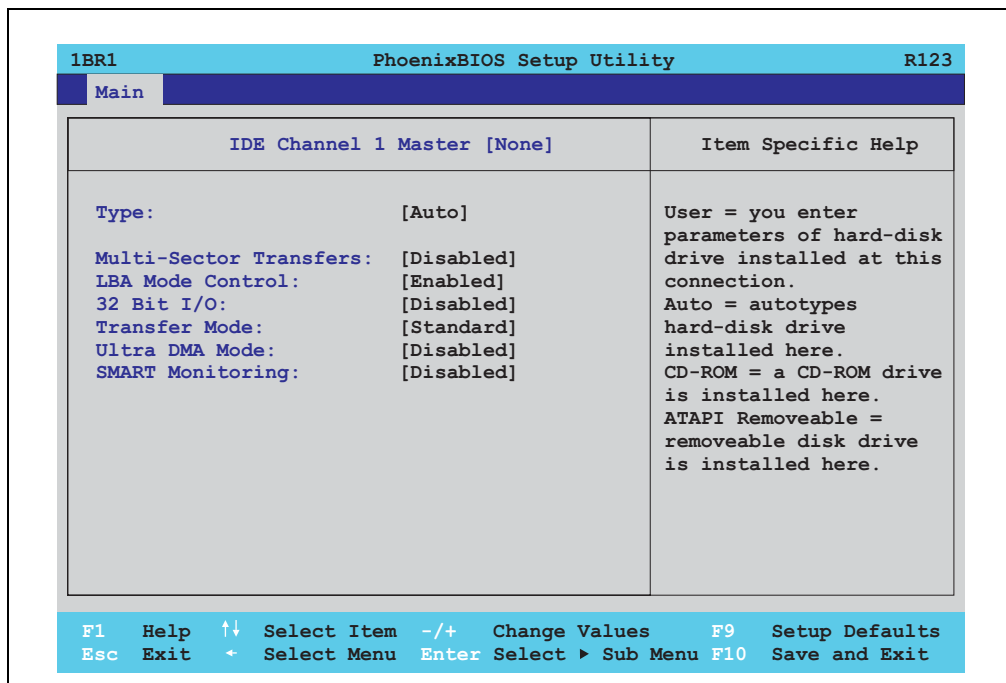

Figure 178: 815E (ETX) IDE Channel 1 Master

BIOS setting	Meaning	Setting options	Effect
Type	The type of drive connected to the secondary master is configured here.	Auto	Automatic recognition of the drive and setup of appropriate values.
		User	Manual setup of the drive (number of cylinders, heads, and sectors).
		Other ATAPI	Use this option for IDE disk drives that are not mentioned here.
		CD-ROM	CD-ROM = CD-ROM drive
		ATAPI removable	The removable media drive is treated as a hard drive or floppy drive.
		IDE removable	The IDE removable drive is treated as a hard drive.
Multi-sector transfer	This option determines the number of sectors per block. Only possible when manually setting up the drive.	Disabled	Disables this function.
		2, 4, 8 or 16 sectors	Number of sectors per block.
LBA mode control	This option activates the logical block addressing for IDE. This function enables support of drives larger than 540 MB. Only possible when manually setting up the drive.	Disabled	Disables this function.
		Enabled	Enables this function.

Table 207: 815E (ETX) IDE Channel 1 Master setting options

BIOS setting	Meaning	Setting options	Effect
32-bit I/O	This function enables 32-bit data transfer.	Disabled	Disables this function.
		Enabled	Enables this function.
Transfer mode	The communication path between the secondary master drive and the system memory is defined here. Only possible when manually setting up the drive.	Default	Default setting.
		Fast PIO 1 - Fast PIO 4 / DMA2	Manual configuration of PIO mode.
Ultra DMA mode	The data transfer rate to and from the secondary master drive is defined here. The DMA mode must be activated in the Windows device manager in order to guarantee maximum performance. Only possible when manually setting up the drive.	Disabled	Disables this function. Do not use UDMA mode.
		Mode 0 - Mode 5	Manual setting option for UDMA mode.
SMART monitoring	Indicates whether the secondary master drive supports SMART technology.	Disabled	No drive support, and function is deactivated.
		Enabled	Drive support present, and function is activated.

Table 207: 815E (ETX) IDE Channel 1 Master setting options (Forts.)

IDE channel 1 slave

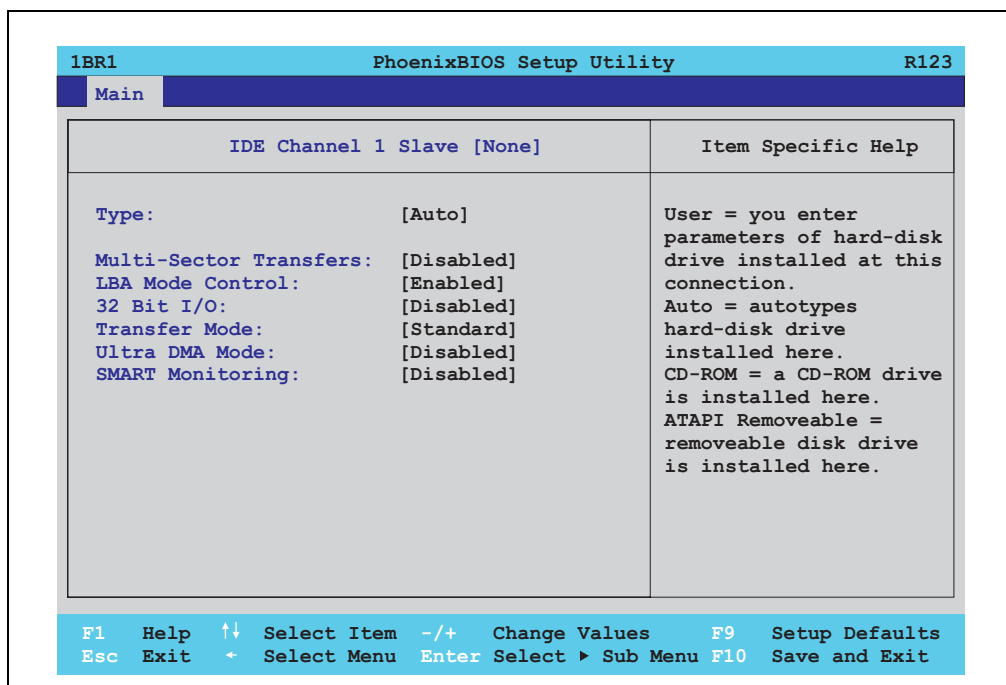

Figure 179: 815E (ETX) IDE Channel 1 Slave

BIOS setting	Meaning	Setting options	Effect
Type	The type of drive connected to the secondary slave is configured here.	Auto	Automatic recognition of the drive and setup of appropriate values.
		User	Manual setup of the drive (number of cylinders, heads, and sectors).
		Other ATAPI	Use this option for IDE disk drives that are not mentioned here.
		CD-ROM	CD-ROM = CD-ROM drive
		ATAPI removable	The removable media drive is treated as a hard drive or floppy drive.
		IDE removable	The IDE removable drive is treated as a hard drive.
Multi-sector transfer	This option determines the number of sectors per block. Only possible when manually setting up the drive.	Disabled	Disables this function.
		2, 4, 8 or 16 sectors	Number of sectors per block.
LBA mode control	This option activates the logical block addressing for IDE. This function enables support of drives larger than 540 MB. Only possible when manually setting up the drive.	Disabled	Disables this function.
		Enabled	Enables this function.

Table 208: 815E (ETX) IDE Channel 1 Slave setting options

BIOS setting	Meaning	Setting options	Effect
32-bit I/O	This function enables 32-bit data transfer.	Disabled	Disables this function.
		Enabled	Enables this function.
Transfer mode	The communication path between the secondary slave drive and the system memory is defined here. Only possible when manually setting up the drive.	Default	Default setting.
		Fast PIO 1 - Fast PIO 4 / DMA2	Manual configuration of PIO mode.
Ultra DMA mode	The data transfer rate to and from the secondary slave is defined here. The DMA mode must be activated in the Windows device manager in order to guarantee maximum performance. Only possible when manually setting up the drive.	Disabled	Disables this function. Do not use UDMA mode.
		Mode 0 - Mode 5	Manual setting option for UDMA mode.
SMART monitoring	Indicates whether the secondary slave drive supports SMART technology.	Disabled	No drive support, and function is deactivated.
		Enabled	Drive support present, and function is activated.

Table 208: 815E (ETX) IDE Channel 1 Slave setting options (Forts.)

1.1.5 Advanced

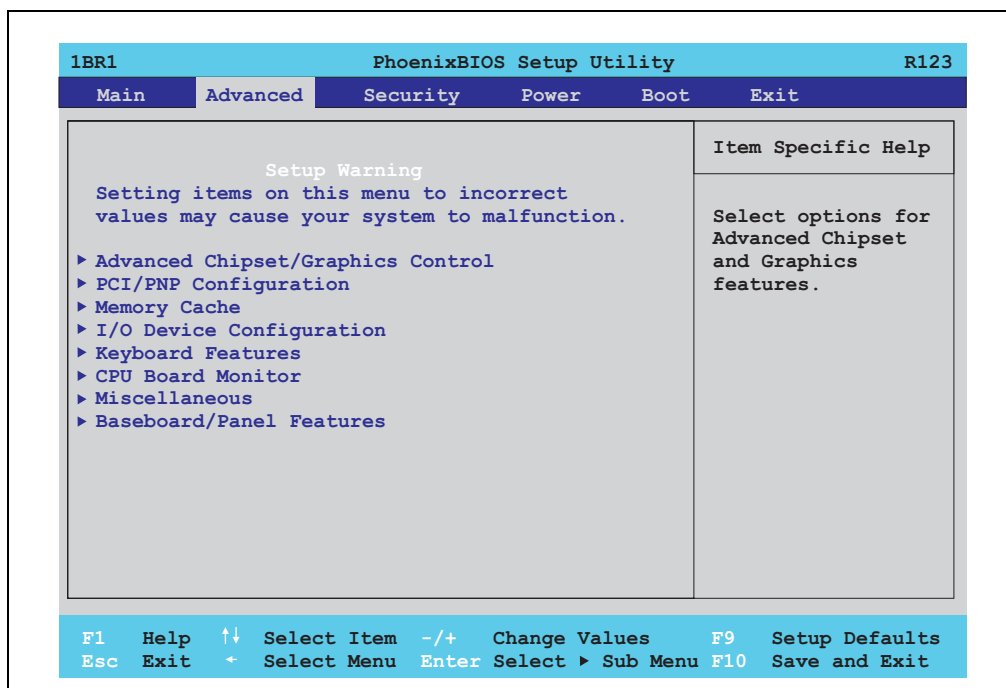

Figure 180: 815E (ETX) Advanced Menu

BIOS setup menu	Meaning	Setting options	Effect
Advanced chipset/graphics control	Setup of advanced chipset and graphics functions.	Enter	Opens the submenu See "Advanced chipset/graphics control", on page 385.
PCI/PNP Configuration	Configures PCI devices.	Enter	Opens the submenu See "PCI/PNP Configuration", on page 387.
Memory cache	Configuration of the memory cache resources.	Enter	Opens the submenu See "Memory cache", on page 393.
I/O Device Configuration	Configures the I/O devices.	Enter	Opens the submenu See "I/O Device Configuration", on page 395.
Keyboard features	Configuration of the keyboard options.	Enter	Opens the submenu See "Keyboard features", on page 398.
CPU board monitor	Displays the current voltages and temperature of the processor in use.	Enter	Opens the submenu See "CPU board monitor", on page 399.
Miscellaneous	Configuration of various BIOS settings (summary screen, halt on errors, etc.).	Enter	Opens the submenu See "Miscellaneous", on page 400.
Main Board/Panel Features	Displays device specific information and setup of device specific values.	Enter	Opens the submenu See "Main Board/Panel Features", on page 401.

Table 209: 815E (ETX) Advanced Menu setting options



## Advanced chipset/graphics control

1BR1		PhoenixBIOS Setup Utility		R123			
Advanced							
Advanced Chipset/Graphics Control			Item Specific Help				
Graphics Engine:			[Auto]				
Graphics Memory Size:			[ 1MB]				
Assign IRQ to VGA:			[Enabled]				
Internal Graphics API Rev: 1.0							
			Select 'Auto' or one of the predefined LCDs: VGA = 640 x 480 1x18 SVGA= 800 x 600 1x18 XGA = 1024x 768 1x18 XGA2= 1024x 768 2x18 SXGA= 1280x1024 2x18  or [Disabled] to disable the onboard video controller.				
F1	Help	↑↓	Select Item	-/+	Change Values	F9	Setup Defaults
Esc	Exit	←	Select Menu	Enter	Select ▶	F10	Save and Exit

Figure 181: 815E (ETX) Advanced Chipset/Graphics Control

BIOS setting	Meaning	Setting options	Effect
Graphics engine	Settings can be made for the onboard video controller.	Auto	Automatic setting of the resolution (using a read-out of the connected panel's EDID data).
		VGA, SVGA, XGA, XGA2, SXGA	VGA = 640 x 480 resolution SVGA = 800 x 600 resolution XGA = 1024 x 768 resolution XGA2 = 1024 x 768 resolution SXGA = 1280 x 1024 resolution
		Disabled	<b>Information:</b> <b>The onboard video must be activated to make video output possible. Deactivate only for use of an external PCI graphics card.</b>
Graphics memory size	Reserves a memory location in the RAM for the onboard graphics controller, into which the memory access will be directed.	1 MB	1 MB main memory is reserved for the onboard video controller.
		512kB	512 k main memory is reserved for the onboard video controller.
Assign IRQ to VGA	This is where an IRQ is reserved and automatically assigned for the CPU board's onboard graphics.	Enabled	Enables this function.
		Disabled	Disables this function.
Internal graphics API Rev	Displays the internal graphics API (Application Programmer Interface) version number.	None	-

Table 210: 815E (ETX) Advanced Chipset/Graphics Control setting options

## PCI/PNP Configuration

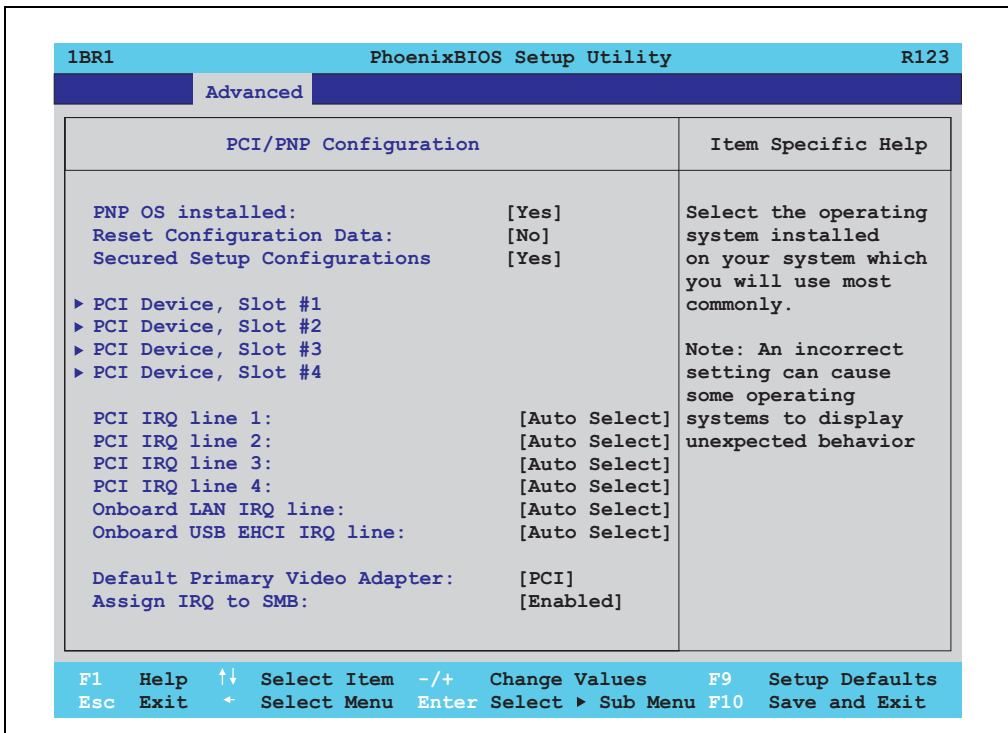

Figure 182: 815E (ETX) PCI/PNP Configuration

BIOS setting	Meaning	Setting options	Effect
PNP OS installed	If the operating system is plug & play capable, then this option informs BIOS that the operating system will handle the distribution of resources in the future.	Yes	The ISA PnP resources are not assigned. The resource assignment sequence is as follows: 1.) Motherboard devices 2. PCI devices
		No	The resource assignment sequence is as follows: 1. Motherboard devices 2. ISA PnP devices 3. PCI devices
Reset configuration data	During booting, the assigned resources are stored in Flash (ESCD).	Yes	When the system is reset after leaving the BIOS setup, all ECSD entries (extended system configuration data) are deleted.
		No	Disables this function. Resources are not reset.
Secured setup configuration	This option protects the setup configuration from interference from a PnP operating system.	Yes	Prevents a PnP operating system from changing system settings.
		No	Disables this function. Changes are allowed.

Table 211: 815E (ETX) PCI/PNP Configuration setting options

## Software • BIOS options

BIOS setting	Meaning	Setting options	Effect
PCI device, slot #1	Advanced configuration of the PCI slot number 1.	Enter	Opens the submenu See "PCI device, slot #1", on page 389
PCI device, slot #2	Advanced configuration of the PCI slot number 2.	Enter	Opens the submenu See "PCI device, slot #2", on page 390
PCI device, slot #3	Advanced configuration of the PCI slot number 3.	Enter	Opens the submenu See "PCI device, slot #3", on page 391
PCI device, slot #4	Advanced configuration of the PCI slot number 4.	Enter	Opens the submenu See "PCI device, slot #4", on page 392
PCI IRQ line 1	Under this option, the external PCI interrupt 1 is assigned to an ISA interrupt.	Auto-select	The interrupt is automatically assigned according to the Plug & Play guidelines.
		Disabled	Disables this function. No assignment.
		3, 4, 5, 7, 8, 9, 10, 11, 12, 14, 15	Manual configuration of the IRQ.
PCI IRQ line 2	Under this option, the external PCI interrupt 2 is assigned to an ISA interrupt.	Auto-select	The interrupt is automatically assigned according to the Plug & Play guidelines.
		Disabled	Disables this function. No assignment.
		3, 4, 5, 7, 8, 9, 10, 11, 12, 14, 15	Manual configuration of the IRQ.
PCI IRQ line 3	Under this option, the external PCI interrupt 3 is assigned to an ISA interrupt.	Auto-select	The interrupt is automatically assigned according to the Plug & Play guidelines.
		Disabled	Disables this function. No assignment.
		3, 4, 5, 7, 8, 9, 10, 11, 12, 14, 15	Manual configuration of the IRQ.
PCI IRQ line 4	Under this option, the external PCI interrupt 4 is assigned to an ISA interrupt.	Auto-select	The interrupt is automatically assigned according to the Plug & Play guidelines.
		Disabled	Disables this function. No assignment.
		3, 4, 5, 7, 8, 9, 10, 11, 12, 14, 15	Manual configuration of the IRQ.
Onboard LAN IRQ line	Under this option, the onboard LAN interrupt is assigned to an ISA interrupt.	Auto-select	The interrupt is automatically assigned according to the Plug & Play guidelines.
		Disabled	Disables this function. No assignment.
		3, 4, 5, 7, 8, 9, 10, 11, 12, 14, 15	Manual configuration of the IRQ.
Onboard USB EHCI IRQ line	Under this option, the USB EHCI interrupt is assigned to an ISA interrupt.	Auto-select	The interrupt is automatically assigned according to the Plug & Play guidelines.
		Disabled	Disables this function. No assignment.
		3, 4, 5, 7, 8, 9, 10, 11, 12, 14, 15	Manual configuration of the IRQ.
Default primary video adapter	This option sets the default graphics card (either an existing AGP or the PCI graphics card).	PCI	A PCI graphics card is set as the default display device.
		AGP	An AGP graphics card is set as the default display device.
Assign IRQ to SMB	Use this function to set whether or not the SM (System Management) bus controller is assigned a PCI interrupt.	Enabled	Automatic assignment of a PCI interrupt.
		Disabled	No assignment of an interrupt.

Table 211: 815E (ETX) PCI/PNP Configuration setting options (Forts.)

PCI device, slot #1

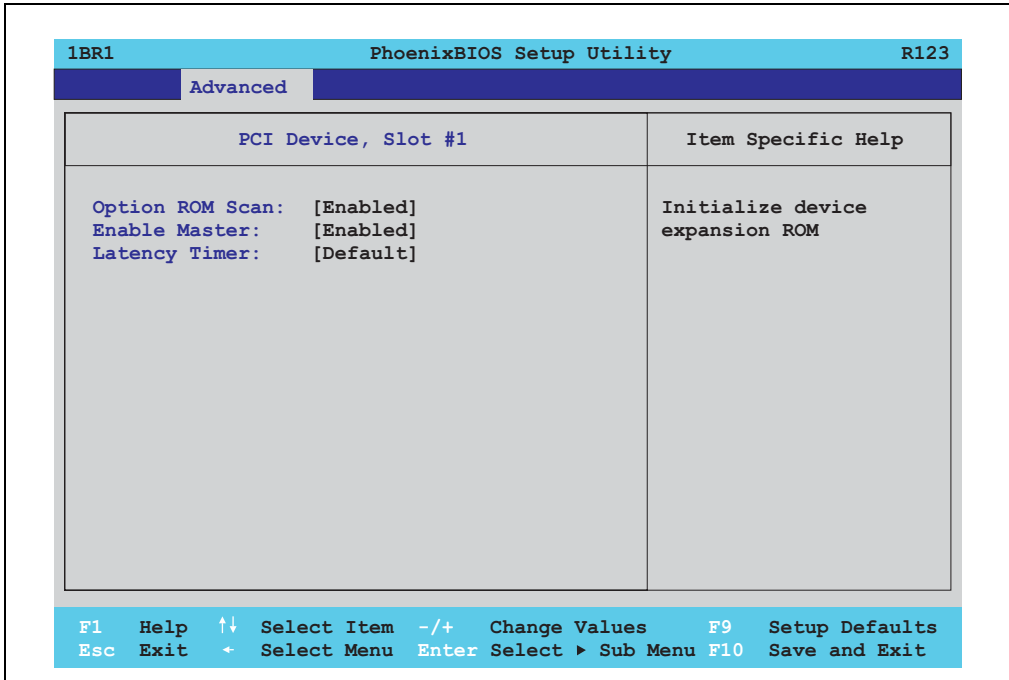

Figure 183: 815E (ETX) PCI device, slot #1

BIOS setting	Meaning	Setting options	Effect
ROM scan option	Setting for the initialization of a device's ROM.	Enabled	Enables this function.
		Disabled	Disables this function.
Enable master	Sets the PCI device to be treated as the PCI bus master. Not all PCI devices can function as PCI bus master! Check device description.	Enabled	Enables this function.
		Disabled	Disables this function.
Latency timer	This option controls how long one card can continue to use the PCI bus master after another PCI card has requested access.	Default	Default setting. Default
		0020h, 0040h, 0060h, 0080h, 00A0h, 00C0h, 00E0h	Value set manually.

Table 212: 815E (ETX) PCI device, slot #1 setting options

[PCI device, slot #2](#)

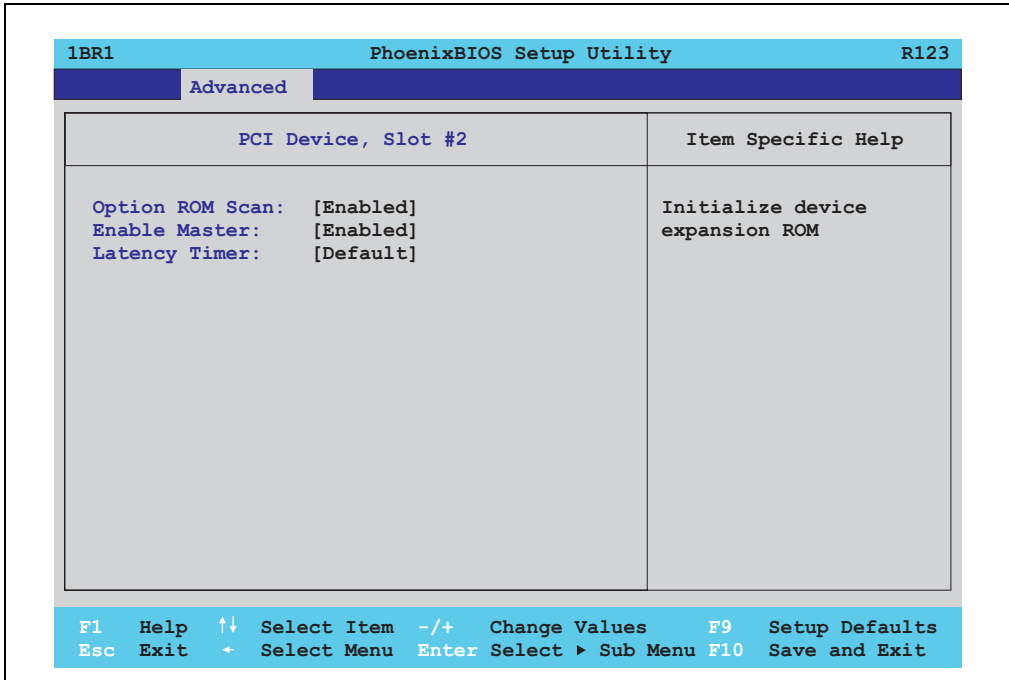

Figure 184: 815E (ETX) PCI device, slot #2

BIOS setting	Meaning	Setting options	Effect
ROM scan option	Setting for the initialization of a device's ROM.	Enabled	Enables this function.
		Disabled	Disables this function.
Enable master	Sets the PCI device to be treated as the PCI bus master. Not all PCI devices can function as PCI bus master! Check device description.	Enabled	Enables this function.
		Disabled	Disables this function.
Latency timer	This option controls how long one card can continue to use the PCI bus master after another PCI card has requested access.	Default	Default setting. Default
		0020h, 0040h, 0060h, 0080h, 00A0h, 00C0h, 00E0h	Value set manually.

Table 213: 815E (ETX) PCI device, slot #2 setting options

PCI device, slot #3

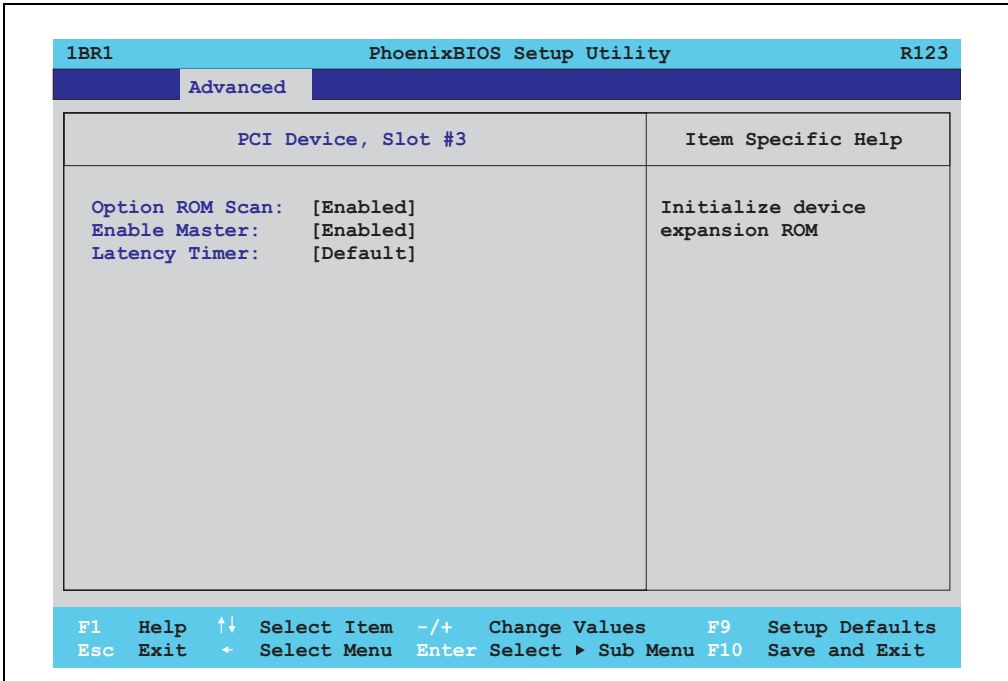

Figure 185: 815E (ETX) PCI device, slot #3

BIOS setting	Meaning	Setting options	Effect
ROM scan option	Setting for the initialization of a device's ROM.	Enabled	Enables this function.
		Disabled	Disables this function.
Enable master	Sets the PCI device to be treated as the PCI bus master. Not all PCI devices can function as PCI bus master! Check device description.	Enabled	Enables this function.
		Disabled	Disables this function.
Latency timer	This option controls how long one card can continue to use the PCI bus master after another PCI card has requested access.	Default	Default setting. Default
		0020h, 0040h, 0060h, 0080h, 00A0h, 00C0h, 00E0h	Value set manually.

Table 214: 815E (ETX) PCI device, slot #3 setting options

[PCI device, slot #4](#)

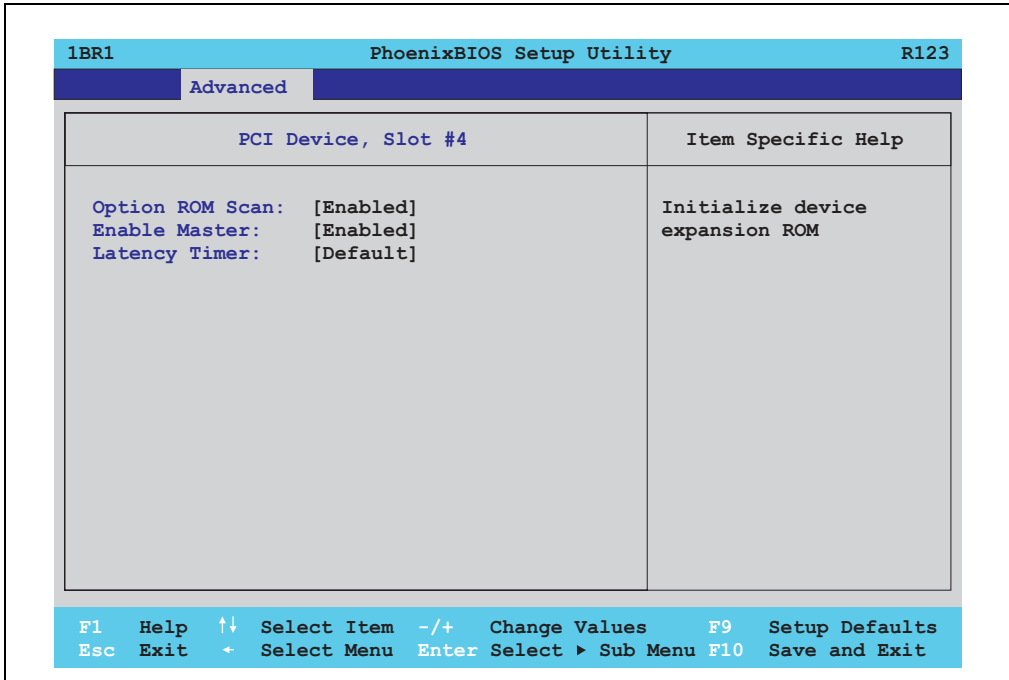

Figure 186: 815E (ETX) PCI device, slot #4

BIOS setting	Meaning	Setting options	Effect
ROM scan option	Setting for the initialization of a device's ROM.	Enabled	Enables this function.
		Disabled	Disables this function.
Enable master	Sets the PCI device to be treated as the PCI bus master. Not all PCI devices can function as PCI bus master! Check device description.	Enabled	Enables this function.
		Disabled	Disables this function.
Latency timer	This option controls how long one card can continue to use the PCI bus master after another PCI card has requested access.	Default	Default setting. Default
		0020h, 0040h, 0060h, 0080h, 00A0h, 00C0h, 00E0h	Value set manually.

Table 215: 815E (ETX) PCI device, slot #4 setting options



Memory cache

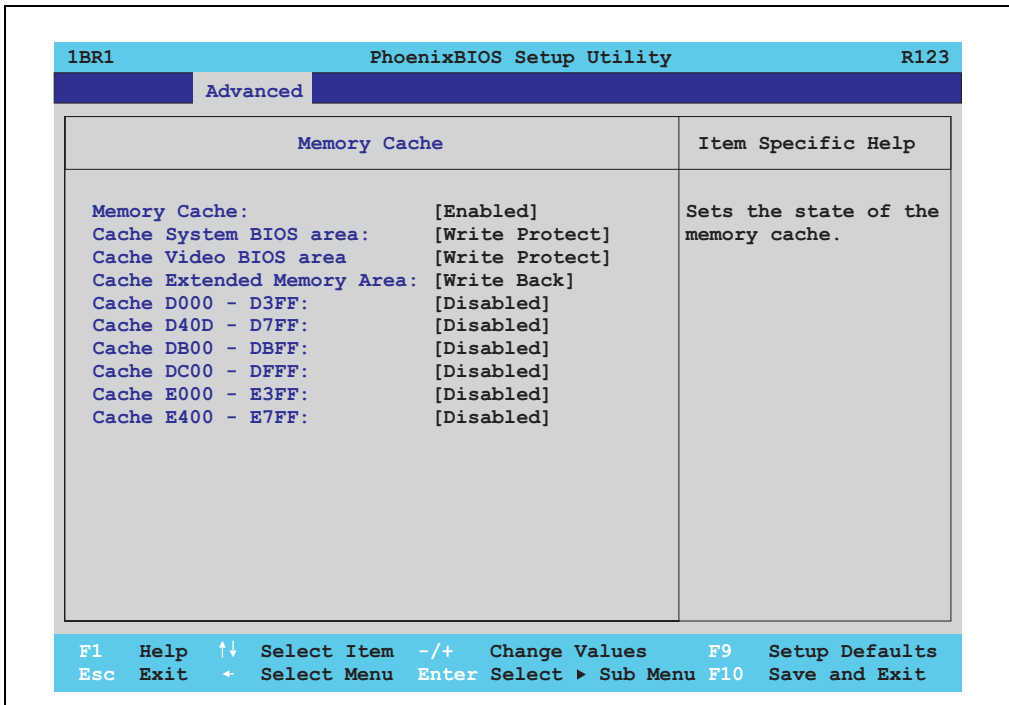

Figure 187: 815E (ETX) Memory Cache

BIOS setting	Meaning	Setting options	Effect
Memory cache	Enable/ disable utilization of the L2 cache.	Enabled	Enables this function.
		Disabled	Disables this function.
Cache system BIOS area	Set whether or not the system BIOS should be buffered.	Write protect	System BIOS is mapped in the cache.
		Uncached	System BIOS is not mapped in the cache.
Cache video BIOS area	Set whether or not the video BIOS should be buffered.	Write protect	Video BIOS is mapped in the cache.
		Uncached	Video BIOS is not mapped in the cache.
Cache extended memory area	Configure how the memory content of the system memory above 1MB should be mapped.	Uncached	No mapping.
		Write through	Memory content is simultaneously mapped in the cache and written to the main memory.
		Write protect	Memory content is mapped in the cache.
		Write back	Memory content is mapped only when necessary.

Table 216: 815E (ETX) Memory Cache setting options

BIOS setting	Meaning	Setting options	Effect
Cache D000 - D3FF	Configure how the memory content of D000-D3FF should be mapped.	Disabled	No mapping.
		Write through	Memory content is simultaneously mapped in the cache and written to the main memory.
		Write protect	Memory content is mapped in the cache.
		Write back	Memory content is mapped only when necessary.
Cache D400 - D7FF	Configure how the memory content of D400-D7FF should be mapped.	Disabled	No mapping.
		Write through	Memory content is simultaneously mapped in the cache and written to the main memory.
		Write protect	Memory content is mapped in the cache.
		Write back	Memory content is mapped only when necessary.
Cache D800 - DBFF	Configure how the memory content of D800-DBFF should be mapped.	Disabled	No mapping.
		Write through	Memory content is simultaneously mapped in the cache and written to the main memory.
		Write protect	Memory content is mapped in the cache.
		Write back	Memory content is mapped only when necessary.
Cache DC00 - DFFF	Configure how the memory content of DC00-DFFF should be mapped.	Disabled	No mapping.
		Write through	Memory content is simultaneously mapped in the cache and written to the main memory.
		Write protect	Memory content is mapped in the cache.
		Write back	Memory content is mapped only when necessary.
Cache E000 - E3FF	Configure how the memory content of E000-E3FF should be mapped.	Disabled	No mapping.
		Write through	Memory content is simultaneously mapped in the cache and written to the main memory.
		Write protect	Memory content is mapped in the cache.
		Write back	Memory content is mapped only when necessary.
Cache E400 - E7FF	Configure how the memory content of E400-E7FF should be mapped.	Disabled	No mapping.
		Write through	Memory content is simultaneously mapped in the cache and written to the main memory.
		Write protect	Memory content is mapped in the cache.
		Write back	Memory content is mapped only when necessary.

Table 216: 815E (ETX) Memory Cache setting options (Forts.)

I/O Device Configuration

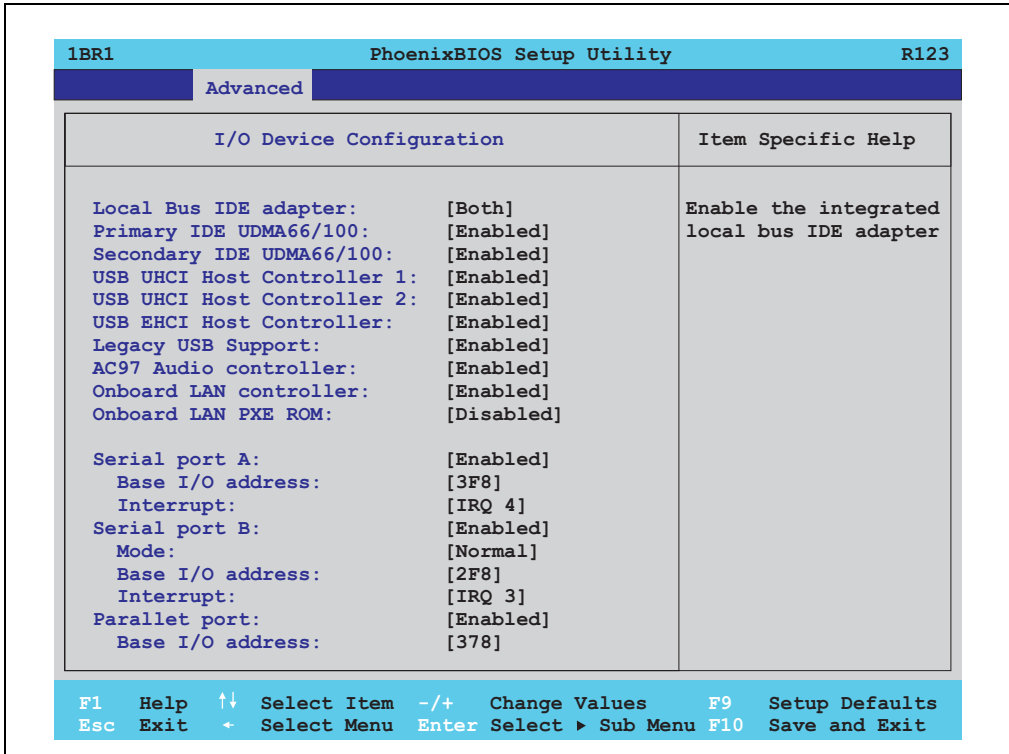

Figure 188: 815E (ETX) I/O Device Configuration

BIOS setting	Meaning	Setting options	Effect
Local bus IDE adapter	Enable or disable one or both of the PCI IDE controllers (primary and secondary).	Disabled	Deactivates both PCI IDE controllers (primary and secondary).
		Primary	Activates the primary IDE controller only.
		Secondary	Activates the secondary IDE controller only.
		Both	Activates both PCI IDE controllers (primary and secondary).
Primary IDE UDMA66/100	Setup the data transfer rate for a device connected to the primary IDE channel. This option is only available when a primary IDE drive is connected.	Disabled	The maximum data transfer rate is UDMA33.
		Enabled	The maximum data transfer rate is UDMA66 or higher.
Secondary IDE UDMA66/100	Setup the data transfer rate for a device connected to the secondary IDE channel. This option is only available when a secondary IDE drive is connected.	Disabled	The maximum data transfer rate is UDMA33.
		Enabled	The maximum data transfer rate is UDMA66.

Table 217: 815E (ETX) I/O Device Configuration setting options

## Software • BIOS options

BIOS setting	Meaning	Setting options	Effect
USB UHCI host controller 1	Configuration of USB UHCI controller 1 for USB port 0 and 1.	Disabled	Deactivates the USB support.
		Enabled	Activates the USB support.
USB UHCI host controller 2	Configuration of the USB UHCI controller 1 for USB port 2 and 3. Can only be configured if the USB UHCI controller 1 is activated.	Disabled	Deactivates the USB support.
		Enabled	Activates the USB support.
USB UHCI host controller	Configuration of the USB EHCI controller. Can only be configured if the USB UHCI controller 1 is activated.	Disabled	Deactivates the USB support.
		Enabled	When enabled, the USB 2.0 support is activated as soon as a USB 2.0 device is connected to the interface.
Legacy USB Support	Here IRQs are assigned to the USB connections.	Disabled	No IRQ assigned.  It is not possible to boot from a USB device (USB stick, USB floppy, USB CD ROM, etc.)! However, a connected USB keyboard can be used to access and configure the BIOS setup, boot menu or optional RAID boot menu. USB devices will not function after completing the BIOS POST routine. USB devices only work after starting the operating system with USB support (e.g. Windows XP). MS-DOS does not support the use of USB devices.
		Enabled	IRQ assigned.  Booting from USB devices is now possible. Supported USB devices work with MS-DOS (e.g. USB keyboard, etc).
AC97 audio controller	For turning the AC97 audio controller on and off.	Disabled	AC97 sound is deactivated.
		Enabled	AC97 sound is activated.
Onboard LAN controller	For turning the ICH4 on-board LAN controller (for ETH1) on and off.	Disabled	Deactivates the LAN controller or the ETH1 interface.
		Enabled	Activates the LAN controller or the ETH1 interface.
Onboard LAN PXE ROM	For turning the remote boot BIOS extension for the onboard LAN controller (ETH1) on and off.	Disabled	Disables this function.
		Enabled	Enables this function.
Serial port A	For the configuration of serial port A (COM1).	Disabled	Port A deactivated.
		Enabled	Port A activated. The base I/O addresses and the interrupt must then be configured manually.
		Auto	Either BIOS or the operating system configures the port automatically.
Base I/O address	Selection of the base I/O address for port A. A yellow star indicates a conflict with another device.	3F8, 2F8, 3E8, 2E8	Base I/O address is manually assigned.
Interrupt	Selection of the interrupt for port A. A yellow star indicates a conflict with another device.	IRQ 3, IRQ 4	Manual assignment of the interrupt.

Table 217: 815E (ETX) I/O Device Configuration setting options (Forts.)

BIOS setting	Meaning	Setting options	Effect
Serial port B	For the configuration of serial port B (COM2).	Disabled	Port B deactivated.
		Enabled	Port A activated. The base I/O addresses and the interrupt must then be configured manually.
		Auto	Either BIOS or the operating system configures the port automatically.
Mode	This option is for setting the serial port B as either a standard interface or as an infrared interface.	Normal	Serial port B is used as a standard interface.
		IR	The serial interface is used as an infrared interface, and allows data transfers up to 115 kBit/s.
Base I/O address	Selection of the base I/O address for port B. A yellow star indicates a conflict with another device.	3F8, 2F8, 3E8, 2E8	Selected base I/O address is manually assigned.
Interrupt	Selection of the interrupt for port B. A yellow star indicates a conflict with another device.	IRQ 3, IRQ 4	Selected interrupt is manually assigned.
Parallel port	For configuring the hardware security key (dongle), which accessed internally through the parallel interface.	Disabled	Deactivates the port.
		Enabled	Activates the port. The base I/O address must then be set.
		Auto	First BIOS and then the operating system configure the port automatically.
Base I/O address	Selection of the base I/O address for the parallel port.	378, 278, 3BC	Base I/O address is manually assigned.

Table 217: 815E (ETX) I/O Device Configuration setting options (Forts.)

Keyboard features

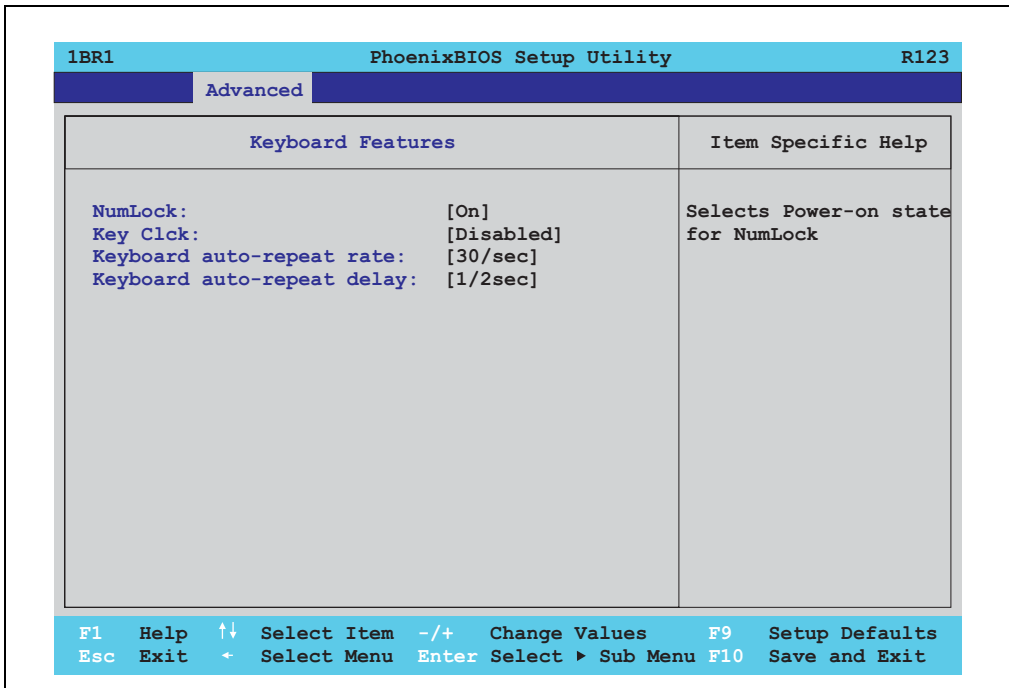

Figure 189: 815E (ETX) Keyboard Features

BIOS setting	Meaning	Setting options	Effect
NumLock	This option sets the status of the numeric keypad when the the system is booted.	On	Numeric keypad is enabled.
		Off	Only the cursor functions of the numerical keypad are activated.
		Auto	Numeric keypad is activated, if present.
Key click	Using this option, the clicking of the keys can be turned on or off.	Disabled	Disables this function.
		Enabled	Enables this function.
Keyboard auto-repeat rate	For setting the speed of repetition when a key is held down.	30/sec, 26.7/sec, 21.8/sec, 18.5/sec, 13.3/sec, 10/sec, 6/sec, 2/sec	Settings from 2 to 30 characters per second.
Keyboard auto-repeat delay	For setting the amount of delay after the key is pressed before the auto-repeat begins.	1/4 sec, 1/2 sec, 3/4 sec, 1 sec	Setting of the desired delay.

Table 218: 815E (ETX) Keyboard Features setting options

## CPU board monitor

**Information:**

The displayed voltage values (e.g. core voltage, battery voltage) on this BIOS Setup page represent uncalibrated information values. These cannot be used to draw any conclusions about any hardware alarms or error conditions. The hardware components used have automatic diagnostics functions that can be applied in the event of error.

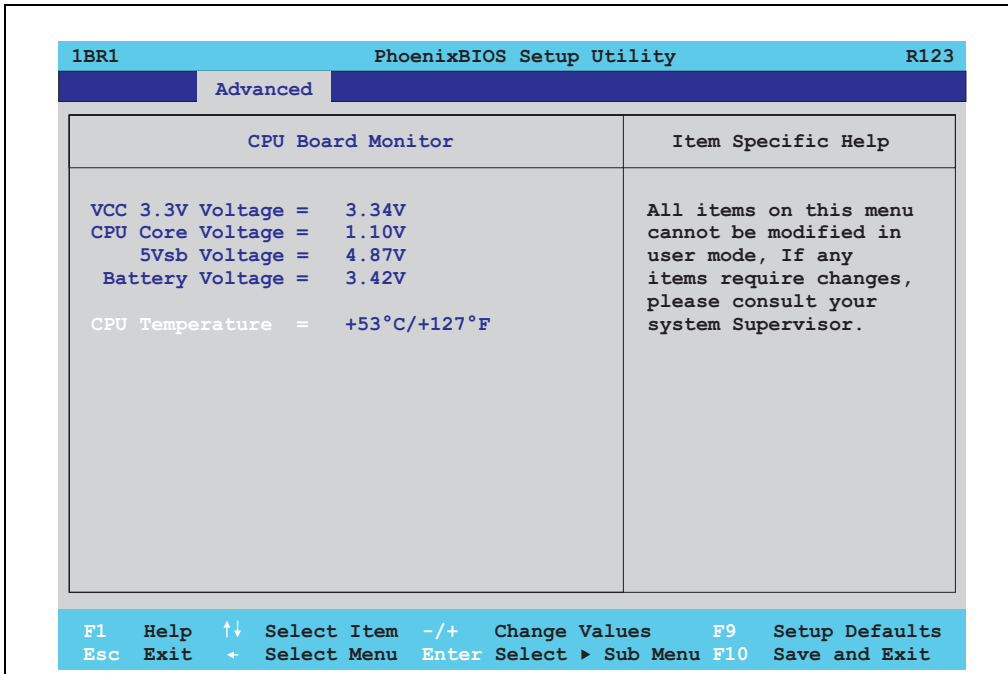

Figure 190: 815E (ETX) CPU Board Monitor

BIOS setting	Meaning	Setting options	Effect
VCC 3.3V voltage	Displays the current voltage of the 3.3 volt supply (in volts).	None	
CPU core voltage	Displays the processor's core voltage (in volts).	None	
5Vsb voltage	Displays the 5 V standby voltage (in volts).	None	
Battery voltage	Displays the battery voltage (in volts).	None	
CPU temperature	Displays the processor's temperature (in degrees Celsius and Fahrenheit).	None	

Table 219: 815E (ETX) CPU Board Monitor setting options

Miscellaneous

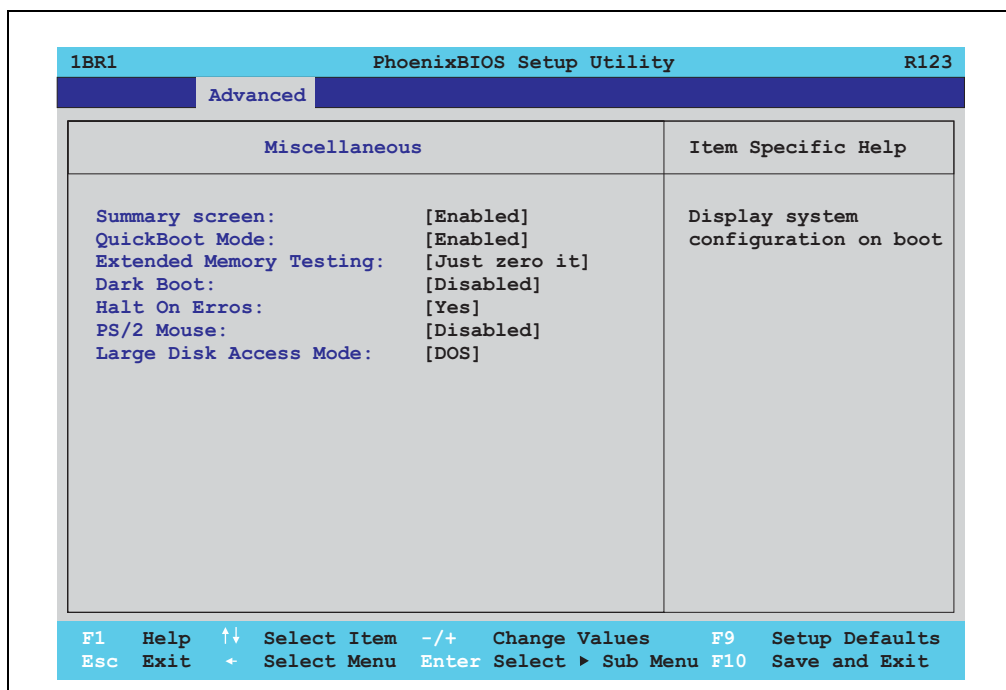

Figure 191: 815E (ETX) Miscellaneous

BIOS setting	Meaning	Setting options	Effect
Summary screen	Set whether or not the system summary screen should open when the system is started (see figure 174 "815E (ETX) BIOS Summary screen", on page 373).	Enabled	Enables this function.
		Disabled	Disables this function.
QuickBoot mode	Speeds up the booting process by skipping several tests.	Enabled	Enables this function.
		Disabled	Disables this function.
Extended memory testing	This function determines the method by which the main memory over 1 MB is tested.	Just zero it	The main memory is quickly tested.
		None	The main memory is not tested at all.
		Normal	This option is only available when the function "QuickBoot Mode" has been set to "disabled." The main memory is tested more slowly than with "Just zero It."
Dark boot	Sets whether the diagnostics screen (see figure 173 "815E (ETX) BIOS diagnostic screen", on page 372) should be displayed when the system is started.	Enabled	Enables this function. The diagnostics screen is not displayed.
		Disabled	Disables this function. The diagnostics screen is displayed.

Table 220: 815E (ETX) Miscellaneous setting options



BIOS setting	Meaning	Setting options	Effect
Halt on errors	This option sets whether the system should pause the Power On Self Test (POST) when it encounters an error.	Yes	The system pauses. The system pauses every time an error is encountered.
		No	The system does not pause. All errors are ignored.
PS/2 mouse	Sets whether the PS/2 mouse port should be activated.	Disabled	Deactivates the port.
		Enabled	Activates the port. The IRQ12 is reserved, and is not available for other components.
Large disk access mode	This option is intended for hard discs with more than 1024 cylinders, 16 heads, and more than 63 sectors per track. Setting options: DOS	Other	For non-compatible access (e.g. Novell, SCO Unix.)
		DOS	For MS DOS compatible access.

Table 220: 815E (ETX) Miscellaneous setting options (Forts.)

## Main Board/Panel Features

The screenshot shows the PhoenixBIOS Setup Utility interface. At the top, it says '1BR1 PhoenixBIOS Setup Utility R123'. The 'Advanced' menu is selected, and the 'Baseboard/Panel Features' option is highlighted. The main display area shows a list of features: Panel Control, Baseboard Monitor, and Legacy Devices. Below these, it lists 'Versions' with BIOS: R123, MTCX PX32: V1.63, and MTCX FPGA: V1.19. Further down, it shows various IDs: Optimized ID: 00000010b, Device ID: 00001BB7h, Compatibility ID: 0000h, Serial Number: 70950173619, Product Name: 5PC600.SX02-01, and User Serial ID: FFFFFFFFh. At the bottom, a legend explains the navigation keys: F1 Help (up/down arrows), Esc Exit (left arrow), Select Item (-/+), Change Values (F9), Select Menu (Enter), Select (right arrow), Sub Menu (F10), Setup Defaults, and Save and Exit.

Figure 192: 815E (ETX) Baseboard/Panel Features

BIOS setting	Meaning	Setting options	Effect
Panel control	For special setup of connected panels (display units).	Enter	Opens the submenu See "Panel control", on page 403
Main board monitor	Display of various temperatures and fan speeds.	Enter	Opens the submenu See "Main board monitor", on page 404

Table 221: 815E (ETX) Baseboard/Panel Features setting options

## Software • BIOS options

BIOS setting	Meaning	Setting options	Effect
Legacy devices		Enter	Opens the submenu See "Legacy devices", on page 405
BIOS	Displays the BIOS version.	None	
MTCX PX32	Displays the MTCX PX32 firmware version.	None	
MTCX FPGA	Displays the MTCX FPGA firmware version.	None	
Optimized ID	Displays the DIP switch setting of the configuration switch.	None	
Device ID	Displays the hexadecimal value of the hardware device ID.	None	
Compatibility ID	Displays the version of the device within the same B&R device code. This ID is needed for Automation Runtime.	None	
Serial Number	Displays the B&R serial number.	None	
Product name	Displays the B&R model number.	None	
User serial ID	Displays the user serial ID. This 8 digit hex value can be freely assigned by the user (e.g. to give the device a unique ID) and can only be changed with using the "B&R Control Center" via the ADI driver.	None	

Table 221: 815E (ETX) Baseboard/Panel Features setting options

Panel control

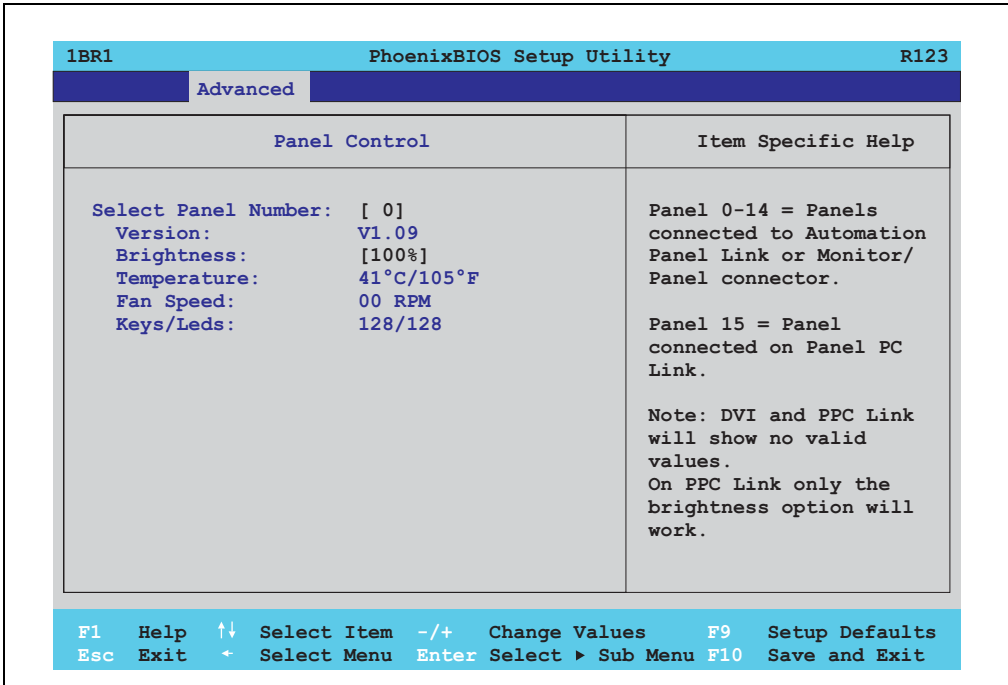

Figure 193: 815E (ETX) Panel Control

BIOS setting	Meaning	Setting options	Effect
Select panel number	Selection of the panel number for which the values should be read out and/or changed.	0 ... 15	Selection of panel 0 ... 15. Panel 15 is specifically intended for panel PC 700 systems.
Version	Displays the firmware version of the SDLR controller.	None	
Brightness	For setting the brightness of the selected panel.	0%, 25%, 50%, 75%, 100%	For setting the brightness (in %) of the selected panel. Changes take effect after saving and restarting the system (e.g. by pressing <F10>).
Temperature	Displays the selected panel's temperature (in degrees Celsius and Fahrenheit).	None	
Fan speed	Displays fan speed for the selected panel.	None	
Keys/LEDs	Displays the available keys and LEDs on the selected panel.	None	

Table 222: 815E (ETX) Panel Control setting options

[Main board monitor](#)

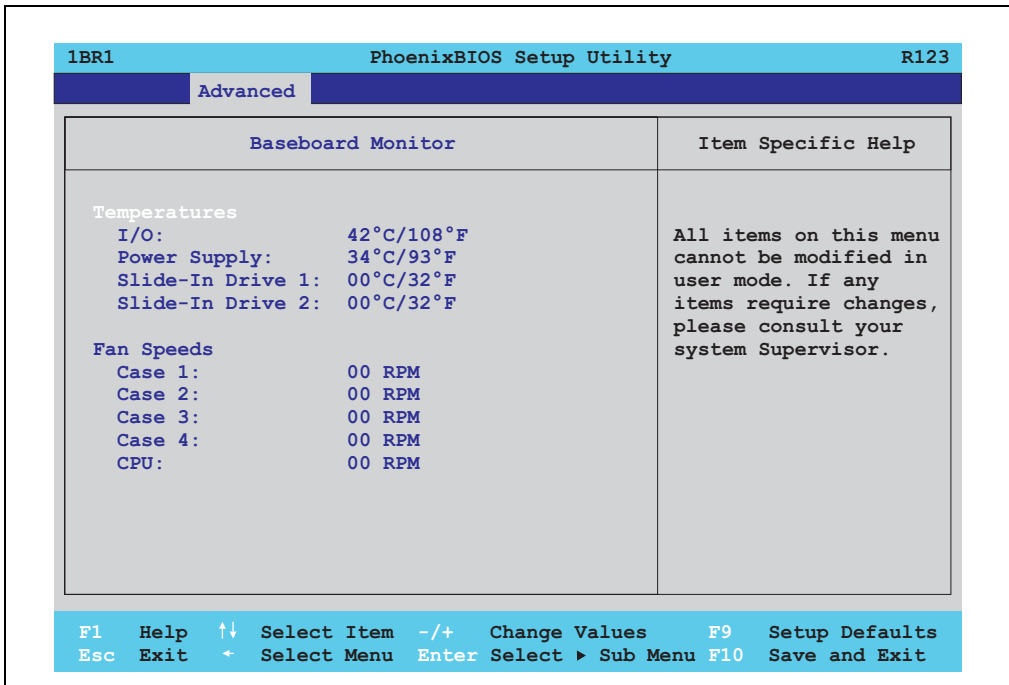

Figure 194: 815E (ETX) Baseboard Monitor

BIOS setting	Meaning	Setting options	Effect
I/O	Displays the temperature in the I/O area in degrees Celsius and Fahrenheit.	None	
Power supply	Displays the temperature in the power supply area in degrees Celsius and Fahrenheit.	None	
Slide-in drive 1	Displays the temperature of the slide-in drive 1 in degrees Celsius and Fahrenheit.	None	
Slide-in drive 2	Displays the temperature of the slide-in drive 2 in degrees Celsius and Fahrenheit.	None	
Case 1	Displays the fan speed of housing fan 1.	None	
Case 2	Displays the fan speed of housing fan 2.	None	
Case 3	Displays the fan speed of housing fan 3.	None	
Case 4	Displays the fan speed of housing fan 4.	None	
CPU	Displays the fan speed of the processor fan.	None	

Table 223: 815E (ETX) Baseboard Monitor setting options

Legacy devices

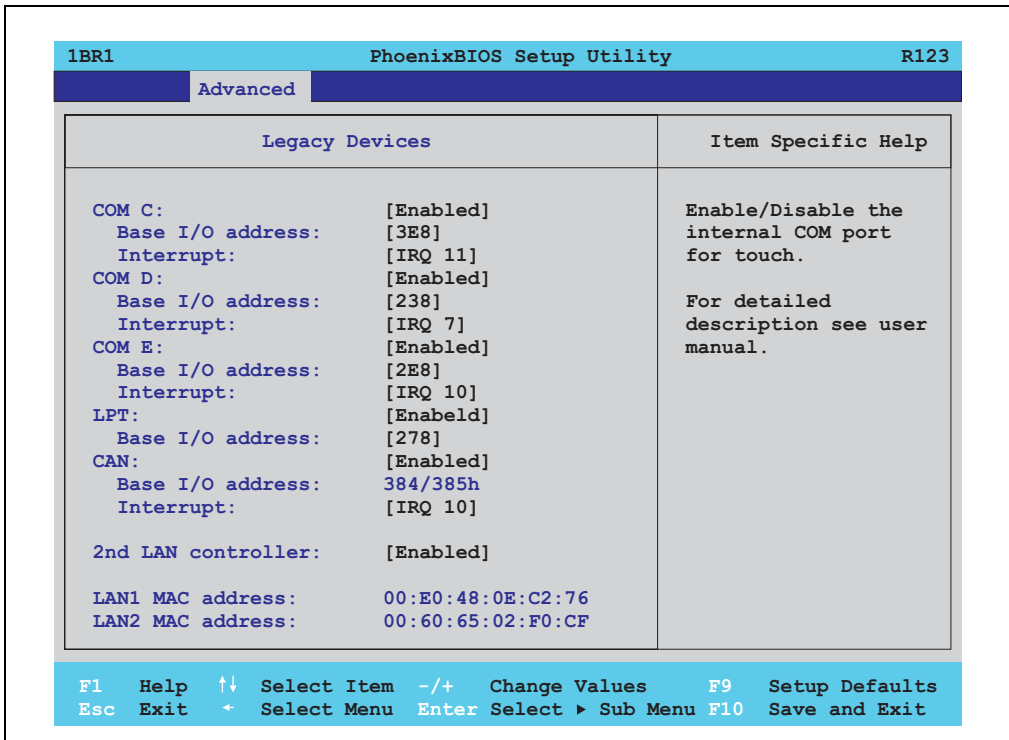

Figure 195: 815E (ETX) Legacy Devices

BIOS setting	Meaning	Setting options	Effect
COM C	Settings for the internal serial interfaces in the system. This setting activates the touch screen in panel PC 700 systems, and, using SDL transfer technology, also in Automation Panel 900 display units.	Disabled	Disables the interface.
		Enabled	Enables the interface.
Base I/O address	Selection of the base I/O address for the COM C port. A yellow star indicates a conflict with another device.	238, 2E8, 2F8, 328, 338, 3E8, 3F8	Selected base I/O address is assigned.
Interrupt	Selection of the interrupt for the COM C port. A yellow star indicates a conflict with another device.	IRQ 3, IRQ 4, IRQ 5, IRQ 10, IRQ 11, IRQ 12, IRQ 15	Selected interrupt is assigned.
COM D	Configuration of the COM D port for the serial interface of an automation panel link slot. The interface is used to operate the touch screen on connected Automation Panel 900 units.	Disabled	Disables the interface.
		Enabled	Enables the interface.

Table 224: 815E (ETX) Legacy Devices setting options

## Software • BIOS options

BIOS setting	Meaning	Setting options	Effect
Base I/O address	Configuration of the base I/O address for the serial COM D port. A yellow star indicates a conflict with another device.	238, 2E8, 2F8, 328, 338, 3E8, 3F8	Selected base I/O address is assigned.
Interrupt	Selection of the interrupt for the COM D port. A yellow star indicates a conflict with another device.	IRQ 3, IRQ 4, IRQ 5, IRQ 10, IRQ 11, IRQ 12, IRQ 15	Selected interrupt is assigned.
COM E	Configuration of the optional COM E port on a B&R add-on interface (IF option).	Disabled	Disables the interface.
		Enabled	Enables the interface.
Base I/O address	Configuration of the base I/O address for the serial COM E port. A yellow star indicates a conflict with another device.	238, 2E8, 2F8, 328, 338, 3E8, 3F8	Selected base I/O address is assigned.
Interrupt	Selection of the interrupt for the COM E port. A yellow star indicates a conflict with another device.	IRQ 3, IRQ 4, IRQ 5, IRQ 10, IRQ 11, IRQ 12, IRQ 15	Selected interrupt is assigned.
LPT	This setting is specific to B&R and should not be changed.	Disabled	Disables the interface.
		Enabled	Enables the interface.
Base I/O address	Configuration of the base I/O address for the optional LPT. A yellow star indicates a conflict with another device.	278, 378, 3BC	Selected base I/O address is assigned.
CAN	Configuration of the CAN port of a B&R add-on CAN interface card (IF option).	Disabled	Disables the interface.
		Enabled	Enables the interface.
Base I/O address	384/385h	None	-
Interrupt	Selection of the interrupt for the CAN port.	IRQ 10	Selected interrupt is assigned.
		NMI	NMI interrupt is assigned.
2nd LAN controller	For turning the onboard LAN controller (ETH2) on and off.	Disabled	Disables the controller.
		Enabled	Enables the controller.
LAN1 MAC address	Displays the MAC addresses for the ETH1 network controller.	-	
LAN2 MAC address	Displays the MAC addresses for the ETH2 network controller.	-	

Table 224: 815E (ETX) Legacy Devices setting options (Forts.)

1.1.6 Security

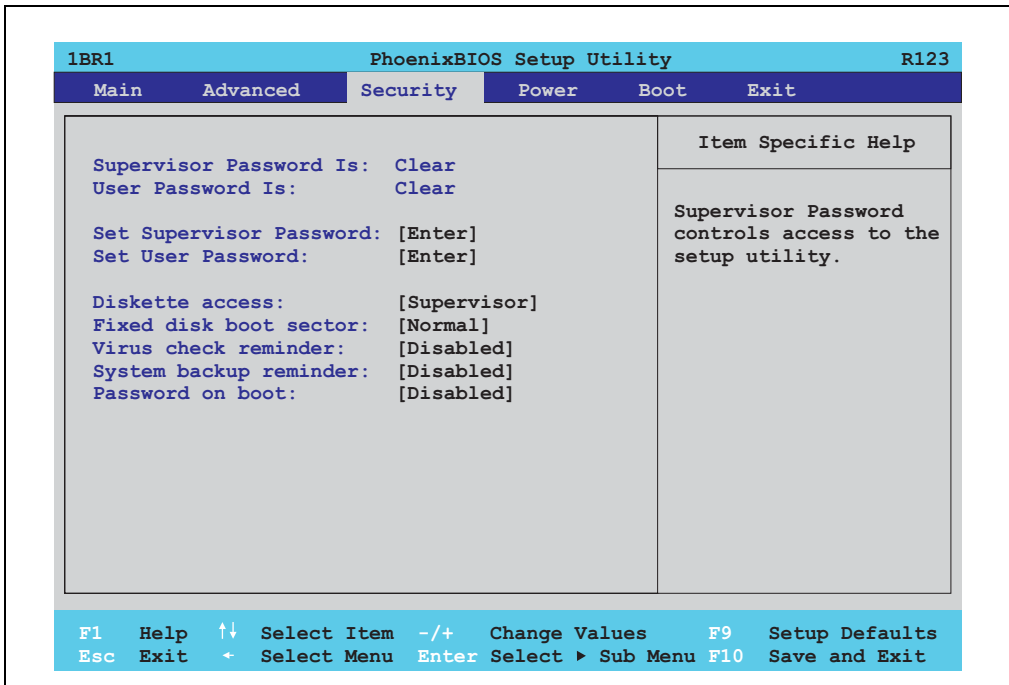

Figure 196: 815E (ETX) Security Menu

BIOS setting	Meaning	Setting options	Effect
Supervisor password is	Displays whether or not a supervisor password has been set.	None	Display <b>set</b> : A supervisor password has been set. Display <b>clear</b> : No supervisor password has been set.
User password is	Displays whether or not a user password has been set.	None	Display <b>set</b> : A user password has been set. Display <b>clear</b> : No user password has been set.
Set supervisor password	To enter/change a supervisor password. A supervisor password is necessary to edit all BIOS settings.	Enter maximum 7 alphanumeric characters - not case sensitive.	Press Enter and enter password two times. The password must be 7 alphanumeric characters or less. Needed to enter BIOS setup. To change the password, enter the old password once and then the new password twice.
Set user password	To enter/change a user password. A user password allows the user to edit only certain BIOS settings.	Enter maximum 7 alphanumeric characters - not case sensitive.	Press Enter and enter password two times. The password must be 7 alphanumeric characters or less. Needed to enter BIOS setup. To change the password, enter the old password once and then the new password twice.

Table 225: 815E (ETX) Security setting options

## Software • BIOS options

BIOS setting	Meaning	Setting options	Effect
Diskette access	Access to the diskette drive is controlled here. Either or the supervisor or the user has access to it. Does not work with USB diskette drives.	Supervisor	Supervisor password is needed to access a diskette drive.
		User	User password is needed to access a diskette drive.
Fixed disk boot sector	The boot sector of the primary hard drive can be write protected against viruses with this option.	Normal	Write access allowed.
		Write protect	Boot sector is write protected.
Virus check reminder	This function opens a reminder when the system is started to scan for viruses.	Disabled	Disables this function.
		Daily	A reminder appears every day when the system is started.
		Weekly	A reminder appears the first time the system is started after every Sunday.
		Monthly	A reminder appears the first time the system is started each month.
System backup reminder	This function opens a reminder when the system is started to create a system backup.	Disabled	Disables this function.
		Daily	A reminder appears every day when the system is started.
		Weekly	A reminder appears the first time the system is started after every Sunday.
		Monthly	A reminder appears the first time the system is started each month.
Password at boot	This function requires a supervisor or user password when the system is started. Only possible when a supervisor or user password is enabled.	Disabled	Disables this function.
		Enabled	Enables this function.

Table 225: 815E (ETX) Security setting options (Forts.)



1.1.7 Power

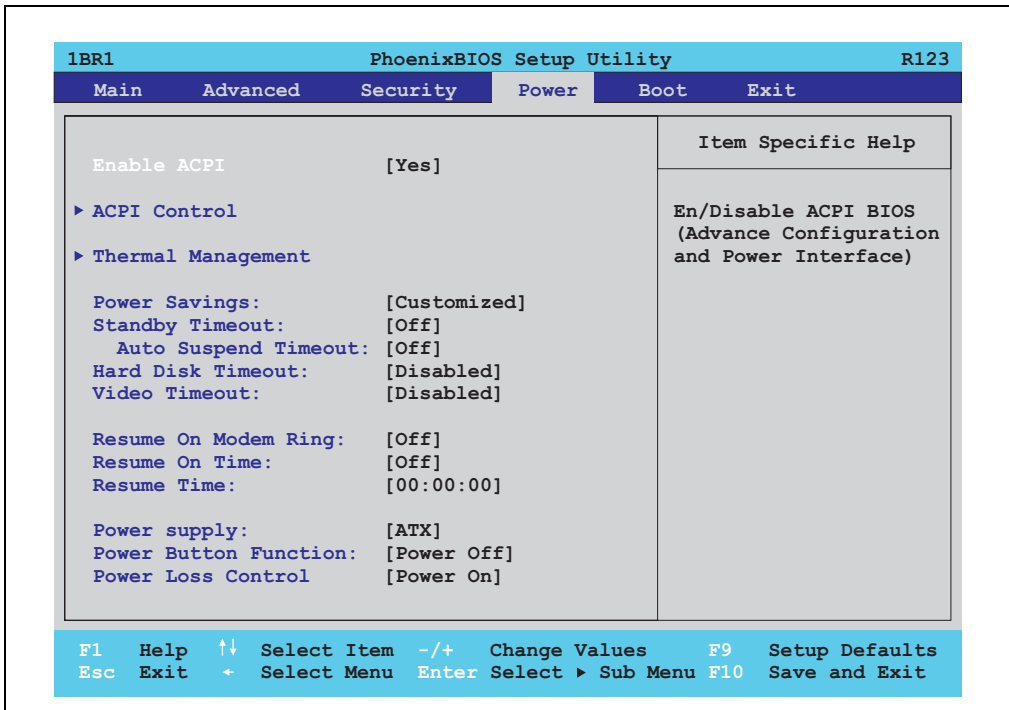

Figure 197: 815E (ETX) Power Menu

BIOS setting	Meaning	Setting options	Effect
Enable ACPI	This option turns the ACPI function (Advanced Configuration and Power Interface) on or off. This is an advanced plug & play and power management functionality.	Yes	Enables this function.
		No	Disables this function.
ACPI control	Configuration of specific limits.	Enter	Opens the submenu See "ACPI control", on page 411
Thermal management	Configuration of specific CPU limits.	Enter	Opens the submenu See "Thermal management", on page 412
Power savings	This function determines if and how the power save function is used.	Disabled	Deactivates the power savings function.
		Customized	Power management is configured by adjusting the individual settings.
		Maximum power Savings	Maximum power savings function.
		Maximum performance	Power savings function to maximize performance.

Table 226: 815E (ETX) Power setting options

## Software • BIOS options

BIOS setting	Meaning	Setting options	Effect
Standby timeout	Set here when the system should enter standby mode. During standby, various devices and the display will be deactivated. This option only available when "power savings" is set to customized.	Off	No standby.
		1, 2, 4, 8 minutes	Time in minutes until standby.
Auto suspend timeout	Set here when the system should enter suspend mode to save electricity. This option only available when "power savings" is set to customized.	Off	No standby.
		5, 10, 15, 20, 30, 40, 60 Minutes	Time in minutes until standby.
Hard disk timeout	Set here how long after the last access the hard disk should enter standby mode. This option only available when "power savings" is set to customized.	Disabled	Disables this function.
		10, 15, 30, 45 seconds	Time in seconds until standby.
		1, 2, 4, 6, 8, 10, 15 Minutes	Time in minutes until standby.
Video timeout		Disabled	
Resume on modem ring	If an external modem is connected to a serial port and the telephone rings, the system starts up.	Off	Disables this function.
		On	Enables this function.
Resume on time	This function enables the system to start at the time set under "resume time."	Off	Disables this function.
		On	Enables this function.
Resume time	Time setting for the option "resume on time" (when the system should start up).	[00:00:00]	Personal setting of the time in the format (hh:mm:ss).
Power supply	The type of power supply being used can be entered here.	ATX	An ATX compatible power supply is being used.  <b>Information:</b> <b>Since the APC620 contains an ATX power supply, ATX should be selected.</b>
		AT	An AT compatible power supply is being used.
Power button Function	This option determines the function of the power button.	Power off	Shuts down the system.
		Sleep	The system enters sleep mode.
Power Loss Control	This option determines how the system reacts to a power outage.	Stay off	The system does not turn back on. The system remains off until the power button is pressed.
		Power-on	The system turns back on.
		Last State	The system resumes the last state it was in before the power outage.

Table 226: 815E (ETX) Power setting options (Forts.)

ACPI control

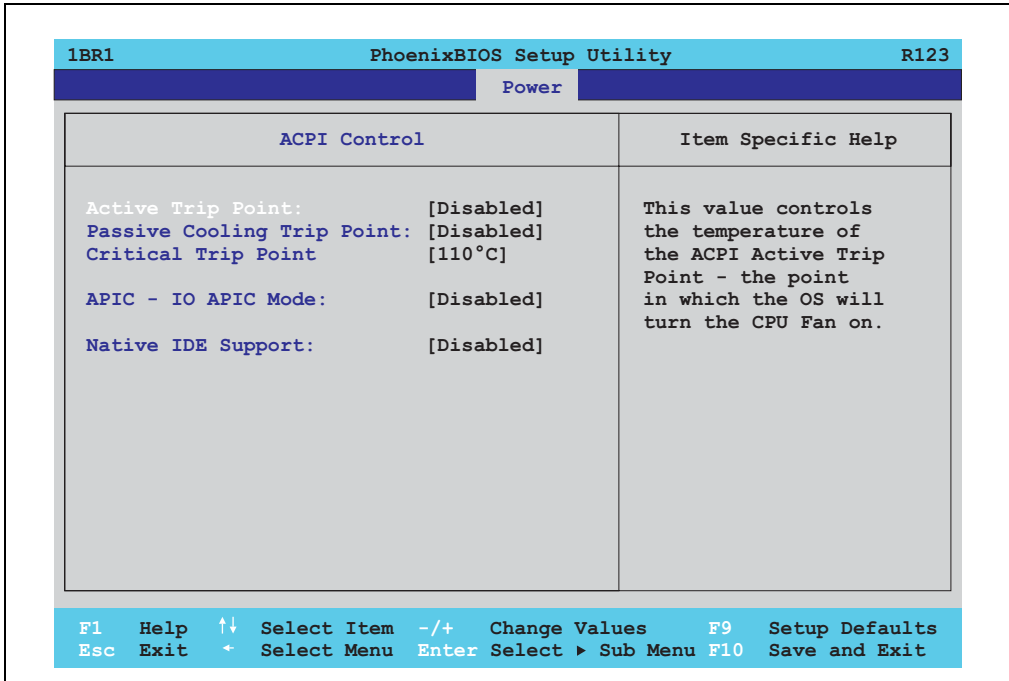

Figure 198: 815E (ETX) ACPI Control

BIOS setting	Meaning	Setting options	Effect
Active trip point	With this function, an optional CPU fan above the operating system can be set to turn on when the CPU reaches the set temperature.	Disabled	Disables this function.
		40 to 100°C	Temperature setting for the active trip point. Can be set in increments of 5°C.
Passive Cooling Trip Point	With this function, a temperature can be set at which the CPU automatically reduces its speed.	Disabled	Disables this function.
		40 to 100°C	Temperature setting for the passive cooling trip point. Can be set in increments of 5°C.
Critical Trip Point	With this function, a temperature can be set at which the operating system automatically shuts itself down.  <b>Warning!</b> This should never be deactivated, as this would allow the CPU to rise above the temperature specifications.	Disabled	Disables this function.
		40 to 110°C	Temperature setting for the critical trip point. Can be set in increments of 5°C.

Table 227: 815E (ETX) ACPI Control setting options

## Software • BIOS options

BIOS setting	Meaning	Setting options	Effect
APIC - I/O APIC mode	This option controls the functionality of the advanced interrupt controller in the processor.	Disabled	Disables the function
		Enabled	Enables this function. The activation of this option is only effective if it takes place before the operating system (Windows XP) is activated. There are then 23 IRQs available.
Native IDE support	The native IDE support offers the possibility to make 4 hard disk controllers (2 x primary ATA for a total of 4 devices, and 2 x secondary ATA for another 2 devices) accessible through Windows XP.	Disabled	Disables this function.
		Enabled	Enables this function.

Table 227: 815E (ETX) ACPI Control setting options (Forts.)

## Thermal management

The screenshot shows the PhoenixBIOS Setup Utility interface. At the top, it says '1BR1 PhoenixBIOS Setup Utility R123'. Below that is a 'Power' menu. The 'Thermal Management' section is active, showing the following settings:

- Auto Thermal Throttling: [Disabled]
- Temperature: [100°C]
- Hysteresis: [5°C]
- CPU Performance: [50%]

Item Specific Help: Reduces CPU speed to avoid overheating.

Navigation keys at the bottom:

- F1 Help
- Esc Exit
- ↑↓ Select Item
- ← Select Menu
- /+ Change Values
- Enter Select
- F9 Setup Defaults
- F10 Save and Exit

Figure 199: 815E (ETX) Thermal Management

BIOS setting	Meaning	Setting options	Effect
Auto thermal throttling	Reduces the CPU speed when it exceeds the limit set in the "temperature" option by the amount set in the "CPU performance" option.	Enabled	Enables this function.
		Disabled	Disables this function.

Table 228: 815E (ETX) Thermal Management

BIOS setting	Meaning	Setting options	Effect
Temperature	Temperature limit for the setting "auto thermal throttling."	75 to 110°C	Can be set in increments of 5°.
Hysteresis	When auto thermal throttling has been activated and the temperature sinks by the number of degrees in this setting, the processor resumes 100% performance.	3 to 6°C	Can be set in increments of 1°C.
CPU performance	When the CPU reaches the temperature set in the "temperature" option, the CPU is throttled by the amount (in percent) set in this option.	13%, 25%, 50%, 75%	CPU performance throttled by amount selected, in percent.

Table 228: 815E (ETX) Thermal Management (Forts.)

### 1.1.8 Boot

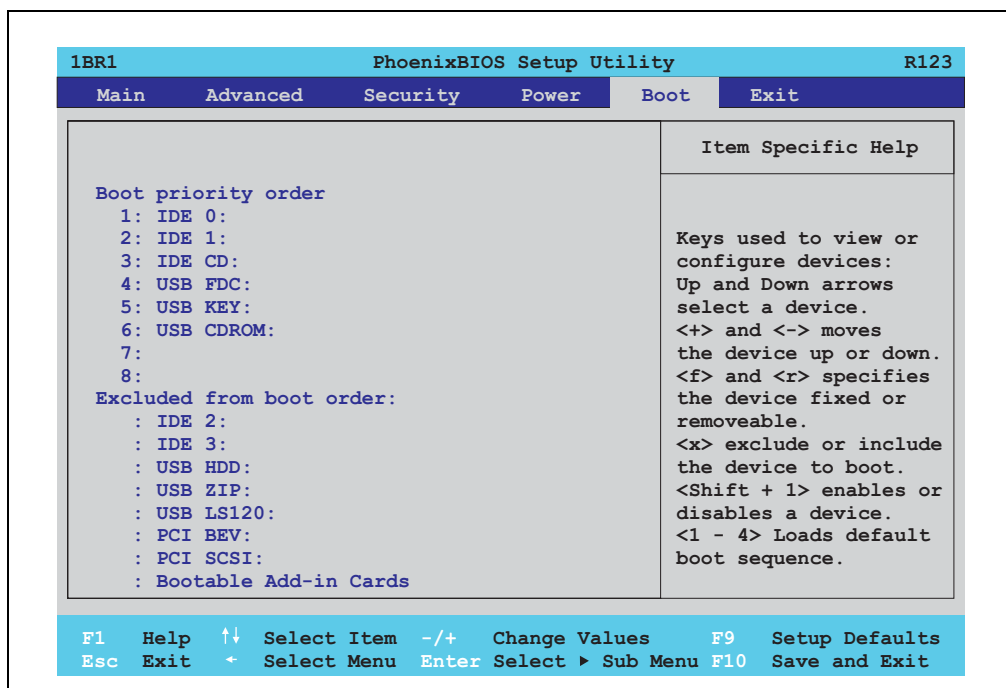

Figure 200: 815E (ETX) Boot Menu

BIOS setting	Meaning	Setting options	Effect
1:		IDE 0, IDE 1,	Use the up arrow ↑ and down arrow ↓, to select a device. Then, use the <+> and <-> keys to change the boot priority of the drive.  To add a device to the "boot priority order" list from the "excluded from boot order" list, use the <x> key. In the same way, the <x> key can move boot devices down out of the boot priority order. The keys 1 - 4 can load preset boot sequences.
2:		IDE 2, IDE 3,	
3:		IDE CD	
4:		USB FDC, USB KEY	
5:		USB CDROM	
6:		USB HDD, USB ZIP	
7:		USB LS120,	
8:		PCI BEV, PCI SCSI, bootable add-in cards	

Table 229: 815E (ETX) Boot setting options

1.1.9 Exit

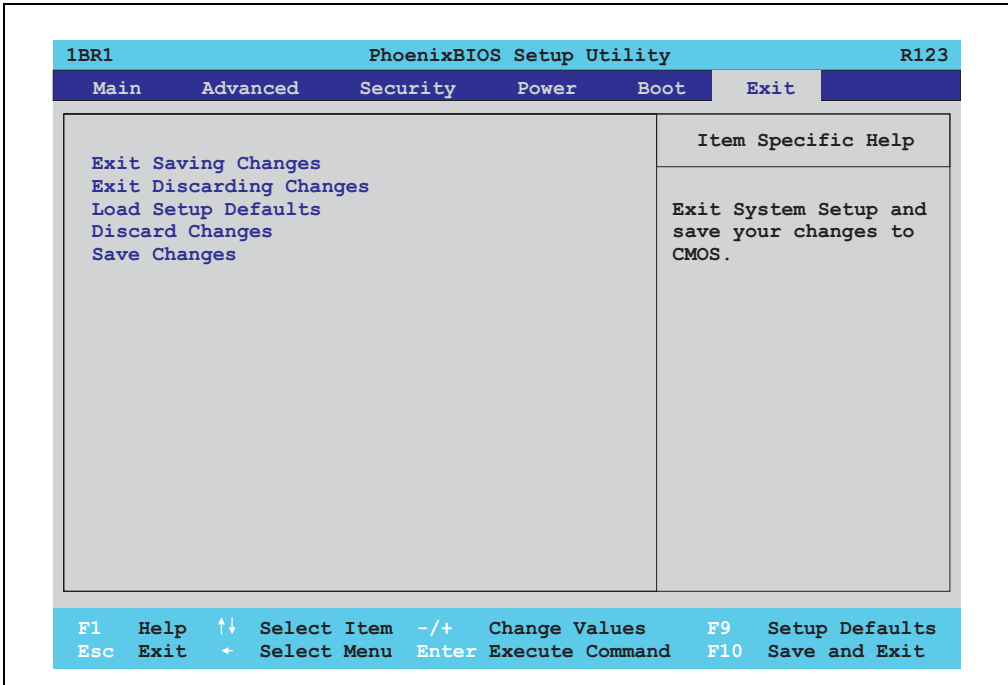

Figure 201: 815E (ETX) Exit Menu

BIOS setting	Meaning	Setting options	Effect
Exit saving changes	BIOS setup is closed with this item. Changes made are saved in CMOS after confirmation, and the system is rebooted.	Yes / No	
Exit discarding changes	With this item you can close BIOS setup without saving the changes made. The system is then rebooted.	Yes / No	
Load setup defaults	This item loads the BIOS setup defaults, which are defined by the DIP switch settings. These settings are loaded for all BIOS configurations.	Yes / No	
Discard Changes	Should unknown changes have been made and not yet saved, they can be discarded.	Yes / No	
Save changes	Settings are saved, and the system is not restarted.	Yes / No	

Table 230: 815E (ETX) Exit setting options

### 1.1.10 Profile overview - BIOS default settings - 815E (ETX)

If the function "load setup defaults" is chosen in the main BIOS setup menu, or if exit is selected (or <F9> is pressed) in the individual setup screens, the following BIOS default settings are the optimized values that will be used.

DIP switch position see Section 1.6 "Location of the DIP switch in APC620 system units", on page 546).

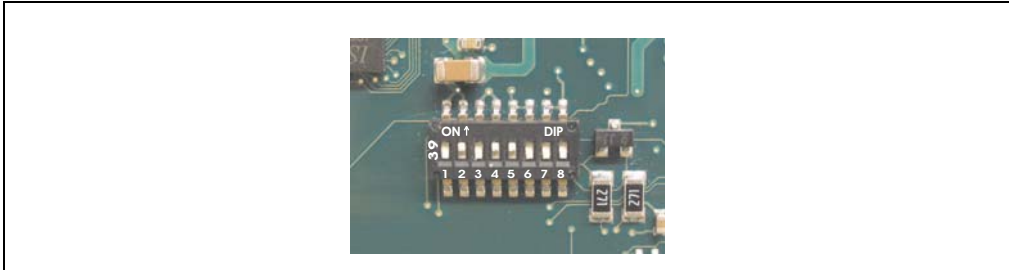

Figure 202: DIP switch on system unit

The first six DIP switches (1-6) are used to set the profiles. The rest (7,8) are reserved.

Number	Optimized for	DIP switch setting							
		1	2	3	4	5	6	7 <sup>1)</sup>	8 <sup>1)</sup>
Profile 0	Automation PC 620 system units 5PC600.SX01-00.	Off	Off	Off	Off	Off	Off	-	-
Profile 1	Reserved	On	Off	Off	Off	Off	Off	-	-
Profile 2	Automation PC 620 system units 5PC600.SX02-00, 5PC600.SX02-01, 5PC600.SX05-00 and 5PC600.SX05-01.	Off	On	Off	Off	Off	Off	-	-
Profile 3	Panel PC 700 system unit 5PC720.1043-00, 5PC720.1214-00, 5PC720.1505-00, 5PC720.1706-00, 5PC720.1906-00, 5PC781.1043-00, 5PC781.1505-00 and 5PC782.1043-00.	On	On	Off	Off	Off	Off	-	-
Profile 4	Panel PC 700 system unit 5PC720.1043-01, 5PC720.1214-01, 5PC720.1505-01 and 5PC720.1505-02.	Off	Off	On	Off	Off	Off	-	-

Table 231: 815E (ETX) Profile overview

1) Reserved.

The following pages provide an overview of the BIOS default settings for the different DIP switch configurations.

#### [Personal settings](#)

If changes have been made to the BIOS defaults, they can be entered in the following tables for backup.



Main

	Profile 0	Profile 1	Profile 2	Profile 3	Profile 4	Personal settings
System Time	-	-	-	-	-	
System Date	-	-	-	-	-	
SMART device monitoring	Enabled	Enabled	Enabled	Enabled	Enabled	
BIOS Date	-	-	-	-	-	
<b>IDE channel 0 master</b>						
Type	Auto	Auto	Auto	Auto	Auto	
Multi-sector transfer	-	-	-	-	-	
LBA mode control	-	-	-	-	-	
32-bit I/O	Disabled	Disabled	Disabled	Disabled	Disabled	
Transfer mode	-	-	-	-	-	
Ultra DMA mode	-	-	-	-	-	
SMART monitoring	Disabled	Disabled	Disabled	Disabled	Disabled	
<b>IDE channel 0 slave</b>						
Type	Auto	Auto	Auto	Auto	Auto	
Multi-sector transfer	-	-	-	-	-	
LBA mode control	-	-	-	-	-	
32-bit I/O	Disabled	Disabled	Disabled	Disabled	Disabled	
Transfer mode	-	-	-	-	-	
Ultra DMA mode	-	-	-	-	-	
SMART monitoring	Disabled	Disabled	Disabled	Disabled	Disabled	
<b>IDE channel 1 master</b>						
Type	Auto	Auto	Auto	Auto	Auto	
Multi-sector transfer	-	-	-	-	-	
LBA mode control	-	-	-	-	-	
32-bit I/O	Disabled	Disabled	Disabled	Disabled	Disabled	
Transfer mode	-	-	-	-	-	
Ultra DMA mode	-	-	-	-	-	
SMART monitoring	Disabled	Disabled	Disabled	Disabled	Disabled	
<b>IDE channel 1 slave</b>						
Type	Auto	Auto	Auto	Auto	Auto	
Multi-sector transfer	-	-	-	-	-	
LBA mode control	-	-	-	-	-	
32-bit I/O	Disabled	Disabled	Disabled	Disabled	Disabled	
Transfer mode	-	-	-	-	-	
Ultra DMA mode	-	-	-	-	-	
SMART monitoring	Disabled	Disabled	Disabled	Disabled	Disabled	

Table 232: 815E (ETX) Main Profile settings overview

**Advanced**Advanced chipset/graphics control

	Profile 0	Profile 1	Profile 2	Profile 3	Profile 4	Personal settings
Graphics engine 1	Auto	Auto	Auto	Auto	Auto	
Graphics memory size	1MB	1MB	1MB	1MB	1MB	
Enable memory gap	Disabled	Disabled	Disabled	Disabled	Disabled	

Table 233: 815E (ETX) Advanced Chipset/Graphics Control Profile settings overview

PCI/PNP Configuration

	Profile 0	Profile 1	Profile 2	Profile 3	Profile 4	Personal settings
PNP OS installed	Yes	Yes	Yes	Yes	Yes	
Reset configuration data	No	No	No	No	No	
Secured setup configuration	Yes	Yes	Yes	Yes	Yes	
PCI IRQ line 1	Auto-select	Auto-select	Auto-select	Auto-select	Auto-select	
PCI IRQ line 2	Auto-select	Auto-select	Auto-select	Auto-select	Auto-select	
PCI IRQ line 3	Auto-select	Auto-select	Auto-select	Auto-select	Auto-select	
PCI IRQ line 4	Auto-select	Auto-select	Auto-select	Auto-select	Auto-select	
Onboard LAN IRQ line	Auto-select	Auto-select	Auto-select	Auto-select	Auto-select	
Onboard USB EHCI IRQ line	Auto-select	Auto-select	Auto-select	Auto-select	Auto-select	
Default primary video adapter	PCI	PCI	PCI	PCI	PCI	
Assign IRQ to SMB	Enabled	Enabled	Enabled	Enabled	Enabled	
<b>PCI device, slot #1</b>						
ROM scan option	Enabled	Enabled	Enabled	Enabled	Enabled	
Enable master	Enabled	Enabled	Enabled	Enabled	Enabled	
Latency timer	Default	Default	Default	Default	Default	
<b>PCI device, slot #2</b>						
ROM scan option	Enabled	Enabled	Enabled	Enabled	Enabled	
Enable master	Enabled	Enabled	Enabled	Enabled	Enabled	
Latency timer	Default	Default	Default	Default	Default	
<b>PCI device, slot #3</b>						
ROM scan option	Enabled	Enabled	Enabled	Enabled	Enabled	
Enable master	Enabled	Enabled	Enabled	Enabled	Enabled	
Latency timer	Default	Default	Default	Default	Default	

Table 234: 815E (ETX) PCI/PNP Configuration Profile settings overview

PCI device, slot #4	Profile 0	Profile 1	Profile 2	Profile 3	Profile 4	Personal settings
ROM scan option	Enabled	Enabled	Enabled	Enabled	Enabled	
Enable master	Enabled	Enabled	Enabled	Enabled	Enabled	
Latency timer	Default	Default	Default	Default	Default	

Table 234: 815E (ETX) PCI/PNP Configuration Profile settings overview (Forts.)

[Memory cache](#)

	Profile 0	Profile 1	Profile 2	Profile 3	Profile 4	Personal settings
Memory cache	Enabled	Enabled	Enabled	Enabled	Enabled	
Cache system BIOS area	Write protect	Write protect	Write protect	Write protect	Write protect	
Cache video BIOS area	Write protect	Write protect	Write protect	Write protect	Write protect	
Cache extended memory area	Write back	Write back	Write back	Write back	Write back	
Cache D000 - D3FF	Disabled	Disabled	Disabled	Disabled	Disabled	
Cache D400 - D7FF	Disabled	Disabled	Disabled	Disabled	Disabled	
Cache D800 - DBFF	Disabled	Disabled	Disabled	Disabled	Disabled	
Cache DC00 - DFFF	Disabled	Disabled	Disabled	Disabled	Disabled	
Cache E000 - E3FF	Disabled	Disabled	Disabled	Disabled	Disabled	
Cache E400 - E7FF	Disabled	Disabled	Disabled	Disabled	Disabled	

Table 235: 815E (ETX) Memory Cache Profile settings overview

[I/O Device Configuration](#)

	Profile 0	Profile 1	Profile 2	Profile 3	Profile 4	Personal settings
Local bus IDE adapter	Primary	<b>Both</b>	<b>Both</b>	Primary	<b>Both</b>	
Primary IDE UDMA66/100	Enabled	Enabled	Enabled	Enabled	Enabled	
USB UHCI host controller 1	Enabled	Enabled	Enabled	Enabled	Enabled	
USB UHCI host controller 2	Enabled	Enabled	Enabled	Enabled	Enabled	
USB UHCI host controller	Enabled	Enabled	Enabled	Enabled	Enabled	
Legacy USB Support	Enabled	Enabled	Enabled	Enabled	Enabled	
AC97 audio controller	Enabled	Enabled	Enabled	Enabled	Enabled	
Onboard LAN controller	Enabled	Enabled	Enabled	Enabled	Enabled	
Onboard LAN PXE ROM	Disabled	<b>Enabled</b>	Disabled	Disabled	Disabled	
Serial port A	Enabled	Enabled	Enabled	Enabled	Enabled	
Base I/O address	3F8	3F8	3F8	3F8	2F8	
Interrupt	IRQ 4	IRQ 4	IRQ 4	IRQ 4	IRQ 4	
Serial port B	Enabled	Enabled	Enabled	Enabled	Enabled	
Mode	Normal	Normal	Normal	Normal	Normal	

Table 236: 815E (ETX) I/O Device Configuration Profile settings overview

## Software • BIOS options

	Profile 0	Profile 1	Profile 2	Profile 3	Profile 4	Personal settings
Base I/O address	3F8	3F8	3F8	3F8	2F8	
Interrupt	IRQ 3	IRQ 3	IRQ 3	IRQ 3	IRQ 3	
Parallel port	Enabled	Enabled	Enabled	Enabled	Enabled	
Base I/O address	378	378	378	378	378	

Table 236: 815E (ETX) I/O Device Configuration Profile settings overview (Forts.)

### [Keyboard features](#)

	Profile 0	Profile 1	Profile 2	Profile 3	Profile 4	Personal settings
NumLock	On	On	On	On	On	
Key click	Disabled	Disabled	Disabled	Disabled	Disabled	
Keyboard auto-repeat rate	30/sec	30/sec	30/sec	30/sec	30/sec	
Keyboard auto-repeat delay	1/2 sec	1/2 sec	1/2 sec	1/2 sec	1/2 sec	

Table 237: 815E (ETX) Keyboard Features Profile settings overview

### [CPU board monitor](#)

	Profile 0	Profile 1	Profile 2	Profile 3	Profile 4	Personal settings
VCC 3.3V voltage	-	-	-	-	-	
CPU core voltage	-	-	-	-	-	
5Vsb voltage	-	-	-	-	-	
Battery voltage	-	-	-	-	-	
CPU temperature	-	-	-	-	-	

Table 238: 815E (ETX) CPU Board Monitor Profile settings overview

### [Miscellaneous](#)

	Profile 0	Profile 1	Profile 2	Profile 3	Profile 4	Personal settings
Summary screen	Enabled	Enabled	Enabled	Enabled	Enabled	
QuickBoot mode	Enabled	Enabled	Enabled	Enabled	Enabled	
Extended memory testing	Just zero it	Just zero it	Just zero it	Just zero it	Just zero it	
Dark boot	Disabled	Disabled	Disabled	Disabled	Disabled	
Halt on errors	Yes	Yes	Yes	Yes	Yes	
PS/2 mouse	Disabled	Enabled	Disabled	Disabled	Disabled	
Large disk access mode	DOS	DOS	DOS	DOS	DOS	

Table 239: 815E (ETX) Miscellaneous Profile settings overview

Main Board/Panel Features

	Profile 0	Profile 1	Profile 2	Profile 3	Profile 4	Personal settings
Versions	-	-	-	-	-	
BIOS	-	-	-	-	-	
MTCX	-	-	-	-	-	
FPGA	-	-	-	-	-	
Optimized ID	-	-	-	-	-	
Device ID	-	-	-	-	-	
Compatibility ID	-	-	-	-	-	
Serial Number	-	-	-	-	-	
Product name	-	-	-	-	-	
User serial ID	-	-	-	-	-	
<b>Panel control</b>						
Select panel number	0	0	0	15	15	
Version	-	-	-	-	-	
Brightness	100%	100%	100%	100%	100%	
Temperature	-	-	-	-	-	
Fan speed	-	-	-	-	-	
Keys/LEDs	-	-	-	-	-	
<b>Main board monitor</b>						
Temperatures	-	-	-	-	-	
I/O	-	-	-	-	-	
Power supply	-	-	-	-	-	
Slide-in drive 1	-	-	-	-	-	
Slide-in drive 2	-	-	-	-	-	
Fan speeds	-	-	-	-	-	
Case 1	-	-	-	-	-	
Case 2	-	-	-	-	-	
Case 3	-	-	-	-	-	
Case 4	-	-	-	-	-	
CPU	-	-	-	-	-	
<b>Legacy devices</b>						
COM C	Disabled	Disabled	Disabled	Enabled	Enabled	
Base I/O address	-	-	-	3E8h	3E8h	
Interrupt	-	-	-	11	11	
COM D	Disabled	Disabled	Disabled	Disabled	Disabled	
Base I/O address	-	-	-	-	-	
Interrupt	-	-	-	-	-	

Table 240: 815E (ETX) Baseboard/Panel Features Profile settings overview

## Software • BIOS options

Legacy devices	Profile 0	Profile 1	Profile 2	Profile 3	Profile 4	Personal settings
COM E	Disabled	Disabled	Disabled	Disabled	Disabled	
Base I/O address	-	-	-	-	-	
Interrupt	-	-	-	-	-	
LPT	Disabled	Disabled	Disabled	Disabled	Disabled	
Base I/O address	-	-	-	-	-	
CAN	Disabled	Disabled	Disabled	Disabled	Disabled	
Base I/O address	-	-	-	-	-	
Interrupt	-	-	-	-	-	
2nd LAN controller	Enabled	Enabled	Enabled	Enabled	Enabled	
LAN1 MAC address	-	-	-	-	-	
LAN2 MAC address	-	-	-	-	-	

Table 240: 815E (ETX) Baseboard/Panel Features Profile settings overview (Forts.)

## Security

	Profile 0	Profile 1	Profile 2	Profile 3	Profile 4	Personal settings
Supervisor password is	Clear	Clear	Clear	Clear	Clear	
User password is	Clear	Clear	Clear	Clear	Clear	
Set supervisor password	-	-	-	-	-	
Set user password	-	-	-	-	-	
Diskette access	Supervisor	Supervisor	Supervisor	Supervisor	Supervisor	
Fixed disk boot sector	Normal	Normal	Normal	Normal	Normal	
Virus check reminder	Disabled	Disabled	Disabled	Disabled	Disabled	
System backup reminder	Disabled	Disabled	Disabled	Disabled	Disabled	
Password at boot	Disabled	Disabled	Disabled	Disabled	Disabled	

Table 241: 815E (ETX) Security Profile settings overview

## Power

	Profile 0	Profile 1	Profile 2	Profile 3	Profile 4	Personal settings
Enable ACPI	Yes	Yes	Yes	Yes	Yes	
Power savings	Disabled	Disabled	Disabled	Disabled	Disabled	
Standby timeout	-	-	-	-	-	
Auto suspend timeout	-	-	-	-	-	
Hard disk timeout	Disabled	Disabled	Disabled	Disabled	Disabled	
Video timeout	Disabled	Disabled	Disabled	Disabled	Disabled	
Resume on modem ring	Off	Off	Off	Off	Off	
Resume on time	Off	Off	Off	Off	Off	
Resume time	0:00:00	0:00:00	0:00:00	0:00:00	0:00:00	
Power supply	ATX	ATX	ATX	ATX	ATX	
Power button function	Power off	Power off	Power off	Power off	Power off	
Power Loss Control	Power-on	Power-on	Power-on	Power-on	Power-on	
<b>ACPI control</b>						
Active trip point	Disabled	Disabled	Disabled	Disabled	Disabled	
Passive Cooling Trip Point	Disabled	Disabled	Disabled	Disabled	Disabled	
Critical Trip Point	110°C	110°C	110°C	110°C	110°C	
APIC - I/O APIC mode	Disabled	Enabled	Disabled	Disabled	Disabled	
Native IDE support	Disabled	Disabled	Disabled	Disabled	Disabled	
<b>Thermal management</b>						
Auto thermal throttling	Enabled	Enabled	Enabled	Enabled	Enabled	
Temperature	100°C	100°C	100°C	100°C	100°C	
Hysteresis	5°C	5°C	5°C	5°C	5°C	
CPU performance	50%	50%	50%	50%	50%	

Table 242: 815E (ETX) Power Profile settings overview

Boot

	Profile 0	Profile 1	Profile 2	Profile 3	Profile 4	Personal settings
Boot priority order						
1:	IDE 0	PCI BEV	IDE 0	IDE 0	IDE 0	
2:	IDE 1	IDE 0	IDE 1	IDE 1	IDE 1	
3:	IDE CD	IDE 1	IDE CD	IDE CD	IDE CD	
4:	USB FDC	IDE CD	USB FDC	USB FDC	USB FDD	
5:	USB KEY	USB FDC	USB KEY	USB KEY	USB KEY	
6:	USB CDROM	USB KEY	USB CDROM	USB CDROM	USB CDROM	
7:	-	USB CDROM	IDE 2	-	IDE 2	
8:	-	-	IDE 3	-	IDE 3	
Excluded from boot order						
:	IDE 2	IDE 2	USB HDD	IDE 2	USB HDD	
:	IDE 3	IDE 3	USB ZIP	IDE 3	USB ZIP	
:	USB HDD	USB HDD	USB LS120	USB HDD	USB LS120	
:	USB ZIP	USB ZIP	PCI BEV	USB ZIP	PCI BEV	
:	USB LS120	USB LS120	PCI SCSI	USB LS120	PCI SCSI	
:	PCI BEV	PCI SCSI	Bootable add-in cards	PCI BEV	Bootable add-in cards	
:	PCI SCSI	Bootable add-in cards		PCI SCSI		
:	Bootable add-in cards			Bootable add-in cards		

Table 243: 815E (ETX) Boot Profile settings overview



## 1.2 855GME (ETX) BIOS description

### Information:

- The following diagrams and BIOS menu items including descriptions refer to BIOS version 1.30. It is therefore possible that these diagrams and BIOS descriptions do not correspond with the installed BIOS version.
- The setup defaults are the settings recommended by B&R. The setup defaults are dependant on the DIP switch configuration on the baseboard (see section 1.2.10 "Profile overview - BIOS default settings - 855GME (ETX)", on page 472).

### 1.2.1 General information

BIOS stands for "Basic Input Output System". It is the most basic standardized communication between the user and the system (hardware). The BIOS system used in the Automation PC 620 systems is produced by Phoenix.

The BIOS Setup Utility lets you modify basic system configuration settings. These settings are stored in CMOS and in EEPROM (as a backup).

The CMOS data is buffered by a battery, and remains in the APC620 even when the power is turned off (no 24 VDC supply) .

### 1.2.2 BIOS setup and boot procedure

BIOS is immediately activated when switching on the power supply of the Automation PC 620 system or pressing the power button. The system checks if the setup data from the EEPROM is "OK". If the data is "OK", then it is transferred to the CMOS. If the data is "not OK", then the CMOS data is checked for validity. An error message is output if the CMOS data contains errors and the boot procedure can be continued by pressing the <F1> key. To prevent the error message from appearing at each restart, open the BIOS setup by pressing the <F2> key and re-save the settings.

BIOS reads the system configuration information in CMOS RAM, checks the system, and configures it using the Power On Self Test (POST).

When these "preliminaries" are finished, BIOS seeks an operating system in the data storage devices available (hard drive, floppy drive, etc.). BIOS launches the operating system and hands over control of system operations to it.

To enter BIOS setup, the F2 key must be pressed as soon as the following message appears on the lower margin of the display (during POST):

"Press <F2> to enter SETUP"

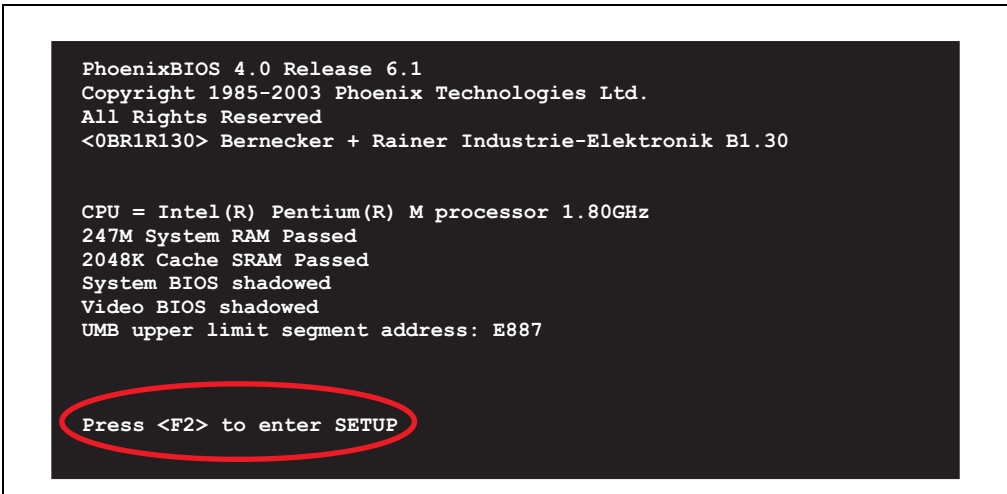

Figure 203: 855GME (ETX) BIOS Diagnostics Screen

### Summary screen

After the POST, the summary screen displays the most important system characteristics.

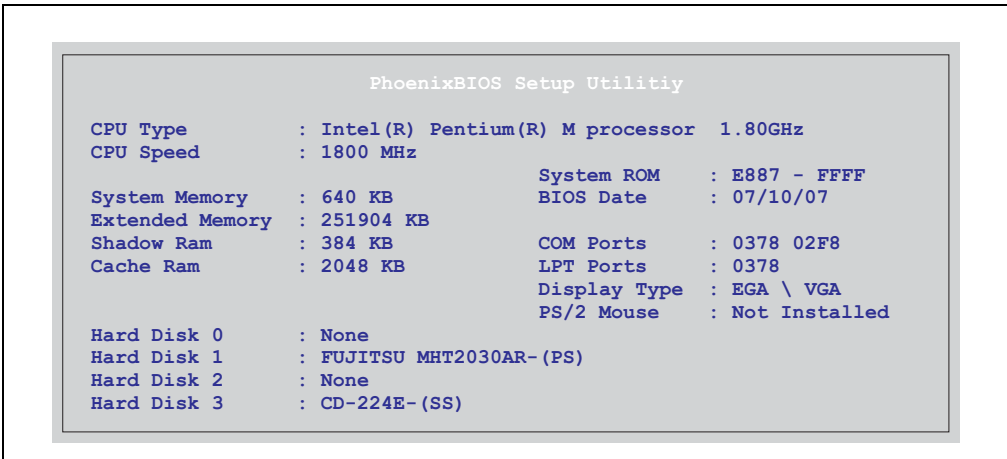

Figure 204: 855GME (ETX) BIOS Summary Screen

### 1.2.3 BIOS setup keys

The following keys are active during the POST:

Key	Function
F2	Enters the BIOS setup menu.
ESC	Cues the boot menu. Lists all bootable devices that are connected to the system. With cursor ↑ and cursor ↓ and by pressing <ENTER>, select the device from which will be booted.
<Spacebar>	Pressing the spacebar skips the system RAM check.
<Pause>	Pressing the <pause> key stops the POST. Press any other key to resume the POST.

Table 244: Keys relevant to 855GME (ETX) BIOS during POST

The following keys can be used after entering the BIOS setup:

Key	Function
Cursor ↑	Moves to the previous item.
Cursor ↓	Go to the next item.
Cursor ←	Move to the item on the left.
Cursor →	Move to the item on the right.
<ESC>	Exits the submenu.
PageUp ↑	Moves the cursor to the top of the current BIOS setup page.
PageDown ↓	Moves the cursor to the bottom of the current BIOS setup page.
<F1> or <Alt+H>	Opens a help window showing the key assignments.
<F5> or <<>	Scrolls to the previous option for the selected BIOS setting.
<F6> or <+> or <spacebar>	Scrolls to the next option for the selected BIOS setting.
<F8>	Load optimized default values for all pages.
<F9>	Load setup default values for all pages.
<F10>	Saves settings and closes BIOS setup.
<Enter>	Opens submenu for a BIOS setup menu item, or displays the configurable values of a BIOS setup item.

Table 245: 855GME (ETX) - BIOS relevant keys

The following sections explain the individual BIOS setup menu items in detail.

BIOS setup menu item	Function	From page
<b>Main</b>	The basic system configurations (e.g. time, date, hard disk parameters) can be set in this menu.	428
<b>Advanced</b>	Advanced BIOS options such as cache areas, PnP, keyboard repeat rate, as well as settings specific to B&R integrated hardware, can be configured here.	438
<b>Security</b>	For setting up the system's security functions.	463
<b>Power</b>	Setup of various APM (Advanced Power Management) options.	465
<b>Boot</b>	The boot order can be set here.	469

Table 246: Overview of 855GME (ETX) BIOS menu items

## Software • BIOS options

BIOS setup menu item	Function	From page
Exit	To end the BIOS setup.	470

Table 246: Overview of 855GME (ETX) BIOS menu items (Forts.)

### 1.2.4 Main

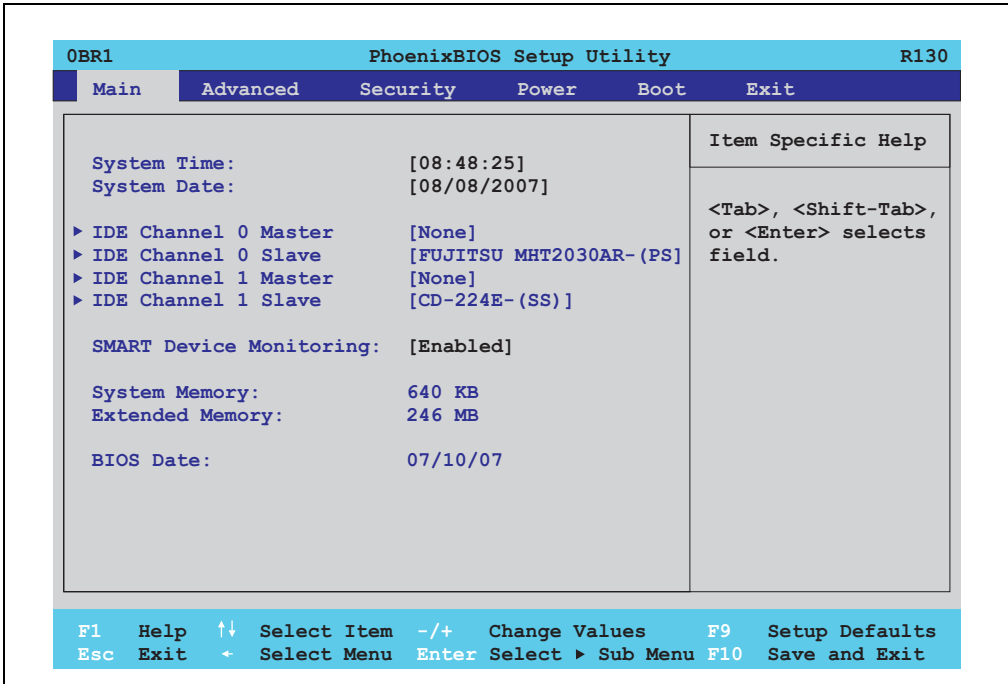

Figure 205: 855GME (ETX) Main

BIOS setting	Meaning	Setting options	Effect
System Time	This is the current system time setting. The time is buffered by a battery (CMOS battery) after the system has been switched off.	Changes the System time	Set the system time in the format (hh:mm:ss).
System Date	This is the current system date setting. The time is buffered by a battery (CMOS battery) after the system has been switched off.	Changes the system date	Set the system date in the format (mm:dd:yyyy).
IDE Channel 0 Master	The drive in the system that is connected to the IDE channel 0 master (previously "primary master") port is configured here.	Enter	Opens the submenu See "IDE channel 0 master", on page 430.
IDE Channel 0 Slave	The drive in the system that is connected to the IDE channel 0 slave (previously "primary slave") port is configured here.	Enter	Opens the submenu See "IDE channel 0 slave", on page 432.

Table 247: 855GME (ETX) Main setting options

BIOS setting	Meaning	Setting options	Effect
<b>IDE Channel 1 Master</b>	The drive in the system that is connected to the IDE channel 1 master (previously "secondary master") port is configured here.	Enter	Opens the submenu See "IDE channel 1 master", on page 434.
<b>IDE Channel 1 Slave</b>	The drive in the system that is connected to the IDE channel 1 slave (previously "secondary slave") port is configured here.	Enter	Opens the submenu See "IDE channel 1 slave", on page 436.
Smart device monitoring	S.M.A.R.T. (Self Monitoring Analysis and Reporting Technology) is implemented in the today's hard drives. This technology allows you to detect reading or rotational problems with the hard drive, and much more.	Enabled	Activates this function. In the future, a message regarding impending errors is produced.
		Disabled	Deactivates this function.
System Memory	Displays the amount of main memory installed. Between 0 and 640 KB.	None	-
Extended memory	Displays the available main memory from the first MB to the maximum memory capacity.	None	-
BIOS Date	BIOS creation date	None	-

Table 247: 855GME (ETX) Main setting options (Forts.)

IDE channel 0 master

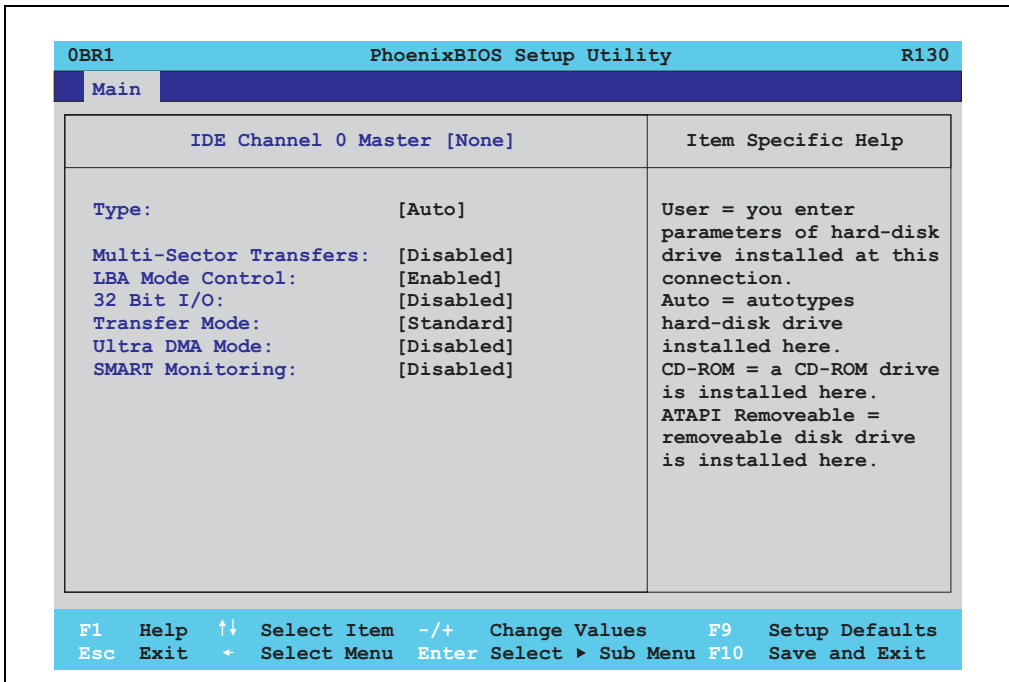

Figure 206: 855GME (ETX) IDE Channel 0 Master Setup

BIOS setting	Meaning	Setting options	Effect
Type	The type of drive connected to the IDE channel 0 master (previously "primary master") is configured here.	Auto	Automatic recognition of the drive and setup of appropriate values.
		User	Manual setup of the drive (number of cylinders, heads, and sectors).
		Other ATAPI	Use this option for IDE disk drives that are not mentioned here.
		CD-ROM	CD-ROM = CD-ROM drive
		ATAPI removable	The removable media drive is treated as a hard drive or floppy drive.
		IDE removable	The IDE removable drive is treated as a hard drive.
Multi-sector transfer	This option determines the number of sectors per block. Only possible when manually setting up the drive.	Disabled	Disables this function.
		2, 4, 8 or 16 sectors	Number of sectors per block.
LBA mode control	This option activates the logical block addressing for IDE. This function enables support of drives larger than 540 MB. Only possible when manually setting up the drive.	Disabled	Disables this function.
		Enabled	Enables this function.

Table 248: 855GME (ETX) IDE Channel 0 Master setting options

BIOS setting	Meaning	Setting options	Effect
32-bit I/O	This function enables 32-bit data transfer.	Disabled	Disables this function.
		Enabled	Enables this function.
Transfer mode	The communication path between the IDE channel 0 master drive and the system memory is defined here. Only possible when manually setting up the drive.	Default	Default setting.
		Fast PIO 1 - Fast PIO 4 / DMA2	Manual configuration of PIO mode.
Ultra DMA mode	The data transfer rate to and from the IDE channel 0 master drive is defined here. The DMA mode must be activated in the Windows device manager in order to guarantee maximum performance. Only possible when manually setting up the drive.	Disabled	Disables this function. Do not use UDMA mode.
		Mode 0 - Mode 5	Manual setting option for UDMA mode.
SMART monitoring	Indicates whether the IDE channel 0 master drive supports SMART technology.	Disabled	No drive support, and function is deactivated.
		Enabled	Drive support present, and function is activated.

Table 248: 855GME (ETX) IDE Channel 0 Master setting options (Forts.)

IDE channel 0 slave

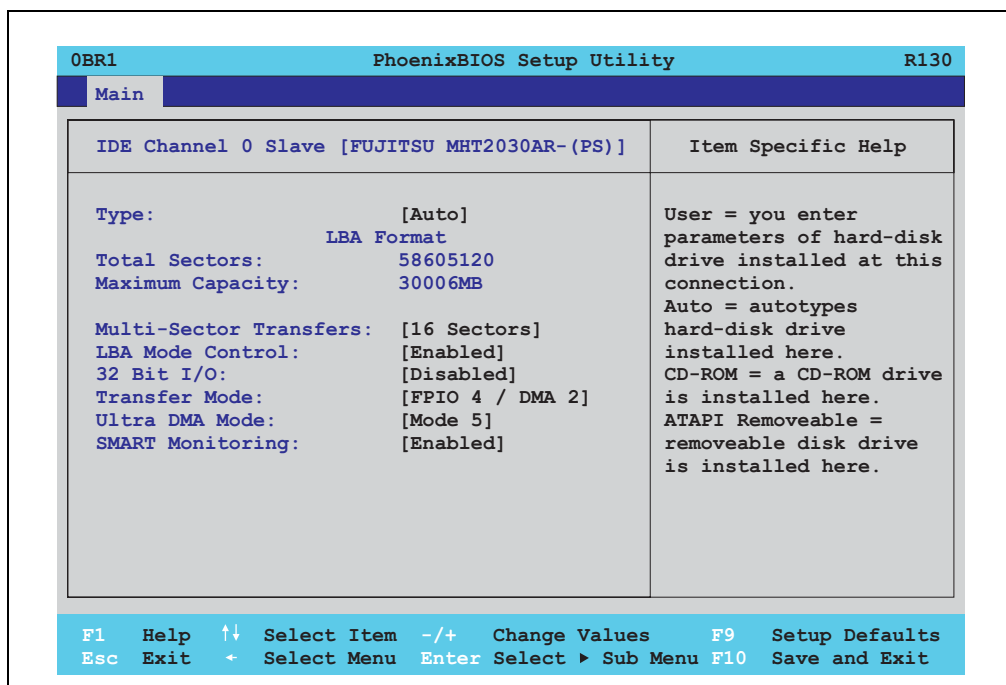

Figure 207: 855GME (ETX) IDE channel 0 slave setup

BIOS setting	Meaning	Setting options	Effect
Type	The type of drive connected to the IDE channel 0 slave (previously "primary slave") is configured here.	Auto	Automatic recognition of the drive and setup of appropriate values.
		User	Manual setup of the drive (number of cylinders, heads, and sectors).
		Other ATAPI	Use this option for IDE disk drives that are not mentioned here.
		CD-ROM	CD-ROM = CD-ROM drive
		ATAPI removable	The removable media drive is treated as a hard drive or floppy drive.
		IDE removable	The IDE removable drive is treated as a hard drive.
Multi-sector transfer	This option determines the number of sectors per block. Only possible when manually setting up the drive.	Disabled	Disables this function.
		2, 4, 8 or 16 sectors	Number of sectors per block.
LBA mode control	This option activates the logical block addressing for IDE. This function enables support of drives larger than 540 MB. Only possible when manually setting up the drive.	Disabled	Disables this function.
		Enabled	Enables this function.

Table 249: 855GME (ETX) IDE Channel 0 Slave setting options



BIOS setting	Meaning	Setting options	Effect
32-bit I/O	This function enables 32-bit data transfer.	Disabled	Disables this function.
		Enabled	Enables this function.
Transfer mode	The communication path between the IDE channel 0 slave and the system memory is defined here. Only possible when manually setting up the drive.	Default	Default setting.
		Fast PIO 1 - Fast PIO 4 / DMA2	Manual configuration of PIO mode.
Ultra DMA mode	The data transfer rate to and from the IDE channel 0 slave drive is defined here. The DMA mode must be activated in the Windows device manager in order to guarantee maximum performance. Only possible when manually setting up the drive.	Disabled	Disables this function. Do not use UDMA mode.
		Mode 0 - Mode 5	Manual setting option for UDMA mode.
SMART monitoring	Indicates whether the IDE channel 0 slave drive supports SMART technology.	Disabled	No drive support, and function is deactivated.
		Enabled	Drive support present, and function is activated.

Table 249: 855GME (ETX) IDE Channel 0 Slave setting options (Forts.)

IDE channel 1 master

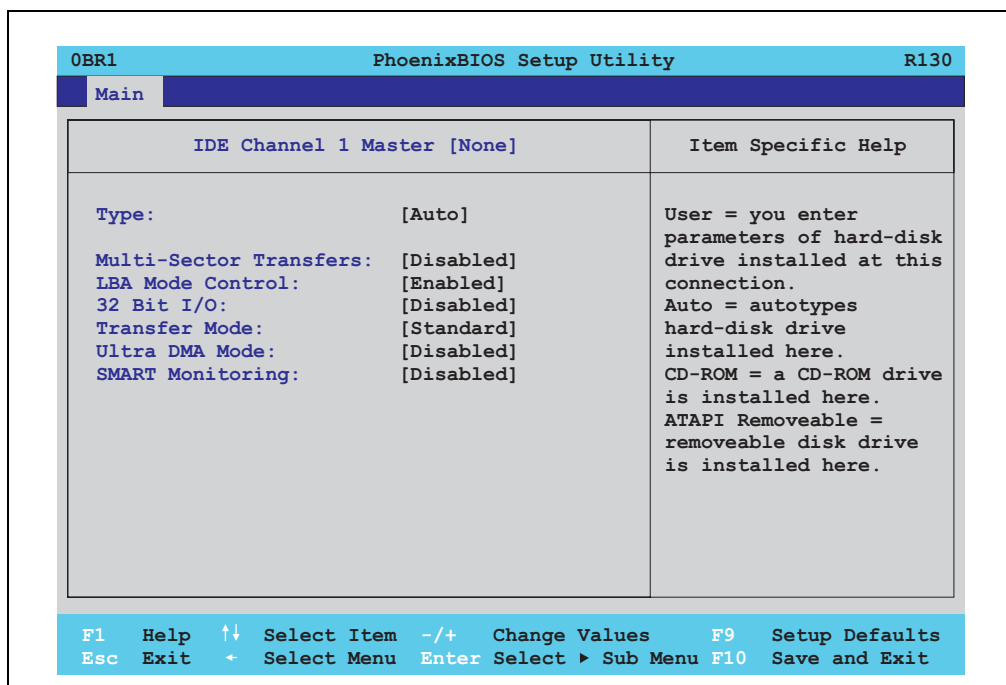

Figure 208: 855GME (ETX) IDE Channel 1 Master Setup

BIOS setting	Meaning	Setting options	Effect
Type	The type of drive connected to the IDE channel 1 master (previously "secondary master") is configured here.	Auto	Automatic recognition of the drive and setup of appropriate values.
		User	Manual setup of the drive (number of cylinders, heads, and sectors).
		Other ATAPI	Use this option for IDE disk drives that are not mentioned here.
		CD-ROM	CD-ROM = CD-ROM drive
		ATAPI removable	The removable media drive is treated as a hard drive or floppy drive.
		IDE removable	The IDE removable drive is treated as a hard drive.
Multi-sector transfer	This option determines the number of sectors per block. Only possible when manually setting up the drive.	Disabled	Disables this function.
		2, 4, 8 or 16 sectors	Number of sectors per block.
LBA mode control	This option activates the logical block addressing for IDE. This function enables support of drives larger than 540 MB. Only possible when manually setting up the drive.	Disabled	Disables this function.
		Enabled	Enables this function.

Table 250: 855GME (ETX) IDE Channel 1 Master setting options

BIOS setting	Meaning	Setting options	Effect
32-bit I/O	This function enables 32-bit data transfer.	Disabled	Disables this function.
		Enabled	Enables this function.
Transfer mode	The communication path between the IDE channel 1 master and the system memory is defined here. Only possible when manually setting up the drive.	Default	Default setting.
		Fast PIO 1 - Fast PIO 4 / DMA2	Manual configuration of PIO mode.
Ultra DMA mode	The data transfer rate to and from the IDE channel 1 master drive is defined here. The DMA mode must be activated in the Windows device manager in order to guarantee maximum performance. Only possible when manually setting up the drive.	Disabled	Disables this function. Do not use UDMA mode.
		Mode 0 - Mode 5	Manual setting option for UDMA mode.
SMART monitoring	Indicates whether the IDE channel 1 master drive supports SMART technology.	Disabled	No drive support, and function is deactivated.
		Enabled	Drive support present, and function is activated.

Table 250: 855GME (ETX) IDE Channel 1 Master setting options (Forts.)

IDE channel 1 slave

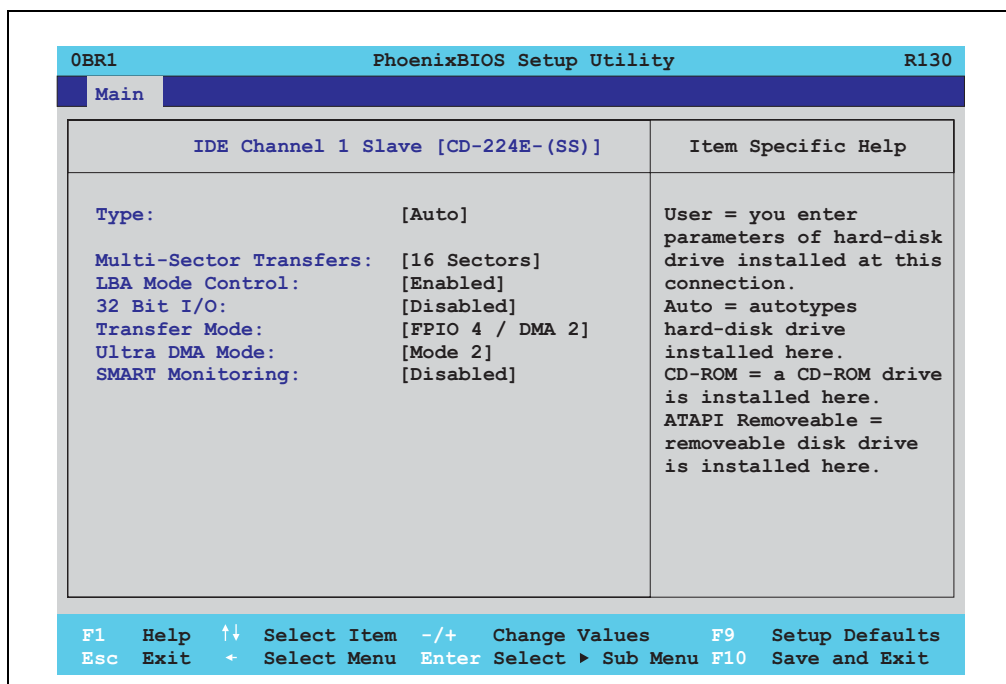

Figure 209: 855GME (ETX) IDE channel 1 slave setup

BIOS setting	Meaning	Setting options	Effect
Type	The type of drive connected to the IDE channel 1 slave (previously "secondary slave") is configured here.	Auto	Automatic recognition of the drive and setup of appropriate values.
		User	Manual setup of the drive (number of cylinders, heads, and sectors).
		Other ATAPI	Use this option for IDE disk drives that are not mentioned here.
		CD-ROM	CD-ROM = CD-ROM drive
		ATAPI removable	The removable media drive is treated as a hard drive or floppy drive.
		IDE removable	The IDE removable drive is treated as a hard drive.
Multi-sector transfer	This option determines the number of sectors per block. Only possible when manually setting up the drive.	Disabled	Disables this function.
		2, 4, 8 or 16 sectors	Number of sectors per block.
LBA mode control	This option activates the logical block addressing for IDE. This function enables support of drives larger than 540 MB. Only possible when manually setting up the drive.	Disabled	Disables this function.
		Enabled	Enables this function.

Table 251: 855GME (ETX) IDE Channel 1 Slave setting options

BIOS setting	Meaning	Setting options	Effect
32-bit I/O	This function enables 32-bit data transfer.	Disabled	Disables this function.
		Enabled	Enables this function.
Transfer mode	The communication path between the IDE channel 1 slave drive and the system memory is defined here. Only possible when manually setting up the drive.	Default	Default setting.
		Fast PIO 1 - Fast PIO 4 / DMA2	Manual configuration of PIO mode.
Ultra DMA mode	The data transfer rate to and from the IDE channel 1 slave drive is defined here. The DMA mode must be activated in the Windows device manager in order to guarantee maximum performance. Only possible when manually setting up the drive.	Disabled	Disables this function. Do not use UDMA mode.
		Mode 0 - Mode 5	Manual setting option for UDMA mode.
SMART monitoring	Indicates whether the IDE channel 1 slave drive supports SMART technology.	Disabled	No drive support, and function is deactivated.
		Enabled	Drive support present, and function is activated.

Table 251: 855GME (ETX) IDE Channel 1 Slave setting options (Forts.)

### 1.2.5 Advanced

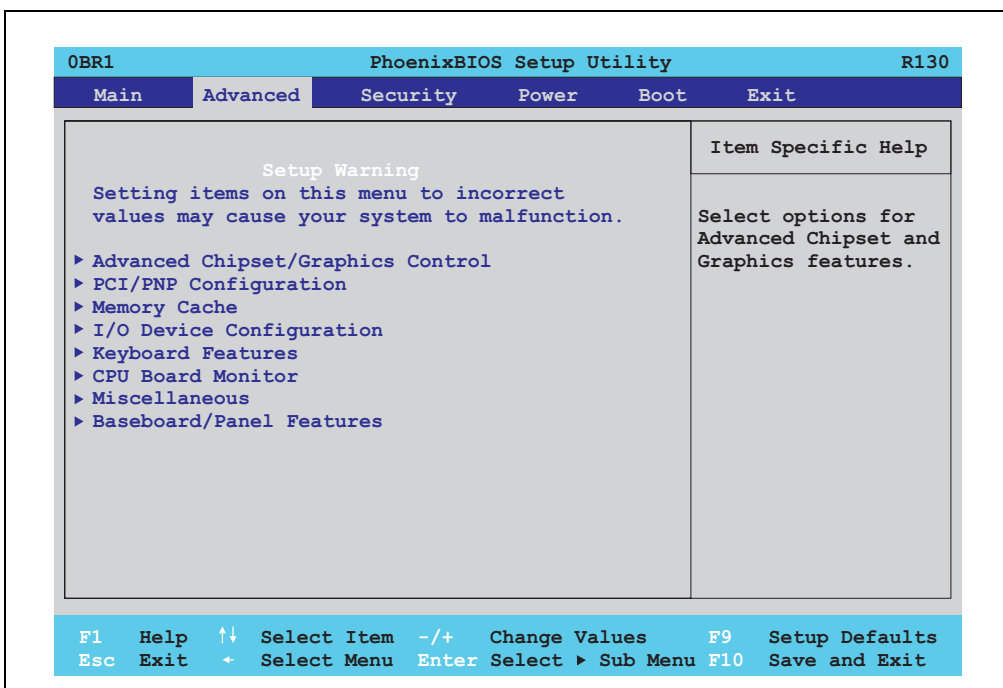

Figure 210: 855GME - advanced setup menu - overview

BIOS setup menu	Meaning	Setting options	Effect
<b>Advanced chipset/graphics control</b>	Setup of advanced chipset and graphics functions.	Enter	Opens the submenu See "Advanced chipset/graphics control", on page 439.
<b>PCI/PNP Configuration</b>	Configures PCI devices.	Enter	Opens the submenu See "PCI/PNP Configuration", on page 441.
<b>Memory cache</b>	Configuration of the memory cache resources.	Enter	Opens the submenu See "Memory cache", on page 448.
<b>I/O Device Configuration</b>	Configures the I/O devices.	Enter	Opens the submenu See "I/O Device Configuration", on page 450.
<b>Keyboard features</b>	Configuration of the keyboard options.	Enter	Opens the submenu See "Keyboard features", on page 453.
<b>CPU board monitor</b>	Displays the current voltages and temperature of the processor in use.	Enter	Opens the submenu See "CPU board monitor", on page 454.
<b>Miscellaneous</b>	Configuration of various BIOS settings (summary screen, halt on errors, etc.).	Enter	Opens the submenu See "Miscellaneous", on page 455.
<b>Main Board/Panel Features</b>	Displays device specific information and setup of device specific values.	Enter	Opens the submenu See "Main Board/Panel Features", on page 456.

Table 252: 855GME (ETX) Advanced Menu setting options

Advanced chipset/graphics control

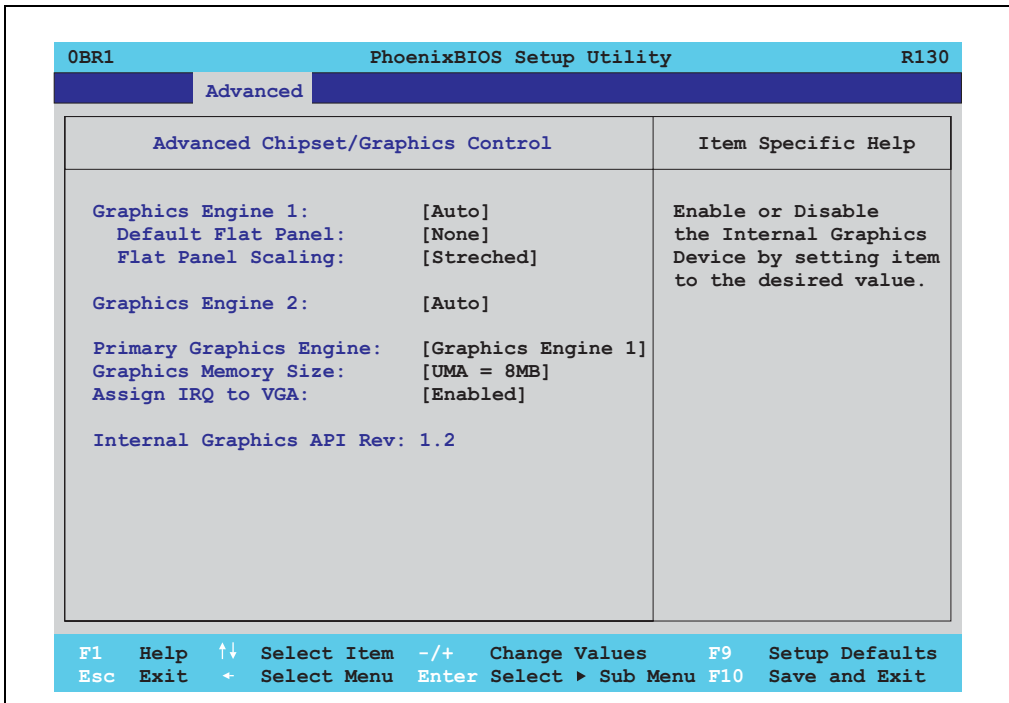

Figure 211: 855GME (ETX) - advanced chipset control

BIOS setting	Meaning	Setting options	Effect
Graphics engine 1	Settings can be made for the onboard video controller (internal graphics device).	Auto	Automatic setting of Graphic Engine 1. The resolution is set using a read-out of the connected panel's EDID data.  <b>Information:</b> If EDID data older than V1.1 is read, it is not passed on to the VGA BIOS
		Disabled	Disable graphics controller.  <b>Information.</b> The onboard video controller must be activated to make video output possible. Deactivate only for use of an external PCI graphics card.

Table 253: 855GME (ETX) Advanced Chipset Control setting options

## Software • BIOS options

BIOS setting	Meaning	Setting options	Effect
Default flat panel	Should the connected panel fail to be automatically recognized, a predefined resolution can be set manually here.	None	A predefined resolution has not been set.
		VGA, SVGA, XGA, XGA2, SXGA, UXGA	VGA = 640 x 480 resolution SVGA = 800 x 600 resolution XGA = 1024 x 768 resolution XGA2 = 1024 x 768 resolution SXGA = 1280 x 1024 resolution UXGA = 1600 x 1200 resolution
Flat panel scaling	For setting whether the video signal should be centered on the panel (stamp format), or fill the entire display (stretched).	Centered	Display is centered.
		Stretched	Display is stretched to fit screen.
Graphics engine 2	Settings can be made for the second onboard video controller (only with an AP Link card).	Auto	Automatic setting of Graphic Engine 2. The resolution is set using a read-out of the connected panel's EDID data.
		Disabled	Deactivates the graphics interface.
Graphics engine	<p>Selection of the primary video output line - depending on the system unit being used, with 5PC600.SX01-00, 5PC600.SX02-01 and 5PC600.SX05-01</p> <ul style="list-style-type: none"> <li>- Graphics engine 1: Monitor / Panel</li> <li>- Graphics engine 2 : not supported</li> </ul> <p>with 5PC600.SX02-00 and 5CP600.SX05-00</p> <ul style="list-style-type: none"> <li>- Graphics engine 1: AP Link output</li> <li>- Graphics engine 2: Monitor / Panel</li> </ul> <p><b>Information:</b></p> <p>The "Primary graphics engine" setting is only relevant from the booting of the system until a graphics driver is started (e.g. in Windows).</p>	Graphics engine 1	The primary video outputs are the display devices on the monitor/panel plug with system units 5PC600.SX01-00, 5PC600.SX02-01 and 5PC600.SX05-01, or the AP Link output with system units 5PC600.SX02-00 and 5CP600.SX05-00.
		Graphics engine 2	The primary video outputs are the display devices on the monitor/panel plug with system units 5PC600.SX02-00 and 5CP600.SX05-00.
Graphics memory size	For setting how much of the main memory (in MB) the graphics controller can use.	1 MB	1 MB main memory to be used by the graphics controller.
		UMA = 8 MB	8 MB main memory to be used by the graphics controller.
		UMA = 16 MB	16 MB main memory to be used by the graphics controller.
		UMA = 32 MB	32 MB main memory to be used by the graphics controller.
Assign IRQ to VGA	This is where an IRQ is reserved and automatically assigned for the CPU board's onboard graphics.	Enabled	Enables this function.
		Disabled	Disables this function.
Internal graphics API Rev	Displays the internal graphics API version number.	-	

Table 253: 855GME (ETX) Advanced Chipset Control setting options (Forts.)



## PCI/PNP Configuration

0BR1 PhoenixBIOS Setup Utility R130	
Advanced	
PCI/PNP Configuration	Item Specific Help
PNP OS installed: [Yes]	Select the operating system installed on your system which you will use most commonly.
Reset Configuration Data: [No]	
Secured Setup Configurations [Yes]	
▶ PCI Device, Slot #1	Note: An incorrect setting can cause some operating systems to display unexpected behavior.
▶ PCI Device, Slot #2	
▶ PCI Device, Slot #3	
▶ PCI Device, Slot #4	
PCI IRQ line 1: [Auto Select]	
PCI IRQ line 2: [Auto Select]	
PCI IRQ line 3: [Auto Select]	
PCI IRQ line 4: [Auto Select]	
Onboard LAN IRQ line: [Auto Select]	
Onboard USB EHCI IRQ line: [Auto Select]	
Default Primary Video Adapter: [PCI]	
Assign IRQ for SMB: [Enabled]	
F1 Help ↑↓ Select Item -/+ Change Values F9 Setup Defaults Esc Exit ← Select Menu Enter Select ▶ Sub Menu F10 Save and Exit	

Figure 212: 815GME (ETX) - PCI/PNP configuration

## Software • BIOS options

BIOS setting	Meaning	Setting options	Effect
PNP OS installed	If the operating system is plug & play capable, then this option informs BIOS that the operating system will handle the distribution of resources in the future.	Yes	The ISA PnP resources are not assigned. The resource assignment sequence is as follows: 1. Motherboard devices 2. PCI devices
		No	The resource assignment sequence is as follows: 1. Motherboard devices 2. ISA PnP devices 3. PCI devices
Reset configuration data	During booting, the assigned resources are stored in Flash (ESCD).	Yes	When the system is reset after leaving the BIOS setup, all ECSD entries (extended system configuration data) are deleted.
		No	Disables this function. Resources are not reset.
Secured setup configuration	This option protects the setup configuration from interference from a PnP operating system.	Yes	Prevents a PnP operating system from changing system settings.
		No	Disables this function. Changes are allowed.
PCI device, slot #1	Advanced configuration of the PCI slot number 1.	Enter	Opens the submenu See "PCI device, slot #1", on page 444
PCI device, slot #2	Advanced configuration of the PCI slot number 2.	Enter	Opens the submenu See "PCI device, slot #2", on page 445
PCI device, slot #3	Advanced configuration of the PCI slot number 3.	Enter	Opens the submenu See "PCI device, slot #3", on page 446
PCI device, slot #4	Advanced configuration of the PCI slot number 4.	Enter	Opens the submenu See "PCI device, slot #4", on page 447
PCI IRQ line 1	Under this option, the external PCI interrupt 1 is assigned to an ISA interrupt.	Auto-select	The interrupt is automatically assigned according to the plug & play guidelines.
		Disabled	Disables this function. No assignment.
		3, 4, 5, 7, 9, 10, 11, 12, 14, 15	Manual configuration of the IRQ.
PCI IRQ line 2	Under this option, the external PCI interrupt 2 is assigned to an ISA interrupt.	Auto-select	The interrupt is automatically assigned according to the plug & play guidelines.
		Disabled	Disables this function. No assignment.
		3, 4, 5, 7, 9, 10, 11, 12, 14, 15	Manual configuration of the IRQ.
PCI IRQ line 3	Under this option, the external PCI interrupt 3 is assigned to an ISA interrupt.	Auto-select	The interrupt is automatically assigned according to the plug & play guidelines.
		Disabled	Disables this function. No assignment.
		3, 4, 5, 7, 9, 10, 11, 12, 14, 15	Manual configuration of the IRQ.
PCI IRQ line 4	Under this option, the external PCI interrupt 4 is assigned to an ISA interrupt.	Auto-select	The interrupt is automatically assigned according to the plug & play guidelines.
		Disabled	Disables this function. No assignment.
		3, 4, 5, 7, 9, 10, 11, 12, 14, 15	Manual configuration of the IRQ.

Table 254: 855GME (ETX) PCI/PNP Configuration setting options

BIOS setting	Meaning	Setting options	Effect
Onboard LAN IRQ line	Under this option, the onboard LAN interrupt is assigned to an ISA interrupt.	Auto-select	The interrupt is automatically assigned according to the plug & play guidelines.
		Disabled	Disables this function. No assignment.
		3, 4, 5, 7, 9, 10, 11, 12, 14, 15	Manual configuration of the IRQ.
Onboard USB EHCI IRQ line	Under this option, the USB EHCI interrupt is assigned to an ISA interrupt.	Auto-select	The interrupt is automatically assigned according to the plug & play guidelines.
		Disabled	Disables this function. No assignment.
		3, 4, 5, 7, 9, 10, 11, 12, 14, 15	Manual configuration of the IRQ.
Default primary video adapter	This option sets the first activated graphics card (either an existing AGP or the PCI graphics card).	PCI	A PCI graphics card is set as the default display device.
		AGP	An AGP graphics card is set as the default display device.
Assign IRQ to SMB	Use this function to set whether or not the SM (System Management) bus controller is assigned a PCI interrupt.	Enabled	Automatic assignment of a PCI interrupt.
		Disabled	No assignment of an interrupt.

Table 254: 855GME (ETX) PCI/PNP Configuration setting options (Forts.)

[PCI device, slot #1](#)

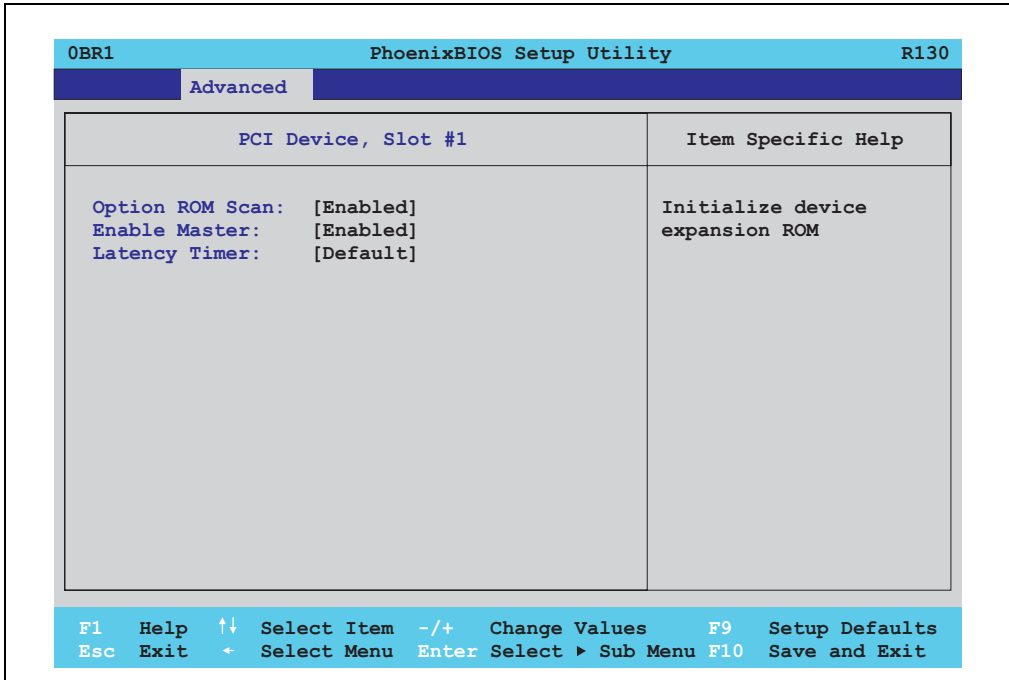

Figure 213: 855GME (ETX) - PCI device, slot #1

BIOS setting	Meaning	Setting options	Effect
ROM scan option	Setting for the initialization of a device's ROM.	Enabled	Enables this function.
		Disabled	Disables this function.
Enable master	Sets the PCI device to be treated as the PCI bus master. Not all PCI devices can function as PCI bus master! Check device description.	Enabled	Enables this function.
		Disabled	Disables this function.
Latency timer	This option controls how long one card can continue to use the PCI bus master after another PCI card has requested access.	Default	Default setting. Default
		0020h, 0040h, 0060h, 0080h, 00A0h, 00C0h, 00E0h	Value set manually.

Table 255: 855GME (ETX) - PCI device, slot #1 - setting options

PCI device, slot #2

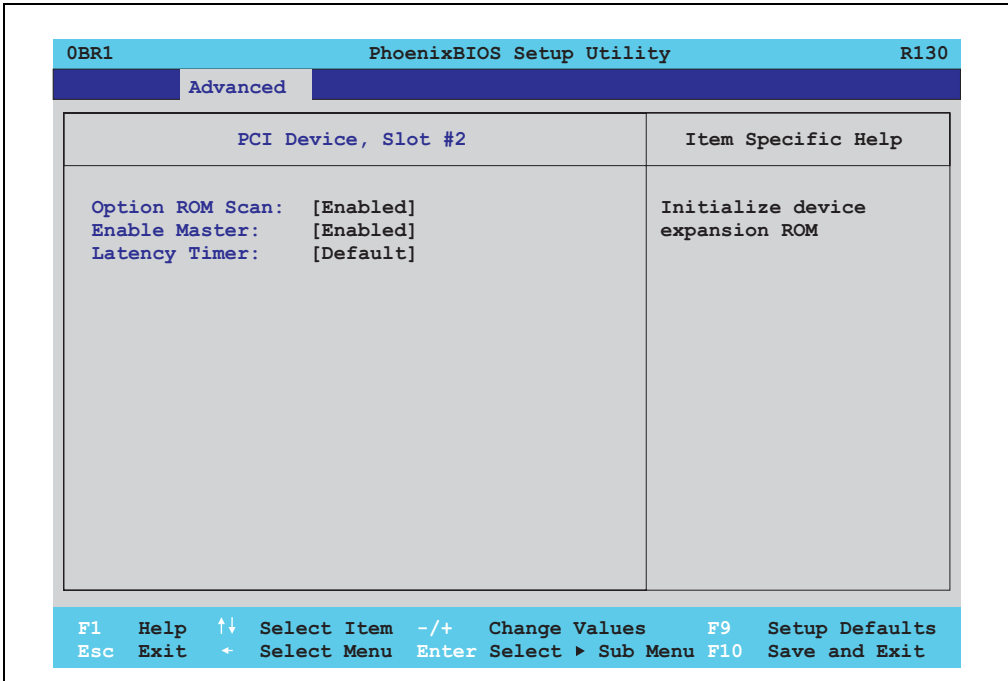

Figure 214: 855GME (ETX) - PCI device, slot #2

BIOS setting	Meaning	Setting options	Effect
ROM scan option	Setting for the initialization of a device's ROM.	Enabled	Enables this function.
		Disabled	Disables this function.
Enable master	Sets the PCI device to be treated as the PCI bus master. Not all PCI devices can function as PCI bus master! Check device description.	Enabled	Enables this function.
		Disabled	Disables this function.
Latency timer	This option controls how long one card can continue to use the PCI bus master after another PCI card has requested access.	Default	Default setting. Default
		0020h, 0040h, 0060h, 0080h, 00A0h, 00C0h, 00E0h	Value set manually.

Table 256: 855GME (ETX) - PCI device, slot #2 - setting options

[PCI device, slot #3](#)

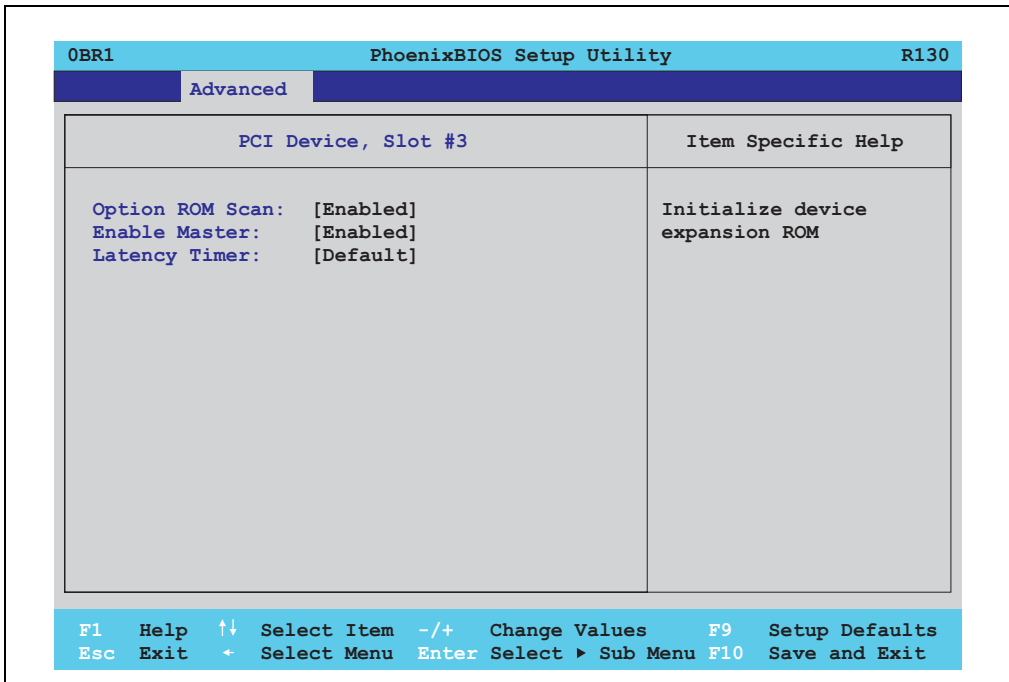

Figure 215: 855GME (ETX) - PCI device, slot #3

BIOS setting	Meaning	Setting options	Effect
ROM scan option	Setting for the initialization of a device's ROM.	Enabled	Enables this function.
		Disabled	Disables this function.
Enable master	Sets the PCI device to be treated as the PCI bus master. Not all PCI devices can function as PCI bus master! Check device description.	Enabled	Enables this function.
		Disabled	Disables this function.
Latency timer	This option controls how long one card can continue to use the PCI bus master after another PCI card has requested access.	Default	Default setting. Default
		0020h, 0040h, 0060h, 0080h, 00A0h, 00C0h, 00E0h	Value set manually.

Table 257: 855GME (ETX) - PCI device, slot #3 - setting options

PCI device, slot #4

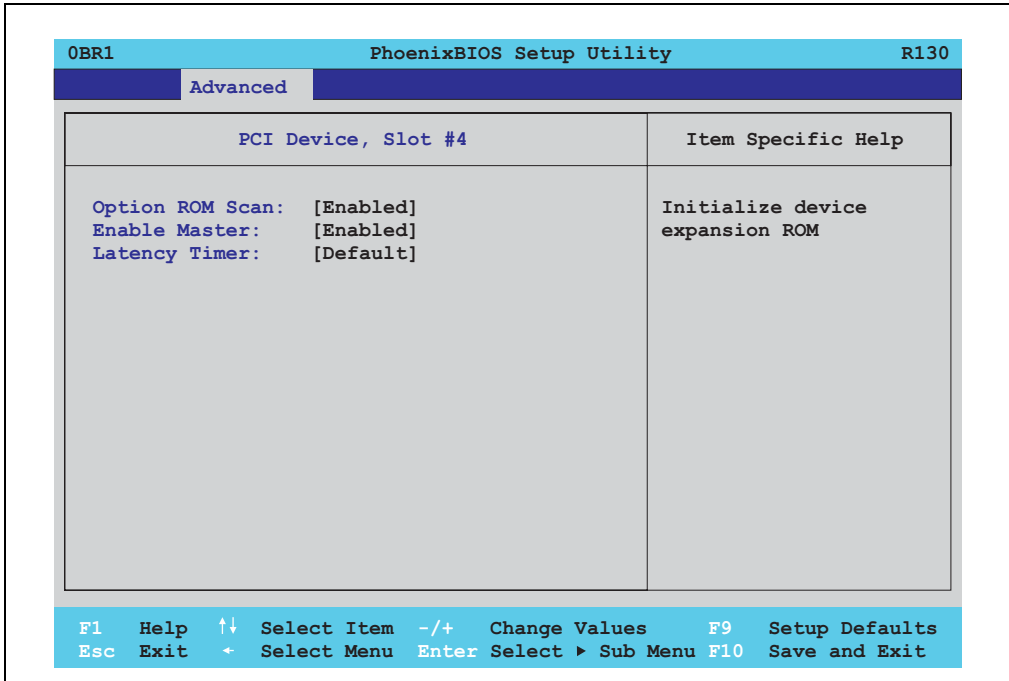

Figure 216: 855GME (ETX) - PCI device, slot #4

BIOS setting	Meaning	Setting options	Effect
ROM scan option	Setting for the initialization of a device's ROM.	Enabled	Enables this function.
		Disabled	Disables this function.
Enable master	Sets the PCI device to be treated as the PCI bus master. Not all PCI devices can function as PCI bus master! Check device description.	Enabled	Enables this function.
		Disabled	Disables this function.
Latency timer	This option controls how long one card can continue to use the PCI bus master after another PCI card has requested access.	Default	Default setting. Default
		0020h, 0040h, 0060h, 0080h, 00A0h, 00C0h, 00E0h	Value set manually.

Table 258: 855GME (ETX) - PCI device, slot #4 - setting options

Memory cache

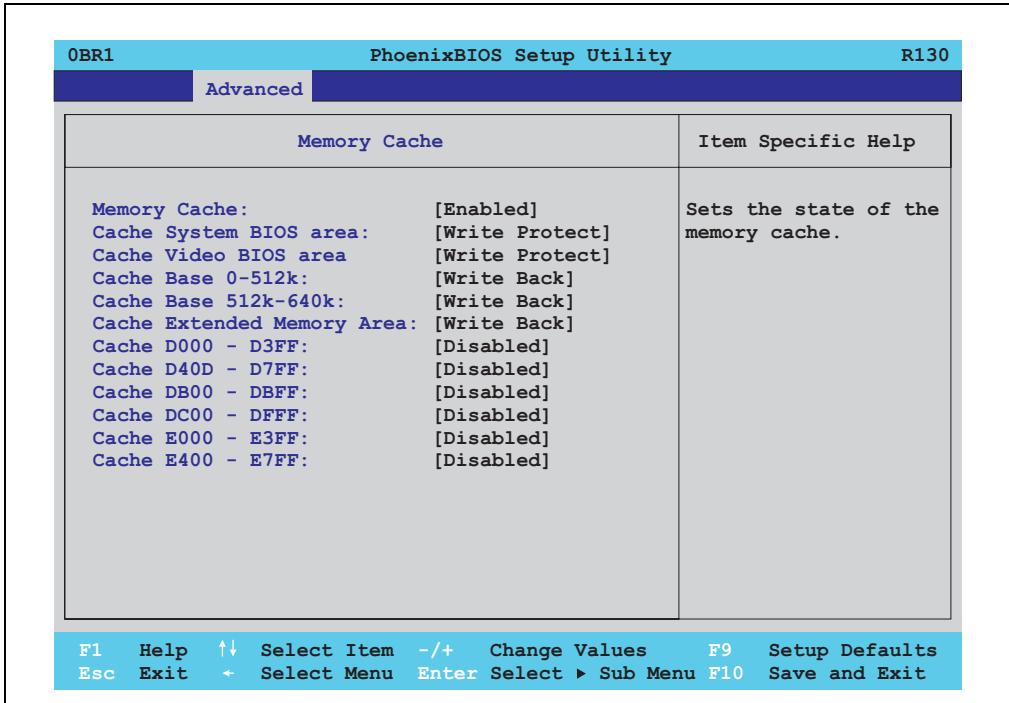

Figure 217: 855GME (ETX) - memory cache

BIOS setting	Meaning	Setting options	Effect
Memory cache	Enable/ disable utilization of the L2 cache.	Enabled	Enables this function.
		Disabled	Disables this function.
Cache system BIOS area	Set whether or not the system BIOS should be buffered.	Write protect	System BIOS is mapped in the cache.
		Uncached	System BIOS is not mapped in the cache.
Cache video BIOS area	Set whether or not the video BIOS should be buffered.	Write protect	Video BIOS is mapped in the cache.
		Uncached	Video BIOS is not mapped in the cache.
Cache base 0-512k	Set whether the memory content should be mapped in the cache (0-512k), and when necessary, written in the main memory.	Disabled	No mapping.
		Write through	Memory content is simultaneously mapped in the cache and written to the main memory.
		Write protect	Memory content is mapped in the cache.
		Write back	Memory content is mapped only when necessary.

Table 259: 855GME (ETX) Memory Cache setting options



BIOS setting	Meaning	Setting options	Effect
Cache base 512-640k	Set whether the memory content should be mapped in the cache (512-640k), and when necessary, written in the main memory.	Disabled	No mapping.
		Write through	Memory content is simultaneously mapped in the cache and written to the main memory.
		Write protect	Memory content is mapped in the cache.
		Write back	Memory content is mapped only when necessary.
Cache extended memory area	Configure how the memory content of the system memory above 1MB should be mapped.	Disabled	No mapping.
		Write through	Memory content is simultaneously mapped in the cache and written to the main memory.
		Write protect	Memory content is mapped in the cache.
		Write back	Memory content is mapped only when necessary.
Cache D000 - D3FF	Configure how the memory content of D000-D3FF should be mapped.	Disabled	No mapping.
		Write through	Memory content is simultaneously mapped in the cache and written to the main memory.
		Write protect	Memory content is mapped in the cache.
		Write back	Memory content is mapped only when necessary.
Cache D400 - D7FF	Configure how the memory content of D400-D7FF should be mapped.	Disabled	No mapping.
		Write through	Memory content is simultaneously mapped in the cache and written to the main memory.
		Write protect	Memory content is mapped in the cache.
		Write back	Memory content is mapped only when necessary.
Cache D800 - DBFF	Configure how the memory content of D800-DBFF should be mapped.	Disabled	No mapping.
		Write through	Memory content is simultaneously mapped in the cache and written to the main memory.
		Write protect	Memory content is mapped in the cache.
		Write back	Memory content is mapped only when necessary.
Cache DC00 - DFFF	Configure how the memory content of DC00-DFFF should be mapped.	Disabled	No mapping.
		Write through	Memory content is simultaneously mapped in the cache and written to the main memory.
		Write protect	Memory content is mapped in the cache.
		Write back	Memory content is mapped only when necessary.
Cache E000 - E3FF	Configure how the memory content of E00-E3FF should be mapped.	Disabled	No mapping.
		Write through	Memory content is simultaneously mapped in the cache and written to the main memory.
		Write protect	Memory content is mapped in the cache.
		Write back	Memory content is mapped only when necessary.
Cache E400 - E7FF	Configure how the memory content of E400-E7FF should be mapped.	Disabled	No mapping.
		Write through	Memory content is simultaneously mapped in the cache and written to the main memory.
		Write protect	Memory content is mapped in the cache.
		Write back	Memory content is mapped only when necessary.

Table 259: 855GME (ETX) Memory Cache setting options (Forts.)

I/O Device Configuration

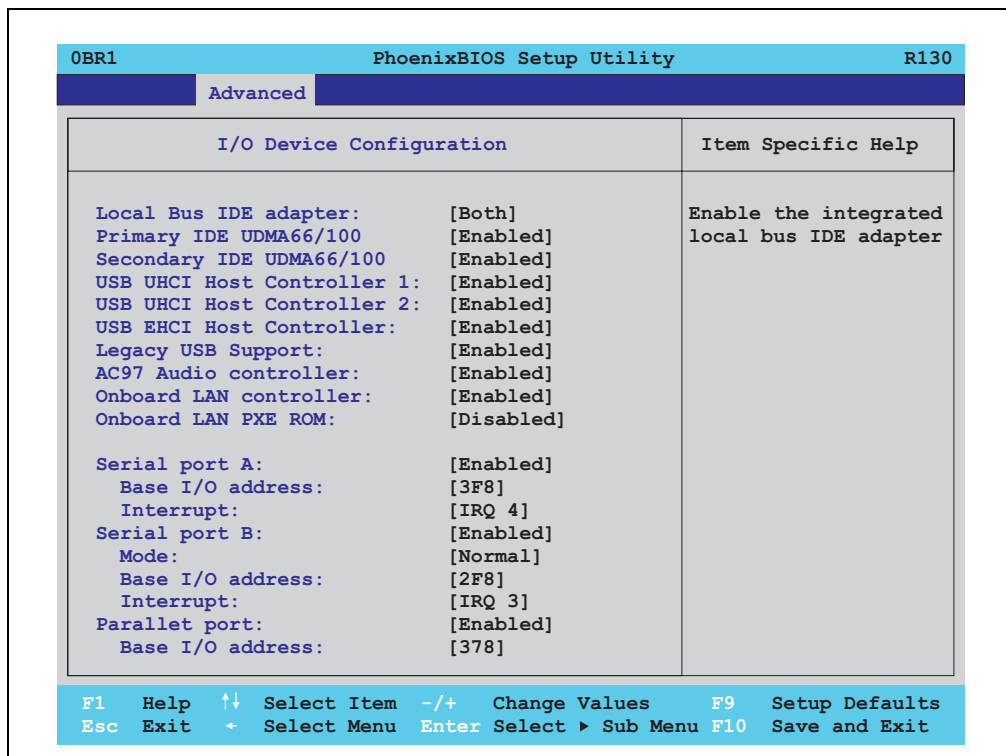

Figure 218: 855GME (ETX) - I/O device configuration

BIOS setting	Meaning	Setting options	Effect
Local bus IDE adapter	Enable or disable one or both of the PCI IDE controllers (primary and secondary).	Disabled	Deactivates both PCI IDE controllers (primary and secondary).
		Primary	Activates the primary IDE controller only.
		Secondary	Activates the secondary IDE controller only.
		Both	Activates both PCI IDE controllers (primary and secondary).
Primary IDE UDMA66/100	Setup the data transfer rate for a device connected to the primary IDE channel. This option is only available when a primary IDE drive is connected.	Disabled	The maximum data transfer rate is UDMA33.
		Enabled	The maximum data transfer rate is UDMA66 or higher.
Secondary IDE UDMA66/100	Setup the data transfer rate for a device connected to the secondary IDE channel. This option is only available when a secondary IDE drive is connected.	Disabled	The maximum data transfer rate is UDMA33.
		Enabled	The maximum data transfer rate is UDMA66.

Table 260: 855GME (ETX) I/O Device Configuration setting options

BIOS setting	Meaning	Setting options	Effect
USB UHCI host controller 1	Configuration of USB UHCI controller 1 for USB port 0 and 1.	Disabled	Deactivates the USB support.
		Enabled	Activates the USB support.
USB UHCI host controller 2	Configuration of the USB UHCI controller 1 for USB port 2 and 3. Can only be configured if the USB UHCI controller 1 is activated.	Disabled	Deactivates the USB support.
		Enabled	Activates the USB support.
USB UHCI host controller	Configuration of the USB EHCI controller. Can only be configured if the USB UHCI controller 1 is activated.	Disabled	Deactivates the USB support.
		Enabled	When enabled, the USB 2.0 support is activated as soon as a USB 2.0 device is connected to the interface.
Legacy USB Support	Here IRQs are assigned to the USB connections.	Disabled	No IRQ assigned.  It is not possible to boot from a USB device (USB stick, USB floppy, USB CD ROM, etc.)! However, a connected USB keyboard can be used to access and configure the BIOS setup, boot menu or optional RAID boot menu. USB devices will not function after completing the BIOS POST routine. USB devices only work after starting the operating system with USB support (e.g. Windows XP). MS-DOS does not support the use of USB devices.
		Enabled	IRQ assigned.  Booting from USB devices is now possible. Supported USB devices work with MS-DOS (e.g. USB keyboard, etc).
AC97 audio controller	For turning the AC97 audio controller on and off.	Disabled	AC97 sound is deactivated.
		Enabled	AC97 sound is activated.
Onboard LAN controller	For turning the ICH4 on-board LAN controller (for ETH1) on and off.	Disabled	Deactivates the LAN controller or the ETH1 interface.
		Enabled	Activates the LAN controller or the ETH1 interface.
Onboard LAN PXE ROM	For turning the remote boot BIOS extension for the onboard LAN controller (ETH1) on and off.	Disabled	Disables this function.
		Enabled	Enables this function.
Serial port A	For the configuration of serial port A (COM1).	Disabled	Port A deactivated.
		Enabled	Port A activated. The base I/O addresses and the interrupt must then be configured manually.
		Auto	Either BIOS or the operating system configures the port automatically.
Base I/O address	Selection of the base I/O address for port A. A yellow star indicates a conflict with another device.	3F8, 2F8, 3E8, 2E8	Base I/O address is manually assigned.
Interrupt	Selection of the interrupt for port A. A yellow star indicates a conflict with another device.	IRQ 3, IRQ 4	Manual assignment of the interrupt.

Table 260: 855GME (ETX) I/O Device Configuration setting options (Forts.)

BIOS setting	Meaning	Setting options	Effect
Serial port B	For the configuration of serial port B (COM2).	Disabled	Port B deactivated.
		Enabled	Port A activated. The base I/O addresses and the interrupt must then be configured manually.
		Auto	Either BIOS or the operating system configures the port automatically.
Mode	This option is for setting the serial port B as either a standard interface or as an infrared interface.	Normal	Serial port B is used as a standard interface.
		IR	The serial interface is used as an infrared interface, and allows data transfers up to 115 kBit/s.
Base I/O address	Selection of the base I/O address for port B. A yellow star indicates a conflict with another device.	3F8, 2F8, 3E8, 2E8	Selected base I/O address is manually assigned.
Interrupt	Selection of the interrupt for port B. A yellow star indicates a conflict with another device.	IRQ 3, IRQ 4	Selected interrupt is assigned.
Parallel port	For configuring the hardware security key (dongle), which accessed internally through the parallel interface.	Disabled	Deactivates the port.
		Enabled	Activates the port. The base I/O address must then be set.
		Auto	First BIOS and then the operating system configure the port automatically.
Base I/O address	Selection of the base I/O address for the parallel port.	378, 278, 3BC	Base I/O address is manually assigned.

Table 260: 855GME (ETX) I/O Device Configuration setting options (Forts.)

Keyboard features

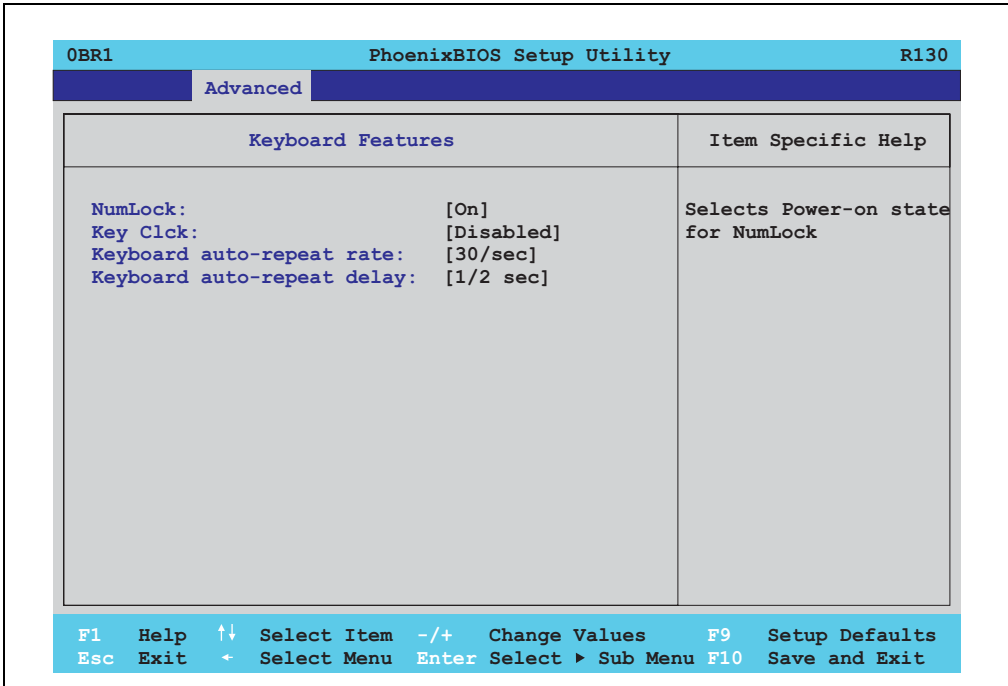

Figure 219: 855GME (ETX) Keyboard Features

BIOS setting	Meaning	Setting options	Effect
NumLock	This option sets the status of the numeric keypad when the the system is booted.	On	Numeric keypad is enabled.
		Off	Only the cursor functions of the numerical keypad are activated.
		Auto	Numeric keypad is activated, if present.
Key click	Using this option, the clicking of the keys can be turned on or off.	Disabled	Disables this function.
		Enabled	Enables this function.
Keyboard auto-repeat rate	For setting the speed of repetition when a key is held down.	30/sec, 26.7/sec, 21.8/sec, 18.5/sec, 13.3/sec, 10/sec, 6/sec, 2/sec	Settings from 2 to 30 characters per second.
Keyboard auto-repeat delay	For setting the amount of delay after the key is pressed before the auto-repeat begins.	1/4 sec, 1/2 sec, 3/4 sec, 1 sec	Setting of the desired delay.

Table 261: 855GME (ETX) Keyboard Features setting options

## CPU board monitor

**Information:**

The displayed voltage values (e.g. core voltage, battery voltage) on this BIOS Setup page represent uncalibrated information values. These cannot be used to draw any conclusions about any hardware alarms or error conditions. The hardware components used have automatic diagnostics functions that can be applied in the event of error.

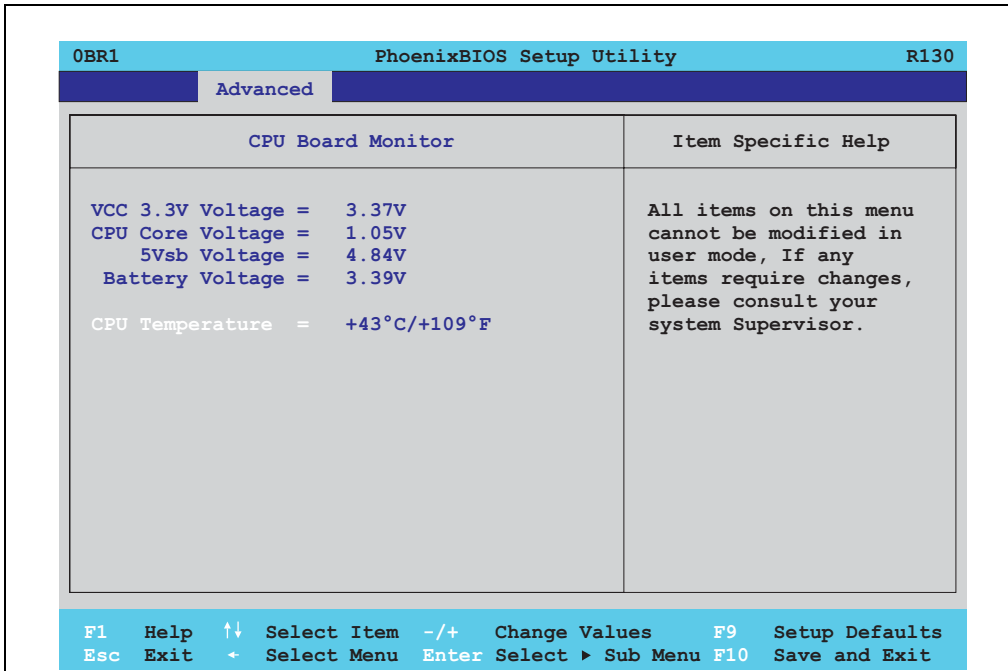

Figure 220: 855GME (ETX) - CPU board monitor

BIOS setting	Meaning	Setting options	Effect
VCC 3.3V voltage	Displays the current voltage of the 3.3 volt supply (in volts).	None	
CPU core voltage	Displays the processor's core voltage (in volts).	None	
5Vsb voltage	Displays the 5 V standby voltage (in volts).	None	
Battery voltage	Displays the battery voltage (in volts).	None	
CPU temperature	Displays the processor's temperature (in degrees Celsius and Fahrenheit).	None	

Table 262: 855GME (ETX) - CPU board monitor - setting options

Miscellaneous

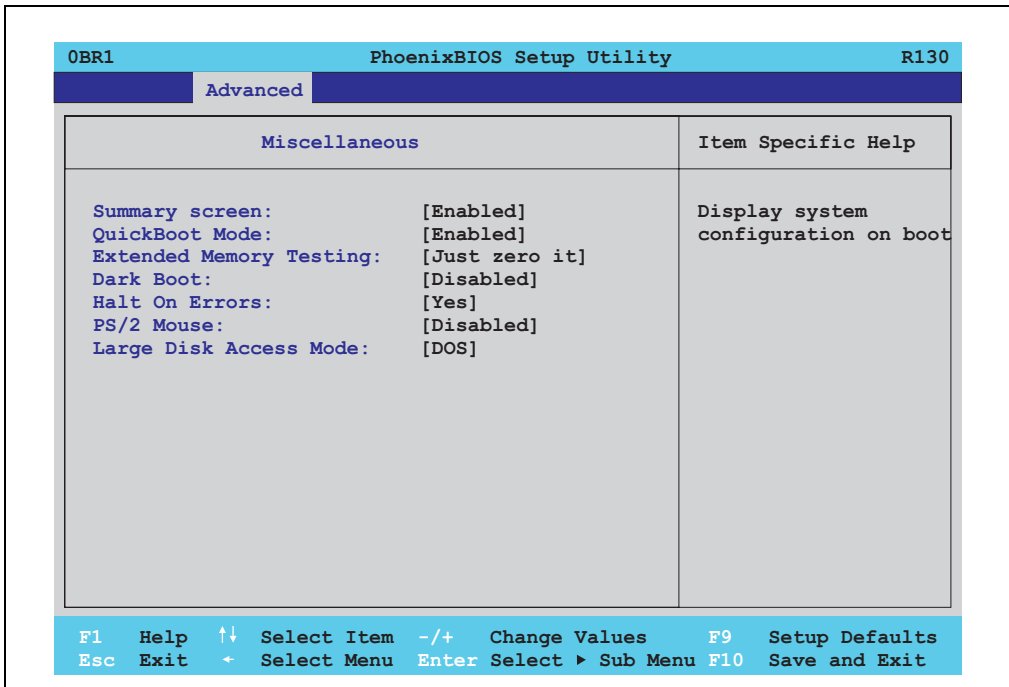

Figure 221: 855GME (ETX) miscellaneous

BIOS setting	Meaning	Setting options	Effect
Summary screen	Set whether or not the system summary screen should open when the system is started (see figure 204 "855GME (ETX) BIOS Summary Screen", on page 426).	Enabled	Enables this function.
		Disabled	Disables this function.
QuickBoot mode	Speeds up the booting process by skipping several tests.	Enabled	Enables this function.
		Disabled	Disables this function.
Extended memory testing	This function determines the method by which the main memory over 1 MB is tested.	Just zero it	The main memory is quickly tested.
		None	The main memory is not tested at all.
		Normal	This option is only available when the function "QuickBoot Mode" has been set to "disabled." The main memory is tested more slowly than with "Just zero It."
Dark boot	Sets whether the diagnostics screen (see figure 203 "855GME (ETX) BIOS Diagnostics Screen", on page 426) should be displayed when the system is started.	Enabled	Enables this function. The diagnostics screen is not displayed.
		Disabled	Disables this function. The diagnostics screen is displayed.

Table 263: 855GME (ETX) miscellaneous - setting options

## Software • BIOS options

BIOS setting	Meaning	Setting options	Effect
Halt on errors	This option sets whether the system should pause the Power On Self Test (POST) when it encounters an error.	Yes	The system pauses. The system pauses every time an error is encountered.
		No	The system does not pause. All errors are ignored.
PS/2 mouse	Sets whether the PS/2 mouse port should be activated.	Disabled	Deactivates the port.
		Enabled	Activates the port. The IRQ12 is reserved, and is not available for other components.
Large disk access mode	This option is intended for hard discs with more than 1024 cylinders, 16 heads, and more than 63 sectors per track. Setting options: DOS	Other	For non-compatible access (e.g. Novell, SCO Unix.)
		DOS	For MS DOS compatible access.

Table 263: 855GME (ETX) miscellaneous - setting options

## Main Board/Panel Features

Baseboard/Panel Features		Item Specific Help
<ul style="list-style-type: none"> <li>▶ Panel Control</li> <li>▶ Baseboard Monitor</li> <li>▶ Legacy Devices</li> </ul> <p>Versions</p> <p>BIOS: R130</p> <p>MTCX PX32: V1.63</p> <p>MTCX FPGA: V1.19</p> <p>Optimized ID: 00000010b</p> <p>Device ID: 00001BB7h</p> <p>Compatibility ID: 0000h</p> <p>Serial Number: 70950173619</p> <p>Product Name: 5PC600.SX02-01</p> <p>User Serial ID: FFFFFFFFh</p>		
<p>F1 Help    ↑↓ Select Item    -/+ Change Values    F9 Setup Defaults</p> <p>Esc Exit    ← Select Menu    Enter Select    ▶ Sub Menu    F10 Save and Exit</p>		

Figure 222: 855GME (ETX) Baseboard/Panel Features

BIOS setting	Meaning	Setting options	Effect
Panel control	For special setup of connected panels.	Enter	Opens the submenu See "Panel control", on page 458.
Main board monitor	Display of various temperatures and fan speeds.	Enter	Opens the submenu See "Main board monitor", on page 459.

Table 264: 855GME (ETX) Baseboard/Panel Features setting options



BIOS setting	Meaning	Setting options	Effect
Legacy devices		Enter	Opens the submenu See "Legacy devices", on page 461.
BIOS	Displays the BIOS version.	None	-
MTCX PX32	Displays the MTCX PX32 firmware version.	None	-
MTCX FPGA	Displays the MTCX FPGA firmware version.	None	-
Optimized ID	Displays the DIP switch setting of the configuration switch.	None	-
Device ID	Displays the hexadecimal value of the hardware device ID.	None	-
Compatibility ID	Displays the version of the device within the same B&R device code. This ID is needed for Automation Runtime.	None	-
Serial Number	Displays the B&R serial number.	None	-
Product name	Displays the B&R model number.	None	-
User serial ID	Displays the user serial ID. This 8 digit hex value can be freely assigned by the user (e.g. to give the device a unique ID) and can only be changed with using the "B&R Control Center" via the ADI driver.	None	-

Table 264: 855GME (ETX) Baseboard/Panel Features setting options (Forts.)

Panel control

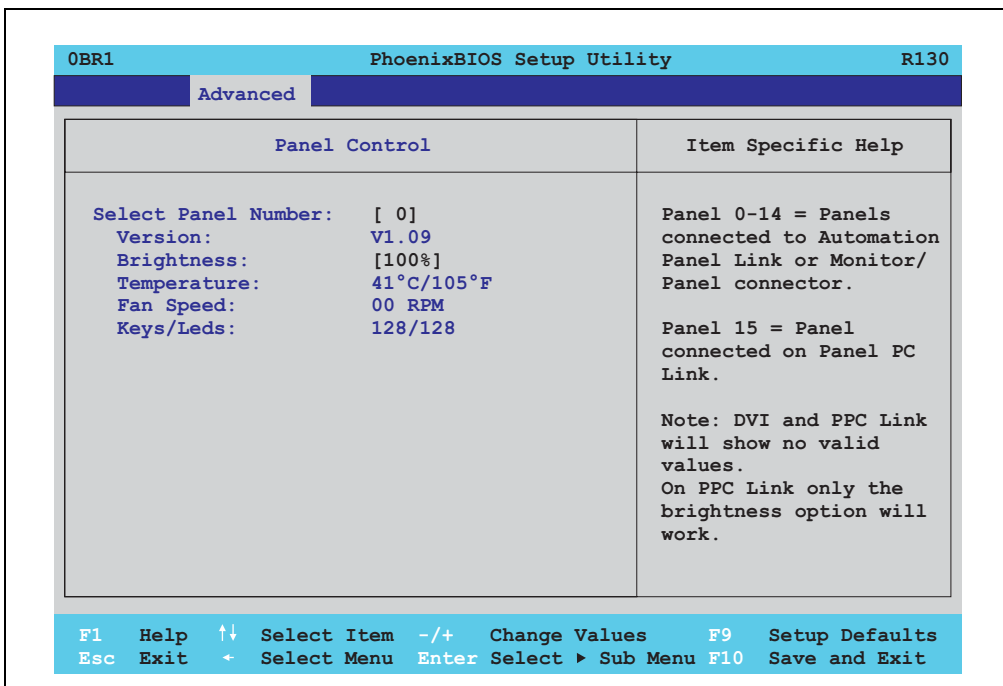

Figure 223: 855GME (ETX) Panel Control

BIOS setting	Meaning	Setting options	Effect
Select panel number	Selection of the panel number for which the values should be read out and/or changed.	0 ... 15	Selection of panel 0 ... 15. Panel 15 is specifically intended for panel PC 700 systems.
Version	Displays the firmware version of the SDLR controller.	None	-
Brightness	For setting the brightness of the selected panel.	0%, 25%, 50%, 75%, 100%	For setting the brightness (in %) of the selected panel. Changes take effect after saving and restarting the system (e.g. by pressing <F10>).
Temperature	Displays the selected panel's temperature (in degrees Celsius and Fahrenheit).	None	-
Fan speed	Displays fan speed for the selected panel.	None	-
Keys/LEDs	Displays the available keys and LEDs on the selected panel.	None	-

Table 265: 855GME (ETX) Panel Control setting options

Main board monitor

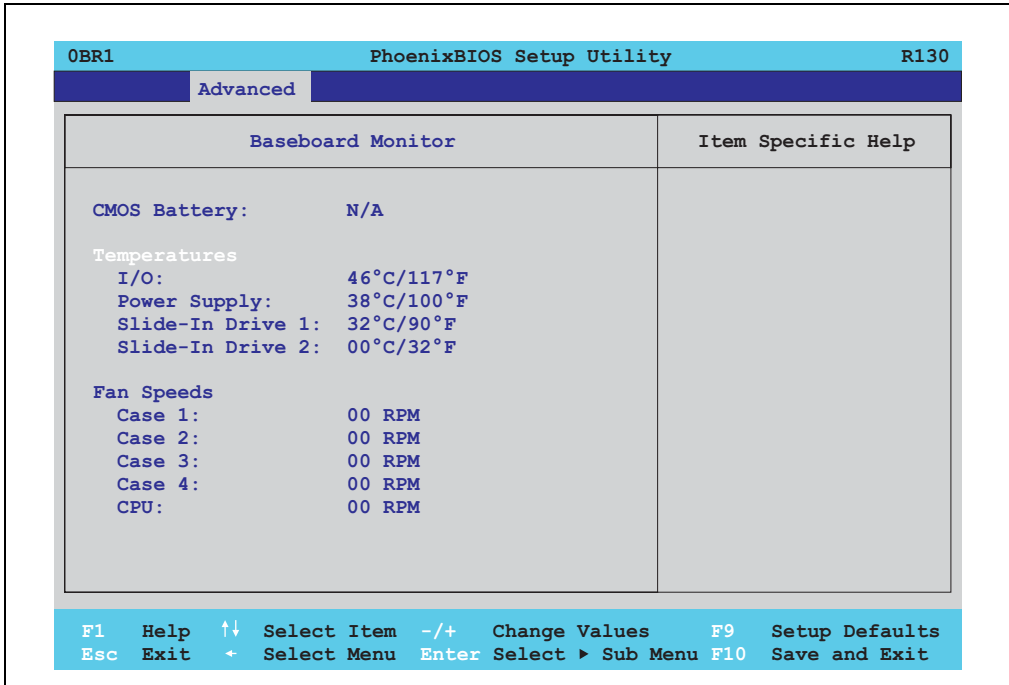

Figure 224: 855GME (ETX) - baseboard monitor

BIOS setting	Meaning	Setting options	Effect
CMOS battery	The status of the built-in CMOS battery is displayed here. Possible displays: <b>N/A</b> - Not Available, <b>GOOD</b> - Battery OK, <b>BAD</b> - Battery must be replaced. For additional information on when status displays are shown, see "Battery", on page 158	None	-
I/O	Displays the temperature in the I/O area in degrees Celsius and Fahrenheit.	None	-
Power supply	Displays the temperature in the power supply area in degrees Celsius and Fahrenheit.	None	-
Slide-in drive 1	Displays the temperature of the slide-in drive 1 in degrees Celsius and Fahrenheit.	None	-
Slide-in drive 2	Displays the temperature of the slide-in drive 2 in degrees Celsius and Fahrenheit.	None	-
Case 1	Displays the fan speed of housing fan 1.	None	-
Case 2	Displays the fan speed of housing fan 2.	None	-

Table 266: 855GME (ETX) - baseboard monitor - setting options

## Software • BIOS options

BIOS setting	Meaning	Setting options	Effect
Case 3	Displays the fan speed of housing fan 3.	None	-
Case 4	Displays the fan speed of housing fan 4.	None	-
CPU	Displays the fan speed of the processor fan.	None	-

Table 266: 855GME (ETX) - baseboard monitor - setting options (Forts.)

Legacy devices

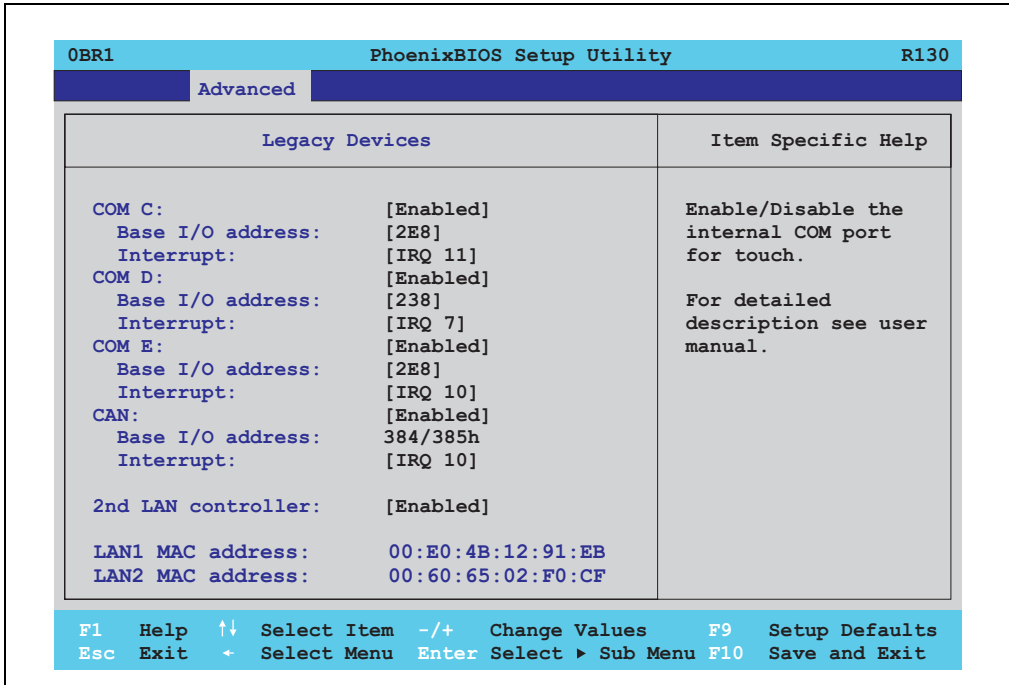

Figure 225: 855GME (ETX) Legacy Devices

BIOS setting	Meaning	Setting options	Effect
COM C	Settings for the internal serial interfaces in the system. This setting activates the touch screen in panel PC 700 systems, and, using SDL transfer technology, also in Automation Panel 900 display units.	Disabled	Disables the interface.
		Enabled	Enables the interface.
Base I/O address	Selection of the base I/O address for the COM C port. A yellow star indicates a conflict with another device.	238, 2E8, 2F8, 328, 338, 3E8, 3F8	Selected base I/O address is assigned.
Interrupt	Selection of the interrupt for the COM C port. A yellow star indicates a conflict with another device.	IRQ 3, IRQ 4, IRQ 5, IRQ 7, IRQ 10, IRQ 11, IRQ 12	Selected interrupt is assigned.
COM D	Configuration of the COM D port for the serial interface of an automation panel link slot. The interface is used to operate the touch screen on connected Automation Panel 900 units.	Disabled	Disables the interface.
		Enabled	Enables the interface.

Table 267: 855GME (ETX) Legacy Devices setting options

## Software • BIOS options

BIOS setting	Meaning	Setting options	Effect
Base I/O address	Configuration of the base I/O address for the serial COM D port. A yellow star indicates a conflict with another device.	238, 2E8, 2F8, 328, 338, 3E8, 3F8	Selected base I/O address is assigned.
Interrupt	Selection of the interrupt for the COM D port. A yellow star indicates a conflict with another device.	IRQ 3, IRQ 4, IRQ 5, IRQ 7, IRQ 10, IRQ 11, IRQ 12	Selected interrupt is assigned.
COM E	Configuration of the optional COM E port on a B&R add-on interface (IF option).	Disabled	Disables the interface.
		Enabled	Enables the interface.
Base I/O address	Configuration of the base I/O address for the serial COM E port. A yellow star indicates a conflict with another device.	238, 2E8, 2F8, 328, 338, 3E8, 3F8	Selected base I/O address is assigned.
Interrupt	Selection of the interrupt for the COM E port. A yellow star indicates a conflict with another device.	IRQ 3, IRQ 4, IRQ 5, IRQ 7, IRQ 10, IRQ 11, IRQ 12	Selected interrupt is assigned.
LPT	This setting is specific to B&R and should not be changed.	Disabled	Disables the interface.
		Enabled	Enables the interface.
Base I/O address	Configuration of the base I/O address for the optional LPT. A yellow star indicates a conflict with another device.	278, 378, 3BC	Selected base I/O address is assigned.
CAN	Configuration of the CAN port of a B&R add-on interface card.	Disabled	Disables the interface.
		Enabled	Enables the interface.
Base I/O address	384/385h	None	-
Interrupt	Selection of the interrupt for the CAN port.	IRQ 10	Selected interrupt is assigned.
		NMI	NMI interrupt is assigned.
2nd LAN controller	For turning the onboard LAN controller (ETH2) on and off.	Disabled	Disables the controller.
		Enabled	Enables the controller.
LAN1 MAC address	Displays the MAC addresses for the ETH1 network controller.	None	-
LAN2 MAC address	Displays the MAC addresses for the ETH2 network controller.	None	-

Table 267: 855GME (ETX) Legacy Devices setting options (Forts.)

1.2.6 Security

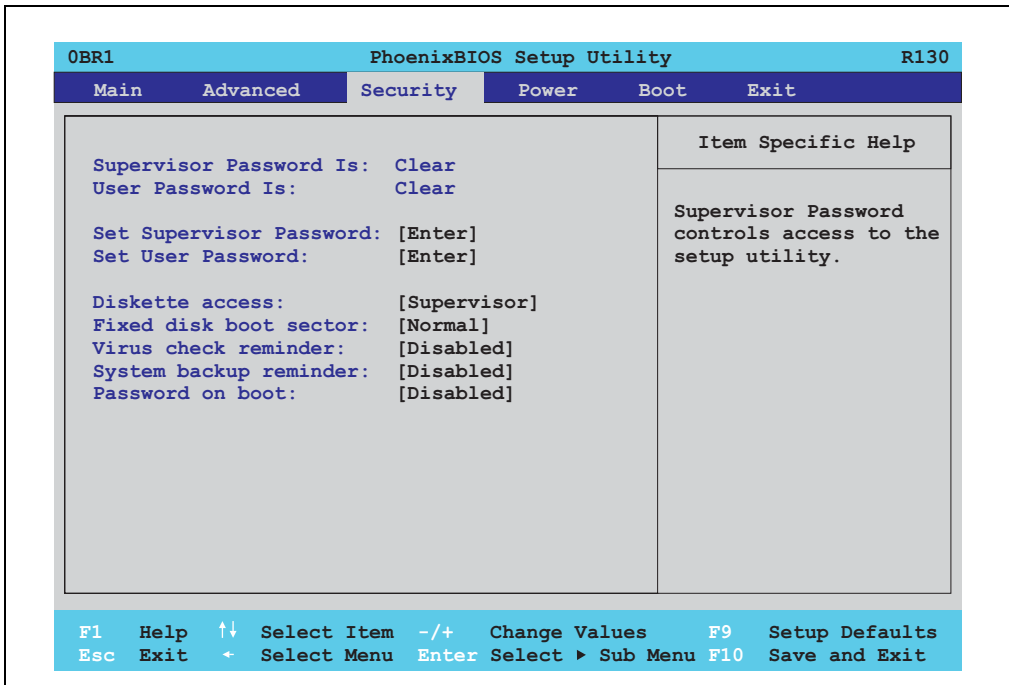

Figure 226: 855GME (ETX) Security Menu

BIOS setting	Meaning	Setting options	Effect
Supervisor password is	Displays whether or not a supervisor password has been set.	None	Display <b>set</b> : A supervisor password has been set. Display <b>clear</b> : No supervisor password has been set.
User password is	Displays whether or not a user password has been set.	None	Display <b>set</b> : A user password has been set. Display <b>clear</b> : No user password has been set.
Set supervisor password	To enter/change a supervisor password. A supervisor password is necessary to edit all BIOS settings.	Enter maximum 7 alphanumeric characters - not case sensitive.	Press Enter and enter password two times. The password must be 7 alphanumeric characters or less. Needed to enter BIOS setup. To change the password, enter the old password once and then the new password twice.
Set user password	To enter/change a user password. A user password allows the user to edit only certain BIOS settings.	Enter maximum 7 alphanumeric characters - not case sensitive.	Press Enter and enter password two times. The password must be 7 alphanumeric characters or less. Needed to enter BIOS setup. To change the password, enter the old password once and then the new password twice.

Table 268: 855GME (ETX) Security setting options

## Software • BIOS options

BIOS setting	Meaning	Setting options	Effect
Diskette access	Access to the diskette drive is controlled here. Either or the supervisor or the user has access to it. Does not work with USB diskette drives.	Supervisor	Supervisor password is needed to access a diskette drive.
		User	User password is needed to access a diskette drive.
Fixed disk boot sector	The boot sector of the primary hard drive can be write protected against viruses with this option.	Normal	Write access allowed.
		Write protect	Boot sector is write protected.
Virus check reminder	This function opens a reminder when the system is started to scan for viruses.	Disabled	Disables this function.
		Daily	A reminder appears every day when the system is started.
		Weekly	A reminder appears the first time the system is started after every Sunday.
		Monthly	A reminder appears the first time the system is started each month.
System backup reminder	This function opens a reminder when the system is started to create a system backup.	Disabled	Disables this function.
		Daily	A reminder appears every day when the system is started.
		Weekly	A reminder appears the first time the system is started after every Sunday.
		Monthly	A reminder appears the first time the system is started each month.
Password at boot	This function requires a supervisor or user password when the system is started. Only possible when a supervisor or user password is enabled.	Disabled	Disables this function.
		Enabled	Enables this function.

Table 268: 855GME (ETX) Security setting options (Forts.)



1.2.7 Power

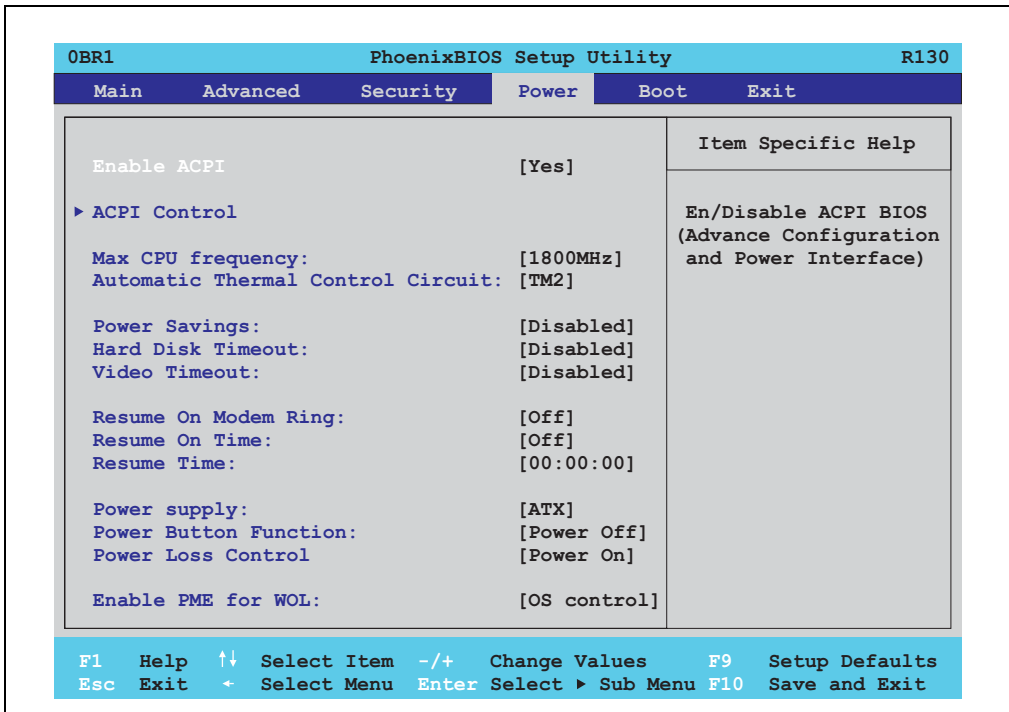

Figure 227: 855GME (ETX) Power menu

BIOS setting	Meaning	Setting options	Effect
Enable ACPI	This option turns the ACPI function (Advanced Configuration and Power Interface) on or off. This is an advanced plug & play and power management functionality.	Yes	Enables this function.
		No	Disables this function.
ACPI control	Configuration of specific limits.	Enter	Opens the submenu See "ACPI control", on page 467
Max CPU frequency	This option makes it possible to determine the maximum CPU frequency for Pentium M processors. This option is not shown for Celeron M processors.	MHz processor frequency steps - depending on the processor being used	Determining the frequency. Low heat build-up, therefore low processing power.
Automatic thermal control circuit	This function monitors the CPUs temperature. If the maximum operating temperature of the CPU is exceeded, the performance of the processor is throttled.	Disabled	Disables this function.
		TM1	Operation with 50% load.
		TM2	Operation in accordance with Intel's Geyserville specifications.

Table 269: 855GME (ETX) Main setting options

## Software • BIOS options

BIOS setting	Meaning	Setting options	Effect
Power savings	This function determines if and how the power save function is used.	Disabled	Deactivates the power savings function.
		Customized	Power management is configured by adjusting the individual settings.
		Maximum power Savings	Maximum power savings function.
		Maximum performance	Power savings function to maximize performance.
Standby timeout	Set here when the system should enter standby mode. During standby, various devices and the display will be deactivated. This option only available when "power savings" is set to customized.	Off	No standby.
		1, 2, 4, 8 minutes	Time in minutes until standby.
Auto suspend timeout	Set here when the system should enter suspend mode to save electricity. This option only available when "power savings" is set to customized.	Off	No standby.
		5, 10, 15, 20, 30, 40, 60 Minutes	Time in minutes until standby.
Hard disk timeout	Set here how long after the last access the hard disk should enter standby mode. This option only available when "power savings" is set to customized.	Disabled	Disables this function.
		10, 15, 30, 45 seconds	Time in seconds until standby.
		1, 2, 4, 6, 8, 10, 15 Minutes	Time in minutes until standby.
Video timeout		Disabled	
Resume on modem ring	If an external modem is connected to a serial port and the telephone rings, the system starts up.	Off	Disables this function.
		On	Enables this function.
Resume on time	This function enables the system to start at the time set under "resume time."	Off	Disables this function.
		On	Enables this function.
Resume time	Time setting for the option "resume on time" (when the system should start up).	[00:00:00]	Personal setting of the time in the format (hh:mm:ss).
Power supply	The type of power supply being used can be entered here.	ATX	An ATX compatible power supply is being used.
		AT	An AT compatible power supply is being used.
Power button Function	This option determines the function of the power button.	Power off	Shuts down the system.
		Sleep	The system enters sleep mode.
Power Loss Control	This option determines how the system reacts to a power outage.	Stay off	The system does not turn back on. The system remains off until the power button is pressed.
		Power-on	The system turns back on.
		Last State	The system resumes the last state it was in before the power outage.

Table 269: 855GME (ETX) Main setting options (Forts.)

BIOS setting	Meaning	Setting options	Effect
Enable PME for WOL	This option enables the PME (Power Management Event) signal for controlling the WOL (Wake On LAN) function for the operating system. This setting affects both Ethernet interfaces (ETH1 and ETH2).	OS control	Evaluation of the PME signal is only active if it has been accordingly activated in the operating system driver. The system can only be woken up from the S4: hibernate mode - Suspend-to-Disk status.
		Enabled	The function, WOL and the evaluation of the PME signal is always enabled.
		Disabled	Disables the function - no WOL possible.

Table 269: 855GME (ETX) Main setting options (Forts.)

ACPI control

The screenshot shows the PhoenixBIOS Setup Utility interface. At the top, it says '0BR1 PhoenixBIOS Setup Utility R130'. Below that is a 'Power' menu. The main area is titled 'ACPI Control' and lists several settings:

- Active Trip Point: [Disabled]
- Passive Cooling Trip Point: [90°C]
- Passive TC1 Value: [1]
- Passive TC2 Value: [5]
- Passive TSP Value: [10]
- Critical Trip Point: [110°C]
- APIC - IO APIC Mode: [Disabled]
- Native IDE Support: [Disabled]

On the right side, under 'Item Specific Help', there is a description for the Active Trip Point: 'This value controls the temperature of the ACPI Active Trip Point - the point in which the OS will turn the CPU Fan on.'

At the bottom, there is a navigation bar with the following options:

- F1 Help ↑↓ Select Item -/+ Change Values F9 Setup Defaults
- Esc Exit ← Select Menu Enter Select ► Sub Menu F10 Save and Exit

Figure 228: 855GME (ETX) ACPI Control

BIOS setting	Meaning	Setting options	Effect
Active trip point	With this function, an optional CPU fan above the operating system can be set to turn on when the CPU reaches the set temperature.  <b>Information:</b> This function is not supported by MS-DOS.	Disabled	Disables this function.
		40 to 100°C	Temperature setting for the active trip point. Can be set in increments of 5°C.

Table 270: 855GME (ETX) ACPI Control setting options

Section 4  
Software

## Software • BIOS options

BIOS setting	Meaning	Setting options	Effect
Passive Cooling Trip Point	<p>With this function, a temperature can be set at which the CPU automatically reduces its speed.</p> <p><b>Information:</b> This function is not supported by MS-DOS.</p>	Disabled	Disables this function.
		40 to 100°C	Temperature setting for the passive cooling trip point. Can be set in increments of 5°C.
Passive TC1 Value	Can only be set if a value was defined manually under the item "Passive cooling trip point".	1 .. 16	Can be defined in single steps
Passive TC2 Value	Can only be set if a value was defined manually under the item "Passive cooling trip point".	1 .. 16	Can be defined in single steps
Passive TSP Value	Can only be set if a value was defined manually under the item "Passive cooling trip point".	2 .. 30	Can be defined in double steps
Critical Trip Point	<p>With this function, a temperature can be set at which the operating system automatically shuts itself down.</p> <p><b>Information:</b> This function is not supported by MS-DOS.</p>	40 to 110°C	Temperature setting for the critical trip point. Can be set in increments of 5°C.
APIC - I/O APIC mode	This option controls the functionality of the advanced interrupt controller in the processor.	Disabled	Disables the function
		Enabled	<p>Enables this function.</p> <p>The activation of this option is only effective if it takes place before the operating system (Windows XP) is activated. There are then 23 IRQs available.</p>
Native IDE support	<p>The native IDE support offers the possibility to make 4 hard disk controllers (2 x primary ATA for a total of 4 devices, and 2 x secondary ATA for another 2 devices) accessible through Windows XP.</p> <p><b>Information:</b> This function is not supported by MS-DOS.</p>	Disabled	Disables this function.
		Enabled	Enables this function.

Table 270: 855GME (ETX) ACPI Control setting options (Forts.)

1.2.8 Boot

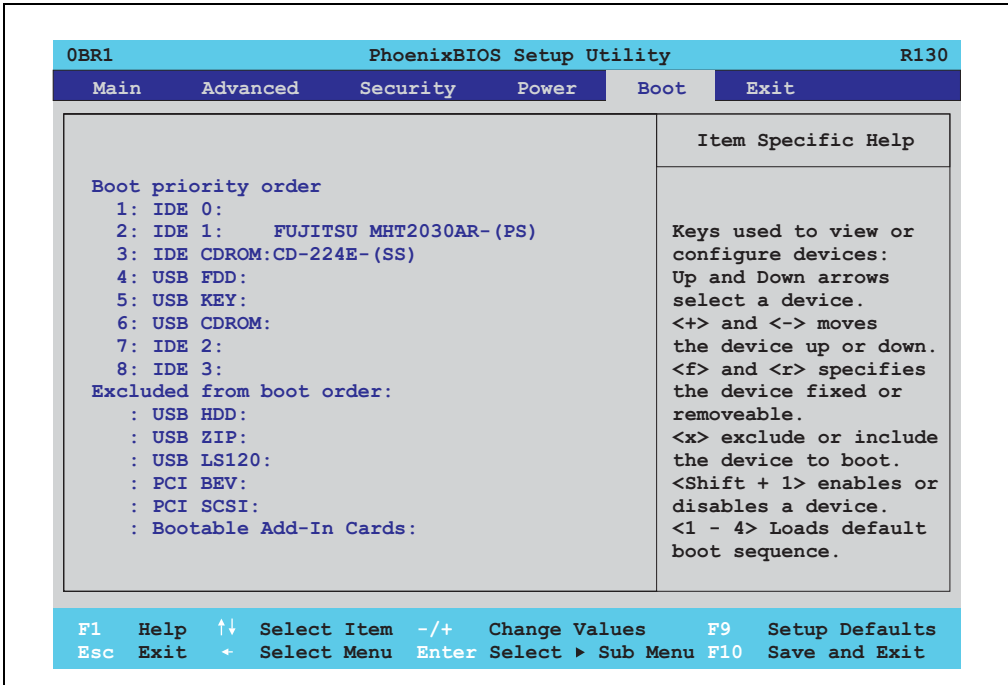

Figure 229: 855GME (ETX) Boot menu

BIOS setting	Meaning	Setting options	Effect
1:		IDE 0, IDE 1,	Use the up arrow ↑ and down arrow ↓, to select a device. Then, use the <+> and <-> keys to change the boot priority of the drive.  To add a device to the "boot priority order" list from the "excluded from boot order" list, use the <x> key. In the same way, the <x> key can move boot devices down out of the boot priority order. The keys 1 - 4 can load preset boot sequences.
2:		IDE 2, IDE 3, IDE CD	
3:		USB FDC, USB KEY	
4:		USB CDROM	
5:		USB HDD, USB ZIP	
6:		USB LS120,	
7:		PCI BEV, PCI SCSI,	
8:		bootable add-in cards	

Table 271: 855GME (ETX) Boot setting options

### 1.2.9 Exit

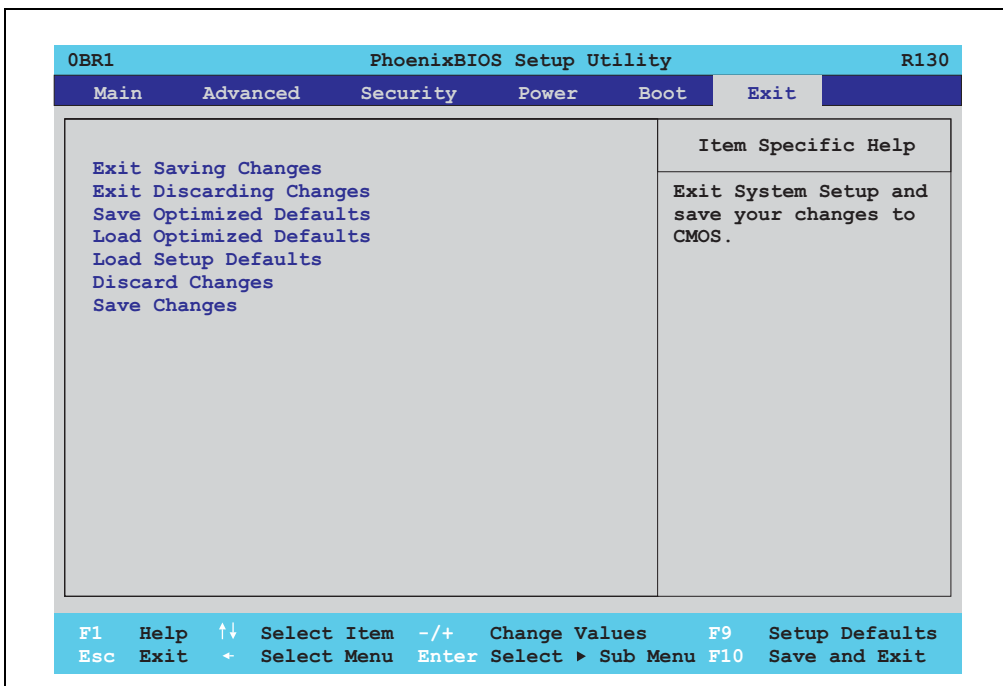

Figure 230: 855GME (ETX) - exit menu

BIOS setting	Meaning	Setting options	Effect
Exit saving changes	BIOS setup is closed with this item. Changes made are saved in CMOS after confirmation, and the system is rebooted.	Yes / No	
Exit discarding changes	With this item you can close BIOS setup without saving the changes made. The system is then rebooted.	Yes / No	
Save optimized defaults	Saves the BIOS values entered by the customer.	Yes / No	
Load optimized defaults	Loads into CMOS the BIOS values saved by the customer.  <b>Information:</b> <b>Only shown if "Save Optimized Defaults" has been executed.</b>	Yes / No	
Load setup defaults	This item loads the BIOS setup defaults, which are defined by the DIP switch settings. These settings are loaded for all BIOS configurations.	Yes / No	

Table 272: 855GME (ETX) - exit menu - setting options

BIOS setting	Meaning	Setting options	Effect
Discard Changes	Should unknown changes have been made and not yet saved, they can be discarded.	Yes / No	
Save changes	Settings are saved, and the system is not restarted.	Yes / No	

Table 272: 855GME (ETX) - exit menu - setting options

### 1.2.10 Profile overview - BIOS default settings - 855GME (ETX)

If the function "load setup defaults" is chosen in the main BIOS setup menu, or if exit is selected (or <F9> is pressed) in the individual setup screens, the following BIOS default settings are the optimized values that will be used.

DIP switch position see Section 1.6 "Location of the DIP switch in APC620 system units", on page 546).

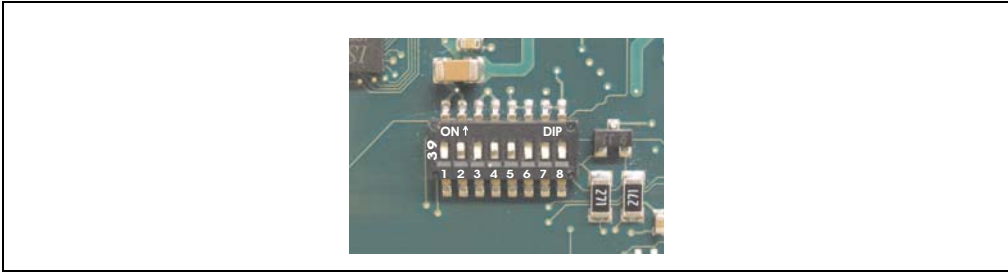

Figure 231: DIP switch on system unit

The first six DIP switches (1-6) are used to set the profiles. The rest (7,8) are reserved.

Number	Optimized for	DIP switch setting							
		1	2	3	4	5	6	7 <sup>1)</sup>	8 <sup>1)</sup>
Profile 0	Automation PC 620 system units 5PC600.SX01-00.	Off	Off	Off	Off	Off	Off	-	-
Profile 1	Reserved	On	Off	Off	Off	Off	Off	-	-
Profile 2	Automation PC 620 system units 5PC600.SX02-00, 5PC600.SX02-01, 5PC600.SF03-00, 5PC600.SX05-00 and 5PC600.SX05-01.	Off	On	Off	Off	Off	Off	-	-
Profile 3	Panel PC 700 system unit 5PC720.1043-00, 5PC720.1214-00, 5PC720.1505-00, 5PC720.1706-00, 5PC720.1906-00, 5PC781.1043-00, 5PC781.1505-00 and 5PC782.1043-00.	On	On	Off	Off	Off	Off	-	-
Profile 4	Panel PC 700 system unit 5PC720.1043-01, 5PC720.1214-01, 5PC720.1505-01 and 5PC720.1505-02.	Off	Off	On	Off	Off	Off	-	-

Table 273: 855GME (XTX) profile overview

1) Reserved.

The following pages provide an overview of the BIOS default settings for the different DIP switch configurations.

#### [Personal settings](#)

If changes have been made to the BIOS defaults, they can be entered in the following tables for backup.



Main

	Profile 0	Profile 1	Profile 2	Profile 3	Profile 4	Personal settings
System Time	-	-	-	-	-	
System Date	-	-	-	-	-	
SMART device monitoring	Enabled	Enabled	Enabled	Enabled	Enabled	
<b>IDE channel 0 master</b>						
Type	Auto	Auto	Auto	Auto	Auto	
Multi-sector transfer	-	-	-	-	-	
LBA mode control	-	-	-	-	-	
32-bit I/O	Disabled	Disabled	Disabled	Disabled	Disabled	
Transfer mode	-	-	-	-	-	
Ultra DMA mode	-	-	-	-	-	
SMART monitoring	Disabled	Disabled	Disabled	Disabled	Disabled	
<b>IDE channel 0 slave</b>						
Type	Auto	Auto	Auto	Auto	Auto	
Multi-sector transfer	-	-	-	-	-	
LBA mode control	-	-	-	-	-	
32-bit I/O	Disabled	Disabled	Disabled	Disabled	Disabled	
Transfer mode	-	-	-	-	-	
Ultra DMA mode	-	-	-	-	-	
SMART monitoring	Disabled	Disabled	Disabled	Disabled	Disabled	
<b>IDE channel 1 master</b>						
Type	Auto	Auto	Auto	Auto	Auto	
Multi-sector transfer	-	-	-	-	-	
LBA mode control	-	-	-	-	-	
32-bit I/O	Disabled	Disabled	Disabled	Disabled	Disabled	
Transfer mode	-	-	-	-	-	
Ultra DMA mode	-	-	-	-	-	
SMART monitoring	Disabled	Disabled	Disabled	Disabled	Disabled	
<b>IDE channel 1 slave</b>						
Type	Auto	Auto	Auto	Auto	Auto	
Multi-sector transfer	-	-	-	-	-	
LBA mode control	-	-	-	-	-	
<b>IDE channel 1 slave</b>						
32-bit I/O	Disabled	Disabled	Disabled	Disabled	Disabled	
Transfer mode	-	-	-	-	-	
Ultra DMA mode	-	-	-	-	-	
SMART monitoring	Disabled	Disabled	Disabled	Disabled	Disabled	

Table 274: 855GME (ETX) - main - profile setting overview

Advanced

[Advanced chipset/graphics control](#)

	Profile 0	Profile 1	Profile 2	Profile 3	Profile 4	Personal settings
Graphics engine 1	Auto	Auto	Auto	Auto	Auto	
Default flat panel	None	None	None	None	None	
Flat panel scaling	Stretched	Stretched	Stretched	Stretched	Stretched	
Graphics engine 2	Auto	Auto	Auto	Auto	Auto	
Graphics engine	Graphics engine 1	Graphics engine 1	Graphics engine 1	Graphics engine 1	Graphics engine 1	
Graphics memory size	UMA = 8 MB	UMA = 8 MB	UMA = 8 MB	UMA = 8 MB	UMA = 8 MB	
Assign IRQ to VGA	Enabled	Enabled	Enabled	Enabled	Enabled	
Internal graphics API Rev	-	-	-	-	-	

Table 275: 855GME (ETX) - advanced chipset/graphics control - profile settings overview

[PCI/PNP Configuration](#)

	Profile 0	Profile 1	Profile 2	Profile 3	Profile 4	Personal settings
PNP OS installed	Yes	No	Yes	Yes	Yes	
Reset configuration data	No	No	No	No	No	
Secured setup configuration	Yes	Yes	Yes	Yes	Yes	
PCI IRQ line 1	Auto-select	Auto-select	Auto-select	Auto-select	Auto-select	
PCI IRQ line 2	Auto-select	Auto-select	Auto-select	Auto-select	Auto-select	
PCI IRQ line 3	Auto-select	Auto-select	Auto-select	Auto-select	Auto-select	
PCI IRQ line 4	Auto-select	Auto-select	Auto-select	Auto-select	Auto-select	
Onboard LAN IRQ line	Auto-select	Auto-select	Auto-select	Auto-select	Auto-select	
Onboard USB EHCI IRQ line	Auto-select	Auto-select	Auto-select	Auto-select	Auto-select	
Default primary video adapter	PCI	PCI	PCI	PCI	PCI	
Assign IRQ to SMB	Enabled	Enabled	Enabled	Enabled	Enabled	

PCI device, slot #1	Profile 0	Profile 1	Profile 2	Profile 3	Profile 4	Personal settings
ROM scan option	Enabled	Enabled	Enabled	Enabled	Enabled	
Enable master	Enabled	Enabled	Enabled	Enabled	Enabled	
Latency timer	Default	Default	Default	Default	Default	
PCI device, slot #2						
ROM scan option	Enabled	Enabled	Enabled	Enabled	Enabled	
Enable master	Enabled	Enabled	Enabled	Enabled	Enabled	

Table 276: 855GME (ETX) PCI/PNP Configuration Profile settings overview

Latency timer	Default	Default	Default	Default	Default	
<b>PCI device, slot #3</b>						
ROM scan option	Enabled	Enabled	Enabled	Enabled	Enabled	
Enable master	Enabled	Enabled	Enabled	Enabled	Enabled	
Latency timer	Default	Default	Default	Default	Default	
<b>PCI device, slot #4</b>						
ROM scan option	Enabled	Enabled	Enabled	Enabled	Enabled	
Enable master	Enabled	Enabled	Enabled	Enabled	Enabled	
Latency timer	Default	Default	Default	Default	Default	

Table 276: 855GME (ETX) PCI/PNP Configuration Profile settings overview (Forts.)

[Memory cache](#)

	Profile 0	Profile 1	Profile 2	Profile 3	Profile 4	Personal settings
Memory cache	Enabled	Enabled	Enabled	Enabled	Enabled	
Cache system BIOS area	Write protect	Write protect	Write protect	Write protect	Write protect	
Cache video BIOS area	Write protect	Write protect	Write protect	Write protect	Write protect	
Cache base 0-512k	Write back	Write back	Write back	Write back	Write back	
Cache base 512-640k	Write back	Write back	Write back	Write back	Write back	
Cache extended memory area	Write back	Write back	Write back	Write back	Write back	
Cache D000 - D3FF	Disabled	Disabled	Disabled	Disabled	Disabled	
Cache D400 - D7FF	Disabled	Disabled	Disabled	Disabled	Disabled	
Cache D800 - DBFF	Disabled	Disabled	Disabled	Disabled	Disabled	
Cache DC00 - DFFF	Disabled	Disabled	Disabled	Disabled	Disabled	
Cache E000 - E3FF	Disabled	Disabled	Disabled	Disabled	Disabled	
Cache E400 - E7FF	Disabled	Disabled	Disabled	Disabled	Disabled	

Table 277: 855GME (ETX) - memory cache - profile settings overview

[I/O Device Configuration](#)

	Profile 0	Profile 1	Profile 2	Profile 3	Profile 4	Personal settings
Local bus IDE adapter	Primary	Both	Both	Primary	Both	
Primary IDE UDMA66/100	Enabled	Enabled	Enabled	Enabled	Enabled	
Secondary IDE UDMA66/100	Enabled	Enabled	Enabled	Enabled	Enabled	
USB UHCI host controller 1	Enabled	Enabled	Enabled	Enabled	Enabled	
USB UHCI host controller 2	Enabled	Enabled	Enabled	Enabled	Enabled	
USB UHCI host controller	Enabled	Enabled	Enabled	Enabled	Enabled	
Legacy USB Support	Enabled	Enabled	Enabled	Enabled	Enabled	
AC97 audio controller	Enabled	Enabled	Enabled	Enabled	Enabled	
Onboard LAN controller	Enabled	Enabled	Enabled	Enabled	Enabled	
Onboard LAN PXE ROM	Disabled	Enabled	Disabled	Disabled	Disabled	
Serial port A	Enabled	Enabled	Enabled	Enabled	Enabled	
Base I/O address	3F8	3F8	3F8	3F8	3F8	
Interrupt	IRQ 4	IRQ 4	IRQ 4	IRQ 4	IRQ 4	
Serial port B	Enabled	Enabled	Enabled	Enabled	Enabled	
Mode	Normal	Normal	Normal	Normal	Normal	
Base I/O address	2F8	2F8	2F8	2F8	2F8	
Interrupt	IRQ 3	IRQ 3	IRQ 3	IRQ 3	IRQ 3	
Parallel port	Enabled	Enabled	Enabled	Enabled	Enabled	
Base I/O address	378	378	378	378	378	

Table 278: 855GME (ETX) I/O Device Configuration Profile settings overview

[Keyboard features](#)

	Profile 0	Profile 1	Profile 2	Profile 3	Profile 4	Personal settings
NumLock	On	On	On	On	On	
Key click	Disabled	Disabled	Disabled	Disabled	Disabled	
Keyboard auto-repeat rate	30/sec	30/sec	30/sec	30/sec	30/sec	
Keyboard auto-repeat delay	1/2 sec	1/2 sec	1/2 sec	1/2 sec	1/2 sec	

Table 279: 855GME (ETX) - keyboard features - profile setting overview

[CPU board monitor](#)

	Profile 0	Profile 1	Profile 2	Profile 3	Profile 4	Personal settings
VCC 3.3V voltage	-	-	-	-	-	
CPU core voltage	-	-	-	-	-	
5Vsb voltage	-	-	-	-	-	
Battery voltage	-	-	-	-	-	
CPU temperature	-	-	-	-	-	

Table 280: 855GME (ETX) - CPU board monitor - profile setting overview

[Miscellaneous](#)

	Profile 0	Profile 1	Profile 2	Profile 3	Profile 4	Personal settings
Summary screen	Enabled	Enabled	Enabled	Enabled	Enabled	
QuickBoot mode	Enabled	Enabled	Enabled	Enabled	Enabled	
Extended memory testing	Just zero it	Just zero it	Just zero it	Just zero it	Just zero it	
Dark boot	Disabled	Disabled	Disabled	Disabled	Disabled	
Halt on errors	Yes	Yes	Yes	Yes	Yes	
PS/2 mouse	Disabled	Enabled	Disabled	Disabled	Disabled	
Large disk access mode	DOS	DOS	DOS	DOS	DOS	

Table 281: 855GME (ETX) - miscellaneous - profile setting overview

[Main Board/Panel Features](#)

	Profile 0	Profile 1	Profile 2	Profile 3	Profile 4	Personal settings
Versions	-	-	-	-	-	
BIOS	-	-	-	-	-	
MTCX	-	-	-	-	-	
FPGA	-	-	-	-	-	
Optimized ID	-	-	-	-	-	
Device ID	-	-	-	-	-	
Compatibility ID	-	-	-	-	-	
Serial Number	-	-	-	-	-	
Product name	-	-	-	-	-	
User serial ID	-	-	-	-	-	
<b>Panel control</b>						
Select panel number	0	0	0	0	0	
Version	-	-	-	-	-	
Brightness	100%	100%	100%	100%	100%	

Table 282: 855GME (ETX) Baseboard/Panel Features profile settings overview

## Software • BIOS options

Panel control	Profile 0	Profile 1	Profile 2	Profile 3	Profile 4	Personal settings
Temperature	-	-	-	-	-	
Fan speed	-	-	-	-	-	
Keys/LEDs	-	-	-	-	-	
<b>Main board monitor</b>						
CMOS battery	-	-	-	-	-	
Temperatures	-	-	-	-	-	
I/O	-	-	-	-	-	
Power supply	-	-	-	-	-	
Slide-in drive 1	-	-	-	-	-	
Slide-in drive 2	-	-	-	-	-	
Fan speeds	-	-	-	-	-	
Case 1	-	-	-	-	-	
Case 2	-	-	-	-	-	
Case 3	-	-	-	-	-	
Case 4	-	-	-	-	-	
CPU	-	-	-	-	-	
<b>Legacy devices</b>						
COM C	Disabled	Enabled	Disabled	Enabled	Enabled	
Base I/O address	-	3E8h	-	3E8h	3E8h	
Interrupt	-	11	-	11	11	
COM D	Disabled	Disabled	Disabled	Disabled	Disabled	
Base I/O address	-	-	-	-	-	
Interrupt	-	-	-	-	-	
COM E	Disabled	Disabled	Disabled	Disabled	Disabled	
Base I/O address	-	-	-	-	-	
Interrupt	-	-	-	-	-	
LPT	Disabled	Disabled	Disabled	Disabled	Disabled	
Base I/O address	-	-	-	-	-	
CAN	Disabled	Disabled	Disabled	Disabled	Disabled	
Base I/O address	-	-	-	-	-	
Interrupt	-	-	-	-	-	
2nd LAN controller	Enabled	Enabled	Enabled	Enabled	Enabled	
LAN1 MAC address	-	-	-	-	-	
LAN2 MAC address	-	-	-	-	-	

Table 282: 855GME (ETX) Baseboard/Panel Features profile settings overview (Forts.)

## Security

	Profile 0	Profile 1	Profile 2	Profile 3	Profile 4	Personal settings
Supervisor password is	Clear	Clear	Clear	Clear	Clear	
User password is	Clear	Clear	Clear	Clear	Clear	
Set supervisor password	-	-	-	-	-	
Set user password	-	-	-	-	-	
Diskette access	Supervisor	Supervisor	Supervisor	Supervisor	Supervisor	
Fixed disk boot sector	Normal	Normal	Normal	Normal	Normal	
Virus check reminder	Disabled	Disabled	Disabled	Disabled	Disabled	
System backup reminder	Disabled	Disabled	Disabled	Disabled	Disabled	
Password at boot	Disabled	Disabled	Disabled	Disabled	Disabled	

Table 283: 855GME (ETX) Security profile settings overview

## Power

	Profile 0	Profile 1	Profile 2	Profile 3	Profile 4	Personal settings
Enable ACPI	Yes	Yes	Yes	Yes	Yes	
Max CPU frequency	Dependant on processor	Dependant on processor	Dependant on processor	Dependant on processor	Dependant on processor	
Automatic thermal control circuit	TM2	TM2	TM2	TM2	TM2	
Power savings	Disabled	Disabled	Disabled	Disabled	Disabled	
Standby timeout	-	-	-	-	-	
Auto suspend timeout	-	-	-	-	-	
Hard disk timeout	Disabled	Disabled	Disabled	Disabled	Disabled	
Video timeout	Disabled	Disabled	Disabled	Disabled	Disabled	
Resume on modem ring	Off	Off	Off	Off	Off	
Resume on time	Off	Off	Off	Off	Off	
Resume time	0:00:00	0:00:00	0:00:00	0:00:00	0:00:00	
Power supply	ATX	ATX	ATX	ATX	ATX	
Power button function	Power off	Power off	Power off	Power off	Power off	
Power Loss Control	Power-on	Power-on	Power-on	Power-on	Power-on	
Enable PME for WOL	OS control	OS control	OS control	OS control	OS control	
<b>ACPI control</b>						
Active trip point	Disabled	Disabled	Disabled	Disabled	Disabled	
Passive Cooling Trip Point	Disabled	Disabled	Disabled	Disabled	Disabled	
Critical Trip Point	110°C	110°C	110°C	110°C	110°C	
APIC - I/O APIC mode	Disabled	Enabled	Disabled	Disabled	Disabled	
Native IDE support	Disabled	Disabled	Disabled	Disabled	Disabled	

Table 284: 855GME (ETX) - power - profile setting overview

Boot

	Profile 0	Profile 1	Profile 2	Profile 3	Profile 4	Personal settings
Boot priority order						
1:	IDE 0	PCI BEV	IDE 0	IDE 0	IDE 0	
2:	IDE 1	IDE 0	IDE 1	IDE 1	IDE 1	
3:	IDE CD	IDE 1	IDE CD	IDE CD	IDE CD	
4:	USB FDD	IDE CD	USB FDD	USB FDD	USB FDD	
5:	USB KEY	USB FDD	USB KEY	USB KEY	USB KEY	
6:	USB CDROM	USB KEY	USB CDROM	USB CDROM	USB CDROM	
7:	-	USB CDROM	IDE 2	-	IDE 2	
8:	-	-	IDE 3	-	IDE 3	
Excluded from boot order						
:	IDE 2	IDE 2	USB HDD	IDE 2	USB HDD	
:	IDE 3	IDE 3	USB ZIP	IDE 3	USB ZIP	
:	USB HDD	USB HDD	USB LS120	USB HDD	USB LS120	
:	USB ZIP	USB ZIP	PCI BEV	USB ZIP	PCI BEV	
:	USB LS120	USB LS120	PCI SCSI	USB LS120	PCI SCSI	
:	PCI BEV	PCI SCSI	Bootable add-in cards	PCI BEV	Bootable add-in cards	
:	PCI SCSI	Bootable add-in cards	-	PCI SCSI		
:	Bootable add-in cards		-	Bootable add-in cards		

Table 285: 855GME (ETX) - boot - profile setting overview



## 1.3 855GME (XTX) BIOS description

### Information:

- The following diagrams and BIOS menu items including descriptions refer to BIOS version 1.16. It is therefore possible that these diagrams and BIOS descriptions do not correspond with the installed BIOS version.
- The setup defaults are the settings recommended by B&R. The setup defaults are dependant on the DIP switch configuration on the baseboard (see section 1.3.10 "Profile overview - BIOS default settings - 855GME (XTX)", on page 527).

#### 1.3.1 General information

BIOS stands for "Basic Input Output System". It is the most basic standardized communication between the user and the system (hardware). The BIOS system used in the Automation PC 620 systems is produced by American Megatrends Inc.

The BIOS Setup Utility lets you modify basic system configuration settings. These settings are stored in CMOS and in EEPROM (as a backup).

The CMOS data is buffered by a battery, and remains in the APC620 even when the power is turned off (no 24VDC supply).

#### 1.3.2 BIOS setup and boot procedure

BIOS is immediately activated when switching on the power supply of the Automation PC 620 system or pressing the power button. The system checks if the setup data from the EEPROM is "OK". If the data is "OK", then it is transferred to the CMOS. If the data is "not OK", then the CMOS data is checked for validity. An error message is output if the CMOS data contains errors and the boot procedure can be continued by pressing the <F1> key. To prevent the error message from appearing at each restart, open the BIOS setup by pressing the <Del> key and re-save the settings.

BIOS reads the system configuration information in CMOS RAM, checks the system, and configures it using the Power On Self Test (POST).

When these "preliminaries" are finished, BIOS seeks an operating system in the data storage devices available (hard drive, floppy drive, etc.). BIOS launches the operating system and hands over control of system operations to it.

To enter BIOS Setup, the DEL key must be pressed as soon as the following message appears on the monitor (during POST):

"Press DEL to run SETUP"

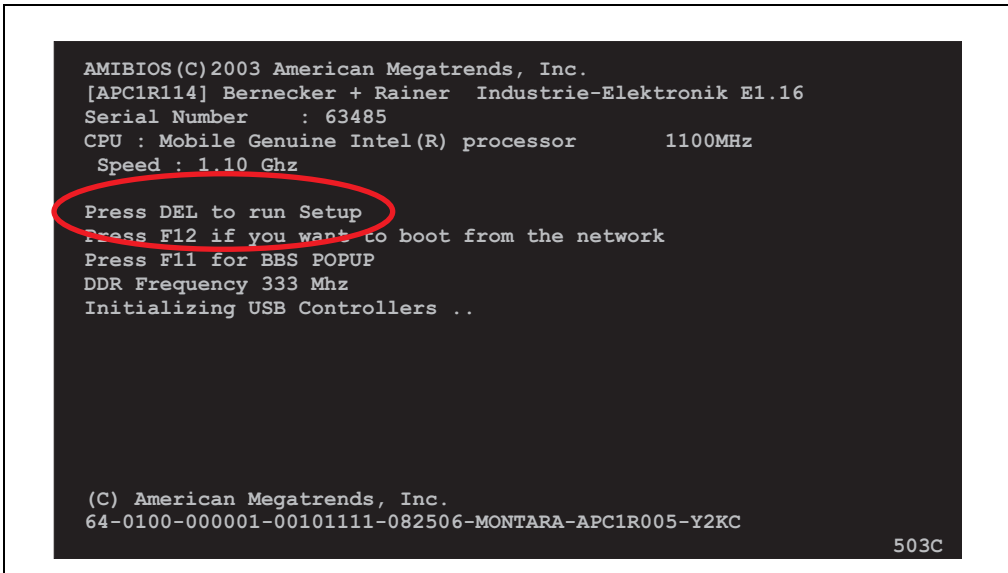

Figure 232: 855GME (XTX) - BIOS diagnostics screen

### 1.3.3 BIOS setup keys

The following keys are enabled during the POST:

Key	Function
ESC	The system RAM check can be skipped by pressing ESC.
Del	Enters the BIOS setup menu.
F12	Using the F12 key, you can boot from the network.
F11	Cues the boot menu. Lists all bootable devices that are connected to the system. With cursor ↑ and cursor ↓ and by pressing <ENTER>, select the device from which will be booted.
<Pause>	Pressing the <pause> key stops the POST. Press any other key to resume the POST.

Table 286: 855GME (XTX) - keys relevant to BIOS during POST

The following keys can be used after entering the BIOS setup:

Key	Function
F1	General help
Cursor ↑	Moves to the previous item.
Cursor ↓	Go to the next item.
Cursor ←	Moves to the previous item.
Cursor →	Go to the next item.
+ -	Changes the setting of the selected function.

Table 287: 855GME (XTX) keys relevant to BIOS in the BIOS menu

Key	Function
Enter	Changes to the selected menu.
PageUp ↑	Change to the previous page.
PageDown ↓	Change to the previous page.
Pos 1	Jumps to the first BIOS menu item or object.
End	Jumps to the last BIOS menu item or object.
F2 / F3	The colors of the BIOS Setup are switched.
F7	Changes are reset.
F9	These settings are loaded for all BIOS configurations.
F10	Save and close.
Esc	Exits the submenu.

Table 287: 855GME (XTX) keys relevant to BIOS in the BIOS menu (Forts.)

The following sections explain the individual BIOS main menu items in detail.

BIOS setup menu item	Function	From page
Main	You can configure the ground configuration time and date in this menu.	484
Advanced	Advanced BIOS options such as cache areas, PnP, keyboard repeat rate, as well as settings specific to B&R integrated hardware, can be configured here.	485
Boot	The boot order can be set here.	518
Security	For setting up the system's security functions.	520
Power	Setup of various APM (Advanced Power Management) options.	523
Exit	To end the BIOS setup.	525

Table 288: Overview of 855GME (XTX) BIOS menu items

### 1.3.4 Main

Immediately after the DEL button is pressed during startup, the main BIOS setup menu appears.

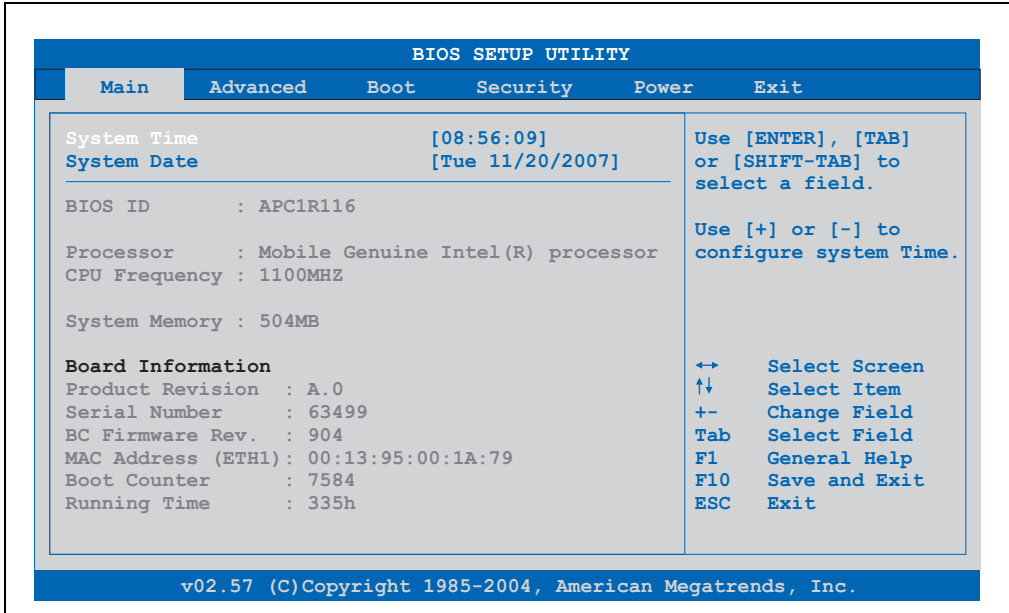

Figure 233: 855GME (XTX) BIOS Main menu

BIOS setting	Meaning	Setting options	Effect
System Time	This is the current system time setting. The time is buffered by a battery (CMOS battery) after the system has been switched off.	Changes the System time	Set the system time in the format (hh:mm:ss).
System Date	This is the current system date setting. The time is buffered by a battery (CMOS battery) after the system has been switched off.	Changes the system date	Set the system date in the format (mm:dd:yyyy).
BIOS ID	Displays the BIOS recognition.	None	-
Processor	Processor display.	None	-
CPU Frequency	CPU frequency display.	None	-
System Memory	System memory display.	None	-
Product Revision	Displays the CPU board HW revision.	None	-
Serial Number	Displays the CPU board serial number.	None	-
BC Firmware Rev.	Displays the CPU board controller firmware revision.	None	-
MAC Address (ETH1)	Displays the assigned MAC address.	None	-

Table 289: 855GME (XTX) Main menu setting options

BIOS setting	Meaning	Setting options	Effect
Boot Counter	Boot counter display.	None	-
Running Time	Runtime display.	None	-

Table 289: 855GME (XTX) Main menu setting options (Forts.)

### 1.3.5 Advanced

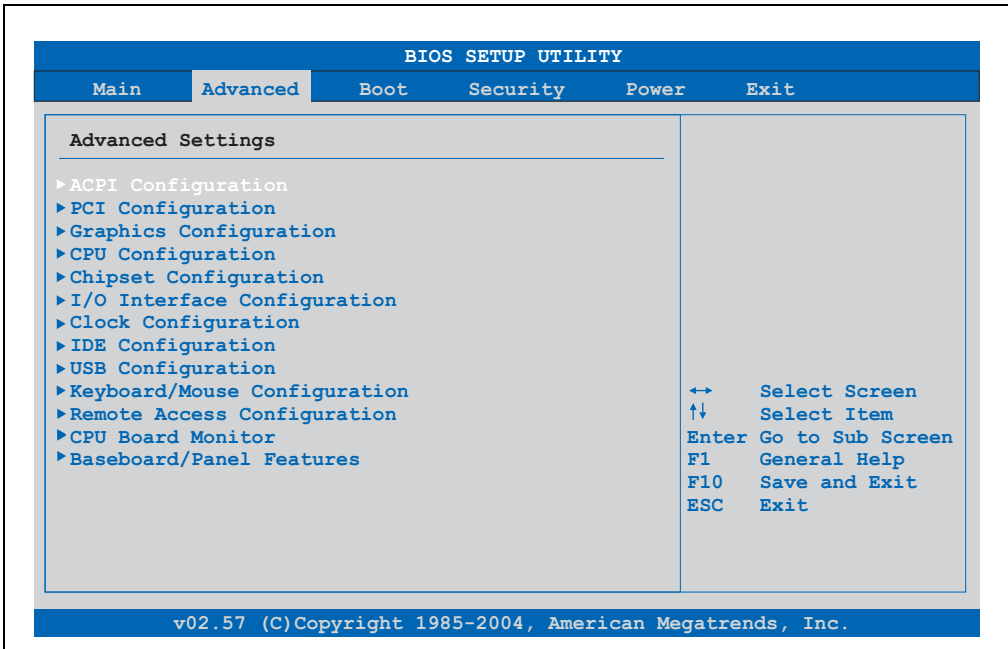

Figure 234: 855GME (XTX) Advanced menu

BIOS setting	Meaning	Setting options	Effect
ACPI configuration	Configures the ACPI devices.	Enter	Opens the submenu See "ACPI configuration", on page 486
PCI Configuration	Configures PCI devices.	Enter	Opens the submenu See "PCI Configuration", on page 488
Graphics configuration	Configures the graphics settings.	Enter	Opens the submenu See "Graphics configuration", on page 490
CPU configuration	Configures the CPU settings.	Enter	Opens the submenu See "CPU configuration", on page 492
Chipset configuration	Configures the chipset functions.	Enter	Opens the submenu See "Chipset configuration", on page 493
I/O interface configuration	Configures the I/O devices.	Enter	Opens the submenu See "I/O interface configuration", on page 494

Table 290: 855GME (XTX) Advanced menu setting options

## Software • BIOS options

BIOS setting	Meaning	Setting options	Effect
<b>Clock Configuration</b>	Configures the clock settings.	Enter	Opens the submenu See "Clock Configuration", on page 496
<b>IDE Configuration</b>	Configures the IDE functions.	Enter	Opens the submenu See "IDE Configuration", on page 497
<b>USB configuration</b>	Configures USB settings	Enter	Opens the submenu See "USB configuration", on page 504
<b>Keyboard/mouse configuration</b>	Configures the keyboard/mouse options.	Enter	Opens the submenu See "Keyboard/mouse configuration", on page 508
<b>Remote access configuration</b>	Configures the remote access settings	Enter	Opens the submenu See "Remote access configuration", on page 509
<b>CPU board monitor</b>	Displays the current voltages and temperature of the processor in use.	Enter	Opens the submenu See "CPU board monitor", on page 511
<b>Main Board/Panel Features</b>	Displays device specific information and setup of device specific values.	Enter	Opens the submenu See "Main Board/Panel Features", on page 512

Table 290: 855GME (XTX) Advanced menu setting options (Forts.)

## ACPI configuration

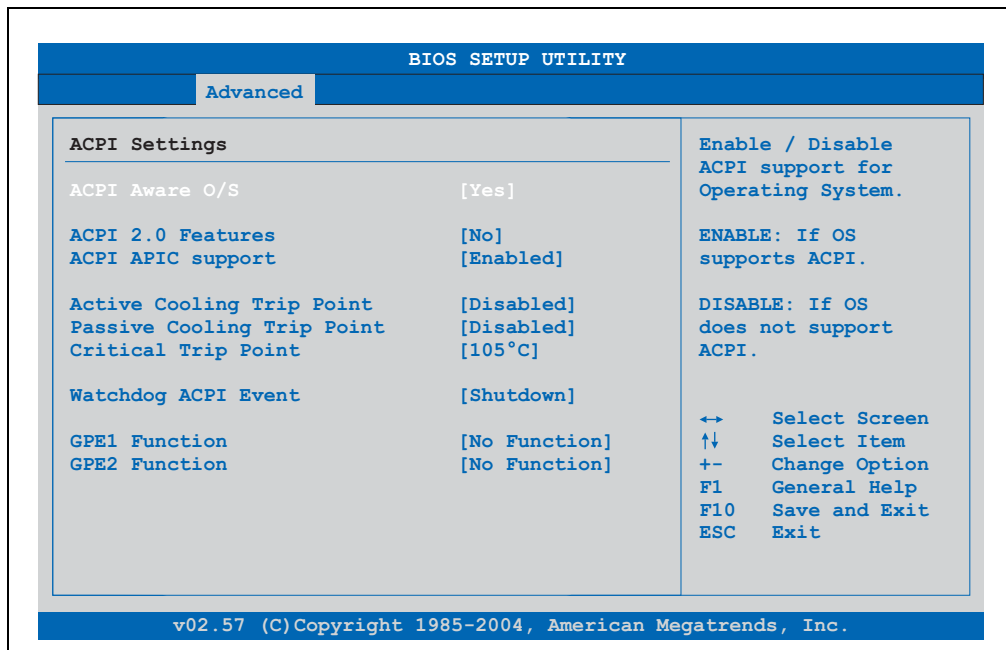

Figure 235: 855GME (XTX) Advanced ACPI Configuration

BIOS setting	Meaning	Setting options	Effect
ACPI Aware O/S	This function determines if the operating system supports the ACPI function (Advanced Configuration and Power Interface).	Yes	The operating system supports ACPI.
		No	The operating system does not support ACPI.
ACPI 2.0 features	This function determines if the operating system supports the ACPI 2.0 specifications.	Yes	The operating system supports ACPI 2.0.
		No	The operating system does not support ACPI 2.0.
ACPI APIC support	This option controls the support of the advanced programmable interrupt controller in the processor.	Enabled	Enables this function.
		Disabled	Disables the function
Active Cooling Trip Point	With this function, an optional CPU fan above the operating system can be set to turn on when the CPU reaches the set temperature.	Disabled	Disables this function.
		50°C, 60°C, 70°C, 80°C, 90°C	Temperature setting for the active trip point. Can be set in increments of 10°C.
Passive Cooling Trip Point	With this function, a temperature can be set at which the CPU automatically reduces its speed.	Disabled	Disables this function.
		50°C, 60°C, 70°C, 80°C, 90°C	Temperature setting for the active trip point. Can be set in increments of 10°C.
Critical Trip Point	With this function, a temperature can be set at which the system automatically shuts itself down.	80°C, 85°C, 90°C, 95°C, 100°C, 105°C, 110°C	Temperature setting for the critical trip point. Can be set in increments of 5°C.
Watchdog ACPI event	System monitoring of the ACPI function.	Shutdown	The system is shut down.
		Restart	Restarts the system.
GPE1 function	Setting the GPE1 function.	No function	Not used.
		Lid switch	-
GPE2 function	Setting the GPE2 function.	No function	Not used.
		Sleep button	-

Table 291: 855GME (XTX) Advanced ACPI Configuration setting options

PCI Configuration

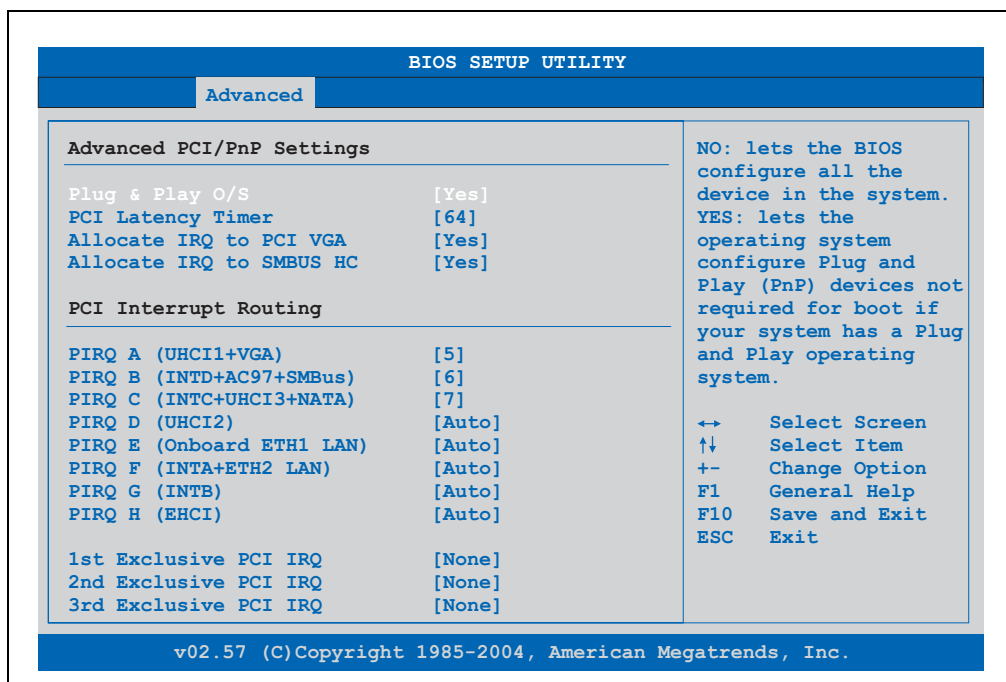

Figure 236: 855GME (XTX) Advanced PCI Configuration

BIOS setting	Meaning	Setting options	Effect
Plug & Play O/S	BIOS is informed if Plug & Play is capable on the operating system.	Yes	The operating system handles the distribution of resources.
		No	BIOS handles the distribution of resources.
PCI Latency Timer	This option controls how long one card can continue to use the PCI bus master after another PCI card has requested access.	32, 64, 96, 128, 160, 192, 224, 248	Value set manually.
Allocate IRQ to PCI VGA	This function is used to determine if an interrupt is assigned to the PCI VGA.	Yes	Automatic assignment of an interrupt.
		No	No assignment of an interrupt.
Allocate IRQ to SMBUS HC	Use this function to set whether or not the SM (System Management) bus controller is assigned a PCI interrupt.	Yes	Automatic assignment of a PCI interrupt.
		No	No assignment of an interrupt.
PIRQ A (UHCI1+VGA)	Under this option, the external PCI interrupt A is assigned to an ISA interrupt.	Auto	The interrupt is automatically assigned according to Plug & Play guidelines.
		5, 6, 7, 8, 9, 10, 11, 12	Manual configuration of the IRQ.
PIRQ B (INTD+AC97+SMBus)	Under this option, the external PCI interrupt B is assigned to and ISA interrupt.	Auto	The interrupt is automatically assigned according to Plug & Play guidelines.
		5, 6, 7, 8, 9, 10, 11, 12	Manual configuration of the IRQ.

Table 292: 855GME (XTX) Advanced PCI Configuration setting options



BIOS setting	Meaning	Setting options	Effect
PIRQ C (INTC+UHCI3+NAT A)	Under this option, the external PCI interrupt C is assigned to and ISA interrupt.	Auto	The interrupt is automatically assigned according to Plug & Play guidelines.
		5, 6, 7, 8, 9, 10, 11, 12	Manual configuration of the IRQ.
PIRQ D (UHCI2)	Under this option, the external PCI interrupt D is assigned to and ISA interrupt.	Auto	The interrupt is automatically assigned according to Plug & Play guidelines.
		5, 6, 7, 8, 9, 10, 11, 12	Manual configuration of the IRQ.
PIRQ E (Onboard ETH1 LAN)	Under this option, the external PCI interrupt E is assigned to an ISA interrupt.	Auto	The interrupt is automatically assigned according to Plug & Play guidelines.
		5, 6, 7, 8, 9, 10, 11, 12	Manual configuration of the IRQ.
PIRQ F (INTA+ETH2 LAN)	Under this option, the external PCI interrupt F is assigned to an ISA interrupt.	Auto	The interrupt is automatically assigned according to Plug & Play guidelines.
		5, 6, 7, 8, 9, 10, 11, 12	Manual configuration of the IRQ.
PIRQ G (INTB)	Under this option, the external PCI interrupt G is assigned to an ISA interrupt.	Auto	The interrupt is automatically assigned according to Plug & Play guidelines.
		5, 6, 7, 8, 9, 10, 11, 12	Manual configuration of the IRQ.
PIRQ H (EHC1)	Under this option, the external PCI interrupt H is assigned to an ISA interrupt.	Auto	The interrupt is automatically assigned according to Plug & Play guidelines.
		5, 6, 7, 8, 9, 10, 11, 12	Manual configuration of the IRQ.
1st exclusive PCI IRQ	With this option you can determine if the IRQ assigned to the PIRQ x is handled exclusively (no IRQ sharing).  <b>Information:</b> Is only displayed if a PIRQ is manually set (e.g. 5).	None	No interrupt is assigned.
		x	Assigns the PIRQ as 1st exclusive PCI IRQ.
2nd exclusive PCI IRQ	With this option you can determine if the IRQ assigned to the PIRQ x is handled exclusively (no IRQ sharing).  <b>Information:</b> Only displayed when two PIRQs are set manually.	None	No interrupt is assigned.
		x	Assigns the PIRQ as 2nd exclusive PCI IRQ.
3rd exclusive PCI IRQ	With this option you can determine if the IRQ assigned to the PIRQ x is handled exclusively (no IRQ sharing).  <b>Information:</b> Only displayed in connection with "Profile 5" and if three PIRQs are set manually.	None	No interrupt is assigned.
		x	Assigns the PIRQ as 3rd exclusive PCI IRQ.

Table 292: 855GME (XTX) Advanced PCI Configuration setting options (Forts.)

Graphics configuration

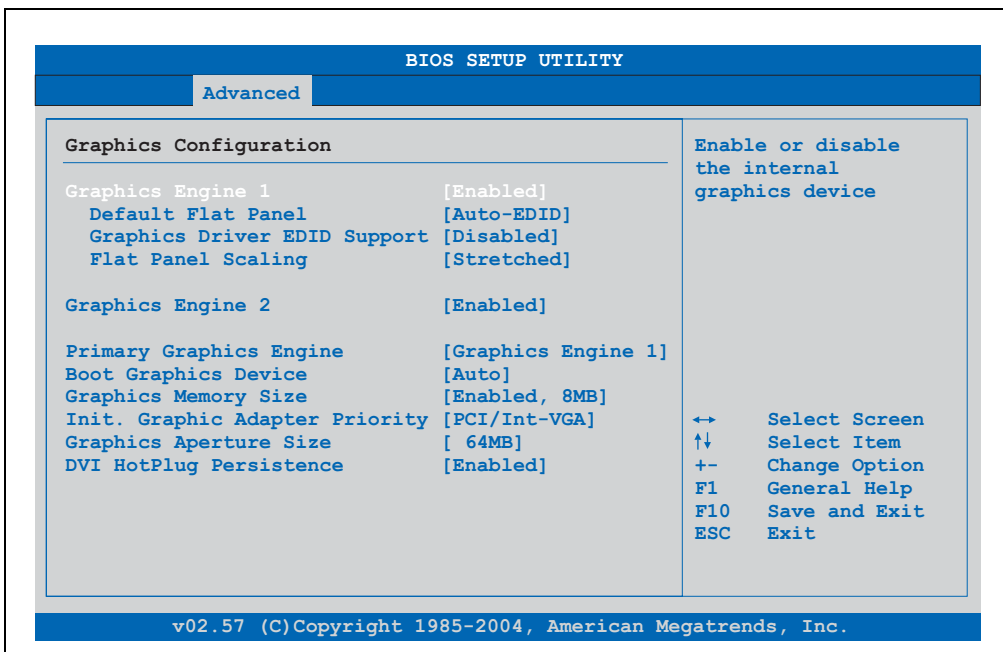

Figure 237: 855GME (XTX) Advanced Graphics Configuration

BIOS setting	Meaning	Setting options	Effect
Graphics engine 1	The onboard graphics controller 1 is activated/deactivated here.	Enabled	Enables this function.
		Disabled	Disables this function.
Default flat panel	Settings can be made for the resolution.	Auto-EDID	Automatic setting of the resolution (using a read-out of the connected panel's EDID data).
		VGA 1x18 (002h) VGA 1x18 (013h) SVGA 1x18 (004h) XGA 1x18 (006h) XGA 2x18 (007h) XGA 1x24 (008h) XGA 2x24 (012h) SXGA 2x24 (00Ah) UXGA 2x24 (00Ch)	VGA = 640 x 480 resolution SVGA = 800 x 600 resolution XGA = 1024 x 768 resolution SXGA = 1280 x 1024 resolution UXGA = 1600 x 1200 resolution
		Customized EDID 1	Graphics card reads the EDID 1 data.
		Customized EDID 2	Graphics card reads the EDID 2 data.
		Customized EDID 3	Graphics card reads the EDID 3 data.
Graphics driver EDID support	If this function is enabled, the following operating system graphics driver can read EDID data on its own. When disabled, the VGA data is taken over by BIOS.	Enabled	Enables this function.
		Disabled	Disables this function.

Table 293: 855GME (XTX) Advanced Graphics Configuration setting options

BIOS setting	Meaning	Setting options	Effect
Flat panel scaling	The screen optimization of the flat screen is determined here.	Centered	Screen output centered.
		Stretched	Screen output adjusted.
Graphics engine 2	Settings can be made for the onboard graphics controller 2.	Enabled	Enables this function.
		Disabled	Disables this function.
Graphics engine	The primary onboard graphics controller can be selected here.	Graphics engine 1	Activation of graphics engine 1
		Graphics engine 2	Activation of graphics engine 2
Boot graphics device	You can select which display mode should be booted here.	Auto	Display mode selected automatically.
		CRT only	Only CRT is booted.
		Engine 2 only	Only engine 2 is booted.
		CRT + Engine 2	CRT and engine 2 are booted.
		Engine 1 only	Only engine 1 is booted.
		CRT + Engine 1	CRT and engine 1 are booted.
Graphics memory size	Reserves a memory location in the RAM for the onboard graphics controller, into which the memory access will be directed.	Enabled, 1MB	1 MB main memory is reserved for the onboard video controller. Controller reserved.
		Enabled, 4MB	4 MB main memory is reserved for the onboard video controller. Controller reserved.
		Enabled, 8MB	8 MB main memory is reserved for the onboard video controller. Controller reserved.
		Enabled, 16MB	16 MB main memory is reserved for the onboard video controller.
		Enabled, 32MB	32 MB main memory is reserved for the onboard video controller.
Init. Graphic adapter priority	This option allows you to set which graphics card should be initialized first.	PCI/Int-VGA	PCI/Int-VGA adapter is first installed.
		Internal VGA	Internal VGA adapter is first installed.
Graphics aperture size	Reserves a memory location in the RAM for the graphics card.  <b>Information:</b> <b>The size with the best performance is the same size as the working memory.</b>	64MB, 128MB, 256MB	Value set manually.
DVI HotPlug persistence	Affects both graphics engines. When enabled, the operating system graphics driver attempts to restore the most recent configuration.	Enabled	Enables this function.
		Disabled	Disables this function.

Table 293: 855GME (XTX) Advanced Graphics Configuration setting options (Forts.)

CPU configuration

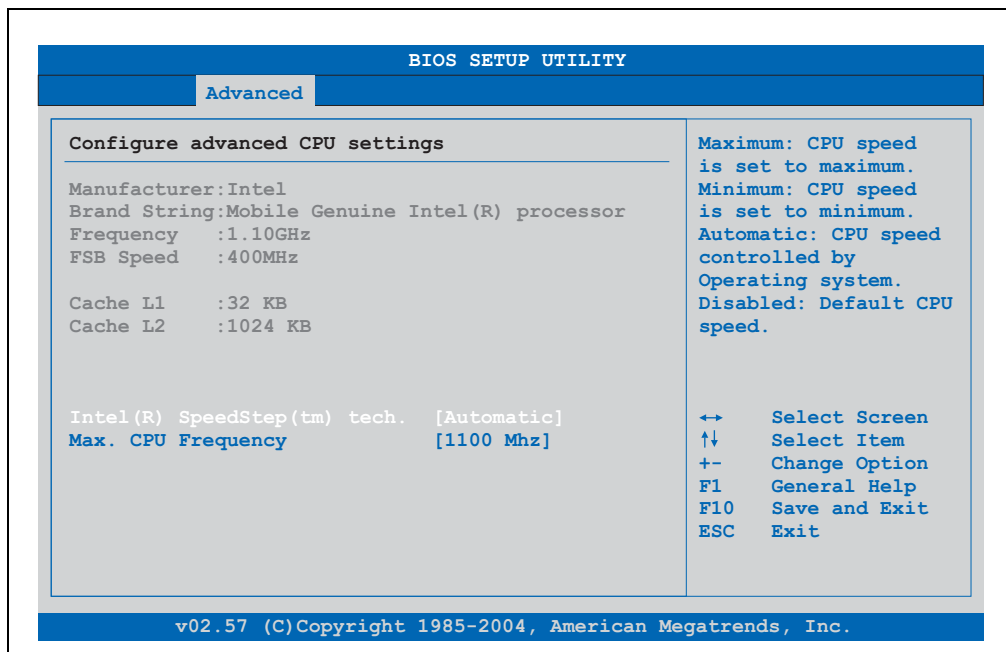

Figure 238: 855GME (XTX) Advanced CPU Configuration

BIOS setting	Meaning	Setting options	Effect
Manufacturer	Manufacturer's display.	None	-
Brand string	Display of CPU values	None	-
Frequency	Processor speed display	None	-
FSB speed	Cycle display of all addressed components. (Front side bus)	None	-
L1 cache	Displays first level cache memory area.	None	-
L2 cache	Displays first level cache memory area.	None	-
Intel (R) SpeedStep (tm) tech.	The computing capacity can be set with this option.	Maximum speed	Maximum computing capacity
		Minimum speed	Minimum computing capacity.
		Automatic	Computing capacity selected automatically.
		Disabled	Disables this function.
Max. CPU frequency	The maximum CPU speed can be set here.  <b>Information:</b> Is only visible if the "Intel (R) SpeedStep (tm) tech." option is set to automatic or maximum speed.	1100 MHz, 1000 MHz, 900 MHz, 800 MHz, 600 MHz;	Value set manually.

Table 294: 855GME (XTX) Advanced CPU Configuration setting options

Chipset configuration

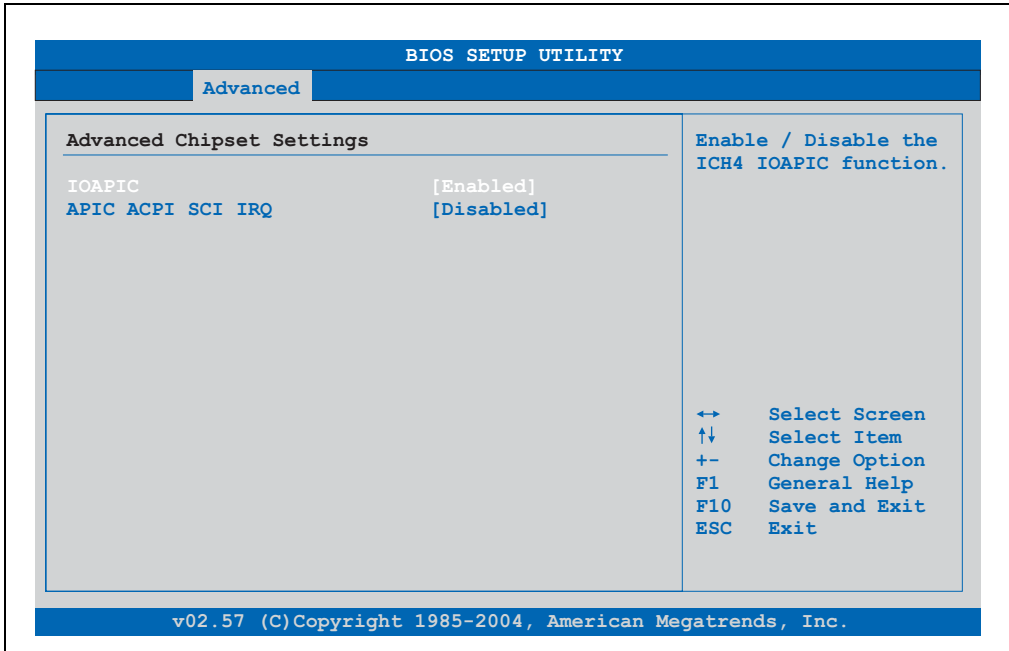

Figure 239: 855GME (XTX) - advanced chipset configuration

BIOS setting	Meaning	Setting options	Effect
IOAPIC	This option is used to activate or deactivate the APIC (Advanced Programmable Interrupt Controller).  <b>Information:</b> The IRQ resources available to the system are expanded when the APIC mode is enabled.	Disabled	Deactivates this function.
		Enabled	Activates this function.
APIC ACPI SCI IRQ	This option is used to activate or deactivate the APIC (Advanced Programmable Interrupt Controller).  <b>Information:</b> The IRQ resources available to the system are expanded when the APIC mode is enabled.	Disabled	Deactivates this function.
		Enabled	Activates this function.

Table 295: 855GME (XTX) - advanced chipset - setting options

I/O interface configuration

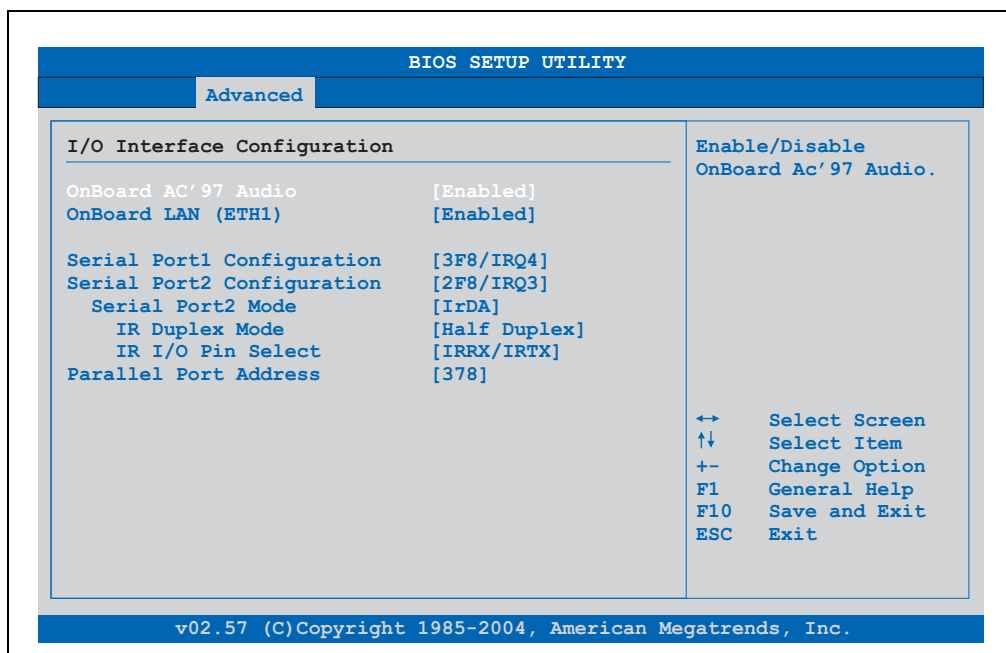

Figure 240: 855GME (XTX) I/O Interface Configuration

BIOS setting	Meaning	Setting options	Effect
OnBoard AC'97 Audio	For turning the Onboard AC'97 audio controller on and off.	Enabled	Enables AC'97 sound.
		Disabled	Disables AC'97 sound.
Onboard LAN (ETH1)	For turning the on-board LAN controller (for ETH1) on and off.	Disabled	Deactivates the LAN controller or the ETH1 interface.
		Enabled	Deactivates the LAN controller or the ETH1 interface.
Serial port 1 configuration	For the configuration of serial port 1 (COM1).	Disabled	Port 1 deactivated.
		3F8/IRQ4	Assignment of the base I/O address and the interrupt.
		3E8 / IRQ4	Assignment of the base I/O address and the interrupt.
Serial port 2 configuration	For the configuration of serial port 2 (COM1).	Disabled	Port 1 deactivated.
		2F8/IRQ3	Assignment of the base I/O address and the interrupt.
		2E8 / IRQ3	Assignment of the base I/O address and the interrupt.

Table 296: 855GME (XTX) Advanced I/O Interface Configuration setting options

BIOS setting	Meaning	Setting options	Effect
Serial port 2 mode	This option is for setting the serial port B as either a standard interface or as an infrared interface (not currently supported).	Normal	Standard interface.
		IrDA	IrDA interface (compliant serial infrared port).
		ASK IR	Interface for IR devices (amplitude shift keyed infrared port).
IR duplex mode	The interface duplex drive can be configured with this option.  <b>Information:</b> Only visible if the "Serial Port2 Mode" function is set to IrDA or ASK IR.	Half-duplex	Half-duplex drive.
		Full-duplex	Full-duplex drive.
IR I/O pin select	With this option, the infrared (IR) function on the on-board I/O chip can be determined.  <b>Information:</b> Only visible if the "Serial Port2 Mode" function is set to IrDA or ASK IR.	IRRX/IRTX	An internal infrared device is used.
		SINB/SOUTB	An external infrared device is used.
Parallel port address	The address of the parallel interface can be defined with this option.  <b>Information:</b> Address is automatically set, even if the function is disabled.	Disabled	Deactivates the port.
		378, 278, 3BC	Manual assignment of the port address.

Table 296: 855GME (XTX) Advanced I/O Interface Configuration setting options (Forts.)

Clock Configuration

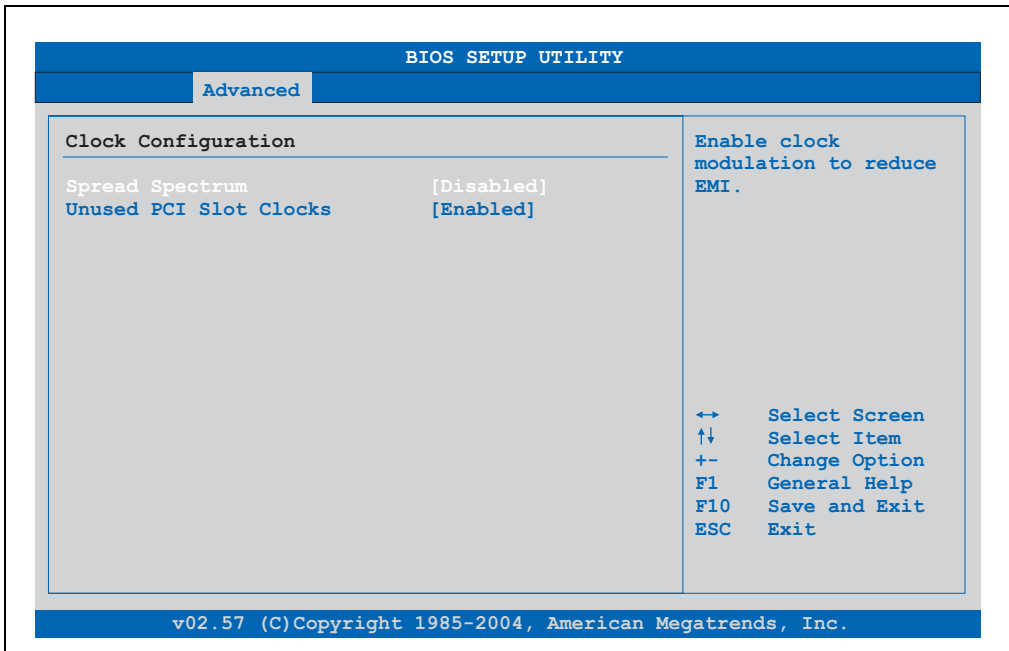

Figure 241: 855GME (XTX) Advanced Clock Configuration

BIOS setting	Meaning	Setting options	Effect
Spread spectrum	With this option, the cycle frequency can be modulated by reducing electromagnetic disturbances.	Disabled	Disables this function.
		Enabled	Enables this function.
Unused PCI slot clocks	This option activates or deactivates the unused PCI slot cycle.	Disabled	Disables this function.
		Enabled	Enables this function.

Table 297: 855GME (XTX) Advanced Clock Configuration setting options



IDE Configuration

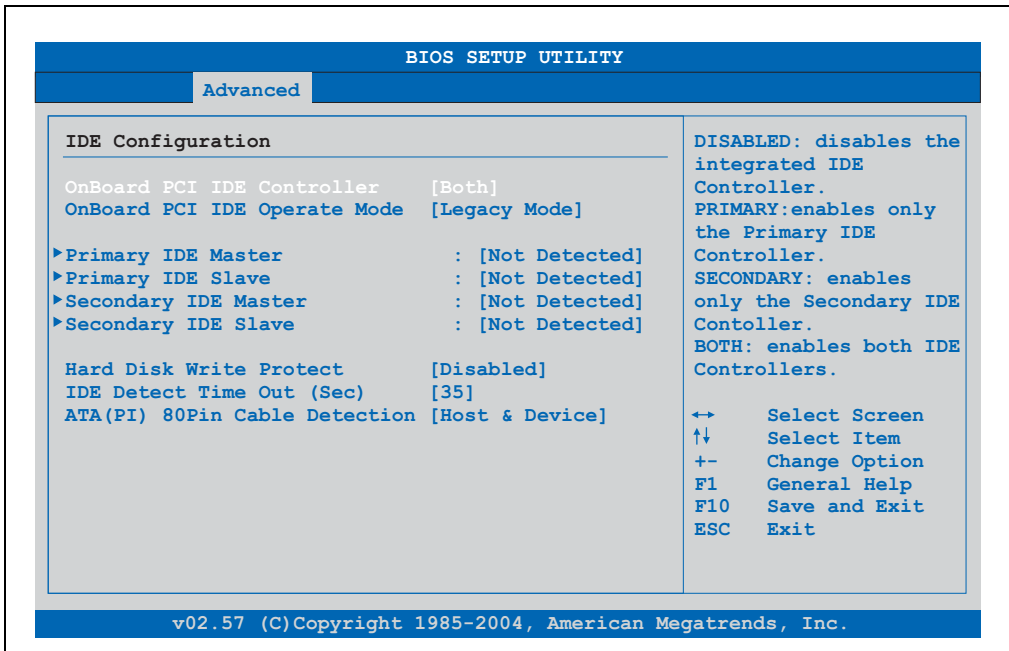

Figure 242: 855GME (XTX) Advanced IDE Configuration

BIOS setting	Meaning	Setting options	Effect
OnBoard PCI IDE controller	Both the IDE controllers found on the board can be configured here.	Disabled	Disables this function.
		Primary	Activates the primary IDE channel.
		Secondary	Activates the secondary IDE channel.
		Both	Activates both IDE channels (primary and secondary).
OnBoard PCI IDE operate mode	The PCI IDE operate mode found on the board is configured here.	Legacy mode	Activates legacy mode
		Native mode	Activates the native mode (suited for Windows XP and Windows 2000).
Primary IDE Master	The drive in the system that is connected to the IDE primary master port is configured here.	Enter	Opens the submenu See "Primary IDE Master", on page 498
Primary IDE slave	The drive in the system that is connected to the IDE primary slave port is configured here.	Enter	Opens the submenu See "Primary IDE slave", on page 500
Secondary IDE Master	The drive in the system that is connected to the IDE secondary master port is configured here.	Enter	Opens the submenu See "Secondary IDE Master", on page 501

Table 298: 855GME (XTX) Advanced IDE Configuration setting options

## Software • BIOS options

BIOS setting	Meaning	Setting options	Effect
Secondary IDE slave	The drive in the system that is connected to the IDE secondary slave port is configured here.	Enter	Opens the submenu See "Secondary IDE slave", on page 503
Hard disk write protect	Write protection for the hard drive can be enabled/disabled here.	Disabled	Disables this function.
		Enabled	Enables this function.
IDE Detect Time Out (Sec)	Configuring the time overrun limit value for the ATA/ATAPI device identification.	0, 5, 10, 15, 20, 25, 30, 35	Value set manually.
ATA (PI) 80 pin cable detection	Detects whether an 80 pin cable is connected to the drive, the controller or to both.  <b>Information:</b>  <b>This cable should be used whenever possible, otherwise error messages will appear.</b>	Host & device	Using both IDE controllers (motherboard, disk drive).
		Host	Using the IDE controller motherboard.
		Device	Using the IDE disk drive controller.

Table 298: 855GME (XTX) Advanced IDE Configuration setting options (Forts.)

### Primary IDE Master

**BIOS SETUP UTILITY**

**Advanced**

---

**Primary IDE Master**

Device : Not Detected

---

Type	[Auto]
LBA/Large Mode	[Auto]
Block (Multi-Sector Transfer)	[Auto]
PIO Mode	[Auto]
DMA Mode	[Auto]
S.M.A.R.T.	[Auto]
32Bit Data Transfer	[Enabled]

↔ Select Screen

↑↓ Select Item

+ - Change Option

F1 General Help

F10 Save and Exit

ESC Exit

v02.57 (C) Copyright 1985-2004, American Megatrends, Inc.

Figure 243: 855GME (XTX) Primary IDE Master

BIOS setting	Meaning	Setting options	Effect
Type	The type of drive connected to the primary master is configured here.	Not installed	No drive installed.
		Auto	Automatic recognition of the drive and setup of appropriate values.
		CD/DVD	CD -/ DVD drive.
		ARMD	ARMD - drive (zip drive)
LBA/Large Mode	This option activates the logical block addressing / large mode for IDE.	Disabled	Disables this function.
		Auto	Automatic enabling of this function when supported by the system.
Block (Multi-Sector Transfer)	This option enables the block mode for IDE hard drives. When this option is enabled, the number of blocks per request from the configuration sector of the hard drive is read.	Disabled	Disables this function.
		Auto	Automatic enabling of this function when supported by the system.
PIO Mode	The PIO mode determines the data rate of the hard drive.  <b>Information:</b> <b>The higher the PIO mode, the shorter the data cable must be.</b>	Auto	Automatic configuration of PIO mode.
		0, 1, 2, 3, 4	Manual configuration of PIO mode.
DMA Mode	The data transfer rate to and from the primary master drive is defined here. The DMA mode must be activated in the Windows device manager in order to guarantee maximum performance. Only possible when manually setting up the drive.	Auto	Automatic definition of the transfer rate.
		SWDMA0, SWDMA1, SWDAM2, MWDMA0, MWDMA1, MWDMA2;	Manual definition of the transfer rate.
S.M.A.R.T.	Monitoring function of modern hard drives (self-monitoring, analysis and reporting technology).	Auto	Automatic detection and enabling.
		Disabled	Disables this function.
		Enabled	Enables this function.
32 Bit Data Transfer	This function enables 32-bit data transfer.	Disabled	Disables this function.
		Enabled	Enables this function.

Table 299: 855GME (XTX) Primary IDE Master setting options

Primary IDE slave

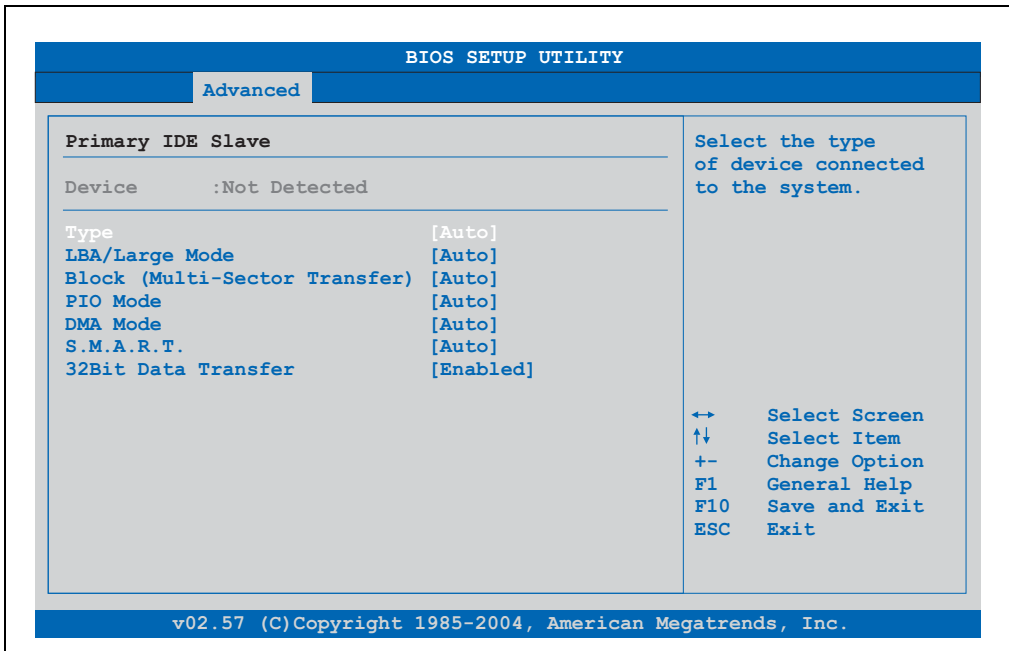

Figure 244: 855GME (XTX) - primary IDE slave

BIOS setting	Meaning	Setting options	Effect
Type	The type of drive connected to the primary slave is configured here.	Not installed	No drive installed.
		Auto	Automatic recognition of the drive and setup of appropriate values.
		CD/DVD	CD -/ DVD drive
		ARMD	ARMD - drive (zip drive)
LBA/Large Mode	This option activates the logical block addressing / large mode for IDE.	Disabled	Disables this function.
		Auto	Automatic enabling of this function when supported by the system.
Block (Multi-Sector Transfer)	This option enables the block mode for IDE hard drives. When this option is enabled, the number of blocks per request from the configuration sector of the hard drive is read.	Disabled	Disables this function.
		Auto	Automatic enabling of this function when supported by the system.
PIO Mode	The PIO mode determines the data rate of the hard drive.  <b>Information:</b> The higher the PIO mode, the shorter the data cable must be.	Auto	Automatic configuration of PIO mode.
		0, 1, 2, 3, 4	Manual configuration of PIO mode.

Table 300: 855GME (XTX) - primary IDE slave - setting options

BIOS setting	Meaning	Setting options	Effect
DMA Mode	The data transfer rate to and from the primary slave drive is defined here. The DMA mode must be activated in the Windows device manager in order to guarantee maximum performance. Only possible when manually setting up the drive.	Auto	Automatic definition of the transfer rate.
		SWDMA0, SWDMA1, SWDAM2, MWDMA0, MWDMA1, MWDMA2;	Manual definition of the transfer rate.
S.M.A.R.T.	Monitoring function of modern hard drives (self-monitoring, analysis and reporting technology).	Auto	Automatic detection and enabling.
		Disabled	Disables this function.
		Enabled	Enables this function.
32 Bit Data Transfer	This function enables 32-bit data transfer.	Disabled	Disables this function.
		Enabled	Enables this function.

Table 300: 855GME (XTX) - primary IDE slave - setting options

Secondary IDE Master

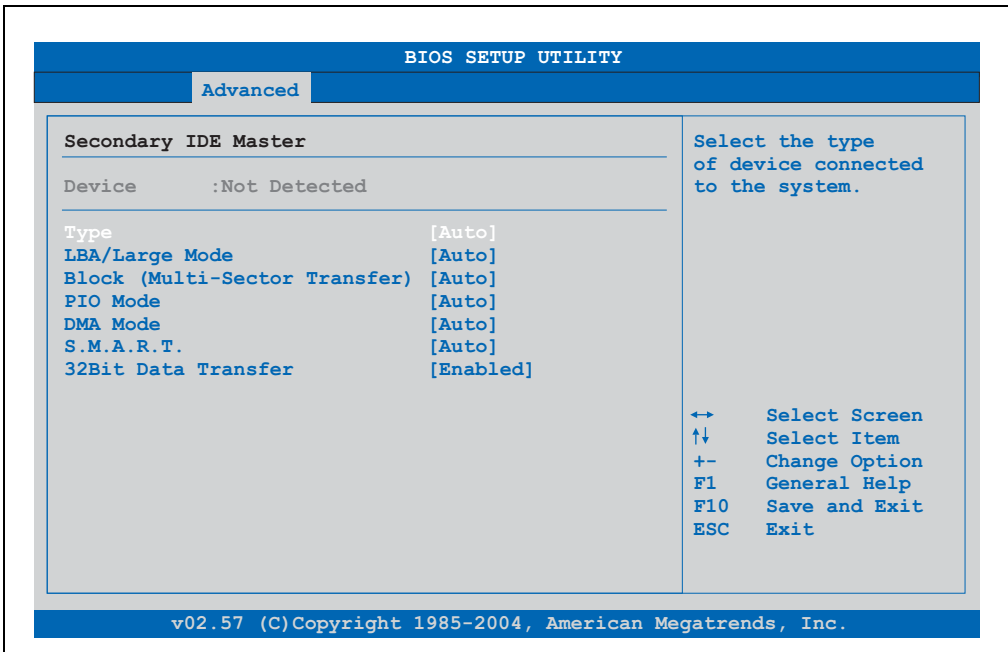

Figure 245: 855GME (XTX) Secondary IDE Master

Section 4  
Software

## Software • BIOS options

BIOS setting	Meaning	Setting options	Effect
Type	The type of drive connected to the secondary master is configured here.	Not installed	No drive installed.
		Auto	Automatic recognition of the drive and setup of appropriate values.
		CD/DVD	CD -/ DVD drive
		ARMD	ARMD - drive (zip drive)
LBA/Large Mode	This option activates the logical block addressing / large mode for IDE.	Disabled	Disables this function.
		Auto	Automatic enabling of this function when supported by the system.
Block (Multi-Sector Transfer)	This option enables the block mode for IDE hard drives. When this option is enabled, the number of blocks per request from the configuration sector of the hard drive is read.	Disabled	Disables this function.
		Auto	Automatic enabling of this function when supported by the system.
PIO Mode	The PIO mode determines the data rate of the hard drive.  <b>Information:</b> <b>The higher the PIO mode, the shorter the data cable must be.</b>	Auto	Automatic configuration of PIO mode.
		0, 1, 2, 3, 4	Manual configuration of PIO mode.
DMA Mode	The data transfer rate to and from the secondary master drive is defined here. The DMA mode must be activated in the Windows device manager in order to guarantee maximum performance. Only possible when manually setting up the drive.	Auto	Automatic definition of the transfer rate.
		SWDMA0, SWDMA1, SWDAM2, MWDMA0, MWDMA1, MWDMA2;	Manual definition of the transfer rate.
S.M.A.R.T.	Monitoring function of modern hard drives (self-monitoring, analysis and reporting technology).	Auto	Automatic detection and enabling.
		Disabled	Disables this function.
		Enabled	Enables this function.
32 Bit Data Transfer	This function enables 32-bit data transfer.	Disabled	Disables this function.
		Enabled	Enables this function.

Table 301: 855GME (XTX) Secondary IDE Master setting options

Secondary IDE slave

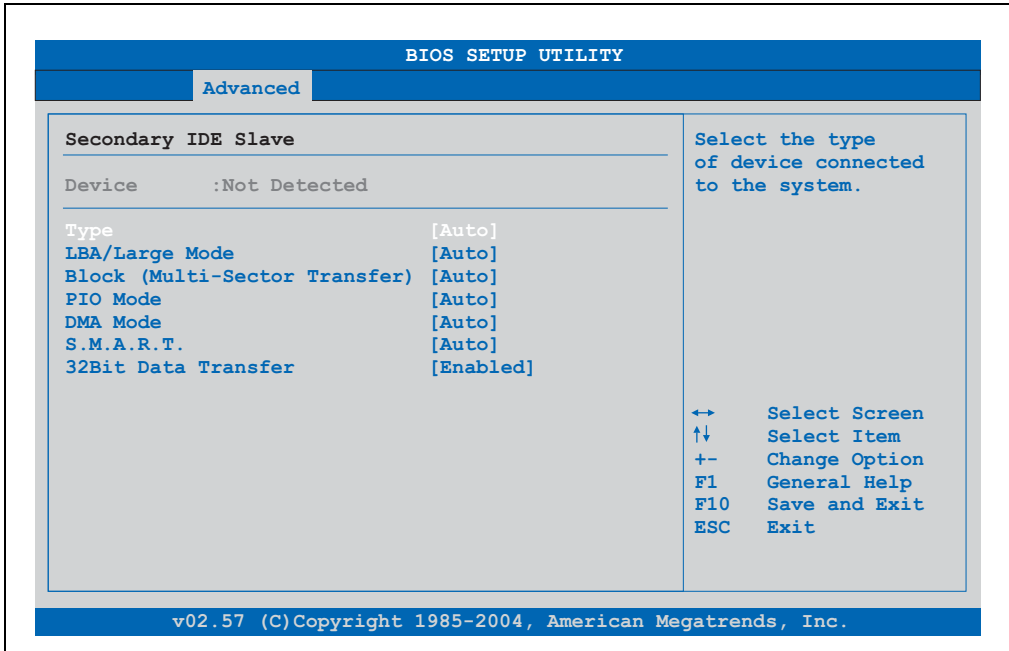

Figure 246: 855GME (XTX) Secondary IDE Slave

BIOS setting	Meaning	Setting options	Effect
Type	The type of drive connected to the secondary slave is configured here.	Not installed	No drive installed.
		Auto	Automatic recognition of the drive and setup of appropriate values.
		CD/DVD	CD -/ DVD drive
		ARMD	ARMD - drive (zip drive)
LBA/Large Mode	This option activates the logical block addressing / large mode for IDE.	Disabled	Disables this function.
		Auto	Automatic enabling of this function when supported by the system.
Block (Multi-Sector Transfer)	This option enables the block mode for IDE hard drives. When this option is enabled, the number of blocks per request from the configuration sector of the hard drive is read.	Disabled	Disables this function.
		Auto	Automatic enabling of this function when supported by the system.
PIO Mode	The PIO mode determines the data rate of the hard drive.  <b>Information:</b> The higher the PIO mode, the shorter the data cable must be.	Auto	Automatic configuration of PIO mode.
		0, 1, 2, 3, 4	Manual configuration of PIO mode.

Table 302: 855GME (XTX) Secondary IDE Slave setting options

Section 4  
Software

## Software • BIOS options

BIOS setting	Meaning	Setting options	Effect
DMA Mode	The data transfer rate to and from the secondary slave is defined here. The DMA mode must be activated in the Windows device manager in order to guarantee maximum performance. Only possible when manually setting up the drive.	Auto	Automatic definition of the transfer rate.
		SWDMA0, SWDMA1, SWDMA2, MWDMA0, MWDMA1, MWDMA2;	Manual definition of the transfer rate.
S.M.A.R.T.	Monitoring function of modern hard drives (self-monitoring, analysis and reporting technology).	Auto	Automatic detection and enabling.
		Disabled	Disables this function.
		Enabled	Enables this function.
32 Bit Data Transfer	This function enables 32-bit data transfer.	Disabled	Disables this function.
		Enabled	Enables this function.

Table 302: 855GME (XTX) Secondary IDE Slave setting options (Forts.)

## USB configuration

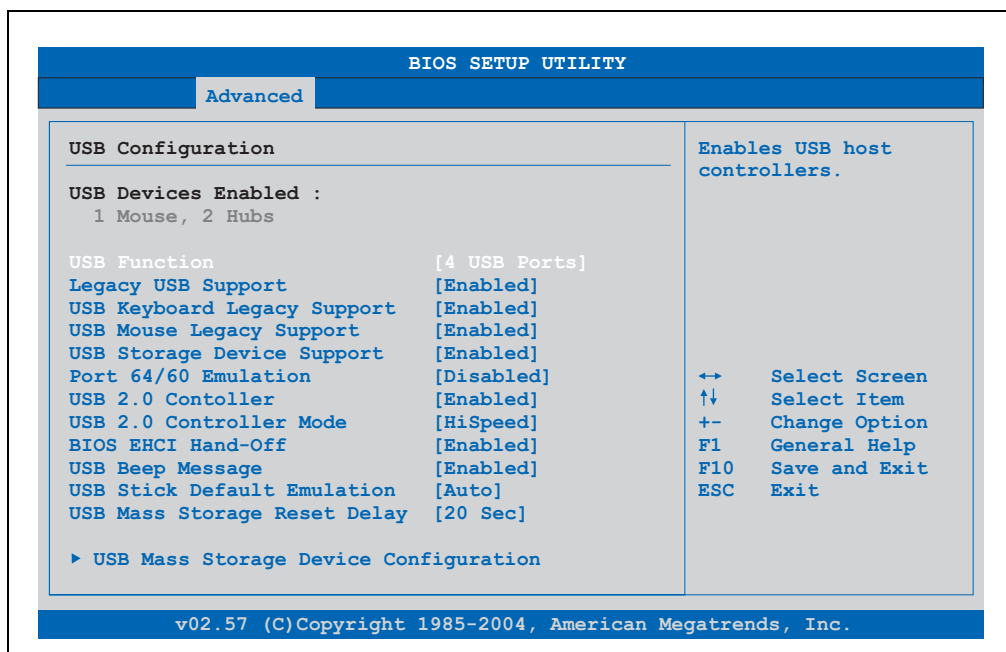

Figure 247: 855GME (XTX) Advanced USB Configuration



BIOS setting	Meaning	Setting options	Effect
USB Function	USB ports can be enabled/disabled here.	Disabled	Disables the USB port.
		2 USB ports, 4 USB ports, 6 USB ports (not supported by APC620 / PPC700).	Manual selection of the USB port.
Legacy USB Support	Legacy USB support can be enabled/disabled here. USB interfaces do not function during startup. USB is supported again after the operating system has started. A USB keyboard is still recognized during the POST.	Disabled	Disables this function.
		Enabled	Enables this function.
		Auto	Automatic enabling.
USB Keyboard Legacy Support	USB keyboard support can be enabled/disabled here.  <b>Information:</b> <b>If this function is disabled, a USB keyboard is also not supported during the POST.</b>	Disabled	Disables this function.
		Enabled	Enables this function.
USB Mouse Legacy Support	USB mouse support can be enabled/disabled here.	Disabled	Disables this function.
		Enabled	Enables this function.
USB Storage Device Support	USB storage device support can be enabled/disabled here.	Disabled	Disables this function.
		Enabled	Enables this function.
Port 64/60 Emulation	Port 64/60 emulation can be enabled/disabled here.	Disabled	USB keyboard functions in all systems excluding Windows NT.
		Enabled	USB keyboard functions in Windows NT.
USB 2.0 Controller	USB 2.0 mode can be activated/deactivated here.	Enabled	Enables this function.
		Disabled	Disables this function.
USB 2.0 Controller Mode	Settings can be made for the USB controller.	Full Speed	12 MBps
		Hi Speed	480 MBps
BIOS EHCI Hand-Off	The support for the operating system can be set up without the fully automatic EHCI function.	Disabled	Disables the function
		Enabled	Enables this function.
USB Beep Message	The warning tone can be activated/deactivated here.	Disabled	Disables this function.
		Enabled	Enables this function.
USB Stick Default Emulation	You can set how the USB device is to be used.	Auto	USB devices with fewer than 530MB of memory are simulated as floppy disk drives and devices with larger capacities are simulated as hard drives.
		Hard Disk	An HDD-formatted drive can be used as an FDD (e.g. zip drive) for starting the system.

Table 303: 855GME (XTX) Advanced USB Configuration setting options

## Software • BIOS options

BIOS setting	Meaning	Setting options	Effect
USB Mass Storage Reset Delay	The waiting time that the USB device POST requires after the device start command can be set.  <b>Information:</b> The message "No USB mass storage device detected" is displayed if no USB memory device has been installed.	10 Sec, 20 Sec, 30 Sec, 40 Sec	Value set manually.
USB mass storage device configuration	This is where the USB mass memory device is configured.  <b>Information:</b> Is only visible when the "USB stick default emulation" function is set to AUTO.	Enter	Opens the submenu See "USB mass storage device configuration", on page 507

Table 303: 855GME (XTX) Advanced USB Configuration setting options (Forts.)

USB mass storage device configuration

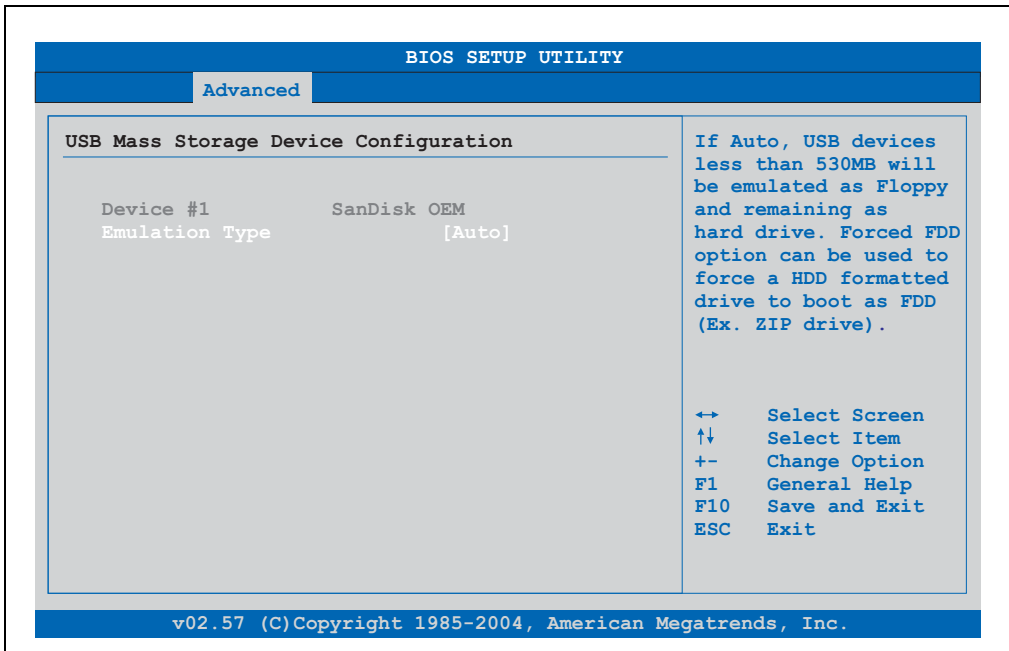

Figure 248: 855GME (XTX) USB mass storage device configuration

BIOS setting	Meaning	Setting options	Effect
Emulation type	With this option, the device to be plugged into the USB interface can be selected.	Auto	Automatic selection of the function.
		Floppy	Using a floppy disk drive.
		Forced FDD	A hard disk image is connected as a floppy image. Functions only in the FAT12, FAT16 or FAT32 formats.
		Hard Disk	Using a hard disk
		CDROM	Using a CD-ROM drive, it is assumed as 'bootable'.

Table 304: 855GME (XTX) USB mass storage device configuration

Keyboard/mouse configuration

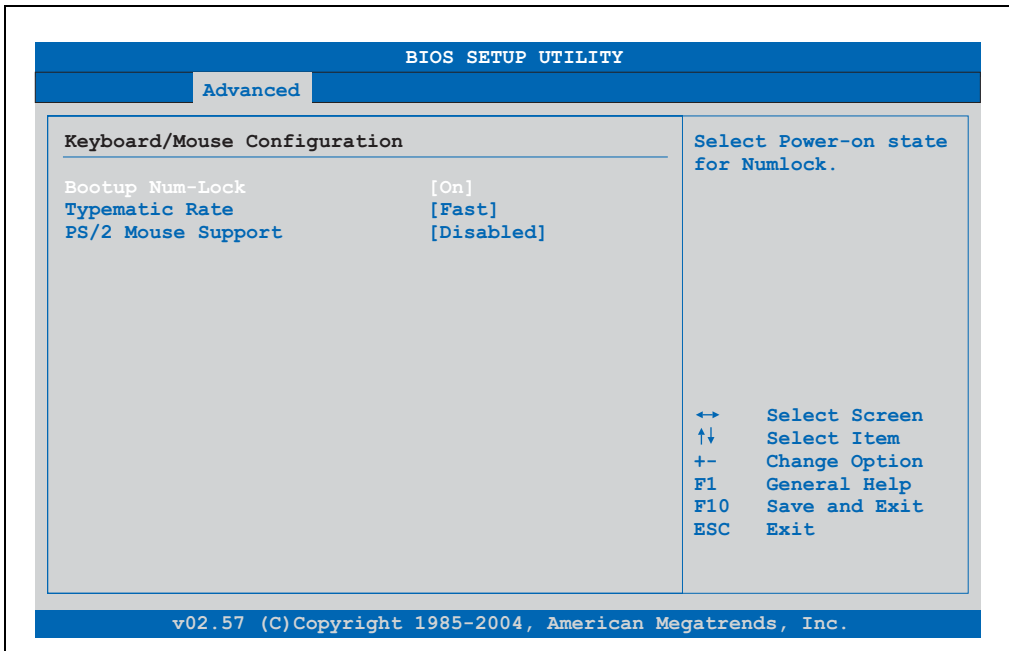

Figure 249: 855GME (XTX) - advanced keyboard/mouse configuration

BIOS setting	Meaning	Setting options	Effect
Boot-up Num-lock	With this field you can define the state of the NumLock key when booting.	Off	Only the cursor functions of the numerical keypad are enabled.
		On	Numeric keypad is enabled.
Typematic rate	The key repeat function is set here.	Slow	Slow key repeat.
		Fast	Fast key repeat.
PS/2 mouse support	Sets whether the PS/2 mouse port should be activated.	Disabled	Disables this function.
		Enabled	Enables this function.
		Auto	Automatic activation of the function if PS/2 mouse port is supported.

Table 305: 855GME (XTX) - advanced keyboard/mouse configuration - setting options

Remote access configuration

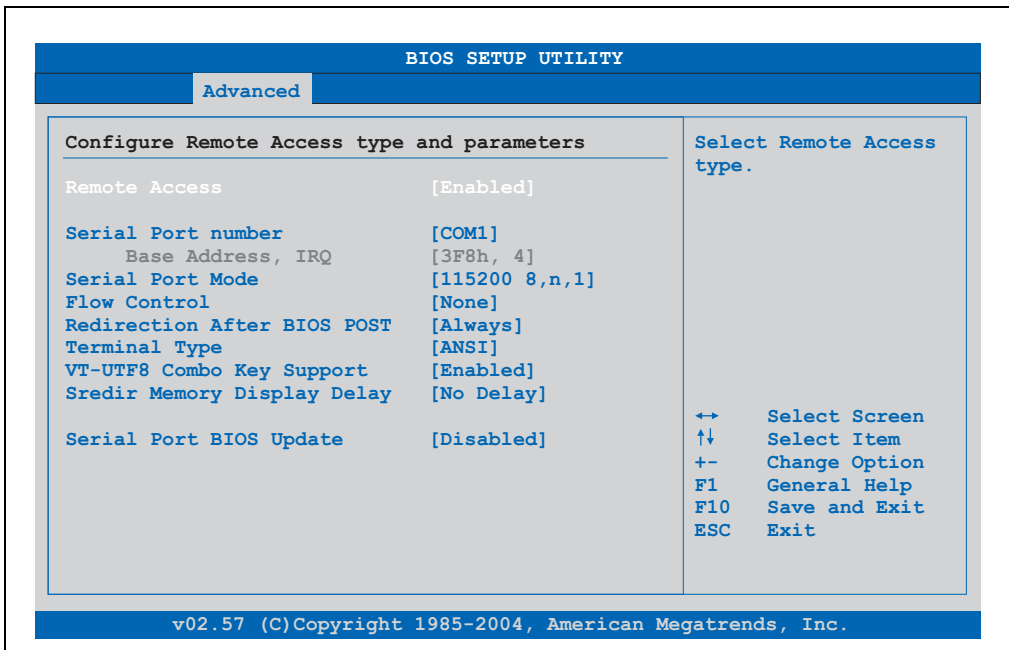

Figure 250: 855GME (XTX) - advanced remote access configuration

BIOS setting	Meaning	Setting options	Effect
Remote access	The remote access function can be enabled/disabled here.	Disabled	Disables this function.
		Enabled	Enables this function.
Serial port number	The serial interface can be set using this option, as long as disabled is not entered in the remote access field.	COM1	Activates the COM1 interface.
		COM2	Activates the COM2 interface.
Base address, IRQ	Serial connection display for the logical address and interrupt, as long as disabled is not entered in the remote access field.	None	-
Serial port mode	The serial interface transfer rate is defined here, as long as disabled is not entered in the remote access field.	115200 8,n,1 57600 8,n,1 38400 8,n,1 19200 8,n,1 09600 8,n,1	Value set manually.

Table 306: 855GME (XTX) - advanced remote access configuration - setting options

## Software • BIOS options

BIOS setting	Meaning	Setting options	Effect
Flow control	<p>The interface configuration is carried out here, as long as disabled is not entered in the remote access field. This setting determines how the transfer is controlled via the interface.</p> <p><b>Information:</b> The setting must be the same on the terminal and the server.</p>	None	The interface is operated without transfer control.
		Hardware	The interface transfer control is carried out through hardware. This mode must be supported by a cable.
		Software	The interface transfer control is carried out through software.
Redirection after BIOS POST	<p>The redirection after start up can be set here, as long as disabled is not entered in the remote access field.</p>	Disabled	The redirection is switched off after start up.
		Boot loader	Redirection is enabled during system start up and charging.
		Always	Redirection is always enabled.
Terminal type	<p>The type of connection can be chosen here, as long as disabled is not entered in the remote access field.</p>	ANSI, VT100, VT-UTF8	Manual configuration of the connection type.
VT-UTF8 Combo Key Support	<p>With this option, the VT-UTF8 Combo Key Support for the ANSI and VT100 connections can be enabled, as long as disabled is not entered in the remote access field.</p>	Disabled	Disables this function.
		Enabled	Enables this function.
Sredir Memory Display Delay	<p>The memory output delay can be set using this option, as long as disabled is not entered in the remote access field (Sredir -&gt; serial redirection).</p>	No delay	No delay.
		Delay 1 sec, Delay 2 sec, Delay 4 sec	Value set manually.
Serial port BIOS update	<p>During system start up, the update is loaded via the serial interface in the processor.</p> <p><b>Information:</b> If this option is disabled, the boot time is reduced.</p>	Disabled	Disables this function.
		Enabled	Enables this function.

Table 306: 855GME (XTX) - advanced remote access configuration - setting options (Forts.)

## CPU board monitor

**Information:**

The displayed temperature and voltage values (e.g. CPU temperature, core voltage, battery voltage) on this BIOS Setup page represent uncalibrated information values. These cannot be used to draw any conclusions about any hardware alarms or error conditions. The hardware components used have automatic diagnostics functions that can be applied in the event of error.

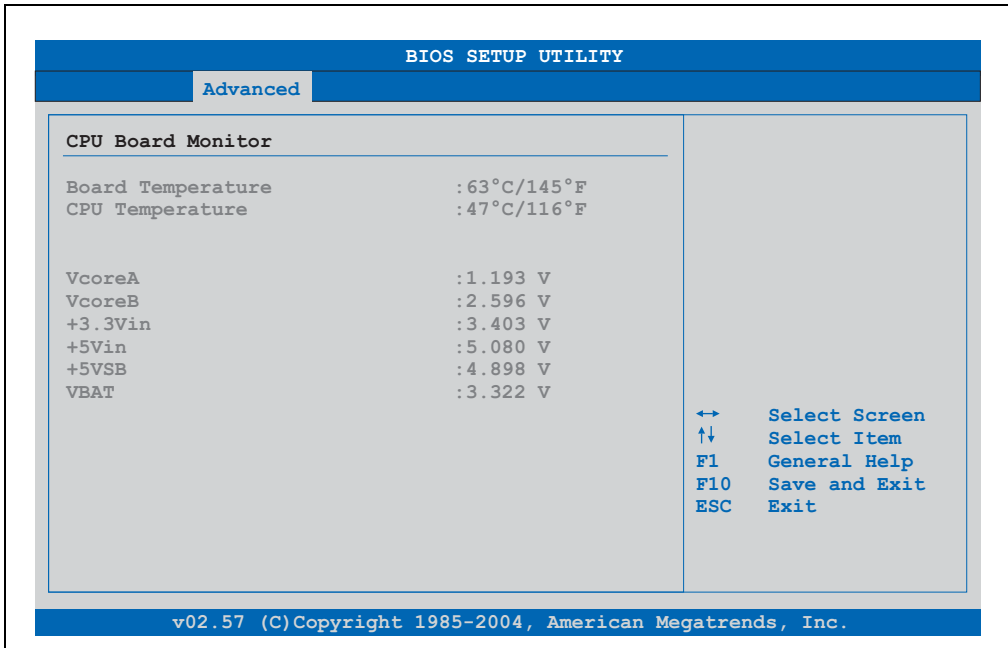

Figure 251: 855GME (XTX) - advanced CPU board monitor

BIOS setting	Meaning	Setting options	Effect
Board temperature	Displays the selected panel's temperature (in degrees Celsius and Fahrenheit).	None	-
CPU temperature	Displays the processor's temperature (in degrees Celsius and Fahrenheit).	None	-
VcoreA	Displays the processor's core voltage A in volts.	None	-
VcoreB	Displays the DDR's core voltage B in volts.	None	-
+3.3Vin	Displays the current voltage of the 3.3 volt supply.	None	-

Table 307: 855GME (XTX) - advanced remote access configuration - setting options

## Software • BIOS options

BIOS setting	Meaning	Setting options	Effect
+5Vin	Displays the current voltage of the 5 volt supply.	None	-
+5VSB	Displays the current level of the jumper.	None	-
VBAT	Displays the battery voltage (in volts).	None	-

Table 307: 855GME (XTX) - advanced remote access configuration - setting options

## Main Board/Panel Features

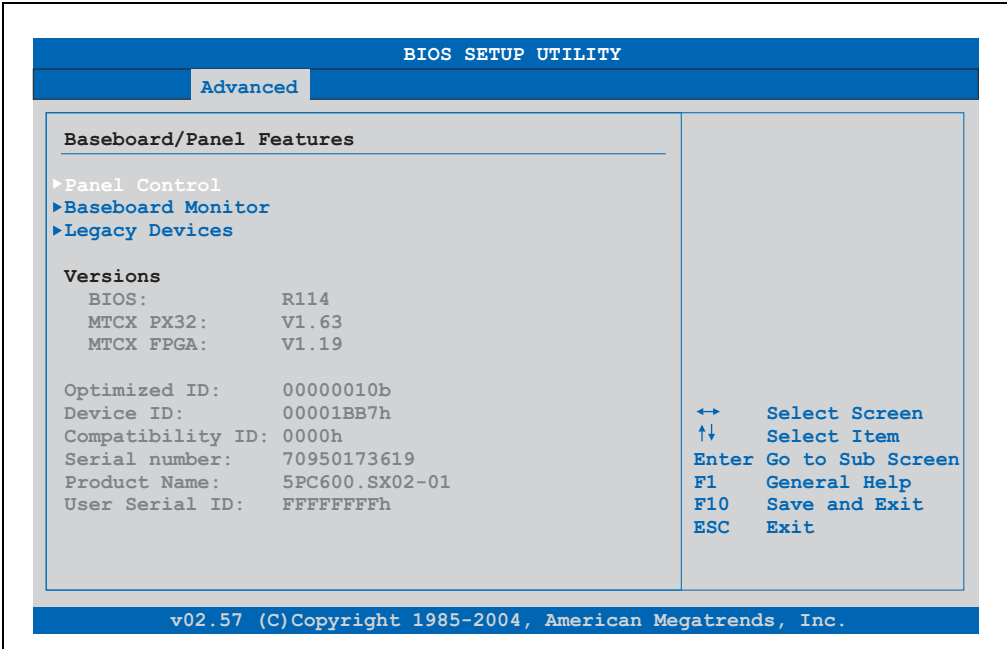

Figure 252: 855GME (XTX) Advanced Baseboard/Panel Features

BIOS setting	Meaning	Setting options	Effect
Panel control	For special setup of connected panels (display units).	Enter	Opens the submenu See "Panel control", on page 514
Main board monitor	Display of various temperatures and fan speeds.	Enter	Opens the submenu See "Main board monitor", on page 515
Legacy devices	Special settings for the interface can be changed here.	Enter	Opens the submenu See "Legacy devices", on page 516
BIOS	Displays the BIOS version.	None	-
MTCX PX32	Displays the MTCX PX32 firmware version.	None	-
MTCX FPGA	Displays the MTCX FPGA firmware version.	None	-

Table 308: 855GME (XTX) Advanced Baseboard/Panel Features setting options



BIOS setting	Meaning	Setting options	Effect
Optimized ID	Displays the DIP switch setting of the configuration switch.	None	-
Device ID	Displays the hexadecimal value of the hardware device ID.	None	-
Compatibility ID	Displays the version of the device within the same B&R device code. This ID is needed for Automation Runtime.	None	-
Serial number	Displays the B&R serial number.	None	-
Product name	Displays the B&R model number.	None	-
User serial ID	Displays the user serial ID. This 8 digit hex value can be freely assigned by the user (e.g. to give the device a unique ID) and can only be changed with using the "B&R Control Center" via the ADI driver.	None	-

Table 308: 855GME (XTX) Advanced Baseboard/Panel Features setting options (Forts.)

[Panel control](#)

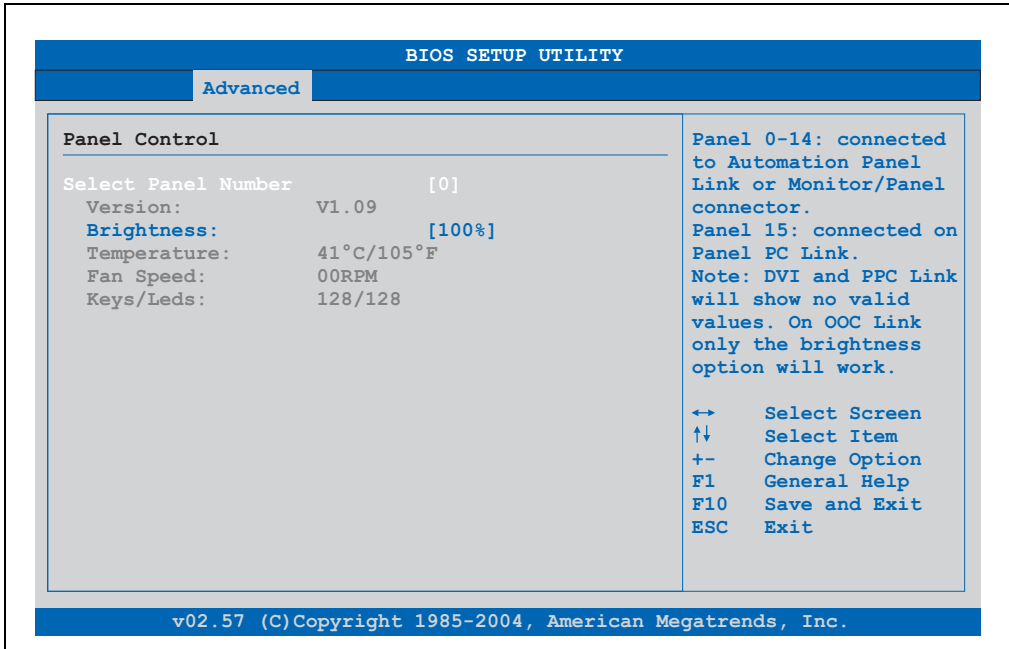

Figure 253: 855GME (XTX) Panel Control

BIOS setting	Meaning	Setting options	Effect
Select panel number	Selection of the panel number for which the values should be read out and/or changed.	0...15	Selection of panel 0 ... 15. Panel 15 is specifically intended for panel PC 700 systems.
Version	Displays the firmware version of the SDLR controller.	None	-
Brightness	For setting the brightness of the selected panel.	00%, 10%, 20%, 30%, 40%, 50%, 60%, 70%, 80%, 90%, 100%	For setting the brightness (in %) of the selected panel. Changes take effect after saving and restarting the system (e.g. by pressing <F10>).
Temperature	Displays the selected panel's temperature (in degrees Celsius and Fahrenheit).	None	-
Fan speed	Displays fan speed for the selected panel.	None	-
Keys/LEDs	Displays the available keys and LEDs on the selected panel.	None	-

Table 309: 855GME (XTX) Panel Control setting options

Main board monitor

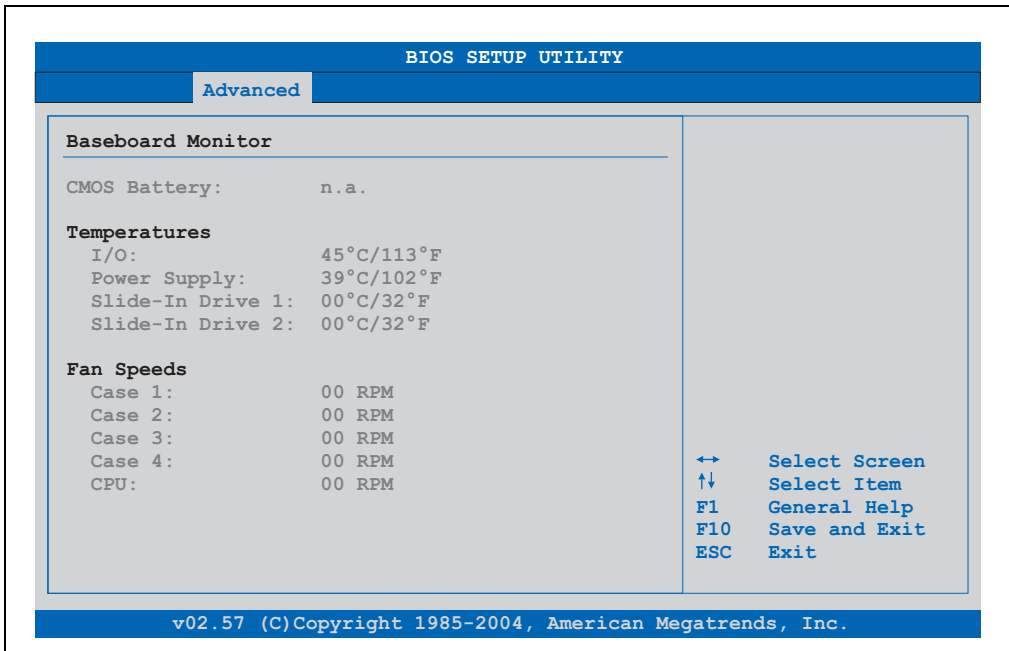

Figure 254: 855GME (XTX) - baseboard monitor

BIOS setting	Meaning	Setting options	Effect
CMOS battery	Displays the battery status. n.a. - not available, either MTCX does not support the firmware (starting with these versions "Main Board/Panel Features", on page 512) or the hardware is too old. <b>Good</b> - Battery is OK <b>Bad</b> - Battery is damaged.	None	-
I/O	Displays the temperature in the I/O area in degrees Celsius and Fahrenheit.	None	-
Power supply	Displays the temperature in the power supply area in degrees Celsius and Fahrenheit.	None	-
Slide-in drive 1	Displays the temperature of the slide-in drive 1 in degrees Celsius and Fahrenheit.	None	-
Slide-in drive 2	Displays the temperature of the slide-in drive 2 in degrees Celsius and Fahrenheit.	None	-
Case 1	Displays the fan speed of housing fan 1.	None	-
Case 2	Displays the fan speed of housing fan 2.	None	-
Case 3	Displays the fan speed of housing fan 3.	None	-
Case 4	Displays the fan speed of housing fan 4.	None	-

Table 310: 855GME (XTX) - baseboard monitor setting options

## Software • BIOS options

BIOS setting	Meaning	Setting options	Effect
CPU	Displays the fan speed of the processor fan.	None	-

Table 310: 855GME (XTX) - baseboard monitor setting options

### [Legacy devices](#)

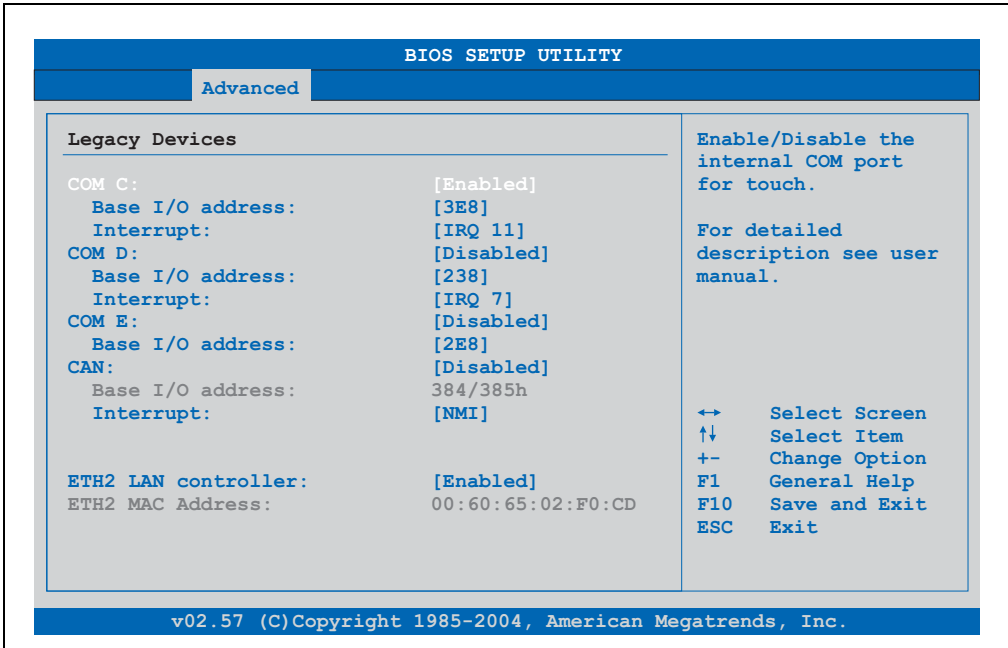

Figure 255: 855GME (XTX) - Legacy devices

BIOS setting	Meaning	Setting options	Effect
COM C	Settings for the internal serial interfaces in the system. This setting activates the touch screen in panel PC 700 systems, and, using SDL transfer technology, also in Automation Panel 900 display units.	Disabled	Disables the interface.
		Enabled	Enables the interface.
Base I/O address	Selection of the base I/O address for the COM C port. A yellow star indicates a conflict with another device.	328, 338, 3E8	Selected base I/O address is assigned.
Interrupt	Selection of the interrupt for the COM C port. A yellow star indicates a conflict with another device.	IRQ 5, IRQ 6, IRQ 11, IRQ 12	Selected interrupt is assigned.

Table 311: 855GME (XTX) Legacy Devices setting options

BIOS setting	Meaning	Setting options	Effect
COM D	Setting for the COM D port for the serial interface of an Automation Panel Link slot. The interface is used to operate the touch screen on connected Automation Panel 900 units.	Disabled	Disables the interface.
		Enabled	Enables the interface.
Base I/O address	Selection of the base I/O address for the COM D port. A yellow star indicates a conflict with another device.	238, 328, 338	Selected base I/O address is assigned.
Interrupt	Selection of the interrupt for the COM D port. A yellow star indicates a conflict with another device.	IRQ 5, IRQ 6, IRQ 7, IRQ 12	Selected interrupt is assigned.
COM E	Configuration of the optional COM E port on a B&R add-on interface (IF option).	Disabled	Disables the interface.
		Enabled	Enables the interface.
Base I/O address	Selection of the base I/O address for the COM E port. A yellow star indicates a conflict with another device.	2E8, 328, 338	Selected base I/O address is assigned.
Interrupt	Selection of the interrupt for the COM E port. A yellow star indicates a conflict with another device.	IRQ 5, IRQ 6, IRQ 10, IRQ 12	Selected interrupt is assigned.
CAN	Configuration of the CAN port of a B&R add-on CAN interface card (IF option).	Disabled	Disables the interface.
		Enabled	Enables the interface.
Base I/O address	Selection of the base I/O address for the CAN port.	None	-
Interrupt	Selection of the interrupt for the CAN port. A yellow star indicates a conflict with another device.	IRQ 10 and NMI	Selected interrupt is assigned.
ETH2 LAN controller	For turning the onboard LAN controller (ETH2) on and off.	Disabled	Disables the controller.
		Enabled	Enables the controller.
ETH2 MAC Address	Displays the Ethernet 2 controller MAC address.	None	-

Table 311: 855GME (XTX) Legacy Devices setting options (Forts.)

1.3.6 Boot

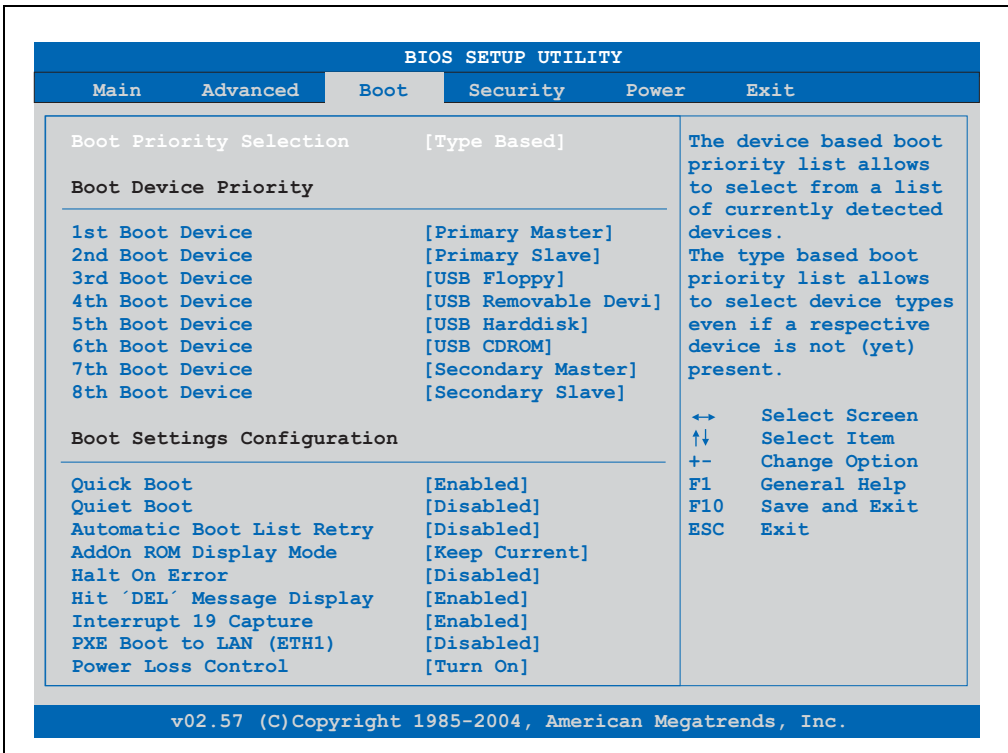

Figure 256: 855GME (XTX) Boot menu

BIOS setting	Meaning	Setting options	Effect
Boot Priority Selection	The priority for when the drives should be booted can be set here.	Device Based	Selection from a list of determined equipment.
		Type Based	Allows the selection of unavailable equipment.
1st Boot Device	The boot drives can be set using this option.	Disabled, primary master, primary slave, secondary master, secondary slave, Legacy floppy, USB floppy, USB harddisk, USB CDROM, USB removable device, onboard LAN (ETH1), external LAN, PCI mass storage PCI SCSI Card, Any PCI BEV Device, Onboard PCI SATA, Third Master Third Slave	Selecting the desired function.
2nd Boot Device			
3rd Boot Device			
4th Boot Device			
5th Boot Device			
6th Boot Device			
7th Boot Device			
8th Boot Device			
Quick Boot	This function reduces the boot time by skipping lines.	Disabled	Disables this function.
		Enabled	Enables this function.

Table 312: 855GME (XTX) Boot menu setting options

BIOS setting	Meaning	Setting options	Effect
Quiet Boot	Determines if POST message or OEM logo is displayed.	Disabled	POST message display.
		Enabled	OEM logo display instead of POST message.
Automatic Boot List Retry	With this option, the operating system automatically restarts following startup failure.	Disabled	Disables this function.
		Enabled	Enables this function.
Add-On ROM Display Mode	Sets the display mode for the ROM (during the booting procedure).	Force BIOS	An additional BIOS part can be displayed.
		Keep Current	BIOS information is displayed.
Halt On Error	This option sets whether the system should pause the Power On Self Test (POST) when it encounters an error.	Disabled	The system does not pause. All errors are ignored.
		Enabled	The system pauses. The system pauses every time an error is encountered.
Hit 'DEL' Message Display	Settings can be made here for the "Hit 'DEL' Message" display.  <b>Information:</b>  When quiet boot is activated the message is not displayed.	Disabled	The message is not displayed.
		Enabled	The message is displayed.
Interrupt 19 Capture	This function can be used to incorporate the BIOS interrupt.	Disabled	Disables this function.
		Enabled	Enables this function.
PXE boot to LAN (ETH1)	Activating/Deactivating the function to boot from LAN.	Disabled	Disables this function.
		Enabled	Enables this function.
Power Loss Control	Determines if the system is on/off following power loss.	Remain Off	Remains off.
		Turn On	Powers on.
		Last State	Enables the previous state.

Table 312: 855GME (XTX) Boot menu setting options (Forts.)

1.3.7 Security

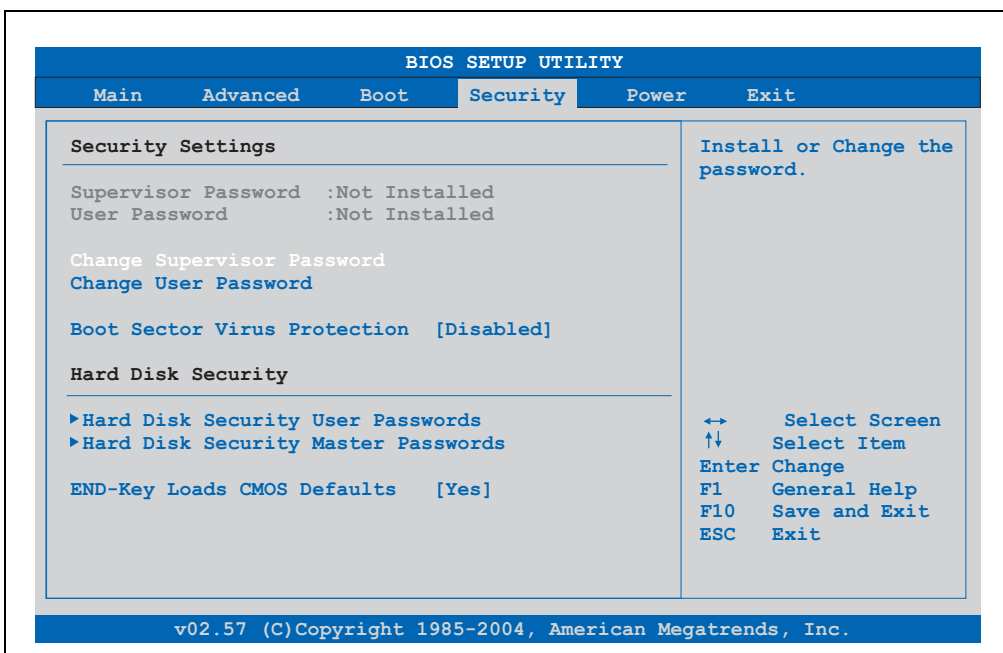

Figure 257: 855GME (XTX) Security menu

BIOS setting	Meaning	Setting options	Effect
Supervisor Password	Displays whether or not a supervisor password has been set.	None	-
User Password	Displays whether or not a user password has been set.	None	-
Change Supervisor Password	To enter/change a supervisor password. A supervisor password is necessary to edit all BIOS settings.	Enter	Enter password.
Change User Password	To enter/change a user password. A user password allows the user to edit only certain BIOS settings.	Enter	Enter password.
Boot Sector Virus Protection	With this option, a warning is issued when the boot sector is accessed through a program or virus.  <b>Information:</b> <b>With this option, only the boot sector is protected, not the entire hard drive.</b>	Disabled	Disables this function.
		Enabled	Enables this function.
Hard disk security user password	The hard disk security user password can be created here.	Enter	Opens the submenu See "Hard disk security user password", on page 521

Table 313: 855GME (XTX) Security menu setting options



BIOS setting	Meaning	Setting options	Effect
<b>Hard disk security master password</b>	The hard disk security master password can be created here.	Enter	Opens the submenu "Hard disk security master password", on page 522
END-key loads CMOS defaults	Using this function, CMOS can be loaded by pressing the END key during POST.	Yes	Enables this function.
		No	Disables this function.

Table 313: 855GME (XTX) Security menu setting options (Forts.)

### Hard disk security user password

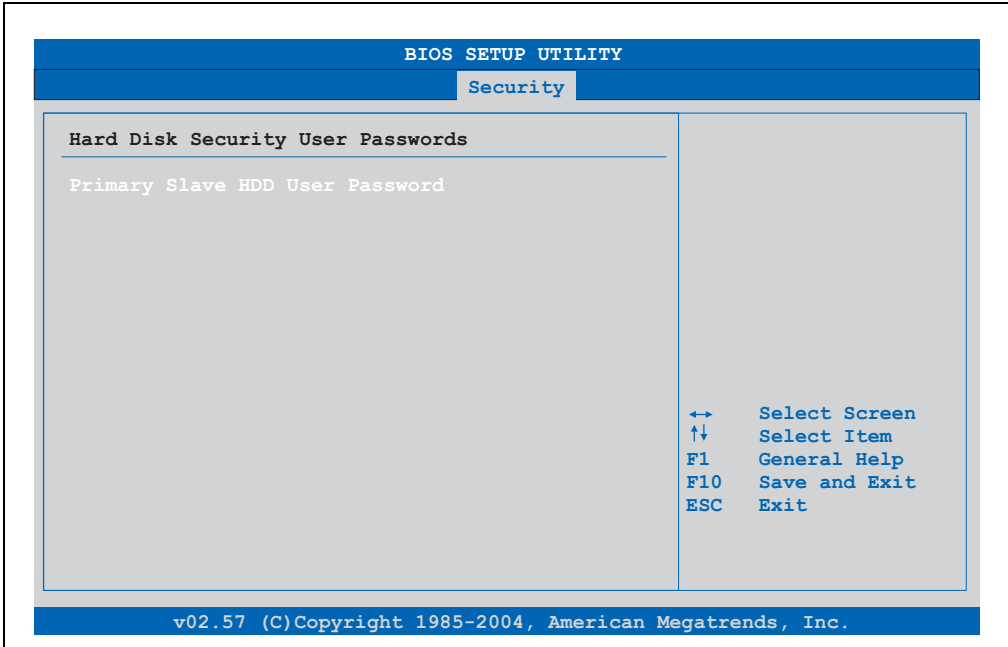

Figure 258: 855GME (XTX) Hard disk security user password

BIOS setting	Meaning	Setting options	Effect
Primary slave HDD user password	This function makes it possible to use the user password to change or configure each hard drive without having to reboot the device. A user password allows the user to edit only certain BIOS settings.	Enter	Enter password.

Table 314: 855GME (XTX) Hard disk security user password

Hard disk security master password

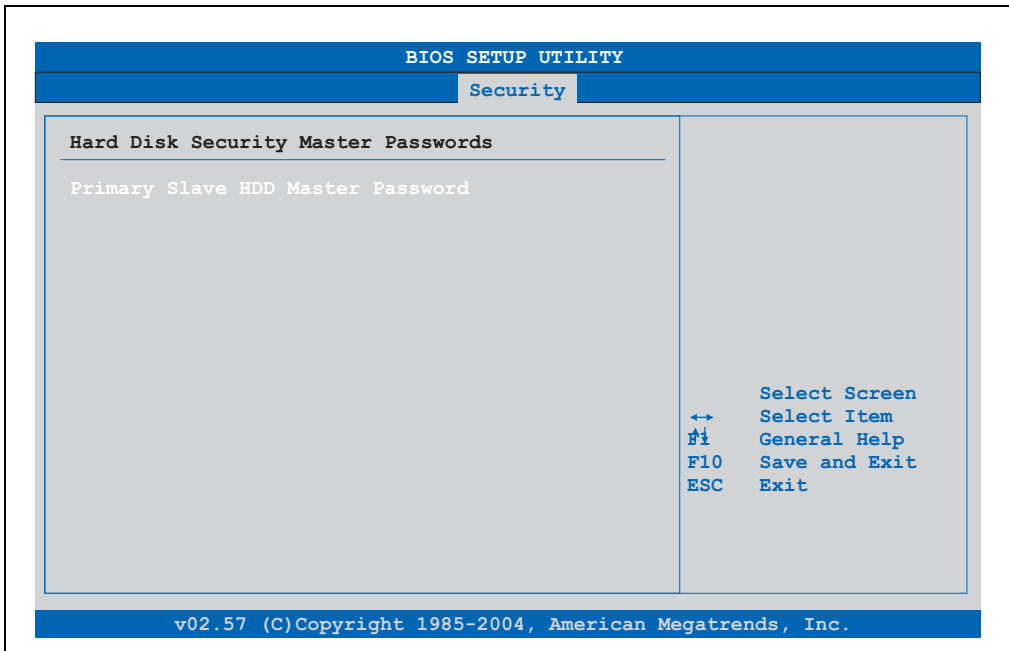

Figure 259: 855GME (XTX) Hard disk security master password

BIOS setting	Meaning	Setting options	Effect
Primary Slave HDD Master Password	This function makes it possible to use the user password to change or configure each hard drive without having to reboot the device.	Enter	Enter password.

Table 315: 855GME (XTX) Hard disk security master password

1.3.8 Power

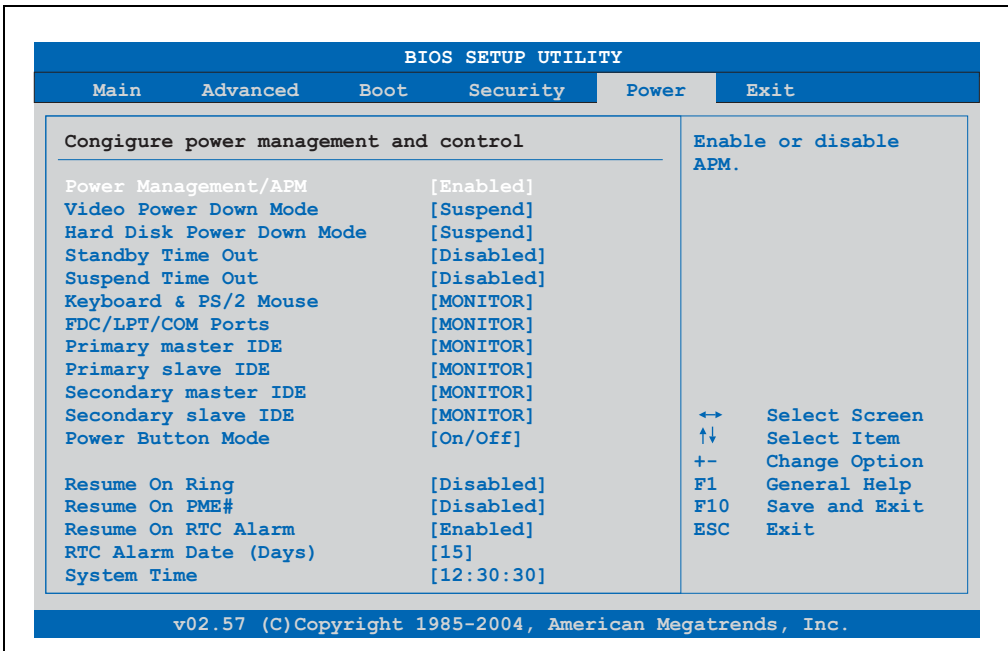

Figure 260: 855GME (XTX) Power menu

BIOS setting	Meaning	Setting options	Effect
Power Management/APM	This option switches the APM function on or off. This is an advanced plug & play and power management functionality.	Disabled	Disables this function.
		Enabled	Enables this function.
Video Power Down Mode	This option allows you to set the energy saving mode for the monitor.	Disabled	Do not switch off the monitor.
		Standby	Monitor goes to standby mode.
		Suspend	Monitor goes to suspend mode.
Hard Disk Power Down Mode	This option allows you to set the energy saving mode for the hard drive.	Disabled	Do not switch off the hard drive.
		Standby	Monitor goes to standby mode.
		Suspend	Hard drive goes to suspend mode.
Standby time out	Using this option, you can configure how long the system stays inactive until standby mode is executed.	Disabled	Disables this function.
		1 min, 2 min, 4 min, 8 min, 10 min, 20 min 30 min, 40 min;	Value set manually.

Table 316: 855GME (XTX) Power menu setting options

## Software • BIOS options

BIOS setting	Meaning	Setting options	Effect
Suspend Time Out	Using this option, you can configure how long the system stays inactive (all components but the CPU are shut off, if possible) before entering suspend mode.	Disabled	Disables this function.
		1 min, 2 min, 4 min, 8 min, 10 min, 20 min 30 min, 40 min, 50 min, 60 min;	Value set manually.
Keyboard & PS/2 Mouse	The monitoring of activities during power saving mode is determined here.	MONITOR	Keyboard or PS/2 mouse activities return the system to its normal state from a particular energy saving mode.
		IGNORE	Activities are ignored.
FDC/LPT/COM ports	The monitoring of activities during power saving mode is determined here.	MONITOR	Activities in the IRQ of specific connections or devices return the system to its normal state from power saving mode.
		IGNORE	Activities are ignored.
Primary master IDE	This option is used to determine whether or not BIOS monitors the activities of these components.	MONITOR	Activities in the IRQ of specific connections or devices return the system to its normal state from power saving mode.
		IGNORE	Activities are ignored.
Primary slave IDE	This option is used to determine whether or not BIOS monitors the activities of these components.	MONITOR	Activities in the IRQ of specific connections or devices return the system to its normal state from power saving mode.
		IGNORE	Activities are ignored.
Secondary master IDE	This option is used to determine whether or not BIOS monitors the activities of these components.	MONITOR	Activities in the IRQ of specific connections or devices return the system to its normal state from power saving mode.
		IGNORE	Activities are ignored.
Secondary slave IDE	This option is used to determine whether or not BIOS monitors the activities of these components.	MONITOR	Activities in the IRQ of specific connections or devices return the system to its normal state from power saving mode.
		IGNORE	Activities are ignored.
Power Button Mode	This function determines the function of the power button.	On/Off	Power button switches on/off.
		Suspend	Power button switches power saving mode on.
Resume On Ring	When the modem receives an incoming call, the PC is brought out of power saving mode.	Disabled	Disables this function.
		Enabled	Enables this function.
Resume on PME#	With this option, you can switch the PME wakeup function on or off.	Disabled	Disables this function.
		Enabled	Enables this function.
Resume On RTC Alarm	With this option, you can activate the alarm and enter the date and time for the system start.	Disabled	Disables this function.
		Enabled	Enables this function.
RTC alarm date (days)	Setting the date for the system start. <b>Information:</b> Setting with "+"/"-".	Every day	System starts daily.
		01-31	System start takes place on the manually set date.

Table 316: 855GME (XTX) Power menu setting options (Forts.)

BIOS setting	Meaning	Setting options	Effect
System Time	Setting the time for the system start.	Changing the time	Individually setting the system time in (hh:mm:ss) format. (hh:mm:ss).

Table 316: 855GME (XTX) Power menu setting options (Forts.)

### 1.3.9 Exit

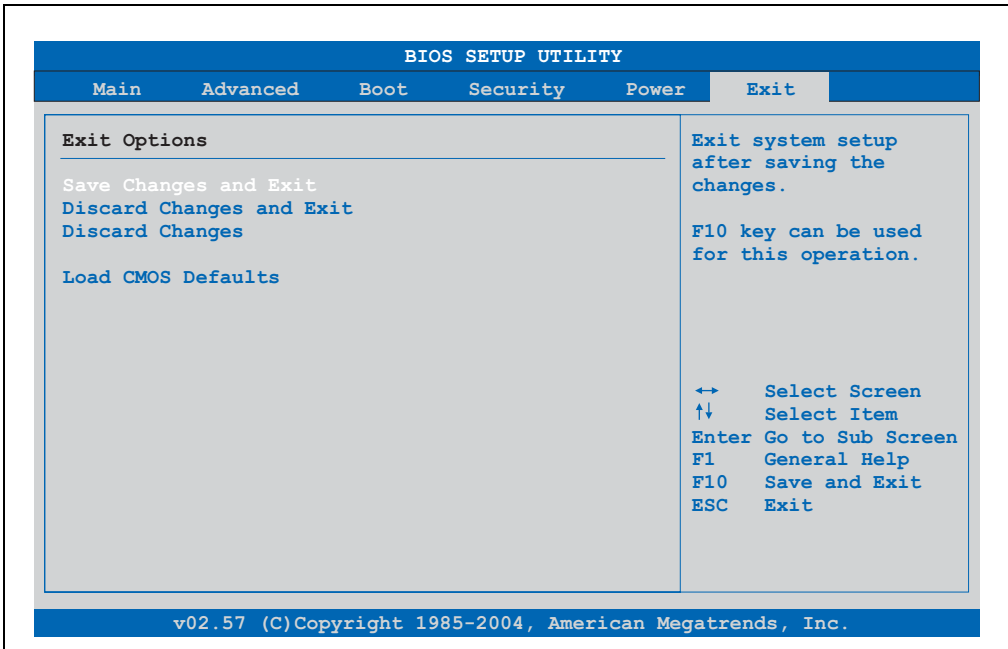

Figure 261: 855GME (XTX) - Exit menu

BIOS setting	Meaning	Setting options	Effect
Save Changes and Exit	BIOS setup is closed with this item. Changes made are saved in CMOS after confirmation, and the system is rebooted.	OK / Cancel	
Discard Changes and Exit	With this item you can close BIOS setup without saving the changes made. The system is then rebooted.	OK / Cancel	
Discard Changes	In the event that settings were made which the user can no longer remember, changes can be reset as long as they haven't been saved.	OK / Cancel	

Table 317: 855GME - (XTX) Exit menu - Setting options

## Software • BIOS options

BIOS setting	Meaning	Setting options	Effect
Load CMOS Defaults	This item loads the CMOS default values, which are defined by the DIP switch settings. These settings are loaded for all BIOS configurations.	OK / Cancel	

Table 317: 855GME - (XTX) Exit menu - Setting options (Forts.)

### 1.3.10 Profile overview - BIOS default settings - 855GME (XTX)

If the function "load setup defaults" is chosen in the main BIOS setup menu, or if exit is selected (or <F9> is pressed) in the individual setup screens, the following BIOS default settings are the optimized values that will be used.

DIP switch position see Section 1.6 "Location of the DIP switch in APC620 system units", on page 546).

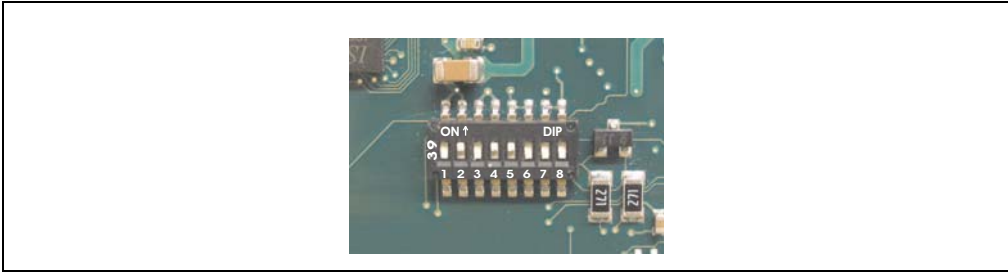

Figure 262: DIP switch on system unit

The first six DIP switches (1-6) are used to set the profiles. The rest (7,8) are reserved.

Number	Optimized for	DIP switch setting							
		1	2	3	4	5	6	7 <sup>1)</sup>	8 <sup>1)</sup>
Profile 0	Automation PC 620 system units 5PC600.SX01-00.	Off	Off	Off	Off	Off	Off	-	-
Profile 1	Reserved	On	Off	Off	Off	Off	Off	-	-
Profile 2	Automation PC 620 system units 5PC600.SX02-00, 5PC600.SX02-01, 5PC600.SF03-00, 5PC600.SX05-00 and 5PC600.SX05-01.	Off	On	Off	Off	Off	Off	-	-
Profile 3	Panel PC 700 system unit 5PC720.1043-00, 5PC720.1214-00, 5PC720.1505-00, 5PC720.1706-00, 5PC720.1906-00, 5PC781.1043-00, 5PC781.1505-00 and 5PC782.1043-00.	On	On	Off	Off	Off	Off	-	-
Profile 4	Panel PC 700 system unit 5PC720.1043-01, 5PC720.1214-01, 5PC720.1505-01 and 5PC720.1505-02.	Off	Off	On	Off	Off	Off	-	-
Profile 5	Automation PC 620 embedded system units 5PC600.SE00-00 und 5PC600.SE00-01	On	Off	On	Off	Off	Off	-	-

Table 318: 855GME (XTX) Profile overview

1) Reserved.

The following pages provide an overview of the BIOS default settings for the different DIP switch configurations. Settings highlighted in yellow are variations from the BIOS default profile (=profile 0).

[Personal settings](#)

If changes have been made to the BIOS defaults, they can be entered in the following tables for backup.

**Main**

Main	Profile 0	Profile 1	Profile 2	Profile 3	Profile 4	Profile 5	Personal settings
System Time	-	-	-	-	-	-	
System Date	-	-	-	-	-	-	
BIOS ID	-	-	-	-	-	-	
Processor	-	-	-	-	-	-	
CPU Frequency	-	-	-	-	-	-	
System Memory	-	-	-	-	-	-	
Product Revision	-	-	-	-	-	-	
Serial Number	-	-	-	-	-	-	
BC Firmware Rev.	-	-	-	-	-	-	
Mac address (ETH1)	-	-	-	-	-	-	
Boot Counter	-	-	-	-	-	-	
Running times	-	-	-	-	-	-	

Table 319: 855GME (XTX) Main profile settings overview

**Advanced**

[ACPI settings](#)

ACPI settings	Profile 0	Profile 1	Profile 2	Profile 3	Profile 4	Profile 5	Personal settings
ACPI Aware O/S	Yes	Yes	Yes	Yes	Yes	Yes	
ACPI 2.0 features	No	No	No	No	No	No	
ACPI APIC support	Enabled	Enabled	Enabled	Enabled	Enabled	Enabled	
Active Cooling Trip Point	Disabled	Disabled	Disabled	Disabled	Disabled	Disabled	
Passive Cooling Trip Point	Disabled	Disabled	Disabled	Disabled	Disabled	Disabled	
Critical Trip Point	105	105	105	105	105	105	
Watching ACPI	Shutdown	Shutdown	Shutdown	Shutdown	Shutdown	Shutdown	
GPE1 function	No function	No function	No function	No function	No function	No function	
GPE2 function	No function	No function	No function	No function	No function	No function	

Table 320: 855GME (XTX) - advanced profile setting options



[PCI Configuration](#)

PCI Configuration	Profile 0	Profile 1	Profile 2	Profile 3	Profile 4	Profile 5	Personal settings
Plug & Play O/S	Yes	No	Yes	Yes	Yes	Yes	
PCI latency timer	64	64	64	64	64	64	
Allocate IRQ to PCI VGA	Yes	Yes	Yes	Yes	Yes	Yes	
Allocate IRQ to SM-BUS HC	Yes	Yes	Yes	Yes	Yes	No	
PIRQ A (UHCH1+VGA)	Auto	Auto	Auto	Auto	Auto	Auto	
PIRQ B (INTD+AC97+SMBus)	Auto	Auto	Auto	Auto	Auto	7	
PIRQ C (INTC+UHCH3+NATA)	Auto	Auto	Auto	Auto	Auto	Auto	
PIRQ D (UHCH2)	Auto	Auto	Auto	Auto	Auto	Auto	
PIRQ E (Onboard ETH1 LAN)	Auto	Auto	Auto	Auto	Auto	Auto	
PIRQ F (INTA+ETH2 LAN)	Auto	Auto	Auto	Auto	Auto	5	
PIRQ G (INTB)	Auto	Auto	Auto	Auto	Auto	6	
PIRQ H (EHC1)	Auto	Auto	Auto	Auto	Auto	Auto	
1st Exclusive PCI IRQ	-	-	-	-	-	5	
2nd Exclusive PCI IRQ	-	-	-	-	-	6	
3rd exclusive PCI IRQ	-	-	-	-	-	7	

Table 321: 855GME - (XTX) PCI configuration - profile setting overview

[Graphics configuration](#)

Graphics configuration	Profile 0	Profile 1	Profile 2	Profile 3	Profile 4	Profile 5	Personal settings
Graphics engine 1	Enabled	Enabled	Enabled	Enabled	Enabled	Enabled	
Default flat panel	Auto-EDID	Auto-EDID	Auto-EDID	Auto-EDID	Auto-EDID	Auto-EDID	
Graphics driver EDID support	Disabled	Disabled	Disabled	Disabled	Disabled	Disabled	
Flat panel scaling	Stretched	Stretched	Stretched	Stretched	Stretched	Stretched	
Graphics engine 2	Enabled	Enabled	Enabled	Enabled	Enabled	Disabled	
Graphics engine	Graphics engine 1	Graphics engine 1	Graphics engine 1	Graphics engine 1	Graphics engine 1	Graphics engine 1	
Boot graphics device	Auto	Auto	Auto	Auto	Auto	Auto	
Graphics memory size	Enabled, 8MB	Enabled, 8MB	Enabled, 8MB	Enabled, 8MB	Enabled, 8MB	Enabled, 8MB	
Init. Graphic adapter priority	PCI/Int-VGA	PCI/Int-VGA	PCI/Int-VGA	PCI/Int-VGA	PCI/Int-VGA	PCI/Int-VGA	
Graphics aperture size	64MB	64MB	64MB	64MB	64MB	64MB	
DVI HotPlug persistence	Enabled	Enabled	Enabled	Enabled	Enabled	Enabled	

Table 322: 855GME - (XTX) Graphics configuration - profile setting overview

[CPU configuration](#)

CPU configuration	Profile 0	Profile 1	Profile 2	Profile 3	Profile 4	Profile 5	Personal settings
Manufacture:	-	-	-	-	-	-	
Brand string	-	-	-	-	-	-	
Frequency	-	-	-	-	-	-	
FSB speed	-	-	-	-	-	-	
L1 cache	-	-	-	-	-	-	
L2 cache	-	-	-	-	-	-	
Intel (R) SpeedStep (tm) tech	Automatic	Automatic	Automatic	Automatic	Automatic	Automatic	
Max. CPU frequency	-	-	-	-	-	-	

Table 323: 855GME - (XTX) CPU configuration - profile setting overview

[Chipset configuration](#)

Chipset configuration	Profile 0	Profile 1	Profile 2	Profile 3	Profile 4	Profile 5	Personal settings
IOAPIC	Disabled	Enabled	Disabled	Disabled	Disabled	Disabled	
APIC ACPI SCI IRQ	Disabled	Disabled	Disabled	Disabled	Disabled	Disabled	

Table 324: 855GME - (XTX) Chipset configuration - profile setting overview

[I/O interface configuration](#)

I/O interface configuration	Profile 0	Profile 1	Profile 2	Profile 3	Profile 4	Profile 5	Personal settings
OnBoard AC97 audio	Enabled	Enabled	Enabled	Enabled	Enabled	Disabled	
Onboard LAN (ETH1)	Enabled	Enabled	Enabled	Enabled	Enabled	Enabled	
Serial port 1 configuration	3F8/IRQ4	3F8/IRQ4	3F8/IRQ4	3F8/IRQ4	3F8/IRQ4	3F8/IRQ4	
Serial port 2 configuration	2F8/IRQ3	2F8/IRQ3	2F8/IRQ3	2F8/IRQ3	2F8/IRQ3	2F8/IRQ3	
Serial port 2 mode	Normal	Normal	Normal	Normal	Normal	Normal	
Parallel port address	378	378	378	378	378	378	

Table 325: 855GME (XTX) - I/O interface configuration - profile settings overview

[Clock Configuration](#)

Clock Configuration	Profile 0	Profile 1	Profile 2	Profile 3	Profile 4	Profile 5	Personal settings
Spread spectrum	Disabled	Disabled	Disabled	Disabled	Disabled	Disabled	
Unused PCI slot clocks	Enabled	Enabled	Enabled	Enabled	Enabled	Enabled	

Table 326: 855GME - (XTX) Clock configuration - profile setting overview

IDE Configuration

IDE Configuration	Profile 0	Profile 1	Profile 2	Profile 3	Profile 4	Profile 5	Personal settings
OnBoard PCI IDE controller	Primary	Both	Both	Primary	Both	Primary	
Onboard PCI IDE operate mode	Legacy mode	Legacy mode	Legacy mode	Legacy mode	Legacy mode	Legacy mode	
Hard disk write protect	Disabled	Disabled	Disabled	Disabled	Disabled	Disabled	
IDE Detect Time Out (Sec)	35	35	35	35	35	35	
ATA(P)I 80 pin cable detection	Host & device	Host & device	Host & device	Host & device	Host & device	Host & device	
<b>Primary IDE Master</b>							
Type	Auto	Auto	Auto	Auto	Auto	Auto	
LBA/Large Mode	Auto	Auto	Auto	Auto	Auto	Auto	
Block (Multi-Sector Transfer)	Auto	Auto	Auto	Auto	Auto	Auto	
PIO Mode	Auto	Auto	Auto	Auto	Auto	Auto	
DMA Mode	Auto	Auto	Auto	Auto	Auto	Auto	
S.M.A.R.T.	Auto	Auto	Auto	Auto	Auto	Auto	
32Bit data transfer	Enabled	Enabled	Enabled	Enabled	Enabled	Enabled	
<b>Primary IDE slave</b>							
Type	Auto	Auto	Auto	Auto	Auto	Auto	
LBA/Large Mode	Auto	Auto	Auto	Auto	Auto	Auto	
Block (Multi-Sector Transfer)	Auto	Auto	Auto	Auto	Auto	Auto	
PIO Mode	Auto	Auto	Auto	Auto	Auto	Auto	
DMA Mode	Auto	Auto	Auto	Auto	Auto	Auto	
S.M.A.R.T.	Auto	Auto	Auto	Auto	Auto	Auto	
32Bit data transfer	Enabled	Enabled	Enabled	Enabled	Enabled	Enabled	
<b>Secondary IDE Master</b>							
Type	Auto	Auto	Auto	Auto	Auto	Auto	
LBA/Large Mode	Auto	Auto	Auto	Auto	Auto	Auto	
Block (Multi-Sector Transfer)	Auto	Auto	Auto	Auto	Auto	Auto	
PIO Mode	Auto	Auto	Auto	Auto	Auto	Auto	
DMA Mode	Auto	Auto	Auto	Auto	Auto	Auto	
S.M.A.R.T.	Auto	Auto	Auto	Auto	Auto	Auto	
32Bit data transfer	Enabled	Enabled	Enabled	Enabled	Enabled	Enabled	
<b>Secondary IDE slave</b>							
Type	Auto	Auto	Auto	Auto	Auto	Auto	
LBA/Large Mode	Auto	Auto	Auto	Auto	Auto	Auto	

Table 327: 855GME - (XTX) IDE configuration - profile setting overview

## Software • BIOS options

Secondary IDE slave	Profile 0	Profile 1	Profile 2	Profile 3	Profile 4	Profile 5	Personal settings
Block (Multi-Sector Transfer)	Auto	Auto	Auto	Auto	Auto	Auto	
PIO Mode	Auto	Auto	Auto	Auto	Auto	Auto	
DMA Mode	Auto	Auto	Auto	Auto	Auto	Auto	
S.M.A.R.T.	Auto	Auto	Auto	Auto	Auto	Auto	
32Bit data transfer	Enabled	Enabled	Enabled	Enabled	Enabled	Enabled	

Table 327: 855GME - (XTX) IDE configuration - profile setting overview

## [USB configuration](#)

USB configuration	Profile 0	Profile 1	Profile 2	Profile 3	Profile 4	Profile 5	Personal settings
USB Function	4 USB Ports	4 USB Ports	4 USB Ports	4 USB Ports	4 USB Ports	6 USB Ports	
Legacy USB Support	Enabled	Enabled	Enabled	Enabled	Enabled	Enabled	
USB Keyboard Legacy Support	Enabled	Enabled	Enabled	Enabled	Enabled	Enabled	
USB Mouse Legacy Support	Disabled	Disabled	Disabled	Disabled	Disabled	Disabled	
USB Storage Device Support	Enabled	Enabled	Enabled	Enabled	Enabled	Enabled	
Port 64/60 Emulation	Disabled	Disabled	Disabled	Disabled	Disabled	Disabled	
USB 2.0 Controller	Enabled	Enabled	Enabled	Enabled	Enabled	Enabled	
USB 2.0 Controller Mode	HiSpeed	HiSpeed	HiSpeed	HiSpeed	HiSpeed	HiSpeed	
BIOS EHCI Hand-Off	Disabled	Disabled	Disabled	Disabled	Disabled	Disabled	
USB Beep Message	Enabled	Enabled	Enabled	Enabled	Enabled	Enabled	
USB Stick Default Emulation	Hard Disk	Hard Disk	Hard Disk	Hard Disk	Hard Disk	Hard Disk	
USB Mass Storage Reset Delay	20 Sec	20 Sec	20 Sec	20 Sec	20 Sec	20 Sec	

Table 328: 855GME - (XTX) USB configuration - profile setting overview

## [Keyboard/mouse configuration](#)

Keyboard/mouse configuration	Profile 0	Profile 1	Profile 2	Profile 3	Profile 4	Profile 5	Personal settings
Boot-up Num-lock	On	On	On	On	On	On	
Typematic rate	Fast	Fast	Fast	Fast	Fast	Fast	
PS/2 mouse support	Disabled	Enabled	Disabled	Disabled	Disabled	Disabled	

Table 329: 855GME (XTX) - keyboard/mouse configuration - profile setting overview

[Remote access configuration](#)

Remote access configuration	Profile 0	Profile 1	Profile 2	Profile 3	Profile 4	Profile 5	Personal settings
Remote access	Disabled	Disabled	Disabled	Disabled	Disabled	Disabled	
Serial port BIOS update	Disabled	Disabled	Disabled	Disabled	Disabled	Disabled	

Table 330: 855GME - (XTX) remote access configuration - profile setting overview

[CPU board monitor](#)

CPU board monitor	Profile 0	Profile 1	Profile 2	Profile 3	Profile 4	Profile 5	Personal settings
Board temperature	-	-	-	-	-	-	
CPU temperature	-	-	-	-	-	-	
VcoreA	-	-	-	-	-	-	
VcoreB	-	-	-	-	-	-	
+3.3Vin	-	-	-	-	-	-	
+5Vin	-	-	-	-	-	-	
+5VSB	-	-	-	-	-	-	
VBAT	-	-	-	-	-	-	

Table 331: 855GME (XTX) - CPU board monitor - profile setting overview

[Main Board/Panel Features](#)

Main Board/Panel Features	Profile 0	Profile 1	Profile 2	Profile 3	Profile 4	Profile 5	Personal settings
<b>Panel control</b>							
Select panel number	-	-	-	-	-	-	
Version	-	-	-	-	-	-	
Brightness	100	100	100	100	100	100	
Temperature		-	-	-	-	-	
Fan speed	-	-	-	-	-	-	
Keys/LEDs	-	-	-	-	-	-	
<b>Main board monitor</b>							
CMOS battery	-	-	-	-	-	-	
I/O	-	-	-	-	-	-	
Power supply	-	-	-	-	-	-	
Slide-in drive 1	-	-	-	-	-	-	
Slide-in drive 2	-	-	-	-	-	-	
Case 1	-	-	-	-	-	-	
Case 2	-	-	-	-	-	-	

Table 332: 855GME (XTX) - baseboard/panel features -profile setting overview

## Software • BIOS options

Main board monitor	Profile 0	Profile 1	Profile 2	Profile 3	Profile 4	Profile 5	Personal settings
Case 3	-	-	-	-	-	-	
Case 4	-	-	-	-	-	-	
CPU	-	-	-	-	-	-	
<b>Legacy devices</b>							
COM C	Disabled	Enabled	Disabled	Enabled	Enabled	Disabled	
Base I/O address	-	3E8h	-	3E8h	3E8h	-	
Interrupt	-	11	-	11	11	-	
COM D	Disabled	Disabled	Disabled	Disabled	Disabled	Disabled	
Base I/O address							
Interrupt							
COM E	Disabled	Disabled	Disabled	Disabled	Disabled	Disabled	
Base I/O address							
Interrupt							
CAN	Disabled	Disabled	Disabled	Disabled	Disabled	Disabled	
Base I/O address							
Interrupt							
ETH2 LAN controller	Enabled	Enabled	Enabled	Enabled	Enabled	Disabled	
ETH2 MAC Address	-	-	-	-	-	-	
<b>Versions</b>							
BIOS	-	-	-	-	-	-	
MTCX PX32	-	-	-	-	-	-	
MTCX FPGA	-	-	-	-	-	-	
Optimized ID	-	-	-	-	-	-	
Device ID	-	-	-	-	-	-	
Compatibility ID	-	-	-	-	-	-	
Serial number	-	-	-	-	-	-	
Product name	-	-	-	-	-	-	
User serial OD	-	-	-	-	-	-	

Table 332: 855GME (XTX) - baseboard/panel features -profile setting overview

Boot

Boot	Profile 0	Profile 1	Profile 2	Profile 3	Profile 4	Profile 5	Personal settings
Boot Priority Selection	Type Based	Type Based	Type Based	Type Based	Type Based	Type Based	
1st Boot Device	Primary master	Onboard LAN	Primary master	Primary master	Primary master	Primary master	
2nd Boot Device	Primary slave	Primary master	Primary slave	Primary slave	Primary slave	Primary slave	
3rd Boot Device	USB floppy	Primary slave	USB floppy	USB floppy	USB floppy	USB floppy	
4th Boot Device	USB removable device	USB floppy	USB removable device	USB removable device	USB removable device	USB removable device	
5th Boot Device	USB hard disk	USB removable device	USB hard disk	USB hard disk	USB hard disk	USB hard disk	
6th Boot Device	USB CDROM	USB CDROM	USB CDROM	USB CDROM	USB CDROM	USB CDROM	
7th Boot Device	Disabled	Secondary master	Secondary master	Disabled	Secondary master	Disabled	
8th Boot Device	Disabled	Disabled	Secondary slave	Disabled	Secondary slave	Disabled	
Quick Boot	Enabled	Enabled	Enabled	Enabled	Enabled	Enabled	
Quiet Boot	Disabled	Disabled	Disabled	Disabled	Disabled	Disabled	
Automatic Boot List Retry	Disabled	Disabled	Disabled	Disabled	Disabled	Disabled	
Add-On ROM Display Mode	Keep Current	Keep Current	Keep Current	Keep Current	Keep Current	Keep Current	
Halt On Error	Disabled	Disabled	Disabled	Disabled	Disabled	Disabled	
Hit 'DEL' Message Display	Enabled	Enabled	Enabled	Enabled	Enabled	Enabled	
Interrupt 19 Capture	Disabled	Disabled	Disabled	Disabled	Disabled	Disabled	
PXE boot to LAN (ETH1)	Disabled	Enabled	Disabled	Disabled	Disabled	Disabled	
Power Loss Control	Turn On	Turn On	Turn On	Turn On	Turn On	Turn On	

Table 333: 855GME (XTX) - boot - profile setting overview

Security

Security	Profile 0	Profile 1	Profile 2	Profile 3	Profile 4	Profile 5	Personal settings
Supervisor Password	-	-	-	-	-	-	
User Password	-	-	-	-	-	-	
Change Supervisor Password	-	-	-	-	-	-	
Change User Password	-	-	-	-	-	-	
Boot Sector Virus Protection	Disabled	Disabled	Disabled	Disabled	Disabled	Disabled	
Hard disk security user password	-	-	-	-	-	-	
Hard disk security master password	-	-	-	-	-	-	

Table 334: 855GME (XTX) - security - profile setting options

## Software • BIOS options

END-key loads CMOS default	Yes	Yes	Yes	Yes	Yes	Yes	
----------------------------	-----	-----	-----	-----	-----	-----	--

Table 334: 855GME (XTX) - security - profile setting options

## Power

Power	Profile 0	Profile 1	Profile 2	Profile 3	Profile 4	Profile 5	Personal settings
Power Management/APM	Enabled	Enabled	Enabled	Enabled	Enabled	Enabled	
Video Power Down Mode	Suspend	Suspend	Suspend	Suspend	Suspend	Suspend	
Hard Disk Power Down Mode	Suspend	Suspend	Suspend	Suspend	Suspend	Suspend	
Standby time out	Disabled	Disabled	Disabled	Disabled	Disabled	Disabled	
Suspend Time Out	Disabled	Disabled	Disabled	Disabled	Disabled	Disabled	
Keyboard & PS/2 Mouse	MONITOR	MONITOR	MONITOR	MONITOR	MONITOR	MONITOR	
FDC/LPT/COM ports	MONITOR	MONITOR	MONITOR	MONITOR	MONITOR	MONITOR	
Primary master IDE	MONITOR	MONITOR	MONITOR	MONITOR	MONITOR	MONITOR	
Primary slave IDE	MONITOR	MONITOR	MONITOR	MONITOR	MONITOR	MONITOR	
Secondary master IDE	MONITOR	MONITOR	MONITOR	MONITOR	MONITOR	MONITOR	
Secondary slave IDE	MONITOR	MONITOR	MONITOR	MONITOR	MONITOR	MONITOR	
Power Button Mode	On/Off	On/Off	On/Off	On/Off	On/Off	On/Off	
Resume On Ring	Disabled	Disabled	Disabled	Disabled	Disabled	Disabled	
Resume on PME#	Disabled	Disabled	Disabled	Disabled	Disabled	Disabled	
Resume On RTC Alarm	Disabled	Disabled	Disabled	Disabled	Disabled	Disabled	

Table 335: 855GME (XTX) - power - profile setting overview



## 1.4 BIOS Error signals (beep codes)

While the Automation PC 620 is booting, the following messages and errors can occur with BIOS. These errors are signaled by different beeping codes.

### 1.4.1 BIOS 815E (ETX) and 855GME (ETX)

Beeping code	Meaning	Necessary user action
1	Everything OK	-
1-2	1x long 2x short - checksum error in the ROM	BIOS updates
1-2-2-3	BIOS checksum error	BIOS updates.
1-3-1-1	Test DRAM refresh, DRAM module is not set properly.	Send industrial PC to B&R for checking.
1-3-1-3	Test 8742 keyboard controller, self test of the keyboard controller failed.	Send industrial PC to B&R for checking.
1-3-4-1	RAM error at address xxxx	Send industrial PC to B&R for checking.
1-3-4-3	RAM error at data bit xxxx, at the lowest bit of the memory bus	Send industrial PC to B&R for checking.
1-4-1-1	RAM error at data bit xxxx, at the highest bit of the memory bus	Send industrial PC to B&R for checking.
2-1-2-3	ROM copyright has an error	Send industrial PC to B&R for checking.
2-2-3-1	Unexpected interrupt	Check interrupt settings in BIOS.

Table 336: BIOS post code messages BIOS 815E (ETX) and 855GME (ETX)

### 1.4.2 BIOS 855GME (XTX)

Beeping code	Meaning	Necessary user action
1 x short	Memory refresh failed.	Load BIOS defaults. In the event that the error persists, send industrial PC to B&R for testing.
2 x short	Parity error: POST error (error in one of the hardware testing procedures)	Check the placement of the inserted card. In the event that the error persists, send industrial PC to B&R for testing.
3 x short	Base 64 KB memory failure: Basic memory defect, RAM error within the initial 64 KB.	Send industrial PC to B&R for checking.
4 x short	Timer not operational: System timer.	Send industrial PC to B&R for checking.
5 x short	Processor error: Processor defect.	Send industrial PC to B&R for checking.
6 x short	8042 gate A20 failure: Keyboard controller defect (block 8042/ A20 gate). Processor cannot switch to protected mode.	Send industrial PC to B&R for checking.
7 x short	Processor exception interrupt error: Virtual mode exception error (CPU generated an interrupt error).	Send industrial PC to B&R for checking.
8 x short	Display memory read/write error: Video memory not accessible; graphic card defect or not built in (no fatal error).	Check inserted graphic card position and eventually exchange. In the event that the error persists, send industrial PC to B&R for testing.
9 x short	ROM-checksum error: ROM-BIOS-checksum incorrect, EPROM, EEPROM or Flash-ROM component defect, BIOS defect or incorrectly updated.	Send industrial PC to B&R for checking.

Table 337: BIOS post code messages BIOS 855GME (XTX)

Beeping code	Meaning	Necessary user action
10 x short	CMOS shutdown register read/write error: CMOS cannot be read/written.	Send industrial PC to B&R for checking.
11 x short	Cache Error / external Cache bad: L2 - Cache on the mainboard is defected.	Send industrial PC to B&R for checking.

Table 337: BIOS post code messages BIOS 855GME (XTX) (Forts.)

## 1.5 Distribution of resources

### 1.5.1 RAM address assignment

RAM address	Resource
000000h - 0003FFh	Interrupt vectors
000400h - 09FFFFh	MS-DOS program area
0A0000h - 0AFFFFh	VGA graphics
0B8000h - 0BBFFFh	VGA Text Mode
0C0000h - 0CFFFFh	VGA BIOS
0D0000h - 0DFFFFh	Available.
0E0000h - 0EBFFFh	USB
0E4000h - 0FFFFFFh	System BIOS (Phoenix)
100000h -	SDRAM

Table 338: RAM address assignment

### 1.5.2 DMA channel assignment

DMA channel	Resource
0	Available
1	Available
2	Floppy disk drive (FDC)
3	LPT (ECP) <sup>1)</sup>
4	Reserved
5	Available
6	Available
7	Available

Table 339: DMA channel assignment

1) Available if LPT is not being operated in ECP mode.

## 1.5.3 I/O address assignment

I/O address	Resource
000h - 01Fh	DMA controller 1
020h - 03Fh	Interrupt controller 1
040h - 05Fh	Timer
060h - 06Fh	Keyboard controller
070h - 071h	Real-time clock, NMI mask, CMOS
080h	Debug port (POST code)
081h - 09Fh	Page register - DMA controller
0A0h - 0BFh	Interrupt controller 2
0C0h - 0DFh	DMA controller 2
0F0h - 0FFh	FPU
170h - 177h	Secondary Hard Disk IDE channel
1F0h - 1F7h	Primary Hard Disk IDE channel
238h - 023F	COM5
278h - 27Fh	Hardware Security Key (LPT2)
2E8h - 2EFh	COM4
2F8h - 2FFh	COM2
376h - 376h	Secondary Hard Disk IDE channel
378h - 37Fh	LPT1 (printer connection)
384h - 385h	CAN controller
3B0h - 3BBh	VGA controller
3BCh - 3BFh	LPT3
3C0h - 3DFh	VGA controller
3E8h - 3EFh	COM3
3F6h - 3F6h	Primary Hard Disk IDE channel
3F0h - 3F7h	FDD controller
3F8h - 3FFh	COM1
LPT1 + 400h	ECP Port, LPT+400h
CF8h - CFBh	PCI config address register
CFCh - CFFh	PCI config data register
4100h - 417Fh	MTCX
FF00h - FF07h	IDE bus master register

Table 340: I/O address assignment

1.5.4 Interrupt assignments in PCI mode

IRQ	0	1	2	3	4	5	6	7	8	9	10	11	12	13	14	15	NMI	NONE
System timer	●																	
Keyboard		●																
IRQ cascade			●															
COM1 (Serial port A)				○	●													
COM2 (Serial port B)				●	○													
LPT1				○	○	○	○	○		○	○	○	○		○			●
LPT2				○	○	○	○	○		○	○	○	○		○			●
LPT3				○	○	○	○	○		○	○	○	○		○			●
PS/2 mouse													●					
ACPI <sup>1)</sup>										●								
FDD							●											○
Real-time clock									●									
Coprocessor (FPU)														●				
Primary IDE channel															●			
Secondary IDE channel																●		
B&R	COM3 (COM C)			○	○	○		○			○	○	○					●
	COM4 (COM D)			○	○	○		○			○	○	○					●
	COM5 (COM E)			○	○	○		○			○	○	○					●
	CAN										○						○	●

Table 341: IRQ interrupt assignments in PCI mode

1) Advanced Configuration and Power Interface.

- ... Default setting
- ... Optional setting

### 1.5.5 Interrupt assignments in APIC mode

A total of 23 IRQs are available in the APIC mode (**A**dvanced **P**rogrammable **I**nterrupt **C**ontroller). The activation of this option is only effective if it takes place before the operating system (Windows XP) is activated. There are then 23 IRQs available.

IRQ	0	1	2	3	4	5	6	7	8	9	10	11	12	13	14	15	16	17	18	19	20	21	22	23	NMI	NONE
System timer	●																									
Keyboard		●																								
IRQ cascade			●																							
COM1 (Serial port A)				○	●																					
COM2 (Serial port B)				●	○																					
LPT1				○	○	○	○	○		○	○	○	○		○											●
LPT2				○	○	○	○	○		○	○	○	○		○											●
LPT3				○	○	○	○	○		○	○	○	○		○											●
PS/2 mouse													●													
ACPI <sup>1)</sup>										●																
FDD							●																			○
Real-time clock								●																		
Coprocessor (FPU)														●												
Primary IDE channel															●											
Secondary IDE channel																●										
B&R	COM3 (COM C)			○	○	○		○			○	○	○													●
	COM4 (COM D)			○	○	○		○			○	○	○													●
	COM5 (COM E)			○	○	○		○			○	○	○													●
	CAN										○														○	●
PIRQ A <sup>2)</sup>																●										
PIRQ B <sup>3)</sup>																		●								
PIRQ C <sup>4)</sup>																			●							
PIRQ D <sup>5)</sup>																				●						
PIRQ E <sup>6)</sup>																					●					
PIRQ F																						●				
PIRQ G																							●			

Table 342: IRQ interrupt assignments in APIC mode

IRQ	0	1	2	3	4	5	6	7	8	9	10	11	12	13	14	15	16	17	18	19	20	21	22	23	NMI	NONE
PIRQ H <sup>7)</sup>																								●		

Table 342: IRQ interrupt assignments in APIC mode (Forts.)

- 1) Advanced Configuration and Power Interface.
- 2) PIRQ A: for PCI; PCI IRQ line 1 + USB UHCI controller #1 + graphics controller.
- 3) PIRQ B: for PCI; PCI IRQ line 2 + AC97 Audio controller + SM Bus.
- 4) PIRQ C: for PCI; PCI RIQ line 3 + USB UHCI controller #3 + native IDE.
- 5) PIRQ D: for PCI; PCI IRQ line 4 + USB UHCI controller #2.
- 6) PIRQ E: LAN controller.
- 7) PIRQ H: USB EHCI controller.

- ... Default setting
- ... Optional setting

The PCI resources are assigned to fixed IRQ lines when the APIC function is enabled. The following image shows the connections to the individual PCI slots.

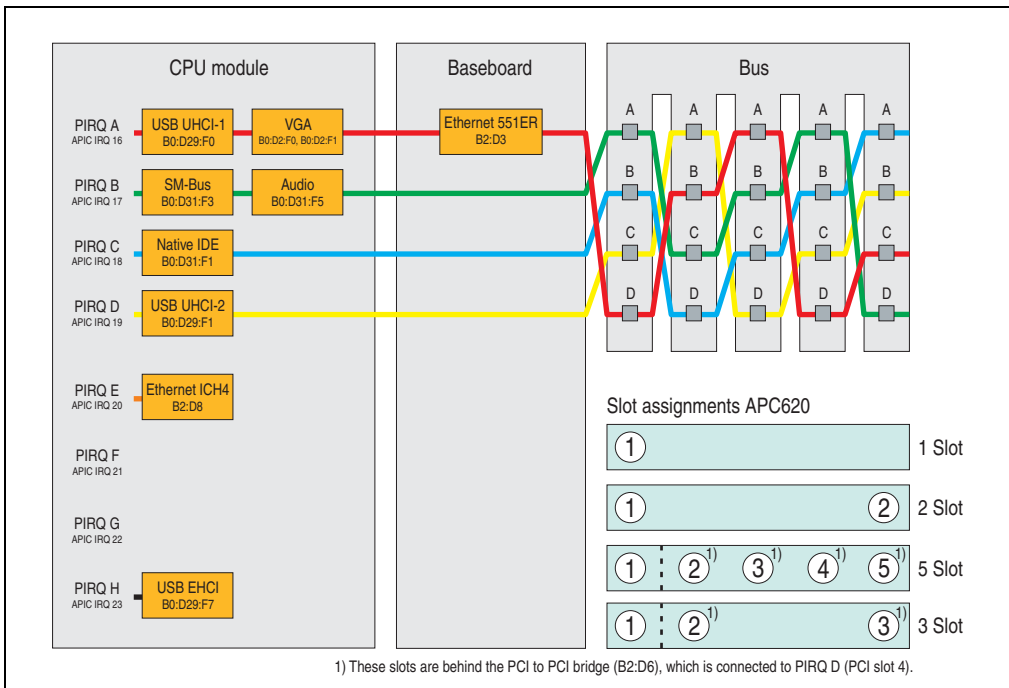

Figure 263: PCI routing with activated APIC CPU boards 815E (ETX), 855GME (ETX)

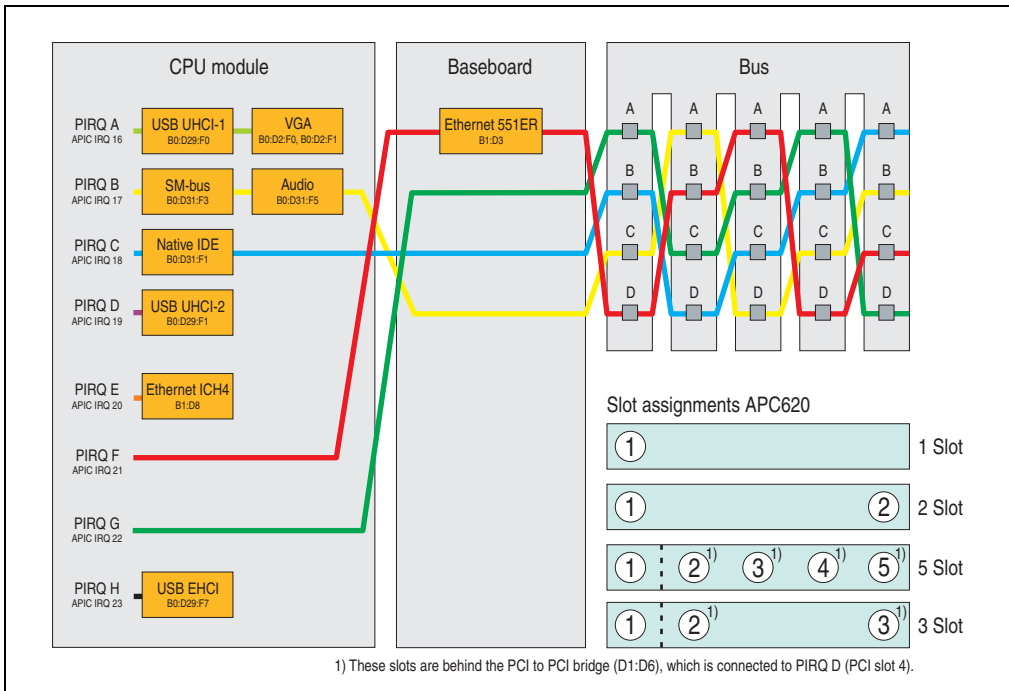

Figure 264: PCI routing with activated APIC CPU boards 855GME (XTX)



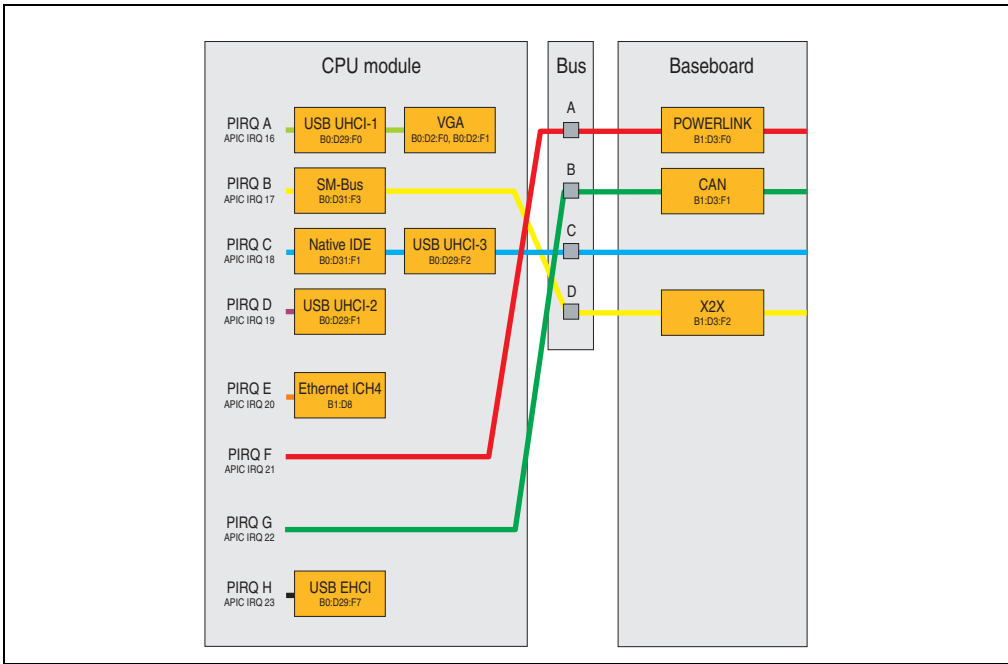

Figure 265: PCI routing with activated APIC CPU boards 855GME (XTX) on the APC620e

### 1.5.6 Inter-IC (I<sup>2</sup>C) bus

I <sup>2</sup> C address	Resource	Note
A0h	EEPROM	EEPROM for CMOS data - cannot be used
B0h	Reserved	Cannot be used
58h	Reserved	Cannot be used

Table 343: Inter-IC (I<sup>2</sup>C) bus resources

### 1.5.7 System Management (SM) bus

SM Bus address	SM device	Note
12h	SMART_CHARGER	
14h	SMART_SELECTOR	
16h	SMART_BATTERY	
D2h	Clock Generator	

Table 344: Inter-IC (I<sup>2</sup>C) bus resources

## 1.6 Location of the DIP switch in APC620 system units

### Warning!

The following procedure is only permitted with the power switched off and the supply voltage disconnected!

To get to the DIP switches, it is necessary to open the front cover. To do this, loosen the five Torx screws (T10) marked and pull the cover off towards the front. Then the DIP switches can be accessed at the location marked in yellow. The setting can now be made using a pointed object. If the system has a slide-in drive, it must be removed first to get to the DIP switches.

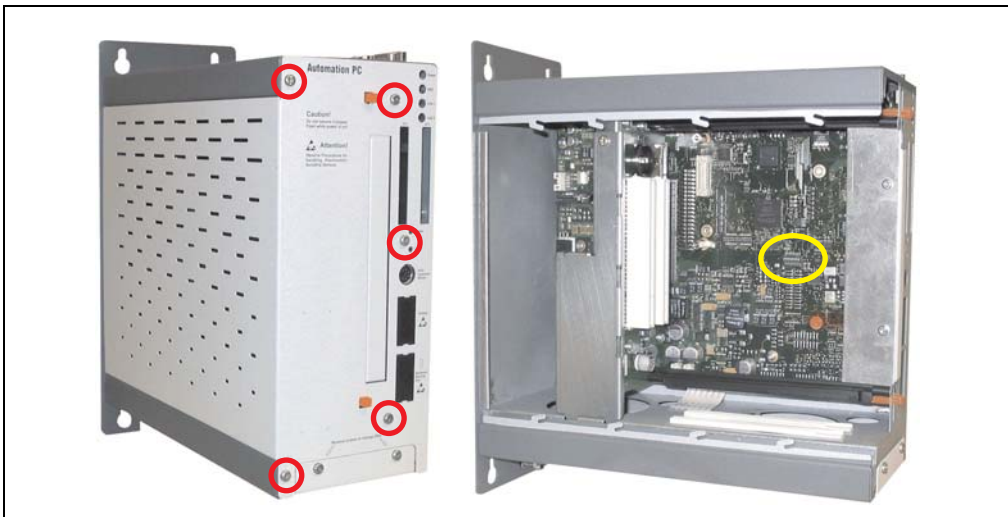

Figure 266: Location of DIP switch

## 2. Upgrade information

### 2.1 BIOS upgrade

#### Warning!

The upgrade procedures described in the following pages must be carried out for all APC620 systems with software versions lower than those listed in the following table.

CPU board software	815E (ETX)	855GME (ETX)
BIOS	< R017	< R007
MTCX PX32 firmware	< V1.19	< V1.19
MTCX FPGA firmware	< V1.06	< V1.06

Table 345: CPU board software versions

Automation Panel Link	Transceiver (5DLSDL.1000-01)	Receiver (5DLSDL.1000-00)
SDLR version	< V0.03	< V0.03

Table 346: Automation panel link software versions

An upgrade might be necessary for the following reason:

- To update implemented functions or to add newly implemented functions or components to the BIOS setup (information about changes can be found in the Readme files of the BIOS upgrade).

#### 2.1.1 What information do I need?

#### Information:

Individually saved BIOS settings are deleted when upgrading the BIOS.

Before starting the upgrade, you should know the CPU board type (815E or 855GME) and the various software versions.

### Which CPU board do I have?

After switching on the APC620, the installed CPU board can be identified by the letters "B", "C" or „E“.

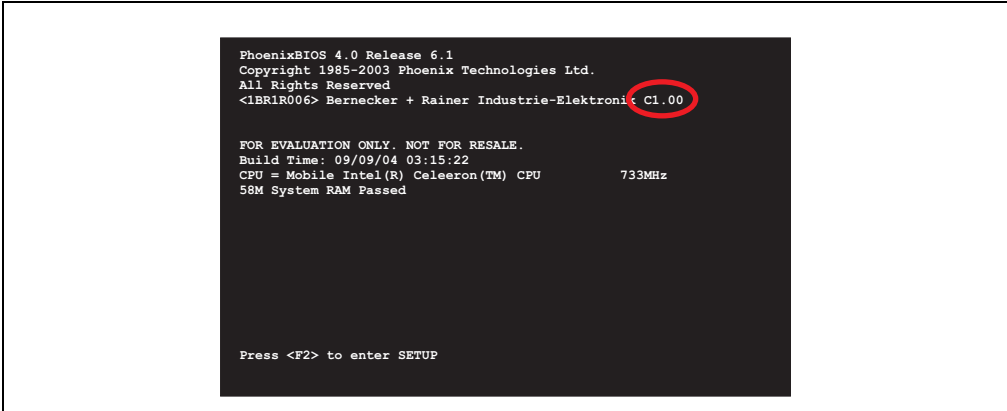

Figure 267: Differentiating between 815E and 855GME CPU boards

Letter	CPU board	Model number
B	855GME (ETX)	5PC600.E855-00 5PC600.E855-01 5PC600.E855-02 5PC600.E855-03 5PC600.E855-04 5PC600.E855-05
C	815E (ETX)	5PC600.E815-00 5PC600.E815-02 5PC600.E815-03
E	855GME (XTX)	5PC600.X855-00 5PC600.X855-01 5PC600.X855-02 5PC600.X855-03 5PC600.X855-04 5PC600.X855-05

Table 347: Differentiating between 815E (ETX) and 855GME (ETX / XTX) CPU boards

Which BIOS version and firmware are already installed on the APC620?

This information can be found on the same BIOS setup page for both the 815E (ETX) and the 855GME (ETX / XTX)CPU boards:

- After switching on the APC620, you can get to the BIOS Setup by pressing "F2" or "DEL".
- From the BIOS main menu "advanced" (top), select "baseboard/panel features" (bottom):

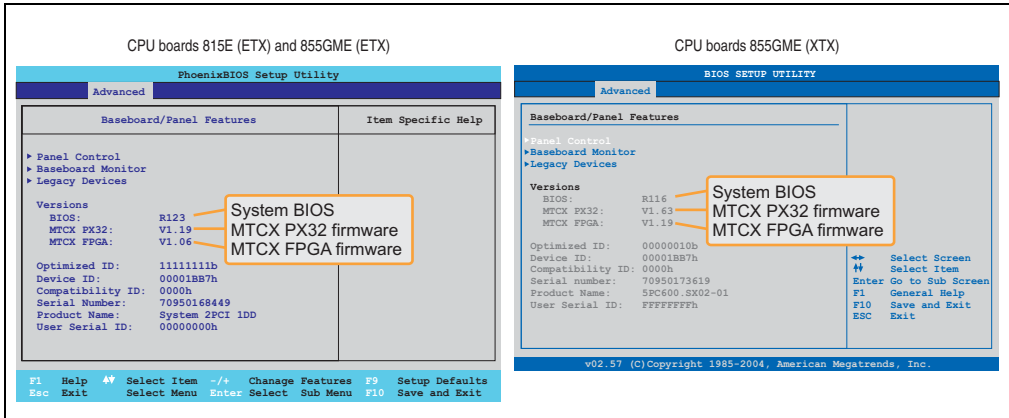

Figure 268: Software versions



## 2.1.2 Upgrade BIOS for 815E (ETX)

- Download and unzip the zip file from the B&R homepage.
- Create bootable media.

### Information:

In MS-DOS, Win95 and Win98, a blank HD disk can be made bootable using the command line command "sys a:" or "format a: /s".

Information concerning creating a bootable diskette in Windows XP can be found on page 558.

- Copy the contents of the \*.zip file to the bootable media. If the B&R upgrade was already added when the bootable media was created using the B&R Embedded OS Installer, then this step is not necessary.
- Connect the bootable media to the APC620 and reboot the device.
- The following boot menu will be shown after startup:

1. Upgrade PHOENIX BIOS for i815E (5PC600.E815-xx)
2. Exit to MS-DOS

Concerning point 1:

BIOS is automatically upgraded (default after 5 seconds).

Concerning point 2:

Returns to the shell (MS-DOS).

- The system must be rebooted after a successful upgrade.

### Information:

When the system has rebooted, setup default values must be reloaded after the message, "System CMOS checksum bad" (press F1 or select "load setup defaults" in the BIOS setup "exit" menu). Afterwards, the time and date must be set again.

### 2.1.3 Upgrade BIOS for 855GME (ETX)

- Download and unzip the zip file from the B&R homepage.
- Create bootable media.

#### Information:

In MS-DOS, Win95 and Win98, a blank HD disk can be made bootable using the command line command "sys a:" or "format a: /s".

Information concerning creating a bootable diskette in Windows XP can be found on page 558.

Information concerning creating a USB flash drive for a B&R upgrade can be found on page 560.

Information concerning creating a CompactFlash card for a B&R upgrade can be found on page 562.

- Copy the contents of the \*.zip file to the bootable media. If the B&R upgrade was already added when the bootable media was created using the B&R Embedded OS Installer, then this step is not necessary.
  - Connect the bootable media to the APC620 and reboot the device.
  - The following boot menu will be shown after startup:
1. Upgrade PHOENIX BIOS for i855GME (5PC600.E855-xx)
  2. Exit to MS-DOS

Concerning point 1:  
BIOS is automatically upgraded (default after 5 seconds).

Concerning point 2:  
Returns to the shell (MS-DOS).

- The system must be rebooted after a successful upgrade.

#### Information:

When the system has rebooted, setup default values must be reloaded after the message, "System CMOS checksum bad" (press F1 or select "load setup defaults" in the BIOS setup "exit" menu).

Starting with BIOS version V1.15, the time and date no longer has to be set again after a BIOS upgrade (stays the same).



## 2.1.4 Upgrade BIOS for 855GME (XTX)

- Download and unzip the zip file from the B&R homepage.
- Create bootable media.

### Information:

In MS-DOS, Win95 and Win98, a blank HD disk can be made bootable using the command line command "sys a:" or "format a: /s".

Information concerning creating a bootable diskette in Windows XP can be found on page 558.

Information concerning creating a USB flash drive for a B&R upgrade can be found on page 560.

Information concerning creating a CompactFlash card for a B&R upgrade can be found on page 562.

- Copy the contents of the \*.zip file to the bootable media. If the B&R upgrade was already added when the bootable media was created using the B&R Embedded OS Installer, then this step is not necessary.
- Connect the bootable media to the APC620 and reboot the device.
- The following boot menu will be shown after startup:

1. Upgrade PHOENIX BIOS for i855GME (5PC600.X855-xx)
2. Exit to MS-DOS

Concerning point 1:

BIOS is automatically upgraded (default after 5 seconds).

Concerning point 2:

Returns to the shell (MS-DOS).

- The system must be rebooted after a successful upgrade.

### Information:

After the system restart, the warning "CMOS checksum BAD" is displayed, but BIOS boots through it. The setup can be opened using the "Del" key and the setup defaults must be loaded again and saved using either the "F9" key or the menu item "Exit" - "Load CMOS defaults".

### 2.1.5 Windows XP Embedded and BIOS upgrade

If the following error message appears after upgrading BIOS:

```
"Copy Error"
```

```
"Setup cannot copy the file Audio3d.dll"
```

then the audio driver must be reinstalled.

To do this, use the audio driver from the B&R Homepage ([www.br-automation.com](http://www.br-automation.com)).

During the installation of the audio driver, the following 2 files must be manually selected from the following directories.

```
ksuser.dll in the directory ...\\Windows\\system32
```

```
ks.sys in the directory ...\\Windows\\system32\\drivers
```

This applies to 815E and 855ME CPU boards.

In order to be able to set up all possible resolutions when using an 815E CPU board, the graphics driver must be reinstalled (see 5.2.1 "Installing the graphics driver for 815E (ETX) CPU boards").

## 2.2 Upgrade the firmware

With the APC620 / Panel PC firmware upgrade (MTCX, SDLR, SDLT), the firmware of a number of controllers (MTCX, SDLR, SDLT, UPS) can be updated, depending on the construction of the APC620 system.

### 2.2.1 Procedure

- Download and unzip the zip file from the B&R homepage.
- Create bootable media.

#### Information:

**In MS-DOS, Win95 and Win98, a blank HD disk can be made bootable using the command line command "sys a:" or "format a: /s".**

**Information concerning creating a bootable diskette in Windows XP can be found on page 558.**

**Information concerning creating a USB flash drive for a B&R upgrade can be found on page 560.**

**Information concerning creating a CompactFlash card for a B&R upgrade can be found on page 562.**

- Copy the contents of the \*.zip file to the bootable media. If the B&R upgrade was already added when the bootable media was created using the B&R Embedded OS Installer, then this step is not necessary.
- Connect the bootable media to the APC620 and reboot the device.
- The following boot menu will be shown after startup:

#### Information:

**The following boot menu options including descriptions are based on version 1.27 of the APC620 / Panel PC Firmware upgrade (MTCX, SDLR, SDLT) disk. In some cases, these descriptions might not match the version you are currently using.**

#### Boot menu options:

1. Upgrade MTCX (APC620/PPC700) PX32 and FPGA
2. Upgrade SDLT (APC620) only
3. Upgrade SDLR (AP800/AP900) on monitor/panel
  - 3.1 Upgrade SDLR on AP 0 (AP800/AP900)
  - 3.2 Upgrade SDLR on AP 1 (AP800/AP900)

## Software • Upgrade information

- 3.3 Upgrade SDLR on AP 2 (AP800/AP900)
- 3.4 Upgrade SDLR on AP 3 (AP800/AP900)
- 3.5 Upgrade all SDLR (AP800/AP900)
- 3.6 Return to main menu
4. Upgrade SDLR (AP800/AP900) on AP link slot
  - 4.1 Upgrade SDLR on AP 8 (AP800/AP900)
  - 4.2 Upgrade SDLR on AP 9 (AP800/AP900)
  - 4.3 Upgrade SDLR on AP 10 (AP800/AP900)
  - 4.4 Upgrade SDLR on AP 11 (AP800/AP900)
  - 4.5 Upgrade all SDLR (AP800/AP900)
  - 4.6 Return to main menu
5. Upgrade add-on UPS (firmware and battery settings)
  - 5.1 Upgrade Add-on UPS Firmware (5AC600.UPSI-00)
  - 5.2 Upgrade Battery Settings (5AC600.UPSB-00)
  - 5.3 Return to main menu
6. Exit

### *Concerning point 1:*

Automatically upgrade PX32 and FPGA for MTCX (default after 5 seconds).

### *Concerning point 2:*

The FPGA of the SDLT controller on the AP Link slot is automatically updated.

### *Concerning point 3:*

A submenu is opened for upgrading the SDLR controller on the Monitor/Panel plug.

- 3.1. Upgrade SDLR on AP 0 (AP800/AP900)  
The SDLR controller is automatically updated on Automation Panel 0.
- 3.2 Upgrade SDLR on AP 1 (AP800/AP900)  
The SDLR controller is automatically updated on Automation Panel 1.
- 3.3 Upgrade SDLR on AP 2 (AP800/AP900)  
The SDLR controller is automatically updated on Automation Panel 2.
- 3.4 Upgrade SDLR on AP 3 (AP800/AP900)  
The SDLR controller is automatically updated on Automation Panel 3.

### 3.5. Upgrade all SDLR (AP800/AP900)

All SDLR controllers are automatically updated on all Automation Panels on the Monitor/Panel (default after 5 sec).

3.6. Return to main menu  
Returns to the main menu.

#### *Concerning point 4:*

A submenu is opened for upgrading the SDLR controller on the AP Link slot.

#### 4.1. Upgrade SDLR on AP 8 (AP800/AP900)

The SDLR controller is automatically updated on Automation Panel 8.

#### 4.2. Upgrade SDLR on AP 9 (AP800/AP900)

The SDLR controller is automatically updated on Automation Panel 9.

#### 4.3 Upgrade SDLR on AP 10 (AP800/AP900)

The SDLR controller is automatically updated on Automation Panel 10.

#### 4.4 Upgrade SDLR on AP 11 (AP800/AP900)

The SDLR controller is automatically updated on Automation Panel 11.

#### 4.5 Upgrade all SDLR (AP800/AP900)

All SDLR controllers are automatically updated on all Automation Panels on the AP Link slot Monitor/Panel (default after 5 sec).

4.6 Return to main menu  
Returns to the main menu.

#### *Concerning point 5:*

The submenu for the add-on UPS firmware and upgrade and the battery settings upgrade is opened - this is irrelevant for PPC700 systems.

#### *Concerning point 6:*

Returns to the shell (MS-DOS).

## **Information:**

**The system must be powered off and on again after a successful controller upgrade.**

## 2.3 Creating an MS-DOS boot diskette in Windows XP

- Place an empty 1.44 MB HD diskette in the disk drive
- Open Windows Explorer
- Right-click on the 3½" floppy icon and select "**Format...**".

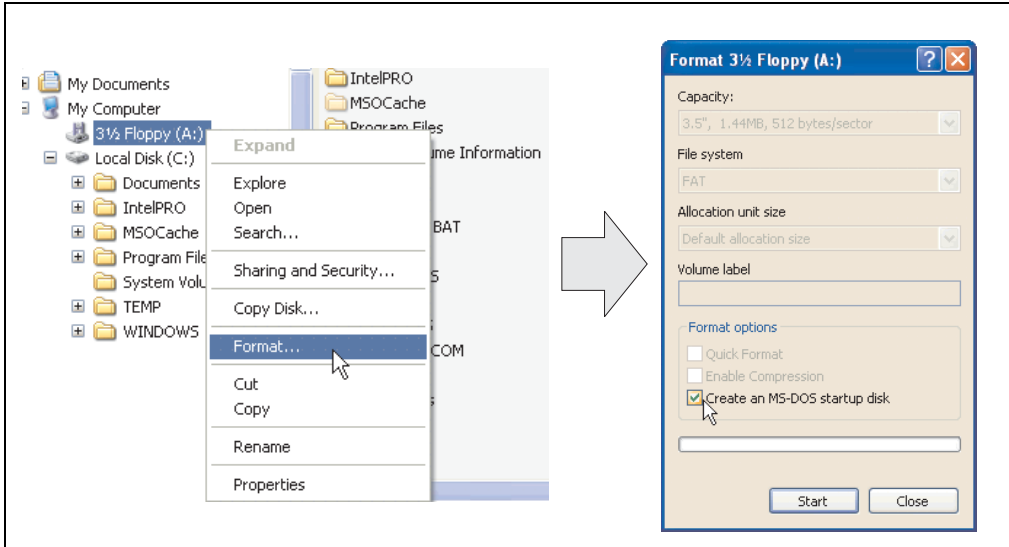

Figure 270: Creating a bootable diskette in Windows XP - step 1

- Then select the checkbox "**Create an MS-DOS startup disk**", press "**Start**" and acknowledge the warning message with "OK".

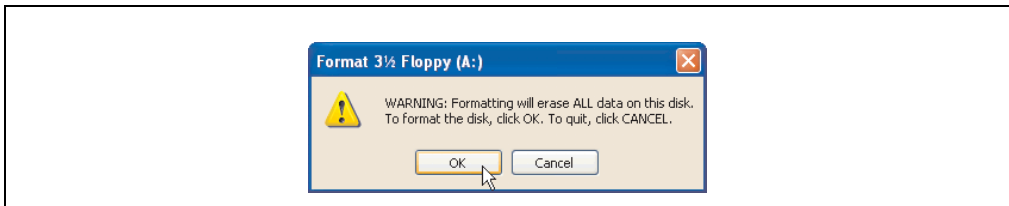

Figure 271: Creating a bootable diskette in Windows XP - step 2

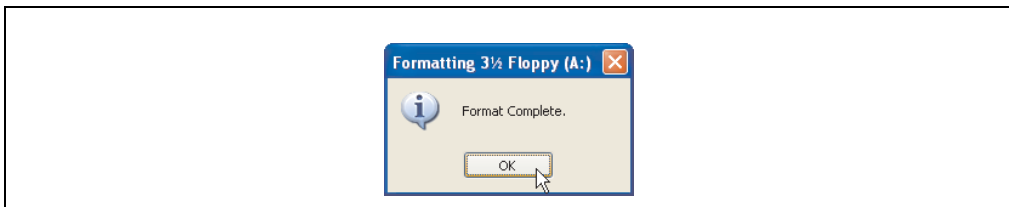

Figure 272: Creating a bootable diskette in Windows XP - step 3

After creating the startup disk, some of the files must be deleted because of the size of the update.

When doing this, all files (hidden, system files, etc.) must be shown on the diskette.

In Explorer, go to the Tools menu, select Folder Options... and open the View tab. Now deactivate the option Hide protected operating system files (Recommended) (activated by default) and activate the option Show hidden files and folders.

before				after			
Name	Size	Type	Date Modified	Name	Size	Type	Date Modified
DISPLAY.SYS	17 KB	System file	6/8/2000 5:00 PM	AUTOEXEC.BAT	0 KB	MS-DOS Batch File	3/22/2006 10:08 AM
EGA2.CPI	58 KB	CPI File	6/8/2000 5:00 PM	COMMAND.COM	91 KB	MS-DOS Application	6/8/2000 5:00 PM
EGA3.CPI	58 KB	CPI File	6/8/2000 5:00 PM	CONFIG.SYS	0 KB	System file	3/22/2006 10:08 AM
EGA.CPI	58 KB	CPI File	6/8/2000 5:00 PM	DISPLAY.SYS	17 KB	System file	6/8/2000 5:00 PM
KEYB.COM	22 KB	MS-DOS Application	6/8/2000 5:00 PM	EGA2.CPI	50 KB	CPI File	6/8/2000 5:00 PM
KEYBOARD.SYS	34 KB	System file	6/8/2000 5:00 PM	EGA3.CPI	50 KB	CPI File	6/8/2000 5:00 PM
KEYBRD2.SYS	32 KB	System file	6/8/2000 5:00 PM	EGA.CPI	58 KB	CPI File	6/8/2000 5:00 PM
KEYBRD3.SYS	31 KB	System file	6/8/2000 5:00 PM	IO.SYS	114 KB	System file	5/15/2001 6:57 PM
KEYBRD4.SYS	13 KB	System file	6/8/2000 5:00 PM	KEYB.COM	22 KB	MS-DOS Application	6/8/2000 5:00 PM
MODE.COM	29 KB	MS-DOS Application	6/8/2000 5:00 PM	KEYBOARD.SYS	34 KB	System file	6/8/2000 5:00 PM
				KEYBRD2.SYS	32 KB	System file	6/8/2000 5:00 PM
				KEYBRD3.SYS	31 KB	System file	6/8/2000 5:00 PM
				KEYBRD4.SYS	13 KB	System file	6/8/2000 5:00 PM
				MODE.COM	29 KB	MS-DOS Application	6/8/2000 5:00 PM
				MSDOS.SYS	1 KB	System file	4/7/2001 1:40 PM

Figure 273: Creating a bootable diskette in Windows XP - step 4

Name	Size	Type	Date Modified
AUTOEXEC.BAT	0 KB	MS-DOS Batch File	3/22/2006 10:08 AM
COMMAND.COM	91 KB	MS-DOS Application	6/8/2000 5:00 PM
CONFIG.SYS	0 KB	System file	3/22/2006 10:08 AM
DISPLAY.SYS	17 KB	System file	6/8/2000 5:00 PM
EGA2.CPI	58 KB	CPI File	6/8/2000 5:00 PM
EGA3.CPI	58 KB	CPI File	6/8/2000 5:00 PM
EGA.CPI	58 KB	CPI File	6/8/2000 5:00 PM
IO.SYS	114 KB	System file	5/15/2001 6:57 PM
KEYB.COM	22 KB	MS-DOS Application	6/8/2000 5:00 PM
KEYBOARD.SYS	34 KB	System file	6/8/2000 5:00 PM
KEYBRD2.SYS	32 KB	System file	6/8/2000 5:00 PM
KEYBRD3.SYS	31 KB	System file	6/8/2000 5:00 PM
KEYBRD4.SYS	13 KB	System file	6/8/2000 5:00 PM
MODE.COM	29 KB	MS-DOS Application	6/8/2000 5:00 PM
MSDOS.SYS	1 KB	System file	4/7/2001 1:40 PM

Figure 274: Creating a bootable diskette in Windows XP - step 5

Now all files (marked) except Command.com, IO.sys and MSDOS.sys can be deleted.

## 2.4 Creating a bootable USB flash drive for B&R upgrade files

When used in connection with a B&R industrial PC, it is possible to upgrade BIOS from one of the USB flash drives available from B&R. To do this, the USB flash drive must be prepared accordingly. This is done with the B&R Embedded OS Installer, which can be downloaded for free from the B&R homepage ([www.br-automation.com](http://www.br-automation.com)).

### 2.4.1 Requirements

The following peripherals are required for creating a bootable USB flash drive:

- B&R USB flash drive
- B&R Industrial PC
- USB Media Drive
- B&R Embedded OS Installer (V3.00 or higher)

### 2.4.2 Procedure

- Connect the USB flash drive to the PC.
- If the drive list is not refreshed automatically, the list must be updated using the command **Drives > Refresh**.
- Mark the desired USB flash drive in the drive list.
- Change to the **Action** tab and select **Install a B&R Update to a USB flash drive** as type of action.
- Enter the path to the MS-DOS operating system files. If the files are part of a ZIP archive, then click on the button **By ZIP file....** If the files are stored in a directory on the hard drive, then click on the button **By folder....**
- In the **B&R Upgrade** text box, it's also possible to enter the path to the ZIP file for the B&R Upgrade Disk and select the file.
- Click on the **Start action** button in the toolbar.



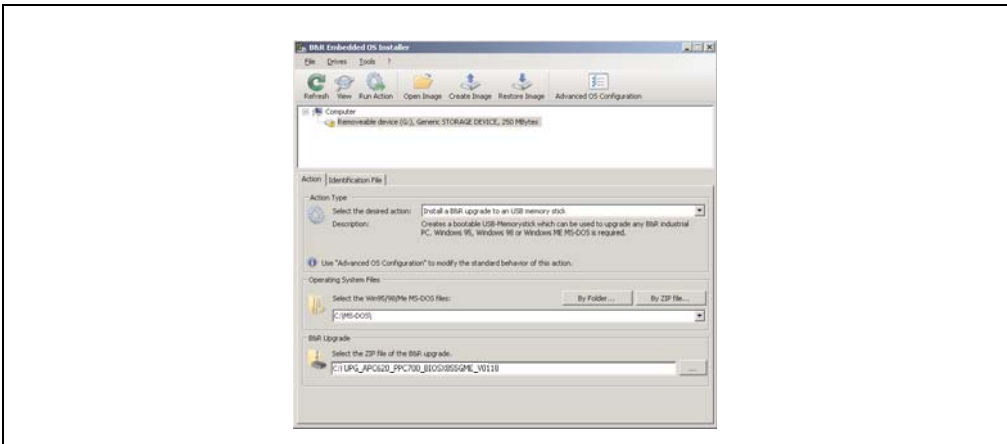

Figure 275: Creating a USB flash drive for B&R upgrade files

### 2.4.3 Where do I get MS-DOS?

Information concerning creating an MS-DOS boot diskette can be found in section 2.3 "Creating an MS-DOS boot diskette in Windows XP", on page 558. Then the files from the diskette are to be copied to your hard drive.

## 2.5 Creating a bootable CompactFlash card for B&R upgrade files

When used in connection with a B&R industrial PC, it is possible to upgrade BIOS from one of the CompactFlash cards available from B&R. To do this, the CompactFlash card must be prepared accordingly. This is done with the B&R Embedded OS Installer, which can be downloaded for free from the B&R homepage ([www.br-automation.com](http://www.br-automation.com)).

### 2.5.1 Requirements

The following peripherals are required for creating a bootable CompactFlash card:

- CompactFlash card
- B&R Industrial PC
- B&R Embedded OS Installer (V3.10 or higher)

### 2.5.2 Procedure

- Insert the CompactFlash card in the CF slot on the industrial PC.
- If the drive list is not refreshed automatically, the list must be updated using the command **Drives > Refresh**.
- Select the desired CompactFlash card from the drive list.
- Change to the **Action** tab and select **Install a B&R Update to a CompactFlash card** as type of action.
- Enter the path to the MS-DOS operating system files. If the files are part of a ZIP archive, then click on the button **By ZIP file....** If the files are stored in a directory on the hard drive, then click on the button **By folder....**
- In the **B&R Upgrade** text box, it's also possible to enter the path to the ZIP file for the B&R Upgrade Disk and select the file.
- Click on the **Start action** button in the toolbar.

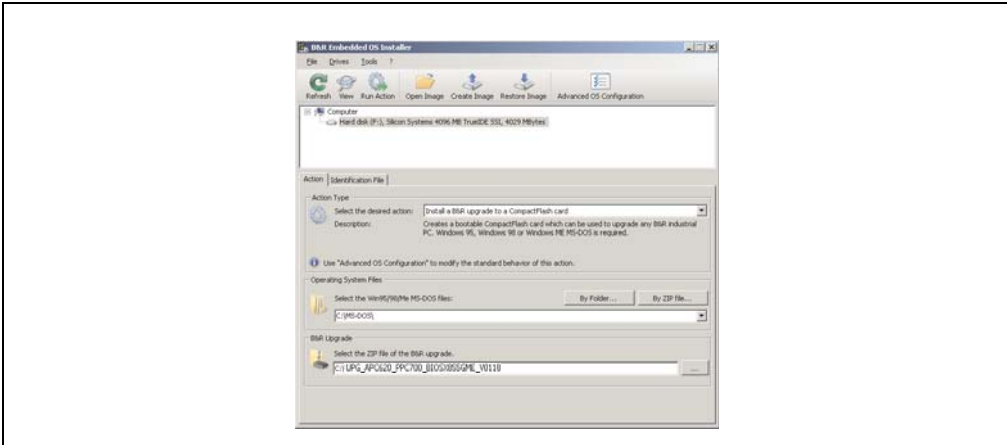

Figure 276: Creating a CompactFlash card for B&R upgrade files

### 2.5.3 Where do I get MS-DOS?

Information concerning creating an MS-DOS boot diskette can be found in section 2.3 "Creating an MS-DOS boot diskette in Windows XP", on page 558. Then the files from the diskette are to be copied to your hard drive.

### 2.6 Upgrade problems

Potential upgrade problems are listed in the Liesmich.txt or Readme.txt files on the upgrade disks.

## 3. Automation PC 620 with Automation Runtime

### 3.1 General information

An integral component of Automation Studio™ is Automation Runtime, the software kernel which allows applications to run on a target system. This runtime environment offers numerous important advantages:

- Guaranteed highest possible performance for the hardware being used
- Runs on all B&R target systems
- Makes the application hardware-independent
- Applications can be easily ported between B&R target systems
- Cyclic system guarantees deterministic behavior
- Configurable jitter tolerance in all task classes
- Supports all relevant programming language such as IEC 61131-3 and C
- Extensive function library conforming to IEC 61131-3 as well as the expanded B&R Automation library
- Integrated into Automation NET. Access to all networks and bus systems via function calls or the Automation Studio™ configuration

### 3.2 Support for Automation PC 620 embedded

#### 3.2.1 ARwin

The fieldbus interfaces CAN, X2X, and POWERLINK are supported by ARwin with an AS 2.6 upgrade.

#### 3.2.2 ARemb

The fieldbus interfaces CAN, X2X, and POWERLINK are supported by AR 2.94 together with an AS 2.7.

### 3.3 Selection of devices

Power supply buffering of 10 ms is guaranteed starting with the following system unit revisions:

Model number	Description	Revision
5PC600.SX01-00	System 1 PCI	B0
5PC600.SX02-00	System 2 PCI, 1 disk drive slot, 1 AP Link slot	B0
5PC600.SX02-01	System 2 PCI, 1 disk drive slot	B0
5PC600.SF03-00	System 3 PCI, 1 disk drive slot, 1 AP Link slot	A0

Table 348: System unit support for buffering with Automation Runtime

Model number	Description	Revision
5PC600.SX05-00	System 5 PCI, 2 disk drive slots, 1 AP Link slot	A0
5PC600.SX05-01	System 5 PCI, 2 disk drive slots	A0
5PC600.SE00-00	APC620e System SDL EPL X2X CAN 512kB	A0
5PC600.SE00-01	APC620e System CRT EPL X2X CAN 512KB	A0
5PC600.SE00-02	APC620e System SDL EPL X2X CAN 1MB	A0

Table 348: System unit support for buffering with Automation Runtime (Forts.)

### 3.4 Visual Components graphic engine support

The output of graphics with Visual Components is only supported by graphic engine 1. Graphic engine 2 is not supported. The following table should clarify the mapping and stretching function of the graphic engine in connection with the different system unit variations.

System unit	Graphic engine (GE) Number	Graphic engine number on		Stretch support on graphic connection
		Monitor / Panel	AP Link slot (5AC600.SDL0-00)	
5PC600.SX01-00	1	GE1	-	Monitor / Panel
5PC600.SX02-00	2	GE2	GE1	AP Link slot (5AC600.SDL0-00)
5PC600.SX02-01	1	GE1	-	Monitor / Panel
5PC600.SF03-00	2	GE2	GE1	AP Link slot (5AC600.SDL0-00)
5PC600.SX05-00	2	GE2	GE1	AP Link slot (5AC600.SDL0-00)
5PC600.SX05-01	1	GE1	-	Monitor / Panel
5PC600.SE00-00	1	GE1	-	Monitor / Panel
5PC600.SE00-01	1	GE1	-	Monitor / Panel
5PC600.SE00-02	1	GE1	-	Monitor / Panel

Table 349: Visual Components video output with different system units

A graphic engine 1 (GE1) is only available in connection with AP Link SDL transmitter 5AC600.SDL0-00 for system units 5PC600.SX02-00, 5PC600.SX05-00 and 5PC600.SF03-00. If no AP Link SDL transmitter is present in the system units listed, then video output is not possible with Visual Components.

## 4. Automation PC 620 with MS-DOS



Figure 277: Automation PC 620 with MS-DOS

Model number	Short description	Note
9S0000.01-010	<b>OEM MS-DOS 6.22 German (disk)</b> OEM MS-DOS 6.22 German disks Only delivered with a new PC.	
9S0000.01-020	<b>OEM MS-DOS 6.22 English (disk)</b> OEM MS-DOS 6.22 English disks Only delivered with a new PC.	

Table 350: Model numbers - MS-DOS

### 4.1 Known problems

Either no drivers are available for the following hardware components or only with limitations:

- AC97 Sound - no support
- USB 2.0 - only USB 1.1 rates can be reached.
- Limited drive support for the slide-in drives 5AC600.DVDS-00 and 5AC600.DVRS-00 - no write functions.
- "Graphics Engine 2" and therefore Extended Desktop mode also cannot be used.
- A few "ACPI control" BIOS functions cannot be used.

The following table shows the tested resolutions and color depths on the Monitor / Panel connector with 855GME CPU boards.

Resolutions for DVI	Color depth		
	8-bit	16-bit	24-bit
640 x 480	✓	✓	✓
800 x 600	✓	✓	✓
1024 x 768	✓	✓	✓
1280 x 1024	✓	✓	✓
Resolutions for RGB	Color depth		
	8-bit	16-bit	24-bit
640 x 480	✓	✓	✓
800 x 600	✓	✓	✓
1024 x 768	✓	✓	✓
1280 x 1024	✓	✓	✓
1600 x 1200	✓	✓	✓
1920 x 1440	✓	✓	

Table 351: Tested resolutions and color depths for DVI and RGB signals

## 5. Automation PC 620 with Windows XP Professional

### Information:

**Discontinuation of support for Windows XP by Microsoft:**

After April 8th, 2014, Microsoft will no longer be providing any security updates, hotfixes, support (free or paid) or technical resources for Windows XP.



Figure 278: Windows XP Professional Logo

Model number	Short description	Note
9S0000.08-010	<b>OEM Microsoft Windows XP Professional</b> CD, German; Only delivered with a new PC.	Cancelled since 10/2008
9S0000.08-020	<b>OEM Microsoft Windows XP Professional</b> CD, English; Only delivered with a new PC.	Cancelled since 10/2008
9S0000.09-090	<b>OEM Microsoft Windows XP Professional Multilanguage</b> CDs; Only delivered with a new PC.	Cancelled since 07/2009
5SWWXP.0600-GER	<b>WinXP Professional with SP3, CD German</b> Microsoft OEM Windows XP Professional Service Pack 3, CD, German. Only available with a new device.	
5SWWXP.0600-ENG	<b>WinXP Professional with SP3, CD English</b> Microsoft OEM Windows XP Professional Service Pack 3, CD, English. Only available with a new device.	
5SWWXP.0600-MUL	<b>WinXP Professional with SP3, CD, Multi-language</b> Microsoft OEM Windows XP Professional Service Pack 3, CD, multi-language. Only available with a new device.	
5SWWXP.0500-GER	<b>WinXP Professional with SP2c, CD German</b> Microsoft OEM Windows XP Professional Service Pack 2c, CD, German. Only available with a new device.	
5SWWXP.0500-ENG	<b>WinXP Professional with SP2c, CD English</b> Microsoft OEM Windows XP Professional Service Pack 2c, CD, English. Only available with a new device.	

Table 352: Model numbers - Windows XP Professional



Model number	Short description	Note
5SWWWXP.0500-MUL	<b>WinXP Professional with SP2c, CD, Multi-language</b> Microsoft OEM Windows XP Professional Service Pack 2c, CD, multi-language. Only available with a new device.	

Table 352: Model numbers - Windows XP Professional (Forts.)

## 5.1 Installation

Upon request, B&R will pre-install Windows XP Professional on the desired mass memory (add-on hard disk, slide-in hard disk). All of the drivers required for operation (graphics, network, etc.) are also installed when doing so.

### 5.1.1 FAQ

#### How do I install Windows XP on systems with 815E CPU boards?

Windows XP can be installed on APC620 systems with 815E CPU boards **only** together with a connected **external monitor (RGB)**. An Automation Panel 900 is switched off in the Windows hardware recognition if connected via SDL or DVI during the installation. Video output via SDL and DVI is only supported after installing the 815E graphics driver.

#### Installation on PCI SATA RAID controller - 5ACPCI.RAIC-03, 5ACPCI.RAIC-05

The following steps are necessary for installing Windows XP Professional on the PCI SATA RAID controller:

- 1) Download the RAID driver from the B&R homepage ([www.br-automation.com](http://www.br-automation.com)) and copy the files to a diskette.
- 2) Connect the Media Drive (5MD900.USB2-01 or 5MD900.USB2-00) to the USB port.
- 3) Insert the diskette and Windows XP Professional CD in the the Media Drive and boot from the CD.
- 4) Press the F6 key during setup to install a third-party SCSI or a driver.
- 5) Press the "s" key when asked about installing an additional drive. Insert the disk in the floppy drive. Press "Enter" and select the driver.
- 6) Follow the setup instructions.
- 7) The setup copies the files to the Windows XP Professional folder and restarts the APC620.

#### [For 5PCI slot model](#)

The following steps are necessary when installing to a slide-in HDD being operated in the slide-in slot 2 (located behind the PCI to SATA Bridge) on the APC620:

- 1) Download the Si3531 SATA driver from the B&R homepage ([www.br-automation.com](http://www.br-automation.com)) and copy the files to a diskette.
- 2) Connect the Media Drive (5MD900.USB2-01 or 5MD900.USB2-00) to the USB port.
- 3) Insert the diskette and Windows XP Professional CD in the the Media Drive and boot from the CD.
- 4) Press the F6 key during setup to install a third-party SCSI or a driver.
- 5) Press the "s" key when asked about installing an additional drive. Insert the disk in the floppy drive. Press "Enter" and select the driver.
- 6) Follow the setup instructions.
- 7) The setup copies the files to the Windows XP Professional folder and restarts the Automation PC 620.

## Information:

- Windows XP setup supports not all USB-FDD drives (see Microsoft KB 916196).
- Depending on the system it could be necessary to change the boot order in BIOS.

## 5.2 Graphics drivers

For operation modes "extended desktop" and "dual display clone", the Intel Extreme graphics chip driver must be installed. Graphics drivers for 815E and 855GME CPU boards are available for approved operating systems in the download area (Service - Material Related Downloads - BIOS / Drivers / Updates) on the B&R homepage ([www.br-automation.com](http://www.br-automation.com)).

### 5.2.1 Installing the graphics driver for 815E (ETX) CPU boards

The following must be observed when installing the graphics chip driver for the graphics chip integrated in the 815E chip set:

- The driver available from Intel is NOT permitted to be used, only the driver available from B&R ([www.br-automation.com](http://www.br-automation.com)).
- After unpacking the \*.zip file, the driver must be updated using the Windows Device Manager "Start - Control Panel - System - Hardware - Device Manager - Update Driver". When doing this, use the file **i81xnt5.inf**.
- The initial installation of the driver can **only** be carried out with an **external monitor (RGB)** connected. After successfully installing the B&R driver, an Automation Panel 900 be operated via SDL or DVI without problems.

## Caution!

Presently, this driver is only approved for the Windows XP Professional and Windows XP embedded operating systems.

## Information:

The following screenshots and descriptions refer to the graphics driver version 6.13.01.3175 for 815E CPU boards. Therefore, it is possible that the screenshots and descriptions might not correspond with the installed driver version.

After the driver is installed, it can be configured in the Control Panel (called up through the icon in the taskbar or Start - Control Panel - Display - Settings - Advanced).

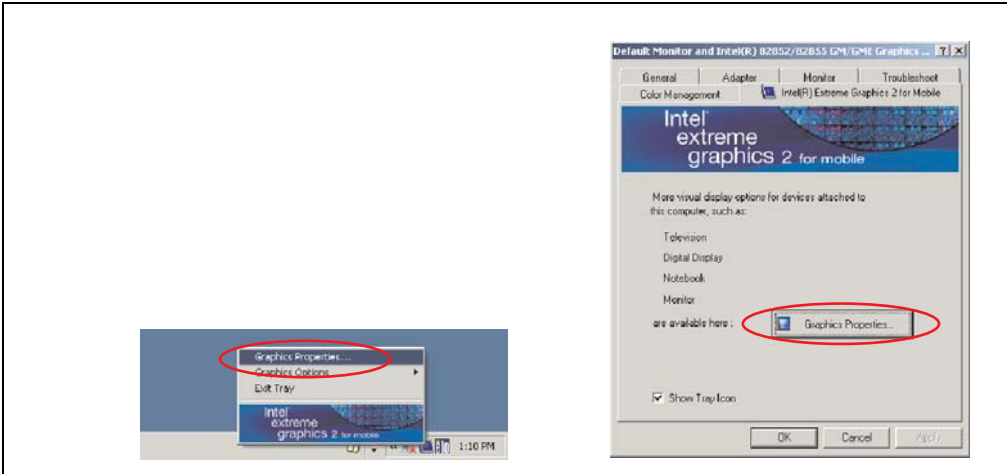

Figure 279: Graphics driver for 815E Control Panel access

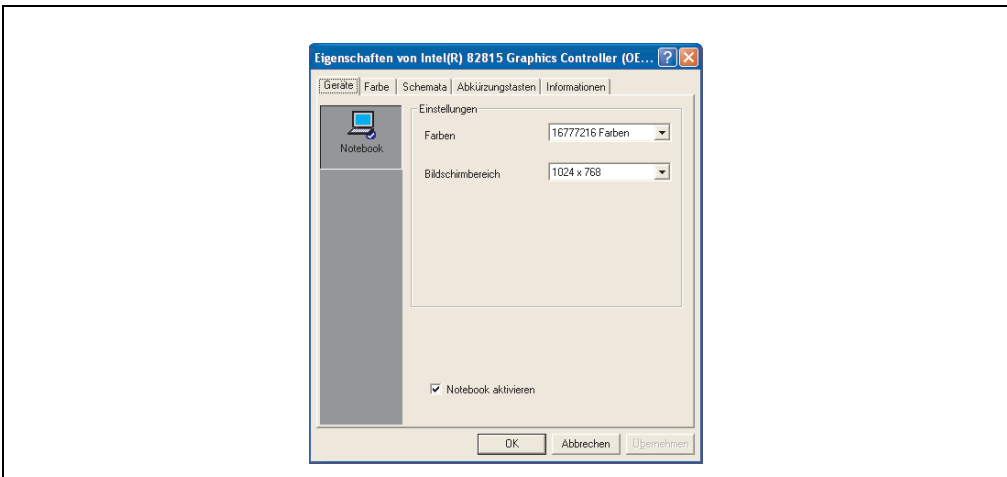

Figure 280: Graphics driver for 815E settings

## 5.2.2 Graphics driver installation - 855GME (ETX / XTX) CPU boards

### Information:

The following screenshots and descriptions refer to the graphics driver version 14.11 for 855GME CPU boards. Therefore, it is possible that the screenshots and descriptions might not correspond with the installed driver version.

After the driver is installed, it can be configured in the Control Panel (called up through the icon in the taskbar or Start - Control Panel - Display - Settings - Advanced).

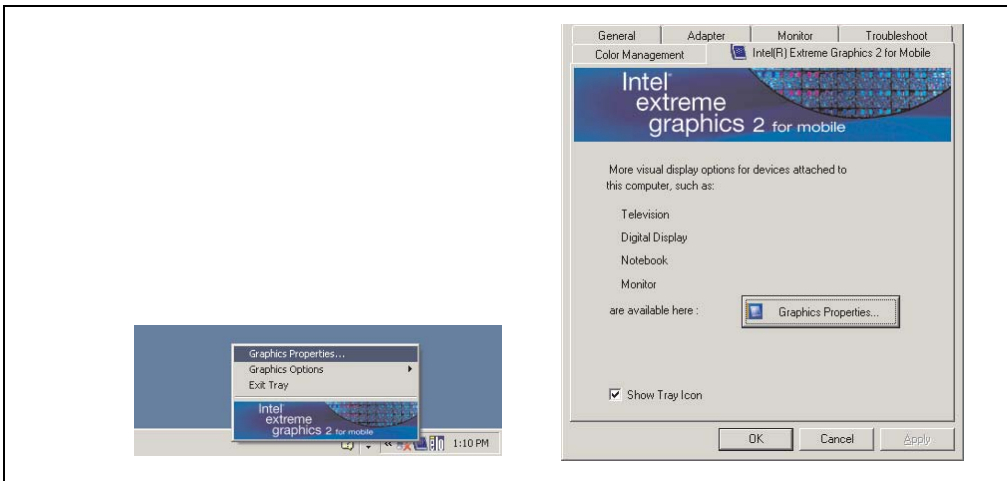

Figure 281: Accessing the graphics driver via Control Panel

### Information:

The connected Automation Panel 900 is still not activated after installing the graphics driver.

See the FAQ for information on this topic: "My Automation Panel 900 is still not activated after installing the graphics driver.", on page 576.

### 5.2.3 Graphics settings for Extended Desktop

Under the "Extended desktop" settings, "Notebook" can be set as the primary device (Graphics Engine 1) and "Digital display" as secondary device (Graphics Engine 2). The two lines display different content (Extended Desktop).

Driver settings		Effect on APC620	
Primary device	Notebook	AP Link output	Graphics engine 1
Secondary device	Digital display	Monitor / Panel	Graphics engine 2
Primary device	Digital display	Monitor / Panel	Graphics engine 2
Secondary device	Notebook	AP Link output	Graphics engine 1

Table 353: Relationship between driver settings and graphics engine

Resolution and color depth can be configured separately for each line via the device settings for notebook and digital display.

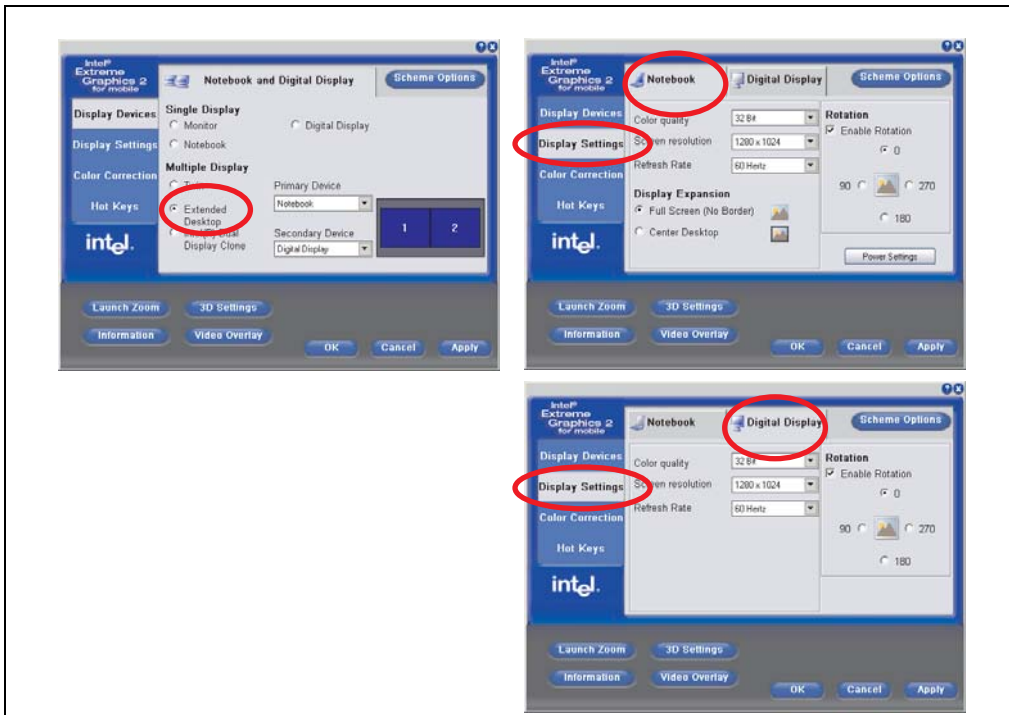

Figure 282: Extended desktop settings - primary and secondary device

Due to the operation of two different lines, for each line one of the internal serial interfaces COM C and COM D on the APC620 must be activated in BIOS (under Advanced - Baseboard/Panel Features - Legacy Devices) for the Automation 900 devices' touch screens. See the section 5.3.1 "Installation for Extended Desktop", on page 578 for information about installing the touch screen driver.

### 5.2.4 Graphics settings for Dual Display Clone

In "Dual display clone" mode, the same content is displayed on every connected Automation Panel 900 unit on both lines (Graphics Engine 1 and Graphics Engine 2). This enables operation of the application from every display.

Driver settings		Effect on APC620	
Primary device	Notebook	AP Link output	Graphics engine 1
Secondary device	Digital display	Monitor / Panel	Graphics engine 2
Primary device	Digital display	Monitor / Panel	Graphics engine 2
Secondary device	Notebook	AP Link output	Graphics engine 1

Table 354: Relationship between driver settings and graphics engine

Resolution and color depth can only be set on the line designated as the primary device.

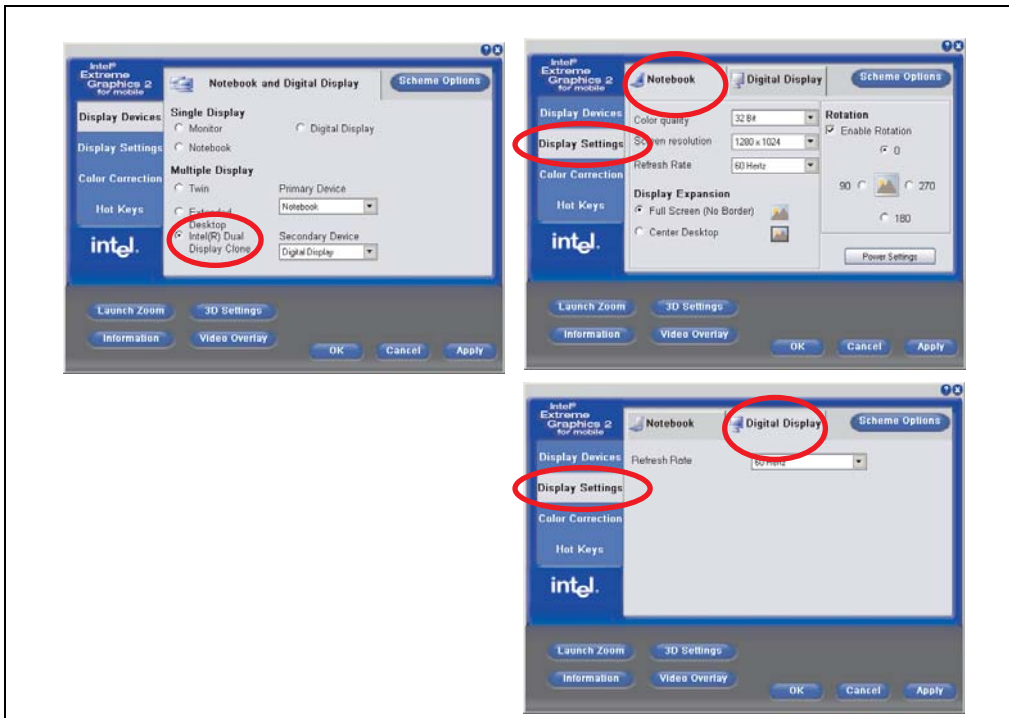

Figure 283: Dual display clone settings - primary and secondary device

The internal serial interface COM C on the APC620 must be activated in BIOS (under Advanced - Baseboard/Panel Features - Legacy Devices) for the Automation 900 devices' touch screens. See the section 5.3.2 "Installation for Dual Display Clone", on page 580 for information about installing the touch screen driver.

A panel locking time can be set in the B&R Control Center to prevent simultaneous operation of the Automation Panel 900 (see the .chm help file for the B&R Control Center).

## Information:

- The panel locking time is reset to the value configured in the key configuration (KCF - Key Configuration File) when the system is restarted.

### 5.2.5 FAQ

#### My Automation Panel 900 is still not activated after installing the graphics driver.

After installation, the graphics driver is automatically set to the analog output - RGB (monitor). As a result, any Automation Panel 900 connected via SDL (Smart Display Link) or DVI remains switched-off after loading the Intel graphics driver in Windows XP.

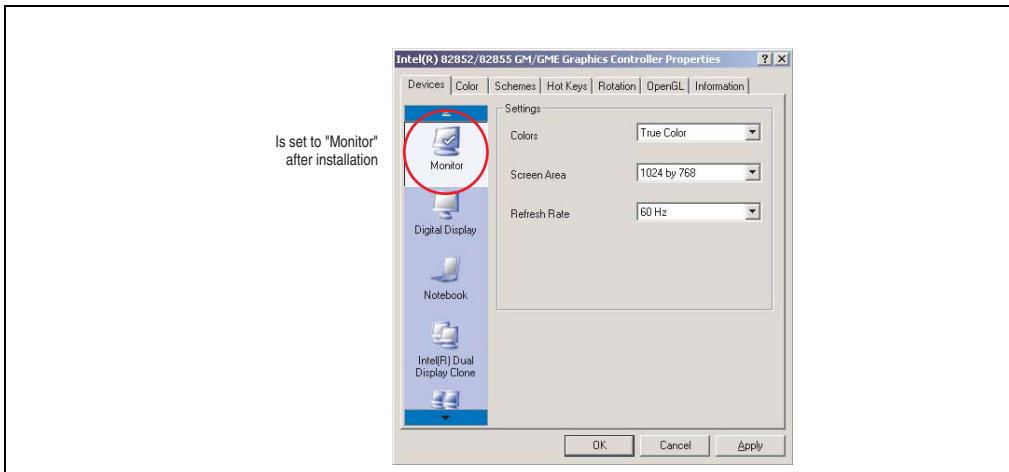

Figure 284: Settings after installing the graphics driver



To correct this problem, an analog monitor (RGB) must be connected to the monitor/panel, to reactivate the settings for digital output (digital display for the monitor/panel output or notebook for the AP Link output).

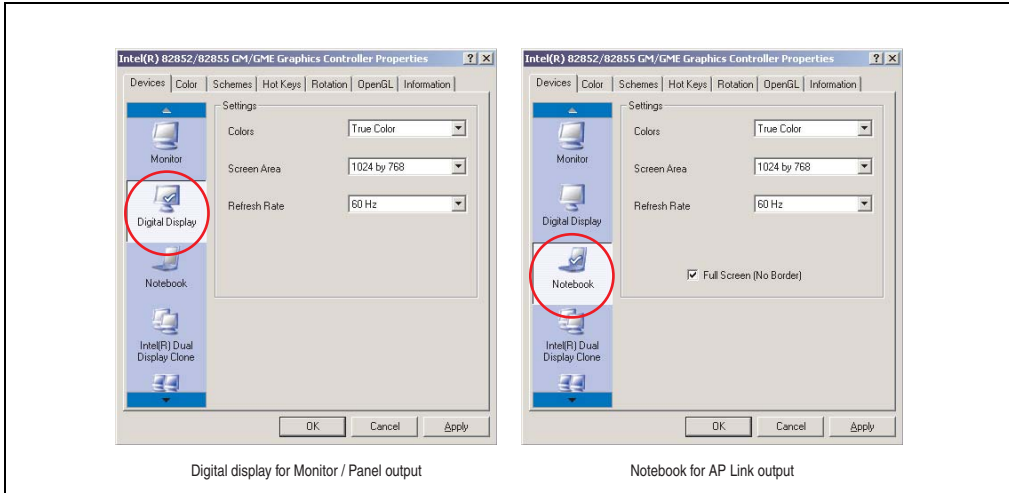

Figure 285: Settings for adjustment

## 5.3 Touch screen driver

For operation modes "extended desktop" and "dual display clone", the Elo touch screen driver must be installed. This can be found in the download area (Service - Material Related Downloads - BIOS / Drivers / Updates) on the B&R homepage ([www.br-automation.com](http://www.br-automation.com)).

### Information:

The touch screen drivers are based on the Windows mouse system. That means that either a mouse (USB or PS/2) must have been connected during the Windows installation or the mouse drivers must be installed additionally (e.g. automatically installed when later connecting a USB mouse). The BIOS function "PS/2 Mouse" must be set to "Enabled" when using a PS/2 mouse. This is located on the BIOS setup page "Advanced" - "Miscellaneous" (the default setting is "Disabled").

#### 5.3.1 Installation for Extended Desktop

### Information:

- Activate COM C and COM D in BIOS.
- During installation the panel locking time must be set to 0 ms ("Auto detect" of the driver could only recognize 1 touch screen).
- Executing setup
- The Automation Panel 900 unit's touch screen is connected with the APC620 serially, so the serial touch screen drivers must be installed.

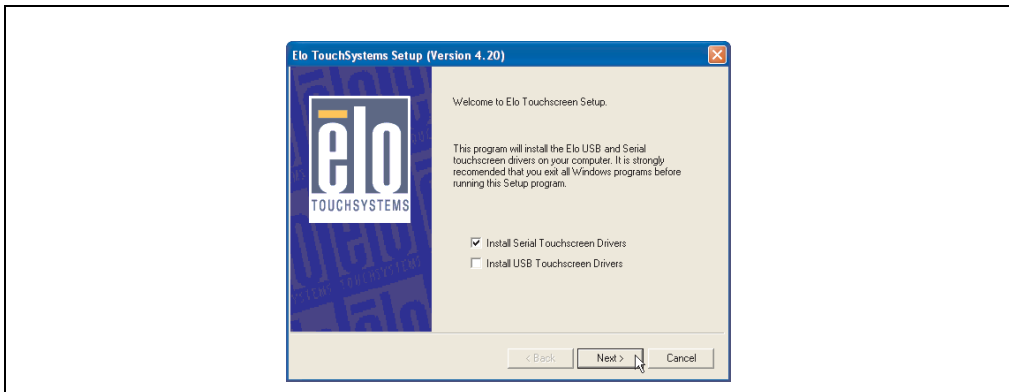

Figure 286: Touch screen driver - serial touch screen

- The driver's auto-detect function sends data packets to every existing serial interface. It then returns a list of all the ports on which an Elo touch screen is connected. The panel locking time must be set to 0 ms (auto-detect only found 1 touch screen)

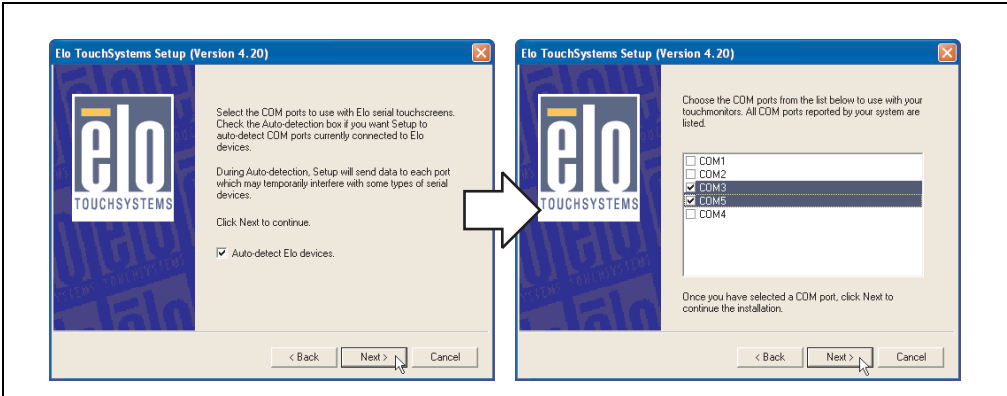

Figure 287: Touch screen driver - auto-detect

- After selecting the COM ports on which Elo touch screens are connected, the system must be rebooted.
- After restarting, each line of touch screens must be calibrated separately. This is done in the menus "Properties 1" and "Properties 2" with the "Align" button. When one touch screen is being calibrated, the others are automatically locked.

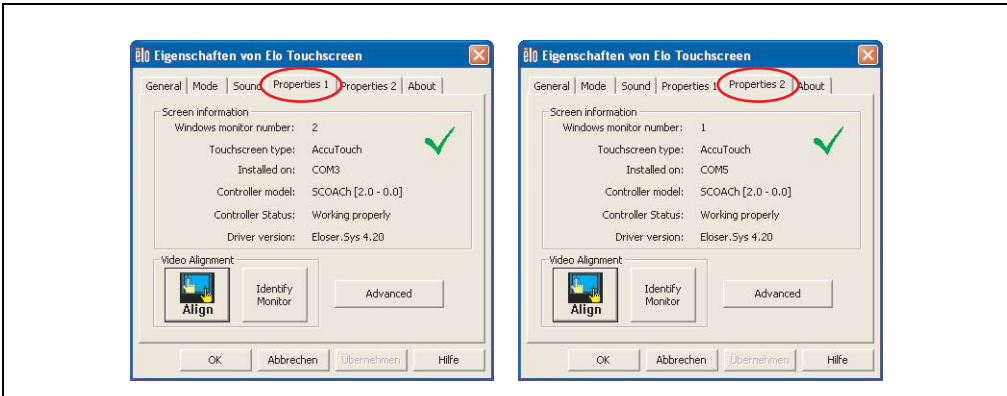

Figure 288: Touch screen calibration

### 5.3.2 Installation for Dual Display Clone

#### Information:

- Activate COM C in BIOS.
- During installation the panel locking time must be set to 0 ms ("Auto detect" of the driver could only recognize 1 touch screen).
- Executing setup
- The Automation Panel 900 unit's touch screen is connected with the APC620 serially, so the serial touch screen drivers must be installed.

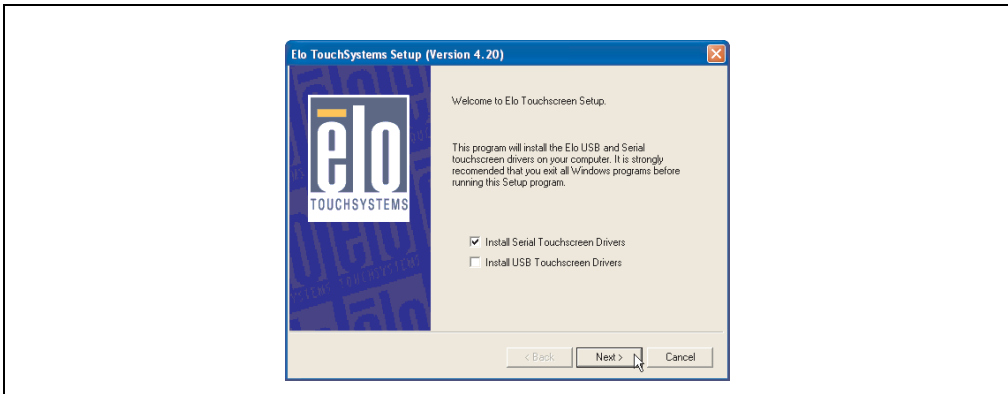

Figure 289: Touch screen driver - serial touch screen

- The driver's auto-detect function sends data packets to every existing serial interface. It then returns a list of all the ports on which an Elo touch screen is connected. The panel locking time must be set to 0 ms (auto-detect only found 1 touch screen)

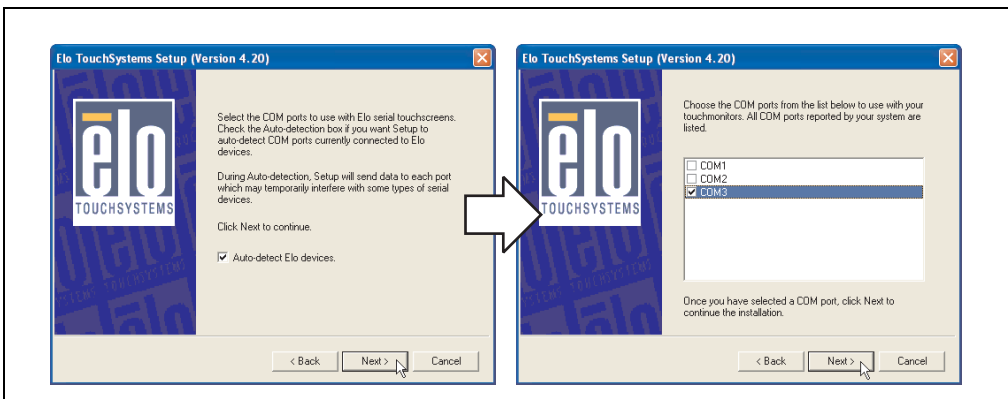

Figure 290: Touch screen driver - auto-detect

- After selecting the COM ports on which Elo touch screens are connected, the system must be rebooted.
- After restarting, only one touch screen must be calibrated. These settings are then applied to other touch screens.

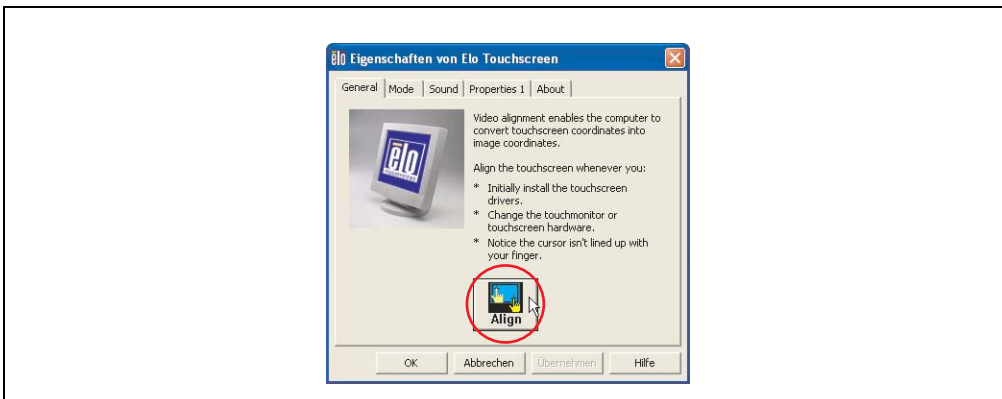

Figure 291: Touch screen calibration

### 5.3.3 FAQ

#### Power options and touch screen

The power options allow a few different settings (e.g. Turn off monitor, Turn off hard disks and System standby for a Windows XP system).

## Caution!

If the "Turn off monitor" function is enabled and a time has been set, then touching the dark touch display after the time has expired presents the risk of "blindly" activating one of the commands in the application and unintentionally triggering functions.

This can be avoided by activating a screen saver. As a result, the next time the touch screen is touched, the screen saver is deactivated.

### 5.4 Audio driver

An audio driver can be found in the download area (Service - Material Related Downloads - BIOS / Drivers / Updates) on the B&R homepage ([www.br-automation.com](http://www.br-automation.com)).

See the section "MIC, Line IN and Line OUT ports", on page 144 for information about the audio driver type.

#### 5.4.1 Installation

Execute the downloaded setup.

## Information:

The option "AC97 Audio controller" must be set to "Enabled" (default setting) in BIOS under Advanced - I/O Device Configuration.

## 5.5 Network driver

The APC620 has 2 different networks controllers. Drivers for both network connections (ETH1 and ETH2) are available for approved operating systems in the download area (Service - Material Related Downloads - BIOS / Drivers / Updates) on the B&R homepage ([www.br-automation.com](http://www.br-automation.com)).

See the sections "Ethernet connection ETH1", on page 130 and "Ethernet connection ETH2", on page 132 for information about network controller types.

### 5.5.1 Installation ETH1

Execute the downloaded setup.

### 5.5.2 Installation ETH2

Installation is performed via the Windows device manager using the Net559ER.inf file.

## 5.6 Automation PC 620 embedded

The fieldbus interfaces CAN, X2X and POWERLINK are not supported by Microsoft Windows XP (no drivers present).

## 6. Automation PC 620 with Windows XP embedded



Figure 292: Windows XP Embedded Logo

Model number	Short description	Note
9S0001.19-020	<b>OEM Microsoft Windows XP Embedded APC620 815E w/CF, English</b> 512 MB CompactFlash card with Windows XP Embedded image for APC620 systems with a 815E CPU board. Only delivered with a new PC.	Cancelled since 10/2005 Replacement type: 5SWWXP.0412-ENG
9S0001.20-020	<b>OEM Microsoft Windows XP Embedded APC620 855GME w/CF, English</b> 512 MB CompactFlash card with Windows XP Embedded image for APC620 systems with a 855GME CPU board. Only delivered with a new PC.	Cancelled since 10/2007 Replacement type: 5SWWXP.0412-ENG
9S0001.27-020	<b>OEM Microsoft Windows XP Embedded (incl. SP2) APC620 815E w/CF, English</b> 512 MB CompactFlash card with Windows XP Embedded image including SP2 for APC620 systems with a 815E CPU board. Only delivered with a new PC.	Cancelled since 10/2005 Replacement type: 5SWWXP.0412-ENG
9S0001.28-020	<b>OEM Microsoft Windows XP Embedded (incl. SP2) APC620 855GME w/CF, English</b> 512 MB CompactFlash card with Windows XP Embedded image including SP2 for APC620 systems with a 855GME CPU board. Only delivered with a new PC.	Cancelled since 10/2007 Replacement type: 5SWWXP.0412-ENG
5SWWXP.0412-ENG	<b>WinXPe FP2007 APC620 E855GME</b> Order Microsoft Windows XP Embedded English, Feature Pack 2007, for APC620 with CPU boards 5PC600.E855-00, 5PC600.E855-01, 5PC600.E855-02, 5PC600.E855-03, 5PC600.E855-04, 5PC600.E855-05; CompactFlash separately (at least 512 MB). Only delivered with a new PC.	
5SWWXP.0413-ENG	<b>WinXPe FP2007 APC620 X855GME</b> Order Microsoft Windows XP Embedded English, Feature Pack 2007, for APC620 with CPU boards 5PC600.X855-00, 5PC600.X855-01, 5PC600.X855-02, 5PC600.X855-03, 5PC600.X855-04, 5PC600.X855-05; CompactFlash separately (at least 512 MB). Only delivered with a new PC.	

Table 355: Model numbers - Windows XP Embedded

### 6.1 General information

Windows XP Embedded is the modular version of the desktop operating system Windows XP Professional. Windows XP Embedded is based on the same binary files as Windows XP Professional and is optimally tailored to the hardware being used. In other words, only the functions and modules required by the respective device are included. Windows XP Embedded is also based on the same reliable code as Windows XP Professional. It provides industry with leading reliability, improvements in security and performance, and the latest technology for Web browsing and extensive device support.

The Windows XP Embedded available from B&R was developed for APC620 systems with 815E and 855GME CPU board units.



## 6.2 Features with FP2007 (Feature Pack 2007)

The feature list shows the most important device functions in Windows XP Embedded with Feature Pack 2007 (FP2007).

Function	Present
Enhanced write filter (EWF)	✓
File Based Write Filter	✓
Page file	Configurable
Administrator account	✓
User account	Configurable
Explorer shell	✓
Registry filter	✓
Internet Explorer 6.0 + SP2	✓
Internet information service (IIS)	-
Terminal service	✓
Windows Firewall	✓
MSN-Explorer	-
Outlook Express	-
Administrative Tools	✓
Remote Desktop	✓
Remote Assistance	-
.NET Framework	-
ASP.NET	-
Codepages/User Locale/Keyboard	✓
Disk Management Service	✓
Windows Installer Service	✓
Class Installer	✓
CoDevice Installer	✓
Media Player	-
DirectX	-
Accessories	✓
Number of fonts	89

Table 356: Device functions in Windows XP Embedded with FP2007

## 6.3 Installation

Upon request, Windows XP Embedded can be preinstalled at B&R Austria on a suitable CompactFlash card (min. 512 MB). The APC620 system is then automatically configured after it has been switched on for the first time. This procedure takes approximately 30 minutes, and the device will be rebooted a number of times.

Brief instructions for creating your own Windows XP Embedded images or a suitable Target Designer export file for 815E or 855GME CPU boards can be downloaded from the download area on the B&R homepage ([www.br-automation.com](http://www.br-automation.com)).

## 6.4 Graphics drivers

Already included in the B&R Windows XP Embedded image for 815E and 855GME CPU boards.

## 6.5 Touch screen driver

The touch screen driver must be manually installed in order to operate Automation Panel 900 touch screen devices. The driver installation is identical to the driver installation for Windows XP Professional Systems. For more information, see 5.3 "Touch screen driver", on page 578

The driver can be downloaded from the download area on the B&R homepage ([www.br-automation.com](http://www.br-automation.com)).

## 6.6 Audio driver

Already integrated in the B&R Windows XP Embedded image for 815E and 855GME CPU boards.

### 6.6.1 After a BIOS upgrade

If the following error message appears after upgrading BIOS:

```
"Copy Error"
```

```
"Setup cannot copy the file Audio3d.dll"
```

then the audio driver must be reinstalled.

To do this, use the audio driver from the B&R Homepage ([www.br-automation.com](http://www.br-automation.com)).

During the installation of the audio driver, the following 2 files must be manually selected from the following directories.

```
ksuser.dll in the directory ...\\Windows\\system32
```

```
ks.sys in the directory ...\\Windows\\system32\\drivers
```

This applies to 815E and 855ME CPU boards.

The graphics driver must be re-installed to enable all possible resolutions when using an 815E CPU board (see 5.2.1 "Installing the graphics driver for 815E (ETX) CPU boards").

## 6.7 Network driver

Already integrated in the B&R Windows XP Embedded image for 815E and 855GME CPU boards.

## 6.8 FAQ

### 6.8.1 Why does the B&R device restart when shutdown?

If the APC620 is connected with a B&R device, then the option "USB root hubs" must be disabled in the Windows XP Embedded device manager under "Universal Serial Bus controllers" using the following dialog box: **Properties > Power Management > Allow the computer to turn off this device to save power.**

## 7. Automation PC 620 with Windows Embedded Standard 2009



Figure 293: Windows Embedded Standard 2009 Logo

Model number	Short description	Note
5SXXWP.0712-ENG	<b>Windows Embedded Standard 2009 APC620 855GME ETX</b> Microsoft OEM Windows Embedded, Standard 2009, English; for APC620 with ETX CPU board with 855GME chipset; order CompactFlash separately (at least 1 GB).	
5SXXWP.0713-ENG	<b>Windows Embedded Standard 2009 APC620 855GME XTX</b> Microsoft OEM Windows Embedded, Standard 2009, English; for APC620 with XTX CPU board with 855GME chipset; order CompactFlash separately (at least 1 GB).	

Table 357: Model numbers - Windows Embedded Standard 2009

### 7.1 General information

Windows XP Embedded Standard 2009 is the modular version of the desktop operating system Windows XP Professional with Service Pack 3. Windows XP Embedded Standard 2009 is based on the same binary files as Windows XP Professional with Service Pack 3 and is optimally tailored to the hardware being used. In other words, only the functions and modules required by the respective device are included. Windows XP Embedded Standard 2009 is also based on the same reliable code as Windows XP Professional with SP3. It provides industry with leading reliability, improvements in security and performance, and the latest technology for Web browsing and extensive device support.

## 7.2 Features with WES2009 (Windows Embedded Standard 2009)

The feature list shows the most important device functions in Windows Embedded Standard 2009.

Function	Present
Enhanced write filter (EWF)	✓
File Based Write Filter	✓
Page file	Configurable
Administrator account	✓
User account	Configurable
Explorer shell	✓
Registry filter	✓
Internet Explorer 7.0	✓
Internet information service (IIS)	-
Terminal service	✓
Windows Firewall	✓
MSN-Explorer	-
Outlook Express	-
Administrative Tools	✓
Remote Desktop	✓
Remote Assistance	-
.NET Framework	-
ASP.NET	-
Local Network Bridge	✓
Codepages/User Locale/Keyboard	✓
Disk Management Service	✓
Windows Installer Service	✓
Class Installer	✓
CoDevice Installer	✓
Media Player 6.4	✓
DirectX 9.0c	✓
Accessories	✓
Number of fonts	89

Table 358: Device functions in Windows Embedded Standard 2009

## 7.3 Installation

Upon request, Windows Embedded Standard 2009 can be preinstalled at B&R Austria on a suitable CompactFlash card (min. 1GB). The APC620 system is then automatically configured after it has been switched on for the first time. This procedure takes approximately 30 minutes, and the device will be rebooted a number of times.

## 7.4 Drivers

All drivers required for operation are preinstalled on the operating system. If an older driver version is installed, the latest version can be downloaded from the B&R homepage ([www.br-automation.com](http://www.br-automation.com)) and installed. A potentially activated "Enhanced Write Filter (EWF)" must be taken into consideration.

### 7.4.1 Touch screen driver

The touch screen driver must be manually installed in order to operate Automation Panel 800 or Automation Panel 900 touch screen devices. The driver can be downloaded from the download area on the B&R homepage ([www.br-automation.com](http://www.br-automation.com)). A potentially activated "Enhanced Write Filter (EWF)" must be taken into consideration.

## Information:

**Required drivers can only be downloaded from the B&R homepage, not from manufacturers' pages.**

## 8. Automation PC 620 with Windows CE



Model number	Short description	Note
5SWWCE.0512-ENG	<b>WinCE5.0 Pro APC620 E855GME</b> Order Microsoft Windows CE 5.0 Professional, English, including license, for APC620 with CPU boards 5PC600.E855-00, 5PC600.E855-01, 5PC600.E855-02, 5PC600.E855-03, 5PC600.E855-04, 5PC600.E855-05; CompactFlash separately (at least 128 MB).	
5SWWCE.0513-ENG	<b>WinCE5.0 Pro APC620 X855GME</b> Order Microsoft Windows CE 5.0 Professional, English, including license, for APC620 with CPU boards 5PC600.X855-00, 5PC600.X855-01, 5PC600.X855-02, 5PC600.X855-03, 5PC600.X855-04, 5PC600.X855-05; CompactFlash separately (at least 128 MB).	
5SWWCE.0612-ENG	<b>WinCE5.0 ProPlus APC620 E855GME</b> Order Microsoft Windows CE 5.0 Professional Plus, English, including license, for APC620 with CPU boards 5PC600.E855-00, 5PC600.E855-01, 5PC600.E855-02, 5PC600.E855-03, 5PC600.E855-04, 5PC600.E855-05; CompactFlash separately (at least 128 MB).	
5SWWCE.0613-ENG	<b>WinCE5.0 ProPlus APC620 X855GME</b> Order Microsoft Windows CE 5.0 Professional Plus, English, including license, for APC620 with CPU boards 5PC600.X855-00, 5PC600.X855-01, 5PC600.X855-02, 5PC600.X855-03, 5PC600.X855-04, 5PC600.X855-05; CompactFlash separately (at least 128 MB).	
5SWWCE.0812-ENG	<b>WinCE6.0 Pro APC620 E855GME</b> Order Microsoft Windows CE 6.0 Professional, English, including license, for APC620 with CPU boards 5PC600.E855-00, 5PC600.E855-01, 5PC600.E855-02, 5PC600.E855-03, 5PC600.E855-04, 5PC600.E855-05; CompactFlash separately (at least 128 MB).	
5SWWCE.0813-ENG	<b>WinCE6.0 Pro APC620 X855GME</b> Order Microsoft Windows CE 6.0 Professional, English, including license, for APC620 with CPU boards 5PC600.X855-00, 5PC600.X855-01, 5PC600.X855-02, 5PC600.X855-03, 5PC600.X855-04, 5PC600.X855-05; CompactFlash separately (at least 128 MB).	

Table 359: Model numbers - Windows CE

### 8.1 General information

B&R Windows CE is an operating system which is optimally tailored to B&R's devices. It includes only the functions and modules which are required by each device. This makes this operating system extremely robust and stable. A further advantage of B&R Windows CE compared to other operating systems are the low licensing costs.

## 8.2 Windows CE 5.0 features

Detailed information about Windows CE for B&R devices can be downloaded in the download area on the B&R homepage ([www.br-automation.com](http://www.br-automation.com)).

Features	Windows CE 5.0
Supported screen resolutions	VGA (TFT), SVGA (TFT), XGA (TFT)
Chipset	Intel 855GME
Color depth	16 bit or 65536 colors <sup>1)</sup>
Graphics card driver	Intel(R) embedded graphics driver
Main memory	Automatic detection and use of up to 512 MB RAM
Boot time / Startup time	Approx. 39 seconds
Screen rotation	not supported
Web browser	Internet Explorer
.NET	Compact Framework
Image size	Approx. 31 MB <sup>2)</sup> , uncompressed
Custom keys	Supported
PVI	Supported
Automation Device Interface	Supported
Remote Desktop Protocol for thin clients	Supported
B&R VNC Viewer	Supported
B&R Task Manager	Supported
B&R Picture Viewer	Supported
Compatible with zenOn	Yes
Compatible with Wonderware	No
Serial interfaces for any use	3
DirectX	No
Audio ports	"Line OUT" and "MIC" are supported. "Line IN" is not supported.

Table 360: Windows CE 5.0 features

1) The color depth depends on the display used.

2) Use the function "*Compress Windows CE Image*" in the B&R Embedded OS Installer to reduce the image size.



### 8.3 Windows CE 6.0 features

Detailed information about Windows CE for B&R devices can be downloaded in the download area on the B&R homepage ([www.br-automation.com](http://www.br-automation.com)).

Features	Windows CE 6.0
Supported screen resolutions	VGA (TFT), SVGA (TFT), XGA (TFT)
Chipset	Intel 855GME
Color depth	16 bit or 65536 colors <sup>1)</sup>
Graphics card driver	Intel® embedded graphics driver
Main memory	Automatic detection and use of up to 512 MB RAM
Boot time / Startup time	Approx. 20 seconds
Screen rotation	not supported
Web browser	Internet Explorer
.NET	Compact Framework
Image size	Approx. 33 MB <sup>2)</sup> , uncompressed
Custom keys	Supported
PVI	Supported
Automation Device Interface	Supported
Remote Desktop Protocol for thin clients	Supported
B&R VNC Viewer	Supported
B&R Task Manager	Supported
B&R Picture Viewer	Supported
Compatible with zenOn	Yes
Compatible with Wonderware	No
Serial interfaces for any use	3
DirectX	No
Audio ports	"Line OUT" and "MIC" are supported. "Line IN" is not supported.

Table 361: Windows CE 6.0 features

1) The color depth depends on the display used.

2) Use the function "*Compress Windows CE Image*" in the B&R Embedded OS Installer to reduce the image size.

### 8.4 Differences between Windows CE 6.0 and Windows CE 5.0

- 2 GB of virtual RAM per process (Windows CE 5.0: 32 MB).
- Simultaneous operation of up to 32,000 processes (Windows CE 5.0: 32 processes).

## 8.5 Requirements

The device must fulfill the following criteria to be able run the Windows CE operating system.

- At least 128 MB main memory.
- At least one 128 MB CompactFlash card (size should be specified when ordered).

## 8.6 Installation

Windows CE is usually preinstalled at the B&R plant.

### 8.6.1 B&R Embedded OS Installer

The B&R Embedded OS Installer allows you to install existing B&R Windows CE images. The four files (NK.BIN, BLDR, LOGOXRES.BMP, and LOGOQVGA.BMP) must be provided from an already functioning B&R Windows CE installation.

The B&R Embedded OS Installer can be downloaded from the download area on the B&R homepage ([www.br-automation.com](http://www.br-automation.com)). Further information is available in the online help for the B&R Embedded OS Installer.

## 9. B&R Automation Device Interface (ADI) driver - Control Center

The ADI (Automation Device Interface) driver enables access to specific functions of B&R devices. Settings for this device can be read and edited using the B&R Control Center applet in the control panel.

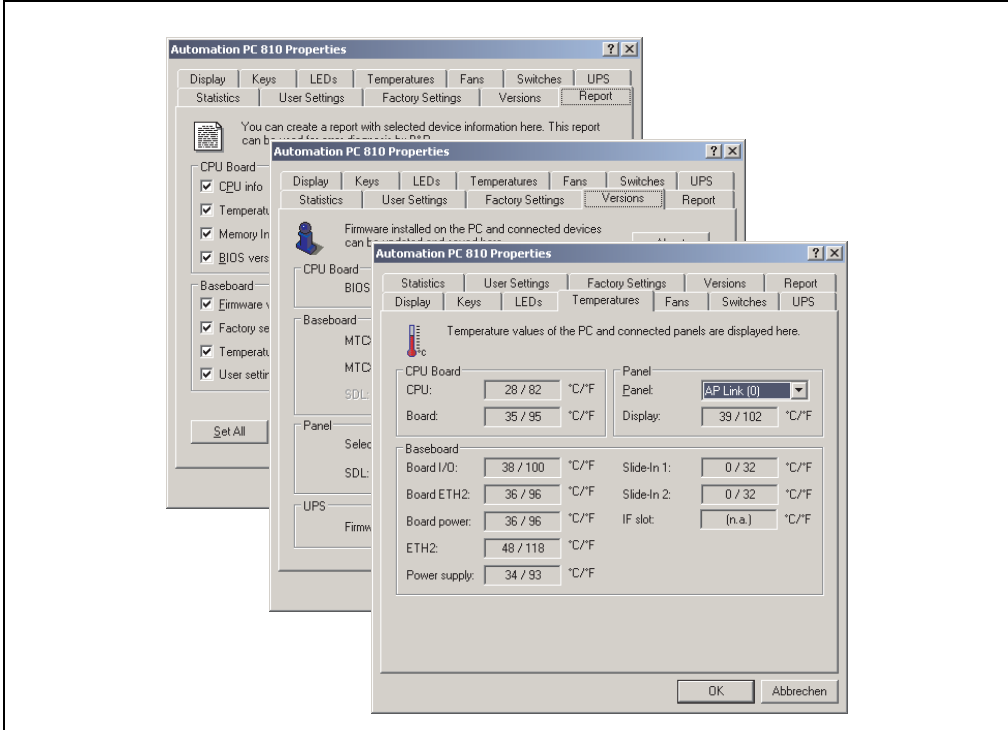

Figure 294: ADI Control Center screenshots - Example (symbol photo)

### Information:

The displayed temperature and voltage values (e.g. CPU temperature, core voltage, battery voltage) on the corresponding ADI page represent uncalibrated information values. These cannot be used to draw any conclusions about any hardware alarms or error conditions. The hardware components used have automatic diagnostics functions that can be applied in the event of error.

## 9.1 Features

### Information:

The functions provided by the Automation Device Interface (ADI) - Control Center vary according to device series.

- Adjusting the display-specific parameters of connected Panels
- Reading of device-specific keys
- Activation of device specific LEDs on a foil keypad
- Reading temperatures, fan speeds, statistical data, and switch settings
- Reading user settings and factory settings
- Reading software versions
- Updating and securing firmware
- Creating reports about the current system (support assistance)
- Setting the SDL equalizer value for the SDL cable adjustment
- Configuring an optional mounted UPS
- Change the user serial ID.

Supports following systems:

- Automation PC 620
- Automation PC 810
- Automation PC 820
- Panel PC 300
- Panel PC 700
- Panel PC 725
- Panel PC 800
- Power Panel 100/200
- Power Panel 300/400
- Power Panel 500
- Mobile Panel 40/50
- Mobile Panel 100/200
- Automation Panel 800 (in connection with Automation PCs and Panel PCs)
- Automation Panel 900 (in connection with Automation PCs and Panel PCs)

## 9.2 Installation

A detailed description of the Control Center can be found in the integrated online help. The B&R Automation Device Interface (ADI) driver (also contains Control Center) can be downloaded for free from the download area on the B&R homepage ([www.br-automation.com](http://www.br-automation.com)).

1. Download and unzip the ZIP archive
  2. Close all applications
  3. Run BrSetup.exe (e.g. double-click on it in Explorer).
- or -
1. Right click on BrSetup.inf in explorer and select "Install".

### Information:

The ADI driver is already included in the B&R images of embedded operating systems.

If a more current ADI driver version exists (see the B&R homepage download area), it can be installed later. A potentially activated "Enhanced Write Filter (EWF)" must be taken into consideration when installing.

### 9.3 SDL equalizer setting

- 1) Start the **Control Center** in the **Control Panel**.
- 2) Then select the **Display** tab.
- 3) Click on **Settings**. This opens the following dialog box:

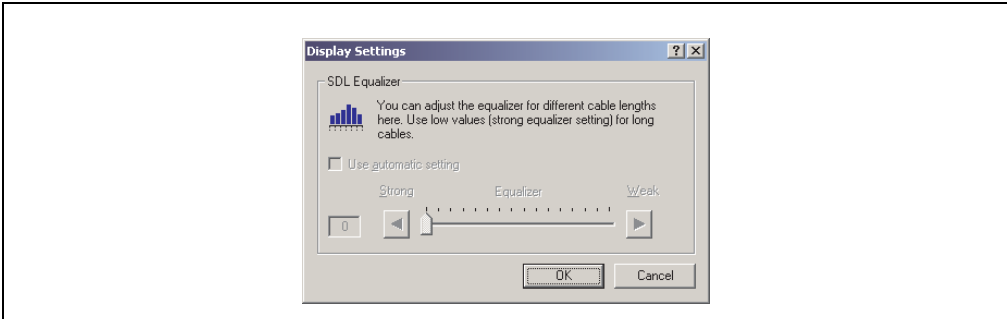

Figure 295: ADI Control Center - SDL equalizer settings

You can change the display's SDL equalizer settings in this dialog box. The equalizer is integrated in the Automation Panel and adapts the DVI signal to various cable lengths. The equalizer value is automatically calculated based on the cable length: You may set a different equalizer value in order to obtain the best possible display quality (e.g. with low-quality cables or poor DVI signal quality).

The value is optimally defined for the cable length when using the "Automatic setting".

#### **Information:**

**The equalizer value can only be changed if the function is supported by the panel (panel firmware version 1.04 or higher) and if MTCX PX32 version 1.54 or higher is installed. Otherwise, the dialog fields are disabled.**

## 9.4 UPS configuration

Here you can view the status values for an optionally installed B&R APC add-on UPS as well as change, update or save the battery settings for the UPS. You can also configure the system settings for the UPS.

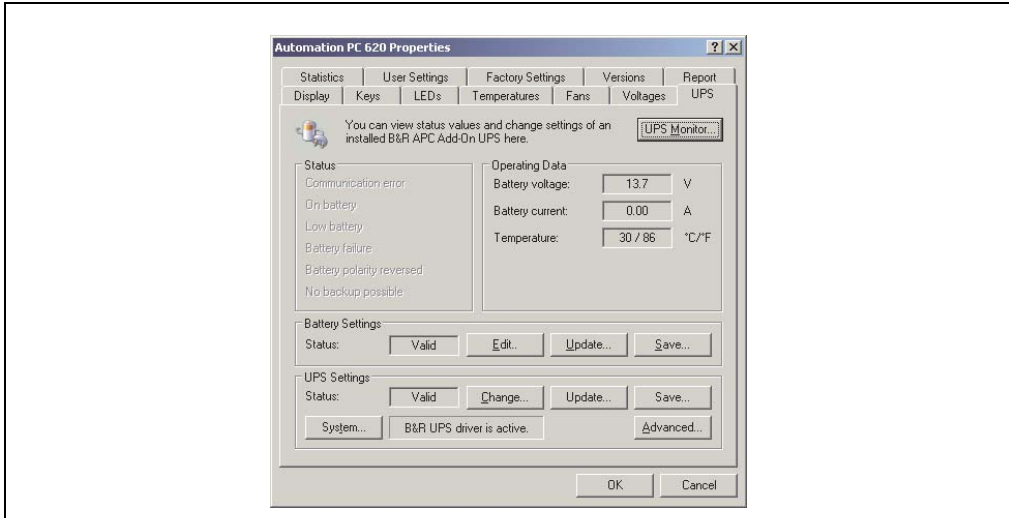

Figure 296: ADI Control Center - UPS settings

### Caution!

The installed UPS must be selected and configured in the Control Panel using the energy options in order for battery operation to be supported.

### Information for Windows XP Embedded:

The UPS service is supported starting with B&R Windows Embedded Version 2.10 or higher.

#### 9.4.1 Installing the UPS service for the B&R APC add-on UPS

- 1) Open the **Control Center** in the **Control Panel**.
- 2) Select **UPS** tab.
- 3) Click on **System** under **UPS settings**. This opens the **Power Options** in the **Control Panel**. (The **Power Options** can also be opened directly from the **Control Panel**.)
- 4) Select the **UPS** tab and click **Select....**

- 5) Choose 'Bernecker + Rainer' as manufacturer and 'APC Add-On UPS' as model and then click **Finish**. The value for the COM connection is only required for a serially connected UPS and is ignored by the APC add-on UPS driver.
- 6) Click on **Apply** to begin UPS operation. After a few seconds the UPS status and details are displayed.
- 7) Click **OK**.
- 8) The text field beside **System** (on the **UPS** tab in the **Control Center**) also indicates whether the B&R UPS driver is active.

## Information:

- **Administrator rights are required in order to change the energy options or display the UPS status.**

### 9.4.2 Displaying UPS status values

- 1) Open the **Control Center** in the **Control Panel**.
- 2) Select **UPS** tab.

The displayed values are updated automatically.

## Information:

**The "reversed battery polarity" status is only displayed in UPS firmware version 1.08 or higher.**

**In UPS firmware Version 1.07 or smaller, a change between battery operation and normal operation can lead to communication errors.**

- 3) **Select UPS monitor** to display UPS status changes since the last time the system or UPS driver was started.



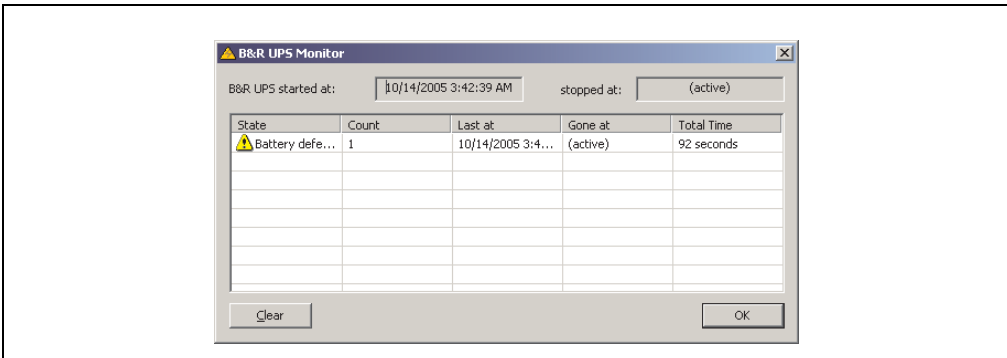

Figure 297: ADI Control Center - UPS monitor

The dialog box is updated automatically when the status changes.

To remove a status from the list, click on **delete**.

## Information:

The current status of the UPS is also displayed when the UPS service is started in the Windows Control Panel on the UPS page in the energy options.

## Information:

In a German version of Windows XP Professional the battery status is displayed as "low" in the energy options, even if the battery is OK (Windows error). In an English version, three battery status levels are displayed: unknown, OK, replace A low battery status is never displayed.

### 9.4.3 Changing UPS battery settings

- 1) Open the **Control Center** in the **Control Panel**.
- 2) Select **UPS** tab.
- 3) Under "Battery settings," click on **Edit**. Clicking on "Open" opens a dialog box.
- 4) Select and **open** the file containing the battery settings.

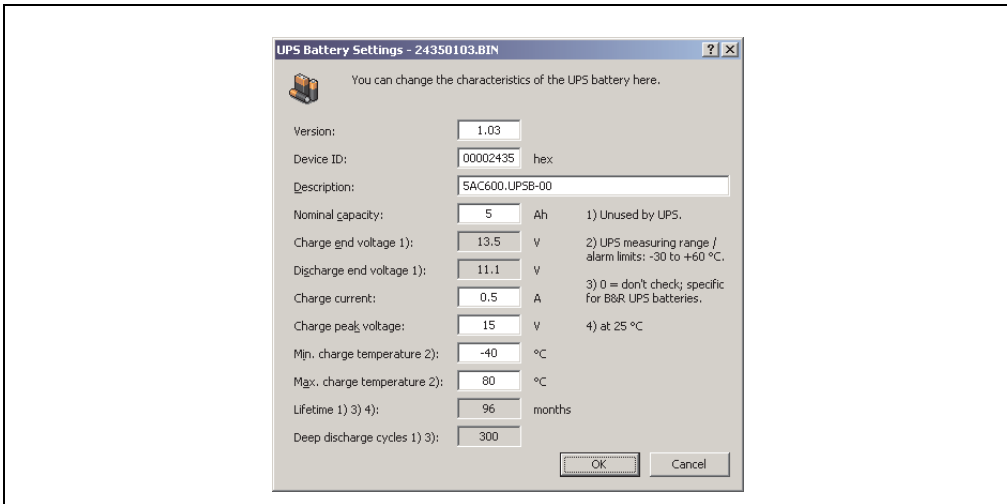

Figure 298: ADI Control Center - UPS battery settings

In this dialog box you can change the settings for the UPS battery.

The changed settings are written to the file by clicking on the **OK** button. The battery settings for the UPS can then be updated with this file.

## Information:

**To make settings for batteries not from B&R, it is best to make a copy of a file with battery settings from B&R under a new name and make adjust the settings in this file for the battery being used.**

Current files with settings for batteries from B&R can be found on the B&R APC620 / PPC700 firmware upgrade disk (starting with V1.16) and can also be updated using these.

## Information:

- The current UPS firmware version 1.10 does not use charge end voltage, deep discharge voltage, lifespan and deep discharge cycles.
- Lifespan is only included in version 2 (and higher) of the UPS battery settings and only valid for B&R UPS batteries at 25°C ambient temperature.
- Deep discharge cycles are only included in version 3 (and higher) of the UPS battery settings and only valid for B&R UPS batteries.

## Information:

If you would like to change the current battery settings on the UPS, they must first be saved in a file.

### 9.4.4 Updating UPS battery settings

- 1) Open the **Control Center** in the **Control Panel**.
- 2) Select **UPS** tab.
- 3) Under **Battery settings**, click on **Update**. Clicking on "Open" opens a dialog box.
- 4) Select and **open** the file containing the battery settings. The "Download" dialog box is opened.

The transfer can be aborted by clicking on **Cancel** in the Download dialog box. **Cancel** is disabled when the flash memory is being written to.

## Caution!

- **The UPS cannot be operated while updating the battery settings.**
- **If the transfer is interrupted, then the procedure must be repeated until the battery settings have been updated successfully. Otherwise battery operation will no longer be possible.**

Deleting the data in flash memory can take several seconds depending on the memory block being used. The progress indicator is not updated during this time.

## Information:

The UPS is automatically restarted after a successful download. This can cause a brief failure in the UPS communication.

### 9.4.5 Saving UPS battery settings

- 1) Open the **Control Center** in the **Control Panel**.
- 2) Select **UPS** tab.
- 3) Under "Battery settings", click on **Save**. Clicking on "Save under" opens a dialog box.
- 4) Enter a file name or select an existing file and click on **Save**.

## Information:

**UPS settings can only be saved using UPS firmware version 1.10 and higher.**

The transfer can be aborted by clicking on **Cancel** in the Download dialog box.

### 9.4.6 Configuring UPS system settings

- 1) Open the **Control Center** in the **Control Panel**.
- 2) Select **UPS** tab.
- 3) Click on **System** under **UPS settings**. The energy options dialog box in the Control Panel is opened.

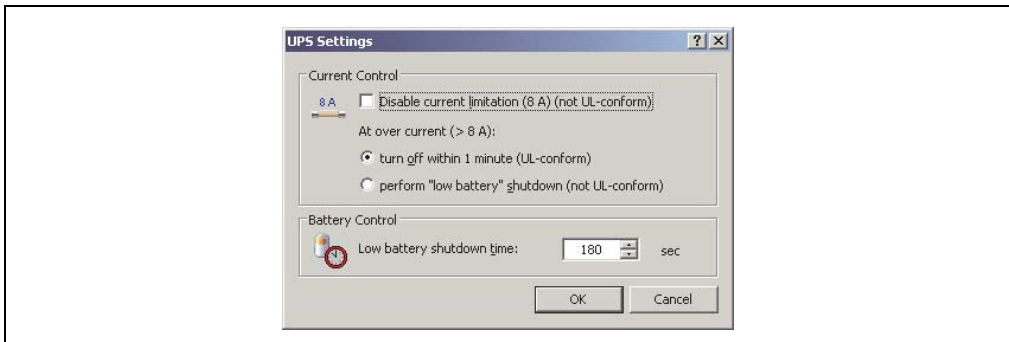

Figure 299: ADI Control Center - UPS settings

Further information regarding the UPD system settings can be found in the Windows help.

## Information:

- UPS settings can only be changed using UPS firmware version 1.10 and higher. If there are no changed settings on the UPS, then the factory or default settings are used.
- The UPS is automatically restarted after UPS settings have been changed. This can cause a brief disruption in communication with the UPS.
- Administrator rights are required in order to change the energy options or display the UPS status.

### Disabling 8 A current limitation

## Information:

It is not UL compliant to switch off the 8 A current limitation on devices during battery operation!

"Low Battery" shutdown caused by an over-current of > 8 A on devices during battery operation is not UL compliant!

Select the checkbox **Disable current limitation (8 A)**.

If current limitation is enabled (checkbox deselected), then the UPS uses battery operation to check whether the UPS battery is discharged with 8 A for longer than 16 seconds. If so, then an overcurrent alarm is sent to the PC.

## Information:

**Current limitation is only supported with UPS firmware version 1.10 and higher.**

Enabling one of the two following options determines how the UPS should perform when an overcurrent alarm occurs:

If **Turn-off within 1 minute** is selected, then the UPS will turn-off within one when an overcurrent alarm occurs.

## Warning!

**The operating system will not be properly shut down if an overcurrent alarm occurs!**

If **Perform "low battery" shutdown** is selected, then the UPS will also signal a "Low battery alarm" in addition to the overcurrent alarm and will turn off after the defined **Low battery shutdown time**. This will allow the operating system to shut down properly when UPS service is enabled.

## Changing the UPS shutdown time when battery is low

Enter the "**Low Battery**" **shutdown time** in seconds. This is the amount of time that the UPS will wait before shutting off the power supply when the battery level is low.

This prevents the UPS battery from becoming too discharged if the Windows UPS service is not enabled and the UPS is therefore not turned off by the operating system.

If the UPS service is enabled, then the UPS will be turned off by the operating system when the battery level is low, based on the Windows UPS service **Turn-off delay** (see 9.4.7 "Changing additional UPS settings"). The **low battery shutdown time** will then be ignored.

### Information:

- The low battery shutdown time must be set to at least 60 seconds, so that the operating system has enough time to send the shutdown command to the UPS when the battery level is low (normally occurs after approximately 30 seconds).
- The low battery shutdown time can only be set in UPS firmware version 1.10 and later. UPS firmware version 1.08 always uses a turn off delay time of 180 seconds. UPS firmware versions earlier than 1.08 do not shut down automatically when the battery level is low.

### 9.4.7 Changing additional UPS settings

- 1) Open the **Control Center** in the **Control Panel**.
- 2) Select **UPS** tab.
- 3) Click on **Advanced** under **UPS settings**. This opens the following dialog box:



Figure 300: ADI Control Center - Advanced UPS settings

## Information:

Administer rights are required in order to display this dialog box.

### Change turn-off time for UPS

The **Shutdown time** can be specified in seconds under **Windows UPS service**. This is the length of time that the UPS waits before switching off the power supply. When a critical alarm occurs (e.g. at low battery level), the Windows UPS service will send a shutdown command with the turn off delay time to the UPS and will shut down the system.

## Information:

This time is evaluated by the Windows UPS Service, but can not be set in the UPS system settings of the energy options. This value should only be changed if the system requires longer than the default setting of 180 seconds to shut down.

## Caution!

The time entered must be longer than the time required to shut down the operating system.

### Activate UPS messages

Under "B&R UPS driver", activate the checkbox "UPS status messages". Any changes to the UPS status will then trigger a message from the B&R UPS driver.

## Information:

Shutting down the system is only reported by the Windows UPS Service. The UPS Service also sends other messages if they are activated in the UPS system settings energy options. These messages are only displayed when the Windows Alerter and Windows Messenger<sup>1)</sup> are active and the PC is logged on to a network. Additionally, some conditions of the B&R APC620 UPS are not detected by the Windows UPS Service, and are therefore do not trigger messages (e.g. when there are no battery settings on the UPS). The Windows Services can be found in the Control Panel under Administrative Tools - Services.

<sup>1)</sup> The Windows Alerter is supported starting with B&R Windows Embedded Version 2.10 or higher.

If the checkbox **Display UPS status with UPS monitor** is also activated, a new message is not displayed for every change, but only a general message and request for you to start the B&R UPS monitor. As long as the UPS monitor is active, no new messages are displayed.

## Information:

Regardless of these options, all changes to the UPS status are logged in Windows event protocol (under "Application").

### 9.4.8 Procedure following power failure

#### Over-current shutdown

If an over-current >8 A is present during battery operation for a duration of 16 seconds, the over-current shutdown is executed. A turn-off time of one minute is available to the system.

If the supply is regenerated during this time, then the shut down process is aborted.

## Information:

The over-current shutdown has the highest priority.

#### Low battery shutdown

If the LowBatteryFlag is set during power failure, then the "low battery" shutdown is executed, preventing the battery from fully discharging. Once the turn-off time expires (3 minutes by default), the UPS shuts down.

If an "over-current" shutdown or "standard" shutdown is detected during the shutdown process, the "low battery" shutdown is replaced by the respective process.

#### Standard shutdown

The standard shutdown is effective when the UPS service is active, the turn-off time is 3 minutes by default.

If the supply voltage returns during the turn-off time, then the shutdown procedure will be stopped.

If the supply voltage returns during the shutdown process, then the shutdown timer will run until the APC620 enters standby mode and will then reboot the system.



# Chapter 5 • Standards and certifications

## 1. Applicable European directives

- EMC directive 2004/108/EG
- Low-voltage directive 2006/95/EG
- Machine directives 98/37/EG beginning 12/29/2009: 2006/42/EG

## 2. Overview of standards

Standard	Description
EN 55011 Class A	Electromagnetic compatibility (EMC), radio disturbance product standard, industrial, scientific, and medical high-frequency devices (ISM devices), limit values and measurement procedure; group 1 (devices that do not create HF during material processing) and group 2 (devices that create HF during material processing)
EN 55022 Class A	Electromagnetic compatibility (EMC), radio disturbance characteristics, information technology equipment (ITE devices), limits and methods of measurement
EN 60060-1	High-voltage test techniques - part 1: General specifications and testing conditions
EN 60068-2-1	Environmental testing - part 2: Tests; test A: Dry cold
EN 60068-2-2	Environmental testing - part 2: Tests; test B: Dry heat
EN 60068-2-3	Environmental testing - part 2: Tests; test and guidance: Damp heat, constant
EN 60068-2-6	Environmental testing - part 2: Tests; test: Vibration (sinusoidal)
EN 60068-2-14	Environmental testing - part 2: Tests; test N: Change of temperature
EN 60068-2-27	Environmental testing - part 2: Tests; test and guidance: Shock
EN 60068-2-30	Environmental testing - part 2: Tests; test and guidance: Damp heat, cyclic
EN 60068-2-31	Environmental testing - part 2: Tests; test: Drop and topple, primarily for equipment-type specimens
EN 60068-2-32	Environmental testing - part 2: Tests; test: Free fall
EN 60204-1	Safety of machinery, electrical equipment on machines - part 1: General requirements
EN 60529	Degrees of protection provided by enclosures (IP code)
EN 60664-1	Insulation coordination for equipment within low-voltage systems - part 1: Principles, requirements and tests
EN 60721-3-2	Classification of environmental conditions - part 3: Classification of groups of environmental parameters and their severities, section 2: Transport
EN 60721-3-3	Classification of environmental conditions - part 3: Classification of groups of environmental parameters and their severities, section 3: Stationary use at weather-protected locations

Table 362: Overview of standards

## Standards and certifications • Overview of standards

Standard	Description
EN 61000-4-2	Electromagnetic compatibility (EMC) - part 4-2: Testing and measuring techniques; electrostatic discharge immunity test
EN 61000-4-3	Electromagnetic compatibility (EMC) - part 4-3: Testing and measuring techniques; radiated radio-frequency electromagnetic field immunity test
EN 61000-4-4	Electromagnetic compatibility (EMC) - part 4-4: Testing and measuring techniques; electrical fast transient/burst immunity test
EN 61000-4-5	Electromagnetic compatibility (EMC) - part 4-5: Testing and measuring techniques; surge immunity test
EN 61000-4-6	Electromagnetic compatibility (EMC) - part 4-6: Testing and measuring techniques; immunity to conducted disturbances, induced by radio-frequency fields
EN 61000-4-8	Electromagnetic compatibility (EMC) - part 4-8: Testing and measuring techniques; power frequency magnetic field immunity test
EN 61000-4-11	Electromagnetic compatibility (EMC) - part 4-11: Testing and measuring techniques; voltage dips, short interruptions and voltage variations immunity tests
EN 61000-4-12	Electromagnetic compatibility (EMC) - part 4-12: Testing and measuring techniques; oscillatory waves immunity test
EN 61000-4-17	Electromagnetic compatibility (EMC) - part 4-12: Testing and measuring techniques; ripple on DC input power port immunity test
EN 61000-4-29	Electromagnetic compatibility (EMC) - part 4-29: Testing and measuring techniques; voltage dips, short interruptions and voltage variations on DC input power port immunity tests
EN 61000-6-2	Electromagnetic compatibility (EMC), generic immunity standard - part 2: industrial environment
EN 61000-6-4	Electromagnetic compatibility (EMC), generic emission standard - part 2: industrial environment
EN 61131-2	Product standard, programmable logic controllers - part 2: Equipment requirements and tests
UL 508	Industrial control equipment (UL = Underwriters Laboratories)
47 CFR	Federal Communications Commission (FCC), 47 CFR Part 15 Subpart B Class A

Table 362: Overview of standards (Forts.)

### 3. Emission requirements (emission)

Emissions	Test carried out according to	Limits according to
Network-related emissions	EN 55011 / EN 55022	EN 61000-6-4: Generic standard (industrial areas)
		EN 55011: Industrial, scientific, and medical (ISM) radio-frequency equipment, class A (industrial areas)
		EN 55022: Information technology equipment (ITE devices), class A (industrial areas)
		EN 61131-2: Programmable logic controllers
		47 CFR Part 15 Subpart B Class A (FCC)
Emissions, Electromagnetic emissions	EN 55011 / EN 55022	EN 61000-6-4: Generic standard (industrial areas)
		EN 55011: Industrial, scientific, and medical (ISM) radio-frequency equipment, class A (industrial areas)
		EN 55022: Information technology equipment (ITE devices), class A (industrial areas)
		EN 61131-2: Programmable logic controllers
		47 CFR Part 15 Subpart B Class A (FCC)

Table 363: Overview of limits and testing guidelines for emissions

### 3.1 Network-related emissions

Test carried out according to EN 55011 / EN 55022	Limits according to EN 61000-6-4	Limits according to EN 55011 Class A	Limits according to EN 55022 Class A
Power mains connections 150 kHz - 500 kHz	-	79 dB (µV) Quasi-peak value 66 dB (µV) Average	79 dB (µV) Quasi-peak value 66 dB (µV) Average
Power mains connections 500 kHz - 30 MHz	-	73 dB (µV) Quasi-peak value 60 dB (µV) Average	73 dB (µV) Quasi-peak value 60 dB (µV) Average
AC mains connections 150 kHz - 500 kHz	79 dB (µV) Quasi-peak value 66 dB (µV) Average	-	-
AC mains connections 500 kHz - 30 MHz	73 dB (µV) Quasi-peak value 60 dB (µV) Average	-	-
Other connections 150 kHz - 500 kHz	-	-	97 - 87 dB (µV) und 53 - 43 dB (µA) Quasi-peak value 84 - 74 dB (µV) und 40 - 30 dB (µA) Average
Other connections 500 kHz - 30 MHz	-	-	87 dB (µV) and 43 dB (µA) Quasi-peak value 74 dB (µV) and 30 dB (µA) Average
Test carried out according to EN 55011 / EN 55022	Limits according to EN 61131-2	Limits according to 47 CFR Part 15 Subpart B class A	
Power mains connections <sup>1)</sup> 150 kHz - 500 kHz	79 dB (µV) Quasi-peak value 66 dB (µV) Average	-	
Power mains connections 500 kHz - 30 MHz	73 dB (µV) Quasi-peak value 60 dB (µV) Average	-	
AC mains connections 150 kHz - 500 kHz	-	79 dB (µV) Quasi-peak value 66 dB (µV) Average	
AC mains connections 500 kHz - 30 MHz	-	73 dB (µV) Quasi-peak value 60 dB (µV) Average	

Table 364: Test requirements - Network-related emissions for industrial areas

## Standards and certifications • Emission requirements (emission)

Other connections 150 kHz - 500 kHz	Only informative for cable lengths > 10 m 40 - 30 dB (µA) Quasi-peak value 30 - 20 dB (µA) Average	-	-
Other connections 500 kHz - 30 MHz	Only informative for cable lengths > 10 m 30 dB (µA) Quasi-peak value 20 dB (µA) Average	-	-

Table 364: Test requirements - Network-related emissions for industrial areas (Forts.)

1) AC network connections only with EN 61131-2

### 3.2 Emissions, electromagnetic emissions

Test carried out according to EN 55011 / EN 55022	Limits according to EN 61000-6-4	Limits according to EN 55011 Class A	Limits according to EN 55022 Class A
30 MHz - 230 MHz measured at a distance of 10 m	< 40 dB (µV/m) Quasi-peak value	< 40 dB (µV/m) Quasi-peak value	< 40 dB (µV/m) Quasi-peak value
230 MHz - 1 GHz measured at a distance of 10 m	< 47 dB (µV/m) Quasi-peak value	< 47 dB (µV/m) Quasi-peak value	< 47 dB (µV/m) Quasi-peak value
Test carried out according to EN 55011 / EN 55022	Limits according to EN 61131-2		
30 MHz - 230 MHz measured at a distance of 10 m	< 40 dB (µV/m) Quasi-peak value		
230 MHz - 1 GHz measured at a distance of 10 m	< 47 dB (µV/m) Quasi-peak value		
Test carried out	Limits according to 47 CFR Part 15 Subpart B class A		
30 MHz - 88 MHz measured at a distance of 10 m	< 90 dB (µV/m) Quasi-peak value		
88 MHz - 216 MHz measured at a distance of 10 m	< 150 dB (µV/m) Quasi-peak value		
216 MHz - 960 MHz measured at a distance of 10 m	< 210 dB (µV/m) Quasi-peak value		
> 960 MHz measured at a distance of 10 m	< 300 dB (µV/m) Quasi-peak value		

Table 365: : Test requirements - Electromagnetic emissions for industrial areas

## 4. Requirements for immunity to disturbances (immunity)

Immunity	Test carried out according to	Limits according to
Electrostatic discharge (ESD)	EN 61000-4-2	EN 61000-6-2: Generic standard (industrial areas)
		EN 61131-2: Programmable logic controllers
Immunity against high-frequency electromagnetic fields (HF field)	EN 61000-4-3	EN 61000-6-2: Generic standard (industrial areas)
		EN 61131-2: Programmable logic controllers
Immunity to high-speed transient electrical disturbances (burst)	EN 61000-4-4	EN 61000-6-2: Generic standard (industrial areas)
		EN 61131-2: Programmable logic controllers
Immunity to surge voltages	EN 61000-4-5	EN 61000-6-2: Generic standard (industrial areas)
		EN 61131-2: Programmable logic controllers
Immunity to conducted disturbances	EN 61000-4-6	EN 61000-6-2: Generic standard (industrial areas)
		EN 61131-2: Programmable logic controllers
Immunity against magnetic fields with electrical frequencies	EN 61000-4-8	EN 61000-6-2: Generic standard (industrial areas)
		EN 61131-2: Programmable logic controllers
Immunity to voltage dips, short-term interruptions and voltage fluctuations	EN 61000-4-11	EN 61000-6-2: Generic standard (industrial areas)
		EN 61131-2: Programmable logic controllers
Immunity to damped vibration	EN 61000-4-12	EN 61000-6-2: Generic standard (industrial areas)
		EN 61131-2: Programmable logic controllers

Table 366: Overview of limits and testing guidelines for immunity

Evaluation criteria according to EN 61000-6-2

### Criteria A:

The operating equipment must continue to work as intended **during** the test. There should be no interference in the operating behavior and no system failures below a minimum operating quality as defined by the manufacturer.

### Criteria B:

The operating equipment must continue to work as directed **after** the test. There should be no interference in the operating behavior and no system failures below a minimum operating quality as defined by the manufacturer.

### Criteria C:

A temporary function failure is permitted if the function restores itself, or the function can be restored by activating configuration and control elements.

### Criteria D:

Impairment or failure of the function, which can no longer be established (operating equipment destroyed).

## 4.1 Electrostatic discharge (ESD)

Test carried out according to EN 61000-4-2	Limits according to EN 61000-6-2	Limits according to EN 61131-2	
Contact discharge to powder-coated and bare metal housing parts	±4 kV, 10 discharges, criteria B	±4 kV, 10 discharges, criteria B	
Discharge through the air to plastic housing parts	±8 kV, 10 discharges, criteria B	±8 kV, 10 discharges, criteria B	

Table 367: Test requirements - Electrostatic discharge (ESD)

## 4.2 High-frequency electromagnetic fields (HF field)

Test carried out according to EN 61000-4-3	Limits according to EN 61000-6-2	Limits according to EN 61131-2	
Housing, completely wired	80 MHz - 1 GHz, 10 V/m, 80% amplitude modulation with 1 kHz, length 3 seconds, criteria A	2 GHz - 2.7 GHz, 1 V/m, 1.4 GHz - 2 GHz, 3 V/m, 80 MHz - 1 GHz, 10 V/m, 80% amplitude modulation at 1 kHz, duration 3 seconds, criteria A	

Table 368: Test requirements - High-frequency electromagnetic fields (HF field)

### 4.3 High-speed transient electrical disturbances (burst)

Test carried out according to EN 61000-4-4	Limits according to EN 61000-6-2	Limits according to EN 61131-2	
AC power I/O	±2 kV, criteria B	-	
AC power inputs	-	±2 kV, criteria B	
AC power outputs	-	±1 kV, criteria B	
DC power I/O >10 m <sup>1)</sup>	±2 kV, criteria B	-	
DC power inputs >10 m	-	±2 kV, criteria B	
DC power outputs >10 m	-	±1 kV, criteria B	
Functional ground connections, signal lines and I/Os >3 m	±1 kV, criteria B	±1 kV, criteria B	
Unshielded AC I/O >3 m	-	±2 kV, criteria B	
Analog I/O	±1 kV, criteria B	±1 kV, criteria B	

Table 369: Test requirements - High-speed transient electrical disturbances (burst)

1) For EN 55024 without length limitation.

### 4.4 Surges (surge)

Test carried out according to EN 61000-4-5	Limits according to EN 61000-6-2	Limits according to EN 61131-2	
AC power I/O, L to L	±1 kV, criteria B	±1 kV, criteria B	
AC power I/O, L to PE	±2 kV, criteria B	±2 kV, criteria B	
DC power I/O, L+ to L-, >10 m	±0.5 kV, criteria B	-	
DC power I/O, L to PE, >10 m	±0.5 kV, criteria B	-	
DC power inputs, L+ to L-	-	±0.5 kV, criteria B	
DC power inputs, L to PE	-	±1 kV, criteria B	
DC power outputs, L+ to L-	-	±0.5 kV, criteria B	
DC power outputs, L to PE	-	±0.5 kV, criteria B	
Signal connections >30 m	±1 kV, criteria B	±1 kV, criteria B	
All shielded cables	-	±1 kV, criteria B	

Table 370: Test requirements - Surge voltages

### 4.5 Conducted disturbances

Test carried out according to EN 61000-4-6	Limits according to EN 61000-6-2	Limits according to EN 61131-2	
AC power I/O	150 kHz - 80 MHz, 10 V, 80% amplitude modulation with 1 kHz, length 3 seconds, criteria A	150 kHz - 80 MHz, 3 V, 80% amplitude modulation with 1 kHz, length 3 seconds, criteria A	

Table 371: Test requirements - Conducted disturbances



## Standards and certifications • Requirements for immunity to disturbances (immunity)

Test carried out according to EN 61000-4-6	Limits according to EN 61000-6-2	Limits according to EN 61131-2	
DC power I/O	150 kHz - 80 MHz, 10 V, 80% amplitude modulation with 1 kHz, length 3 seconds, criteria A	150 kHz - 80 MHz, 3 V, 80% amplitude modulation with 1 kHz, length 3 seconds, criteria A	
Functional ground connections	0.15 - 80 MHz, 10 V, 80% amplitude modulation with 1 kHz, Length 3 seconds, criteria A	150 kHz - 80 MHz, 3 V, 80% amplitude modulation with 1 kHz, length 3 seconds, criteria A	
Signal connections >3 m	0.15 - 80 MHz, 10 V, 80% amplitude modulation with 1 kHz, Length 3 seconds, criteria A	150 kHz - 80 MHz, 3 V, 80% amplitude modulation with 1 kHz, length 3 seconds, criteria A	

Table 371: Test requirements - Conducted disturbances (Forts.)

### 4.6 Magnetic fields with electrical frequencies

Test carried out according to EN 61000-4-8	Limits according to EN 61000-6-2	Limits according to EN 61131-2	
Test direction x, test in the field of an induction coil 1 m x 1 m	30 A/m, criteria A	30 A/m, criteria A	
Test direction y, test in the field of an induction coil 1 m x 1 m	30 A/m, criteria A	30 A/m, criteria A	
Test direction z, test in the field of an induction coil 1 m x 1 m	30 A/m, criteria A	30 A/m, criteria A	

Table 372: Test requirements - Magnetic fields with electrical frequencies

## 4.7 Voltage dips, fluctuations and short-term interruptions

Test carried out according to EN 61000-4-11	Limits according to EN 61000-6-2	Limits according to EN 61131-2	
AC power inputs	Voltage dip 70% (30% reduction), 0.5 periods, criteria B	-	
AC power inputs	Voltage dip 40% (60% reduction), 5 periods, criteria C	-	
AC power inputs	Voltage dip 40% (60% reduction), 50 periods, criteria C	-	
AC power inputs	Voltage interruptions < 5% (> 95% reduction), 250 periods, criteria C	-	
AC power inputs	-	20 interruptions, 0.5 periods, criteria A	
DC power inputs	-	20 interruptions for 10 ms < UN - 15%, criteria A	

Table 373: Test requirements - Voltage dips, fluctuations, and short-term interruptions

## 4.8 Damped vibration

Test carried out according to EN 61000-4-12	Limits according to EN 61131-2		
Power I/O, L to L	$\pm 1$ kV, 1 MHz, repeat rate 400/seconds, length 2 seconds, connection lengths 2 m, criteria B		
Power I/O, L to PE	$\pm 2.5$ kV, 1 MHz, repeat rate 400/seconds, length 2 seconds, connection lengths 2 m, criteria B		

Table 374: Test requirements - Damped vibration

## 5. Mechanical conditions

Vibration	Test carried out according to	Limits according to
Vibration operation	EN 60068-2-6	EN 61131-2: Programmable logic controllers
		EN 60721-3-3 class 3M4
Vibration during transport (packaged)	EN 60068-2-6	EN 60721-3-2 class 2M1
		EN 60721-3-2 class 2M2
		EN 60721-3-2 class 2M3
Shock during operation	EN 60068-2-27	EN 61131-2: Programmable logic controllers
		EN 60721-3-3 class 3M4
Shock during transport (packaged)	EN 60068-2-27	EN 60721-3-2 class 2M1
		EN 60721-3-2 class 2M2
		EN 60721-3-2 class 2M3
Toppling (packaged)	EN 60068-2-31	EN 60721-3-2 class 2M1
		EN 60721-3-2 class 2M2
		EN 60721-3-2 class 2M3
Free fall (packaged)	EN 60068-2-32	EN 61131-2: Programmable logic controllers

Table 375: Overview of limits and testing guidelines for vibration

### 5.1 Vibration operation

Test carried out according to EN 60068-2-6	Limits according to EN 61131-2		Limits according to EN 60721-3-3 class 3M4		
	Frequency	Limit value	Frequency	Limit value	
Vibration during operation: Uninterrupted duty with moveable frequency in all 3 axes (x, y, z), 1 octave per minute	10 sweeps for each axis		10 sweeps for each axis		
	5 - 9 Hz	Amplitude 3.5 mm	2 - 9 Hz	Amplitude 3 mm	
	9 - 150 Hz	Acceleration 1 g	9 - 200 Hz	Acceleration 1 g	

Table 376: Test requirements - Vibration during operation

## 5.2 Vibration during transport (packaged)

Test carried out according to EN 60068-2-6	Limits according to EN 60721-3-2 class 2M1		Limits according to EN 60721-3-2 class 2M2		Limits according to EN 60721-3-2 class 2M3	
Vibration during transport: Uninterrupted duty with moveable frequency in all 3 axes (x, y, z)	10 sweeps for each axis, packaged		10 sweeps for each axis, packaged		10 sweeps for each axis, packaged	
	Frequency	Limit value	Frequency	Limit value	Frequency	Limit value
	2 - 9 Hz	Amplitude 3.5 mm	2 - 9 Hz	Amplitude 3.5 mm	2 - 8 Hz	Amplitude 7.5 mm
	9 - 200 Hz	Acceleration 1 g	9 - 200 Hz	Acceleration 1 g	8 - 200 Hz	Acceleration 2 g
	200 - 500 Hz	Acceleration 1.5 g	200 - 500 Hz	Acceleration 1.5 g	200 - 500 Hz	Acceleration 4 g

Table 377: Test requirements - Vibration during transport (packaged)

## 5.3 Shock during operation

Test carried out according to EN 60068-2-27	Limits according to EN 61131-2	Limits according to EN 60721-3-3 class 3M4	
Shock during operation: Pulse (half-sine) stress in all 3 axes (x, y, z)	Acceleration 15 g, duration 11 ms, 18 shocks	Acceleration 15 g, duration 11 ms	

Table 378: Test requirements - Shock during operation

## 5.4 Shock during transport (packaged)

Test carried out according to EN 60068-2-27	Limits according to EN 60721-3-2 class 2M1	Limits according to EN 60721-3-2 class 2M2	Limits according to EN 60721-3-2 class 2M3
Pulse (half-sine) stress in all 3 axes (x, y, z)	Acceleration 10 g, Length 11 ms, each 3 shocks, packaged	Acceleration 30 g, Length 6 ms, each 3 shocks, packaged	Acceleration 100 g, Length 6 ms, each 3 shocks, packaged

Table 379: Test requirements - Shock during transport

## 5.5 Toppling

Test carried out according to EN 60068-2-31	Limits according to EN 60721-3-2 class 2M1		Limits according to EN 60721-3-2 class 2M2		Limits according to EN 60721-3-2 class 2M3	
Drop and topple	Devices: Drop/topple on each edge		Devices: Drop/topple on each edge		Devices: Drop/topple on each edge	
	Weight	Required	Weight	Required	Weight	Required
	<20 kg	Yes	<20 kg	Yes	<20 kg	Yes
	20 - 100 kg	-	20 - 100 kg	Yes	20 - 100 kg	Yes
	>100 kg	-	>100 kg	-	>100 kg	Yes

Table 380: Test requirements - Toppling

5.6 Free fall (packaged)

Test carried out according to EN 60068-2-32	Limits according to EN 61131-2		Limits according to EN 60721-3-2 class 2M1		Limits according to EN 60721-3-2 class 2M2		Limits according to EN 60721-3-2 class 2M3	
Free fall	Devices with delivery packaging each with 5 fall tests		Devices packaged		Devices packaged		Devices packaged	
	<b>Weight</b>	<b>Height</b>	<b>Weight</b>	<b>Height</b>	<b>Weight</b>	<b>Height</b>	<b>Weight</b>	<b>Height</b>
	<10 kg	1.0 m	<20 kg	0.25 m	<20 kg	1.2 m	<20 kg	1.5 m
	10 - 40 kg	0.5 m	20 - 100 kg	0.25 m	20 - 100 kg	1.0 m	20 - 100 kg	1.2 m
	> 40 kg	0.25 m	>100 kg	0.1 m	>100 kg	0.25 m	>100 kg	0.5 m
	Devices with product packaging each with 5 fall tests							
	<b>Weight</b>	<b>Height</b>						
	<10 kg	0.3 m						
	10 - 40 kg	0.3 m						
	> 40 kg	0.25 m						

Table 381: Test requirements - Toppling

## 6. Climate conditions

Temperature / humidity	Test carried out according to	Limits according to
Worst case operation	UL 508	UL 508: Industrial control equipment EN 61131-2: Programmable logic controllers
Dry heat	EN 60068-2-2	EN 61131-2: Programmable logic controllers
Dry cold	EN 60068-2-1	EN 61131-2: Programmable logic controllers
Large temperature fluctuations	EN 60068-2-14	EN 61131-2: Programmable logic controllers
Temperature fluctuations in operation	EN 60068-2-14	EN 61131-2: Programmable logic controllers
Humid heat, cyclic	EN 60068-2-30	EN 61131-2: Programmable logic controllers
Humid heat, constant (storage)	EN 60068-2-3	EN 61131-2: Programmable logic controllers

Table 382: Overview of limits and testing guidelines for temperature and humidity

### 6.1 Worst case operation

Test carried out according to UL 508	Limits according to UL 508	Limits according to EN 61131-2	
Worst case during operation. Operation of the device with the max. ambient temperature specified in the data sheet at the max. specified load	3 hours at max. ambient temperature (min. +40°C) duration approx. 5 hours	3 hours at max. ambient temperature (min. +40°C) duration approx. 5 hours	

Table 383: Test requirements - Worst case during operation

### 6.2 Dry heat

Test carried out according to EN 60068-2-2	Limits according to EN 61131-2		
Dry heat	16 hours at +70°C for 1 cycle, then 1 hour acclimatization and function testing, duration approximately 17 hours		

Table 384: Test requirements - Dry heat

### 6.3 Dry cold

Test carried out according to EN 60068-2-1	Limits according to EN 61131-2		
Dry cold	16 hours at -40°C for 1 cycle, then 1 hour acclimatization and function testing, duration approximately 17 hours		

Table 385: Test requirements - Dry cold

## 6.4 Large temperature fluctuations

Test carried out according to EN 60068-2-14	Limits according to EN 61131-2		
Large temperature fluctuations	3 hours at -40°C and 3 hours at +70°C, 2 cycles, then 2 hours acclimatization and function testing, duration approximately 14 hours		

Table 386: Test requirements - Large temperature fluctuations

## 6.5 Temperature fluctuations in operation

Test carried out according to EN 60068-2-14	Limits according to EN 61131-2		
Open devices: These can also have a housing and are installed in switching cabinets	3 hours at +5°C and 3 hours at 55°C, 5 cycles, temperature gradient 3°C / min, the unit is occasionally supplied with voltage during testing, duration approximately 30 hours		
Closed devices: These are devices whose data sheet specifies a surrounding housing (enclosure) with the corresponding safety precautions	3 hours at +5°C and 3 hours at +55°C, 5 cycles, temperature gradient 3°C / min, the unit is occasionally supplied with voltage during testing, duration approximately 30 hours		

Table 387: Test requirements - Temperature fluctuations during operation

## 6.6 Humid heat, cyclic

Test carried out according to EN 60068-2-30	Limits according to EN 61131-2		
Alternating climate	24 hours at +25°C / +55°C and 97% / 83% RH, 2 cycles, then 2 hours acclimatization, function testing and insulation, duration approximately 50 hours		

Table 388: Test requirements - Humid heat, cyclic

## 6.7 Humid heat, constant (storage)

Test carried out according to EN 60068-2-3	Limits according to EN 61131-2		
Humid heat, constant (storage)	48 hours at +40°C and 92.5% RH, then insulation test within 3 hours, duration approximately 49 hours		

Table 389: Test requirements - Humid heat, constant (storage)

## 7. Safety

Safety	Test carried out according to	Limits according to
Ground resistance	EN 61131-2	EN 60204-1: Electrical equipment of machines
		EN 61131-2: Programmable logic controllers
Insulation resistance		EN 60204-1: Electrical equipment of machines
High voltage	EN 60060-1	EN 61131-2: Programmable logic controllers
		UL 508: Industrial control equipment
Residual voltage	EN 61131-2	EN 60204-1: Electrical equipment of machines
		EN 61131-2: Programmable logic controllers
Leakage current		VDE 0701-1: Service, changes and testing of electrical devices
Overload	UL 508	EN 61131-2: Programmable logic controllers
		UL 508: Industrial control equipment
Simulation component defect	UL 508	EN 61131-2: Programmable logic controllers
		UL 508: Industrial control equipment
Voltage range		EN 61131-2: Programmable logic controllers

Table 390: Overview of limits and testing guidelines for safety



## 7.1 Ground resistance

Test carried out according to EN 61131-2	Limits according to EN 60204-1 <sup>1)</sup>		Limits according to EN 61131-2
Ground resistance: housing (from any metal part to the ground terminal)	Smallest effective cross section of the protective ground conductor for the branch being tested	Maximum measured voltage drop at a test current of 10 A	Test current 30 A for 2 min, < 0.1 $\Omega$
	1.0 mm <sup>2</sup>	3.3 V	
	1.5 mm <sup>2</sup>	2.6 V	
	2.5 mm <sup>2</sup>	1.9 V	
	4.0 mm <sup>2</sup>	1.4 V	
	> 6.0 mm <sup>2</sup>	1.0 V	

Table 391: Test requirements - Ground resistance

1) See EN 60204-1:1997 page 62, table 9.

## 7.2 Insulation resistance

Test carried out	Limits according to EN 60204-1 <sup>1)</sup>		
Insulation resistance: main circuits to protective ground conductor	> 1 M $\Omega$ at 500 V DC voltage		

Table 392: Test requirements - Insulation resistance

1) See EN 60204-1:1997 page 62, table 9.

## 7.3 High voltage

Test carried out according to EN 60060-1	Limits according to EN 61131-2 <sup>1)</sup>			Limits according to UL 508			
	Input voltage	Test voltage			Input voltage	Test voltage	
		1.2/50 $\mu$ s voltage surge peak	AC, 1 min	DC, 1 min		AC, 1 min	DC, 1 min
High voltage: Primary circuit to secondary circuit and to protective ground circuit (transformers, coils, varistors, capacitors and components used to protect against over-voltage can be removed before the test)	0 - 50 VAC 0 - 60 VDC	850 V	510 V	720 V	$\leq 50$ V	500 V	707 V
	50 - 100 VAC 60 - 100 VDC	1360 V	740 V	1050 V	$> 50$ V	$1000$ V + $2 \times U_N$	$(1000$ V + $2 \times U_N$ ) x 1.414
	100 - 150 VAC 100 - 150 VDC	2550 V	1400 V	1950 V			
	150 - 300 VAC 150 - 300 VDC	4250 V	2300 V	3250 V			
	300 - 600 VAC 300 - 600 VDC	6800 V	3700 V	5250 V			
	600 - 1000 VAC 600 - 1000 VDC	10200 V	5550 V	7850 V			

Table 393: Test requirements - High voltage

1) See EN 61131-2:2003 page 104, table 59.

## 7.4 Residual voltage

Test carried out according to EN 61131-2	Limits according to EN 60204-1	Limits according to EN 61131-2	
Residual voltage after switching off	< 60 V after 5 sec (active parts) < 60 V after 1 sec (plug pins)	< 60 V after 5 sec (active parts) < 60 V after 1 sec (plug pins)	

Table 394: Test requirements - Residual voltage

## 7.5 Leakage current

Test carried out	Limits according to VDE 0701-1		
Leakage current: Phase to ground	< 3.5 mA		

Table 395: Test requirements - Leakage current

## 7.6 Overload

Test carried out according to UL 508	Limits according to EN 61131-2	Limits according to UL 508	
Overload of transistor outputs	50 switches, 1.5 I <sub>N</sub> , 1 sec on / 9 sec off	50 switches, 1.5 I <sub>N</sub> , 1 sec on / 9 sec off	

Table 396: Test requirements - Overload

## 7.7 Defective component

Test carried out according to UL 508	Limits according to EN 61131-2	Limits according to UL 508	
Simulation of how components in power supply became defective	Non-flammable surrounding cloth No contact with conductive parts	Non-flammable surrounding cloth No contact with conductive parts	

Table 397: Test requirements - Defective component

## 7.8 Voltage range

Test carried out according to	Limits according to EN 61131-2			
	Measurement value	Tolerance min/max		
Supply voltage	24 VDC 48 VDC 125 VDC	-15% +20%		
	24 VAC 48 VAC 100 VAC 110 VAC 120 VAC 200 VAC 230 VAC 240 VAC 400 VAC	-15% +10%		

Table 398: Test requirements - Voltage range

## 8. Other tests

Other tests	Test carried out according to	Limits according to
Protection type	-	EN 60529: Degrees of protection provided by enclosures (IP code)
Degree of pollution	-	EN 60664-1: Insulation coordination for equipment within low-voltage systems - part 1: Principles, requirements and tests

Table 399: Overview of limits and testing guidelines for other tests

### 8.1 Protection type

Test carried out according to	Limits according to EN 60529	Limits according to EN 60529	
Protection of the operating equipment	IP2. Protection against large solid foreign bodies =12.5 mm diameter	IP.6 Protection against large solid foreign bodies: Dust-proof	
Protection of personnel	IP2. Protection against touching dangerous parts with finger	IP.6 Protection against touching dangerous parts with conductor	
Protection against water permeation with damaging consequences	IP.0 Not protected	IP.5 Protected against sprayed water	

Table 400: Test requirements - Protection

### 8.2 Degree of pollution

Test carried out according to	Limits according to EN 60664-1		
Definition	Degree of pollution II		

Table 401: Test requirements - Degree of pollution

## 9. SDL flex cable - test description

### 9.1 Torsion

#### 9.1.1 Test structure

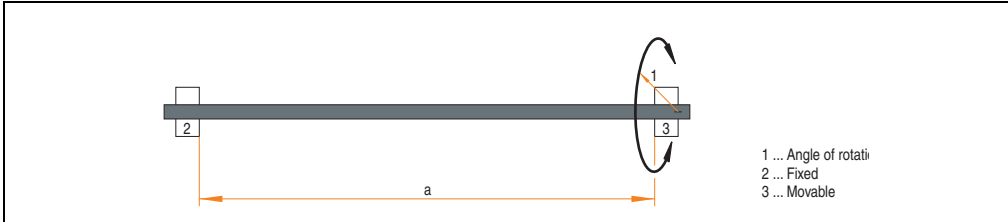

Figure 301: Test structure - torsion

#### 9.1.2 Test conditions

- Distance a: 450 mm
- Rotation angle:  $\pm 85^\circ$
- Velocity: 50 cycles / minute
- Special feature: The cable was clamped down twice in the machine.

#### 9.1.3 Individual tests

- Visible pixel errors: At the beginning of the test, the minimum equalizer setting was determined. This is the value between 0-15 at which no more pixel errors are visible. If the equalizer setting is changed due to the mechanical load, this is noted.
- Touch screen for function (with a 21.3" Automation Panel - 5AP920.2138-01)
- USB mouse function
- Hot plug function tested by unplugging the USB plug
- After a test duration of 15000 cycles, the test was ended with a result of "OK".

## 9.2 Cable drag chain

### 9.2.1 Test structure

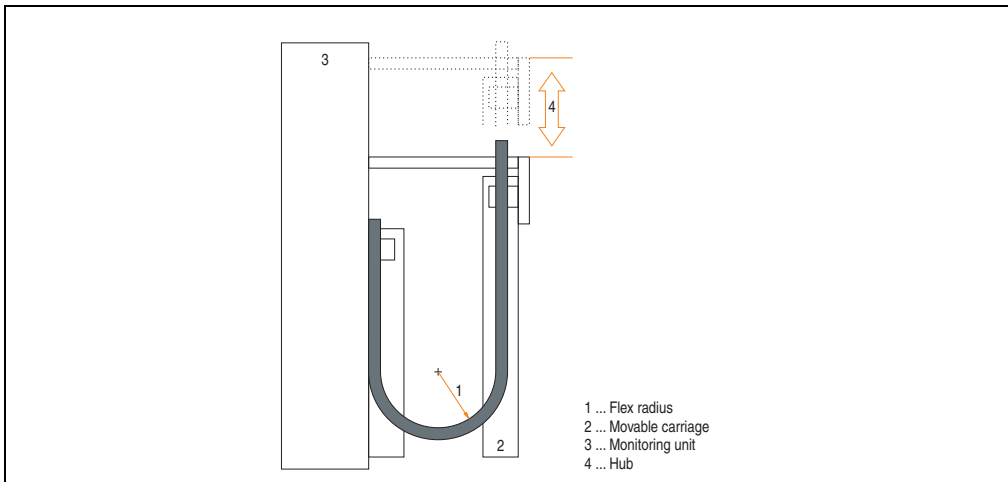

Figure 302: Test structure - Cable drag chain

### 9.2.2 Test conditions

- Flex radius: 180 mm (= 15 x cable diameter)
- Hub: 460 mm
- Velocity: 4800 cycles / hour
- Special feature: The cable was clamped down twice in the machine.

### 9.2.3 Individual tests:

- Visible pixel errors: At the beginning of the test, the minimum equalizer setting is determined. This is the value between 0-15 at which no more pixel errors are visible. If the equalizer setting is changed due to the mechanical load, this is noted.
- Touch screen for function (with a 21.3" Automation Panel - 5AP920.2138-01)
- USB mouse function
- Hot plug function tested by unplugging the USB plug
- After a test duration of 30,000 cycles, the test was ended with a result of "OK".

## 10. International certifications

B&R products and services comply with applicable standards. They are international standards from organizations such as ISO, IEC and CENELEC, as well as national standards from organizations such as UL, CSA, FCC, VDE, ÖVE, etc. We give special consideration to the reliability of our products in an industrial environment.



Certifications	
USA and Canada 	All important B&R products are tested and listed by Underwriters Laboratories and checked quarterly by a UL inspector. This mark is valid for the USA and Canada and simplifies certification of your machines and systems in these areas.
Europe 	All harmonized EN standards for the applicable directives are met.

Table 402: International Certifications





# Chapter 6 • Accessories

## 1. Overview

Model number	Short description	Note
0AC201.91	<b>Lithium batteries, 4 pcs.</b> Lithium batteries, 4 pcs., 3 V / 950 mAh, button cell	
4A0006.00-000	<b>Lithium battery, 1 pc.</b> Lithium battery, 1 pc., 3 V / 950 mAh, button cell	
0TB103.9	<b>Plug 24V 5.08 3-pin screw clamps</b> 24 VDC 3-pin connector, female. Screw clamps, 3.31 mm <sup>2</sup> , protected against vibration by the screw flange	
0TB103.91	<b>Plug 24V 5.08 3-pin cage clamps</b> 24 VDC 3-pin connector, female. Cage clamps, 3.31 mm <sup>2</sup> , protected against vibration by the screw flange	
0TB704.9	<b>Terminal block, 4-pin,</b> Screw clamp, 1.5 mm <sup>2</sup>	
0TB704.91	<b>Terminal block, 4-pin,</b> cage clamps, 2.5 mm <sup>2</sup>	
5A5003.03	<b>Front cover</b> Front cover for the USB 2.0 Media Drive 5MD900.USB2-00.	
5AC600.ICOV-00	<b>Interface covers</b> Interface covers for APC620 and PPC700 devices; 5 pieces	
5AC600.UPSI-00	<b>Add-on UPS module</b> UPS module for APC620, APC810, PPC800; for system units 5PC600.SX01-00 (starting with Rev. H0), 5PC600.SX02-00 (starting with Rev. G0), 5PC600.SX02-01 (starting with Rev. H0), 5PC600.SX05-00 (starting with Rev. F0), 5PC600.SX05-01 (starting with Rev. F0), 5PC600.SF03-00 (starting with Rev. A0), 5PC810.SX*. 5PC820.1505-00, 5PC820.1906-00 Order cable (5CAUPS.0005-00 or 5CAUPS.0030-00) and battery unit (5AC600.UPSB-00) separately.	
5AC600.UPSB-00	<b>Battery unit 5 Ah</b> Battery unit 5Ah; for APC620, APC810 or PPC800 UPS.	
5ACPCI.ETH1-01	<b>PCI Ethernet card 10/100</b> half size PCI Ethernet card, 1 Ethernet connection	
5ACPCI.ETH3-01	<b>PCI Ethernet card 10/100 3port</b> half size PCI Ethernet card, 3 Ethernet connections	
5AC900.1000-00	<b>Adapter DVI-A/m to CRT</b> Adapter DVI (plug) to CRT (socket), for connecting a standard monitor to a DVI-I interface.	
5AC600.SRAM-00	<b>APC620/PPC700 SRAM module 512kB</b> SRAM module for APC620 and PPC700 512 KB.	
5CAMSC.0001-00	<b>APC620 internal supply cable</b>	

Table 403: Model numbers - Accessories

## Accessories • Overview

Model number	Short description	Note
5CADVI.0018-00	<b>DVI-D cable 1.8 m</b> Single cable, DVI-D/m:DVI-D/m; length: 1.8 m	
5CADVI.0050-00	<b>DVI-D cable 5 m</b> Single cable, DVI-D/m:DVI-D/m; length: 5 m	
5CADVI.0100-00	<b>DVI-D cable 10 m</b> Single cable, DVI-D/m:DVI-D/m; length: 10 m	
5CASDL.0018-00	<b>SDL cable 1.8 m</b> SDL cable for a fixed type of layout; length: 1.8 m	
5CASDL.0018-01	<b>SDL cable 1.8 m 45°</b> SDL cable for fixed type of layout with one-sided 45° plug; length: 1.8 m	
5CASDL.0018-03	<b>SDL flex cable 1.8 m</b> SDL cable for fixed and flexible type of layout; length: 1.8 m	
5CASDL.0050-00	<b>SDL cable 5 m</b> SDL cable for a fixed type of layout; length: 5 m	
5CASDL.0050-01	<b>SDL cable 5 m 45°</b> SDL cable for fixed type of layout with one-sided 45° plug; length: 5 m	
5CASDL.0050-03	<b>SDL flex cable 5 m</b> SDL cable for fixed and flexible type of layout; length: 5 m	
5CASDL.0100-00	<b>SDL cable 10 m</b> SDL cable for a fixed type of layout; length: 10 m	
5CASDL.0100-01	<b>SDL cable 10 m 45°</b> SDL cable for fixed type of layout with one-sided 45° plug; length: 10 m	
5CASDL.0100-03	<b>SDL flex cable 10 m</b> SDL cable for fixed and flexible type of layout; length: 10 m	
5CASDL.0150-00	<b>SDL cable 15 m</b> SDL cable for a fixed type of layout; length: 15 m	
5CASDL.0150-01	<b>SDL cable 15 m 45°</b> SDL cable for fixed type of layout with one-sided 45° plug; length: 15 m	
5CASDL.0150-03	<b>SDL flex cable 15 m</b> SDL cable for fixed and flexible type of layout; length: 15 m	
5CASDL.0200-00	<b>SDL cable 20 m</b> SDL cable for a fixed type of layout; length: 20 m	
5CASDL.0200-03	<b>SDL flex cable 20 m</b> SDL cable for fixed and flexible type of layout; length: 20 m	
5CASDL.0250-00	<b>SDL cable 25 m</b> SDL cable for a fixed type of layout; length: 25 m	
5CASDL.0250-03	<b>SDL flex cable 25 m</b> SDL cable for fixed and flexible type of layout; length: 25 m	
5CASDL.0300-00	<b>SDL cable 30 m</b> SDL cable for a fixed type of layout; length: 30 m	
5CASDL.0300-03	<b>SDL flex cable 30 m</b> SDL cable for fixed and flexible type of layout; length: 30 m	
5CASDL.0300-10	<b>SDL cable with extender 30 m</b> SDL cable with extender for a fixed type of layout; length 30 m	Cancelled since 12/2006 Replaced by 5CASDL.0300-13
5CASDL.0300-13	<b>SDL flex cable with extender 30 m</b> SDL cable with extender for fixed and flexible type of layout; length: 30 m	

Table 403: Model numbers - Accessories (Forts.)

Model number	Short description	Note
5CASDL.0400-10	<b>SDL cable with extender 40 m</b> SDL cable with extender for a fixed type of layout; length 40 m	Cancelled since 12/2006 Replaced by 5CASDL.0400-13
5CASDL.0400-13	<b>SDL flex cable with extender 40 m</b> SDL cable with extender for fixed and flexible type of layout; length: 40 m	
5CAUPS.0005-00	<b>APC620 UPS cable 0.5 m</b> Connection cable between add-on UPS module and UPS battery unit, length 0.5 meters	
5CAUPS.0030-00	<b>APC620 UPS cable 3 m</b> Connection cable between add-on UPS module and UPS battery unit, length 3 meters	
5CAUSB.0018-00	<b>USB 2.0 cable, A/m:B/m 1.8 m</b> USB 2.0 connection cable; plug type A - type B; length 1.8 m	
5CAUSB.0050-00	<b>USB 2.0 cable, A/m:B/m 5 m</b> USB 2.0 connection cable; plug type A - type B; length 5 m	
9A0014.02	<b>RS232 cable DB9/f:DB9/m 1.8 m</b> RS232 extension cable for remote operation of a display unit with touch screen, length 1.8 m.	
9A0014.05	<b>RS232 cable DB9/f:DB9/m 5 m</b> RS232 extension cable for remote operation of a display unit with touch screen, length 5 m.	
9A0014.10	<b>RS232 cable DB9/f:DB9/m 10 m</b> RS232 extension cable for remote operation of a display unit with touch screen, length 10 m.	
5CFCRD.0512-06	<b>CompactFlash 512 MB B&amp;R</b> CompactFlash card with 512 MB SLC NAND flash and IDE/ATA interface	
5CFCRD.1024-06	<b>CompactFlash 1024 MB B&amp;R</b> CompactFlash card with 1024 MB SLC NAND flash and IDE/ATA interface	
5CFCRD.2048-06	<b>CompactFlash 2048 MB B&amp;R</b> CompactFlash card with 2048 MB SLC NAND flash and IDE/ATA interface	
5CFCRD.4096-06	<b>CompactFlash 4096 MB B&amp;R</b> CompactFlash card with 4096 MB SLC NAND flash and IDE/ATA interface	
5CFCRD.8192-06	<b>CompactFlash 8192 MB B&amp;R</b> CompactFlash card with 8192 MB SLC NAND flash and IDE/ATA interface	
5CFCRD.016G-06	<b>CompactFlash 16 GB B&amp;R</b> CompactFlash card with 16 GB SLC NAND flash and IDE/ATA interface	
5CFCRD.032G-06	<b>CompactFlash 32 GB B&amp;R</b> CompactFlash card with 32 GB SLC NAND flash and IDE/ATA interface	
5CFCRD.0512-04	<b>CompactFlash 512 MB B&amp;R</b> CompactFlash card with 512 MB SLC NAND flash and IDE/ATA interface	
5CFCRD.1024-04	<b>CompactFlash 1024 MB B&amp;R</b> CompactFlash card with 1024 MB SLC NAND flash and IDE/ATA interface	
5CFCRD.2048-04	<b>CompactFlash 2048 MB B&amp;R</b> CompactFlash card with 2048 MB SLC NAND flash and IDE/ATA interface	
5CFCRD.4096-04	<b>CompactFlash 4096 MB B&amp;R</b> CompactFlash card with 4096 MB SLC NAND flash and IDE/ATA interface	
5CFCRD.8192-04	<b>CompactFlash 8192 MB B&amp;R</b> CompactFlash card with 8192 MB SLC NAND flash and IDE/ATA interface	
5CFCRD.016G-04	<b>CompactFlash 16 GB B&amp;R</b> CompactFlash card with 16 GB SLC NAND flash and IDE/ATA interface	
5CFCRD.0064-03	<b>CompactFlash 64 MB SSI</b> CompactFlash card with 64 MB SLC NAND flash and IDE/ATA interface	

Table 403: Model numbers - Accessories (Forts.)

## Accessories • Overview

Model number	Short description	Note
5CFCRD.0128-03	<b>CompactFlash 128 MB SSI</b> CompactFlash card with 128 MB SLC NAND flash and IDE/ATA interface	
5CFCRD.0256-03	<b>CompactFlash 256 MB SSI</b> CompactFlash card with 256 MB SLC NAND flash and IDE/ATA interface	
5CFCRD.0512-03	<b>CompactFlash 512 MB SSI</b> CompactFlash card with 512 MB SLC NAND flash and IDE/ATA interface	
5CFCRD.1024-03	<b>CompactFlash 1024 MB SSI</b> CompactFlash card with 1024 MB SLC NAND flash and IDE/ATA interface	
5CFCRD.2048-03	<b>CompactFlash 2048 MB SSI</b> CompactFlash card with 2048 MB SLC NAND flash and IDE/ATA interface	
5CFCRD.4096-03	<b>CompactFlash 4096 MB SSI</b> CompactFlash card with 4096 MB SLC NAND flash and IDE/ATA interface	
5CFCRD.8192-03	<b>CompactFlash 8192 MB SSI</b> CompactFlash card with 8192 MB SLC NAND flash and IDE/ATA interface	
5CFCRD.0032-02	<b>CompactFlash 32 MB SanDisk/A</b> CompactFlash card with 32 MB flash PROM and IDE/ATA interface.	Cancelled since 12/2005 Replaced by 5CFCRD.0064-03
5CFCRD.0064-02	<b>CompactFlash 64 MB SanDisk/A</b> CompactFlash card with 64 MB flash PROM and IDE/ATA interface.	Cancelled since 12/2005 Replaced by 5CFCRD.0064-03
5CFCRD.0128-02	<b>CompactFlash 128 MB SanDisk/A</b> CompactFlash card with 128 MB flash PROM and IDE/ATA interface	Cancelled since 12/2005 Replaced by 5CFCRD.0128-03
5CFCRD.0256-02	<b>CompactFlash 256 MB SanDisk/A</b> CompactFlash card with 256 MB flash PROM and IDE/ATA interface	Cancelled since 12/2005 Replaced by 5CFCRD.0256-03
5CFCRD.0512-02	<b>CompactFlash 512 MB SanDisk/A</b> CompactFlash card with 512 MB flash PROM and IDE/ATA interface	Cancelled since 12/2005 Replaced by 5CFCRD.0512-03
5CFCRD.1024-02	<b>CompactFlash 1024 MB SanDisk/A</b> CompactFlash card with 1024 MB flash PROM and IDE/ATA interface	Cancelled since 12/2005 Replaced by 5CFCRD.1024-03
5CFCRD.2048-02	<b>CompactFlash 2048 MB SanDisk/A</b> CompactFlash card with 2048 MB flash PROM and IDE/ATA interface	Cancelled since 12/2005 Replaced by 5CFCRD.2048-03
5MD900.USB2-00	<b>USB 2.0 drive DVD-ROM/CD-RW FDD CF USB</b> USB 2.0 drive combination, consists of DVD-ROM/CD-RW, FDD, CompactFlash slot (type II), USB connection (type A front, type B back); 24 V DC.	Cancelled since 10/2006 Replacement type 5MD900.USB-01
5MD900.USB2-01	<b>USB 2.0 drive DVD-RW/CD-RW FDD CF USB</b> USB 2.0 drive combination, consists of DVD-R/RW/DVD+R/RW/CD-RW, FDD, CompactFlash slot (type II), USB connection (type A front, type B back); 24 V DC.	
5MMUSB.0128-00	<b>USB flash drive 128 MB SanDisk</b> USB 2.0 flash drive 128 MB	Cancelled since 12/2005 Replaced by 5MMUSB.2048-00
5MMUSB.0256-00	<b>USB flash drive 256 MB SanDisk</b> USB 2.0 flash drive 256 MB	Cancelled since 03/2007 Replaced by 5MMUSB.2048-00
5MMUSB.0512-00	<b>USB flash drive 512 MB SanDisk</b> USB 2.0 flash drive 512 MB	Cancelled since 07/2007 Replaced by 5MMUSB.2048-00
5MMUSB.1024-00	<b>USB flash drive 1 GB SanDisk</b> USB 2.0 flash drive 1 GB	Cancelled since 03/2007 Replaced by 5MMUSB.2048-00
5MMUSB.2048-00	<b>USB flash drive 2 GB SanDisk</b> USB 2.0 flash drive 2 GB	

Table 403: Model numbers - Accessories (Forts.)

Model number	Short description	Note
5MMUSB.2048-01	<b>USB flash drive 2 GB B&amp;R</b> USB 2.0 flash drive 2 GB	
5SWHMI.0000-00	<b>HMI Drivers &amp; Utilities DVD</b>	
5AC600.FA01-00	<b>APC620 replacement fan filter 1PCI 5 piece</b> APC620 replacement fan filter for system unit with 1 PCI Slot (5PC600.SX01-00).	
5AC600.FA02-00	<b>APC620 replacement fan filter 1PCI 5 piece</b> APC620 replacement fan filter for system unit with 2 PCI slot (5PC600.SX02-00, 5PC600.SX02-01).	
5AC600.FA03-00	<b>APC620f replacement fan filter 1PCI 5 piece</b> APC620 replacement fan filter for system unit with 3 PCI Slots (5PC600.SF03-00).	
5AC600.FA05-00	<b>APC620 replacement fan filter 1PCI 5 piece</b> APC620 replacement fan filter for system units with 5 PCI slot (5PC600.SX02-00, 5PC600.SX02-01).	
0PS102.0	<b>Power supply, 1-phase, 2.1 A</b> 24 VDC power supply, 1-phase, 2.1 A, input 100-240 VAC, wide range, DIN rail mounting	
0PS104.0	<b>Power supply, 1-phase, 4.2 A</b> 24 VDC power supply, 1 phase, 4.2 A, input 115/230 VAC, auto select, DIN rail mounting	
0PS105.1	<b>Power supply, 1-phase, 5 A</b> 24 VDC power supply, 1 phase, 5 A, input 115/230 VAC, manual select, DIN rail mounting	
0PS105.2	<b>Power supply, 1-phase, 5 A, redundant</b> 24 VDC power supply, 1 phase, 5 A, redundant through parallel operation, input 115/230 VAC, manual select, DIN rail mounting	
0PS110.1	<b>Power supply, 1-phase, 10 A</b> 24 VDC power supply, 1 phase, 10 A, input 115/230 VAC, manual select, DIN rail mounting	
0PS110.2	<b>Power supply, 1-phase, 10 A, redundant</b> 24 VDC power supply, 1 phase, 10 A, redundant through parallel operation, input 115/230 VAC, manual select, DIN rail mounting	
0PS120.1	<b>Power supply, 1-phase, 20 A</b> 24 VDC power supply, 1 phase, 20 A, input 115/230 VAC, auto select, DIN rail mounting	
0PS305.1	<b>Power supply, 3-phase, 5 A</b> 24 VDC power supply, 3-phase, 5 A, input 400..500 VAC (3 phases), wide range, DIN rail mounting	
0PS310.1	<b>Power supply, 3-phase, 10 A</b> 24 VDC power supply, 3-phase, 10 A, input 400..500 VAC (3 phases), wide range, DIN rail mounting	
0PS320.1	<b>Power supply, 3-phase, 20 A</b> 24 VDC power supply, 3-phase, 20 A, input 400..500 VAC (3 phases), wide range, DIN rail mounting	
0PS340.1	<b>Power supply, 1-phase, 40 A</b> 24 VDC power supply, 3 phase, 40 A, input 115/230 VAC, auto select, DIN rail mounting	

Table 403: Model numbers - Accessories (Forts.)

## 2. Supply voltage connector (TB103 3-pin)

### 2.1 General information

This single row 3-pin terminal block is mainly used to connect the supply voltage.

### 2.2 Order data



Model number	Description	Figure
0TB103.9	Plug for the 24 V supply voltage (screw clamps)	 <p>0TB103.9</p>  <p>0TB103.91</p>
0TB103.91	Plug for the 24 V supply voltage (cage clamps)	

Table 404: Order data - TB103

### 2.3 Technical data

#### Information:

The following characteristics, features and limit values only apply to this accessory and can deviate from those specified for the entire device. For the entire device where this accessory is installed, refer to the data provided specifically for the entire device.

Name	0TB103.9	0TB103.91
Number of pins	3	
Type of terminal	Screw clamps	Cage clamps

Table 405: Technical data - TB103 supply plug

**Accessories • Supply voltage connector (TB103 3-pin)**

Name	0TB103.9	0TB103.91
Distance between contacts	5.08 mm	
Resistance between contacts	$\leq 5 \text{ m}\Omega$	
Nominal voltage according to VDE / UL,CSA	250 V / 300 V	
Current load according to VDE / UL,CSA	14.5 A / 10 A per contact	
Terminal size	0.08 mm <sup>2</sup> - 3.31 mm <sup>2</sup>	
Cable type	Copper wires only (no aluminum wires!)	

Table 405: Technical data - TB103 supply plug (Forts.)

### 3. X2X and CAN plugs (4-pin)

#### 3.1 General information

This 4-pin plug is needed for connecting to the X2X and CAN interface.

#### 3.2 Order data

Model number	Description	Figure
0TB704.9	4-pin screw clamp	
0TB704.91	4-pin cage clamps	

Table 406: Order data - 0TB704.9 and 0TB704.91

#### 3.3 Technical data

### Information:

The following characteristics, features and limit values only apply to this accessory and can deviate from those specified for the entire device. For the entire device where this accessory is installed, refer to the data provided specifically for the entire device.

Name	0TB704.9	0TB704.91
Number of pins	4	
Type of terminal	Screw clamps	Cage clamps

Table 407: Technical data - TB103 supply plug



## 4. Replacement CMOS batteries

The lithium battery is needed for buffering the BIOS CMOS data, the real-time clock, and SRAM data. The battery is subject to wear and should be replaced regularly (at least following the specified buffer duration).

### 4.1 Order data

Model number	Description	Figure
0AC201.91	Lithium batteries, 5 pcs., 3 V / 950 mAh button cell	
4A0006.00-000	Lithium battery, 1 piece, 3 V / 950 mAh button cell	

Table 408: Order data - Lithium batteries

### 4.2 Technical data

#### Warning!

Replace battery with Renata, type CR2477N only. Use of another battery may present a risk of fire or explosion.

Battery may explode if mistreated. Do not recharge, disassemble or dispose of in fire.

#### Information:

The following characteristics, features and limit values only apply to this accessory and can deviate from those specified for the entire device. For the entire device where this accessory is installed, refer to the data provided specifically for the entire device.

Features	0AC201.91	4A0006.00-000
Capacity	950 mAh	
Voltage	3 V	
Self discharge at 23°C	< 1% per year	
Storage time	Max. 3 years at 30° C	

Table 409: Technical data - Lithium batteries

## Accessories • Replacement CMOS batteries

Features	0AC201.91	4A0006.00-000
Environmental characteristics		
Storage temperature	-20 to 60°C	
Relative humidity	0 to 95% (non-condensing)	

Table 409: Technical data - Lithium batteries (Forts.)

## 5. Interface covers 5AC600.ICOV-00

The interface covers protect interfaces from dirt and dust when not in use.

### 5.1 Order data

Model number	Description	Figure
5AC600.ICOV-00	<b>Interface covers</b> Interface covers for APC620 and PPC700 devices; 5 pieces	

Table 410: Order data - APC620 interface cover

### 5.2 Contents of delivery

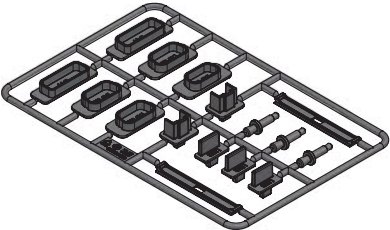
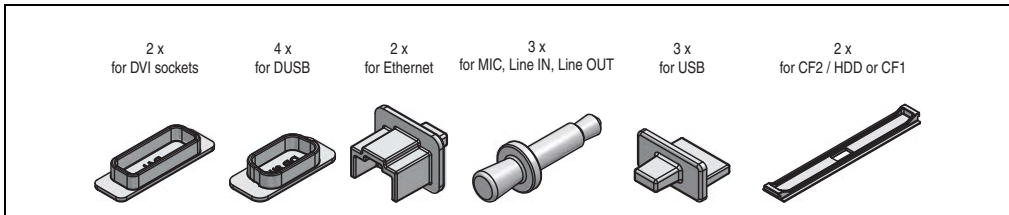

Figure 303: Contents of delivery - interface cover

## 6. DVI - monitor adapter 5AC900.1000-00

This adapter enables a standard monitor to be connected to the DVI-I interface.

### 6.1 Order data

Model number	Description	Figure
5AC900.1000-00	<b>Adapter DVI-A/m to CRT DB15HD/f</b> Adapter DVI (plug) to CRT (socket), for connecting a standard monitor to a DVI-I interface.	

Table 411: Order data - DVI - CRT adapter

## 7. CompactFlash cards 5CFCRD.xxxx-06

### 7.1 General information

#### Information:

B&R CompactFlash cards 5CFCRD.xxxx-06 and CompactFlash cards from a different manufacturer cannot be used in the same system at the same time. Due to differences in technology (older vs. newer technologies), problems can occur during system startup that are caused by the different boot times.

See chapter 3 "Commissioning" section 9 "Known problems / issues", on page 369.

#### Information:

The 5CFCRD.xxxx-06 CompactFlash cards are supported on B&R devices with WinCE Version  $\geq 6.0$ .

### 7.2 Order data

Model number	Description	Figure
5CFCRD.0512-06	CompactFlash 512 MB B&R (SLC)	 <p>CompactFlash card</p>
5CFCRD.1024-06	CompactFlash 1 GB B&R (SLC)	
5CFCRD.2048-06	CompactFlash 2 GB B&R (SLC)	
5CFCRD.4096-06	CompactFlash 4 GB B&R (SLC)	
5CFCRD.8192-06	CompactFlash 8 GB B&R (SLC)	
5CFCRD.016G-06	CompactFlash 16 GB B&R (SLC)	
5CFCRD.032G-06	CompactFlash 32 GB B&R (SLC)	

Table 412: Order data - CompactFlash cards

### 7.3 Technical data

## Caution!

A sudden loss of power may result in data loss! In very rare cases, mass memory may also be damaged.

To prevent damage and loss of data, it is recommended to use a UPS device.

## Information:

The following characteristics, features and limit values only apply to this accessory and can deviate from those specified for the fully assembled device. The data specifications for the fully assembled device take precedence over those of individual components.

Features	5CFCRD. 0512-06	5CFCRD. 1024-06	5CFCRD. 2048-06	5CFCRD. 4096-06	5CFCRD. 8192-06	5CFCRD. 016G-06	5CFCRD. 032G-06
Capacity	512 MB	1 GB	2 GB	4 GB	8 GB	16 GB	32 GB
MTBF (at 25°C)	>3,000,000 hours (at 25°C)						
Maintenance	None						
Data reliability	< 1 unrecoverable error in 10 <sup>14</sup> bit read accesses						
Data retention	10 years						
Lifetime monitoring	Yes						
Supported operating modes	PIO Mode 0-6, Multiword DMA Mode 0-4, Ultra DMA Mode 0-4						
Continuous reading							
Typical	33 MB/s	33 MB/s	33 MB/s	33 MB/s	33 MB/s	36 MB/s	36 MB/s
Maximum	35 MB/s	35 MB/s	35 MB/s	34 MB/s	34 MB/s	37 MB/s	37 MB/s
Continuous writing							
Typical	15 MB/s	15 MB/s	15 MB/s	14 MB/s	14 MB/s	28 MB/s	28 MB/s
Maximum	18 MB/s	18 MB/s	18 MB/s	17 MB/s	17 MB/s	30 MB/s	30 MB/s
<b>Endurance</b>							
Guaranteed data volume							
Guaranteed <sup>1)</sup>	50 TB	100 TB	200 TB	400 TB	800 TB	1600 TB	3200 TB
Results for 5 years <sup>1)</sup>	27.40 GB/day	54.79 GB/day	109.59 GB/day	219.18 GB/day	438.36 GB/day	876.72 GB/day	1753.44 GB/day
Clear/write cycles							
Guaranteed	100,000						
SLC flash	Yes						
Wear leveling	Static						
Error Correction Coding (ECC)	Yes						
<b>Endurance</b>	<b>5CFCRD. 0512-06</b>	<b>5CFCRD. 1024-06</b>	<b>5CFCRD. 2048-06</b>	<b>5CFCRD. 4096-06</b>	<b>5CFCRD. 8192-06</b>	<b>5CFCRD. 016G-06</b>	<b>5CFCRD. 032G-06</b>

Table 413: Technical data - 5CFCRD.xxxx-06 CompactFlash cards

## Accessories • CompactFlash cards 5CFCRD.xxxx-06

S.M.A.R.T. Support	Yes						
<b>Support</b>							
Hardware	PP300/400, PP500, PPC300, PPC700, PPC725, PPC800, APC620, APC810, APC820						
Windows XP Professional	No	No	No	Yes	Yes	Yes	Yes
Windows XP Embedded	Yes	Yes	Yes	Yes	Yes	Yes	Yes
Windows Embedded Standard 2009	No	Yes	Yes	Yes	Yes	Yes	Yes
Windows CE 6.0	Yes	Yes	Yes	Yes	Yes	Yes <sup>2)</sup>	Yes <sup>2)</sup>
Windows CE 5.0	No	No	No	No	No	No	No
PVI Transfer	≥ V3.2.3.8 (part of PVI Development Setup ≥ V2.06.00.3011)	≥ V3.2.3.8 (part of PVI Development Setup ≥ V2.06.00.3011)	≥ V3.2.3.8 (part of PVI Development Setup ≥ V2.06.00.3011)	≥ V3.2.3.8 (part of PVI Development Setup ≥ V2.06.00.3011)	≥ V3.2.3.8 (part of PVI Development Setup ≥ V2.06.00.3011)	≥ V3.6.8.40 (part of PVI Development Setup ≥ V3.0.0.3020)	≥ V4.0.0.8 (part of PVI Development Setup ≥ V3.0.2.3014)
B&R Embedded OS Installer	≥ V3.10	≥ V3.10	≥ V3.10	≥ V3.10	≥ V3.10	≥ V3.20	≥ V3.21
<b>Mechanical characteristics</b>							
Dimensions	36.4 ±0.15 mm						
Length	42.8 ±0.10 mm						
Width	3.3 ±0.10 mm						
Thickness	3.3 ±0.10 mm						
Weight	10 g						
<b>Environmental characteristics</b>							
Ambient temperature	0 to 70°C						
Operation	-65 to 150°C						
Storage	-65 to 150°C						
Transport	-65 to 150°C						
Relative humidity	Max. 85% at 85°C						
Operation/Storage/Transport	Max. 85% at 85°C						
Vibration	20 G peak, 20- 2000 Hz, 4 in each direction (JEDEC JESD22, method B103)						
Operation/Storage/Transport	5.35 G RMS, 15 min per level (IEC 68-2-6)						
Shock	1.5k G peak, 0.5 ms 5 times (JEDEC JESD22, method B110)						
Operation/Storage/Transport	30 G, 11 ms 1 time (IEC 68-2-27)						
Altitude	Max. 4572 m						

Table 413: Technical data - 5CFCRD.xxxx-06 CompactFlash cards (Forts.)

1) Endurance of B&R CFs (with linear written block size 128 kB)

2) Not supported by B&R Embedded OS installer.

### 7.3.1 Temperature humidity diagram

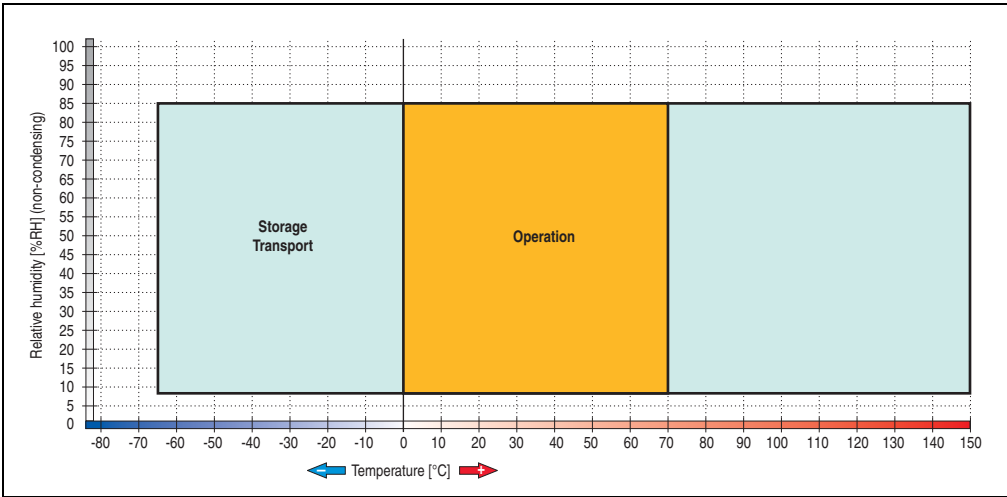

Figure 304: Temperature humidity diagram - CompactFlash cards 5CFCRD.xxxx-06

### 7.4 Dimensions

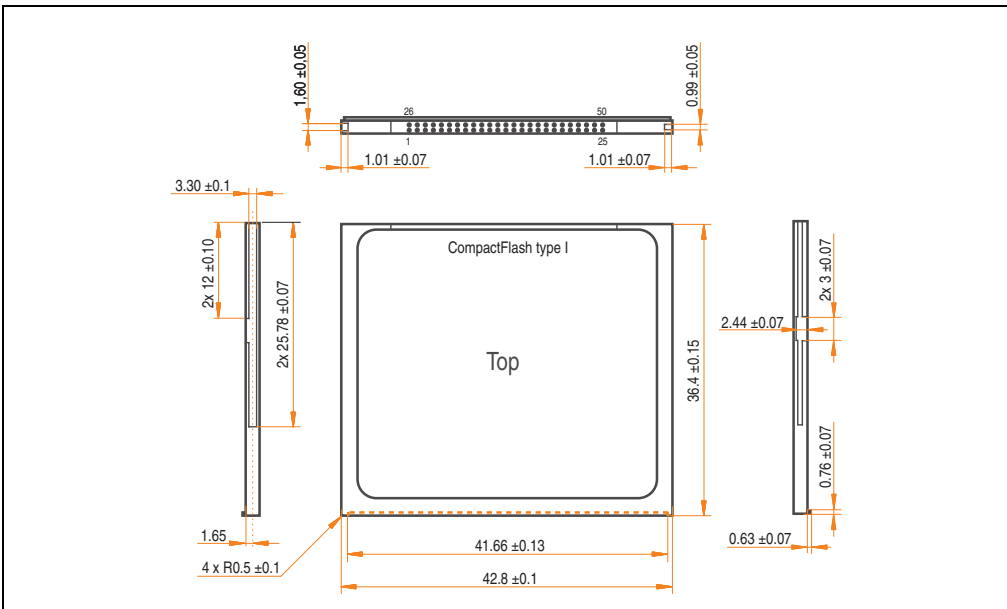

Figure 305: Dimensions - CompactFlash card Type I



## 7.5 Benchmark

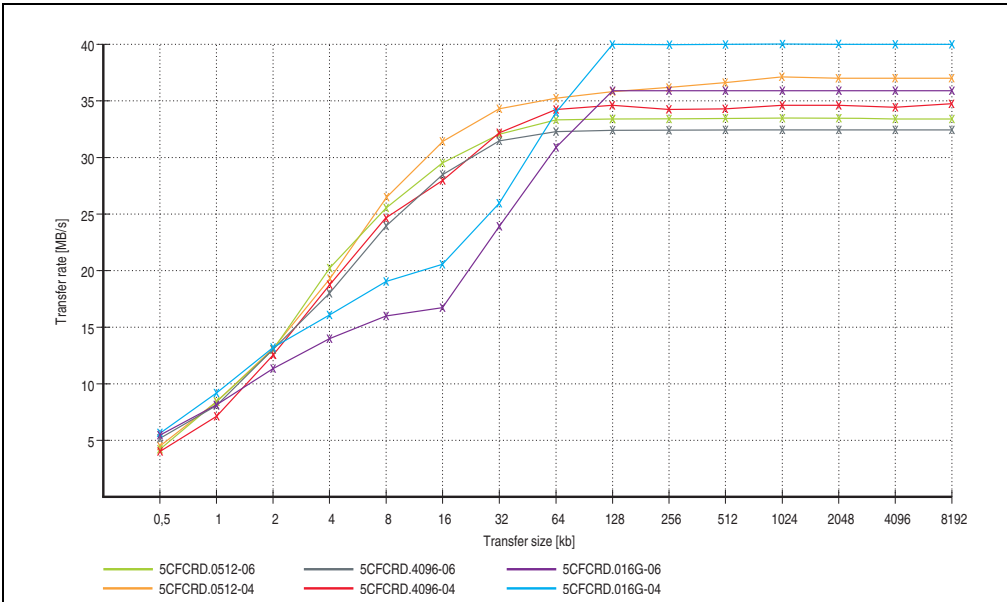

Figure 306: ATTO Benchmark v2.34 comparison when reading - 5CFCRD.xxxx-04 with 5CFCRD.xxxx-06

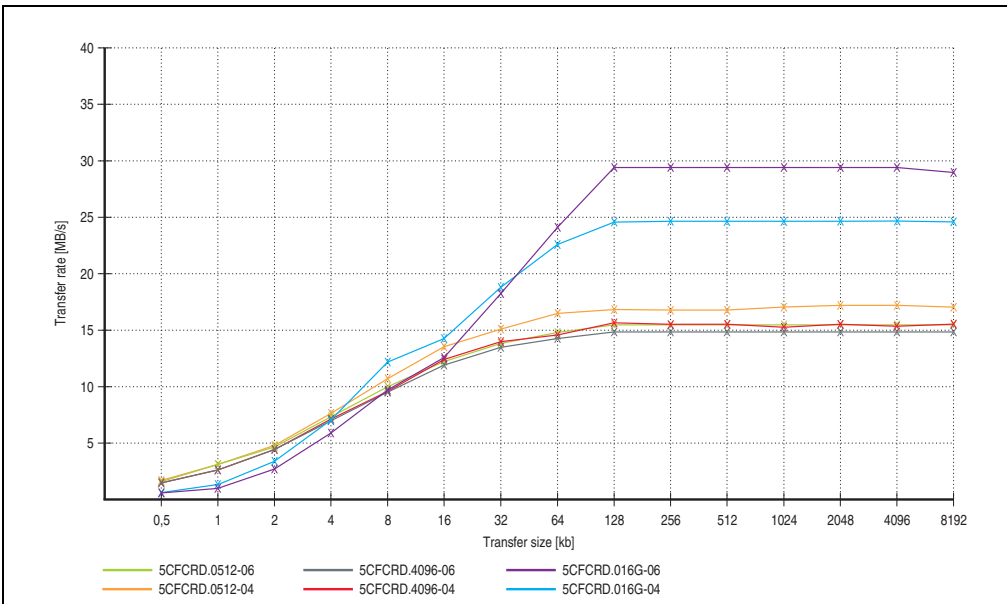

Figure 307: ATTO Benchmark v2.34 comparison when writing - 5CFCRD.xxxx-04 with 5CFCRD.xxxx-06

## 8. CompactFlash cards 5CFCRD.xxxx-04

### 8.1 General information

#### Information:

B&R CompactFlash cards 5CFCRD.xxxx-04 and CompactFlash cards from a different manufacturer cannot be used in the same system at the same time. Due to differences in technology (older vs. newer technologies), problems can occur during system startup that are caused by the different boot times.

See chapter 3 "Commissioning", section 9 "Known problems / issues", on page 369.

#### Information:

The 5CFCRD.xxxx-04 CompactFlash cards are supported on B&R devices with WinCE Version 6.0 or higher.

### 8.2 Order data

Model number	Description	Figure
5CFCRD.0512-04	512 MB B&R CompactFlash card	
5CFCRD.1024-04	1024 MB B&R CompactFlash card	
5CFCRD.2048-04	2048 MB B&R CompactFlash card	
5CFCRD.4096-04	4096 MB B&R CompactFlash card	
5CFCRD.8192-04	8192 MB B&R CompactFlash card	
5CFCRD.016G-04	16 GB B&R CompactFlash card	
		CompactFlash card

Table 414: Order data - CompactFlash cards

### 8.3 Technical data

## Caution!

A sudden loss of power can cause data to be lost! In very rare cases, the mass memory may also become damaged.

To prevent damage and loss of data, it is recommended to use a UPS device.

## Information:

The following characteristics, features and limit values only apply to this accessory and can deviate those specified for the entire device. For the entire device where this accessory is installed, refer to the data provided specifically for the entire device.

Features	5CFCRD.0512-04	5CFCRD.1024-04	5CFCRD.2048-04	5CFCRD.4096-04	5CFCRD.8192-04	5CFCRD.016G-04
MTBF (at 25°C)	> 3,000,000 hours					
Maintenance	None					
Data reliability	< 1 unrecoverable error in 10 <sup>14</sup> bit read accesses					
Data retention	10 years					
Lifetime monitoring	Yes					
Supported operating modes	PIO Mode 0-6, Multiword DMA Mode 0-4, Ultra DMA Mode 0-4					
Continuous reading	Typically 35 MB/s (240X) <sup>1)2)</sup> Max. 37 MB/s (260X) <sup>1)2)</sup>	Typically 35 MB/s (240X) <sup>1)2)</sup> Max. 37 MB/s (260X) <sup>1)2)</sup>	Typically 35 MB/s (240X) <sup>1)2)</sup> Max. 37 MB/s (260X) <sup>1)2)</sup>	Typically 33 MB/s (220X) <sup>1)2)</sup> Max. 34 MB/s (226X) <sup>1)2)</sup>	Typically 27 MB/s (180X) <sup>1)2)</sup> Max. 28 MB/s (186X) <sup>1)2)</sup>	Typically 36 MB/s (240X) <sup>1)2)</sup> Max. 37 MB/s (247X) <sup>1)2)</sup>
Continuous writing	Typically 17 MB/s (110X) Max. 20 MB/s (133X)	Typically 17 MB/s (110X) Max. 20 MB/s (133X)	Typically 17 MB/s (110X) Max. 20 MB/s (133X)	Typically 16 MB/s (106X) Max. 18 MB/s (120X)	Typically 15 MB/s (100X) Max. 17 MB/s (110X)	Typically 18 MB/s (120X) Max. 19 MB/s (126X)
<b>Endurance</b>						
Guaranteed amount of data <sup>3)</sup> Results in 5 years <sup>3)</sup>	50 TB 27.40 GB/day	100 TB 54.79 GB/day	200 TB 109.59 GB/day	400 TB 219.18 GB/day	800 TB 438.36 GB/day	1600 TB 876.72 GB/day
Clear/write cycles Guaranteed Typical <sup>4)</sup>	100,000 2,000,000					
SLC flash	Yes					
Wear leveling	Static					
Error Correction Coding (ECC)	Yes					

Table 415: Technical data - CompactFlash cards 5CFCRD.xxxx-04

## Accessories • CompactFlash cards 5CFCRD.xxxx-04

Support	5CFCRD.0512-04	5CFCRD.1024-04	5CFCRD.2048-04	5CFCRD.4096-04	5CFCRD.8192-04	5CFCRD.016G-04
Hardware	PP300/400, PPC300, PPC700, PPC725, PPC800, APC620, APC810, APC820					
Windows XP Professional	-	-	-	Yes	Yes	Yes
Windows XP Embedded	Yes	Yes	Yes	Yes	Yes	Yes
Windows Embedded Standard 2009	-	Yes	Yes	Yes	Yes	Yes
Windows CE 6.0	Yes	Yes	Yes	Yes	Yes	Yes <sup>5)</sup>
Windows CE 5.0	-	-	-	-	-	-
PVI Transfer Tool	V3.2.3.8 (part of PVI Development Setup V2.06.00.3011)					-
B&R Embedded OS Installer	V3.10					-
<b>Mechanical characteristics</b>						
Dimensions						
Length	36.4 ±0.15 mm					
Width	42.8 ±0.10 mm					
Thickness	3.3 ±0.10 mm					
Weight	10 g					
<b>Environmental characteristics</b>						
Ambient temperature						
Operation	0 to 70°C					
Bearings	-65 to 150°C					
Transport	-65 to 150°C					
Relative humidity						
Operation/Storage/Transport	Max. 85% at 85°C					
Vibration						
Operation/Storage/Transport	20 G peak, 20- 2000 Hz, 4 in each direction (JEDEC JESD22, method B103) 5.35 G RMS, 15 min per level (IEC 68-2-6)					
Shock						
Operation/Storage/Transport	1.5k G peak, 0.5 ms 5 times (JEDEC JESD22, method B110) 30 G, 11 ms 1 time (IEC 68-2-27)					
Altitude	Max. 15,000 feet (4,572 m)					

Table 415: Technical data - CompactFlash cards 5CFCRD.xxxx-04 (Forts.)

- 1) Speed specification with 1X = 150 KB/s. All specifications refer to the Samsung Flash chips, CompactFlash cards in UDMA mode 4, 30 ns cycle time in True-IDE mode with sequential write/read test.
- 2) The file is written/read sequentially in True IDE mode with the DOS program Thruput.exe.
- 3) Endurance of B&R CF cards (linear written block size with 128 KB)
- 4) Depending on the average file size.
- 5) Not supported by B&R Embedded OS installer.

### 8.3.1 Temperature humidity diagram

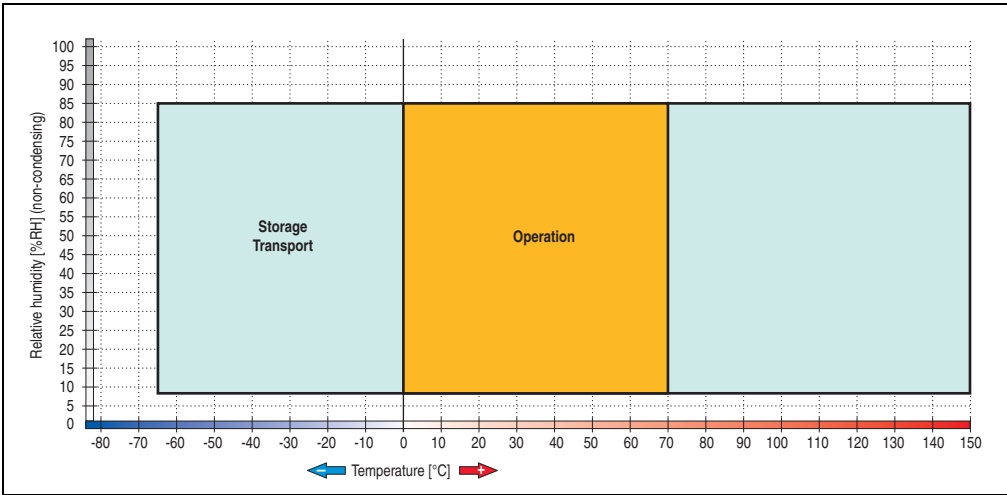

Figure 308: Temperature humidity diagram - CompactFlash cards 5CFCRD.xxxx-04

### 8.4 Dimensions

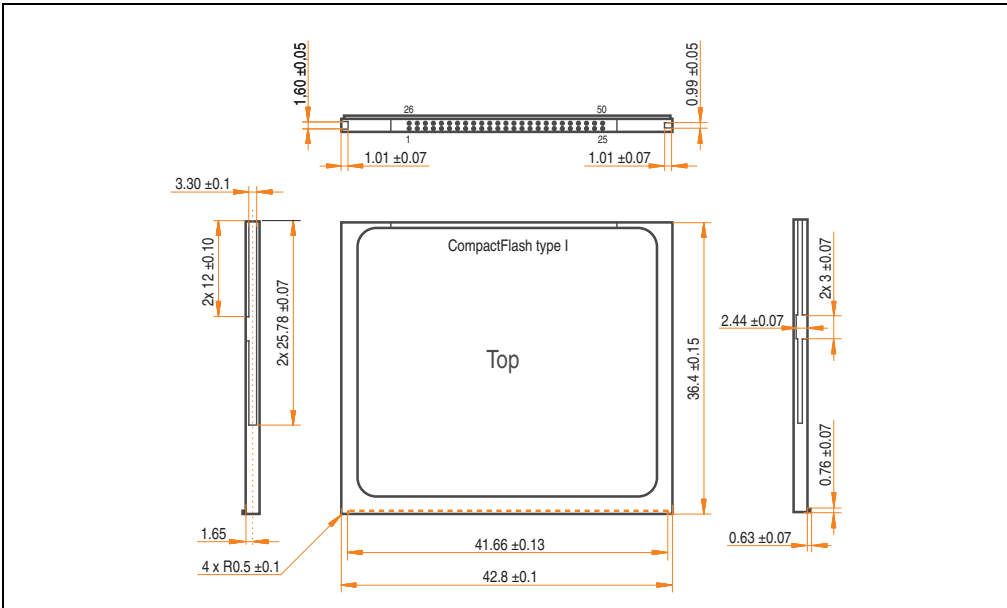

Figure 309: Dimensions - CompactFlash card Type I

## 8.5 Benchmark

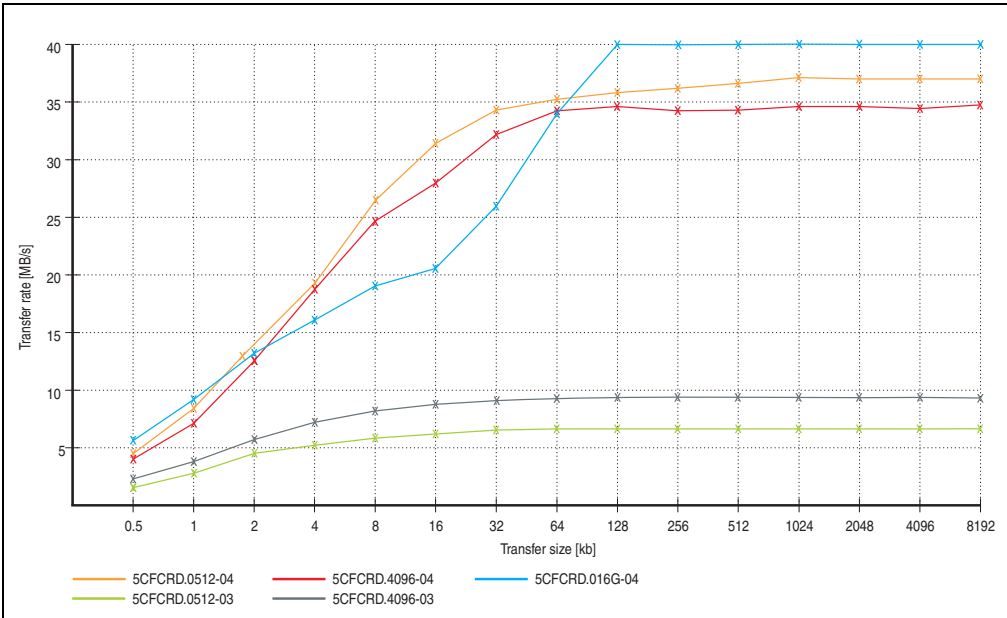

Figure 310: ATTO disk benchmark v2.34 comparison (reading)

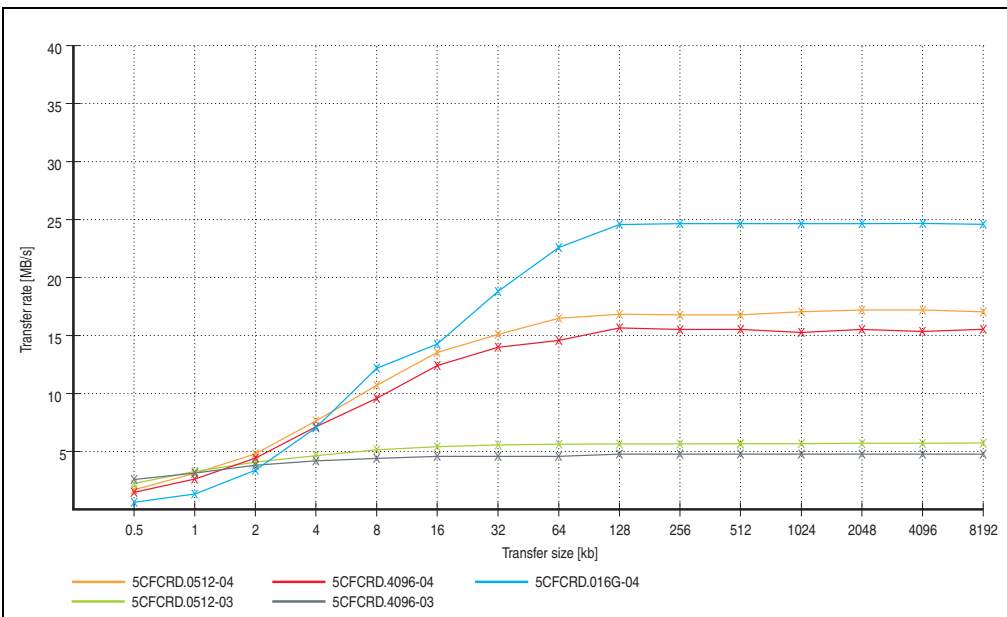

Figure 311: ATTO disk benchmark v2.34 comparison (writing)

## 9. CompactFlash cards - 5CFCRD.xxxx-03

### 9.1 General information

#### Information:

Silicon Systems CompactFlash cards 5CFCRD.xxxx-03 and CompactFlash cards from a different manufacturer cannot be used in the same system at the same time. Due to differences in technology (older vs. newer technologies), problems can occur during system startup that are caused by the different boot times.

See chapter 3 "Commissioning", section 9 "Known problems / issues", on page 369.

#### Information:

On Windows CE 5.0 devices, 5CFCRD.xxxx-03 CompactFlash cards up to 1GB are supported.

### 9.2 Order data

Model number	Description	Figure
5CFCRD.0064-03	CompactFlash 64 MB SSI	 <p>CompactFlash card</p>
5CFCRD.0128-03	CompactFlash 128 MB SSI	
5CFCRD.0256-03	CompactFlash 256 MB SSI	
5CFCRD.0512-03	CompactFlash 512 MB SSI	
5CFCRD.1024-03	CompactFlash 1024 MB SSI	
5CFCRD.2048-03	CompactFlash 2048 MB SSI	
5CFCRD.4096-03	CompactFlash 4096 MB SSI	
5CFCRD.8192-03	CompactFlash 8192 MB SSI	

Table 416: Order data - CompactFlash cards

### 9.3 Technical data

## Caution!

A sudden loss of power can cause data to be lost! In very rare cases, the mass memory may also become damaged.

To prevent damage and loss of data, B&R recommends that you use a UPS device.

## Information:

The following characteristics, features and limit values only apply to this accessory and can deviate those specified for the entire device. For the entire device where this accessory is installed, refer to the data provided specifically for the entire device.

Features	5CFCRD. 0064-03	5CFCRD. 0128-03	5CFCRD. 0256-03	5CFCRD. 0512-03	5CFCRD. 1024-03	5CFCRD. 2048-03	5CFCRD. 4096-03	5CFCRD. 8192-03
MTBF (at 25°C)	> 4,000,000 hours							
Maintenance	None							
Data reliability	< 1 unrecoverable error in 10 <sup>14</sup> bit read accesses							
Data retention	10 years							
Lifetime monitoring	Yes							
Supported operating modes	PIO Mode 0-4, Multiword DMA Mode 0-2							
Continuous reading	Typically 8 MB/s							
Continuous writing	Typically 6 MB/s							
<b>Endurance</b>								
Clear/write cycles Typical	> 2,000,000							
SLC flash	Yes							
Wear leveling	Static							
Error Correction Coding (ECC)	Yes							
<b>Support</b>								
Hardware	MP100/200, PP100/200, PP300/400, PPC300, PPC700, PPC725, PPC800, Provit 2000, Provit 5000, APC620, APC680, APC810, APC820							
Windows XP Professional	-	-	-	-	-	-	Yes	Yes
Windows XP Embedded	-	-	-	Yes	Yes	Yes	Yes	Yes
Windows Embedded Standard 2009	-	-	-	-	Yes	Yes	Yes	Yes
Windows CE 6.0	Yes	Yes	Yes	Yes	Yes	Yes	Yes	Yes <sup>1)</sup>

Table 417: Technical data - CompactFlash cards 5CFCRD.xxxx-03



## Accessories • CompactFlash cards - 5CFCRD.xxxx-03

Support	5CFCRD. 0064-03	5CFCRD. 0128-03	5CFCRD. 0256-03	5CFCRD. 0512-03	5CFCRD. 1024-03	5CFCRD. 2048-03	5CFCRD. 4096-03	5CFCRD. 8192-03
Windows CE 5.0	Yes	Yes	Yes	Yes	Yes	-	-	-
PVI Transfer Tool	V2.57 (part of PVI Development Setup V2.5.3.3005)							
B&R Embedded OS Installer	V2.21							
<b>Mechanical characteristics</b>								
Dimensions								
Length	36.4 ±0.15 mm							
Width	42.8 ±0.10 mm							
Thickness	3.3 ±0.10 mm							
Weight	11.4 g							
<b>Environmental characteristics</b>								
Ambient temperature								
Operation	0 to 70°C							
Bearings	-50 to 100°C							
Transport	-50 to 100°C							
Relative humidity								
Operation/Storage/Transport	8 to 95%, non-condensing							
Vibration								
Operation	max. 16.3 g (159 m/s <sup>2</sup> 0-peak)							
Storage/Transport	max. 30 g (294 m/s <sup>2</sup> 0-peak)							
Shock								
Operation	Max. 1000 g (9810 m/s <sup>2</sup> 0-peak)							
Storage/Transport	Max. 3000 g (29430 m/s <sup>2</sup> 0-peak)							
Altitude	Maximum 80,000 feet (24,383 meters)							

Table 417: Technical data - CompactFlash cards 5CFCRD.xxxx-03 (Forts.)

1) Not supported by B&R Embedded OS installer.

### 9.3.1 Temperature humidity diagram

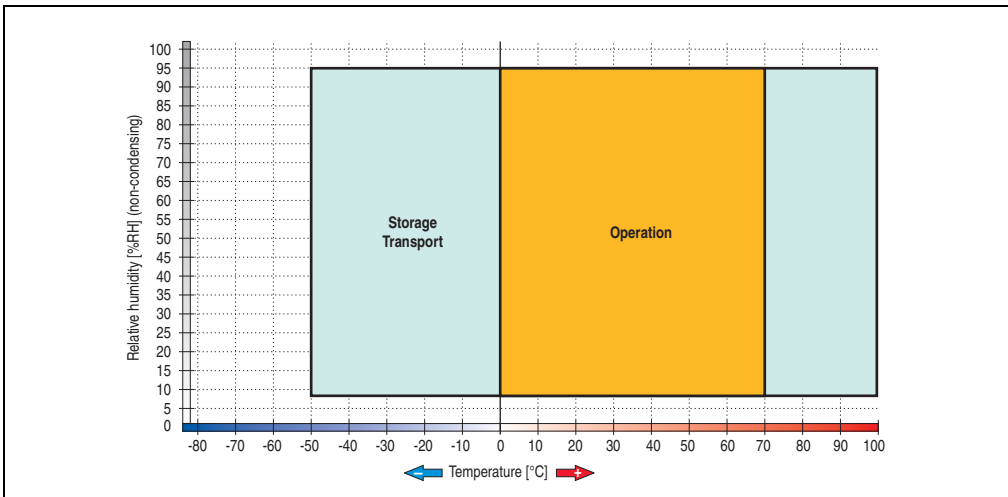

Figure 312: Temperature humidity diagram - CompactFlash cards 5CFCRD.xxxx-03

### 9.4 Dimensions

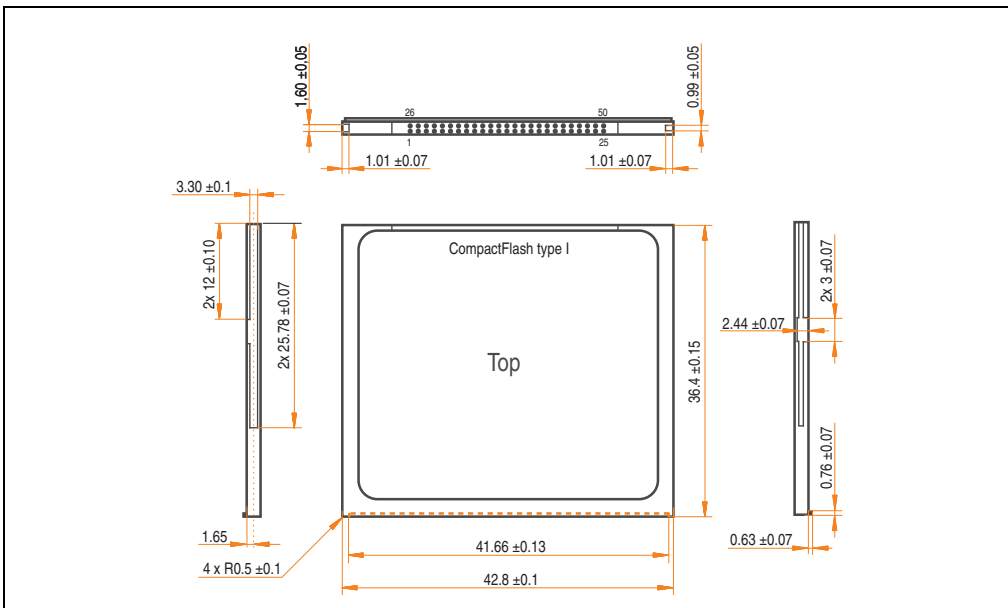

Figure 313: Dimensions - CompactFlash card Type I

## 10. CompactFlash cards 5CFCRD.xxxx-02

### 10.1 General information

#### Information:

SanDisk CompactFlash cards 5CFCRD.xxxx-02 and CompactFlash cards from a different manufacturer cannot be used in the same system at the same time. Due to differences in technology (older vs. newer technologies), problems can occur during system startup that are caused by the different boot times.

See chapter 3 "Commissioning", section 9 "Known problems / issues", on page 369.

CompactFlash cards are easy-to-exchange storage media. Due to their robustness against environmental influences (e.g. temperature, shock, vibration, etc.), CompactFlash cards are ideal for use as storage media in industrial environments.

### 10.2 Order data

Model number	Description	Figure
5CFCRD.0032-02	CompactFlash 32 MB SanDisk/A	
5CFCRD.0064-02	CompactFlash 64 MB SanDisk/A	
5CFCRD.0128-02	CompactFlash 128 MB SanDisk/A	
5CFCRD.0256-02	CompactFlash 256 MB SanDisk/A	
5CFCRD.0512-02	CompactFlash 512 MB SanDisk/A	
5CFCRD.1024-02	CompactFlash 1024 MB SanDisk/A	
5CFCRD.2048-02	CompactFlash 2048 MB SanDisk/A	

Table 418: Order data - CompactFlash cards 5CFCRD.xxxx-02

### 10.3 Technical data

#### Information:

The following characteristics, features and limit values only apply to this accessory and can deviate from those specified for the entire device. For the entire device where this accessory is installed, refer to the data provided specifically for the entire device.

## Accessories • CompactFlash cards 5CFCRD.xxxx-02

Features	5CFCRD.xxxx-02
MTBF (at 25°C)	> 3,000,000 hours
Maintenance	None
Data reliability	< 1 unrecoverable error in 10 <sup>14</sup> bit read accesses < 1 faulty correction in 10 <sup>20</sup> bit read accesses
Write/erase procedures	> 2,000,000 times
<b>Mechanical characteristics</b>	
Dimensions	
Length	36.4 ±0.15 mm
Width	42.8 ±0.10 mm
Thickness	3.3 mm ±0.10 mm
Weight	11.4 g
<b>Environmental characteristics</b>	
Ambient temperature	
Operation	0 to 70°C
Bearings	-25 to 85°C
Transport	-25 to 85°C
Relative humidity	
Operation / Storage	8 to 95%, non-condensing
Vibration	
Operation / Storage	Maximum 30 g (point to point)
Shock	
Operation / Storage	Maximum 3,000 g
Altitude	24,000 meters

Table 419: Technical data - CompactFlash cards 5CFCRD.xxxx-02

## 10.4 Dimensions

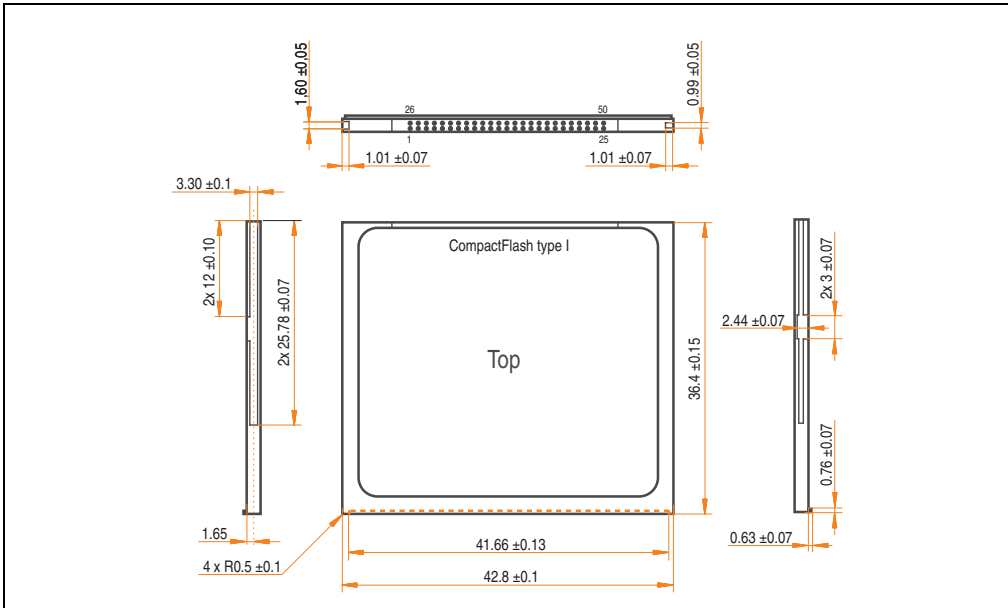

Figure 314: Dimensions - CompactFlash card Type I

## 10.5 Calculating the lifespan

SanDisk provides a 6-page "white paper" for the lifespan calculation of CompactFlash cards (see following pages). This document can also be found on the SanDisk homepage.

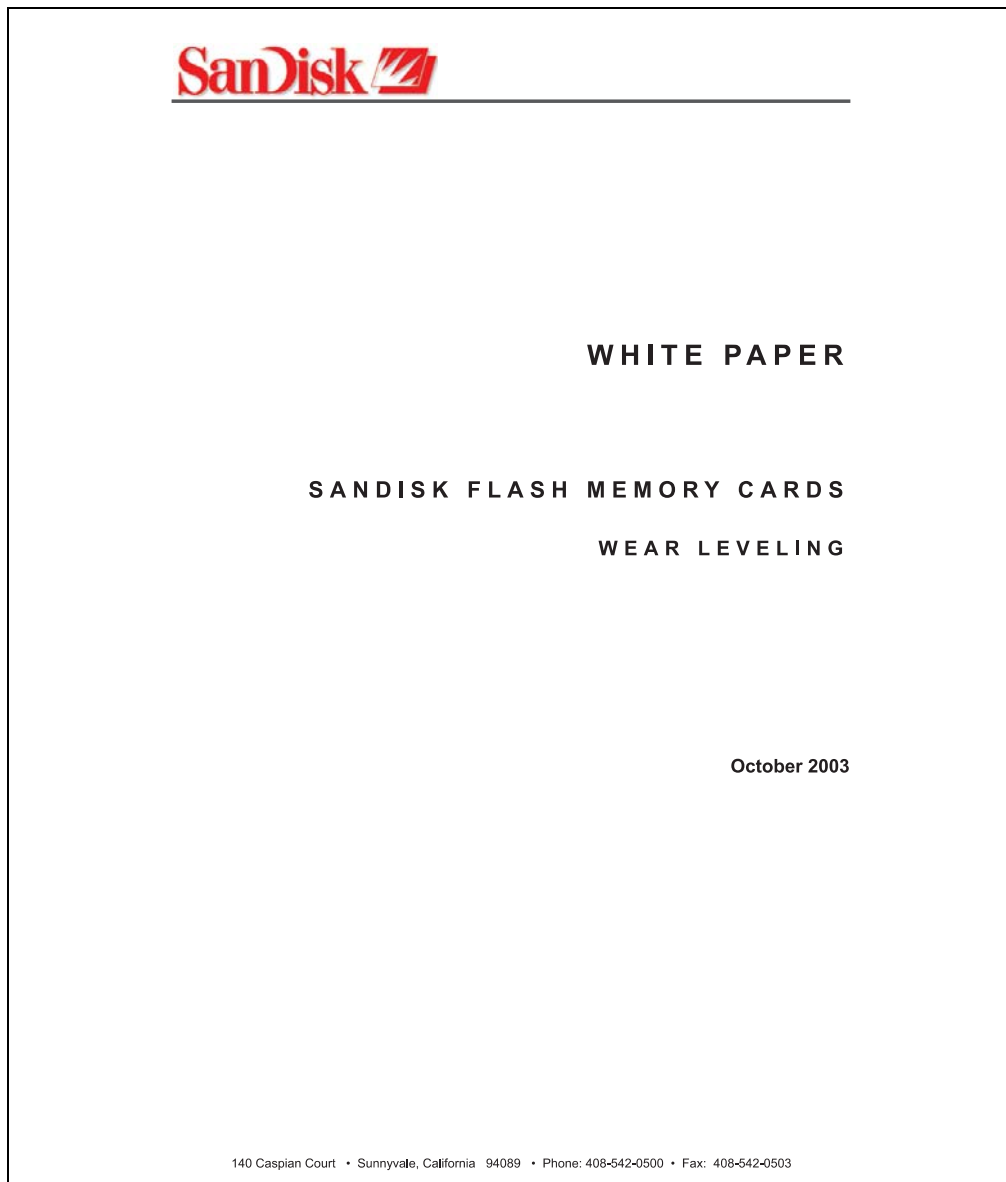

Figure 315: SanDisk white paper - page 1 of 6

*SanDisk® Corporation general policy does not recommend the use of its products in life support applications where in a failure or malfunction of the product may directly threaten life or injury. Per SanDisk Terms and Conditions of Sale, the user of SanDisk products in life support applications assumes all risk of such use and indemnifies SanDisk against all damages.*

*The information in this manual is subject to change without notice.*

*SanDisk Corporation shall not be liable for technical or editorial errors or omissions contained herein; nor for incidental or consequential damages resulting from the furnishing, performance, or use of this material.*

*All parts of the SanDisk documentation are protected by copyright law and all rights are reserved. This documentation may not, in whole or in part, be copied, photocopied, reproduced, translated, or reduced to any electronic medium or machine-readable form without prior consent, in writing, from SanDisk Corporation.*

*SanDisk and the SanDisk logo are registered trademarks of SanDisk Corporation.*

*Product names mentioned herein are for identification purposes only and may be trademarks and/or registered trademarks of their respective companies.*

*© 2003 SanDisk Corporation. All rights reserved.*

*SanDisk products are covered or licensed under one or more of the following U.S. Patent Nos. 5,070,032; 5,095,344; 5,168,465; 5,172,338; 5,198,380; 5,200,959; 5,268,318; 5,268,870; 5,272,669; 5,418,752; 5,602,987. Other U.S. and foreign patents awarded and pending.*

*Lit. No. 80-36-00278 10/03 Printed in U.S.A.*

---

**SanDisk Corporation**

Doc No. 80-36-00278

SanDisk Flash Memory Cards Wear Leveling

Page 2

Figure 316: SanDisk white paper - page 2 of 6

## OVERVIEW

This purpose of this white paper is to help SanDisk customers understand the benefits of wear leveling and to assist customers in calculating life expectancy of SanDisk cards in specific applications.

Flash memory is susceptible to wear as a result of the repeated program and erase cycles that are inherent in typical data storage applications. Applications in which this is a major concern include hard disk replacement applications where write operations occur frequently. How a storage system manages the wear of the memory is key to understanding the extended reliability of the host that relies on these storage systems.

## WEAR LEVELING METHODOLOGY

Current products available in the industrial channel use NAND flash memory. It is important to understand the NAND memory architecture to gain insight into the wear leveling mechanism.

Each memory chip is divided into blocks. A block is an array of memory cells organized as sectors. The number of blocks and sectors vary from product to product. The minimum unit for a write or read operation is a page (or sector). The minimum unit for an erase operation is a block. Physical blocks are logically grouped into zones. For the current technology, a typical zone size is 4 MB. However, this may change from product to product. Wear leveling is done within a zone. The current firmware does not spread the wear across the capacity of the card. Each zone has about 3% additional "spare blocks" beyond what is assigned to meet the logical capacity of the flash card. This group of blocks is commonly referred to as the "Erase Pool".

With the introduction of SanDisk's Write-before-Erase architecture, each time a host writes data to the same logical address (CHS or LBA), data is written into a newly assigned, empty physical block from the "Erase Pool". The intrinsic nature of writing to a new physical location each time a logical address is written to is the basis for wear leveling found in SanDisk cards. This action spreads the writes over the zone, thus greatly extending the overall life of the card. The methodology of using a large number of physical addresses to manage a smaller logical address table allows for rotation of the physical addresses among the entire group of physical blocks within a zone. The resulting wear leveling optimizes the effective life of the media and avoids prematurely reaching the end of life on frequently written to host addresses.

When a card detects that a block has reached the end of its useful life, it removes that block from the blocks that are available for write operations. The result is a reduction of the size of the erase pool. This does not affect the capacity of the card as seen by the host. When the pool of blocks available for write operations has been exhausted due to wear, the card will reach the end of its useful life for write operations.

---

SanDisk Corporation

Doc No. 80-36-00278

SanDisk Flash Memory Cards Wear Leveling

Page 3

Figure 317: SanDisk white paper - page 3 of 6



Current SanDisk products do not preempt wear leveling events during normal operation of the card. Applications typically don't require such management beyond the natural wear leveling that occurs during normal host operations. As a result, the effectiveness of wear leveling in current SanDisk products is dependent upon host usage. It is important for customers whose applications do not fall into this typical usage pattern to understand how their applications will affect the lifetime of the card.

## LIFE EXPECTANCY SCENARIOS

### ► best case analysis

In a typical application, large data files are written to the card occupying contiguous sequential logical address space. This results in optimal wear leveling and provides card life exceeding the specification for card endurance. This increased endurance is achieved as follows: The 2,000,000 endurance cycles specification (I-Grade only) is a result of large amounts of test data collected from a very large sample set that accounts for the extreme limits of the test population. With the 3% additional erase pool being used in an ideal fashion, the distribution is narrowed and the card will survive beyond its specified lifetime.

### ► worst case analysis

In the worst-case application, data will be written as single sectors to random addresses across the card. These single sector writes will exercise the erase pool more rapidly, requiring the system to perform a "garbage collection" operation to free up new blocks for subsequent write operations. At the extreme, each single sector write would cause one block to be programmed and erased. As a typical block size is 16kB or 32 sectors, the amount of wear is increased by a factor of 31 since 32 physical sectors are written and erased for each sector the host writes. Spreading this wear across the erase pool results in an effective 1/30 usable lifetime. This case is an extreme example and is only included to show the range of application dependence. This result is comparable to other vendor's cards based on memory with a 16kB erase block.

### ► analysis of host dependence

In assessing the life expectancy of a card in a given system several factors need to be understood. These factors include the types of files and their corresponding sizes, frequency of card write operations and file system behavior (including data structures). The types of files must be considered since some files, such as operating systems or executable files, typically remain in fixed locations once they are stored in the card. This limits the number of physical blocks available for circulation into the erase pool. The remaining capacity after these files have been accounted for can then be divided by the typical size of files that will be updated over the lifetime of the card. Related to this calculation is how the file system overwrites existing files. Typical operating system behavior, such as DOS, will allocate new blocks from the file allocation table, or FAT, and so repeated file writes will occupy a new set of addresses on the card. This is very beneficial in spreading wear across the card since it forces the card to cycle the entire physical

---

#### SanDisk Corporation

Figure 318: SanDisk white paper - page 4 of 6

area being used for such files. Special cases to consider include those where the files being updated are very small. Typically an operating system uses a minimum number of sectors to store a file, referred to as a cluster. Typical cluster sizes range from 8 to 64 sectors in size. The cluster size is important for files that are the same or smaller than the 32-sector block since these may trigger garbage collection operations. If these updates happen in a random fashion (sequential updates would not be affected by cluster size) lifetime may be reduced as a result. Finally, the frequency of such updates is then used to determine how long it will take before the card reaches its statistical limit for endurance. These factors can be combined in an equation that can be used to calculate the minimum time a card will function in that application:

$$lifetime = 2,000,000 \times \frac{(C_{zone} - C_{fixed}) \times \left(1 - k_r \times \frac{32 - N_{cluster}}{32}\right)}{FS_{typ}} \times \frac{1}{f_w}$$

where  $C_{zone}$  is the total capacity of the zone,  $C_{fixed}$  is the capacity used by fixed files,  $N_{cluster}$  is the cluster size,  $FS_{typ}$  is the average file size and  $f_w$  is the average frequency at which files are updated.  $k_r$  is a factor that is 0 for file sizes that are typically over 16kB or for applications that are not random in the order in which such files are updated.

#### Example 1

In this example 128 KB of data is updated once a day. The zone has 500 KB worth of fixed files. A 4 MB zone size is assumed.

$$lifetime = 2,000,000 \times \frac{(4000 - 500) \times (1 - 0)}{128} \times \frac{1}{1/day}$$

$$lifetime = 149828 \text{ years}$$

#### Example 2

This example is a data logging operation using a 1GB card where a 4kB file is updated every five seconds. This would result in sequential address being written.

$$lifetime = 2,000,000 \times \frac{4000}{4} \times \frac{1}{1/5 \text{ sec}}$$

$$lifetime = 317 \text{ years}$$

---

SanDisk Corporation

Figure 319: SanDisk white paper - page 5 of 6

**Example 3**

This example is a data logging operation using the same 1GB card where a new 4kB file is written every five seconds. But in this case the cluster size is 4kB and it is expected that, due to file system fragmentation, the logical addresses will be written randomly.

$$lifetime = 2,000,000 \times \frac{4 \times \left(1 - 1 \times \frac{32-8}{32}\right)}{.004} \times \frac{1}{1/5 \text{ sec}}$$

$$lifetime = 79.3 \text{ years}$$

**CONCLUSION**

These examples are general in nature but show how the equation can be used as a guideline for calculating card lifetime in different applications. They also demonstrate that SanDisk card architecture exceeds reasonable life expectancy in typical applications. If a particular applications behaves in such a way that this equation cannot be applied, the SanDisk Applications Engineering group can assist in performing card lifetime analysis.

For more information, please visit the SanDisk Web site at: [www.sandisk.com](http://www.sandisk.com)

**SanDisk Corporation**

Corporate Headquarters  
140 Caspian Court  
Sunnyvale, CA 94089  
408-542-0500  
FAX: 408-542-0503  
URL: <http://www.sandisk.com>

**SanDisk Corporation**

Figure 320: SanDisk white paper - page 6 of 6

## 11. USB Media Drive 5MD900.USB2-00



Figure 321: USB Media Drive 5MD900.USB2-00

### 11.1 Features

- Desk-top or rack-mount operation (mounting rail brackets)
- Integrated USB diskette drive
- Integrated DVD-ROM/CD-RW drive
- Integrated CompactFlash slot IDE/ATAPI (Hot Plug capable)
- Integrated USB 2.0 connection (up to 480 MBit high speed)
- +24 VDC supply (back side)
- USB/B 2.0 connection (back side)
- Optional front cover (model number 5A5003.03 see also section 11.8 "Front cover 5A5003.03 for the USB Media Drive", on page 673)

## 11.2 Technical data

### Information:

The following characteristics, features and limit values only apply to this accessory and can deviate from those specified for the entire device. For the entire device where this accessory is installed, refer to the data provided specifically for the entire device.

Features - entire device	5MD900.USB2-00
Transfer rate	Low speed (1.5 MBit/s), full speed (12 MBit/s), to high speed (480 Mbit/s)
Maximum cable length	5 m (not including hub)
Power supply Rated voltage	24 VDC $\pm$ 25%
Features - diskette drive	
Data capacity	720 KB / 1.25 MB / 1.44 MB (formatted)
Data transfer rate	250 kbit/s (720 KB) or 500 kbit/s (1.25 MB and 1.44 MB)
Rotation speed	Up to 360 rpm
Diskette media	High density (2HD) or normal density (2DD) 3.5" diskettes
MTBF	30,000 POH (Power-On Hours)
Features - DVD-ROM/CD-RW drive	
Write speed CD-R CD-RW	24x, 16x, 10x and 4x 10x and 4x
Reading rate CD DVD	24x 8x
Data transfer rate	Max. 33.3 MB/s
Access time (average) CD DVD	85 ms 110 ms
Revolution speed	Max. 5136 rpm $\pm$ 1%
Starting time (0 rpm to read access)	19 seconds (maximum)
Host interface	IDE (ATAPI)
Readable media CD DVD	CD/CD-ROM (12 cm, 8 cm), CD-R, CD-RW DVD-ROM, DVD-R, DVD-RW, DVD-RAM
Non-write protected media CD	CD-R, CD-RW
Write-methods	Disk at once, session at once, packet write, track at once
Laser class	Class 1 laser
Data buffer capacity	2 MB

Table 420: Technical data - USB Media Drive 5MD900.USB2-00

## Accessories • USB Media Drive 5MD900.USB2-00

Features - DVD-ROM/CD-RW drive	5MD900.USB2-00
Compatible formats	CD-DA, CD-ROM mode 1/mode 2 CD-ROM XA mode 2 (form 1, form 2) Photo CD (single/multi-session) Enhanced CD, CD text DVD-ROM, DVD-R, DVD-Video (double layer) DVD-RAM (4.7 GB, 2.6 GB)
Noise level (complete read access)	Approx. 45 dBA at 50 cm
Lifespan Opening/closing the drawer	60,000 POH (Power-On Hours) > 10,000 times
CompactFlash slot layout	
CompactFlash Type Amount Connection	Type I 1 slot IDE/ATAPI
CompactFlash LED	Signals read or write access to an inserted CompactFlash card
Hot Plug capable	Yes
Features - USB connections	
USB A on the front side Power supply	Connection of further peripheral devices Max. 500 mA
USB B back side	Connection to the system
Mechanical characteristics	
Outer dimensions (without slide-in) Width Length Height	70 mm 100 mm 9.5 mm
Weight	Approx. 1.1 kg (without front cover)
Environmental characteristics	
Ambient temperature Operation Bearings Transport	5 to 45°C -20 to 60°C -40 to 60°C
Relative humidity Operation Bearings Transport	20 to 80%, non-condensing 5 to 90%, non-condensing 5 to 95%, non-condensing
Vibration Operation Bearings Transport	At max. 5 - 500 Hz and 0.3 g At max. 10 - 100 Hz and 2 g At max. 10 - 100 Hz and 2 g
Shock (pulse with a sine half-wave) Operation Storage (packaged) Transport (packaged)	At max. 5 g for 11 ms At max. 60 g for 11 ms At max. 60 g for 11 ms
Altitude	Max. 3000 meters

Table 420: Technical data - USB Media Drive 5MD900.USB2-00 (Forts.)

### 11.3 Dimensions

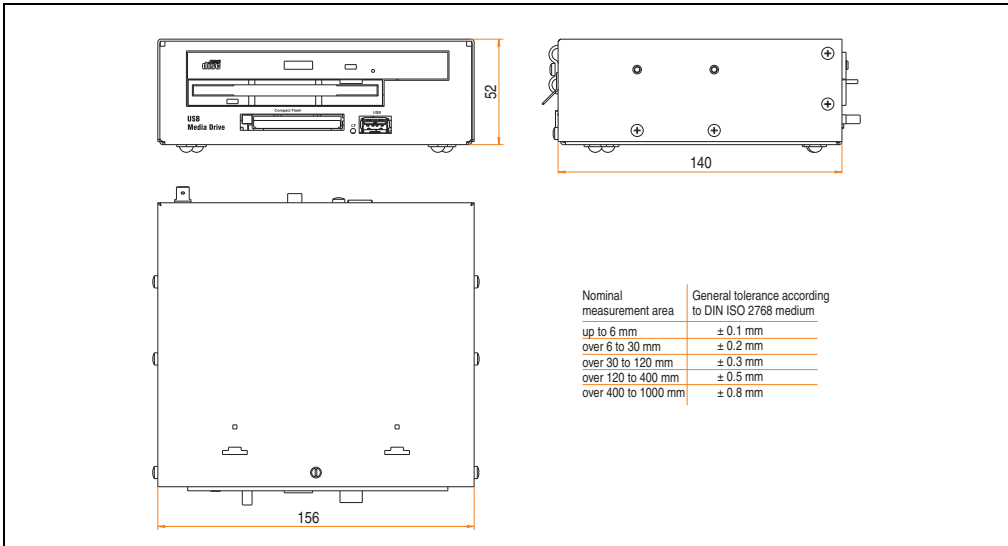

Figure 322: Dimensions for USB Media Drive 5MD900.USB2-00

### 11.4 Dimensions with front cover

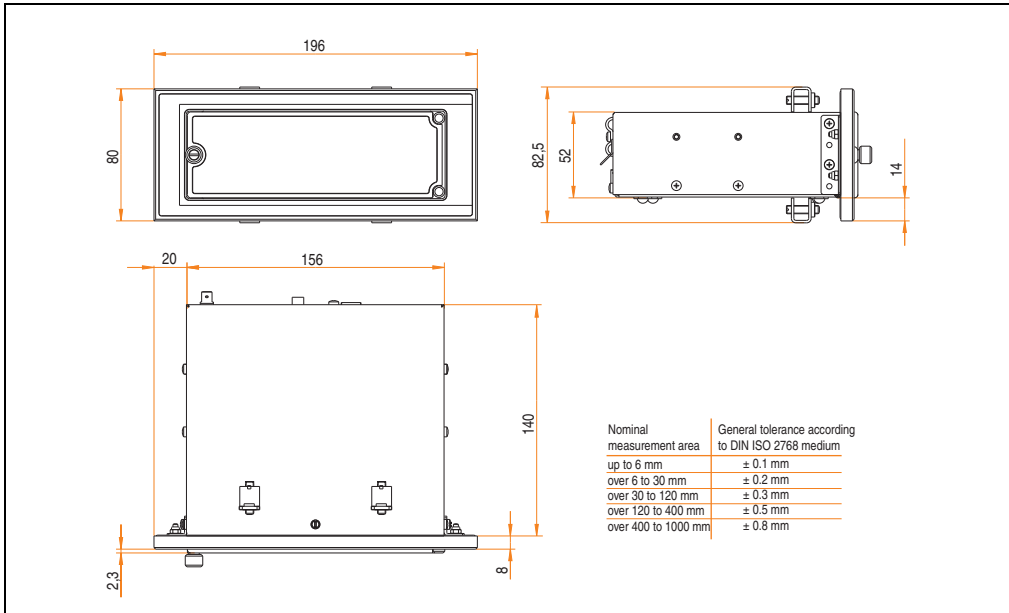

Figure 323: Dimensions - USB Media Drive with front cover

### 11.5 Contents of delivery

Amount	Component
1	USB Media Drive complete unit
2	Mounting rail brackets

Table 421: Contents of delivery - USB Media Drive 5MD900.USB2-00

### 11.6 Interfaces

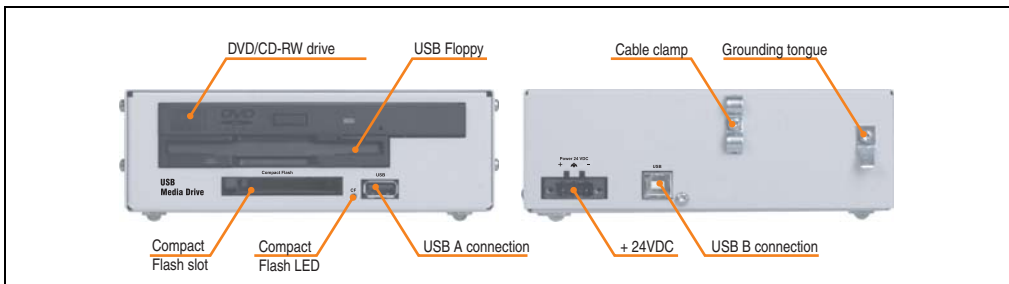

Figure 324: Interfaces for USB Media Drive 5MD900.USB2-00



## 11.7 Installation

The USB Media Drive can be operated as a desk-top device (rubber feet) or as a rack-mount device (2 mounting rail brackets included).

### 11.7.1 Mounting orientation

Because of limits to the mounting orientation with the components used (floppy, DVD-CDRW drive), the USB media drive is only permitted to be mounted and operated as shown in the following figure.

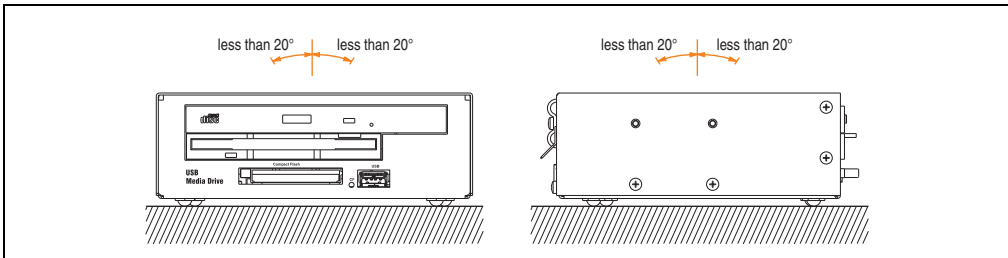

Figure 325: Mounting orientation of USB Media Drive 5MD900.USB2-00

### 11.8 Front cover 5A5003.03 for the USB Media Drive

This front cover can also be mounted on the front of the USB media drive (model number 5MD900.USB2-00 or 5MD900.USB2-01) to protect the interface.

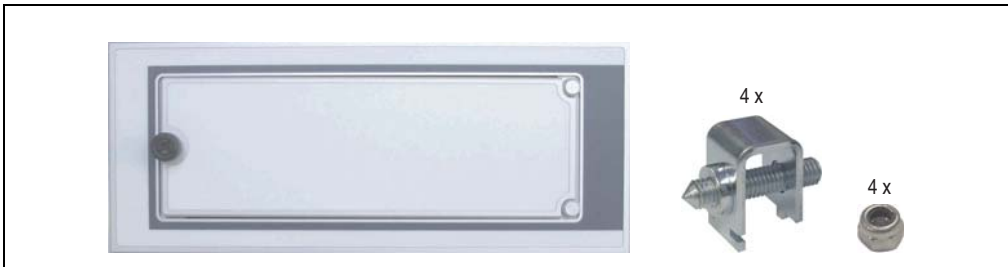

Figure 326: Front cover 5A5003.03

#### 11.8.1 Technical data

Features	5A5003.03
Front cover design / colors Dark gray border around the cover Light gray background	Similar to Pantone432CV Similar to Pantone 427CV

Table 422: Technical data - 5A5003.03

### 11.8.2 Dimensions

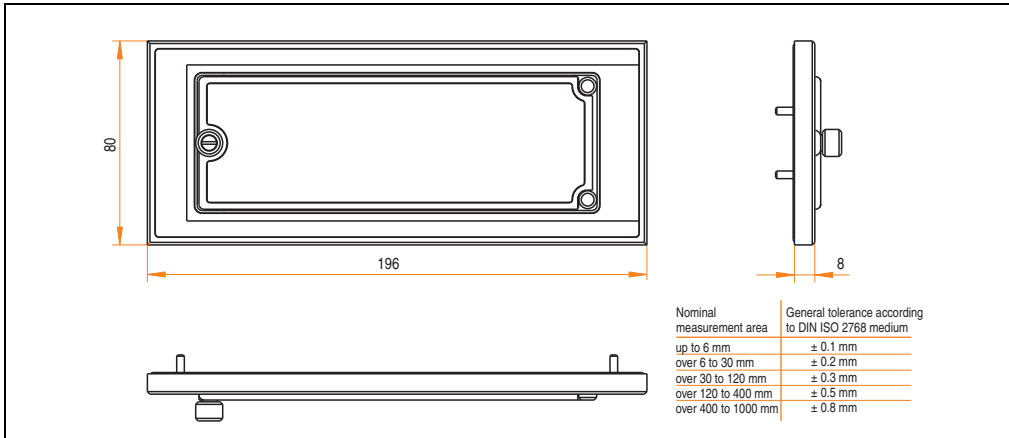

Figure 327: Dimensions - 5A5003.03

### 11.8.3 Installation

The front cover is attached with 2 mounting rail brackets (included with USB Media Drive) and 4 locknuts. The USB media drive and front cover can be mounted as a whole in (for example) a switching cabinet door.

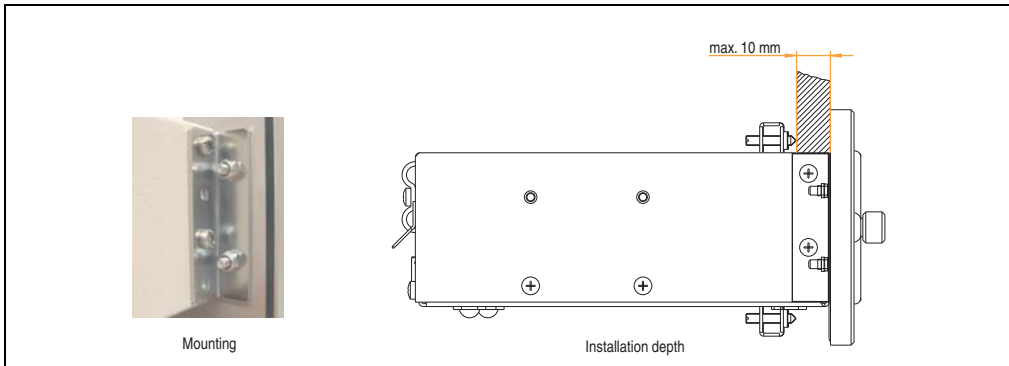

Figure 328: Front cover mounting and installation depth

## 12. USB Media Drive - 5MD900.USB2-01



Figure 329: USB Media Drive - 5MD900.USB2-01

### 12.1 Features

- Desk-top or rack-mount operation (mounting rail brackets)
- Integrated USB diskette drive
- Integrated DVD-RW/CD-RW drive
- Integrated CompactFlash slot IDE/ATAPI (Hot Plug capable)
- Integrated USB 2.0 connection (up to 480 MBit high speed)
- +24 VDC supply (back side)
- USB/B 2.0 connection (back side)
- Optional front cover (model number 5A5003.03 see also section 12.8 "Front cover 5A5003.03 for the USB Media Drive", on page 680)

## 12.2 Technical data

### Information:

The following characteristics, features and limit values only apply to this accessory and can deviate from those specified for the entire device. For the entire device where this accessory is installed, refer to the data provided specifically for the entire device.

Features - entire device	5MD900.USB2-01
Transfer rate	Low speed (1.5 MBit/s), full speed (12 MBit/s), to high speed (480 Mbit/s)
Maximum cable length	5 m (not including hub)
Power supply Rated voltage	24 VDC $\pm$ 25%
Features - diskette drive	
Data capacity	720 KB / 1.25 MB / 1.44 MB (formatted)
Data transfer rate	250 kbit/s (720 KB) or 500 kbit/s (1.25 MB and 1.44 MB)
Rotation speed	Up to 360 rpm
Diskette media	High density (2HD) or normal density (2DD) 3.5" diskettes
MTBF	30,000 POH (Power-On Hours)
Features - DVD-RW/CD-RW drive	
Write speed CD-R CD-RW DVD-R DVD-RW DVD-RAM <sup>1)</sup> DVD+R DVD+R (double layer) DVD+RW	24x, 16x, 10x and 4x 10x and 4x 8x, 4x and 2x 4x and 2x 3x and 2x 8x, 4x and 2x 2x, 4x 4x and 2x
Reading rate CD DVD	24x 8x
Data transfer rate	Max. 33.3 MB/s
Access time (average) CD DVD	130 ms (24x) 130 ms (8x)
Revolution speed	Max. 5090 rpm $\pm$ 1%
Starting time (0 rpm to read access) CD DVD	14 seconds (maximum) 15 seconds (maximum)
Host interface	IDE (ATAPI)
Laser class	Class 1 laser

Table 423: Technical data - USB Media Drive 5MD900.USB2-01

## Accessories • USB Media Drive - 5MD900.USB2-01

Features - DVD-ROM/CD-RW drive	5MD900.USB2-01
Readable media CD DVD	CD/CD-ROM (12 cm, 8 cm), CD-R, CD-RW DVD-ROM, DVD-R, DVD-RW, DVD-RAM, DVD+R, DVD+R (double layer), DVD+RW
Non-write protected media CD DVD	CD-R, CD-RW DVD-R/RW, DVD-RAM (4.7 GB), DVD+R/RW, DVD+R (double layer)
Compatible formats	CD-DA, CD-ROM mode 1/mode 2 CD-ROM XA mode 2 (form 1, form 2) Photo CD (single/multi-session), Enhanced CD, CD text DVD-ROM, DVD-R, DVD-RW, DVD-Video DVD-RAM (4.7 GB, 2.6 GB) DVD+R, DVD+R (double layer), DVD+RW
Write-methods CD DVD	Disk at once, session at once, packet write, track at once Disk at once, incremental, over-write, sequential, multi-session
Data buffer capacity	8 MB
Noise level (complete read access)	Approx. 48 dBA at 50 cm
Lifespan Opening/closing the drawer	60,000 POH (Power-On Hours) > 10,000 times
CompactFlash slot layout	
CompactFlash Type Amount Connection	Type I 1 slot IDE/ATAPI
CompactFlash LED	Signals read or write access to an inserted CompactFlash card
Hot Plug capable	Yes
Features - USB connections	
USB A on the front side Power supply Type Transfer rate	Connection of further peripheral devices Max. 500 mA 2.0 Low speed (1.5 MBit/s), full speed (12 MBit/s), to high speed (480 Mbit/s)
USB B back side	Connection to the system
Mechanical characteristics	
Outer dimensions (without slide-in) Width Length Height	70 mm 100 mm 9,5 mm
Weight	Approx. 1.1 kg (without front cover)
Environmental characteristics	
Ambient temperature Operation Bearings Transport	5 to 45°C -20 to 60°C -40 to 60°C

Table 423: Technical data - USB Media Drive 5MD900.USB2-01 (Forts.)

Environmental characteristics	5MD900.USB2-01
Relative humidity Operation Bearings Transport	20 to 80%, non-condensing 5 to 90%, non-condensing 5 to 95%, non-condensing
Vibration Operation Bearings Transport	At max. 5 - 500 Hz and 0.3 g At max. 10 - 100 Hz and 2 g At max. 10 - 100 Hz and 2 g
Shock (pulse with a sine half-wave) Operation Storage (packaged) Transport (packaged)	At max. 5 g for 11 ms At max. 60 g for 11 ms At max. 60 g for 11 ms
Altitude	Max. 3000 meters

Table 423: Technical data - USB Media Drive 5MD900.USB2-01 (Forts.)

1) RAM drivers are not provided by the manufacturer. Support of RAM function by the burning software "Nero" (model number 5SWUT1.0000-00) or other burning software packages and drivers from third party providers.

### 12.3 Dimensions

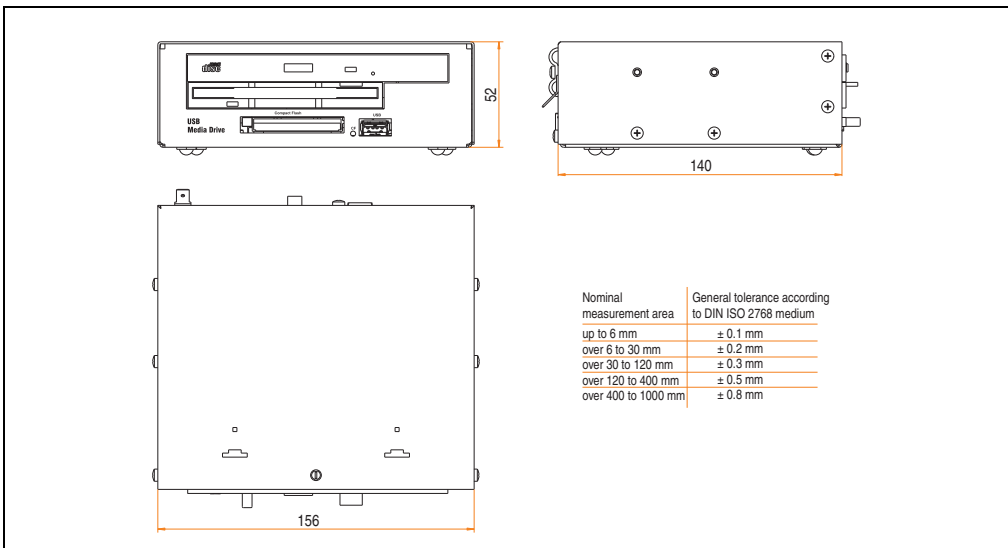

Figure 330: Dimensions - 5MD900.USB2-01

## 12.4 Dimensions with front cover

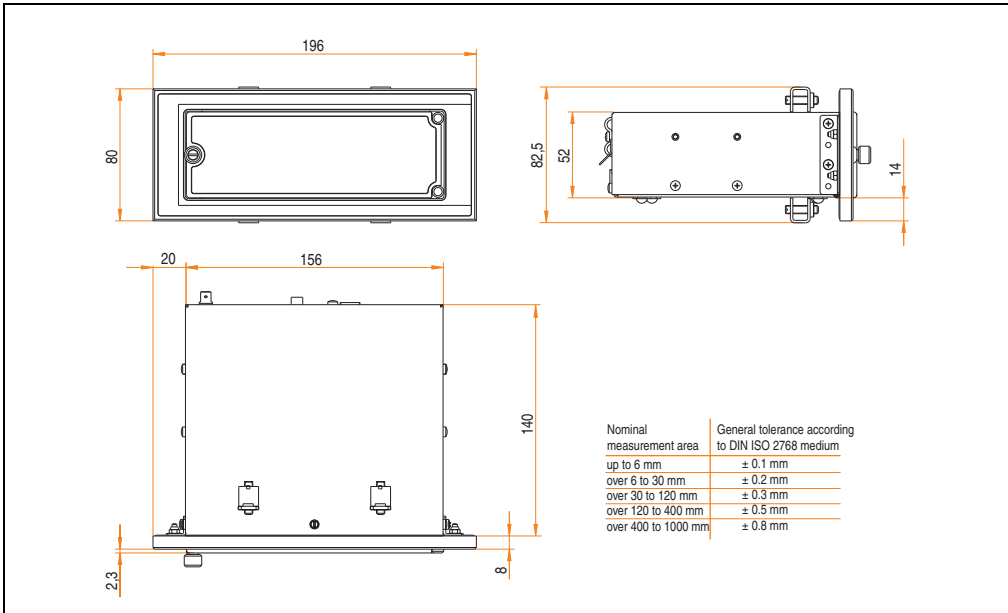

Figure 331: Dimensions - USB Media Drive with front cover

## 12.5 Contents of delivery

Amount	Component
1	USB Media Drive complete unit
2	Mounting rail brackets

Table 424: Contents of delivery - USB Media Drive - 5MD900.USB2-01

## 12.6 Interfaces

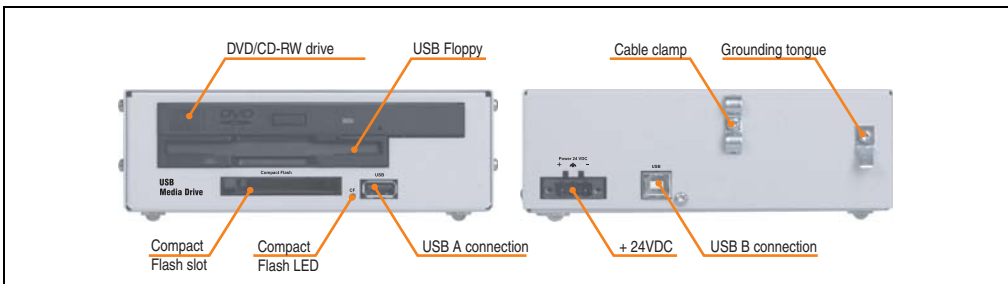

Figure 332: Interfaces - 5MD900.USB2-01

## 12.7 Installation

The USB Media Drive can be operated as a desk-top device (rubber feet) or as a rack-mount device (2 mounting rail brackets included).

### 12.7.1 Mounting orientation

Because of limits to the mounting orientation with the components used (floppy, DVD-CDRW drive), the USB media drive is only permitted to be mounted and operated as shown in the following figure.

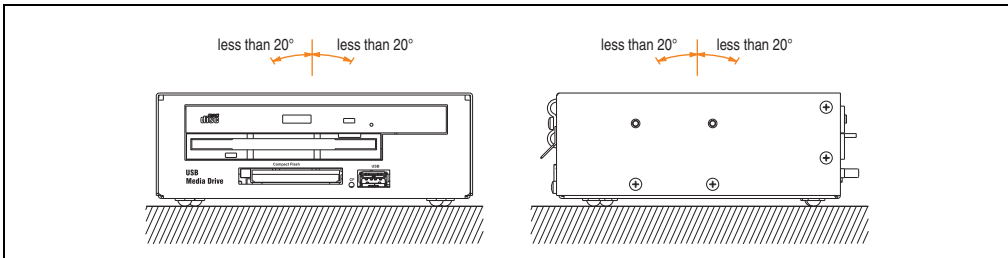

Figure 333: Mounting orientation - 5MD900.USB2-01

### 12.8 Front cover 5A5003.03 for the USB Media Drive

This front cover can also be mounted on the front of the USB media drive (model number 5MD900.USB2-00 or 5MD900.USB2-01) to protect the interface.

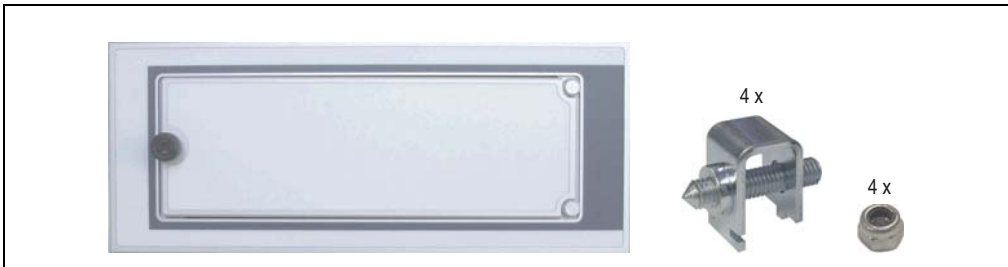

Figure 334: Front cover 5A5003.03

#### 12.8.1 Technical data

Features	5A5003.03
Front cover design / colors Dark gray border around the cover Light gray background	Similar to Pantone432CV Similar to Pantone 427CV

Table 425: Technical data - 5A5003.03



### 12.8.2 Dimensions

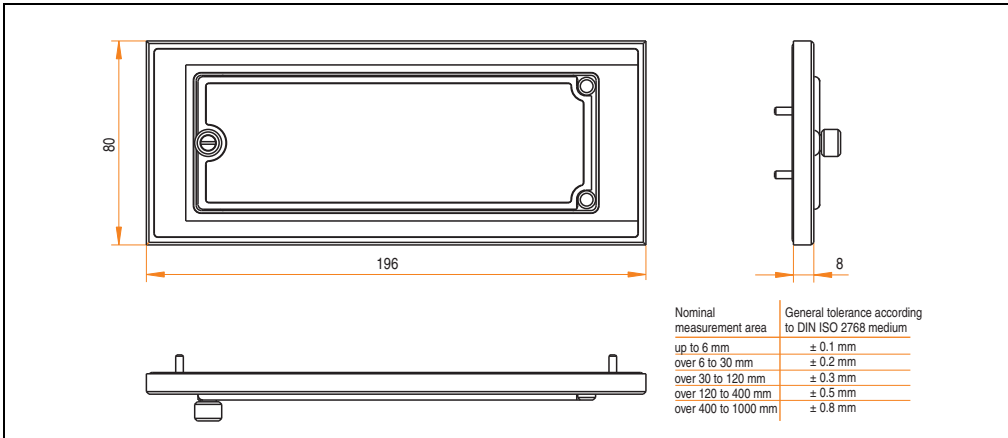

Figure 335: Dimensions - 5A5003.03

### 12.8.3 Installation

The front cover is attached with 2 mounting rail brackets (included with USB Media Drive) and 4 locknuts. The USB media drive and front cover can be mounted as a whole in (for example) a switching cabinet door.

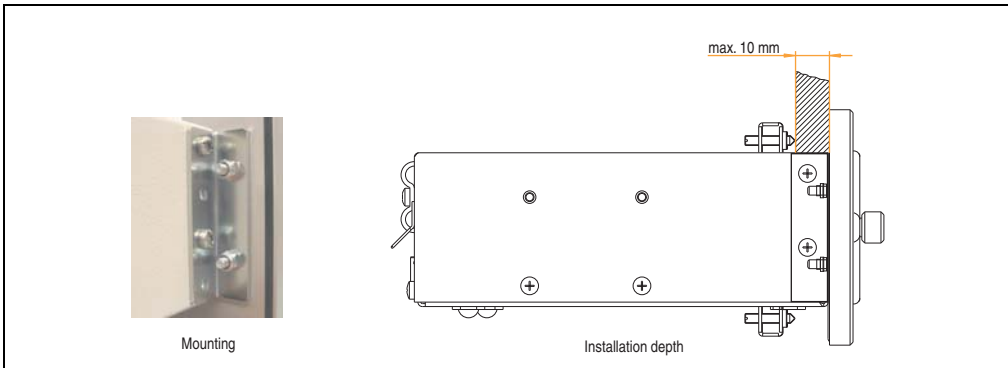

Figure 336: Front cover mounting and installation depth

## 13. USB flash drive

### Information:

We reserve the right to supply alternative products due to the vast quantity of flash drives available on the market and their corresponding short product lifecycle. Therefore, the following measures might be necessary in order to boot from these flash drives (e.g. the SanDisk Cruzer Micro flash drive with 512 MB):

- The flash drive must be reformatted or in some cases even re-partitioned (set active partition).
- The flash drive must be at the top of the BIOS boot order, or alternatively the IDE controllers can also be deactivated in the BIOS. This can be avoided in most cases if a "`fdisk /mbr`" command is also executed on the USB flash drive.

### 13.1 General information

USB flash drives are easy-to-exchange storage media. Because of the fast data transfer provided by USB 2.0, USB flash drives are ideal for use as a portable memory medium. Without requiring additional drivers ("Hot Plug & Play" - except with Windows 98SE), the USB flash drive can be converted immediately into an additional drive where data can be read or written.

### 13.2 Order data

Model number	Description	Figure
5MMUSB.0128-00	USB flash drive 128 MB SanDisk Cruzer Mini	 <p>SanDisk Cruzer® Mini</p> <p>SanDisk Cruzer® Mini 512 MB</p> <p>SanDisk Cruzer® Micro</p> <p>B&amp;R USB Memory Stick</p>
5MMUSB.0256-00	USB flash drive 256 MB SanDisk Cruzer Mini	
5MMUSB.0512-00	USB flash drive 512 MB SanDisk Cruzer Mini up to Rev. E0 or Cruzer Micro starting with Rev. E0	
5MMUSB.1024-00	USB flash drive 1 GB SanDisk Cruzer Mini up to Rev. E0 or Cruzer Micro starting with Rev. E0	
5MMUSB.2048-00	USB flash drive 2 GB SanDisk Cruzer Micro	
5MMUSB.2048-01	USB flash drive 2 GB B&R	

Table 426: Order data - USB flash drives

### 13.3 Technical data - 5MMUSB.xxxx-00

## Information:

The following characteristics, features and limit values only apply to this accessory and can deviate those specified for the entire device. For the entire device where this accessory is installed, refer to the data provided specifically for the entire device.

Features	5MMUSB.0128-00	5MMUSB.0256-00	5MMUSB.0512-00	5MMUSB.1024-00	5MMUSB.2048-00
LED Cruzer Mini / Cruzer Micro	1 LED (green), signals data transfer (send and receive)				
Power supply Current requirements Cruzer Mini / Cruzer Micro	Via the USB port 650 µA in sleep mode, 150 mA read/write				
Interface Cruzer Mini / Cruzer Micro Type Transfer rate Sequential reading Sequential writing Connection	USB specification 2.0 high speed device, mass storage class, USB-IF and WHQL certified USB 1.1 and 2.0 compatible Up to 480 MBit (high speed) Max. 8.7 MB/second Max. 1.7 MB/second To each USB type A interface				
MTBF (at 25°C) Cruzer Mini / Cruzer Micro	100,000 hours				
Data retention Cruzer Mini / Cruzer Micro	10 years				
Maintenance Cruzer Mini / Cruzer Micro	None				
Operating system support Cruzer Mini Cruzer Micro	Windows CE 4.1, CE 4.2, 98SE <sup>1</sup> , ME, 2000, XP, Mac OS 9.1.x and Mac OS X 10.1.2 Windows CE 4.2, CE 5.0, ME, 2000, XP and Mac OS 9.1.x+, OS X v10.1.2+				
<b>Mechanical characteristics</b>					
Dimensions Height - Cruzer Mini / Cruzer Micro Width - Cruzer Mini / Cruzer Micro Depth - Cruzer Mini / Cruzer Micro	62 mm / 52.2 mm 19 mm / 19 mm 11 mm / 7.9 mm				
<b>Environmental characteristics</b>					
Environmental temperature Cruzer Mini / Cruzer Micro <sup>2)</sup> Operation Bearings Transport	0 to +45°C -20 to +60°C -20 to +60°C				
Humidity Cruzer Mini / Cruzer Micro Operation Bearings Transport	10 to 90%, non-condensing 5 to 90%, non-condensing 5 to 90%, non-condensing				

Table 427: Technical data - USB flash drive 5MMUSB.xxxx-00

## Accessories • USB flash drive

Features	5MMUSB.0128-00	5MMUSB.0256-00	5MMUSB.0512-00	5MMUSB.1024-00	5MMUSB.2048-00
Vibration Cruiser Mini / Cruiser Micro Operation Bearings Transport	At 10 - 500 Hz: 2 g (19.6 m/s <sup>2</sup> 0-peak), oscillation rate 1/minute At 10 - 500 Hz: 4 g (39.2 m/s <sup>2</sup> 0-peak), oscillation rate 1/minute At 10 - 500 Hz: 4 g (39.2 m/s <sup>2</sup> 0-peak), oscillation rate 1/minute				
Shock Cruiser Mini / Cruiser Micro Operation Bearings Transport	Max. 40 g (392 m/s <sup>2</sup> 0-peak) and 11 ms length Max. 80 g (784 m/s <sup>2</sup> 0-peak) and 11 ms length Max. 80 g (784 m/s <sup>2</sup> 0-peak) and 11 ms length				
Altitude Cruiser Mini / Cruiser Micro Operation Bearings Transport	3,048 meters 12,192 meters 12,192 meters				

Table 427: Technical data - USB flash drive 5MMUSB.xxxx-00 (Forts.)

- 1) For Win 98SE, a driver can be downloaded from the [SanDisk](#) homepage.
- 2) Temperature data is for operation at 500 meters. Derating the max. ambient temperature - typically 1°C per 1000 meters (from 500 meters above sea level).

### 13.3.1 Temperature humidity diagram

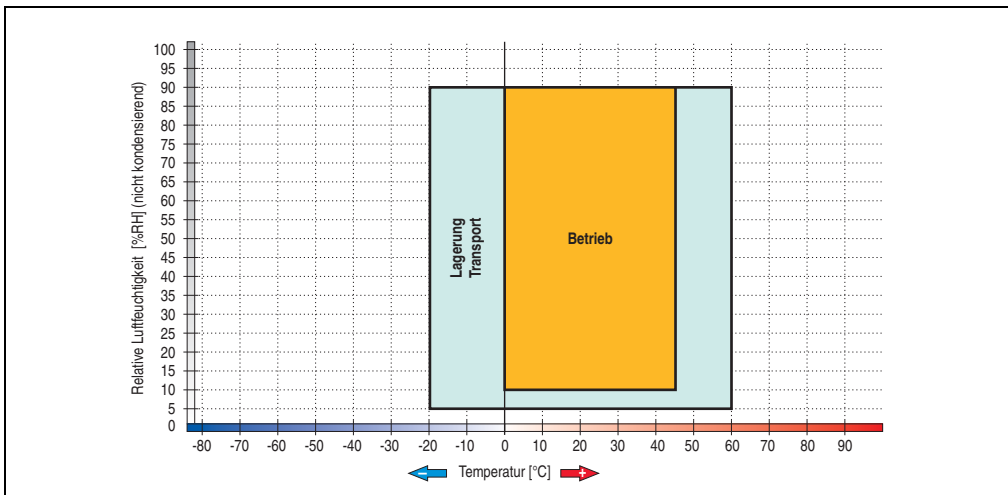

Figure 337: Temperature humidity diagram for flash drives 5MMUSB.xxxx-00

## 13.4 Technical data - 5MMUSB.2048-01

### Information:

The following characteristics, features and limit values only apply to this accessory and can deviate those specified for the entire device. For the entire device where this accessory is installed, refer to the data provided specifically for the entire device.

Features	5MMUSB.2048-01
LED	1 LED (green), signals data transfer (send and receive)
Power supply Current requirements	Via the USB port max. 500 µA sleep mode, max. 120 mA read/write
Interface Type Transfer rate Sequential reading Sequential writing Connection	USB specification 2.0 high speed device, mass storage class, USB-IF and WHQL certified USB 1.1 and 2.0 compatible Up to 480 MBit (high speed) Max. 31 MB/second Max. 30 MB/second To each USB type A interface
MTBF	> 3,000,000 hours
Data retention	> 10 years
Maintenance	None
Operating system support	Windows CE, ME, 2000, XP, Vista und Mac OS 9 or newer, Linux 2.4 or newer
Mechanical characteristics	
Dimensions Length Width Thickness	67.85 mm 17.97 mm 8.35 mm
Environmental characteristics	
Ambient temperature Operation Bearings Transport	0 to 70°C -50 to 100°C -50 to 100°C
Relative humidity Operation Bearings Transport	85%, non-condensing 85%, non-condensing 85%, non-condensing
Vibration Operation Bearings Transport	At 20 - 2000 Hz: 20 g (peak) At 20 - 2000 Hz: 20 g (peak) At 20 - 2000 Hz: 20 g (peak)
Shock Operation Bearings Transport	max. 1500 g (peak) max. 1500 g (peak) max. 1500 g (peak)

Table 428: Technical data - USB flash drive 5MMUSB.2048-01

Environmental characteristics	5MMUSB.2048-01
Altitude	
Operation	3,048 meters
Bearings	12,192 meters
Transport	12,192 meters

Table 428: Technical data - USB flash drive 5MMUSB.2048-01 (Forts.)

### 13.4.1 Temperature humidity diagram

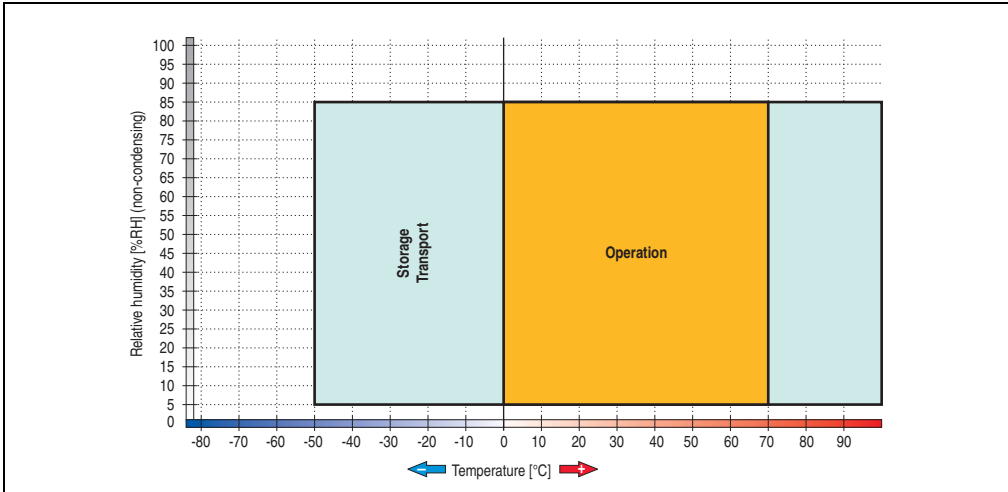

Figure 338: Temperature humidity diagram - USB flash drive - 5MMUSB.2048-01

Temperature data is for operation at 500 meters. Derating the max. ambient temperature - typically 1°C per 1000 meters (from 500 meters above sea level).

## 14. HMI Drivers & Utilities DVD 5SWHMI.0000-00



Figure 339: HMI Drivers & Utilities DVD 5SWHMI.0000-00

Model number	Short description	Note
5SWHMI.0000-00	HMI Drivers & Utilities DVD	

Table 429: Model number - HMI Drivers & Utilities DVD

This DVD contains drivers, utilities, software upgrades and user's manuals for B&R Panel system products (see B&R homepage [www.br-automation.com](http://www.br-automation.com) – Industrial PCs, Visualization and Operation).

At the time of its creation, the content on the DVD is identical to the files found in the download area of the B&R homepage (under Service – “Material Related Downloads”).

### BIOS upgrades for the products

- Automation PC 620 / Panel PC 700 CPU Board 815E und 855GME BIOS
- Automation PC 620 / Panel PC 700 CPU Board X855GME BIOS
- Automation PC 620 / Panel PC 700 CPU Board 945GME N270 BIOS
- Automation PC 680
- Automation PC 810 / Automation PC 820 / Panel PC 800 B945GME BIOS
- Automation PC 810 / Panel PC 800 945GME N270 CPU Board BIOS
- Automation PC 810 / Panel PC 800 GM45 CPU Board BIOS
- Provit 2000 products - IPC2000/2001/2002

- Provit 5000 products - IPC5000/5600/5000C/5600C
- Power Panel 100 BIOS devices
- Mobile Panel 100 BIOS devices
- Power Panel 100 / Mobile Panel 100 User Boot Logo
- Power Panel 100 / Mobile Panel 100 REMHOST Utility
- Power Panel 300/400 BIOS devices
- Power Panel 300/400 BIOS User Boot Logo
- Panel PC 310

### Drivers for the devices

- Automation Device Interface (ADI)
- Audio
- Chipset
- CD-ROM
- LS120
- Graphics
- Network
- PCI / SATA RAID controller
- Touch screen
- Touchpad
- Interfacecard

### Firmware Upgrades

- Automation PC 620 / Panel PC 700 (MTCX, SDLR, SDLT)
- Automation PC 810 (MTCX, SDLR, SDLT)
- Automation PC 820 (MTCX, SDLR, SDLT)
- Mobile Panel 100 (SMCX)
- Panel PC 300 (MTCX)
- Power Panel 100 (aPCI)
- Power Panel 300/400 (aPCI)
- Power Panel 300/400 (MTCX)
- Panel PC 800 (MTCX, SDLR, SDLT)
- UPS firmware



## Utilities / Tools

- B&R Embedded OS Installer
- Windows CE Tools
- User Boot Logo Conversion Utility
- SATA RAID Installations Utility
- Automation Device Interface (ADI)
- CompactFlash endurance calculator (Silicon Systems)
- Miscellaneous
- MTC Utilities
- Key Editor
- MTC & Mkey Utilities
- Mkey Utilities
- UPS configuration software
- ICU ISA configuration
- Intel PCI NIC Boot ROM
- Diagnostic Utilities

## Windows

- Windows CE 6.0
- Windows CE 5.0
- Windows CE 4.2
- Windows CE 4.1
- Windows CE Tools
- Windows Embedded Standard 2009
- Thin Client
- Windows NT Embedded
- Windows XP Embedded
- VNC Viewer

## MCAD templates for

- Industrial PCs
- Operator Interface devices
- Legend Strips templates
- Customized designs

## ECAD templates for

- Industrial PCs
- Automation PCs
- Automation Panel 900
- Panel (Power Panel)

## Documentation for

- Automation PC 620
- Automation PC 680
- Automation PC 810
- Automation PC 820
- Automation Panel 800
- Automation Panel 900
- Panel PC 310
- Panel PC 700
- Panel PC 725
- Panel PC 800
- Power Panel 15/21/35/41
- Power Panel 100/200
- Power Panel 300/400
- Mobile Panel 40/50
- Mobile Panel 100/200
- Mobile Panel connection box
- Provit 2000
- Provit 3030
- Provit 4000
- Provit 5000
- Provit Benchmark
- Provit Mkey
- Windows CE 5.0 help
- Windows CE 6.0 help
- Windows NT Embedded application guide
- Windows XP Embedded application guide
- UPS - uninterruptible power supply

- Implementation instructions
- B&R Hilscher fieldbus cards (CANopen, DeviceNet, PROFIBUS, PROFINET)

### **Service tools**

- Acrobat Reader 5.0.5 (freeware in German, English and French)
- Power Archiver 6.0 (freeware in German, English and French)
- Internet Explorer 5.0 (German and English)
- Internet Explorer 6.0 (German and English)

## 15. Cables

### 15.1 APC620 internal supply cable 5CAMSC.0001-00

This supply cable is used internally e.g. to supply special PCI cards. It is connected to the APC620 main board. For requirements and procedures, see appendix A, section "Connection of an external device to the main board", on page 792.

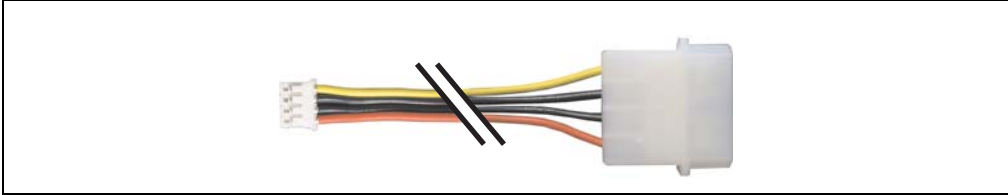

Figure 340: APC620 internal supply cable 5CAMSC.0001-00

#### 15.1.1 Order data

Model number	Description	Note
5CAMSC.0001-00	APC620 internal supply cable	

Table 430: Model number - APC620 internal supply cable

#### 15.1.2 Technical data

Features	5CAMSC.0001-00
Length	100 mm ±5 mm
Connector type	1x 4-pin male disk drive power plug, 1x 4-pin female plug housing
Wire cross section	AWG 22
Flexibility	Flexible

Table 431: Technical data - 5CAMSC.0001-00

## 15.2 DVI cable 5CADVI.0xxx-00

The DVI cables 5CADVI.0xxx-00 are designed for fixed layout.

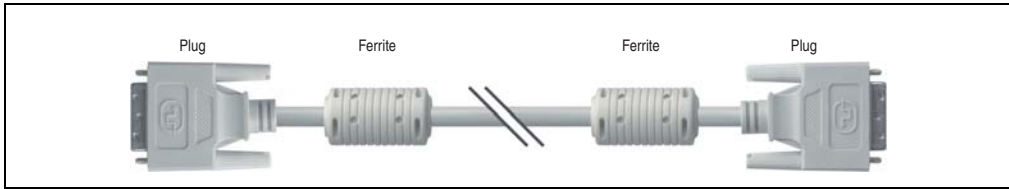

Figure 341: DVI extension cable (similar)

### Caution!

**DVI cables can only be plugged in and unplugged when the APC620 and display device (Automation Panel 900, monitor) are turned off.**

#### 15.2.1 Order data

Model number	Description	Note
5CADVI.0018-00	<b>DVI-D cable 1.8 m</b> Single cable, DVI-D/m:DVI-D/m; length: 1.8 m	
5CADVI.0050-00	<b>DVI-D cable 5 m</b> Single cable, DVI-D/m:DVI-D/m; length: 5 m	
5CADVI.0100-00	<b>DVI-D cable 10 m</b> Single cable, DVI-D/m:DVI-D/m; length: 10 m	

Table 432: Model numbers - DVI cables

### 15.2.2 Technical data

Features	5CADVI.0018-00	5CADVI.0050-00	5CADVI.0100-00
Length Tolerance	1.8 m ±30 mm	5 m ±50 mm	10 m ±100 mm
Cable diameter Maximum	8.5 mm		
Shielding	Individual cable pairs and entire cable		
Connector type Connection cycles	2x DVI-D (18+1), male 100		
Wire cross section	AWG 28		
Line resistance	Max. 237 Ω/km		
Insulation resistance	Min. 100 MΩ/km		
Flexibility	Limited flexibility; valid for ferrite magnet - ferrite magnet (tested 100 cycles with 5x cable diameter, 20 cycles / minute)		
Flex radius Fixed layout	See figure "Flex radius specification", on page 694 5x cable diameter (plug - ferrite magnet and ferrite magnet - ferrite magnet)		
Weight	Approx. 300 g	Approx. 590 g	Approx. 2100 g

Table 433: Technical data - DVI cable 5CADVI.0xxx-00

### 15.2.3 Flex radius specification

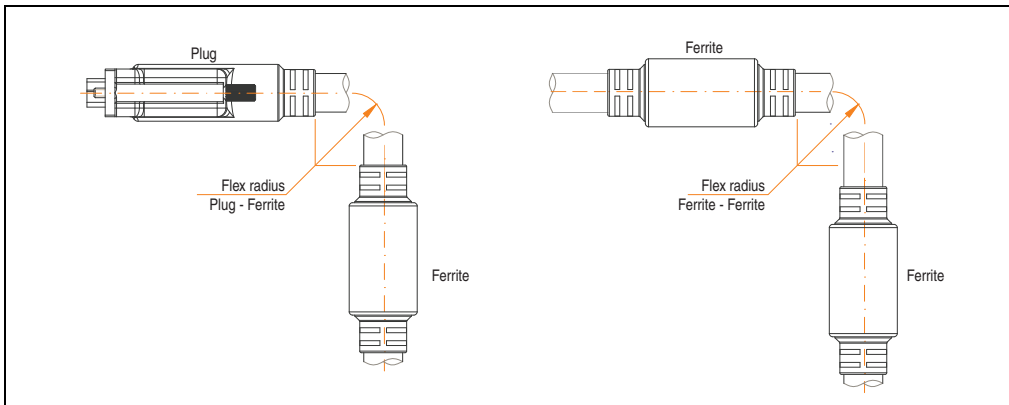

Figure 342: Flex radius specification

### 15.2.4 Cable specifications

The following figure shows the pin assignments for the DVI cable available at B&R. If you want to build a suitable cable yourself, it should be wired according to these specifications.

## Warning!

If a self-built cable is used, B&R cannot guarantee that it will function properly.

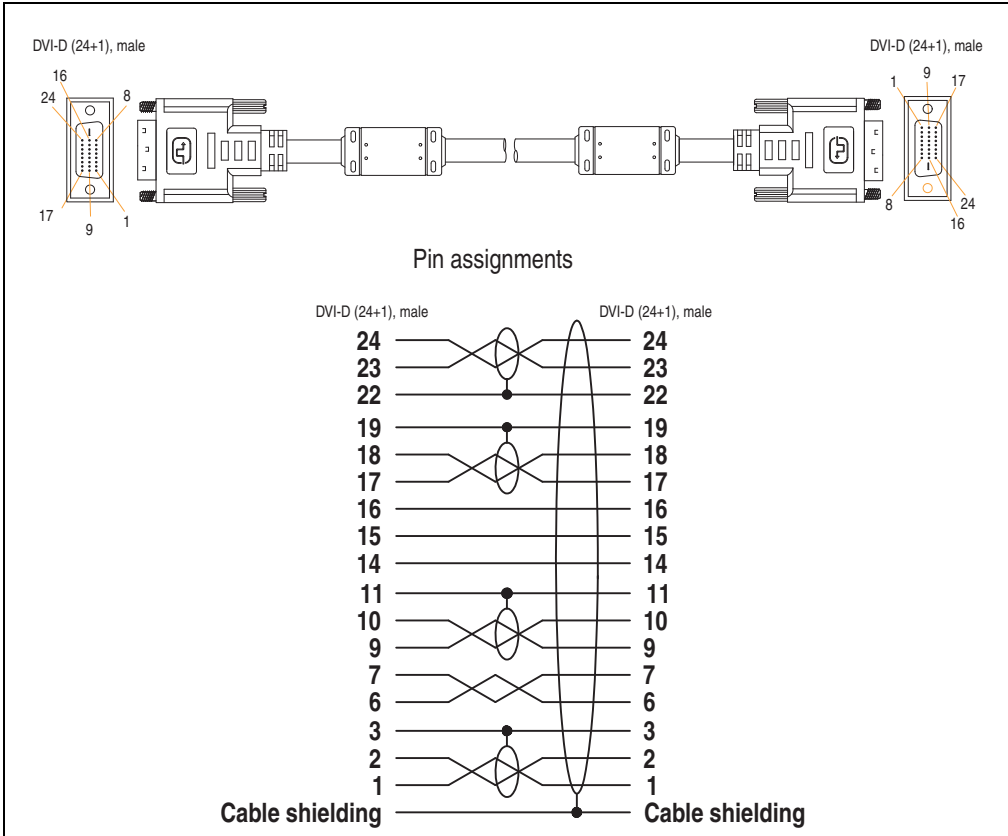

Figure 343: Pin assignments - DVI cable

### 15.3 SDL cable 5CASDL.0xxx-00

The SDL cables 5CASDL.0xxx-00 are designed for fixed layout. Use of the SDL flex cable 5CASDL.0xxx-03 is required for a flexible installation (e.g. in swing arm systems).

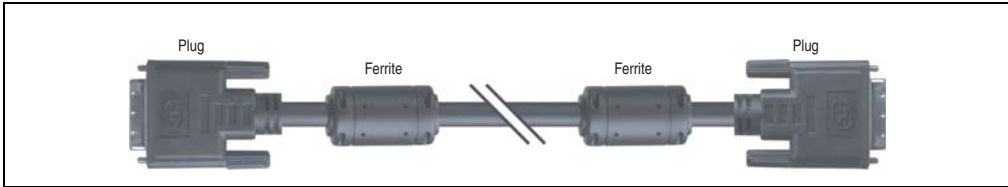

Figure 344: SDL extension cable (similar)

## Caution!

The SDI cable can only be plugged in and unplugged when the device is turned off.

#### 15.3.1 Order data

Model number	Description	Note
5CASDL.0018-00	<b>SDL cable 1.8 m</b> SDL cable for a fixed type of layout; length: 1.8 m	
5CASDL.0050-00	<b>SDL cable 5 m</b> SDL cable for a fixed type of layout; length: 5 m	
5CASDL.0100-00	<b>SDL cable 10 m</b> SDL cable for a fixed type of layout; length: 10 m	
5CASDL.0150-00	<b>SDL cable 15 m</b> SDL cable for a fixed type of layout; length: 15 m	
5CASDL.0200-00	<b>SDL cable 20 m</b> SDL cable for a fixed type of layout; length: 20 m	
5CASDL.0250-00	<b>SDL cable 25 m</b> SDL cable for a fixed type of layout; length: 25 m	
5CASDL.0300-00	<b>SDL cable 30 m</b> SDL cable for a fixed type of layout; length: 30 m	

Table 434: Model numbers - SDL cables



15.3.2 Technical data

Features	5CASDL.0018-00	5CASDL.0050-00	5CASDL.0100-00	5CASDL.0150-00	5CASDL.0200-00	5CASDL.0250-00	5CASDL.0300-00
Length Tolerance	1.8 m ±50 mm	5 m ±80 mm	10 m ±100 mm	15 m ±120 mm	20 m ±150 mm	25 m ±200 mm	30 m ±200 mm
Cable diameter Typical Maximum	8.6 ±0.2 mm 9 mm		11 ±0.2 mm 11.5 mm				
Shielding	Individual cable pairs and entire cable						
Connector type Connection cycles	2x DVI-D (24+1), male 100						
Wire cross section	AWG 28			AWG 24			
Line resistance	Max. 237 Ω/km			Max. 93 Ω/km			
Insulation resistance	Min. 10 MΩ/km						
Flexibility	Limited flexibility; valid for ferrite magnet - ferrite magnet (tested 100 cycles with 5x cable diameter, 20 cycles / minute)						
Halogen-free	No						
Flex radius Fixed layout	See figure "Flex radius specification", on page 697 5x cable diameter (plug - ferrite magnet and ferrite magnet - ferrite magnet)						
Weight	Approx. 300 g	Approx. 590 g	Approx. 2100 g	Approx. 3000 g	Approx. 4100 g	Approx. 5100 g	Approx. 6100 g

Table 435: Technical data - SDL cables 5CASDL.0xxx-00

15.3.3 Flex radius specification

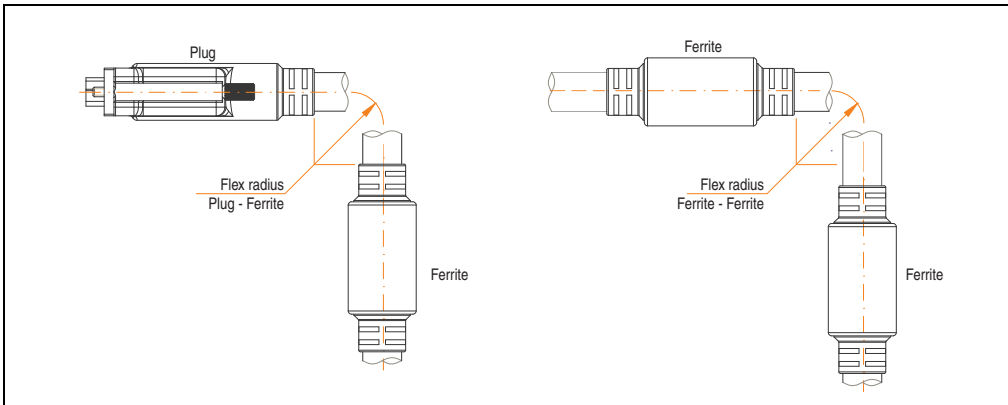

Figure 345: Flex radius specification

### 15.3.4 Cable specifications

The following figure shows the pin assignments for the SDL cable available at B&R. If you want to build a suitable cable yourself, it should be wired according to these specifications.

## Warning!

If a self-built cable is used, B&R cannot guarantee that it will function properly.

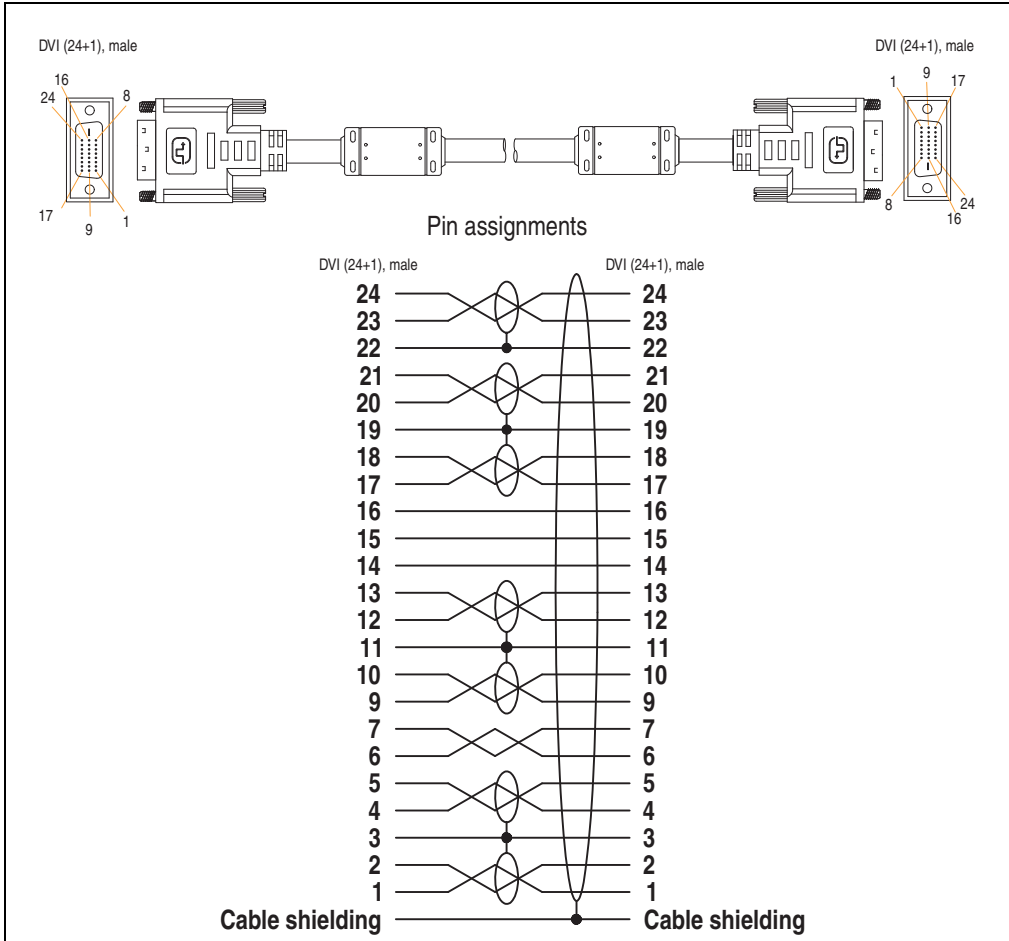

Figure 346: Pin assignments - SDL cable 5CASDL.0xxx-00

## 15.4 SDL cable with 45° plug 5CASDL.0xxx-01

The SDL cables 5CASDL.0xxx-01 are designed for fixed layout.

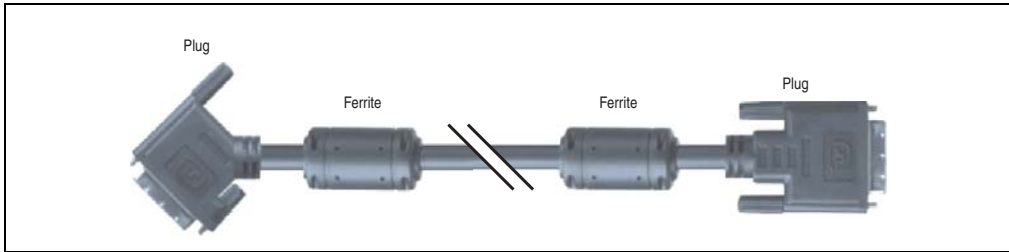

Figure 347: SDL cable with 45° plug (similar)

### Caution!

The SDI cable can only be plugged in and unplugged when the device is turned off.

#### 15.4.1 Order data

Model number	Description	Note
5CASDL.0018-01	<b>SDL cable 1.8 m 45°</b> SDL cable for fixed type of layout with one-sided 45° plug; length: 1.8 m	
5CASDL.0050-01	<b>SDL cable 5 m 45°</b> SDL cable for fixed type of layout with one-sided 45° plug; length: 5 m	
5CASDL.0100-01	<b>SDL cable 10 m 45°</b> SDL cable for fixed type of layout with one-sided 45° plug; length: 10 m	
5CASDL.0150-01	<b>SDL cable 15 m 45°</b> SDL cable for fixed type of layout with one-sided 45° plug; length: 15 m	

Table 436: Model numbers - SDL cables with 45° plug

### 15.4.2 Technical data

Features	5CASDL.0018-01	5CASDL.0050-01	5CASDL.0100-01	5CASDL.0150-01
Length Tolerance	1.8 m ±50 mm	5 m ±80 mm	10 m ±100 mm	15 m ±120 mm
Cable diameter Maximum	9 mm		11.5 mm	
Shielding	Individual cable pairs and entire cable			
Connector type Connection cycles	2x DVI-D (24+1), male 100			
Wire cross section	AWG 28		AWG 24	
Line resistance	Max. 237 Ω/km		Max. 93 Ω/km	
Insulation resistance	Min. 10 MΩ/km			
Flexibility	Limited flexibility; valid for ferrite magnet - ferrite magnet (tested 100 cycles with 5x cable diameter, 20 cycles / minute)			
Halogen-free	No			
Flex radius Fixed layout	See figure "Flex radius specification", on page 700 5x cable diameter (plug - ferrite magnet and ferrite magnet - ferrite magnet)			
Weight	Approx. 300 g	Approx. 590 g	Approx. 2100 g	Approx. 3000 g

Table 437: Technical data - SDL cable with 45° plug 5CASDL.0xxx-01

### 15.4.3 Flex radius specification

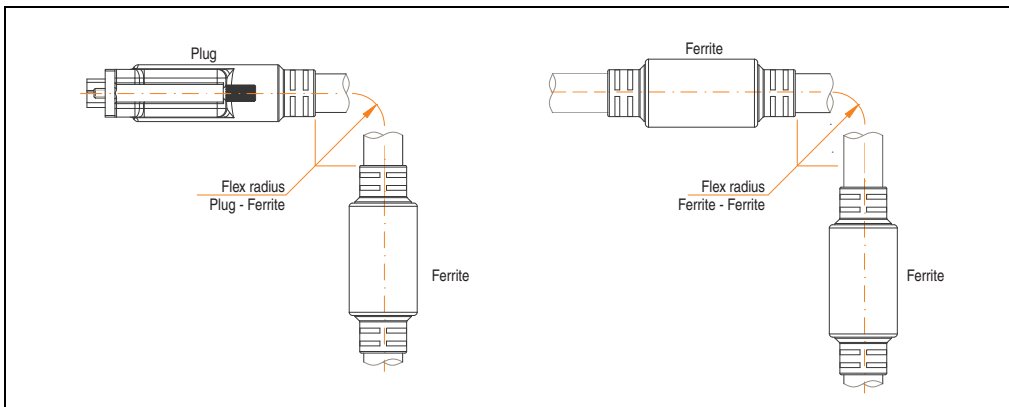

Figure 348: Flex radius specification

### 15.4.4 Cable specifications

The following figure shows the pin assignments for the SDL cable available at B&R. If you want to build a suitable cable yourself, it should be wired according to these specifications.

## Warning!

If a self-built cable is used, B&R cannot guarantee that it will function properly.

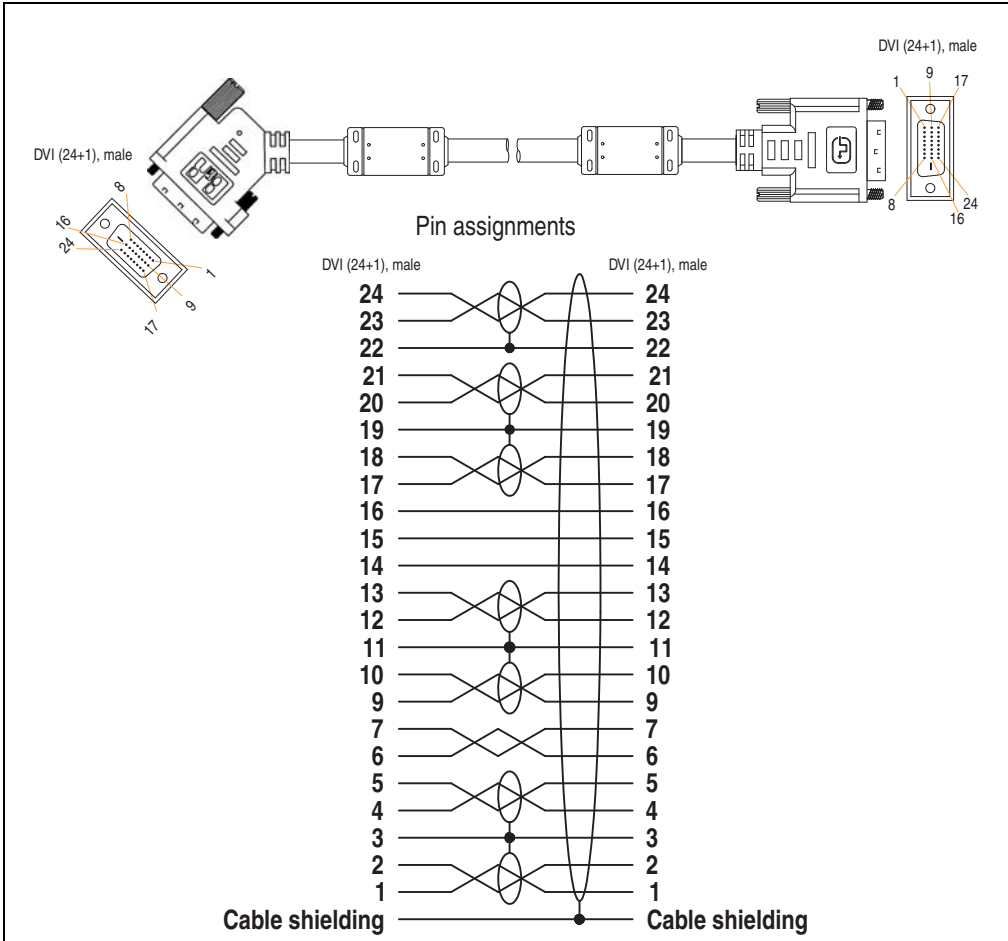

Figure 349: Pin assignments - SDL cable with 45° plug 5CASDL.0xxx-01

### 15.5 SDL cable with extender 5CASDL.0x00-10

The SDL cables (with extender) 5CASDL.0xxx-10 are designed for fixed layout. Use of the SDL flex cable (with extender) 5CASDL.0x00-13 is required for a flexible installation (e.g. in swing arm systems).

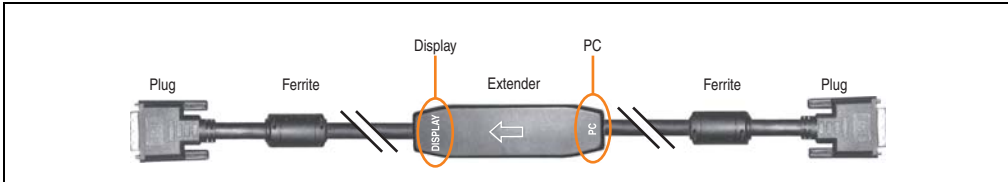

Figure 350: SDL cable with extender (similar)

## Caution!

**SDL cables with extender can only be plugged in and unplugged when the device is turned off. The correct direction of connection (Display, PC) for the wiring is illustrated on the middle of the extender.**

#### 15.5.1 Order data

Model number	Description	Note
5CASDL.0300-10	<b>30 m SDL cable with extender</b> SDL cable with extender for a fixed type of layout; length 30 m	Cancelled since 12/2006 Replaced by 5CASDL.0300-13
5CASDL.0400-10	<b>40 m SDL cable with extender</b> SDL cable with extender for a fixed type of layout; length 40 m	Cancelled since 12/2006 Replaced by 5CASDL.0400-13

Table 438: Model numbers - SDL cable with extender

15.5.2 Technical data

Features	5CASDL.0300-10	5CASDL.0400-10
Length Tolerance	30 m ±200 mm	40 m ±200 mm
Dimensions - Extender box	Height 18.5 mm, width 35 mm, length 125 mm	
Cable diameter Maximum	11.5 mm	
Shielding	Individual cable pairs and entire cable	
Connector type Connection cycles	2x DVI-D (24+1), male 100	
Wire cross section	AWG 24	
Line resistance	Max. 93 Ω/km	
Insulation resistance	Min. 10 MΩ/km	
Flexibility	Limited flexibility; valid for ferrite magnet - ferrite magnet (tested 100 cycles with 5x cable diameter, 20 cycles / minute)	
Flex radius Fixed layout	See figure "Flex radius specification", on page 703 5 x cable diameter (of plug - ferrite magnet and ferrite magnet - extender)	
Weight	Approx. 6100 g	Approx. 8100 g

Table 439: Technical data - SDL cable with extender 5CASDL.0x00-10

15.5.3 Flex radius specification

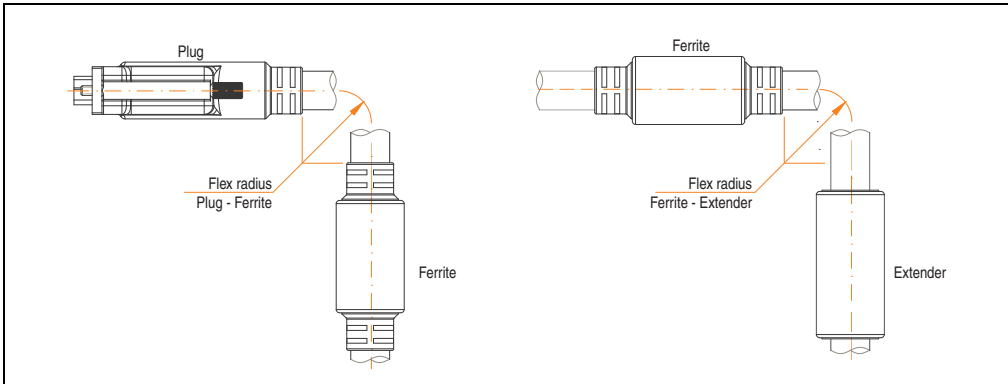

Figure 351: Flex radius specification

### 15.5.4 Cable connection

The SDL cable with extender must be connected between the Automation PC 620 and Automation Panel 900 display unit in the correct direction. The correct signal direction is indicated on the extender unit for this purpose:

- Connect the end labeled "PC" with the video output of the Automation PC 620.
- The "Display" end should be connected to the display unit Automation Panel 900.

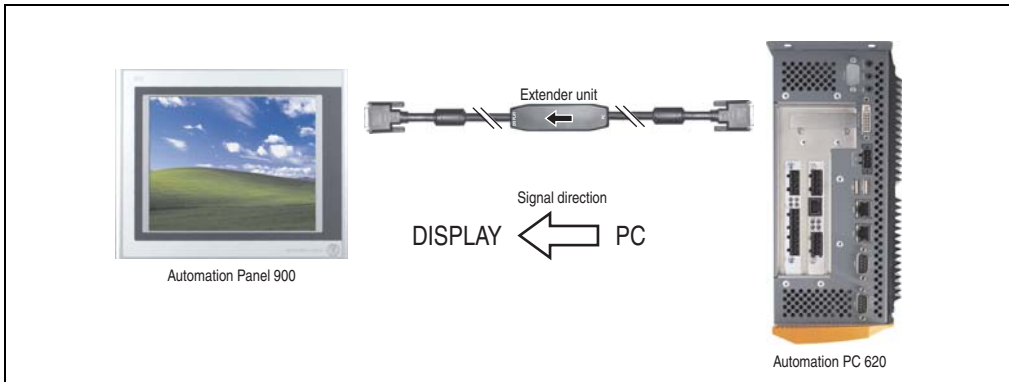

Figure 352: Example of the signal direction for the SDL cable with extender



### 15.5.5 Cable specifications

The following figure shows the pin assignments for the SDL cable with extender available at B&R.

#### Information:

Only B&R SDL cables with extender can be used.

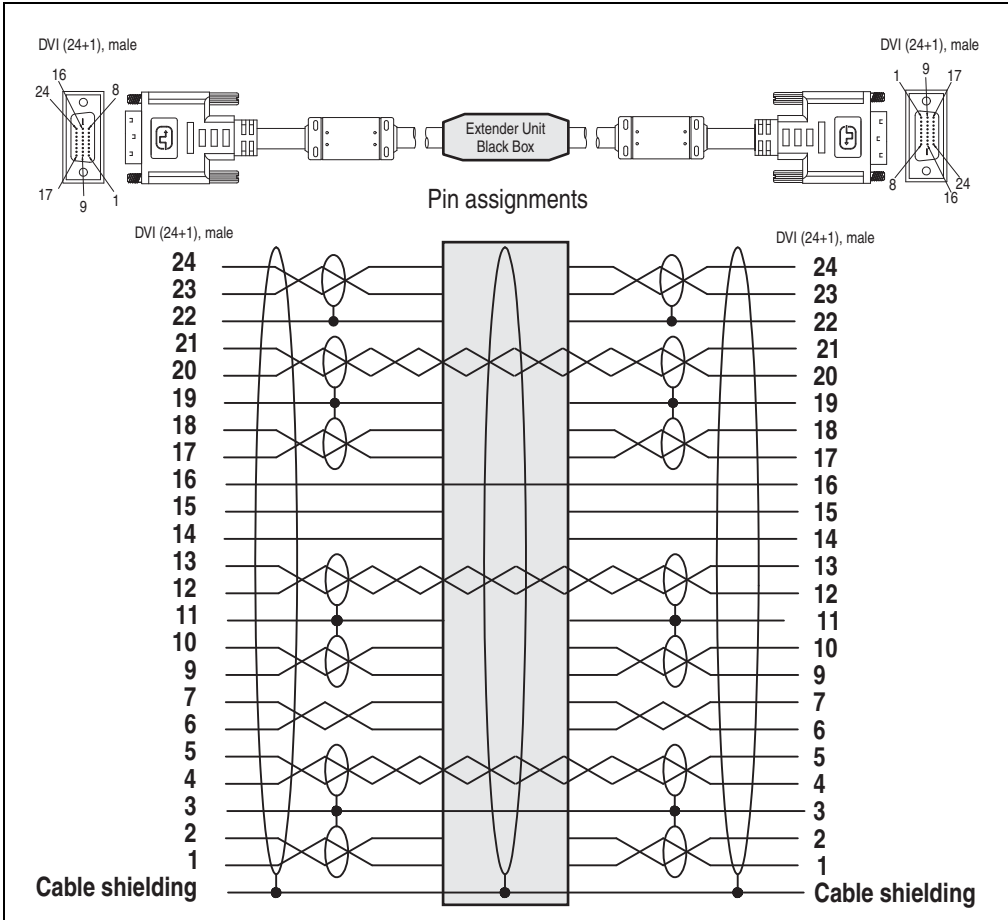

Figure 353: Pin assignments - SDL cable with extender 5CASDL.0x00-10

## 15.6 SDL flex cable 5CASDL.0xxx-03

The SDL flex cables 5CASDL.0xxx-03 are designed for both fixed and flexible installations (e.g. in swing arm systems).

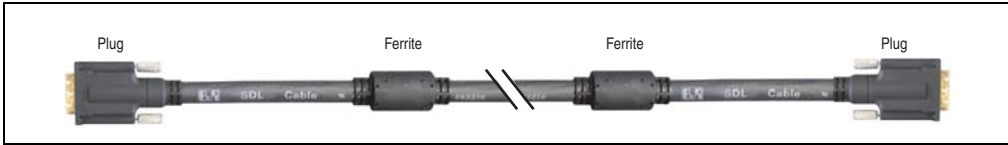

Figure 354: SDL cable 5CASDL.0xxx-03 (similar)

### Caution!

The SDI cable can only be plugged in and unplugged when the device is turned off.

#### 15.6.1 Order data

Model number	Description	Note
5CASDL.0018-03	<b>1.8 m flex SDL cable</b> SDL cable for fixed and flexible type of layout; length: 1.8 m	
5CASDL.0050-03	<b>5 m flex SDL cable</b> SDL cable for fixed and flexible type of layout; length: 5 m	
5CASDL.0100-03	<b>10 m flex SDL cable</b> SDL cable for fixed and flexible type of layout; length: 10 m	
5CASDL.0150-03	<b>15 m flex SDL cable</b> SDL cable for fixed and flexible type of layout; length: 15 m	
5CASDL.0200-03	<b>20 m flex SDL cable</b> SDL cable for fixed and flexible type of layout; length: 20 m	
5CASDL.0250-03	<b>25 m flex SDL cable</b> SDL cable for fixed and flexible type of layout; length: 25 m	
5CASDL.0300-03	<b>30 m flex SDL cable</b> SDL cable for fixed and flexible type of layout; length: 30 m	

Table 440: Model numbers - SDL cable 5CASDL.0xxx-03

15.6.2 Technical data

Mechanical characteristics	5CASDL.0018-03	5CASDL.0050-03	5CASDL.0100-03	5CASDL.0150-03	5CASDL.0200-03	5CASDL.0250-03	5CASDL.0300-03
Length Tolerance	1.8 m ±20 mm	5 m ±45 mm	10 m ±90 mm	15 m ±135 mm	20 m ±180 mm	25 m ±225 mm	30 m ±270 mm
Cable diameter Maximum	12 mm						
Shielding	Individual cable pairs and entire cable						
Connector type Connection cycles Contacts Mechanical protection	2x DVI-D (24+1), male Min. 200 Gold plated Metal cover with crimped stress relief						
Max. tension During installation During operation	≤ 400 N ≤ 50 N						
Materials Cable shield Color	RoHS compliant Aluminum foil clad + tinned copper mesh Black (similar to RAL 9005)						
Flexibility	Flexible; valid for ferrite magnet - ferrite magnet (tested 300,000 cycles with 15x cable diameter, 4800 cycles / hour)						
Halogen-free	Yes						
Flex radius Fixed layout  flexible installation	See figure "Flex radius specification", on page 708 6x cable diameter (of plug - ferrite magnet) 10x cable diameter (of ferrite magnet - ferrite magnet) 15x cable diameter (of ferrite magnet - ferrite magnet)						
Weight	Approx. 450 g	Approx. 1000 g	Approx. 2000 g	Approx. 3000 g	Approx. 4000 g	Approx. 5000 g	Approx. 6000 g
<b>Electrical properties (at 20°C)</b>							
Wire cross section	24 AWG (control wires) 26 AWG (DVI, USB, data)						
Line resistance 24 AWG 26 AWG	≤ 95 Ω/km ≤ 145 Ω/km						
Insulation resistance	> 200 MΩ/km						
Wave impedance	100 ±10 Ω						
Test voltage Wire / wire Wire / shield	1 kV <sub>eff</sub> 0.5 kV <sub>eff</sub>						
Operating voltage	≤ 30 V						
<b>Environmental characteristics</b>							
Temperature resistance Fixed installation Moving Bearings	-20 to 80°C -5 to 60°C -20 to 80°C						
Fire resistance	Fire resistant according to UL758 (cable vertical flame test)						

Table 441: Technical data - SDL cable 5CASDL.0xxx-03

## Accessories • Cables

Standards and certifications	5CASDL.0018-03	5CASDL.0050-03	5CASDL.0100-03	5CASDL.0150-03	5CASDL.0200-03	5CASDL.0250-03	5CASDL.0300-03
Torsion load	100,000 cycles (tested angle of rotation: $\pm 85^\circ$ speed: 50 cycles / minute)						
Cable drag chain	300,000 cycles Tested flex radius: 180 mm; 15x cable diameter; hub: 460 mm; speed: 4800 cycles / hour						
Approbation	UL AWM 20236 80°C 30 V						
Oil and hydrolysis resistance	According to VDE 0282-10						

Table 441: Technical data - SDL cable 5CASDL.0xxx-03 (Forts.)

### 15.6.3 Flex radius specification

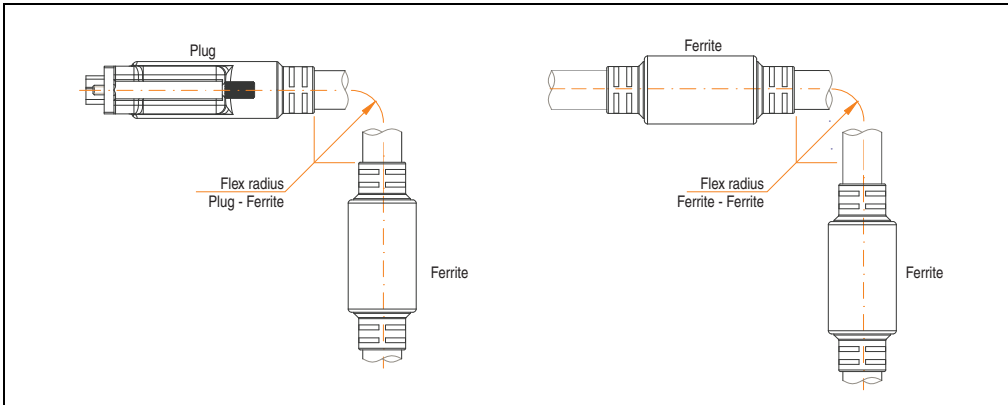

Figure 355: Flex radius specification

### 15.6.4 Dimensions

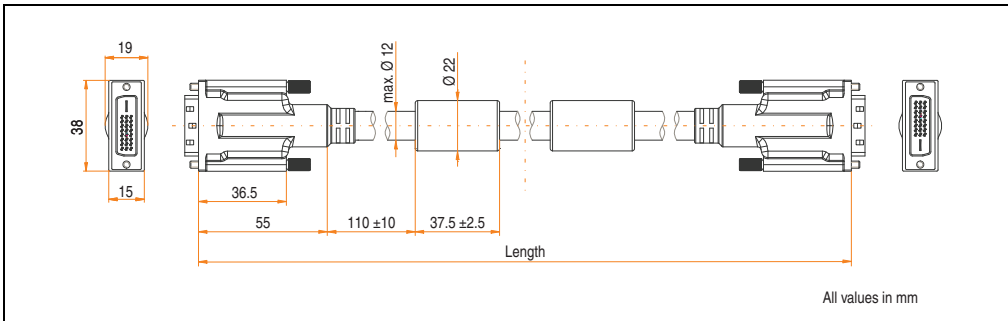

Figure 356: Dimensions - SDL cable 5CASDL.0xxx-03

15.6.5 Structure

Element	Assignment	Cross section	
DVI	TMDS data 0	26 AWG	<p>Schematic display</p>
	TMDS data 1	26 AWG	
	TMDS data 2	26 AWG	
	TMDS cycle	26 AWG	
USB	XUSB0	26 AWG	
	XUSB1	26 AWG	
Data	SDL	26 AWG	
Control wires	DDC cycle	24 AWG	
	DDC data	24 AWG	
	+ 5 V	24 AWG	
	mass	24 AWG	
	Hot Plug detect	24 AWG	

Table 442: Structure - SDL cable 5CASDL.0xxx-03

### 15.6.6 Cable specifications

The following figure shows the pin assignments for the SDL cable available at B&R. If you want to build a suitable cable yourself, it should be wired according to these specifications.

## Warning!

If a self-built cable is used, B&R cannot guarantee that it will function properly.

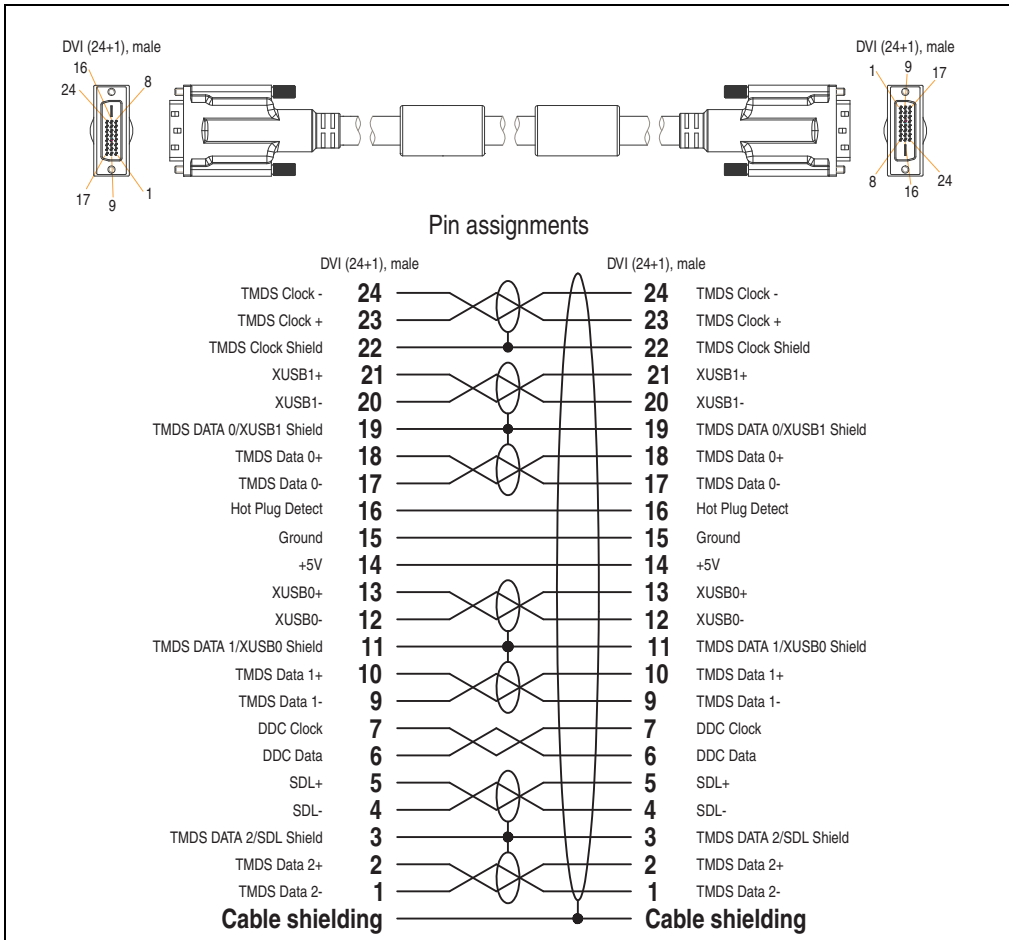

Figure 357: Pin assignments - SDL cable 5CASDL.0xxx-03

## 15.7 SDL flex cable with extender 5CASDL.0x00-13

The SDL flex cables (with extender) 5CASDL.0x00-13 are designed for both fixed and flexible installations (e.g. in swing arm systems).

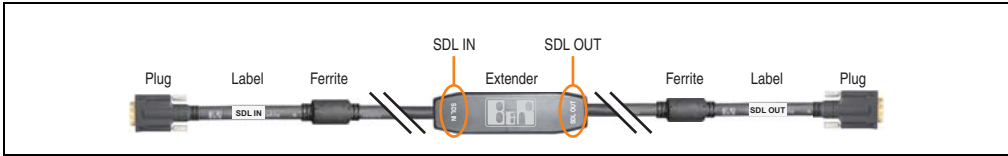

Figure 358: SDL flex cable with extender - 5CASDL.0x00-13 (similar)

### Caution!

**SDL cables with extender can only be plugged in and unplugged when the device is turned off. The correct direction of connection (SDL IN, SDL OUT) for the wiring is illustrated on the middle of the extender and between the ferrite magnet and plug (with a sticker).**

#### 15.7.1 Order data

Model number	Description	Note
5CASDL.0300-13	<b>30 m SDL flex cable with extender</b> SDL cable with extender for fixed and flexible type of layout; length: 30 m	
5CASDL.0400-13	<b>40 m SDL flex cable with extender</b> SDL cable with extender for fixed and flexible type of layout; length: 40 m	

Table 443: Model numbers - SDL flex cable with extender

**15.7.2 Technical data**

Features	5CASDL.0300-13	5CASDL.0400-13
Length Tolerance	30 m ±200 mm	40 m ±200 mm
Dimensions - Extender box	Height 18.5 mm, width 35 mm, length 125 mm	
Cable diameter Maximum	12 mm	
Shielding	Individual cable pairs and entire cable	
Connector type Connection cycles Contacts Mechanical protection	2x DVI-D (24+1), male Min. 200 Gold plated Metal cover with crimped stress relief	
Max. tension During installation During operation	≤ 400 N ≤ 50 N	
Materials Cable shield Color	RoHS compliant Aluminum foil clad + tinned copper mesh Black (similar to RAL 9005)	
Flexibility	Flexible; valid for ferrite magnet - ferrite magnet (tested 300,000 cycles with 15x cable diameter, 4800 cycles / hour)	
Halogen-free	Yes	
Flex radius Fixed layout  flexible installation	See figure "Flex radius specification", on page 713 6x cable diameter (of plug - ferrite magnet) 10x cable diameter (of ferrite magnet - extender) 15x cable diameter (of ferrite magnet - ferrite magnet)	
Weight	Approx. 6200 g	Approx. 8000 g
<b>Electrical properties (at 20°C)</b>		
Wire cross section	24 AWG (control wires) 26 AWG (DVI, USB, data)	
Line resistance 24 AWG 26 AWG	≤ 95 Ω/km ≤ 145 Ω/km	
Insulation resistance	> 200 MΩ/km	
Wave impedance	100 ±10 Ω	
Test voltage Wire / wire Wire / shield	1 kV <sub>eff</sub> 0.5 kV <sub>eff</sub>	
Operating voltage	≤ 30 V	
<b>Environmental characteristics</b>		
Temperature resistance Fixed installation Moving Bearings	-20 to 60°C -5 to 60°C -20 to 60°C	
Fire resistance	Fire resistant according to UL758 (cable vertical flame test)	

Table 444: Technical data - SDL flex cable with extender 5CASDL.0x00-13



Standards and certifications	5CASDL.0300-13	5CASDL.0400-13
Torsion load	100,000 cycles (tested angle of rotation: $\pm 85^\circ$ speed: 50 cycles / minute)	
Cable drag chain	300,000 cycles Tested flex radius: 180 mm; 15x cable diameter; hub: 460 mm; speed: 4800 cycles / hour	
Approbation	UL AWM 20236 80°C 30 V	
Oil and hydrolysis resistance	According to VDE 0282-10	

Table 444: Technical data - SDL flex cable with extender 5CASDL.0x00-13 (Forts.)

### 15.7.3 Flex radius specification

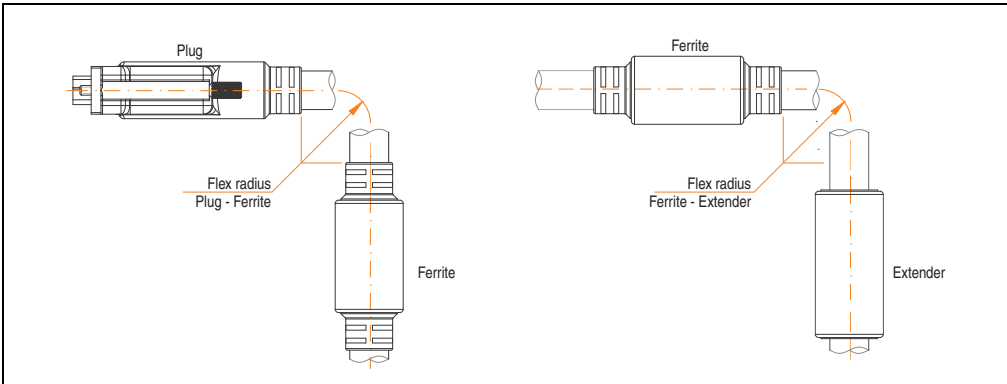

Figure 359: Flex radius specification

### 15.7.4 Dimensions

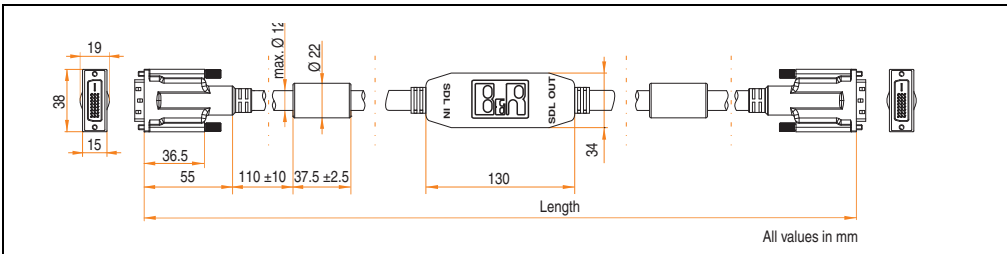

Figure 360: Dimensions - SDL flex cable with extender 5CASDL.0x00-13

### 15.7.5 Cable connection

The SDL flex cable with extender must be connected between the Industrial PC and Automation Panel 900 display unit in the correct direction. The signal direction is indicated on the extender unit for this purpose:

- Connect the end labeled "SDL IN" with the video output of the Automation PC 620 or Panel PC 700 (monitor/panel output) or Panel OUT of an AP900 AP Link card.
- The "SDL OUT" end should be connected to the display unit (e.g. Automation Panel 900) via the Automation Panel Link insert card (Panel IN).

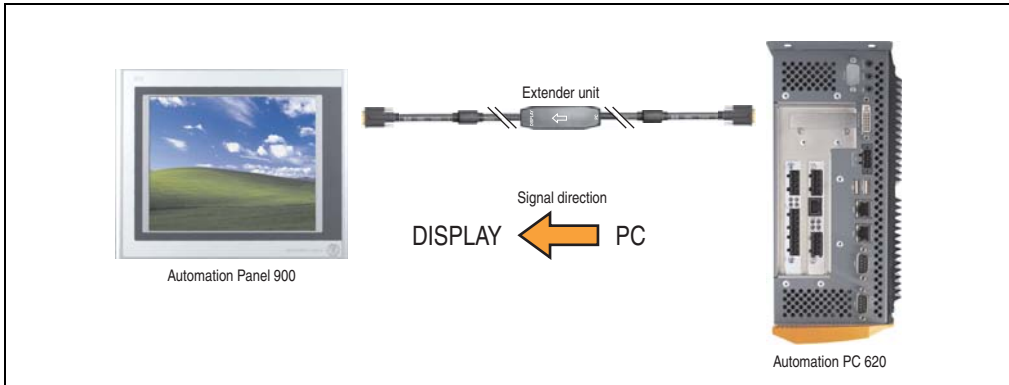

Figure 361: Example of the signal direction for the SDL flex cable with extender - APC620

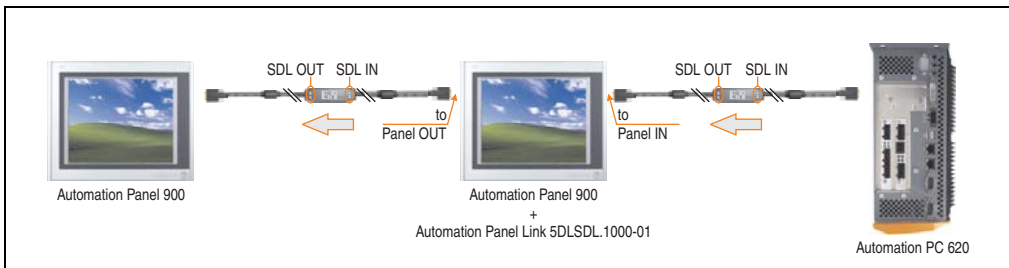

Figure 362: Example of signal direction display - SDL flex cable with extender

### 15.7.6 Cable specifications

The following figure shows the pin assignments for the SDL flex cable with extender available at B&R.

#### Information:

Only B&R SDL flex cables with extender can be used.

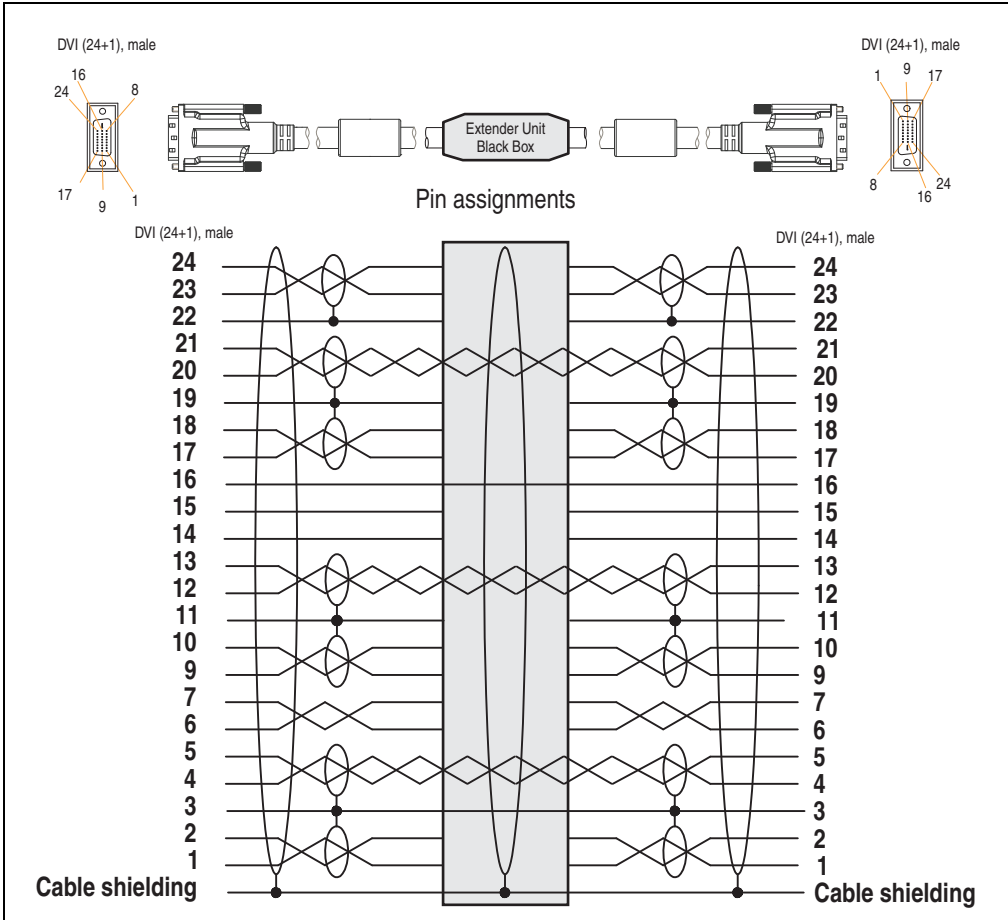

Figure 363: Pin assignments - SDL flex cable with extender 5CASDL.0x00-13

## 15.8 RS232 cable 9A0014-xx

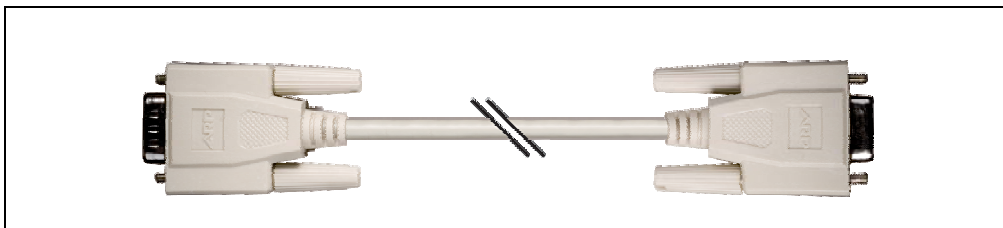

Figure 364: RS232 extension cable (similar)

### 15.8.1 Order data

Model number	Description	Note
9A0014.02	<b>RS232 cable DB9/f:DB9/m 1.8 m</b> RS232 extension cable for remote operation of a display unit with touch screen, length 1.8 m.	
9A0014.05	<b>RS232 cable DB9/f:DB9/m 5 m</b> RS232 extension cable for remote operation of a display unit with touch screen, length 5 m.	
9A0014.10	<b>RS232 cable DB9/f:DB9/m 10 m</b> RS232 extension cable for remote operation of a display unit with touch screen, length 10 m.	

Table 445: Model numbers - RS232 cables

### 15.8.2 Technical data

Features	9A0014.02	9A0014.05	9A0014.10
Length	1.8 m	5 m	10 m
Tolerance	±50 mm	±80 mm	±100 mm
Outer diameter	Max. 5 mm		
Shielding	Entire cable		
Connector type	DSUB (9-pin), male / female		
Wire cross section	AWG 26		
Flexibility	Flexible		
Flex radius	Min. 70 mm		

Table 446: Technical data - RS232 cables

### 15.8.3 Cable specifications

The following figure shows the pin assignments for the RS232 cable available at B&R. If you want to build a suitable cable yourself, it should be wired according to these specifications.

## Warning!

If a self-built cable is used, B&R cannot guarantee that it will function properly.

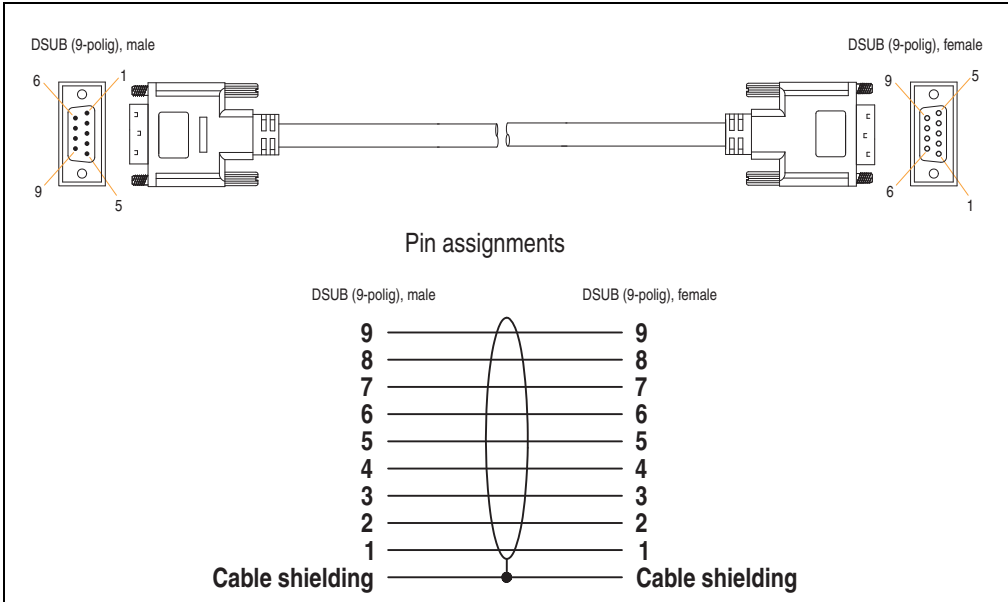

Figure 365: Pin assignments - RS232 cable

## 15.9 USB cable 5CAUSB.00xx-00



Figure 366: USB extension cable (similar)

### 15.9.1 Order data

Model number	Description	Note
5CAUSB.0018-00	<b>USB 2.0 cable, A/m:B/m 1.8 m</b> USB 2.0 connection cable; plug type A - type B; length 1.8 m	
5CAUSB.0050-00	<b>USB 2.0 cable, A/m:B/m 5 m</b> USB 2.0 connection cable; plug type A - type B; length 5 m	

Table 447: Model numbers - USB cables

### 15.9.2 Technical data

Features	5CAUSB.0018-00	5CAUSB.0050-00
Length Tolerance	1.8 m ±30 mm	5 m ±50 mm
Outer diameter	Max. 5 mm	
Shielding	Entire cable	
Connector type	USB type A male and USB type B male	
Wire cross section	AWG 24, 28	
Flexibility	Flexible	
Flex radius	Min. 100 mm	

Table 448: Technical data - USB cables

### 15.9.3 Cable specifications

The following figure shows the pin assignments for the USB cable available at B&R. If you want to build a suitable cable yourself, it should be wired according to these specifications.

## Warning!

If a self-built cable is used, B&R cannot guarantee that it will function properly.

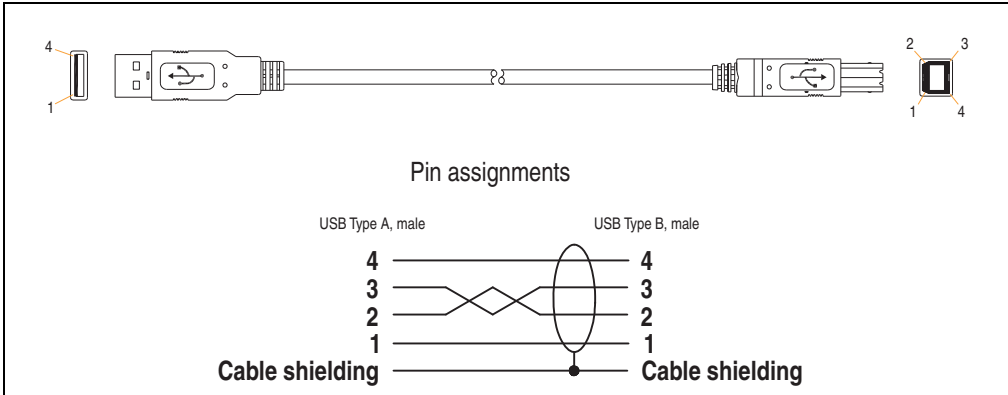

Figure 367: Pin assignments - USB cable

## 16. Uninterruptible power supply

With the optionally integrated UPS, the Automation PC 620 makes sure that the PC system completes write operations even after a power failure occurs. When the UPS detects a power failure, it switches to battery operation immediately without interruption. This means that all running programs will be ended properly by the UPS software. This prevents the possibility of inconsistent data (only functions if the UPC is already configured and the driver is activated).

### Information:

More detailed information about uninterruptible power supplies can be found in the UPS users manual (of the external UPS 24 VDC). This can be downloaded from the B&R homepage.

### Information:

The monitor is not buffered by the UPS and will shut off when the power fails.

By integrating the charging circuit in the Automation PC 620 housing, the installation has been reduced to merely attaching the connection cable to the battery unit mounted next to the PC.

Special emphasis was placed on ease of maintenance when the battery unit was designed. The batteries are easily accessible from the front and can be switched in just a few moments when servicing.

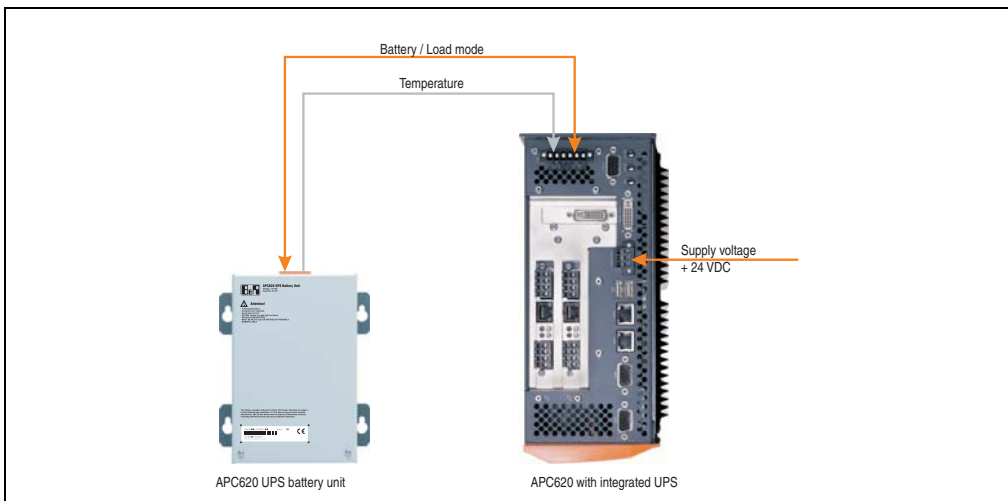

Figure 368: UPS principle



## 16.1 Order data

Model number	Description	Note
5AC600.UPSI-00	<b>Add-on UPS module</b> Order UPS module for Automation PC, cable (5CAUPS.0005-00 or 5CAUPS.0030-00) and battery unit (5AC600.UPSB-00) separately.	
5AC600.UPSB-00	<b>5Ah battery unit</b> UPS battery unit for the add-on UPS module	
5CAUPS.0005-00	<b>0.5 meter UPS cable</b> Connection cable between add-on UPS module and UPS battery unit, length 0.5 meters	
5CAUPS.0030-00	<b>3 meter UPS cable</b> Connection cable between add-on UPS module and UPS battery unit, length 3 meters	

Table 449: Order data - Uninterruptible power supply

## 16.2 Features

- Long-lasting, maintenance-free rechargeable batteries
- Communication via integrated interfaces
- Temperature sensor
- Driver software
- Deep discharge protection

## 16.3 Requirements

- 1) An appropriate system unit.

The add-on UPS module (5AC600.UPSI-00) can only be installed with the following APC620 system unit revisions:

System unit	Revision
5PC600.SX01-00	Starting with revision H0
5PC600.SX02-00	Starting with revision G0
5PC600.SX02-01	Starting with revision H0
5PC600.SX05-00	Starting with F0
5PC600.SX05-01	Starting with F0
5PC600.SF03-00	Starting with revision A0
5PC600.SE00-00	Starting with revision A0
5PC600.SE00-01	Starting with revision A0
5PC600.SE00-02	Starting with revision A0
5PC810.SX*.	Starting with revision A0

Table 450: System unit revisions - Add-on UPS module

## Accessories • Uninterruptible power supply

### 2) Add-on UPS module 5AC600.UPSI-00

For more on installing the add-on modules, see chapter 7 "Maintenance / Servicing", section 5 "Installing the UPS module", on page 765.

### 3) Battery unit 5AC600.UPSB-00

### 4) UPS connection cable 0.5 m (5CAUPS.0005-00) or 3 m (5CAUPS.0030-00)

### 5) APC620 firmware versions:

To read the status or make changes to the settings of the APC620 add-on UPS (5AC600.UPSI-00) and the APC620 battery unit (5AC600.UPSB-00), the following software components are necessary:

Software name	Type	Version
MTCX PX32 <sup>1)</sup>	Firmware	1.61 or higher
MTCX FPGA <sup>1)</sup>	Firmware	1.18 or higher
ADI Control Center <sup>1)</sup>	Driver / Control Center	1.60 or higher

Table 451: Firmware and software required for the UPS

1) The software can be downloaded from the B&R homepage ([www.br-automation.com](http://www.br-automation.com)).

For info regarding upgrading the firmware, see chapter 4 "Software", section 2.2 "Upgrade the firmware", on page 555.

The APC620 firmware version can be read in BIOS under the main menu item "Advanced", submenu item "Baseboard/Panel Features", or in the B&R Control Center.

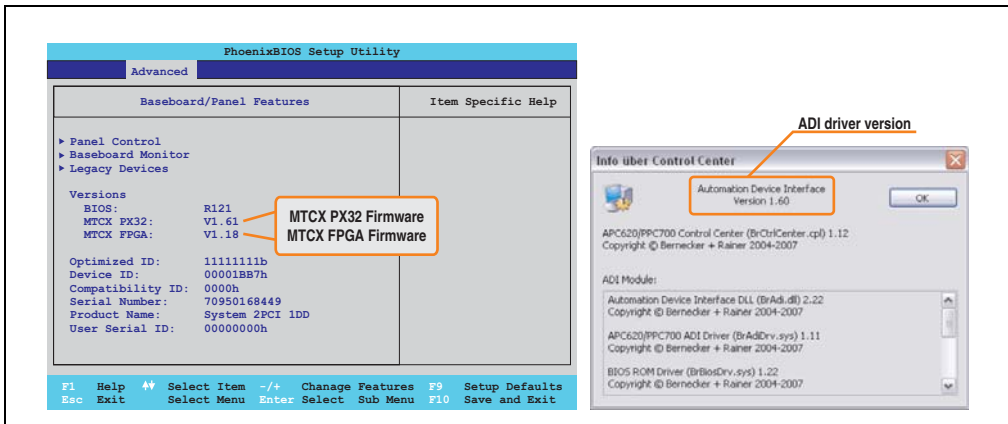

Figure 369: Firmware and software required for the UPS

The required firmware versions can be found in the APC620 / Panel PC firmware upgrade (MTCX, SDLR, SDLT) V1.16<sup>1)</sup>.

1) The software can be downloaded from the B&R homepage ([www.br-automation.com](http://www.br-automation.com)).

- 6) To configure: Automation Device Interface driver version 1.60 or higher (for the ADI Control Center)

For info regarding configuration of the B&R UPS using the ADI Control Center, see chapter 4 "Software", section 9.4 "UPS configuration", on page 599.

## 16.4 Individual components

### 16.4.1 Add-on UPS module 5AC600.UPSI-00

The add-on UPS module can easily be installed in an appropriate APC620 system unit (List of required revisions: see section "Requirements", on page 721).

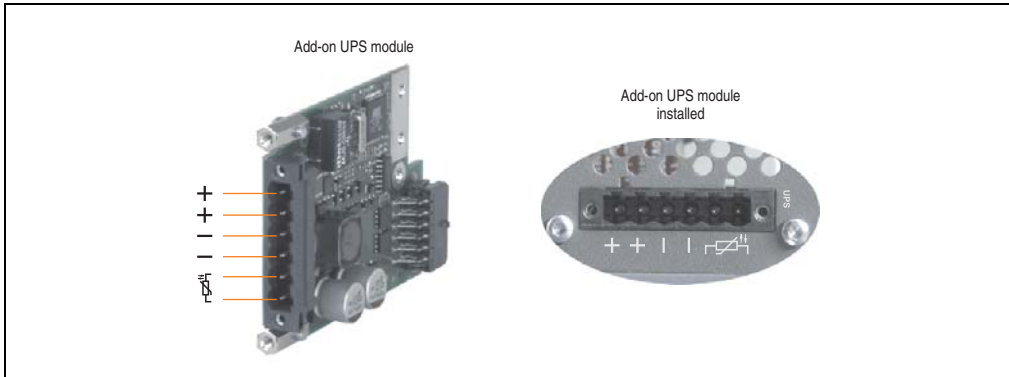

Figure 370: Add-on UPS module 5AC600.UPSI-00

### Technical data

Features	5AC600.UPSI-00
Switching threshold mains / battery operation	15 / 13 V
Mains failure bridging	Max. 20 min at 150 W load
Charging current	Max. 0.5 A
Deep discharge protection	Yes, at 10 V on the battery unit
Short circuit protection	No
Power requirements	Max. 7.5 W
Status indicators	Via the ADI Control Center (see section "UPS configuration", on page 599)
Configuration	Via the ADI Control Center (see section "UPS configuration", on page 599)

Table 452: Technical data - 5AC600.UPSI-00

## Installation

The module is installed using the materials included in the delivery. For installation instructions, see chapter 7 "Maintenance / Servicing", section 5 "Installing the UPS module", on page 765.

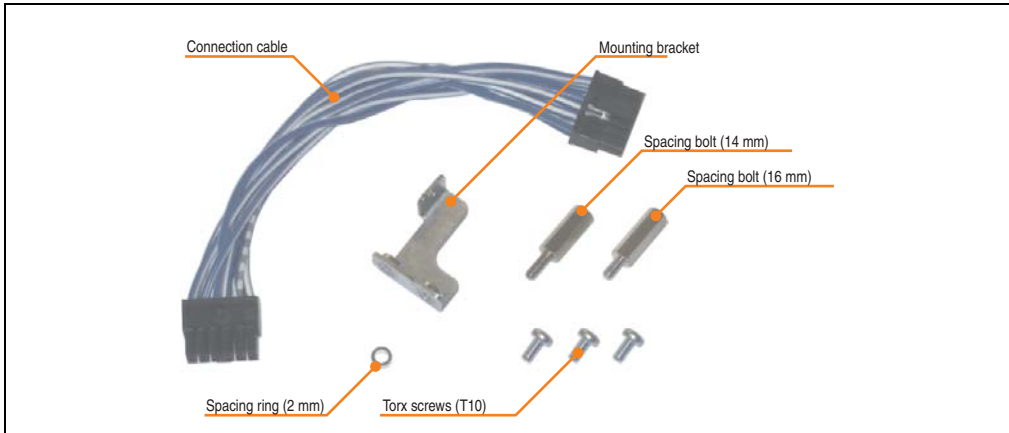

Figure 371: Add-on UPS module 5AC600.UPSI-00 - Installation materials

### 16.4.2 Battery unit 5AC600.UPSB-00

The battery unit is subject to wear and should be replaced regularly (at least following the specified lifespan).

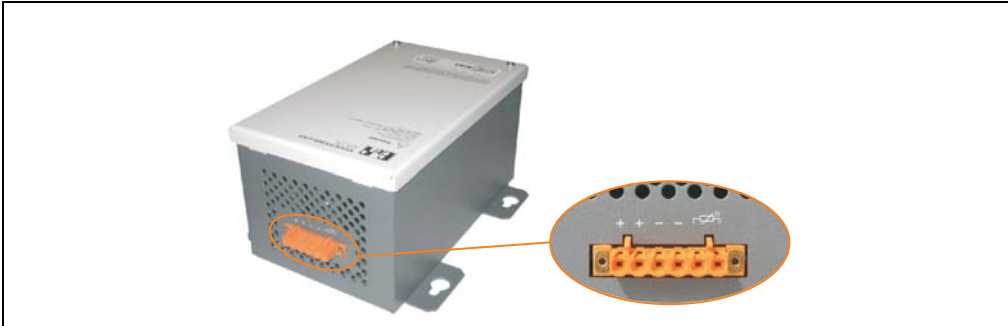

Figure 372: Battery unit 5AC600.UPSB-00

### Technical data

Features	5AC600.UPSB-00 ≤ D0	5AC600.UPSB-00 ≥ E0
Battery Type Method	Energys Cyclon 12 V 5 Ah; (6 connected in series) Single cell (X cell)	
Operating current	Max. 8 A	
Deep discharge voltage	10 V	
Fuse <sup>1)</sup>	No	Yes
Dimensions (W x H x D)	Figure 375 "Dimensions - 5AC600.UPSB-00", on page 728	
Temperature sensor	NTC resistance	
Weight	Approx. 3.2 kg	
Ambient temperature Charging mode Operation Bearings Transport	-30 to 60°C -40 to 80°C -65 to 80°C -65 to 80°C	
Relative humidity Operation Bearings Transport	5 to 95% (non-condensing) 5 to 95% (non-condensing) 5 to 95% (non-condensing)	
Altitude	Max. 3000 meters	
Mounting instructions	See "Mounting instructions", on page 729	
Lifespan	10 years at 25°C (up to 80% battery capacity)	
Maintenance interval during storage	6 month interval between charges	
typ. recharge time at low battery	15 hours	

Table 453: Technical data - 5AC600.UPSB-00

1) The fuse can be installed later in revisions up to and including D0. More information can be found in the "Maintenance and service" chapter of the APC810 and PPC800 user's manuals.

Temperature life span diagram up to 20% battery capacity.

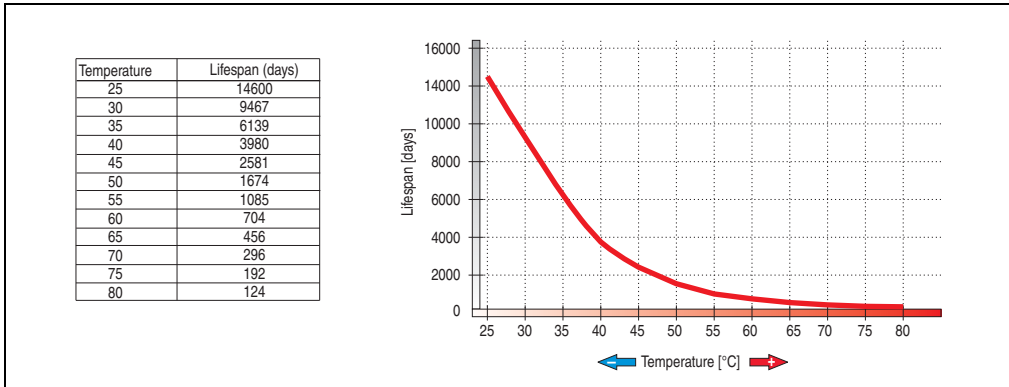

Figure 373: Temperature life span diagram

Deep discharge cycles

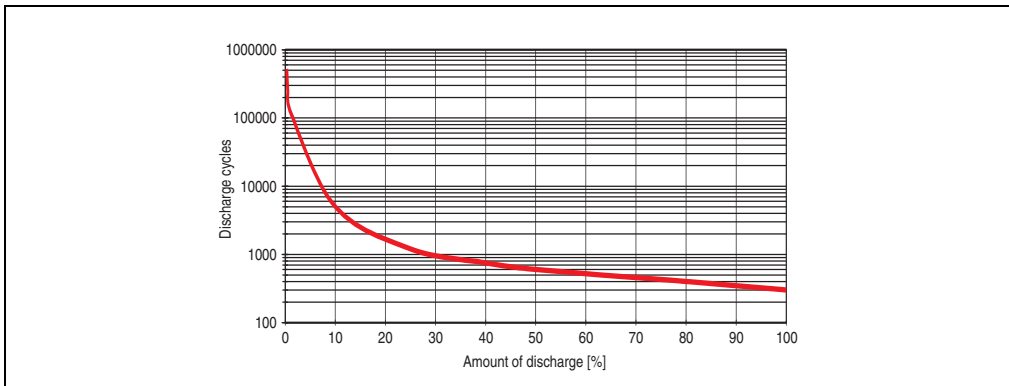

Figure 374: Deep discharge cycles

## Dimensions

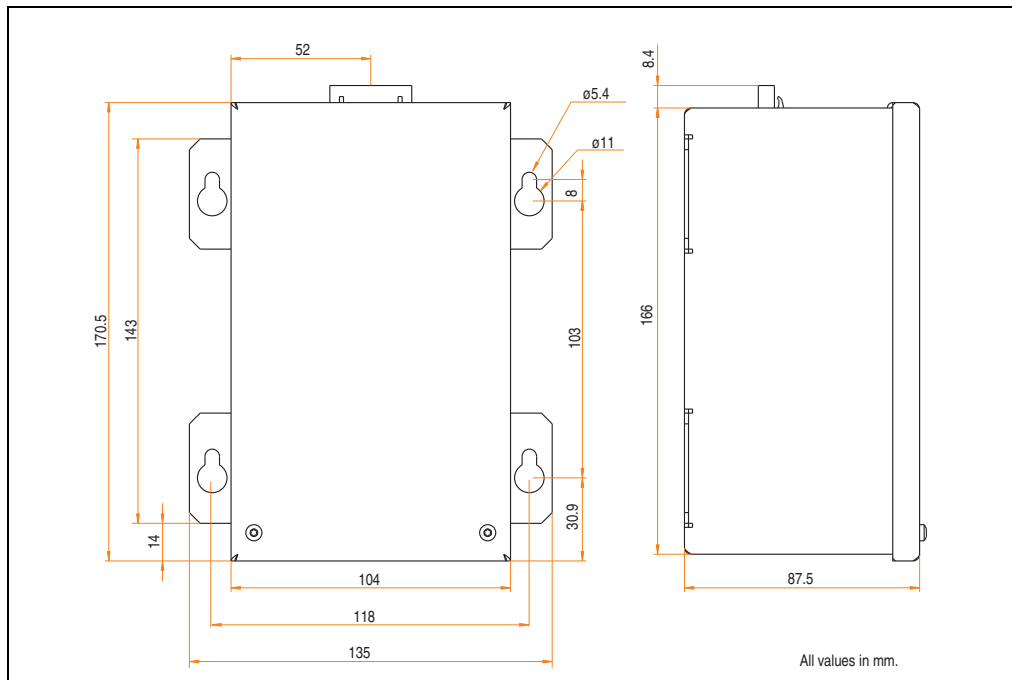

Figure 375: Dimensions - 5AC600.UPSB-00



## Drilling template

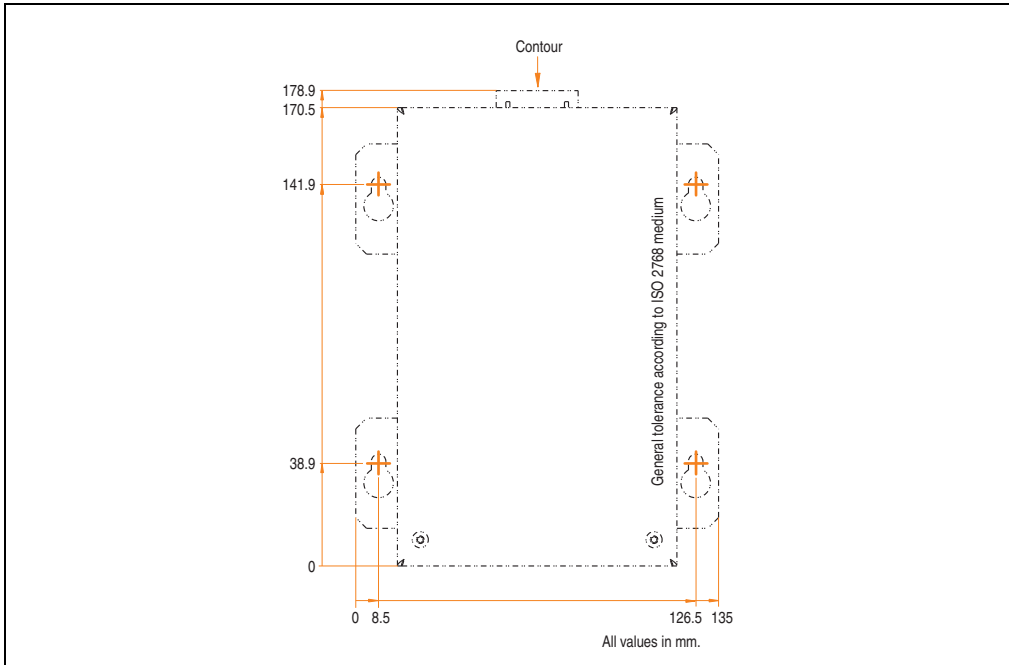

Figure 376: Drilling template for the battery unit

## Mounting instructions

Due to the unique construction of these batteries, they can be stored and operated in any position.

### 16.4.3 UPS connection cable

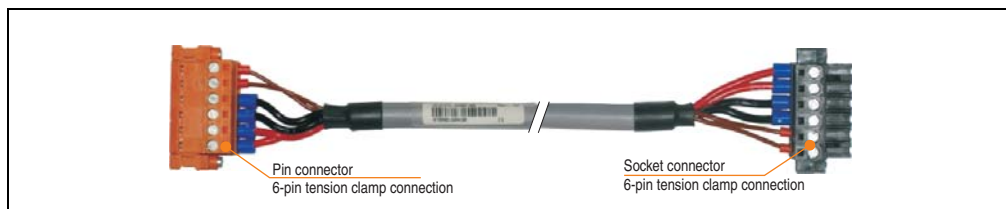

Figure 377: UPS connection cable

### Technical data

Features	5CAUPS.0005-00	5CAUPS.0030-00
Length	0.5 m	3 m
Outer diameter	8.5 mm ±0.2 mm	
Connector type	6-pin plug connectors, tension clamp connection / 6-pin socket connectors, tension clamp connection	
Wire cross section Temperature sensor wire Voltage wire	2 x 0.5 mm <sup>2</sup> (AWG 20) 4 x 2.5 mm <sup>2</sup> (AWG 13)	
Line resistance 0.5 mm <sup>2</sup> 2.5 mm <sup>2</sup>	Max. 39 Ω/km Max. 7.98 Ω/km	
Flex radius Fixed installation Free-moving	5 x wire cross-section 10 x wire cross-section	
Temperature range Moving Non-moving	-5 to 80°C -30 to 80°C	
Weight	Approx. 143 kg/km	
Materials Cable shield Color	Thermoplastic PVC-based material Window gray (similar to RAL 7040)	
Peak operating voltage	12 V DC	
Testing AC voltage Wire / wire	1500 V	
Operating voltage	Max. 300 V	
Current load	10 A at 20°C	

Table 454: Technical data - UPS connection cable

## 17. External UPS

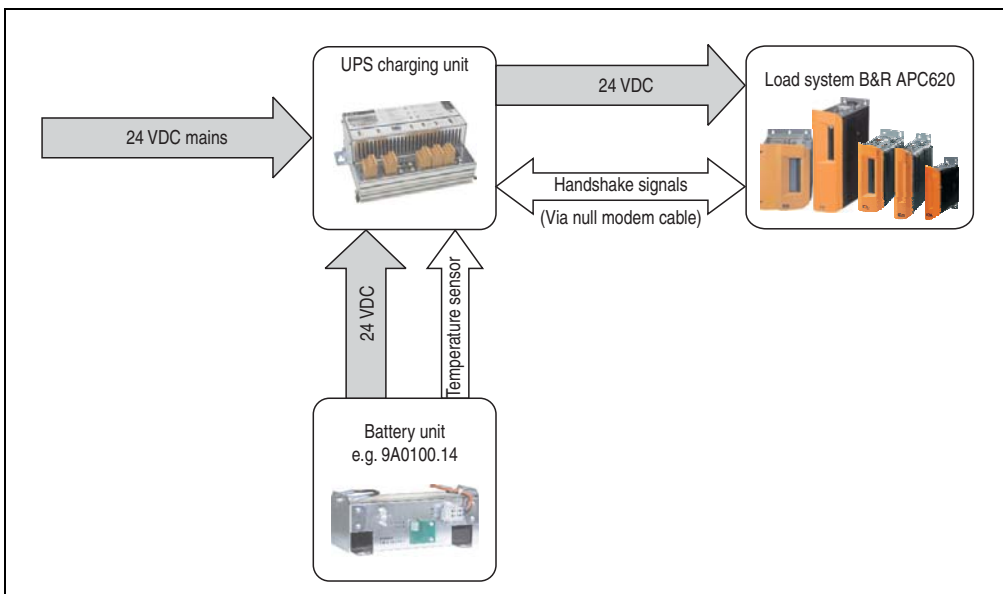

Figure 378: Block diagram of the UPS

### 17.1 General information

For supply with an external UPS, a UPS charging unit, a battery unit and a null modem cable are required.

In normal operation, the 24 VDC supply voltage is put straight through to the load system. If the supply voltage fails, the rechargeable UPS batteries power the PC to allow controlled shutdown without loss of data.

Data and commands are exchanged between the UPS and the load system via the handshake signals for an RS232 interface.

More information concerning an external UPS is available in the "UPS manual", which can be downloaded from the B&R homepage ([www.br-automation.com](http://www.br-automation.com)).

## 17.2 Order data

Model number	Description	Note
9A0100.11	<b>UPS 24 VDC</b> 24 VDC input, 24 VDC output, serial interface	
9A0100.14	<b>UPS battery unit type B</b> 24 V; 2.2 Ah; including battery cage	
9A0100.15	<b>UPS battery unit type B (replacement part)</b> 2 x 12 V; 2.2 Ah; for battery unit 9A0100.14	
9A0017.01	<b>RS232 Null Modem Cable, 0.6 m</b> To connect UPS and load system (9-pin DSUB socket - 9-pin DSUB socket)	
9A0017.02	<b>RS232 Null Modem Cable, 1.8 m</b> To connect UPS and load system (9-pin DSUB socket - 9-pin DSUB socket)	

Table 455: UPS - Order data

## 18. PCI Ethernet cards

### 18.1 PCI Ethernet card 10/100 - 5ACPCI.ETH1-01

The universal (3.3 V and 5 V) half-size PCI Ethernet card has a 10/100 MBit/s network connection and can be inserted in a 16-bit PCI slot and operated as an additional network interface.

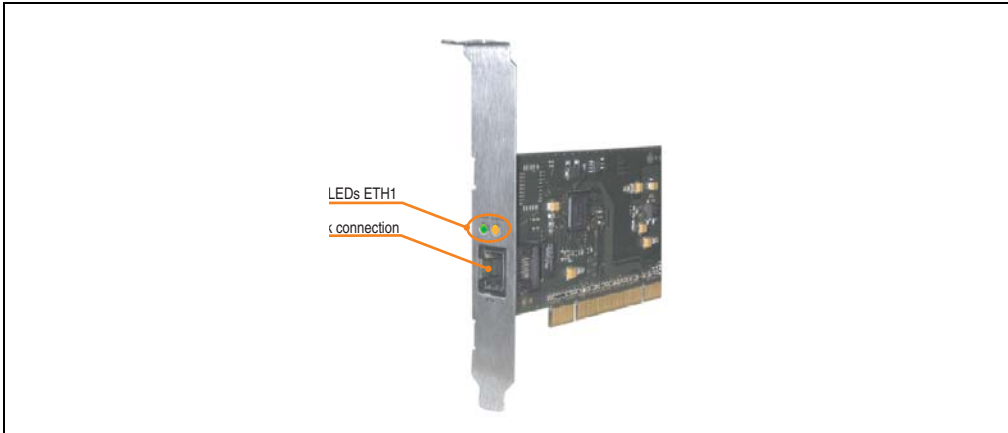

Figure 379: PCI Ethernet card 10/100 - 5ACPCI.ETH1-01

#### 18.1.1 Technical data

Ethernet connection		
Controller	Intel 82551ER	
Power supply	Universal card (2 notches) for 3.3 V or 5 V	
Cabling	S/STP (Cat5e)	
Transfer rate	10/100 MBit/s <sup>1)</sup>	
Cable length	max. 100 m (min. Cat5e)	
LED	On	Off
Green	100 Mbit/s	10 Mbit/s
Orange	Link (Ethernet network connection available)	Activity (blinking) (Data transfer in progress)

RJ45 twisted pair (10BaseT/100BaseT), female

Table 456: Ethernet connection ETH

1) Both operating modes possible. Change-over takes place automatically.

### 18.1.2 Driver support

A special driver is necessary for operating the Intel Ethernet controller 82551ER. Drivers for Windows XP Professional, Windows XP Embedded, and DOS are available for download on the B&R Homepage in the download area ([www.br-automation.com](http://www.br-automation.com)).

## Information:

Required drivers can only be downloaded from the B&R homepage, not from manufacturers' pages.

### 18.1.3 Dimensions

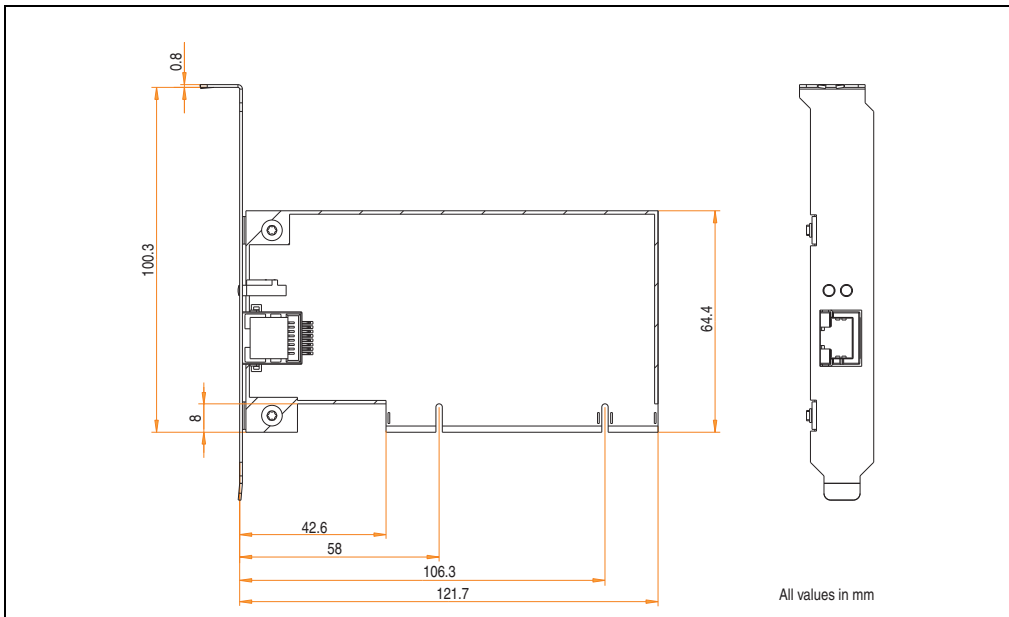

Figure 380: Dimensions - 5ACPCI.ETH1-01

## 18.2 PCI Ethernet card 10/100 - 5ACPCI.ETH3-01

The universal (3.3 V and 5 V) half-size PCI Ethernet card has three 10/100 MBit/s network connections and can be inserted in a 16-bit PCI slot and operated as an additional network interface.

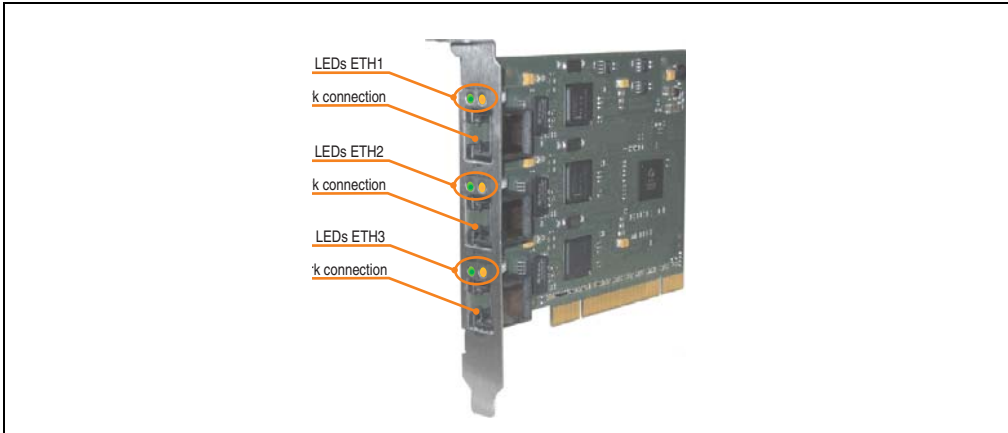

Figure 381: PCI Ethernet card 10/100 - 5ACPCI.ETH3-01

### 18.2.1 Technical data

Ethernet connections		
Controller	each with Intel 82551ER	
Power supply	Universal card (2 notches) for 3.3 V or 5 V	
Cabling	each S/STP (Cat5e)	
Transfer rate	each 10/100 MBit/s <sup>1)</sup>	
Cable length	each max. 100 m (min. Cat5e)	
LED	On	Off
Green	100 Mbit/s	10 Mbit/s
Orange	Link (Ethernet network connection available)	Activity (blinking) (Data transfer in progress)

3 x RJ45 twisted pair (10BaseT/100BaseT), female

Table 457: Ethernet connections ETH1, ETH2, ETH3

1) Both operating modes possible. Change-over takes place automatically.

### 18.2.2 Driver support

A special driver is necessary for operating the Intel Ethernet controller 82551ER. Drivers for Windows XP Professional, Windows XP Embedded, and DOS are available for download on the B&R Homepage in the download area ([www.br-automation.com](http://www.br-automation.com)).

## Information:

Required drivers can only be downloaded from the B&R homepage, not from manufacturers' pages.

### 18.2.3 Dimensions

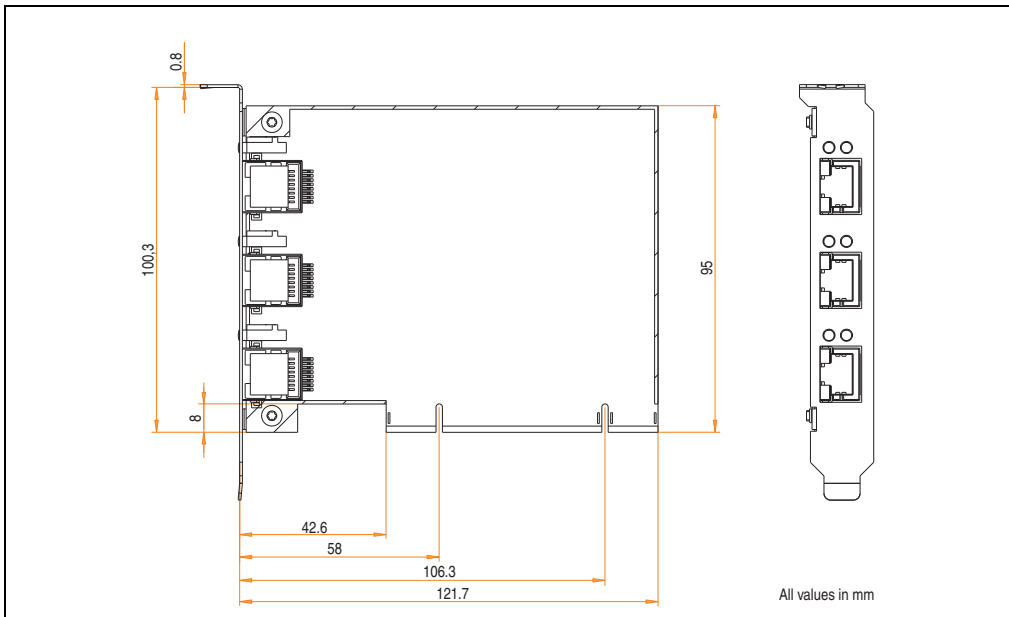

Figure 382: Dimensions - 5ACPCI.ETH3-01



## 19. Replacement fan

### Information:

The fan filters are subject to wear , and should be checked with appropriate frequency to determine whether the air flow provides sufficient cooling. An exchange or cleaning of the filter kit is appropriate at that time.

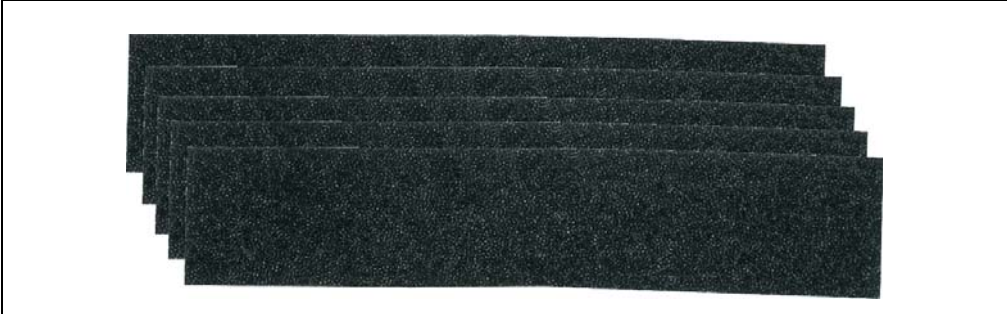

Figure 383: Replacement fan

Model number	Short description	Note
5AC600.FA01-00	<b>APC620 replacement fan filter 1PCI 5 piece</b> This fan filter is an optional addition for system units with 1 PCL slot (5PC600.SX01-00).	
5AC600.FA02-00	<b>APC620 replacement fan filter 1PCI 5 piece</b> This fan filter is an optional addition for system units with 2 PCL slots (5PC600.SX02-00, 5PC600.SX02-01).	
5AC600.FA03-00	<b>APC620 replacement fan filter 3PCI 5 piece</b> This fan filter is an optional addition for system units with 3 PCL slots (5PC600.SF03-00).	
5AC600.FA05-00	<b>APC620 replacement fan filter 1PCI 5 piece</b> This fan filter is an optional addition for system units with 5 PCL slots (5PC600.SX05-00, 5PC600.SX05-01).	

Table 458: Model numbers - Replacement fan filters

## 20. SRAM module - 5AC600.SRAM-00

The 512 KB SRAM module increases APC620 application possibilities. It is inserted internally on the baseboard (depending on revision) and doesn't require a PCI slot. Nonvolatile data can be stored on it. The module is backed up by the APC620 battery.

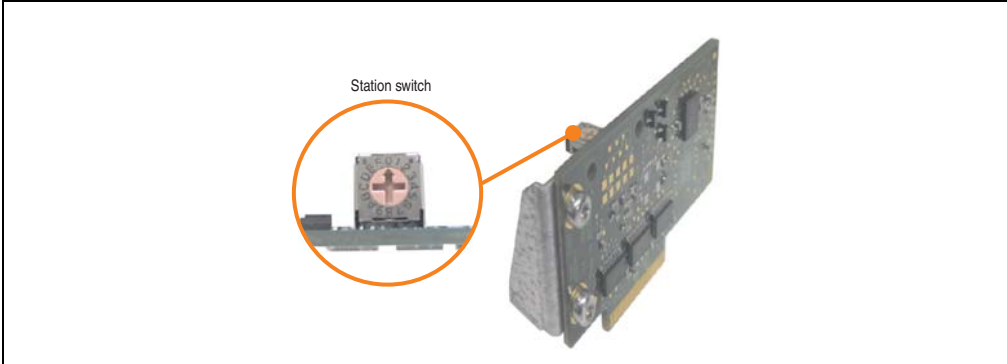

Figure 384: 5AC600.SRAM-00

The following system unit hardware revisions are required before mounting the SRAM module:

- 5PC600.SX01-00 starting with Rev I0
- 5PC600.SX01-00 starting with Rev. H0
- 5PC600.SX02-01 starting with Rev. K0
- 5PC600.SF03-00 all revisions
- 5PC600.SX05-00 starting with Rev. H0
- 5PC600.SX05-01 starting with Rev. H0

### 20.1 Technical data

Features	5AC600.SRAM-00
Connection to system	via the PCI bus (PCI PnP)
Memory Quantity Battery-buffered Remanent variables for AR (Automation Runtime) in power fail mode	SRAM 512 kB Yes 256 kB with CPU board 5PC600.E855-xx and 5PC600.X855-xx 192 kB with CPU board 5PC600.X945-00
Station switch	16 digits (0-F)
Data rate	Up to 31 MB/s for write access Up to 25 MB/s for read access

Table 459: Technical data - 5AC600.SRAM-00

Features	5AC600.SRAM-00	
PCI configuration space	Value	Meaning
Vendor ID Device ID Status HeaderType	1677h A085h 0200h 00h	B & R 5AC600.SRAM-00 DEVSEL timing medium Single function device
The card is registered in the PCI Configuration Space as Single Function Device	Value	Meaning
Device 0 Base class Sub class Command IRQ BAR0 BAR1	 05h 00h 0000h - 512 4	 Memory controller RAM Bus master (not used) Not used kByte memory area Byte I/O area

Table 459: Technical data - 5AC600.SRAM-00

## 20.2 Driver support

The module is presently only supported in an Automation Runtime environment. Driver for other operating systems (e.g. Windows XP) are available upon request.

## 20.3 Installation

Installation is described in the example with system unit 5PC600.SF03-00 with inserted AP Link cards and APC620 UPS module.

- Remove side cover from APC620 (see chapter 7 "Maintenance / Servicing", section 6 "Mounting the side cover", on page 781).
- Screw on the M3x5 Torx included in the delivery to the baseboard of the module.

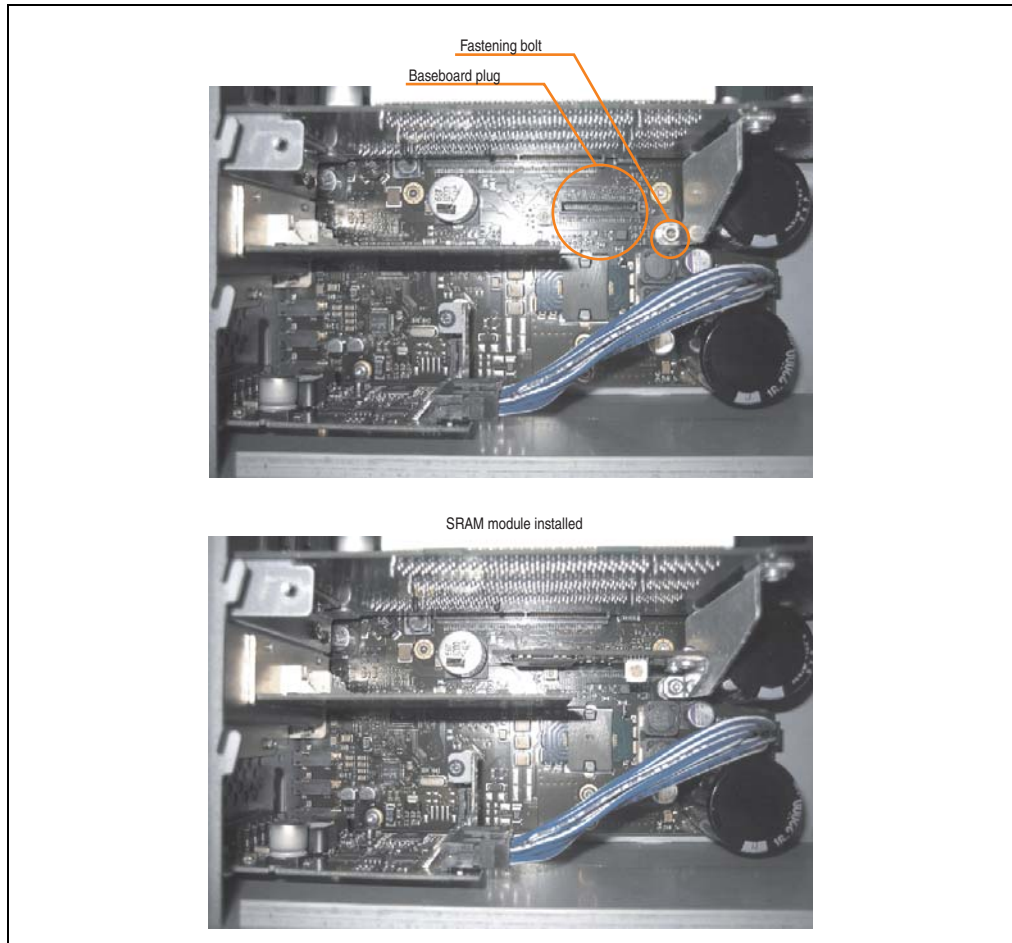

Figure 385: SRAM module installation

## 21. Power supplies

In order to meet demands for complete, comprehensive system solutions, power supplies are available in the B&R product line for mounting rail installation. This extensive spectrum ranges from single-phase power supplies that supply 2.1 A up to three-phase power supplies that supply 40 A. All switching power supplies can manage a wide range of AC and DC input voltages. This input ranges from 100 to 240 VAC or 400 to 500 VAC and from 85 to 375 VDC. Devices are protected against short circuit, overload, and open circuit, which allows them to be operated without functional limitations or derating even when overloads between 15% and 25% occur.



Figure 386: B&R power supplies (examples)

Two mini power supplies (PS102 and PS104) in robust plastic housing are available in the lower performance range. A well-designed cooling concept allows several different mounting orientations. The functional DIN rail allows fast mounting and removal. Wiring is essentially performed in seconds thanks to the spring clamps being used. The compact design, easy mounting and several different mounting orientations make the two smallest power supplies in this product line components that can be used practically anywhere.

## 21.1 Model numbers and brief technical overview

The technical data listed in the following tables should act as a brief selection guide. For more detailed technical data, data sheets are available for download from production description section of the B&R homepage ([www.br-automation.com](http://www.br-automation.com)).

### 21.1.1 Single-phase power supplies

Features	0PS102.0	0PS104.0	0PS105.1	0PS105.2	0PS110.1	0PS110.2	0PS120.1
Output power	50 W	100 W	120 W	120 W	240 W	240 W	480 W
AC input voltage	85-264 V	85-132 V 184-264 V	85-132 V 176-264 V	85-132 V 176-264 V	85-132 V 176-264 V	85-132 V 176-264 V	85-132 V 176-264 V
DC input voltage	85-375 V	220-375 V	210-375 V	210-375 V	210-375 V	210-375 V	-
Output voltage	24-28 V	24-28 V	24 V	24 V	24-28 V	24-28 V	24-28 V
Output current at 24 V	2.1 A	4.2 A	5 A	5 A	10 A	10 A	20 A
Parallel operation	No	Yes	Yes	Yes	Yes	Yes	Yes
Current balancing	No	Yes	No	Yes	No	Yes	Yes

Table 460: Single-phase power supplies

### 21.1.2 Three-phase power supplies

Features	0PS305.1	0PS310.1	0PS320.1	0PS340.1
Output power	120 W	240 W	490 W	960 W
AC input voltage	340-576 V	340-576 V	340-576 V	340-576 V
DC input voltage	450-820 V	450-820 V	450-820 V	450-820 V
Output voltage	24-28 V	24-28 V	24 V	24 V
Output current at 24 V	5 A	10 A	20 A	40 A
Parallel operation	Yes	Yes	Yes	Yes
Current balancing	No	Yes	Yes	Yes

Table 461: Three-phase power supplies

## Chapter 7 • Maintenance / Servicing

---

The following chapter describes service/maintenance work which can be carried out by a trained, qualified user.

### 1. Changing the battery

The lithium battery buffers the internal real-time clock (RTC) and the CMOS data. The buffer duration of the battery is at least 4 years (2½ years with the SRAM module model number 5AC600.SRAM-00 and at 50°C, 8.5 mA current requirements of the supplied components and a self discharge of 40%).

#### Information:

- The product design allows the battery to be changed with the APC620 switched either on or off. In some countries, safety regulations do not allow batteries to be changed while the module is switched on.
- Any BIOS settings that have been made will remain when the battery is changed with the power turned off (stored in non-volatile EEPROM). The date and time must be reset later because this data is lost when the battery is changed.
- The battery should only be changed by qualified personnel.

#### Warning!

Replace battery with Renata, type CR2477N only. Use of another battery may present a risk of fire or explosion.

Battery may explode if mistreated. Do not recharge, disassemble or dispose of in fire.

The following replacement lithium batteries are available: 4A0006.00-000 (single) and 0AC201.91 (4 pcs.).

## 1.1 Battery status evaluation

The battery status is evaluated immediately following start-up of the device and is subsequently checked by the system every 24 hours. The battery is subjected to a brief load (1 second) during the measurement and then evaluated. The evaluated battery status is displayed in the BIOS Setup pages (under Advanced - Baseboard monitor) and in the B&R Control Center (ADI driver), but can also be read in a customer application via the ADI Library.

Battery status	Meaning
N/A	Hardware, i.e. firmware used is too old and does not support read.
GOOD	Data buffering is guaranteed
BAD	Data buffering is guaranteed for approx. another 500 hours from the point in time that the battery capacity is determined to be BAD (insufficient).

Table 462: Meaning of battery status

From the point when battery capacity is recognized as insufficient, data buffering is guaranteed for approximately another 500 hours. When changing the battery, data is buffered for approximately another 10 minutes by a gold leaf capacitor.

## 1.2 Procedure

- Disconnect the power supply to the Automation PC 620 (also see information on page 743).
- Touch the housing or ground connection (not the power supply!) in order to discharge any electrostatic charge from your body.
- Remove the black plastic cover from the battery compartment and carefully pull out the battery using the removal strips.



Figure 387: Battery removal



- Insert the new battery with correct polarity. The battery should not be held by its edges. Insulated tweezers may also be used for inserting the battery.

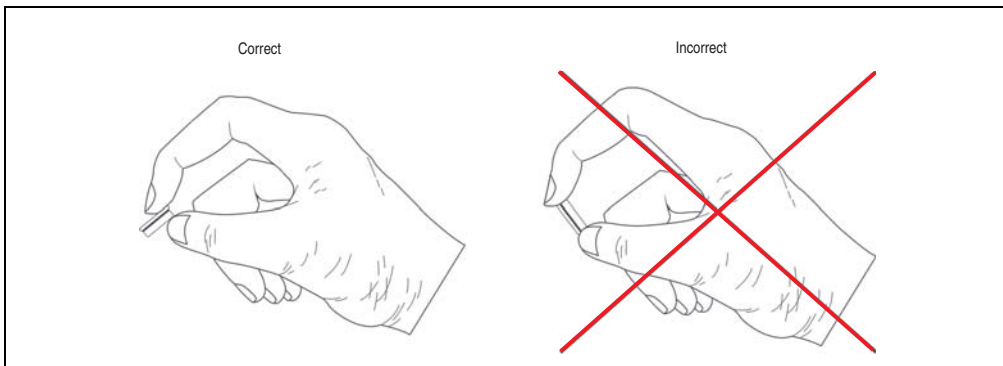

Figure 388: Battery handling

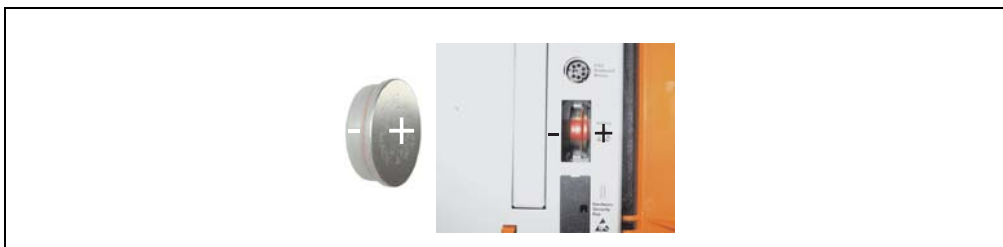

Figure 389: Battery polarity

- To make the next battery change easier, be sure the removal strip is in place when inserting battery.
- Reconnect the power supply to the PC 620 by plugging the power cable back in and pressing the power button (also see information on page 743).
- Reset the data and time in BIOS (see information on page 743).

## Warning!

**Lithium batteries are considered hazardous waste. Used batteries should be disposed of according to local requirements.**

## 2. Changing the CompactFlash

By pressing the ejection lever (see figure) with a pointed object (i.e. pen) the exchange of the CompactFlash card is quickly and safely.

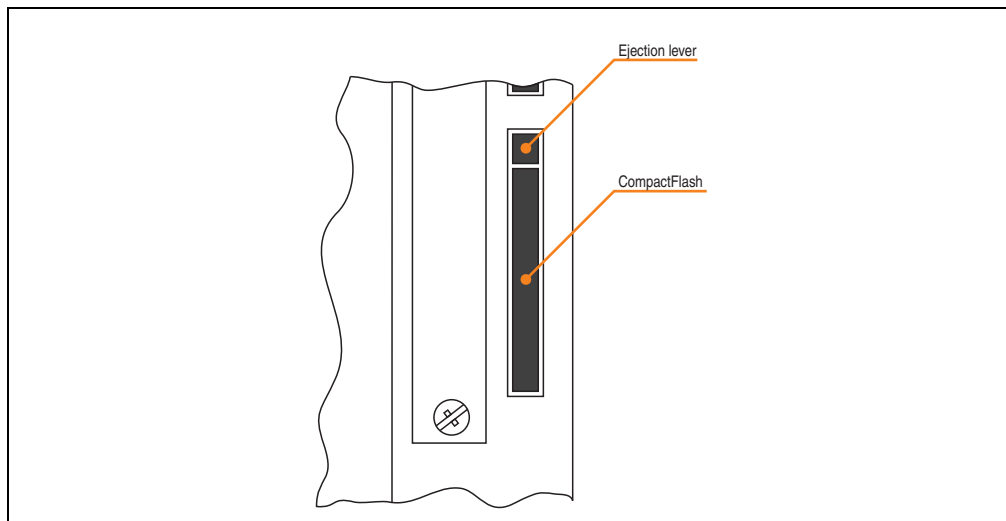

Figure 390: CompactFlash + ejection lever (representation picture)

### **Caution!**

**The power must be turned off before inserting or removing the CompactFlash card!**

### 3. Fan kit installation and replacement

#### 3.1 Procedure for APC620 with 1 PCI slot

- Disconnect the power supply to the Automation PC 620.
- Touch the housing or ground connection (not the power supply!) in order to discharge any electrostatic charge from your body.
- Open the orange front cover. Behind the cover there are 4 Torx screws (T10) that must be removed.



Figure 391: APC620 1PCI slot - Remove screws to install/ remove filter kit

- After the screws have been removed, the side cover and the fan kit cover can be removed toward the front.



Figure 392: APC620 1PCI slot - Remove side cover and fan kit cover

- If a PCI card is in place, it must be removed before moving on to the next step.

- There are two arrows on the fans that indicate the direction of air flow and the direction of fan rotation.

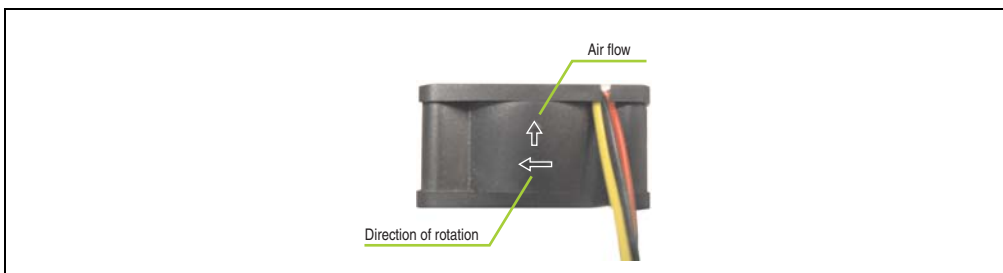

Figure 393: Markings for direction of airflow / fan rotation

## Warning!

The fans must be inserted so that the air flows toward the inside of the housing.

- Align fans over the fastening bolts (see arrows). Feed cables through the openings in the housing (see circles) into the main board of the APC620.

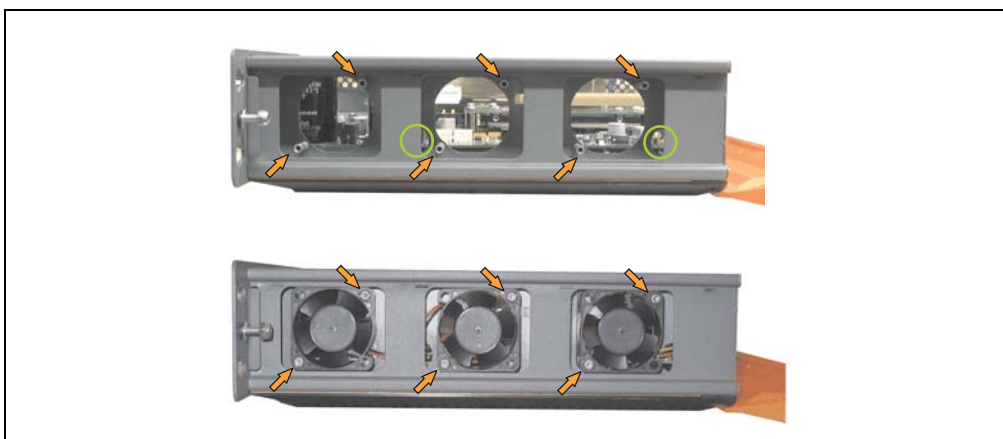

Figure 394: APC620 1PCI slot - Fan installation

- Secure fans with the 6 included Torx (T10) screws.

- The fan connection cable must be connected to the main circuit board at the right position (fan 1 at position 1, fan 2 at position 2, fan 3 at position 3).

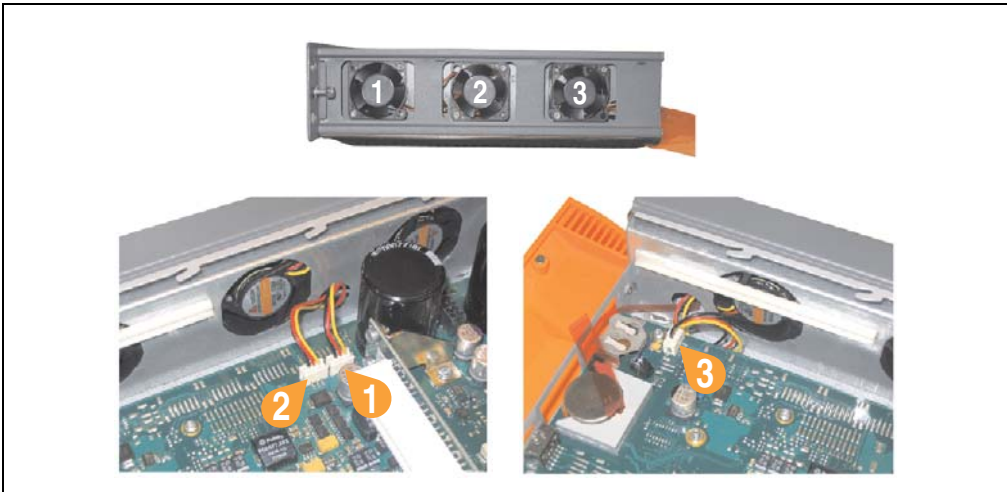

Figure 395: APC620 1PCI slot - Fan cable connection to the main board

- If a PCI card was previously in place, it can now be re-inserted.
- Place dust filter in the fan kit cover and replace removed components (filter kit cover, side cover) in reverse order.

### 3.2 Procedure for APC620 with 2 PCI slot

- Disconnect the power supply to the Automation PC 620.
- Touch the housing or ground connection (not the power supply!) in order to discharge any electrostatic charge from your body.
- Open the orange front cover. Behind the cover there are 4 Torx screws (T10) that must be removed.



Figure 396: APC620 2PCI slots - Remove screws to install/ remove filter kit

- After the screws have been removed, the side cover and the fan kit cover can be removed toward the front.

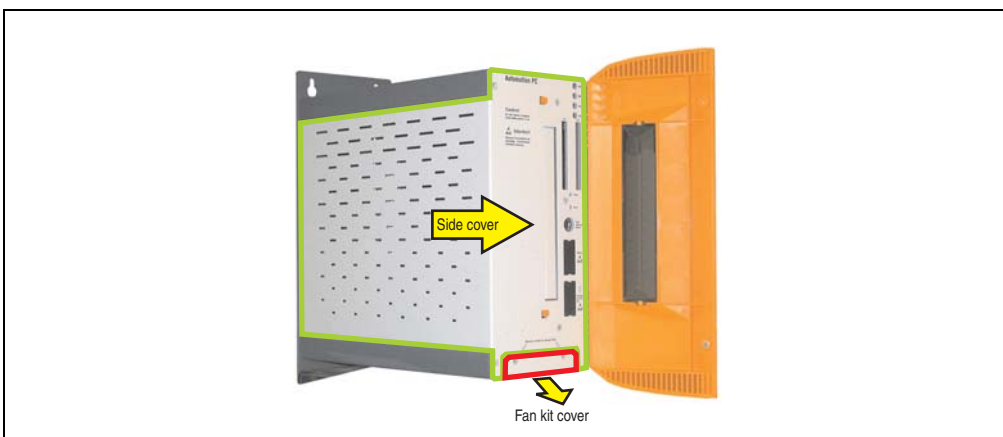

Figure 397: APC620 2PCI slots - Remove side cover and fan kit cover

- If one or more PCI cards are in place, they must be removed before moving on to the next step.
- If a slide-in drive is in place, it also must be removed before moving on to the next step.
- There are two arrows on the fans that indicate the direction of air flow and the direction of fan rotation.

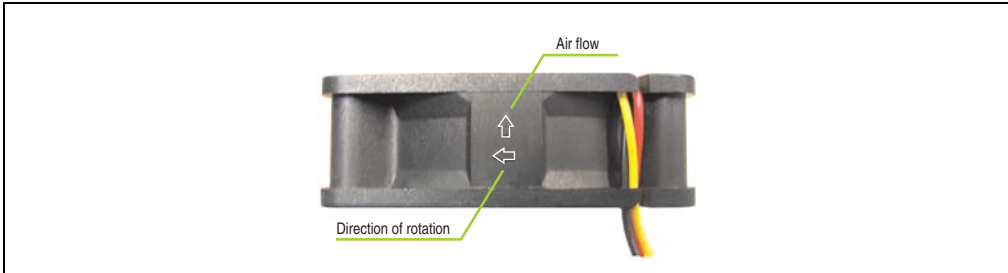

Figure 398: Markings for direction of airflow / fan rotation

## Warning!

The fans must be inserted so that the air flows toward the inside of the housing.

- Align fans over the fastening bolts (see arrows). Feed cables through the openings in the housing (see circles) into the main board of the APC620.

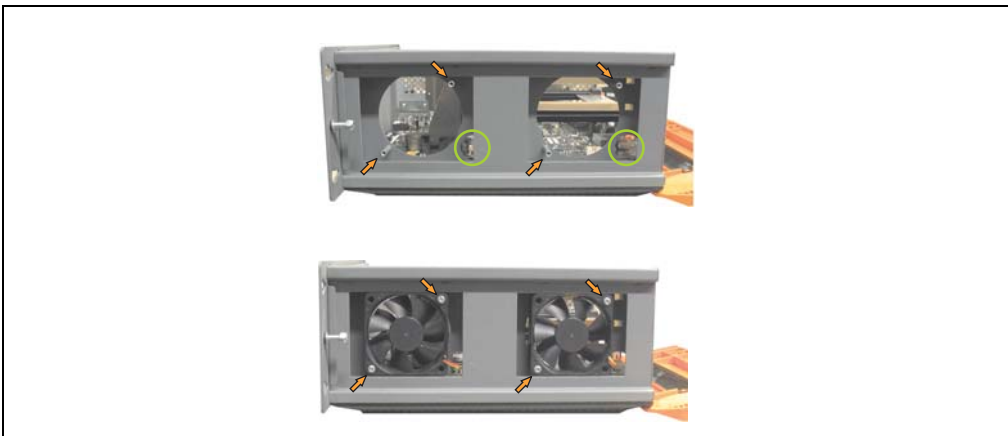

Figure 399: APC620 2PCI slots - Fan installation

- Secure fans with the 4 included Torx (T10) screws.

- The fan connection cable must be connected to the main circuit board at the right position (fan 1 at position 1, fan 2 at position 2).

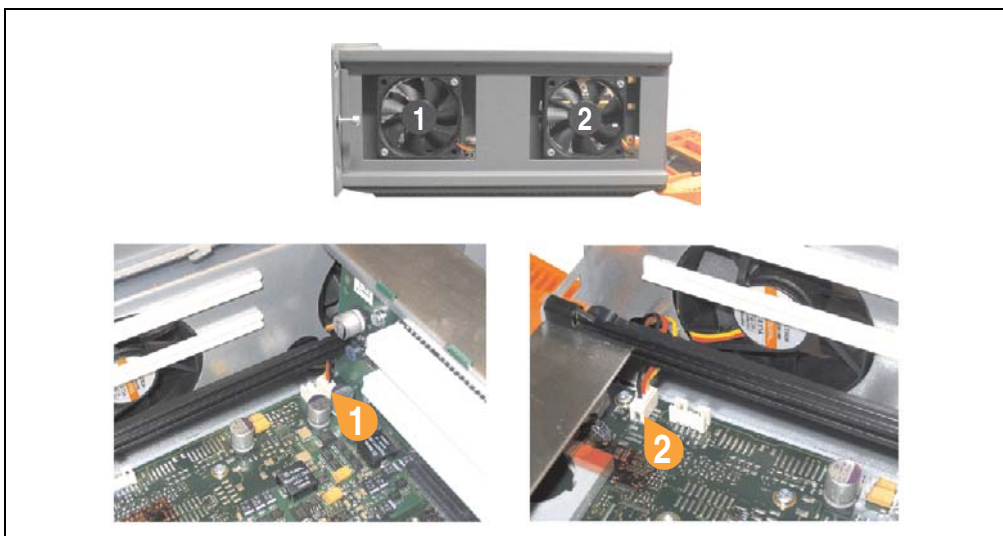

Figure 400: APC620 2PCI slots - Fan cable connection to the main board

- If one or more PCI cards were previously in place, they can now be re-inserted.
- If a slide-in drive was previously in place, it too can now be re-inserted.
- Place the dust filter in the fan kit cover and secure with the filter clasp.

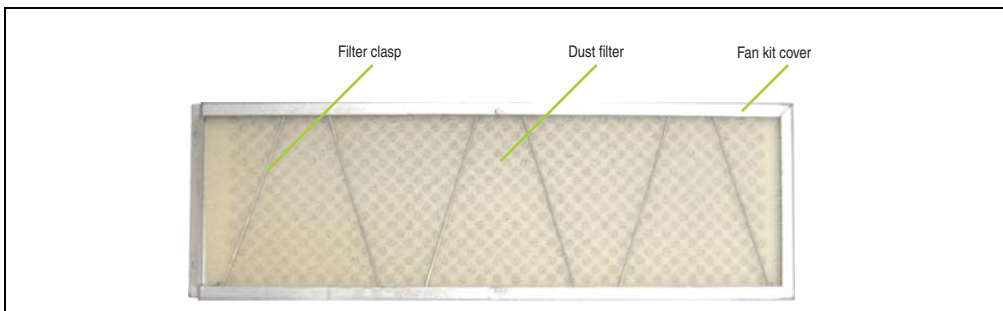

Figure 401: Dust filter in the fan kit cover and filter clasp

- Replace any removed components (filter kit cover, side cover) in the reverse order.



### 3.3 Procedure for APC620 with 3 PCI slot

- Disconnect the power supply to the Automation PC 620.
- Touch the housing or ground connection (not the power supply!) in order to discharge any electrostatic charge from your body.
- Open the orange front cover. Behind the cover there are 4 Torx screws (T10) that must be removed.



Figure 402: APC620 3PCI slot - Remove screws to install/ remove filter kit

- After the screws have been removed, the side cover and the fan kit cover can be removed toward the front.



Figure 403: APC620 3PCI slots - Remove side cover and fan kit cover

- There are two arrows on the fans that indicate the direction of air flow and the direction of fan rotation.

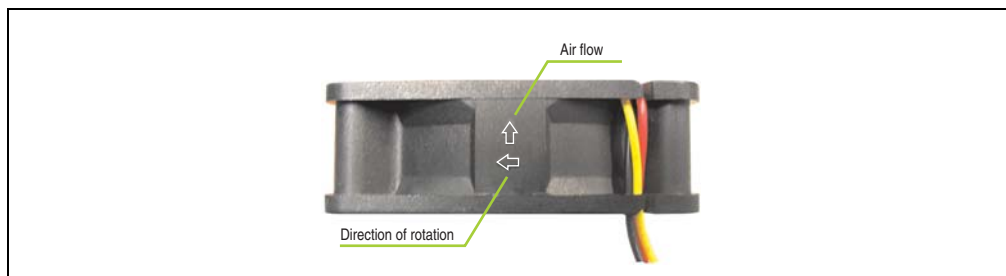

Figure 404: Markings for direction of airflow / fan rotation

## Warning!

The fans must be inserted so that the air flows toward the inside of the housing.

- Align fans over the fastening bolts (see arrows). Feed cables through the openings in the housing (see circles) into the main board of the APC620.



Figure 405: APC620 3PCI slot - Fan installation

- Secure fans with the 4 included Torx (T10) screws.

- The fan connection cable must be connected to the main circuit board at the right position (fan 1 at position 1, fan 2 at position 2).

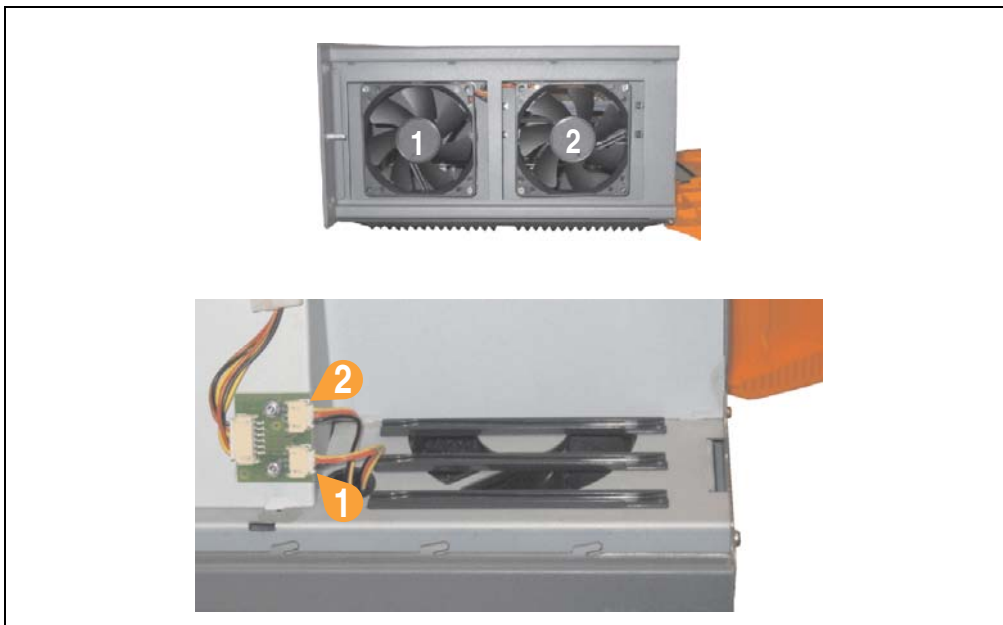

Figure 406: APC620 3PCI slot - Fan cable connection to the main board

- Place the dust filter in the fan kit cover and secure with the filter clasp.

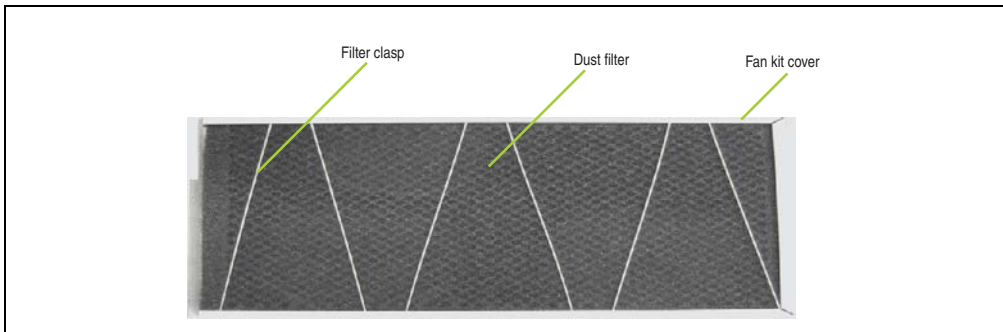

Figure 407: Dust filter in the fan kit cover and filter clasp

- Replace any removed components (filter kit cover, side cover) in the reverse order.

### 3.4 Procedure for APC620 with 5 PCI slot

- Disconnect the power supply to the Automation PC 620.
- Touch the housing or ground connection (not the power supply!) in order to discharge any electrostatic charge from your body.
- Open the orange front cover. Behind the cover there are 4 Torx screws (T10) that must be removed.



Figure 408: APC620 5PCI slot - Remove screws to install/ remove filter kit

- After the screws have been removed, the side cover and the fan kit cover can be removed toward the front.



Figure 409: APC620 5PCI slot - Remove side cover and fan kit cover

- If one or more PCI cards are in place, they must be removed before moving on to the next

step.

- If a slide-in drive is in place, it also must be removed before moving on to the next step.
- Attach the two included cable fasteners in the appropriate holes.

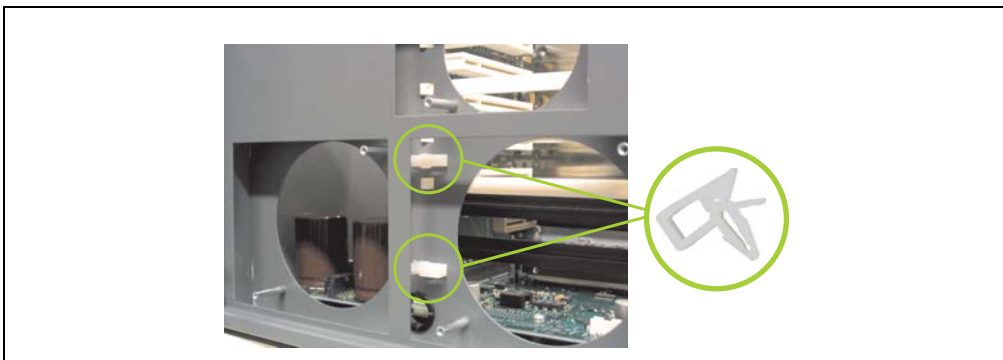

Figure 410: APC620 5PCI attach cable fasteners

- There are two arrows on the fans that indicate the direction of air flow and the direction of fan rotation.

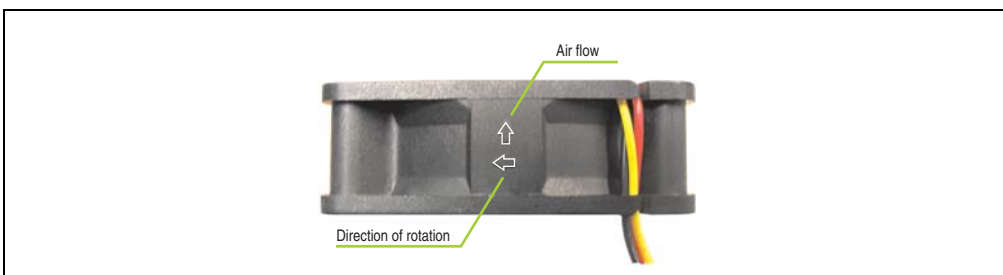

Figure 411: Markings for direction of airflow / fan rotation

## Warning!

The fans must be inserted so that the air flows toward the inside of the housing.

- Align fans over the fastening bolts (see arrows). Feed cables through the openings in the housing (see circles) into the main board of the APC620.  
The fan connector cable for the 40 mm fan should be placed in the cable fastener.

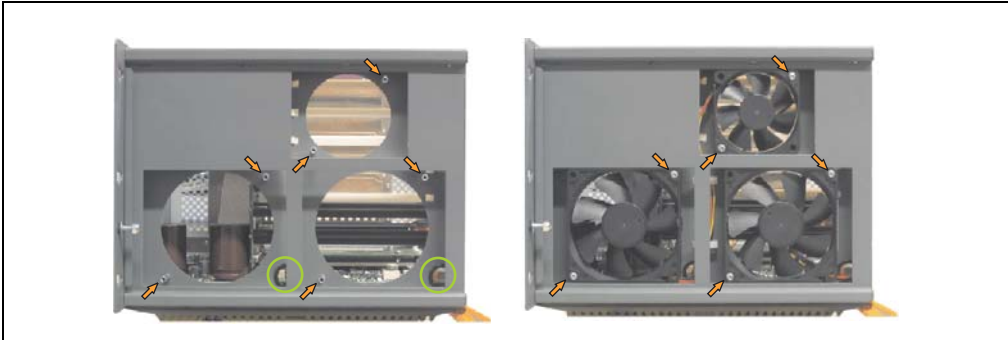

Figure 412: APC620 5PCI slot - Fan installation

- Secure fans with the 6 included Torx (T10) screws.

## Maintenance / Servicing • Fan kit installation and replacement

- The fan connection cable must be connected to the main circuit board at the right position (fan 1 at position 1, fan 2 at position 2, fan 3 at position 3).

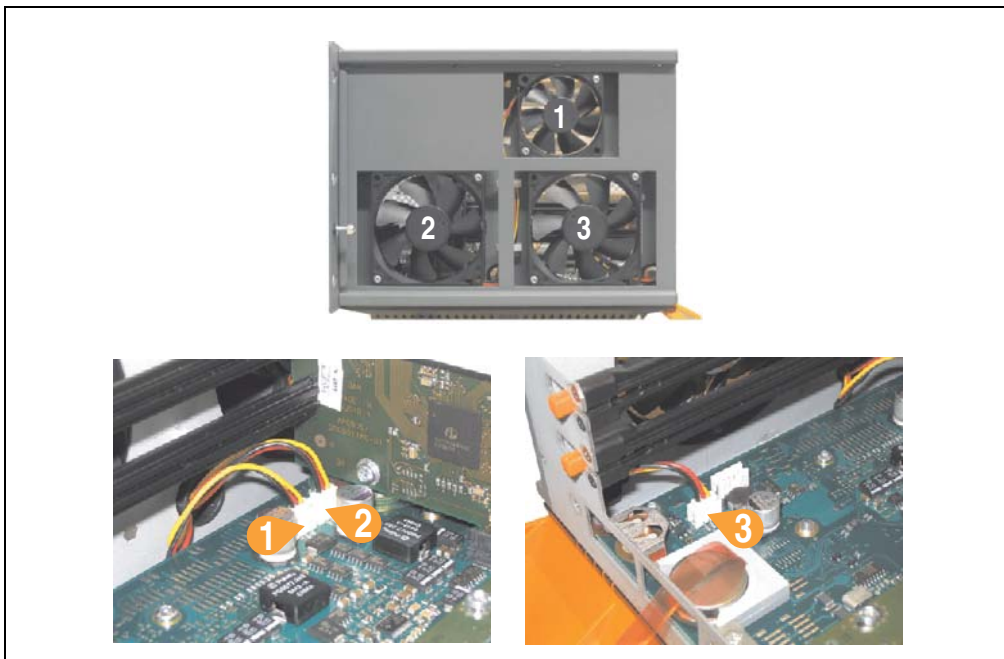

Figure 413: APC620 5PCI slot - Fan cable connection to the main board

- If one or more PCI cards were previously in place, they can now be re-inserted.
- If a slide-in drive was previously in place, it too can now be re-inserted.



- Place the dust filter in the fan kit cover and secure with the filter clasp.

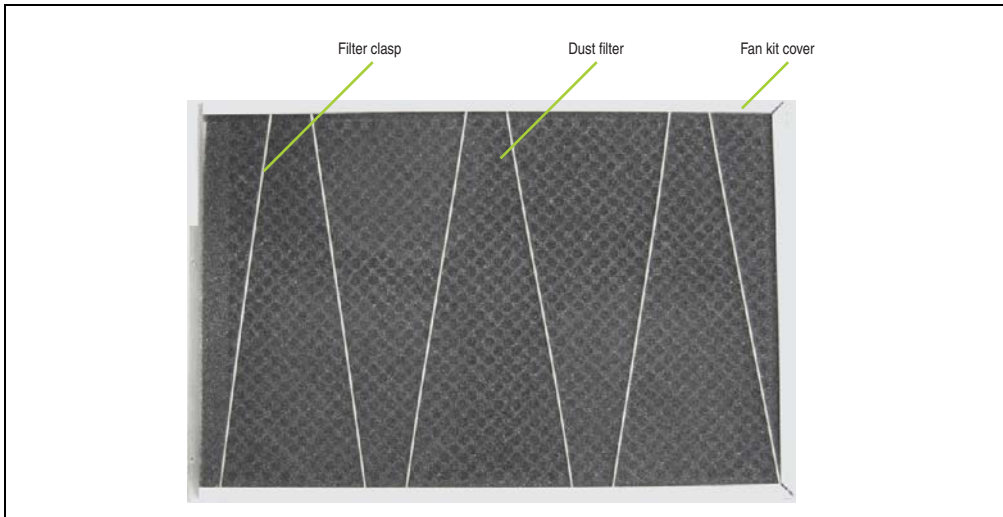

Figure 414: Dust filter in the fan kit cover and filter clasp

- Replace any removed components (filter kit cover, side cover) in the reverse order.

## 4. Slide-in drive - installation and exchange

Slide-in drives can be installed and exchanged in system units with 2 or 5 PCI slots.

### 4.1 Installation procedure

- Disconnect the power supply to the Automation PC 620.
- Touch the housing or ground connection (not the power supply!) in order to discharge any electrostatic charge from your body.
- Remove the side cover, see section 6 "Mounting the side cover", on page 781.
- Remove the slide-in dummy module.

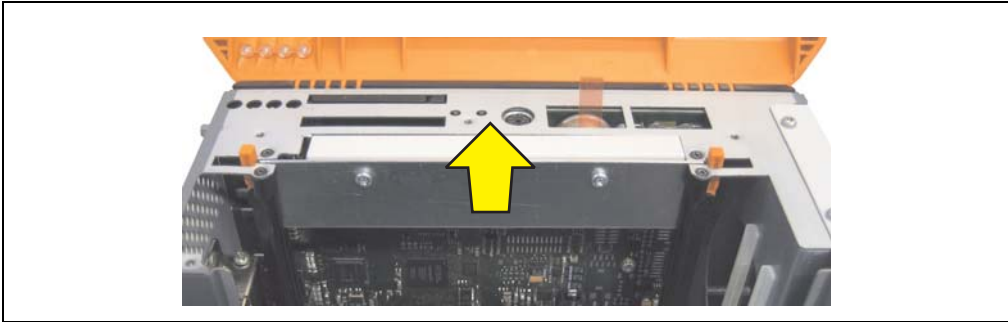

Figure 415: Removing the slide-in dummy module

- Insert the slide-in drive.

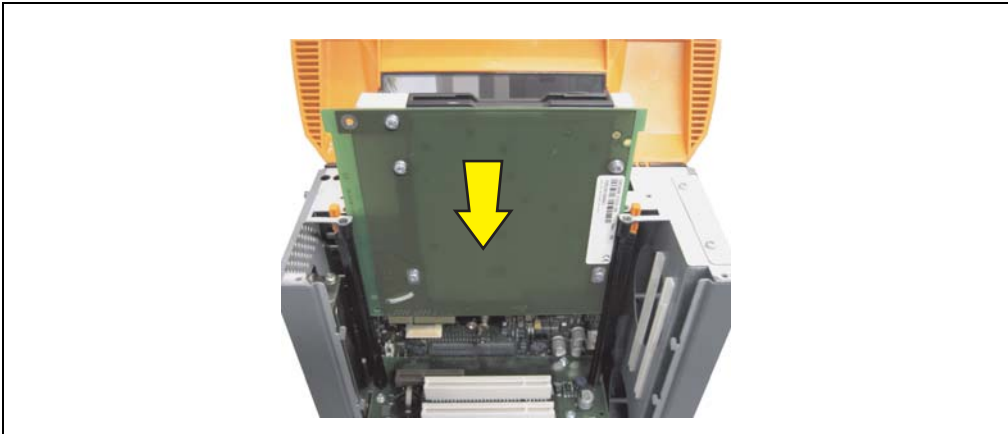

Figure 416: Installing the slide-in drive

- Attach the side cover.

## 4.2 Exchange procedure

- Disconnect the power supply to the Automation PC 620.
- Touch the housing or ground connection (not the power supply!) in order to discharge any electrostatic charge from your body.
- Remove the side cover, see section 6 "Mounting the side cover", on page 781.
- Simultaneously remove both slide-in slot releasing mechanisms outwards. The slide-in drive is pushed a few mm upwards for easy removal.

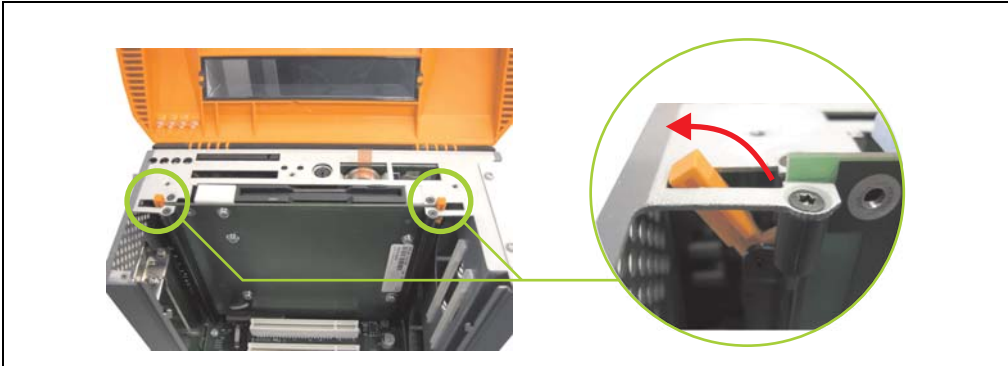

Figure 417: Release the slide-in slot releasing mechanisms

- Removing the slide-in drive.

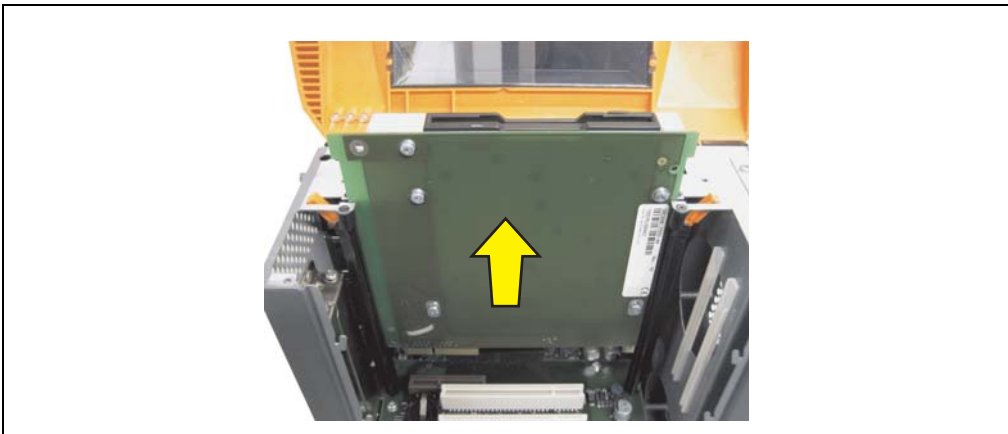

Figure 418: Removing the slide-in drive

- Move the slide-in slot releasing mechanisms to the start position.

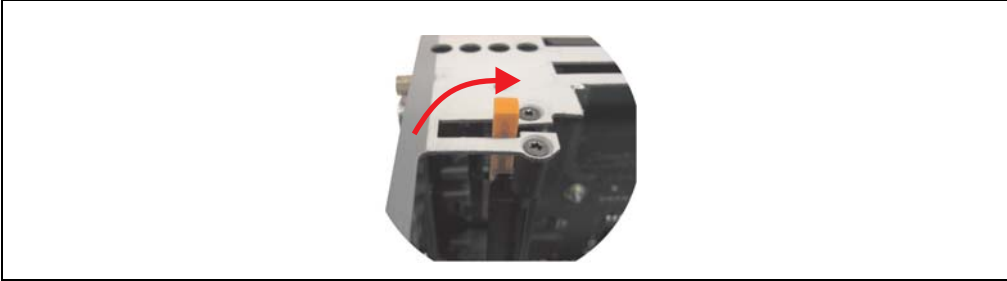

Figure 419: Slide-in slot releasing mechanism start position

- Insert the new slide-in drive or re-attach the side cover.

## 5. Installing the UPS module

The module is installed using the materials included in the delivery. Different parts are used depending on the system unit and whether the add-on interface module is **installed** (description starting on page 774) or **not installed** (description follows).

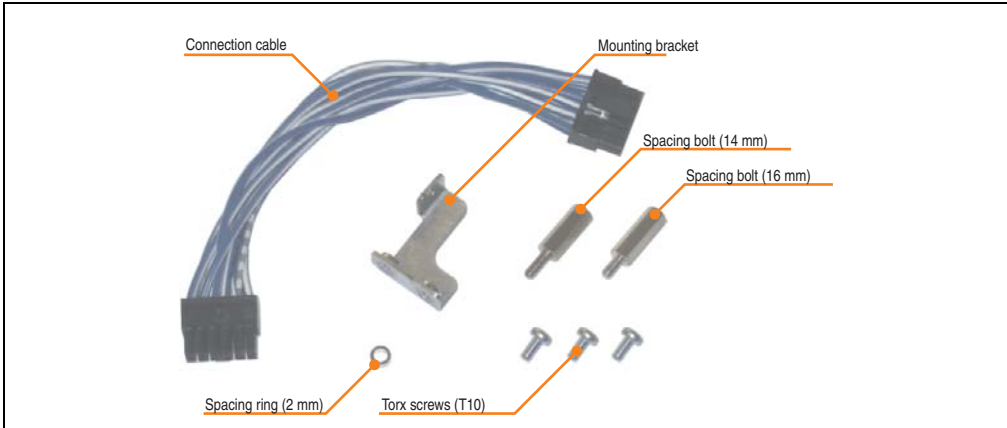

Figure 420: Add-on UPS module 5AC600.UPSI-00 - Installation materials

### 5.1 Automation PC 620 without add-on interface module

#### 5.1.1 APC620, 1 PCI slot

- Remove side cover (see section 6 "Mounting the side cover", on page 781).
- Remove UPS module cover by removing the 2 marked Torx screws (T10).

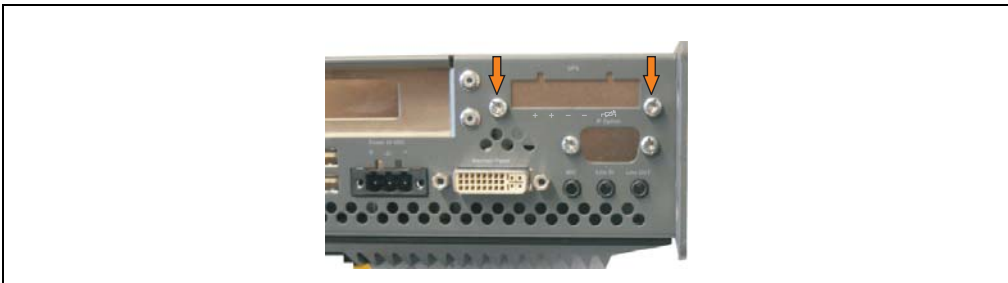

Figure 421: Remove UPS module cover

- Screw in spacing bolt and spacing ring (using M5 hex socket screwdriver).

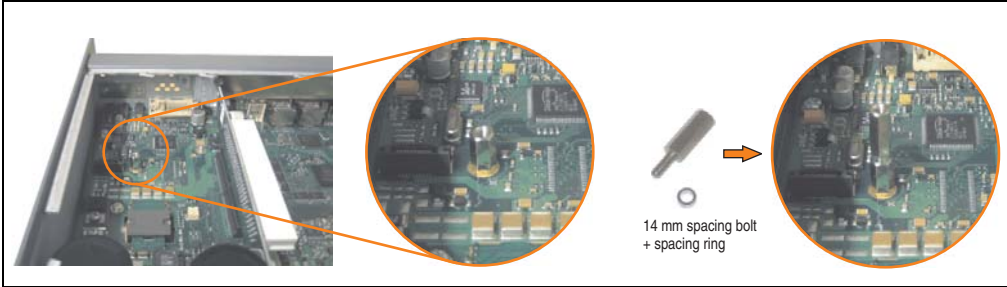

Figure 422: Screw in spacing bolt and spacing ring

- Install UPS module with 2 Torx screws (T10) and 1 Torx screw (T10). Use the previously removed Torx screws and one Torx screw from the mounting materials.



Figure 423: Install UPS module

- Plug in connection cable (see marked socket).

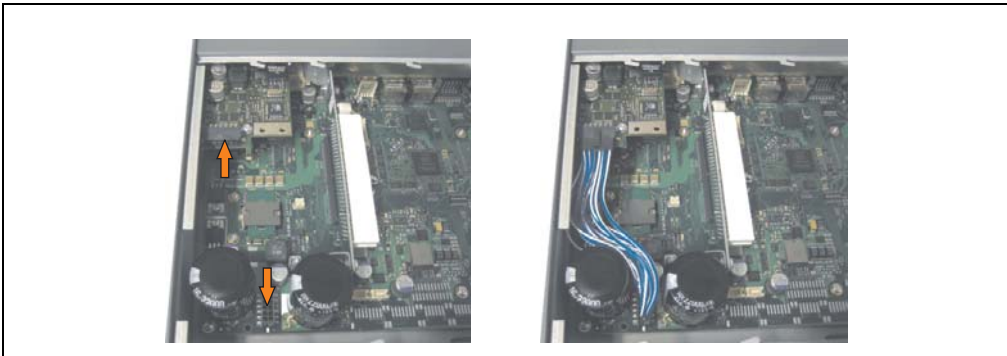

Figure 424: Plug in connection cable

## Information:

When connecting the cable, make sure that the connector locking mechanism is engaged.

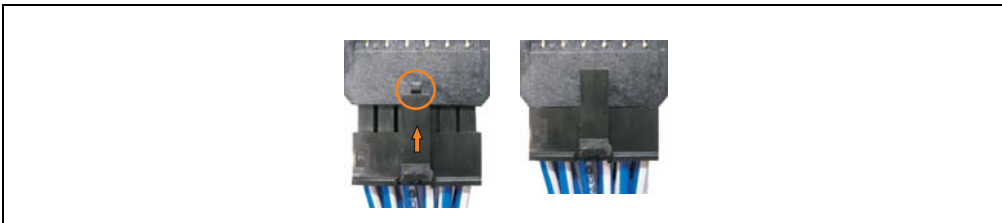

Figure 425: Connector locking mechanism

- Attach the side cover.

### 5.1.2 APC620, 2 PCI slot

- Remove side cover (see section 6 "Mounting the side cover", on page 781).
- Remove UPS module cover by removing the 2 marked Torx screws (T10).

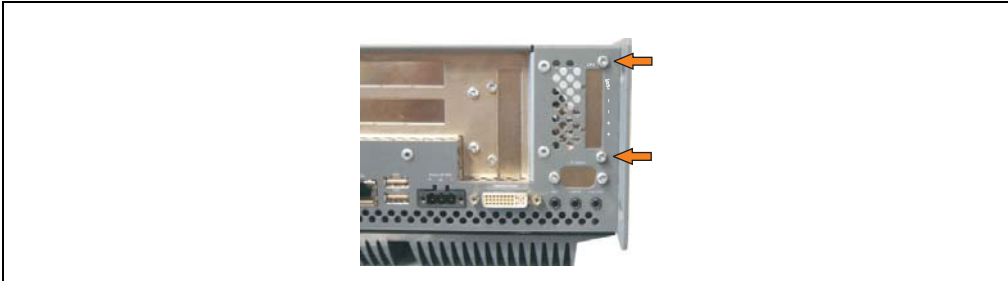

Figure 426: Remove UPS module cover

- Remove cover plate by removing the marked Torx screw (T10).

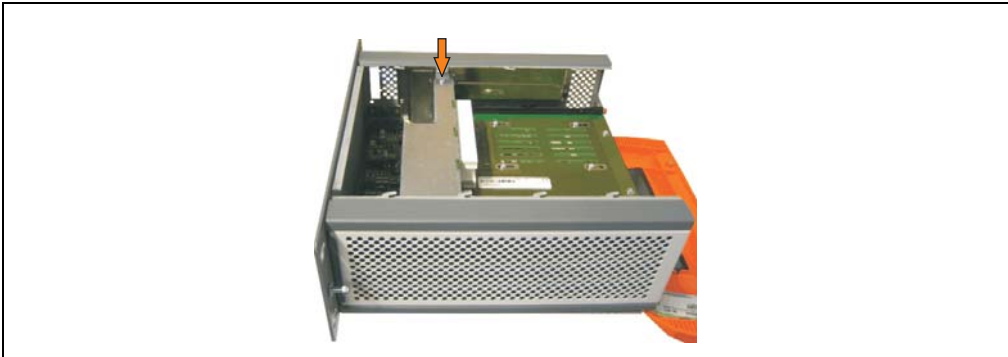

Figure 427: Remove cover plate

- Screw in spacing bolt and spacing ring (using M5 hex socket screwdriver).

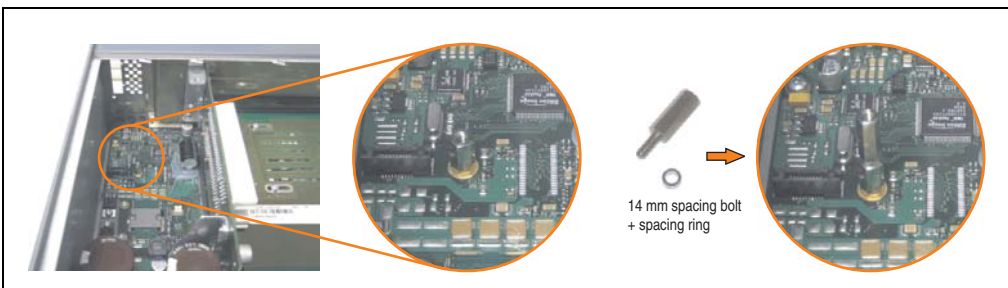

Figure 428: Screw in spacing bolt and spacing ring



- Install mounting bracket on UPS module using 2 Torx screws (T10).

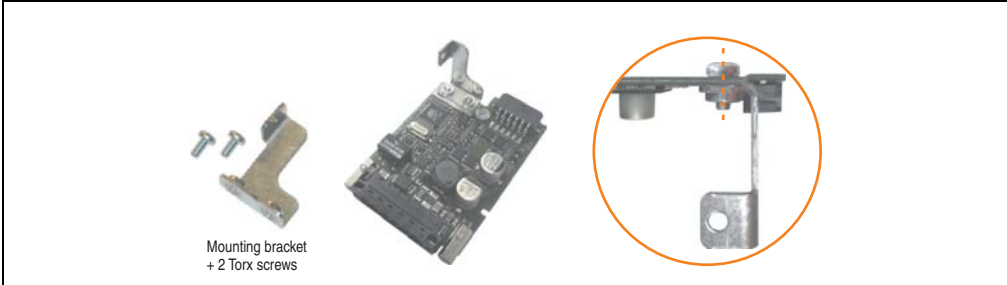

Figure 429: Install mounting bracket

- Install UPS module with 2 Torx screws (T10) and 1 Torx screw (T10). Use the previously removed Torx screws and one Torx screw from the mounting materials.

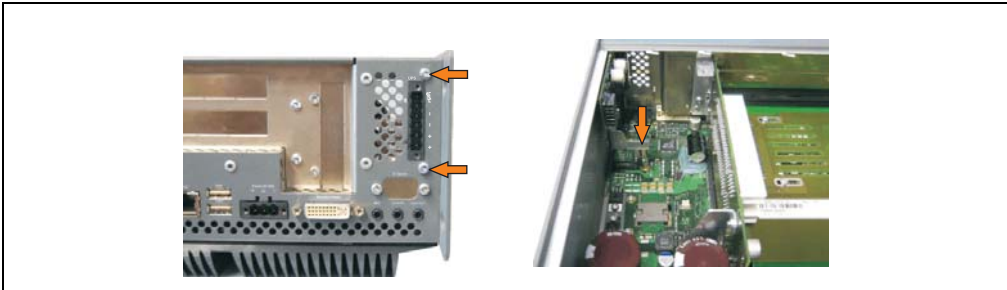

Figure 430: Install UPS module

- Plug in connection cable (see marked socket).

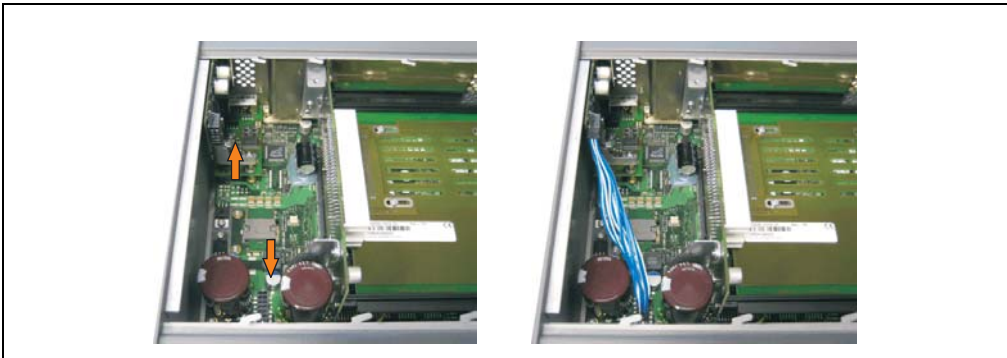

Figure 431: Plug in connection cable

## Information:

When connecting the cable, make sure that the connector locking mechanism is engaged.

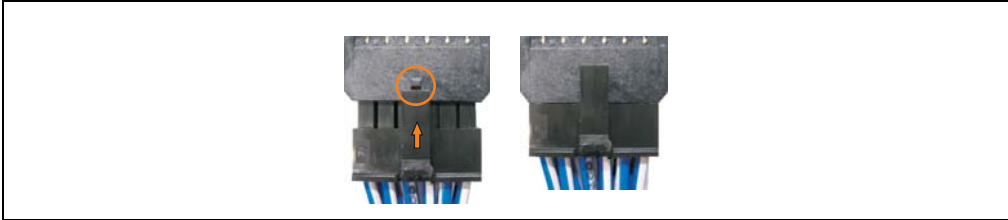

Figure 432: Connector locking mechanism

- Attach cover plate and side cover.

### 5.1.3 APC620, 5 PCI slot

- Remove side cover (see section 6 "Mounting the side cover", on page 781).
- Remove UPS module cover by removing the 2 marked Torx screws (T10).

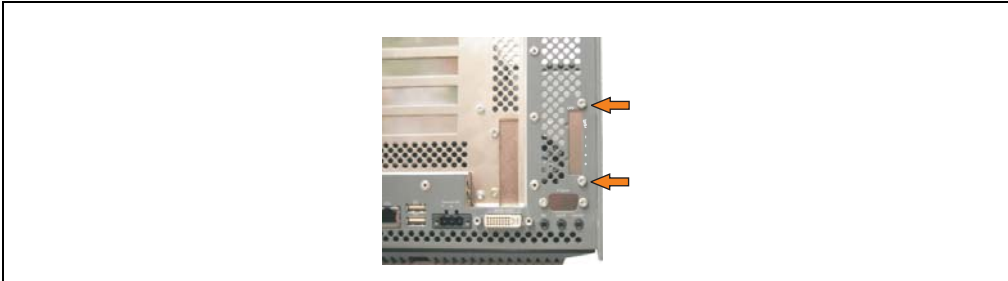

Figure 433: Remove UPS module cover

- Remove cover plate by removing the marked Torx screw (T10).

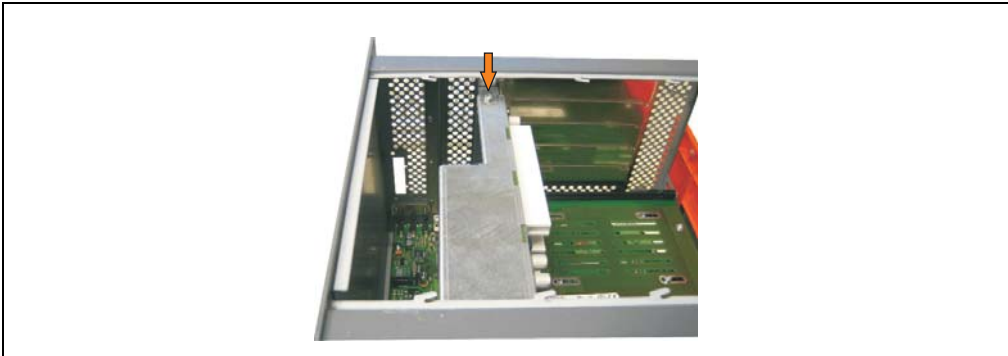

Figure 434: Remove cover plate

- Screw in spacing bolt and spacing ring (using M5 hex socket screwdriver).

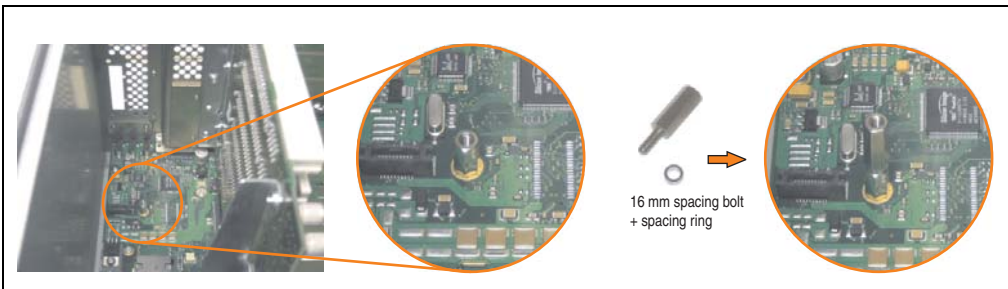

Figure 435: Screw in spacing bolt and spacing ring

- Install mounting bracket on UPS module using 2 Torx screws (T10).

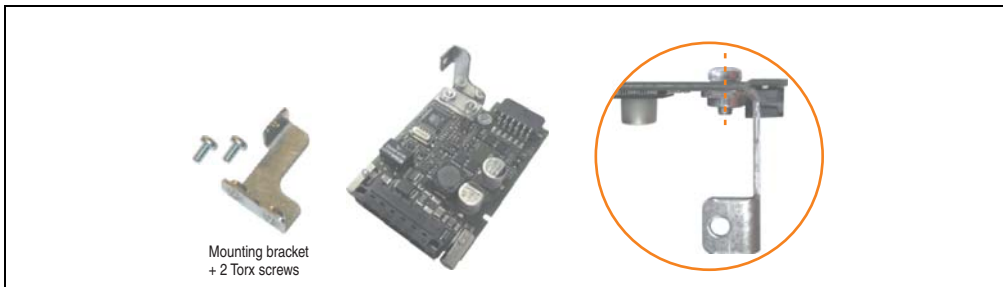

Figure 436: Install mounting bracket

- Install UPS module with 2 Torx screws (T10) and 1 Torx screw (T10). Use the previously removed Torx screws and one Torx screw from the mounting materials.

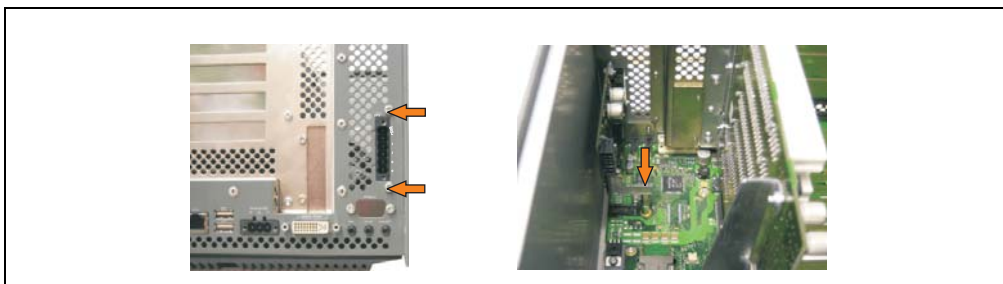

Figure 437: Install UPS module

- Attach connection cable (see marked socket).

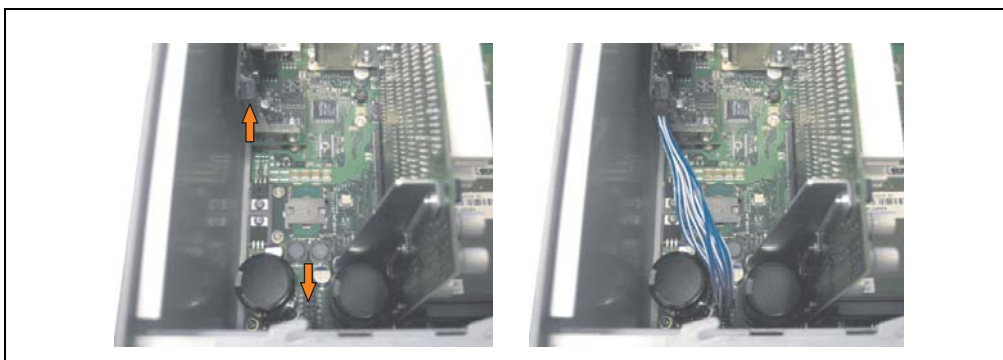

Figure 438: Plug in connection cable

**Information:**

When connecting the cable, make sure that the connector locking mechanism is engaged.

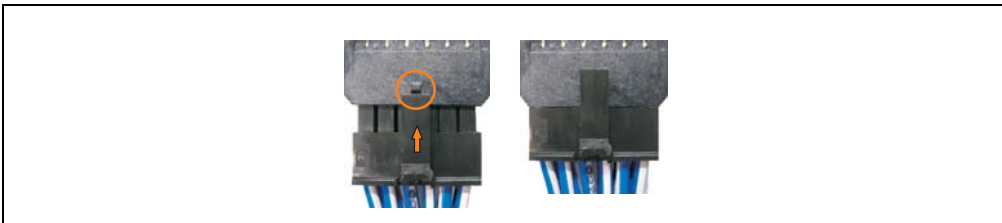

Figure 439: Connector locking mechanism

- Attach cover plate and side cover.

## 5.2 Automation PC 620 with add-on interface module

### 5.2.1 APC620, 1 PCI slot

- Remove side cover (see section 6 "Mounting the side cover", on page 781).
- Remove UPS module cover by removing the 2 marked Torx screws (T10).



Figure 440: Remove UPS module cover

- Screw in spacing bolt (using M5 hex socket screwdriver).

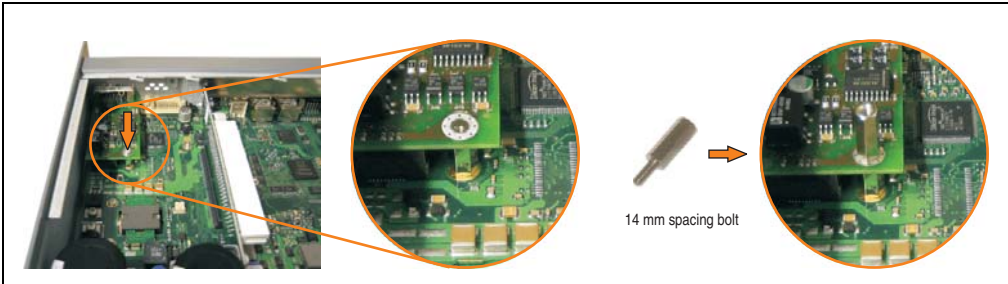

Figure 441: Screw in spacing bolt

- Install UPS module with 2 Torx screws (T10) and 1 Torx screw (T10). Use the previously removed Torx screws and one Torx screw from the mounting materials.

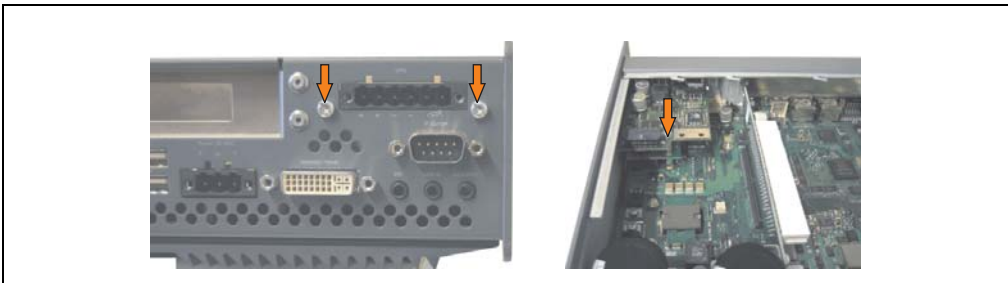

Figure 442: Install UPS module

- Plug in connection cable (see marked socket).

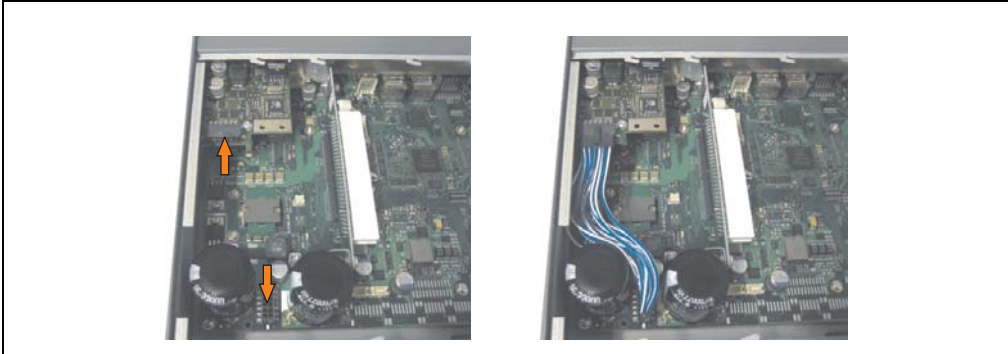

Figure 443: Plug in connection cable

## Information:

When connecting the cable, make sure that the connector locking mechanism is engaged.

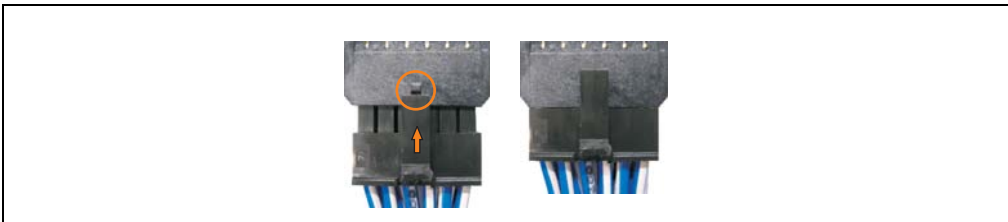

Figure 444: Connector locking mechanism

- Attach the side cover.

### 5.2.2 APC620, 2 PCI slot

- Remove side cover (see section 6 "Mounting the side cover", on page 781).
- Remove UPS module cover by removing the 2 marked Torx screws (T10).

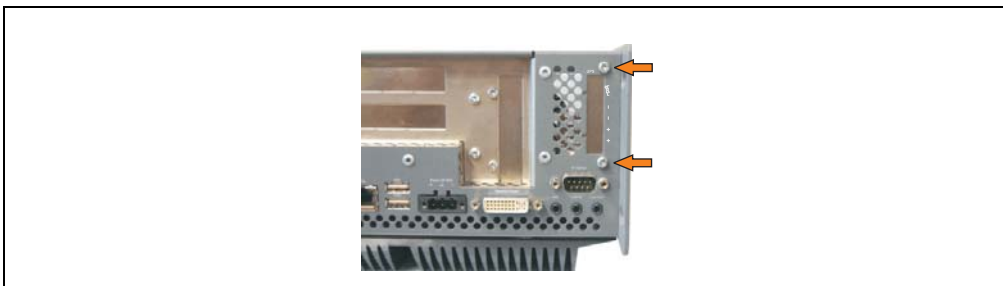

Figure 445: Remove UPS module cover

- Remove cover plate by removing the marked Torx screw (T10).

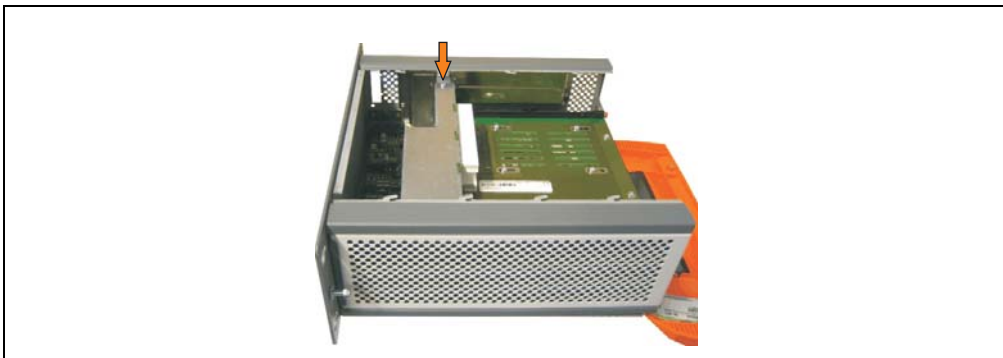

Figure 446: Remove cover plate

- Screw in spacing bolt (using M5 hex socket screwdriver).

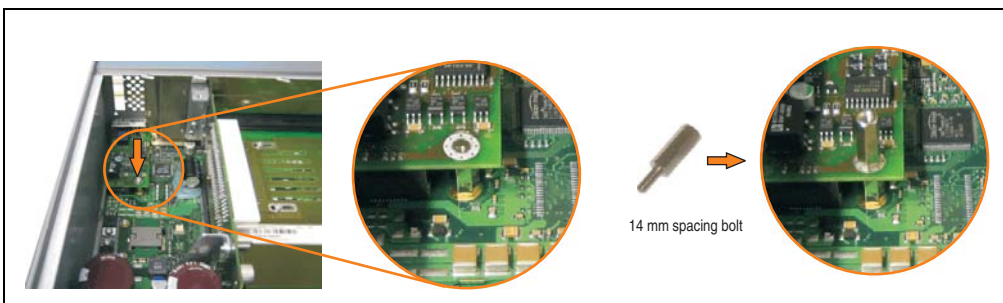

Figure 447: Screw in spacing bolt



- Install mounting bracket on UPS module using 2 Torx screws (T10).

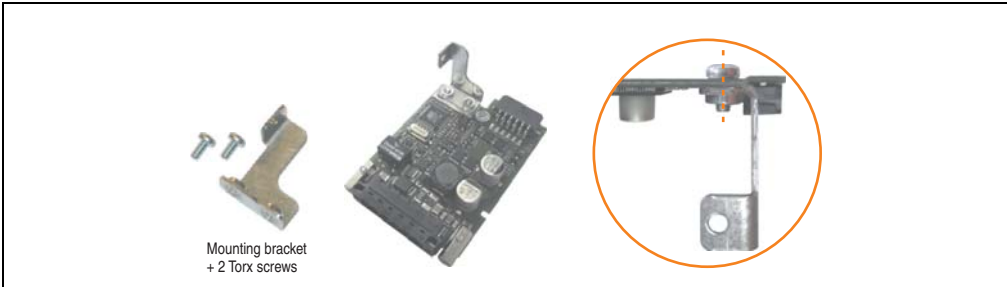

Figure 448: Install mounting bracket

- Install UPS module with 2 Torx screws (T10) and 1 Torx screw (T10). Use the previously removed Torx screws and one Torx screw from the mounting materials.

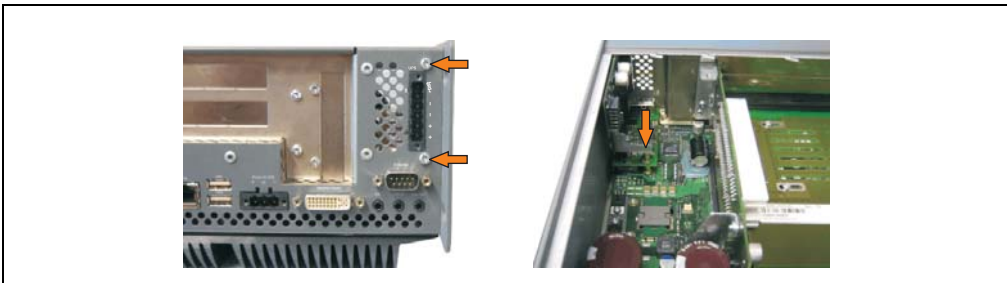

Figure 449: Install UPS module

- Plug in connection cable (see marked socket).

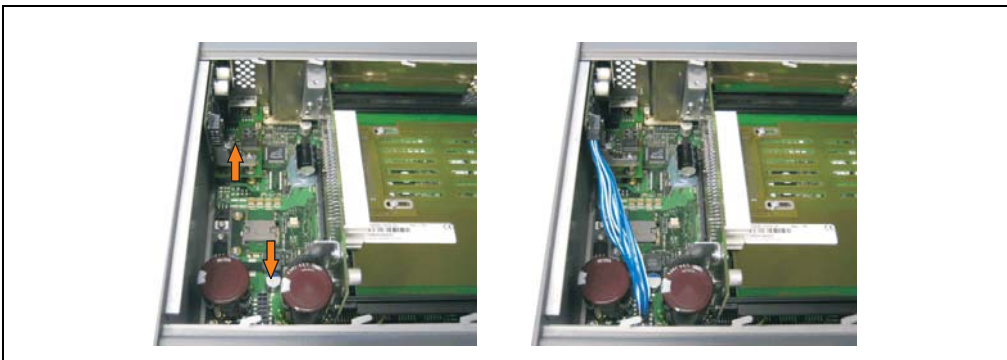

Figure 450: Plug in connection cable

## Information:

When connecting the cable, make sure that the connector locking mechanism is engaged.

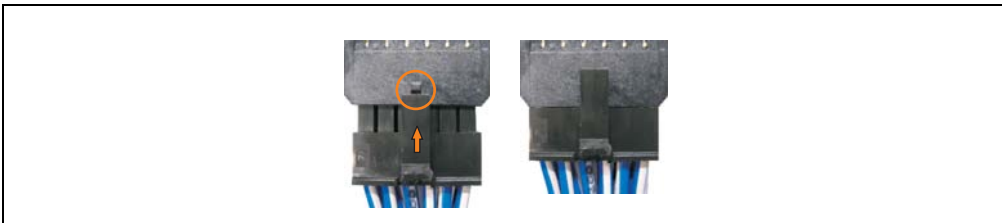

Figure 451: Connector locking mechanism

- Attach cover plate and side cover.

### 5.2.3 APC620, 5 PCI slot

- Remove side cover (see section 6 "Mounting the side cover", on page 781).
- Remove UPS module cover by removing the 2 marked Torx screws (using T10 screwdriver).

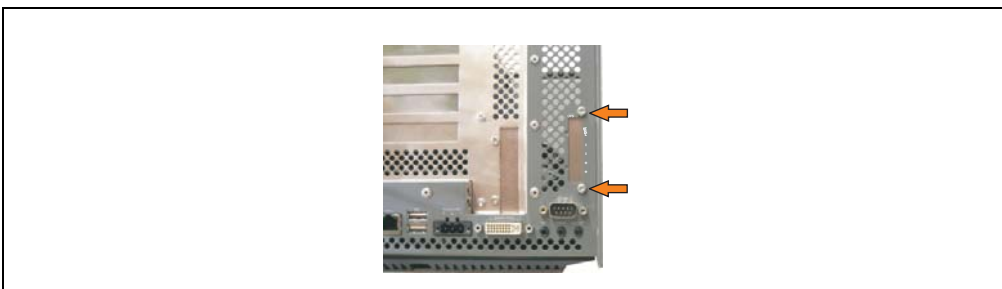

Figure 452: Remove UPS module cover

- Remove cover plate by removing the marked Torx screw (T10).

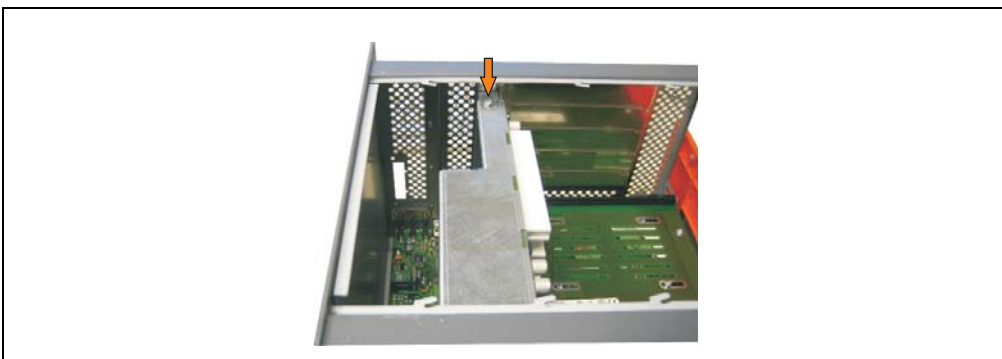

Figure 453: Remove cover plate

- Screw in spacing bolt (using M5 hex socket screwdriver).

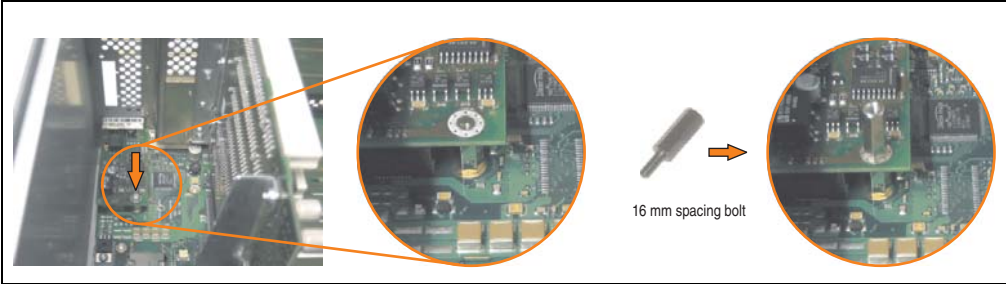

Figure 454: Screw in spacing bolt

- Install mounting bracket on UPS module using 2 Torx screws (T10).

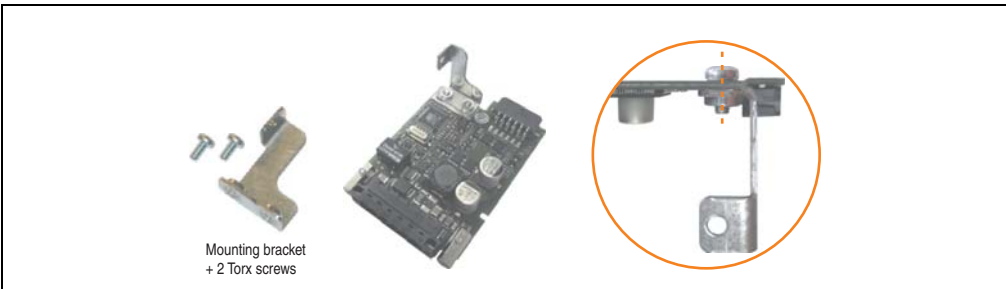

Figure 455: Install mounting bracket

- Install UPS module with 2 Torx screws (T10) and 1 Torx screw (T10). Use the previously removed Torx screws and one Torx screw from the mounting materials.

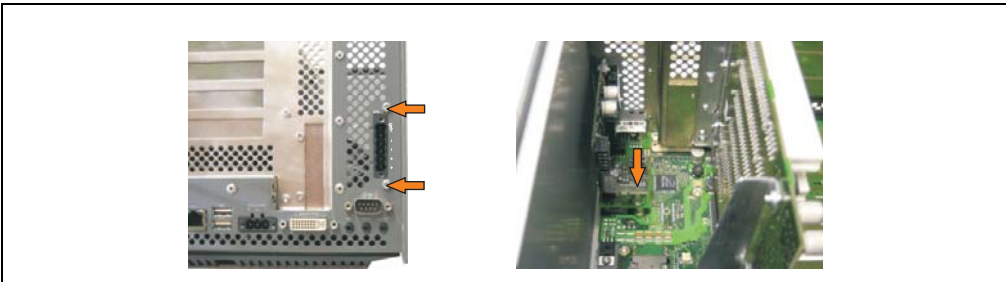

Figure 456: Install UPS module

- Plug in connection cable (see marked socket).

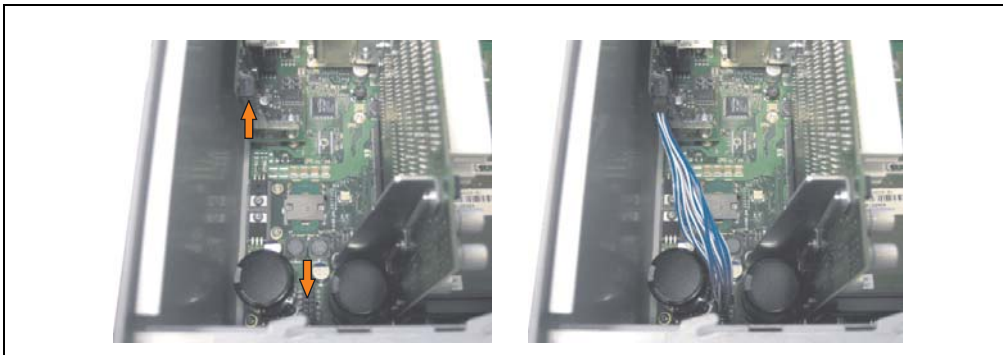

Figure 457: Plug in connection cable

## Information:

When connecting the cable, make sure that the connector locking mechanism is engaged.

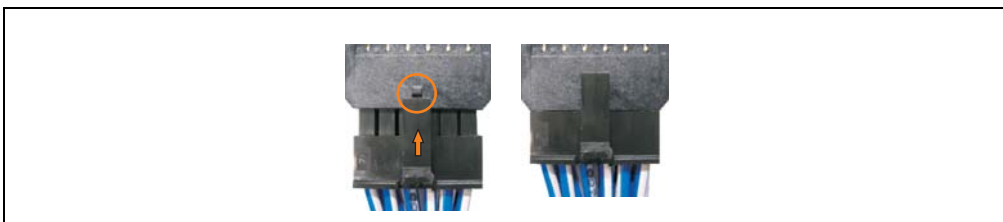

Figure 458: Connector locking mechanism

- Attach cover plate and side cover.

## 6. Mounting the side cover

The number of Torx (T10) screws varies depending on the system (1, 2, 3 or 5 PCI slots).

### 6.1 APC620 with 1 PCI slot

- Disconnect the power supply to the Automation PC 620.
- Touch the housing or ground connection (not the power supply!) in order to discharge any electrostatic charge from your body.
- Open the orange front cover. Behind the cover there are 3 Torx screws (T10) that must be removed.



Figure 459: Mounting the side cover - APC620, 1 PCI slot

- After the screws have been removed, the side cover can be removed by sliding it toward the front.

## 6.2 APC620 with 2 PCI slot

- Disconnect the power supply to the Automation PC 620.
- Touch the housing or ground connection (not the power supply!) in order to discharge any electrostatic charge from your body.
- Open the orange front cover. Behind the cover there are 5 Torx screws (T10) that must be removed.



Figure 460: Mounting the side cover - APC620, 2 PCI slot

- After the screws have been removed, the side cover can be removed by sliding it toward the front.

### 6.3 APC620 with 3 PCI slot

- Disconnect the power supply to the Automation PC 620.
- Touch the housing or ground connection (not the power supply!) in order to discharge any electrostatic charge from your body.
- Open the orange front cover. Behind the cover there are 7 Torx screws (T10) that must be removed.



Figure 461: Mounting the side cover - APC620, 3 PCI slot

- After the screws have been removed, the side cover can be removed by sliding it toward the front.

## 6.4 APC620 with 5 PCI slot

- Disconnect the power supply to the Automation PC 620.
- Touch the housing or ground connection (not the power supply!) in order to discharge any electrostatic charge from your body.
- Open the orange front cover. Behind the cover there are 7 Torx screws (T10) that must be removed.



Figure 462: Mounting the side cover - APC620, 5 PCI slot

- After the screws have been removed, the side cover can be removed by sliding it toward the front.



## 7. Exchanging a PCI SATA RAID hard disk

In the example, the assumption is made that the secondary hard disk (HDD1) is defective. In such a case, the defective hard disk can be replaced by the replacement drive SATA hard disk.

A size 10 Torx screwdriver is needed for exchanging the hard disk.

Exchange procedure

- Remove the power supply to the device (Automation PC 620 / Panel PC 700).
- Touch the housing or ground connection (not the power supply!) in order to discharge any electrostatic charge from your body.
- Remove the side cover.
- Remove the SATA RAID insert.
- Loosen the 4 appropriate mounting screws (M3x5) - see Figure 463 "Screw assignment on the back side of the SATA RAID controller", on page 785.

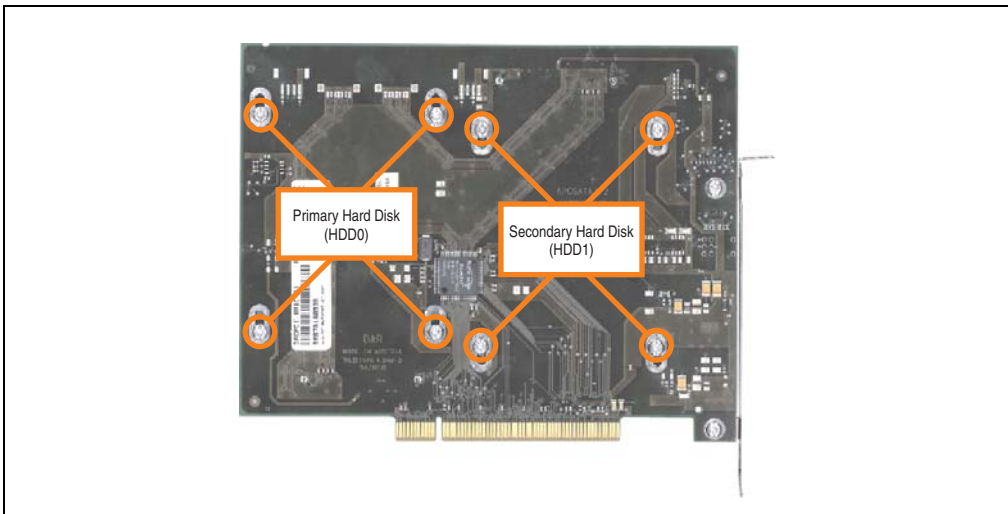

Figure 463: Screw assignment on the back side of the SATA RAID controller

- On the front side, slide the hard disk down and away (image 1).
- Carefully plug the new hard disk into the connector (image 2).

## Information:

When doing this, make sure that the hard disk is only touched on the front side, and not on the top side.

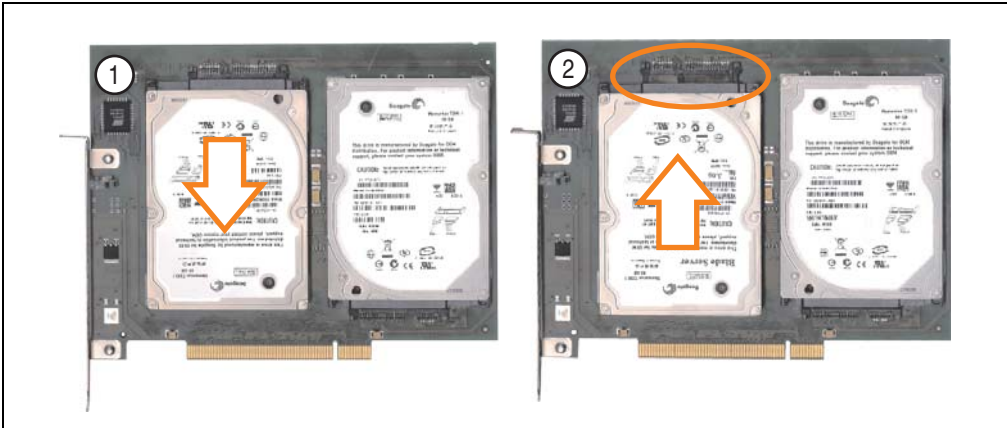

Figure 464: Hard disk exchange

- Re-secure the hard disk using the 4 fastening screws (M3x5) used earlier.
- Reassemble device in the reverse order.
- An error message is output by the RAID BIOS after starting the system "RAID1 set is in Critical status - press any key to enter Configuration Utility".

A rebuild must be executed in the SATA RAID BIOS - for more information on this, see the section "Rebuild mirrored set", on page 356.

## 8. Replacing the front cover

Depending on how the front cover is attached, the following points must be taken into consideration when replacing.

### 8.1 Variation A - Front cover screwed-in

- On the side of the APC620 there are Torx screws (T12) that must be removed (3, 4 or 6 screws, depending on the APC620 design). Pull the cover in the direction of the arrows, thereby pulling the hinge bar under the heat sink.



Figure 465: Removing the APC620 front cover

## Maintenance / Servicing • Replacing the front cover

- Slide the new hinge bar under the heat sink and screw it back on using the screws removed earlier.

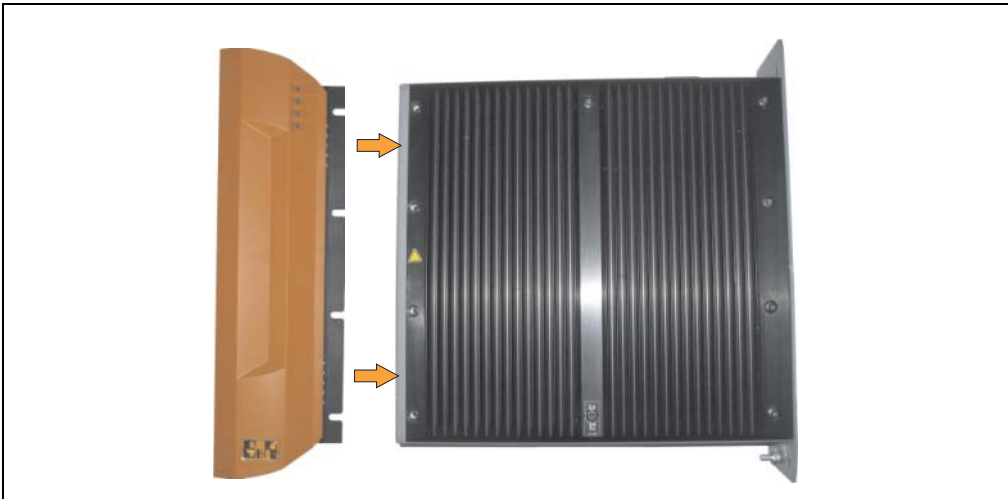

Figure 466: Mounting the APC620 front cover

## 8.2 Variation B - Front cover attached without screws

- A label on the side of the hinge bar "PULL TO REMOVE" indicates that the front cover is attached without screws.



Figure 467: APC620 front cover label

- Open the front cover approximately 1-2 cm. Now remove the cover by pulling it in the direction of the red arrow.



Figure 468: Removing the APC620 front cover

- Attach the new cover to the hinge bar from the side.

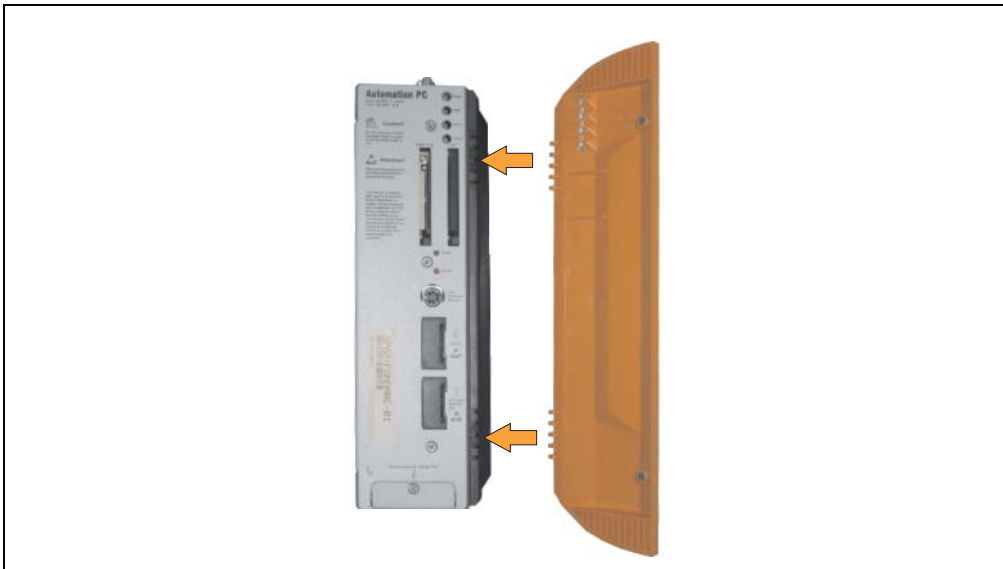

Figure 469: Attaching the front cover

# Appendix A

## 1. Temperature sensor locations

The APC620 has temperature sensors in various places (CPU, power supply, slide-in drive 1, slide-in drive 2, I/O). The temperatures<sup>1)</sup> can be read in BIOS (menu item "advanced" - baseboard/panel features - baseboard monitor) or in Microsoft Windows XP/Embedded, using B&R Control Center<sup>2)</sup>.

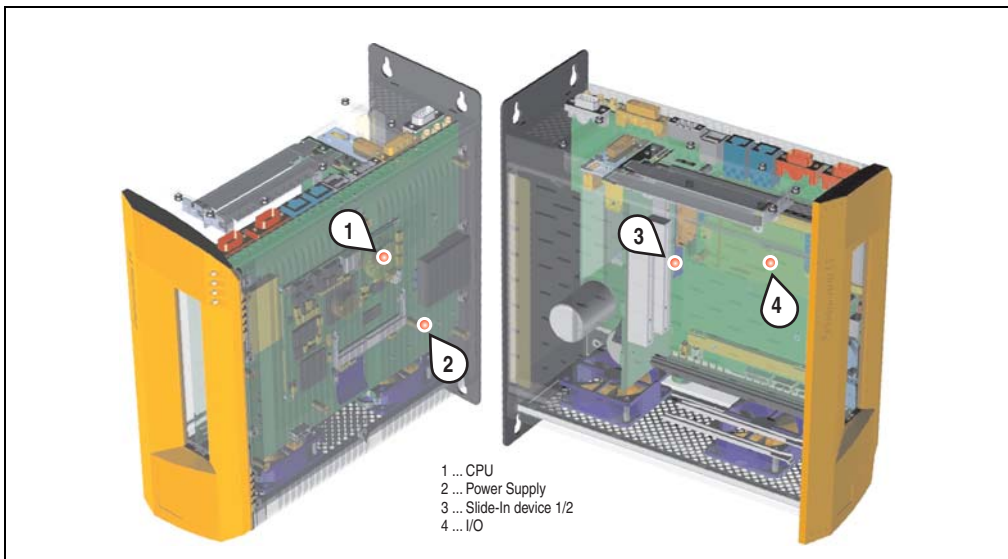

Figure 470: Temperature sensor locations

Position	Measurement point for	Measurement	Max. specified
1	CPU	Processor temperature (sensor integrated on the CPU board).	100°C
2	Power supply	Power supply temperature.	95°C
3	Slide-in drive 1/2	Temperature of a slide-in drive (the sensor is integrated on the slide-in drive)	Drive dependent
4	I/O	Temperature under an add-on drive.	80°C

Table 463: Temperature sensor locations

1) The measured temperature is a guideline for the immediate ambient temperature, but can be influenced by neighboring components.

2) The B&R Control Center - ADI driver - can be downloaded for free from the download area on the B&R homepage ([www.br-automation.com](http://www.br-automation.com)).

## 2. Connection of an external device to the main board

A plug on the main board enables branching of +5 VDC and +12 VDC for the internal supply of e.g. special PCI cards.

The connector is only provided starting with the following system unit revisions:

Model number	Short description	Starting with revision
5PC600.SX01-00	System 1 PCI	B7
5PC600.SX02-00	System 2 PCI, 1 disk drive slot, 1 AP Link slot	B0
5PC600.SX02-01	System 2 PCI, 1 disk drive slot	B9
5PC600.SX05-00	System 5 PCI, 2 disk drive slots, 1 AP Link slot	A0
5PC600.SX05-01	System 5 PCI, 2 disk drive slots	A0

Table 464: Revision information for connecting an external device

The voltage can be accessed using the "APC620 internal supply cable 5CAMSC.0001-00", on page 692. Depending on the system unit revision, the connector is located close to the fan connector. The APC620 side cover and possibly also the slide-in drive and PCI cards must be removed to reach the connector.

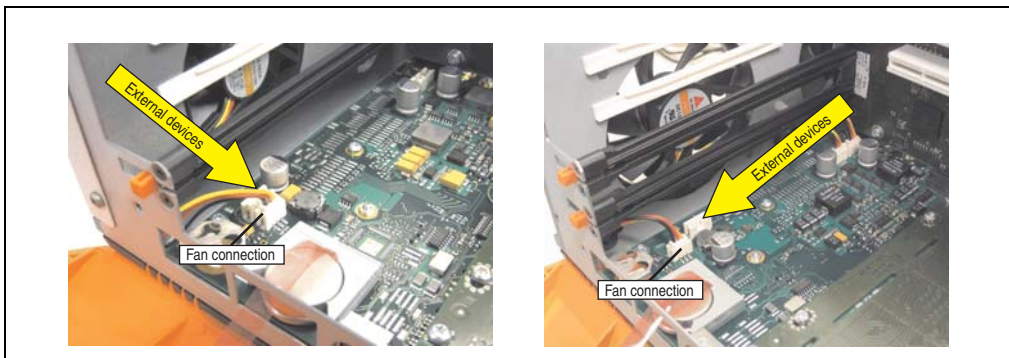

Figure 471: Connector location for external devices

Connector for the external devices			
<b>Pin</b>	<b>Assignment</b>	<b>Power</b>	4-pin connector, male  
1	+12 VDC	Max. 10 W	
2	GND		
3	GND	Max. 5 W	
4	+5 VDC		

Table 465: Pin assignments - Connector on main board

Connections are protected by a 1 A multi-fuse.



### 3. Maintenance Controller Extended (MTCX)

The MTCX controller (FPGA processor) is located on the main board (part of every system unit) of the APC620 device.

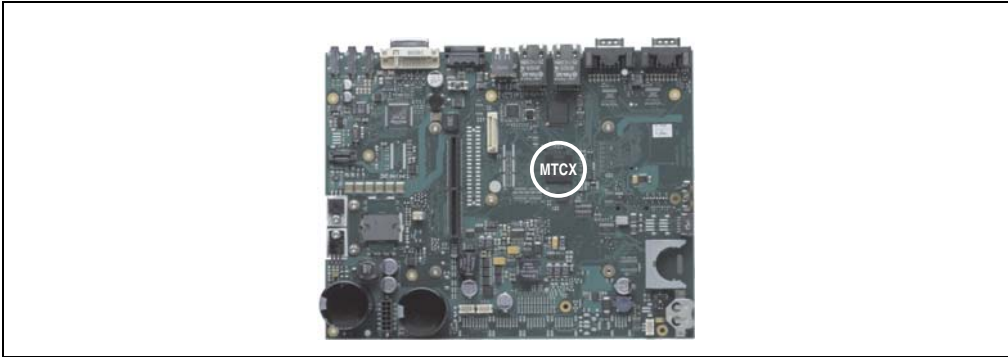

Figure 472: MTCX controller location

The MTCX is responsible for the following monitoring and control functions:

- Power on (power OK sequencing) and power fail logic
- Watchdog handling (NMI and reset handling)
- Temperature monitoring (I/O area, power supply, slide-in drive 1/2)
- Fan control (3 housing fans)
- Key handling / coordination (matrix keyboard on Automation Panel 900 devices configurable using B&R Key Editor, PS/2 keyboard)
- LED handling (matrix keyboard with LEDs on Automation Panel 900 devices configurable using B&R Key Editor)
- Advanced desktop operation (keys, USB forwarding)
- Daisy chain display operation (touch screen, USB forwarding)
- Panel locking mechanism (configurable using B&R Control Center - ADI driver)
- Backlight control for a connected B&R display
- Statistical data recording (power cycles - each power on, power on and fan hours are recorded - every full hour is counted e.g. 50 minutes no increase)
- SDL data transfer (display, matrix keyboard, touch screen, service data, USB)
- Status LEDs (HDD, panel lock, Link 1, Link 2)

The functions of the MTCX can be expanded via Firmware upgrade<sup>1)</sup>. The version can be read in BIOS (menu item "advanced" - baseboard/panel features) or in Microsoft Windows XP/embedded, using B&R Control Center.

1) Can be downloaded from the download area on the B&R homepage ([www.br-automation.com](http://www.br-automation.com)).

### 3.1 SDL timing

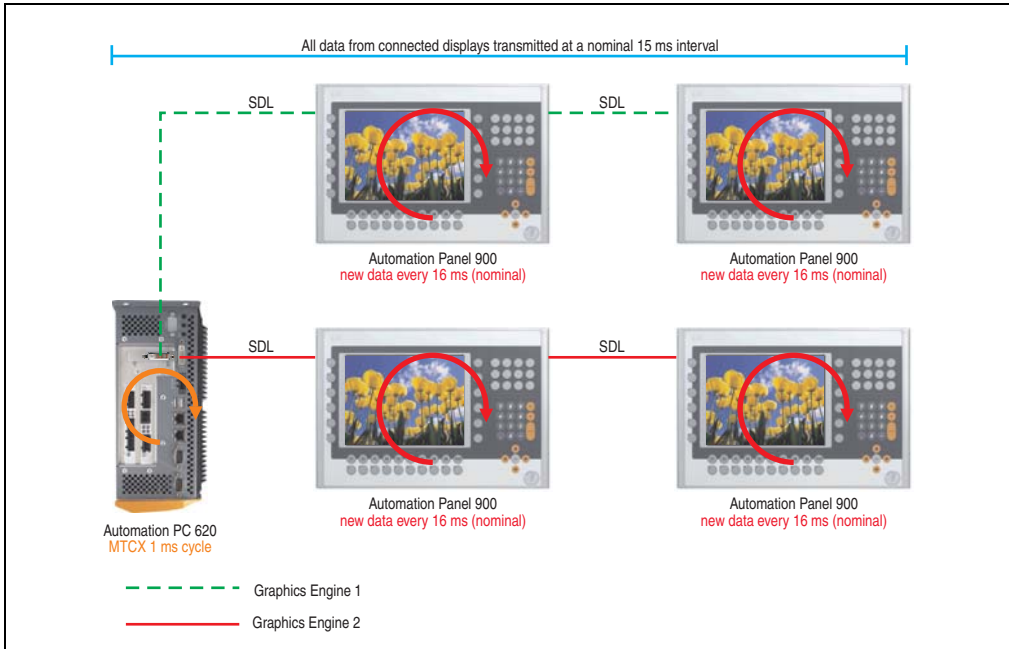

Figure 473: Sample configuration for SDL timing

Basic procedure:

- 1) On every Automation Panel 900 display unit, the data (button and LED, touch screen, service data) is nominally determined asynchronously every 16 ms, saved and made available.
- 2) The MTCX in the APC620 samples one display unit after another asynchronously in 1 ms increments. The status is requested within the 15 ms nominal cycle (maximum 15 display units x 1 ms), regardless of the total number of display units connected in the system (Graphics Engine 1 + Graphics Engine 2), and the information is saved in the MTCX's Dual-Ported RAM.
- 3) An application can access the MTCX data using the programming interface (API) ADI (Automation Device Interface). Reading or writing data does not affect the asynchronous acquisition of data from the connected display units.  
Further information about this can be found in the "ADI Development Kit" and the "Automation PC 620 / Panel PC 700 Implementation Guide" (both available on the B&R Homepage).

## Caution!

Due to safety requirements regulated by international standards, implementing an E-stop element via SDL (using Matrix) is NOT allowed. Instead, such an element must be wired according to the safety requirements.

## Information:

Display data will not be updated and cannot be read by the MTCX while a display unit is in upgrade mode (e.g. SDL firmware upgrade).

The nominal time specifications are not guaranteed maximum lengths of time, but may be increased due to e.g. transfer disturbances and external influences.

### Schematic diagram

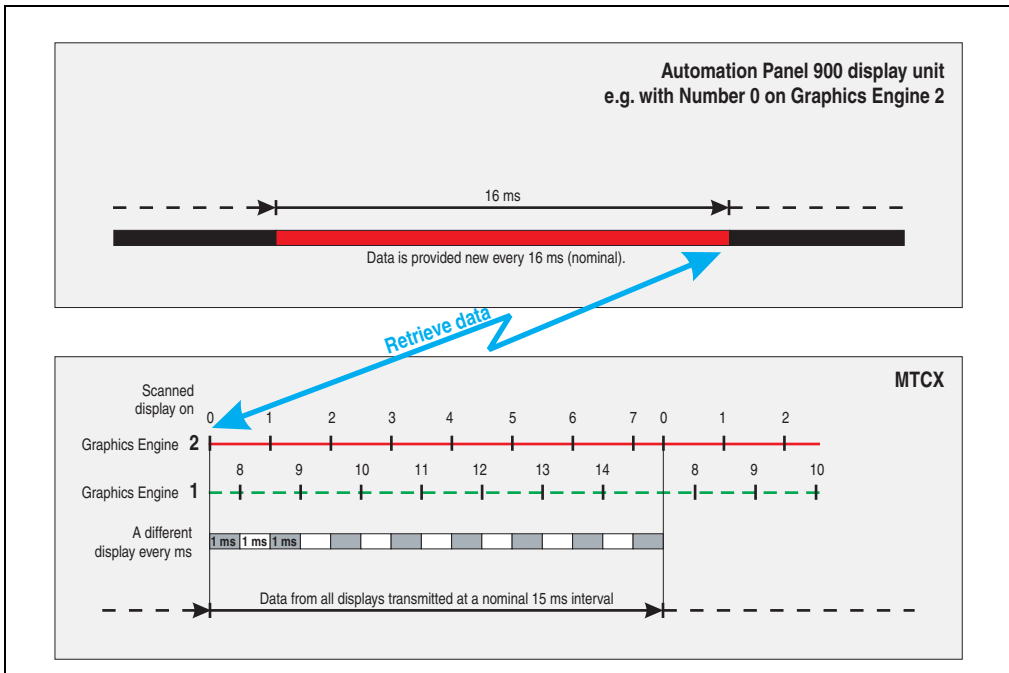

Figure 474: SDL timing - Example for Automation Panel 900 with the number 0

### 3.2 Temperature monitoring - Fan control

The MTCX constantly monitors the temperature using temperature sensors (see section 1 "Temperature sensor locations", on page 791), which directly determine how the fan is controlled. The RPM depends on the temperature measured. The limit values depend on the MTCX firmware version being used.

Sensor range	Start-up temperature	Max fan speed at:
CPU	39°C	55°C
Power supply	39°C	55°C
Slide-in drive 1/2	39°C	55°C
I/O	39°C	55°C

Table 466: Temperature limits for fan control

The fans stop again when the temperature drops below 37°C.

## 4. B&R Key Editor information

On display units, it is often necessary to adjust the function keys and LEDs for the application software being used. The B&R Key Editor makes it quick and easy to adapt the application to a unique configuration.

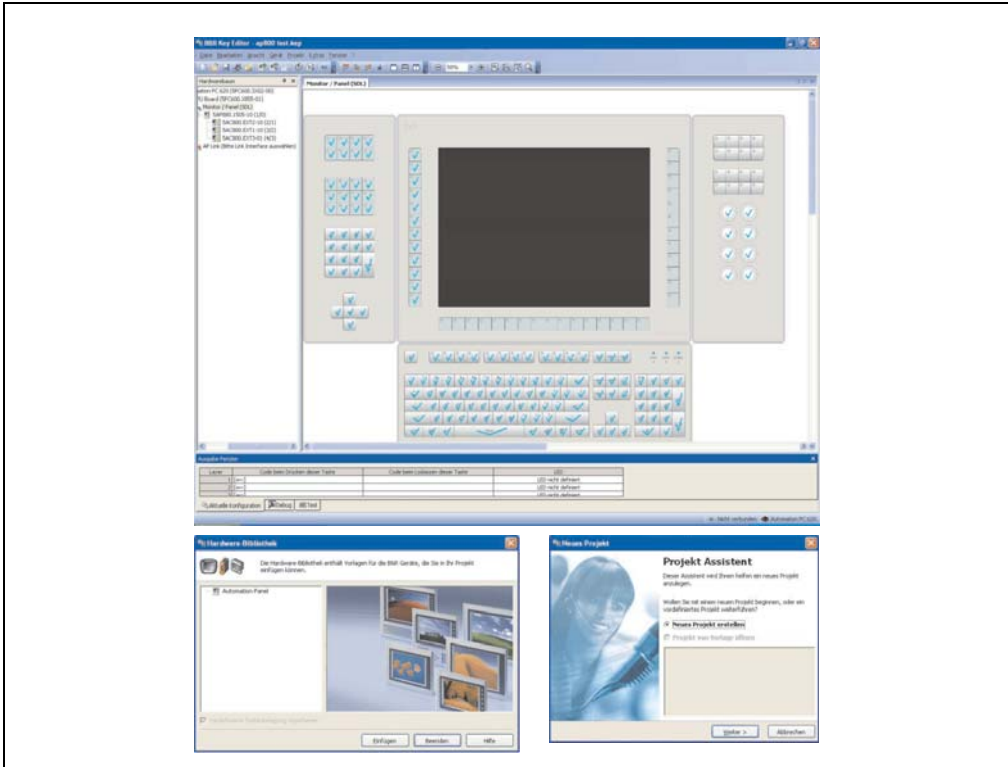

Figure 475: B&R Key Editor screenshots Version 3.10 (representation picture)

Features:

- Configuration of normal keys like on a keyboard (A, B, C, etc.)
- Keyboard shortcuts (CTRL+C, SHIFT+DEL, etc.) on one key
- Special key functions (change brightness, etc.)
- Assign functions to LEDs (HDD access, power, etc.)
- 4 assignments per key possible (using layer function)
- Configuration of panel locking time when multiple Automation Panel 900 devices are connected to Automation PCs and Panel PCs devices.

Supports following systems (Version 3.10):

- Automation PC 620
- Automation PC 810
- Automation PC 820
- Automation Panel 800
- Automation Panel 900
- IPC2000, IPC2001, IPC2002
- IPC5000, IPC5600
- IPC5000C, IPC5600C
- Mobile Panel 40/50
- Mobile Panel 100/200
- Panel PC 300
- Panel PC 700
- Panel PC 800
- Power Panel 100/200
- Power Panel 300/400
- Power Panel 500 (the Key Editor device file must be downloaded separately from the B&R homepage)

A detailed guide for configuring keys and LEDs can be found in the B&R Key Editor's online help.

The B&R Key Editor can be downloaded for free from the download area on the B&R homepage ([www.br-automation.com](http://www.br-automation.com)). Additionally, it can also be found on the B&R HMI Drivers & Utilities DVD (model number 5SWHMI.0000-00).

## 5. B&R Automation Device Interface (ADI) development kit

This software can be used to activate functions of the B&R Automation Device Interface (ADI) from Windows applications, which, for example, were created using the following development tools:

- Microsoft Visual C++ 6.0
- Microsoft Visual Basic 6.0
- Microsoft eMbedded Visual C++ 4.0
- Microsoft Visual Studio 2005 (or newer)

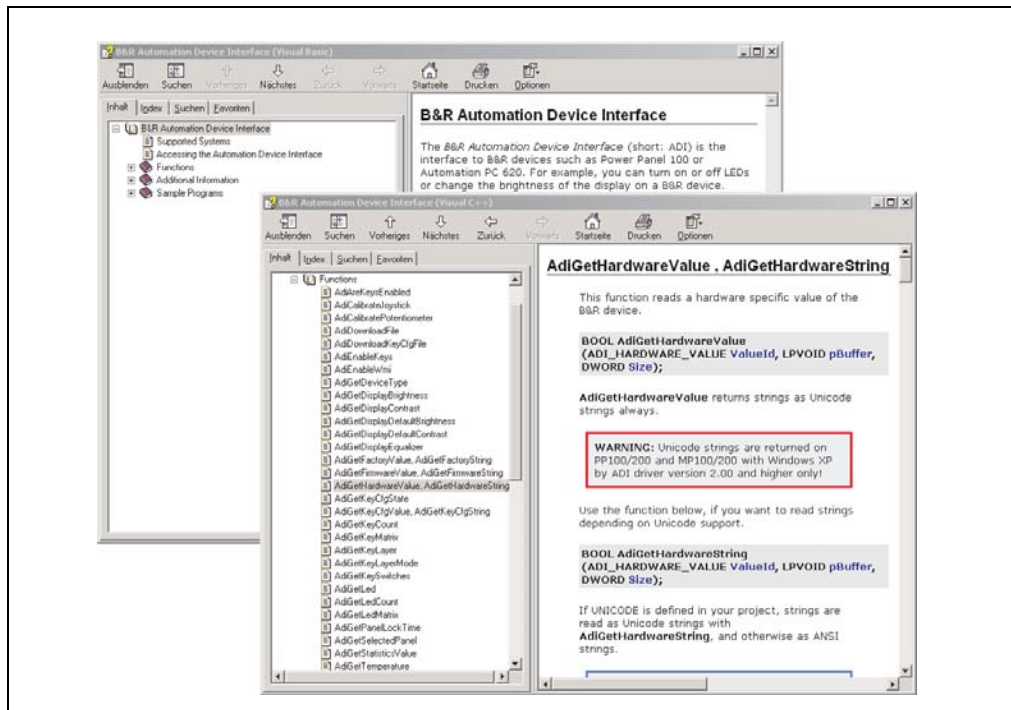

Figure 476: ADI development kit screenshots (Version 3.10)

Features:

- One Microsoft Visual Basic module with declarations for the ADI functions.
- Header files and import libraries for Microsoft Visual C++.
- Help files for Visual Basic and Visual C++.
- Sample projects for Visual Basic and Visual C++.
- ADI DLL (for testing the applications, if no ADI driver is installed).

Supports following systems (Version 3.10 and higher):

- Automation PC 620
- Automation PC 810
- Automation PC 820
- Mobile Panel 40/50
- Mobile Panel 100/200
- Panel PC 300
- Panel PC 700
- Panel PC 800
- Power Panel 100/200
- Power Panel 300/400
- Power Panel 500

The ADI driver suitable for the device must be installed on the stated product series. The ADI driver is already included in the B&R images of embedded operating systems.

A detailed description of using the ADI functions can be found in the integrated online help.

The B&R Automation Device Interface (ADI) development kit can be downloaded for free from the download area on the B&R homepage ([www.br-automation.com](http://www.br-automation.com)).



## 6. B&R Automation Device Interface (ADI) .NET SDK

This software can be used to activate functions of the B&R Automation Device Interface (ADI) from .NET applications, which were created using Microsoft Visual Studio 2005 (or newer).

Supported programming languages:

- Visual Basic
- Visual C++
- Visual C#
- Visual J#

System requirements:

- Development system: PC with Windows XP/7 with
  - Microsoft Visual Studio 2005 or newer
  - Microsoft .NET Framework 2.0 and / or Microsoft .NET Compact Framework 2.0 or newer

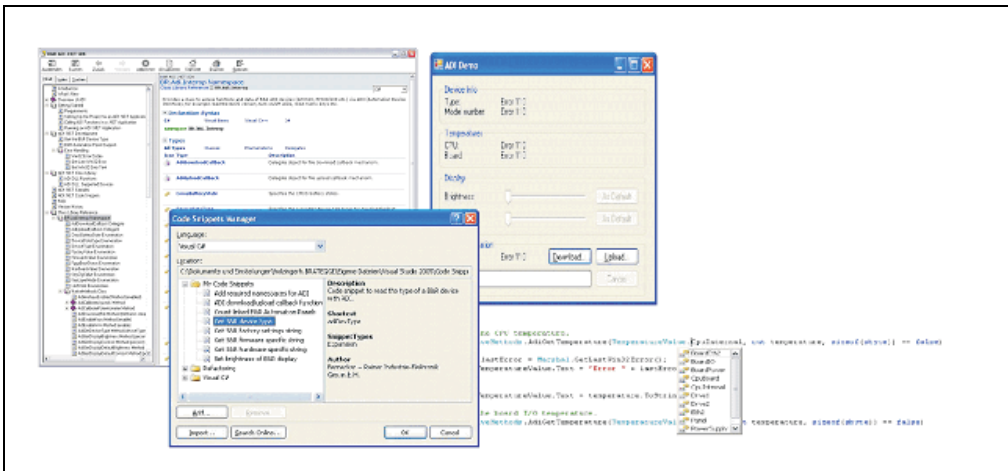

Figure 477: ADI .NET SDK Screenshots (Version 1.50)

Features:

- ADI .NET Class Library.
- Help files in HTML Help 1.0 format (.chm file) and MS Help 2.0 format (.HxS file).
- Sample projects and code snippets for Visual Basic, Visual C++, Visual C# and Visual J#.
- ADI DLL (for testing the applications, if no ADI driver is installed).

Supports following systems (Version 1.50 and higher):

- Automation PC 620
- Automation PC 810
- Automation PC 820
- Mobile Panel 40/50
- Mobile Panel 100/200
- Panel PC 300
- Panel PC 700
- Panel PC 800
- Power Panel 100/200
- Power Panel 300/400
- Power Panel 500

The ADI driver suitable for the device must be installed on the stated product series. The ADI driver is already included in the B&R images of embedded operating systems.

A detailed description of using the ADI functions can be found in the integrated online help.

The ADI .NET SDK can be downloaded for free from the download area on the B&R homepage ([www.br-automation.com](http://www.br-automation.com)).

## 7. Glossary

### A

#### ACPI

Abbreviation for "**A**dvanced **C**onfiguration and **P**ower **I**nterface". Configuration interface that enables the operating system to control the power supply for each device connected to the PC. With ACPI, the computer's BIOS is only responsible for the details of communication with the hardware.

#### APC

An abbreviation for "**A**utomation **P**C".

#### API

Abbreviation for "**A**pplication **P**rogram **I**nterface" The interface, which allows applications to communicate with other applications or with the operating system.

#### Automation Runtime

A uniform runtime system for all B&R automation components.

### B

#### Baud rate

Measurement unit for data transfer speed. It indicates the number of states for a transferred signal per second and is measured using the baud unit of measurement. 1 baud = 1 bit/sec or 1 bps.

#### BIOS

An abbreviation for "**B**asic **I**nput/**O**utput **S**ystem". Core software for computer systems with essential routines for controlling input and output processes on hardware components, for performing tests after system start and for loading the operating system. Although BIOS is used to configure a system's performance, the user does not usually come into contact with it.

#### Bit

Binary digit > binary position, binary character, smallest discrete unit of information. A bit can have the value 0 or 1.

#### Bit rate

The number of bits that can be transferred within a specified time unit. 1 bit/sec = 1 baud.

### Bootstrap loader

A program that automatically runs when the computer is switched on or restarted. After some basic hardware tests have been carried out, the bootstrap loader starts a larger loader and hands over control to it, which in turn boots the operating system. The bootstrap loader is typically found in ROM on the computer.

### Byte

Data format [1 byte = 8 bits] and a unit for characterizing information amounts and memory capacity. The following units are the commonly used units of progression: KB, MB, GB.

### B&R Automation Runtime

Windows-based program for creating installation disks to install B&R Automation Runtime™ on the target system.

## C

### Cache

Background memory, also known as non-addressable memory or fast buffer memory. It is used to relieve the fast main memory of a computer. For example, data that should be output to slower components by the working memory (e.g. disk storage, printers) is stored temporarily in cache memory and output from there at an appropriate speed for the target devices.

### CAN

An abbreviation for "**C**ontroller **A**rea **N**etwork" (serial bus system). Structure according to ISO 11898; Bus medium: twisted pair. Good transfer properties in short distances less than 40 m with a 1 MBit/sec data transfer rate. Maximum number of stations: Theoretically unlimited, but practically limited up to 64. Real-time capable (i.e. defined maximum latency times for messages with high priority). High reliability using error detection, error handling, troubleshooting. Hamming distance.

### CD-ROM

Abbreviation for "**C**ompact **D**isc **R**ead-**O**nly **M**emory". A removable data medium with a capacity of ~700 MB. CD-ROMs are optically scanned.

### CE mark

A CE mark for a product. It consists of the letters "CE" and indicates conformity to all EU guidelines for the labeled product. It indicates that the individual or corporate body who has performed or attached the label assures that the product conforms to all EU guidelines for complete harmonization. It also indicates that all mandatory conformity evaluation procedures have taken place.

## CMOS

"CMOS" is a battery powered memory area where fundamental parameters of an IBM (or compatible) personal computer are stored. Information such as the type of hard drive, size of the working memory and the current date and time are required when booting the computer. As the name suggests, the memory is based on CMOS technology standards.

## COM

A device name used to access serial ports in MS-DOS. The first serial port can be accessed under COM1, the second under COM2, etc. A modem, mouse, or serial printer is typically connected to a serial port.

## COM1

Device name for the first serial port in a PC system. The input/output area for COM1 is usually found at address 03F8H. Generally, the COM1 port is assigned to IRQ 4. In many systems, an RS232 serial mouse is connected to COM1.

## COM2

Device name for the second serial port in a PC system. The input/output area for COM2 is usually found at address 02F8H. Generally, the COM2 port is assigned to IRQ 3. In many systems, a modem is connected to COM2.

## COM3

Device name for a serial port in a PC system. The input/output area for COM3 is usually found at address 03E8H. Generally, the COM3 port is assigned to IRQ 4. In many systems, COM3 is used as an alternative for COM1 or COM2 if peripheral devices are already connected to COM1 and COM2.

## CompactFlash®

CompactFlash memory cards [CF cards] are exchangeable nonvolatile mass memory systems with very small dimensions [43 x 36 x 3.3 mm, approximately half the size of a credit card]. In addition to the flash memory chips, the controller is also present on the cards. CF cards provide complete PC card / ATA functionality and compatibility. A 50-pin CF card can be simply inserted in a passive 68-pin type II adapter card. It conforms to all electrical and mechanical PC card interface specifications. CF cards were launched by SanDisk back in 1994. Currently, memory capacities reach up to 8 GB per unit. Since 1995, CompactFlash Association [CFA] has been looking after standardization and the worldwide distribution of CF technology

## CPU

An abbreviation for "**C**entral **P**rocessing **U**nit". Interprets and executes commands. It is also known as a "microprocessor" or "processor" for short. A processor is able to receive, decode and execute commands, as well as transfer information to and from other resources via the computer bus.

### CTS

An abbreviation for "**C**lear **T**o **S**end". A signal used when transferring serial data from modem to computer, indicating its readiness to send the data. CTS is a hardware signal which is transferred via line number 5 in compliance with the RS-232-C standard.

## D

### DCD

An abbreviation for "**D**ata **C**arrier **D**etected". A signal used in serial communication that is sent by the modem to the computer it is connected to, indicating that it is ready for transfer.

### Dial-up

Data is transferred over the telephone network using a modem or an ISDN adapter.

### DIMM

"Double In-line Memory Module" consisting of one or more RAM chips on a small circuit board that is connected with the motherboard of a computer.

### DMA

**D**irect **M**emory **A**ccess > Accelerated direct access to a computer's RAM by bypassing the CPU.

### DRAM

An abbreviation for "**D**ynamic **R**andom **A**ccess **M**emory". Dynamic RAM consists of an integrated semiconductor circuit that stores information based on the capacitor principle. Capacitors lose their charge in a relatively short time. Therefore, dynamic RAM circuit boards must contain a logic that allows continual recharging of RAM chips. Since the processor cannot access dynamic RAM while it is being recharged, one or more waiting states can occur when reading or writing data. Although it is slower, dynamic RAM is used more often than static RAM since the simple design of the circuits means that it can store four times more data than static RAM.

### DSR

An abbreviation for "**D**ata **S**et **R**eady". A signal used in serial data transfer, which is sent by the modem to the computer it is connected to, indicating its readiness for processing. DSR is a hardware signal which is sent via line number 6 in compliance with the RS-232-C standard.

### DTR

An abbreviation for "**D**ata **T**erminal **R**eady". A signal used in serial data transfer that is sent by the computer to the modem it is connected to, indicating the computer's readiness to accept incoming signals.

## DVD

An abbreviation for "**D**igital **V**ersatile **D**isc". The next generation of optical data carrier technology is able to store a higher volume of data than conventional CDs. Standard DVDs, which have a single layer, can hold 4.7 GB. Dual-layer DVDs can hold 8.5 GB. Double-sided DVDs can therefore hold up to 17 GB. A special drive is needed for DVDs. Conventional CDs can also be played on DVD drives.

## DVI

Abbreviation for "**D**igital **V**isual **I**nterface" An interface for the digital transfer of video data.

## DVI-A

Analog only

## DVI-D

Digital only

## DVI-I

Integrated, i.e. analog and digital

**E**

## EDID data

Abbreviation for "**E**xtended **D**isplay **I**dentification **D**ata". EDID data contains the characteristics of monitors / TFT displays transferred as 128 KB data blocks to the graphics card via the Display Data Channel (DDC). This EDID data can be used to set the graphics card to the monitor properties.

## EIDE

An abbreviation for "**E**nhanced **I**ntegrated **D**rive **E**lectronics". An expansion of the IDE standard. Enhanced IDE is considered the standard for hardware interfaces. This interface is designed for drives with an integrated drive controller.

## EMC

"**E**lectromagnetic **C**ompatibility" The ability of a device or a system to function satisfactorily in its electromagnetic environment without introducing intolerable electromagnetic disturbances to anything in that environment [IEV 161-01-07].

## EPROM

Erasable **P**ROM > (completely with ultraviolet light).

### Ethernet

An IEEE 802.3 standard for networks. Ethernet uses bus or star topology and controls the traffic on communication lines using the access procedure CSMA/CD (Carrier Sense Multiple Access with Collision Detection). Network nodes are connected using coaxial cables, fiber optic cables or twisted pair cabling. Data transfer on an Ethernet network takes place in frames of variable lengths that consist of supply and controller information as well as 1500 bytes of data. The Ethernet standard provides base band transfers at 10 megabit and 100 megabit per second.

### ETX

Abbreviation for "**E**Embedded **T**Technology **eX**extended". This established standard offers complete PC functionality on a very compact form factor of just 114 mm x 100 mm (.45" x .4"). The flexibility offered by ETX® in the development of system specific main boards allows easy requirement fulfillment in a number of different applications.

## F

### FDD

Abbreviation for "**F**loppy **D**isk **D**rive". Reading device for removable magnetic memory from the early days of PC technology. Due to their sensitivity and moving components, FDDs have been almost completely replaced by CompactFlash memory in modern automation solutions.

### Fiber optics

### Fiber optic cable

### FIFO

An abbreviation for "**F**irst **I**n **F**irst **O**ut". A queuing organization method whereby elements are removed in the same order as they were inserted. The first element inserted is the first one removed. Such an organization method is typical for a list of documents that are waiting to be printed.

### Firmware

Programs stored permanently in read-only memory. Firmware is software used to operate computer-controlled devices that generally stays in the device throughout its lifespan or over a long period of time. Such software includes operating systems for CPUs and application programs for industrial PCs as well as programmable logic controllers (e.g. the software in a washing machine controller). This software is written in read-only memory (ROM, PROM, EPROM) and cannot be easily replaced.

### Floppy

Also known as a diskette. A round plastic disk with an iron oxide coating that can store a magnetic field. When the floppy disk is inserted in a disk drive, it rotates so that the different areas (or sectors) of the disk's surface are moved under the read/write head. This allows the magnetic orientation of the particle to be modified and recorded. Orientation in one direction represents binary 1, while the reverse orientation represents binary 0.



## FPC

An abbreviation for "**F**lat **P**anel **C**ontroller".

## FPD

An abbreviation for "**F**lat **P**anel **D**isplay".

## FTP

"**F**ile **T**ransfer **P**rotocol" Rules for transferring data over a network from one computer to another computer. This protocol is based on TCP/IP, which has established itself as the standard for transferring data over Ethernet networks. FTP is one of the most used protocols on the Internet. It is defined in RFC 959 in the official regulations for Internet communication.

## G

## GB

Gigabyte (1 GB = 230 or 1,073,741,824 Bytes)

## H

## Handshake

Method of synchronization for data transfer when data is sent at irregular intervals. The sender signals that data can be sent, and the receiver signals when new data can be received.

## HDD

An abbreviation for "**H**ard **D**isk **D**rive". Fixed magnetic mass memory with high capacities, e.g. 120 GB.

## I

## IDE

An abbreviation for "**I**ntegrated **D**rive **E**lectronics". A drive interface where the controller electronics are integrated in the drive.

## ISA

An abbreviation for "**I**ndustry **S**tandard **A**rchitecture". A term given for the bus design which allows expansion of the system with plug-in cards that can be inserted in PC expansion slots.

## ISO

International Organization for Standardization > Worldwide federation of national standardization institutions from over 130 countries. ISO is not an acronym for the name of the organization; it is derived from the Greek word "isos", meaning "equal" ([www.iso.ch](http://www.iso.ch)).

### J

#### Jitter

Jitter is a term that describes time deviations of cyclic events. If, for example, an event should take place every 200is and it actually occurs every 198 to 203is, then the jitter is 5is. Jitter has many causes. It originates in the components and transfer media of networks because of noise, crosstalk, electromagnetic interference and many other random occurrences. In automation technology, jitter is a measure of the quality of synchronization and timing.

#### Jumper

A small plug or wire link for adapting the hardware configuration used to connect the different points of an electronic circuit.

### L

#### LCD

An abbreviation for "**L**iquid **C**rystal **D**isplay". A display type, based on liquid crystals that have a polarized molecular structure and are enclosed between two transparent electrodes as a thin layer. If an electrical field is applied to the electrodes, the molecules align themselves with the field and form crystalline arrangements that polarize the light passing through. A polarization filter, which is arranged using lamellar electrodes, blocks the polarized light. In this way, a cell (pixel) containing liquid crystals can be switched on using electrode gates, thus coloring this pixel black. Some LCD displays have an electroluminescent plate behind the LCD screen for lighting. Other types of LCD displays can use color.

#### LED

An abbreviation for "**L**ight **E**mitting **D**iode". A semiconductor diode which converts electrical energy into light. LEDs work on the principle of electroluminescence. They are highly efficient because they do not produce much heat in spite of the amount of light they emit. For example, "operational status indicators" on floppy disk drives are LEDs.

#### LPT

Logical device name for line printers. In MS-DOS, names are reserved for up to three parallel printer ports with the names LPT1, LPT2 and LPT3. The first parallel port (LPT1) is usually identical to the primary parallel output device PRN (in MS-DOS the logical device name for the printer). The abbreviation LPT stands for "Line Printer Terminal".

### M

#### MB

Megabyte (1 MB = 220 or 1,048,576 bytes).

**Microprocessor**

Highly integrated circuit with the functionality of a CPU, normally housed on a single chip. It comprises a control unit, arithmetic and logic unit, several registers and a link system for connecting memory and peripheral components. The main performance features are the internal and external data bus and address bus widths, the command set and the clock frequency. Additionally, a choice can be made between CISC and RISC processors. The first commercially available worldwide microprocessor was the Intel 4004. It came on the market in 1971.

**MIPS**

Million instructions per second > Measurement for the computing speed of computers.

**Motherboard**

A circuit board that houses the main components of a computer such as the CPU switching circuit, co-processors, RAM, ROM for firmware, interface circuits, and expansion slots for hardware expansions.

**MTBF**

An abbreviation for "**Mean time between failure**". The average time which passes before a hardware component fails and repair is needed. This time is usually expressed in thousands or ten thousands of hours, sometimes known as power-on hours (POH).

**MTCX**

An abbreviation for »**Maintenance Controller EXtended**«. The MTCX is an independent processor system that provides additional functions for a B&R industrial PC that are not available with a normal PC. The MTC communicates with the B&R industrial PC via the ISA bus (using a couple register).

**Multitasking**

Multitasking is an operating mode in an operating system that allows several computer tasks to be executed virtually simultaneously.

**0****OEM**

"**Original Equipment Manufacturer**"; A company that integrates third-party and in-house manufactured components into their own product range and then distributes these products under its own name.

**OPC**

OLE for Process Control > A communication standard for components in the area of automation. The goal of OPC development is to provide an open interface that builds on Windows-based technologies such as OLE, COM and DCOM. It allows problem-free standardized data transfer between controllers, operating and monitoring systems, field devices and office applications from different manufacturers. This development is promoted by the OPC Foundation, which is

made up of over 200 companies from around the world, including Microsoft and other leading companies. Nowadays, OPC is also interpreted as a synonym for Openness, Productivity and Connectivity, symbolizing the new possibilities that this standard opens up.

OPC server

The missing link between connection modules for the Interbus and the visualization application. It communicates serially with the connection modules via the ISA or PCI bus or Ethernet.

### P

Panel

A common term for B&R display units (with or without keys).

PCI Bus

Abbreviation for "**P**eripheral **C**omponent **I**nterconnect bus". Developed by Intel as an intermediary/local bus for the latest PC generations. It is basically a synchronous bus. The main clock of the CPU is used for synchronization. The PCI bus is microprocessor-independent, 32-bit and 64-bit compatible, and supports both 3.3 V and 5 V cards and devices.

PCMCIA

An abbreviation for "**P**ersonal **C**omputer **M**emory **C**ard **I**nternational **A**ssociation". An association of manufacturers and dealers who are dedicated to the cultivation and further development of common standards for peripheral devices based on PC cards with a slot for such cards. PC cards are mainly used for laptops, palmtops (and other portable computers), and intelligent electronic devices. Version 1 of the PCMCIA standard was introduced in 1990.

PLC

Programmable Logic Controller; Computer-based control device that functions using an application program. The application program is relatively easy to create using standardized programming languages [IL, FBD, LAD, AS, ST]. Because of its serial functionality, reaction times are slower compared to connection-oriented control. Today, PLCs are available in device families with matched modular components for all levels of an automation hierarchy.

PnP

An abbreviation for "**P**lug and **P**lay". Specifications developed by Intel. Using Plug and Play allows a PC to automatically configure itself so that it can communicate with peripheral devices (e.g. monitors, modems, and printers). Users can connect a peripheral device (plug) and it immediately runs (play) without having to manually configure the system. A Plug and Play PC requires a BIOS that supports Plug and Play and a respective expansion card.

POH

An abbreviation for "**P**ower **O**n **H**ours". See MTBF.

## POST

An abbreviation for "**Power-On Self Test**". A set of routines that are stored in ROM on the computer and that test different system components, e.g. RAM, disk drive and the keyboard in order to determine that the connection is operating correctly and ready for operation. POST routines notify the user of problems that occur. This is done using several signal tones or by displaying a message that frequently accompanies a diagnosis value on the standard output or standard error devices (generally the monitor). If the POST runs successfully, control is transferred over to the system's bootstrap loader.

## POWERLINK

An enhancement of standard Ethernet. It enables data exchange under strict real-time conditions with cycle times down to 200  $\mu$ s and jitter under 1  $\mu$ s. This makes Ethernet power available on all communication levels of automation technology – from control levels to I/O. POWERLINK was initiated by the company B&R Industrie-Elektronik and is now managed by the open end user and vendor association, EPSG - Ethernet POWERLINK Standardization Group ([www.ethernet-powerlink.org](http://www.ethernet-powerlink.org)).

## Q

### QVGA

Abbreviation for "**Quarter Video Graphics Array**". Usually a screen resolution of 320 × 240 pixels.

### QUXGA

Abbreviation for "**Quad Ultra Extended Graphics Array**". Generally a screen resolution of 3200 × 2400 pixels (4:3). Quad implies the 4x greater pixel resolution compared to the UXGA.

### QWUXGA

Abbreviation for "**Quad WUXGA**"; Generally a screen resolution of 3840 × 2400 pixels (8:5, 16:10).

## R

### RAM

An abbreviation for "**Random Access Memory**". Semiconductor memory which can be read or written to by the microprocessor or other hardware components. Memory locations can be accessed in any order. The various ROM memory types do allow random access, but they cannot be written to. The term RAM refers to a more temporary memory that can be written to as well as read.

### Real time

A system is operating in real time or has real-time capability if the input sizes (e.g. signals, data) are received and processed in a defined time period, and the results are made available in real time for a partner system or the system environment. See also "real-time demands" and "real-time system".

### ROM

An abbreviation for "**Read-Only Memory**". Semiconductor memory where programs or data were permanently stored during the production process.

### RS232

**Recommended Standard Number 232**. Oldest and most widespread interface standard, also called a V.24 interface. All signals are referenced to ground making this an unbalanced interface. High level: -3 to -30 V, low level: +3 to +30 V; cable lengths up to 15 m, transfer rates up to 20 kbit/s; for point-to-point connections between 2 stations.

### RS422

**Recommended Standard Number 422**. Interface standard, balanced operation, increased immunity to disturbances. High level: 2 to -6 V, low level: +2 to +6 V; 4-wire connection [inverted/not inverted], cable lengths up to 1200 m, transfer rates up to 10 Mbit/s, 1 sender can carry out simplex communication with up to 10 receivers.

### RS485

**Recommended Standard Number 485**. Interface standard upgraded from RS422. High level: 1.5 to -6 V, low level: +1.5 to +6 V; two-line connection [half-duplex mode] or four-line connection [full-duplex mode]; permissible cable length up to 1200 m, transfer rates up to 10 Mbit/s. Up to 32 stations (sender/receiver) can be connected to an RS485 bus.

### RTS

An abbreviation for "**Request To Send**". A signal used in serial data transfer for requesting send permission. For example, it is sent from a computer to the modem connected to it. The RTS signal is assigned to pin 4 according to the hardware specifications of the RS-232-C standard.

### RXD

An abbreviation for "**Receive (RX) Data**". A line for transferring serial data received from one device to another, e.g. from a modem to a computer. For connections complying with the RS-232-C standard, the RXD is connected to pin 3 of the plug.

## S

### SDRAM

An abbreviation for "**Synchronous Dynamic Random Access Memory**". A construction of dynamic semiconductor components (DRAM) that can operate with higher clock rates than conventional DRAM switching circuits. This is made possible using block access. For each access, the DRAM determines the next memory addresses to be accessed.

### SFC

Sequential function chart > Graphic input language for PLCs used to represent sequential control.

**Slot PLC**

PC insert card that has full PLC functionality. On the PC, it is coupled via a DPR with the process using a fieldbus connection. It is programmed externally or using the host PC.

**SoftPLC**

Synonym for SoftPLC.

**SRAM**

An abbreviation for "**Static Random Access Memory**". A semiconductor memory (RAM) made up of certain logic circuits (flip-flop) that only keeps stored information while powered. In computers, static RAM is generally only used for cache memory.

**SUXGA**

Abbreviation for **Super Ultra Extended Graphics Array**; Generally a screen resolution of 2048×1536 pixels (4:3). An alternative name is QXGA (**Quad Extended Graphics Array**), which is 4x the pixel resolution of XGA.

**SVGA**

Abbreviation for "**Super Video Graphics Array**"; Graphics standard with a resolution of at least 800×600 pixels and at least 256 colors.

**Switch**

Device similar to a hub that takes data packets received in a network and, unlike a hub, passes them only to the respective addressee, not to all network nodes. Unlike a hub, a switch provides targeted communication within a network that only takes place between sender and receiver. Other network nodes are not involved.

**SXGA**

Abbreviation for Super Extended Graphics Array. Graphics standard with a screen resolution of 1280 × 1024 pixels (aspect ratio 5:4).

**SXGA+**

Abbreviation for SXGA Plus; Generally 1400 × 1050 pixels.

**System units**

Provit system units consist of a mainboard (without processor), slots for RAM modules, VGA controller, serial and parallel interfaces, and connections for the FPD, monitor, PS/2 AT keyboard, PS/2 mouse, USB, Ethernet (for system units with Intel Celeron and Pentium III processors), Panelware keypad modules and external FDD.

### T

#### Task

Program unit that is assigned a specific priority by the real-time operating system. It contains a complete process and can consist of several modules.

#### TCP/IP

Transmission Control Protocol/Internet Suit of Protocols. Network protocol that has become the generally accepted standard for data exchange in heterogeneous networks. TCP/IP is used both in local networks for communication between various computer and also for LAN to WAN access.

#### TFT display

LCD (Liquid Crystal Display) technology where the display consists of a large grid of LCD cells. Each pixel is represented by a cell, whereby electrical fields produced in the cells are supported by thin film transistors (TFT) that result in an active matrix. In its simplest form, there is exactly one thin film transistor per cell. Displays with an active matrix are generally used in laptops and notebooks because they are thin, offer high-quality color displays and can be viewed from all angles.

#### Touch screen

Screen with touch sensors for selecting options in a displayed menu using the tip of the finger.

#### TXD

An abbreviation for "Transmit (**TX**) Data". A line for the transfer of serial data sent from one device to another, e.g. from a computer to a modem. For connections complying with the RS-232-C standard, the TXD is connected to pin 2 of the plug.

### U

#### UART

An abbreviation for "**U**niversal **A**synchronous **R**eceiver-**T**ransmitter". A module generally consisting of a single integrated circuit that combines the circuits required for asynchronous serial communication for both sending and receiving. UART represents the most common type of circuit in modems for connecting to a personal computer.

#### UDMA

An abbreviation for "**U**ltra **D**irect **M**emory **A**ccess". A special IDE data transfer mode that allows high data transfer rates for drives. There have been many variations in recent times.

UDMA33 mode transfers 33 megabytes per second.

UDMA66 mode transfers 66 megabytes per second.

UDMA100 mode transfers 100 megabytes per second.

Both the mainboard and the hard drive must support the specification to implement modifications.



**UPS**

Abbreviation for "**U**ninterruptible **P**ower **S**upply". See "UPS".

**USB**

An abbreviation for "**U**niversal **S**erial **B**us" A serial bus with a bandwidth of up to 12 megabits per second (Mbit/s) for connecting a peripheral device to a microcomputer. Up to 127 devices can be connected to the system using a single multipurpose connection, the USB bus (e.g. external CD drives, printers, modems as well as the mouse and keyboard). This is done by connecting the devices in a row. USB allows devices to be changed when the power supply is switched on (hot plugging) and multi-layered data flow.

**UPS**

An abbreviation for "**U**ninterruptible **P**ower **S**upply". The UPS supplies power to systems that cannot be connected directly to the power mains for safety reasons because a power failure could lead to loss of data. The UPS allows the PC to be shut down securely without losing data if a power failure occurs.

**UXGA**

Abbreviation for "**U**ltra **E**xtended **G**raphics **A**rray" Generally a screen resolution of 1600 × 1200 pixels (aspect ratio 4:3, 12:9).

**V****VGA**

An abbreviation for "**V**ideo **G**raphics **A**dapter". A video adapter which can handle all EGA (Enhanced Graphics Adapter) video modes and adds several new modes.

**W****Windows CE**

Compact 32-bit operating system with multitasking and multithreading that Microsoft developed especially for the OEM market. It can be ported for various processor types and has a high degree of real-time capability. The development environment uses proven, well-established development tools. It is an open and scalable Windows operating system platform for many different devices. Examples of such devices are handheld PCs, digital wireless receivers, intelligent mobile phones, multimedia consoles, etc. In embedded systems, Windows CE is also an excellent choice for automation technology.

**WSXGA**

Wide SXGA, generally 1600 × 900 pixels (16:9).

**WUXGA**

Wide UXGA, generally 1920 × 1200 pixels (16:10).

WXGA

Wide XGA, generally 1280 × 768 pixels.

X

XGA

An abbreviation for "EXtended Graphics Array". An expanded standard for graphics controllers and monitors that was introduced by IBM in 1990. This standard supports 640x480 resolution with 65,536 colors or 1024x768 resolution with 256 colors. This standard is generally used in workstation systems.

XTX

Abbreviation for "eXpress Technologoy for ETX" A further development consistent with the proven ETX® standard. The newest I/O technology is implemented on a reliable form factor in XTX. The ETX® interface X2 is equipped with new serial buses like PCI Express™ und Serial ATA®, instead of the unpopular ISA bus. All other signals on the X1, X3 and X4 interfaces remain completely compatible with the ETX® Standard (Rev. 2.7). However, if ISA signals are needed, a PCI-ISA can be implemented on the base board. The use of an LPC bus already in XTX™ is considerably cheaper than a bridge solution.

Figure 1:	APC620 embedded for central control and visualization.....	51
Figure 2:	APC620 as visualization device .....	52
Figure 3:	Automation PC 620 system overview.....	53
Figure 4:	Selection guide - APC620 basic system with 1, 2, 3, and 5 PCI slots.....	56
Figure 5:	Selection guide - APC620 optional components with 1, 2, 3, and 5 PCI slots	57
Figure 6:	Selection guide - Basic system and optional components APC620 embedded..	59
Figure 7:	Interface overview - APC620, 1 PCI slot variant (top).....	60
Figure 8:	Interface overview - APC620, 1 PCI slot variant (front).....	61
Figure 9:	Dimensions - APC620, 1 PCI slot variant.....	65
Figure 10:	Interface overview - APC620, 2 PCI slot variant (top).....	66
Figure 11:	Interface overview - APC620, 2 PCI slot variant (front).....	67
Figure 12:	Dimensions - APC620, 2 PCI slot variant.....	71
Figure 13:	Interface overview - APC620, 3 PCI slot variant (top).....	72
Figure 14:	Interface overview - APC620, 3 PCI slot variant (front).....	73
Figure 15:	Dimensions - APC620, 3 PCI slot variant.....	76
Figure 16:	Interface overview - APC620, 5 PCI slot variant (top).....	77
Figure 17:	Interface overview - APC620, 5 PCI slot variant (front).....	78
Figure 18:	Dimensions - APC620, 5 PCI slot variant.....	82
Figure 19:	APC620 embedded variant interface overview - top side .....	83
Figure 20:	APC620 embedded variant interface overview - front side .....	84
Figure 21:	APC620 embedded variant - dimensions.....	88
Figure 22:	Example of worst-case conditions for temperature measurement .....	89
Figure 23:	Ambient temperatures for systems with an 815E CPU board (ETX).....	90
Figure 24:	Example of worst-case conditions for temperature measurement .....	93
Figure 25:	Ambient temperatures for systems with an 855GME CPU board (ETX / XTX)...	94
Figure 26:	Ambient temperatures for embedded systems with an 855GME CPU board (ETX / XTX)	95
Figure 27:	Supply voltage for the 5PC600.SX01-00 revision $\geq$ I0.....	97
Figure 28:	Supply voltage for the 5PC600.SX01-00 revision $<$ I0 .....	99
Figure 29:	Supply voltage for the 2 PCI slots (dependent on system unit version) .....	101
Figure 30:	Supply voltage for the 2 PCI slots (dependent on system unit version) .....	104
Figure 31:	Supply voltage block diagram 3 PCI slots .....	107
Figure 32:	Supply voltage for the 5 PCI slots (dependent on system unit version) .....	109
Figure 33:	Supply voltage block diagram 5 PCI slots (dependent on system unit version)..	113
Figure 34:	Supply voltage for the 5PC600.SE00-00, 5PC600.SE00-01 and 5PC600.SE00-02	117
Figure 35:	General device interfaces example - APC620 with 5 PCI slots.....	121
Figure 36:	General device interfaces example - APC620 embedded .....	122
Figure 37:	Supply voltage connection .....	135
Figure 38:	Ground connection .....	136
Figure 39:	Monitor / Panel connection.....	138
Figure 40:	Monitor / Panel connection with RGB video signal.....	142
Figure 41:	Monitor / Panel connection with DVI video signal .....	142
Figure 42:	Monitor / Panel connection with SDL video signal .....	143

## Figure index

Figure 43:	Dimensions - Standard half-size PCI cards.....	147
Figure 44:	Dimensions - Standard full-size PCI cards.....	148
Figure 45:	PCI connector type: 5 volt .....	149
Figure 46:	Front-side status LEDs.....	151
Figure 47:	APC620 serial number sticker on front-side.....	163
Figure 48:	APC620 serial number sticker on back-side .....	163
Figure 49:	Example of serial number search: 70950170564.....	164
Figure 50:	Block diagram of entire device with system unit 5PC600.SX01-00 and 855GME CPU board	165
Figure 51:	Block diagram of entire device with system unit 5PC600.SX02-00 and 855GME CPU board	166
Figure 52:	Block diagram of entire device with system unit 5PC600.SX02-01 and 855GME CPU board	167
Figure 53:	Block diagram of entire device with system unit 5PC600.SF03-00 and 855GME CPU board	168
Figure 54:	Block diagram of entire device with system unit 5PC600.SX05-00 and 855GME CPU board	169
Figure 55:	Block diagram of entire device with system unit 5PC600.SX05-01 and 855GME CPU board	170
Figure 56:	Block diagram of entire device with system unit 5PC600.SE00-00 and 855GME CPU board	171
Figure 57:	Block diagram of entire device with system unit 5PC600.SE00-01 and 855GME CPU board	172
Figure 58:	Block diagram of entire device with system unit 5PC600.SE00-02 and 855GME CPU board	173
Figure 59:	CPU boards 815E (ETX) .....	179
Figure 60:	CPU boards 855GME (ETX) .....	181
Figure 61:	CPU boards 855GME (XTX) .....	183
Figure 62:	Heat sink .....	185
Figure 63:	Main memory module.....	186
Figure 64:	Add-on SSD 128 GB - 5AC600.SSDI-00 £ D0.....	187
Figure 65:	Add-on SSD 128 GB - 5AC600.SSDI-00 <sup>3</sup> E0.....	187
Figure 66:	Temperature humidity diagram - Add-on SSD 128 GB - 5AC600.SSDI-00 £ D0 190	
Figure 67:	Temperature humidity diagram - Add-on SSD 128 GB - 5AC600.SSDI-00 <sup>3</sup> E0. 190	
Figure 68:	Replacement SSD 128 GB - 5MMSSD.0128-00 £ D0 .....	191
Figure 69:	Replacement SSD 128 GB - 5MMSSD.0128-00 <sup>3</sup> E0 .....	191
Figure 70:	Temperature humidity diagram - Replacement SSD 128 GB - 5MMSSD.0128- 00 £ D0	193
Figure 71:	Temperature humidity diagram - Replacement SSD 128 GB - 5MMSSD.0128- 00 <sup>3</sup> E0	194
Figure 72:	Add-on hard disk 30 GB 24x7 - 5AC600.HDDI-00 .....	195
Figure 73:	Temperature humidity diagram - Add-on hard disk 5AC600.HDDI-00 .....	197
Figure 74:	Add-on hard disk 20 GB - 5AC600.HDDI-01 .....	198
Figure 75:	Temperature humidity diagram - Add-on hard disk 5AC600.HDDI-01 .....	200
Figure 76:	Add-on hard disk 40 GB - 5AC600.HDDI-02.....	201

Figure 77:	Temperature humidity diagram - Add-on hard disk 5AC600.HDDI-02 .....	203
Figure 78:	Add-on hard disk 60 GB - 5AC600.HDDI-03 .....	204
Figure 79:	Temperature humidity diagram - Add-on hard disk 5AC600.HDDI-03 .....	206
Figure 80:	Add-on hard disk 80 GB - 5AC600.HDDI-04 .....	207
Figure 81:	Temperature humidity diagram - Add-on hard disk 5AC600.HDDI-04 .....	209
Figure 82:	Add-on hard disk 40 GB - 5AC600.HDDI-05 .....	210
Figure 83:	Temperature humidity diagram - Add-on hard disk 5AC600.HDDI-05 .....	212
Figure 84:	Add-on hard disk 80 GB - 5AC600.HDDI-06 .....	213
Figure 85:	Temperature humidity diagram - Add-on hard disk 5AC600.HDDI-06 .....	215
Figure 86:	Add-on CompactFlash slot - 5AC600.CFSI-00 .....	216
Figure 87:	Slide-in CD-ROM - 5AC600.CDXS-00 .....	217
Figure 88:	Temperature humidity diagram - Slide-in CD-ROM 5AC600.CDXS-00 .....	219
Figure 89:	Slide-in DVD-ROM/CD-RW - 5AC600.DVDS-00 .....	220
Figure 90:	Temperature humidity diagram - Slide-in DVD-ROM/CD-RW 5AC600.DVDS-00 222	
Figure 91:	Slide-in DVD-R/RW, DVD+R/RW - 5AC600.DVRS-00 .....	223
Figure 92:	Temperature humidity diagram - Slide-in DVD-R/RW, DVD+R/RW 5AC600.DVRS-00 .....	227
Figure 93:	Slide-in CF 2-slot - 5AC600.CFSS-00 .....	228
Figure 94:	Slide-in USB FDD - 5AC600.FDDS-00 .....	230
Figure 95:	Temperature humidity diagram - Slide-in USB diskette drive 5AC600.FDDS-00 232	
Figure 96:	Slide-in hard disk 30 GB - 5AC600.HDDS-00 .....	233
Figure 97:	Temperature humidity diagram - Slide-in hard disk 5AC600.HDDS-00 .....	235
Figure 98:	Slide-in hard disk 20 GB - 5AC600.HDDS-01 .....	236
Figure 99:	Temperature humidity diagram - Slide-in hard disk 5AC600.HDDS-01 .....	238
Figure 100:	Slide-in hard disk 40 GB - 5AC600.HDDS-02 .....	239
Figure 101:	Temperature humidity diagram - Slide-in hard disk 5AC600.HDDS-02 .....	241
Figure 102:	RAID 1 system schematic .....	242
Figure 103:	RAID controller - 5ACPCI.RAIC-00 .....	243
Figure 104:	PCI RAID storage - 5ACPCI.RAIS-00 .....	245
Figure 105:	Temperature humidity diagram - RAID hard disk 5ACPCI.RAIS-00 .....	247
Figure 106:	PCI RAID storage - 5ACPCI.RAIS-01 .....	248
Figure 107:	Temperature humidity diagram - RAID hard disk 5ACPCI.RAIS-01 .....	250
Figure 108:	PCI SATA RAID controller - 5ACPCI.RAIC-01 .....	251
Figure 109:	Temperature humidity diagram - SATA RAID hard disk 5ACPCI.RAIC-01 ..	253
Figure 110:	PCI slot numbering on APC620 systems with 5 PCI slots .....	255
Figure 111:	Replacement SATA HDD 60 GB - 5ACPCI.RAIC-02 .....	256
Figure 112:	Temperature humidity diagram - SATA RAID hard disk 5ACPCI.RAIC-02 ..	258
Figure 113:	PCI SATA RAID controller - 5ACPCI.RAIC-03 .....	259
Figure 114:	Temperature humidity diagram - SATA RAID hard disk 5ACPCI.RAIC-03 ..	261
Figure 115:	PCI slot numbering on APC620 systems with 5 PCI slots .....	263
Figure 116:	Replacement SATA HDD 160 GB - 5ACPCI.RAIC-04 .....	264
Figure 117:	Temperature humidity diagram - SATA RAID hard disk 5ACPCI.RAIC-04 ..	266
Figure 118:	PCI SATA RAID controller - 5ACPCI.RAIC-05 .....	267
Figure 119:	Temperature humidity diagram - SATA RAID Hard Disk - 5ACPCI.RAIC-05 .....	269

## Figure index

Figure 120:	Replacement SATA HDD 250 GB - 5MMHDD.0250-00.....	271
Figure 121:	Temperature humidity diagram - SATA RAID hard disk - 5MMHDD.0250-00 .... 273	
Figure 122:	Add-on CAN interface - 5AC600.CANI-00 .....	274
Figure 123:	Terminating resistor - Add-on CAN interface 5AC600.CANI-00.....	277
Figure 124:	Contents of the delivery / mounting material - 5AC600.CANI-00 .....	277
Figure 125:	Add-on RS232/422/485 interface - 5AC600.485I-00.....	278
Figure 126:	Add-on RS232/422/485 interface - operated in RS485 mode.....	280
Figure 127:	Contents of the delivery / mounting material - 5AC600.485I-00.....	281
Figure 128:	Fan kit - 5PC600.FA01-00.....	282
Figure 129:	Fan kit - 5PC600.FA02-00.....	283
Figure 130:	Fan kit - 5PC600.FA03-00.....	285
Figure 131:	Fan kit - 5PC600.FA05-00.....	286
Figure 132:	AP Link card.....	288
Figure 133:	AP Link device connection with DVI video signal.....	291
Figure 134:	AP Link device connection with SDL video signal.....	292
Figure 135:	Mounting plates for the APC620 .....	293
Figure 136:	Mounting orientation - Standard .....	297
Figure 137:	Air circulation spacing - Standard.....	298
Figure 138:	Mounting orientation - Optional .....	299
Figure 139:	Optional circulation spacing .....	300
Figure 140:	Mounting orientations for an APC620 with hard disk drive.....	301
Figure 141:	Mounting orientations for an APC 620 with a slide-in CD-ROM drive.....	302
Figure 142:	Mounting orientations for an APC620 with a slide-in DVD-ROM/CD-RW drive .. 303	
Figure 143:	Mounting orientations for an APC620 with a slide-in DVD-R/RW / DVD+R/RW drive	304
Figure 144:	Mounting orientations for an APC620 with a slide-in USB FDD drive .....	305
Figure 145:	Flex radius - Cable connection.....	306
Figure 146:	Grounding concept.....	307
Figure 147:	Configuration - One Automation Panel 900 via DVI (onboard) .....	310
Figure 148:	Configuration - An Automation Panel 900 via SDL (onboard).....	313
Figure 149:	Configuration - An Automation Panel 800 via SDL (onboard).....	317
Figure 150:	Configuration - One AP900 and an AP800 via SDL (onboard) .....	320
Figure 151:	Configuration - Four Automation Panel 900 units via SDL (onboard) .....	323
Figure 152:	Configuration - One Automation Panel 900 via SDL (AP Link) .....	328
Figure 153:	Configuration - 4 Automation Panel 900 units via SDL (AP Link) .....	332
Figure 154:	Configuration - Two Automation Panel 900 units via SDL (onboard) and SDL (AP Link)	337
Figure 155:	Configuration - Eight Automation Panel 900 units via SDL (onboard) and SDL (AP Link)	341
Figure 156:	Configuration - Six AP900 and two AP800 devices via SDL (onboard) and SDL (AP Link)	346
Figure 157:	Examples - internal numbering of the extension units.....	350
Figure 158:	Open the RAID Configuration Utility.....	351
Figure 159:	RAID Configuration Utility - Menu .....	351
Figure 160:	RAID Configuration Utility - Menu .....	352

Figure 161:	RAID Configuration Utility - Create RAID set - Striped.....	353
Figure 162:	RAID Configuration Utility - Create RAID set - Mirrored.....	354
Figure 163:	RAID Configuration Utility - Delete RAID set.....	355
Figure 164:	RAID Configuration Utility - Rebuild mirrored set.....	356
Figure 165:	RAID Configuration Utility - Resolve conflicts.....	357
Figure 166:	RAID Configuration Utility - Low level format.....	358
Figure 167:	Local connection of USB peripheral devices on the APC620.....	359
Figure 168:	Remote connection of USB peripheral devices to the APC900 via DVI.....	360
Figure 169:	Remote connection of USB peripheral devices to the APC800/900 via SDL.....	361
Figure 170:	B&R Control Center.....	363
Figure 171:	Settings for Passmark BurnIn Pro V4 with an APC810 2-slot with DVD.....	364
Figure 172:	Test overview of an APC810 2-slot with DVD.....	365
Figure 173:	815E (ETX) BIOS diagnostic screen.....	372
Figure 174:	815E (ETX) BIOS Summary screen.....	373
Figure 175:	815E (ETX) Main Menu.....	375
Figure 176:	815E (ETX) IDE Channel 0 Master.....	376
Figure 177:	815E (ETX) IDE Channel 0.....	378
Figure 178:	815E (ETX) IDE Channel 1 Master.....	380
Figure 179:	815E (ETX) IDE Channel 1 Slave.....	382
Figure 180:	815E (ETX) Advanced Menu.....	384
Figure 181:	815E (ETX) Advanced Chipset/Graphics Control.....	385
Figure 182:	815E (ETX) PCI/PNP Configuration.....	387
Figure 183:	815E (ETX) PCI device, slot #1.....	389
Figure 184:	815E (ETX) PCI device, slot #2.....	390
Figure 185:	815E (ETX) PCI device, slot #3.....	391
Figure 186:	815E (ETX) PCI device, slot #4.....	392
Figure 187:	815E (ETX) Memory Cache.....	393
Figure 188:	815E (ETX) I/O Device Configuration.....	395
Figure 189:	815E (ETX) Keyboard Features.....	398
Figure 190:	815E (ETX) CPU Board Monitor.....	399
Figure 191:	815E (ETX) Miscellaneous.....	400
Figure 192:	815E (ETX) Baseboard/Panel Features.....	401
Figure 193:	815E (ETX) Panel Control.....	403
Figure 194:	815E (ETX) Baseboard Monitor.....	404
Figure 195:	815E (ETX) Legacy Devices.....	405
Figure 196:	815E (ETX) Security Menu.....	407
Figure 197:	815E (ETX) Power Menu.....	409
Figure 198:	815E (ETX) ACPI Control.....	411
Figure 199:	815E (ETX) Thermal Management.....	412
Figure 200:	815E (ETX) Boot Menu.....	414
Figure 201:	815E (ETX) Exit Menu.....	415
Figure 202:	DIP switch on system unit.....	416
Figure 203:	855GME (ETX) BIOS Diagnostics Screen.....	426
Figure 204:	855GME (ETX) BIOS Summary Screen.....	426
Figure 205:	855GME (ETX) Main.....	428
Figure 206:	855GME (ETX) IDE Channel 0 Master Setup.....	430
Figure 207:	855GME (ETX) IDE channel 0 slave setup.....	432

## Figure index

Figure 208:	855GME (ETX) IDE Channel 1 Master Setup .....	434
Figure 209:	855GME (ETX) IDE channel 1 slave setup .....	436
Figure 210:	855GME - advanced setup menu - overview .....	438
Figure 211:	855GME (ETX) - advanced chipset control .....	439
Figure 212:	815GME (ETX) - PCI/PNP configuration .....	441
Figure 213:	855GME (ETX) - PCI device, slot #1 .....	444
Figure 214:	855GME (ETX) - PCI device, slot #2 .....	445
Figure 215:	855GME (ETX) - PCI device, slot #3 .....	446
Figure 216:	855GME (ETX) - PCI device, slot #4 .....	447
Figure 217:	855GME (ETX) - memory cache .....	448
Figure 218:	855GME (ETX) - I/O device configuration .....	450
Figure 219:	855GME (ETX) Keyboard Features .....	453
Figure 220:	855GME (ETX) - CPU board monitor .....	454
Figure 221:	855GME (ETX) miscellaneous .....	455
Figure 222:	855GME (ETX) Baseboard/Panel Features .....	456
Figure 223:	855GME (ETX) Panel Control .....	458
Figure 224:	855GME (ETX) - baseboard monitor .....	459
Figure 225:	855GME (ETX) Legacy Devices .....	461
Figure 226:	855GME (ETX) Security Menu .....	463
Figure 227:	855GME (ETX) Power menu .....	465
Figure 228:	855GME (ETX) ACPI Control .....	467
Figure 229:	855GME (ETX) Boot menu .....	469
Figure 230:	855GME (ETX) - exit menu .....	470
Figure 231:	DIP switch on system unit .....	472
Figure 232:	855GME (XTX) - BIOS diagnostics screen .....	482
Figure 233:	855GME (XTX) BIOS Main menu .....	484
Figure 234:	855GME (XTX) Advanced menu .....	485
Figure 235:	855GME (XTX) Advanced ACPI Configuration .....	486
Figure 236:	855GME (XTX) Advanced PCI Configuration .....	488
Figure 237:	855GME (XTX) Advanced Graphics Configuration .....	490
Figure 238:	855GME (XTX) Advanced CPU Configuration .....	492
Figure 239:	855GME (XTX) - advanced chipset configuration .....	493
Figure 240:	855GME (XTX) I/O Interface Configuration .....	494
Figure 241:	855GME (XTX) Advanced Clock Configuration .....	496
Figure 242:	855GME (XTX) Advanced IDE Configuration .....	497
Figure 243:	855GME (XTX) Primary IDE Master .....	498
Figure 244:	855GME (XTX) - primary IDE slave .....	500
Figure 245:	855GME (XTX) Secondary IDE Master .....	501
Figure 246:	855GME (XTX) Secondary IDE Slave .....	503
Figure 247:	855GME (XTX) Advanced USB Configuration .....	504
Figure 248:	855GME (XTX) USB mass storage device configuration .....	507
Figure 249:	855GME (XTX) - advanced keyboard/mouse configuration .....	508
Figure 250:	855GME (XTX) - advanced remote access configuration .....	509
Figure 251:	855GME (XTX) - advanced CPU board monitor .....	511
Figure 252:	855GME (XTX) Advanced Baseboard/Panel Features .....	512
Figure 253:	855GME (XTX) Panel Control .....	514
Figure 254:	855GME (XTX) - baseboard monitor .....	515



Figure 255:	855GME (XTX) - Legacy devices.....	516
Figure 256:	855GME (XTX) Boot menu .....	518
Figure 257:	855GME (XTX) Security menu.....	520
Figure 258:	855GME (XTX) Hard disk security user password.....	521
Figure 259:	855GME (XTX) Hard disk security master password.....	522
Figure 260:	855GME (XTX) Power menu.....	523
Figure 261:	855GME (XTX) - Exit menu.....	525
Figure 262:	DIP switch on system unit .....	527
Figure 263:	PCI routing with activated APIC CPU boards 815E (ETX), 855GME (ETX) .....	543
Figure 264:	PCI routing with activated APIC CPU boards 855GME (XTX) .....	544
Figure 265:	PCI routing with activated APIC CPU boards 855GME (XTX) on the APC620e. 545	
Figure 266:	Location of DIP switch.....	546
Figure 267:	Differentiating between 815E and 855GME CPU boards .....	548
Figure 268:	Software versions.....	549
Figure 269:	Firmware version of Automation Panel Link SDL transceiver/receiver .....	550
Figure 270:	Creating a bootable diskette in Windows XP - step 1 .....	558
Figure 271:	Creating a bootable diskette in Windows XP - step 2 .....	558
Figure 272:	Creating a bootable diskette in Windows XP - step 3 .....	558
Figure 273:	Creating a bootable diskette in Windows XP - step 4 .....	559
Figure 274:	Creating a bootable diskette in Windows XP - step 5 .....	559
Figure 275:	Creating a USB flash drive for B&R upgrade files.....	561
Figure 276:	Creating a CompactFlash card for B&R upgrade files .....	563
Figure 277:	Automation PC 620 with MS-DOS .....	566
Figure 278:	Windows XP Professional Logo .....	568
Figure 279:	Graphics driver for 815E Control Panel access .....	571
Figure 280:	Graphics driver for 815E settings.....	571
Figure 281:	Accessing the graphics driver via Control Panel.....	572
Figure 282:	Extended desktop settings - primary and secondary device.....	573
Figure 283:	Dual display clone settings - primary and secondary device.....	575
Figure 284:	Settings after installing the graphics driver.....	576
Figure 285:	Settings for adjustment.....	577
Figure 286:	Touch screen driver - serial touch screen .....	578
Figure 287:	Touch screen driver - auto-detect .....	579
Figure 288:	Touch screen calibration .....	579
Figure 289:	Touch screen driver - serial touch screen .....	580
Figure 290:	Touch screen driver - auto-detect .....	580
Figure 291:	Touch screen calibration .....	581
Figure 292:	Windows XP Embedded Logo.....	584
Figure 293:	Windows Embedded Standard 2009 Logo.....	588
Figure 294:	ADI Control Center screenshots - Example (symbol photo).....	595
Figure 295:	ADI Control Center - SDL equalizer settings.....	598
Figure 296:	ADI Control Center - UPS settings.....	599
Figure 297:	ADI Control Center - UPS monitor .....	601
Figure 298:	ADI Control Center - UPS battery settings.....	602
Figure 299:	ADI Control Center - UPS settings.....	604
Figure 300:	ADI Control Center - Advanced UPS settings.....	606

## Figure index

Figure 301:	Test structure - torsion .....	629
Figure 302:	Test structure - Cable drag chain .....	630
Figure 303:	Contents of delivery - interface cover .....	643
Figure 304:	Temperature humidity diagram - CompactFlash cards 5CFCRD.xxxx-06 ...	648
Figure 305:	Dimensions - CompactFlash card Type I .....	648
Figure 306:	ATTO Benchmark v2.34 comparison when reading - 5CFCRD.xxxx-04 with 5CFCRD.xxxx-06 .....	649
Figure 307:	ATTO Benchmark v2.34 comparison when writing - 5CFCRD.xxxx-04 with 5CFCRD.xxxx-06 .....	649
Figure 308:	Temperature humidity diagram - CompactFlash cards 5CFCRD.xxxx-04 ...	653
Figure 309:	Dimensions - CompactFlash card Type I .....	653
Figure 310:	ATTO disk benchmark v2.34 comparison (reading) .....	654
Figure 311:	ATTO disk benchmark v2.34 comparison (writing) .....	654
Figure 312:	Temperature humidity diagram - CompactFlash cards 5CFCRD.xxxx-03 ...	658
Figure 313:	Dimensions - CompactFlash card Type I .....	658
Figure 314:	Dimensions - CompactFlash card Type I .....	661
Figure 315:	SanDisk white paper - page 1 of 6 .....	662
Figure 316:	SanDisk white paper - page 2 of 6 .....	663
Figure 317:	SanDisk white paper - page 3 of 6 .....	664
Figure 318:	SanDisk white paper - page 4 of 6 .....	665
Figure 319:	SanDisk white paper - page 5 of 6 .....	666
Figure 320:	SanDisk white paper - page 6 of 6 .....	667
Figure 321:	USB Media Drive 5MD900.USB2-00 .....	668
Figure 322:	Dimensions for USB Media Drive 5MD900.USB2-00 .....	671
Figure 323:	Dimensions - USB Media Drive with front cover .....	672
Figure 324:	Interfaces for USB Media Drive 5MD900.USB2-00 .....	672
Figure 325:	Mounting orientation of USB Media Drive 5MD900.USB2-00 .....	673
Figure 326:	Front cover 5A5003.03 .....	673
Figure 327:	Dimensions - 5A5003.03 .....	674
Figure 328:	Front cover mounting and installation depth .....	674
Figure 329:	USB Media Drive - 5MD900.USB2-01 .....	675
Figure 330:	Dimensions - 5MD900.USB2-01 .....	678
Figure 331:	Dimensions - USB Media Drive with front cover .....	679
Figure 332:	Interfaces - 5MD900.USB2-01 .....	679
Figure 333:	Mounting orientation - 5MD900.USB2-01 .....	680
Figure 334:	Front cover 5A5003.03 .....	680
Figure 335:	Dimensions - 5A5003.03 .....	681
Figure 336:	Front cover mounting and installation depth .....	681
Figure 337:	Temperature humidity diagram for flash drives 5MMUSB.xxxx-00 .....	684
Figure 338:	Temperature humidity diagram - USB flash drive - 5MMUSB.2048-01 .....	686
Figure 339:	HMI Drivers & Utilities DVD 5SWHMI.0000-00 .....	687
Figure 340:	APC620 internal supply cable 5CAMSC.0001-00 .....	692
Figure 341:	DVI extension cable (similar) .....	693
Figure 342:	Flex radius specification .....	694
Figure 343:	Pin assignments - DVI cable .....	695
Figure 344:	SDL extension cable (similar) .....	696
Figure 345:	Flex radius specification .....	697

Figure 346:	Pin assignments - SDL cable 5CASDL.0xxx-00.....	698
Figure 347:	SDL cable with 45° plug (similar) .....	699
Figure 348:	Flex radius specification .....	700
Figure 349:	Pin assignments - SDL cable with 45° plug 5CASDL.0xxx-01 .....	701
Figure 350:	SDL cable with extender (similar).....	702
Figure 351:	Flex radius specification .....	703
Figure 352:	Example of the signal direction for the SDL cable with extender .....	704
Figure 353:	Pin assignments - SDL cable with extender 5CASDL.0x00-10.....	705
Figure 354:	SDL cable 5CASDL.0xxx-03 (similar) .....	706
Figure 355:	Flex radius specification .....	708
Figure 356:	Dimensions - SDL cable 5CASDL.0xxx-03 .....	708
Figure 357:	Pin assignments - SDL cable 5CASDL.0xxx-03.....	710
Figure 358:	SDL flex cable with extender - 5CASDL.0x00-13 (similar).....	711
Figure 359:	Flex radius specification .....	713
Figure 360:	Dimensions - SDL flex cable with extender 5CASDL.0x00-13.....	713
Figure 361:	Example of the signal direction for the SDL flex cable with extender - APC620. 714	
Figure 362:	Example of signal direction display - SDL flex cable with extender .....	714
Figure 363:	Pin assignments - SDL flex cable with extender 5CASDL.0x00-13 .....	715
Figure 364:	RS232 extension cable (similar).....	716
Figure 365:	Pin assignments - RS232 cable .....	717
Figure 366:	USB extension cable (similar) .....	718
Figure 367:	Pin assignments - USB cable.....	719
Figure 368:	UPS principle.....	720
Figure 369:	Firmware and software required for the UPS .....	722
Figure 370:	Add-on UPS module 5AC600.UPSI-00 .....	724
Figure 371:	Add-on UPS module 5AC600.UPSI-00 - Installation materials .....	725
Figure 372:	Battery unit 5AC600.UPSB-00 .....	726
Figure 373:	Temperature life span diagram .....	727
Figure 374:	Deep discharge cycles .....	727
Figure 375:	Dimensions - 5AC600.UPSB-00 .....	728
Figure 376:	Drilling template for the battery unit.....	729
Figure 377:	UPS connection cable .....	730
Figure 378:	Block diagram of the UPS .....	731
Figure 379:	PCI Ethernet card 10/100 - 5ACPCI.ETH1-01 .....	733
Figure 380:	Dimensions - 5ACPCI.ETH1-01 .....	734
Figure 381:	PCI Ethernet card 10/100 - 5ACPCI.ETH3-01 .....	735
Figure 382:	Dimensions - 5ACPCI.ETH3-01 .....	736
Figure 383:	Replacement fan .....	737
Figure 384:	5AC600.SRAM-00.....	738
Figure 385:	SRAM module installation .....	740
Figure 386:	B&R power supplies (examples) .....	741
Figure 387:	Battery removal .....	744
Figure 388:	Battery handling .....	745
Figure 389:	Battery polarity .....	745
Figure 390:	CompactFlash + ejection lever (representation picture).....	746
Figure 391:	APC620 1PCI slot - Remove screws to install/ remove filter kit.....	747

## Figure index

Figure 392:	APC620 1PCI slot - Remove side cover and fan kit cover.....	747
Figure 393:	Markings for direction of airflow / fan rotation.....	748
Figure 394:	APC620 1PCI slot - Fan installation.....	748
Figure 395:	APC620 1PCI slot - Fan cable connection to the main board.....	749
Figure 396:	APC620 2PCI slots - Remove screws to install/ remove filter kit.....	750
Figure 397:	APC620 2PCI slots - Remove side cover and fan kit cover.....	750
Figure 398:	Markings for direction of airflow / fan rotation.....	751
Figure 399:	APC620 2PCI slots - Fan installation.....	751
Figure 400:	APC620 2PCI slots - Fan cable connection to the main board.....	752
Figure 401:	Dust filter in the fan kit cover and filter clasp.....	752
Figure 402:	APC620 3PCI slot - Remove screws to install/ remove filter kit.....	753
Figure 403:	APC620 3PCI slots - Remove side cover and fan kit cover.....	754
Figure 404:	Markings for direction of airflow / fan rotation.....	754
Figure 405:	APC620 3PCI slot - Fan installation.....	755
Figure 406:	APC620 3PCI slot - Fan cable connection to the main board.....	756
Figure 407:	Dust filter in the fan kit cover and filter clasp.....	756
Figure 408:	APC620 5PCI slot - Remove screws to install/ remove filter kit.....	757
Figure 409:	APC620 5PCI slot - Remove side cover and fan kit cover.....	757
Figure 410:	APC620 5PCI attach cable fasteners.....	758
Figure 411:	Markings for direction of airflow / fan rotation.....	758
Figure 412:	APC620 5PCI slot - Fan installation.....	759
Figure 413:	APC620 5PCI slot - Fan cable connection to the main board.....	760
Figure 414:	Dust filter in the fan kit cover and filter clasp.....	761
Figure 415:	Removing the slide-in dummy module.....	762
Figure 416:	Installing the slide-in drive.....	762
Figure 417:	Release the slide-in slot releasing mechanisms.....	763
Figure 418:	Removing the slide-in drive.....	763
Figure 419:	Slide-in slot releasing mechanism start position.....	764
Figure 420:	Add-on UPS module 5AC600.UPSI-00 - Installation materials.....	765
Figure 421:	Remove UPS module cover.....	765
Figure 422:	Screw in spacing bolt and spacing ring.....	766
Figure 423:	Install UPS module.....	766
Figure 424:	Plug in connection cable.....	766
Figure 425:	Connector locking mechanism.....	767
Figure 426:	Remove UPS module cover.....	768
Figure 427:	Remove cover plate.....	768
Figure 428:	Screw in spacing bolt and spacing ring.....	768
Figure 429:	Install mounting bracket.....	769
Figure 430:	Install UPS module.....	769
Figure 431:	Plug in connection cable.....	769
Figure 432:	Connector locking mechanism.....	770
Figure 433:	Remove UPS module cover.....	771
Figure 434:	Remove cover plate.....	771
Figure 435:	Screw in spacing bolt and spacing ring.....	771
Figure 436:	Install mounting bracket.....	772
Figure 437:	Install UPS module.....	772
Figure 438:	Plug in connection cable.....	772

Figure 439:	Connector locking mechanism .....	773
Figure 440:	Remove UPS module cover .....	774
Figure 441:	Screw in spacing bolt .....	774
Figure 442:	Install UPS module .....	774
Figure 443:	Plug in connection cable .....	775
Figure 444:	Connector locking mechanism .....	775
Figure 445:	Remove UPS module cover .....	776
Figure 446:	Remove cover plate .....	776
Figure 447:	Screw in spacing bolt .....	776
Figure 448:	Install mounting bracket .....	777
Figure 449:	Install UPS module .....	777
Figure 450:	Plug in connection cable .....	777
Figure 451:	Connector locking mechanism .....	778
Figure 452:	Remove UPS module cover .....	778
Figure 453:	Remove cover plate .....	778
Figure 454:	Screw in spacing bolt .....	779
Figure 455:	Install mounting bracket .....	779
Figure 456:	Install UPS module .....	779
Figure 457:	Plug in connection cable .....	780
Figure 458:	Connector locking mechanism .....	780
Figure 459:	Mounting the side cover - APC620, 1 PCI slot .....	781
Figure 460:	Mounting the side cover - APC620, 2 PCI slot .....	782
Figure 461:	Mounting the side cover - APC620, 3 PCI slot .....	783
Figure 462:	Mounting the side cover - APC620, 5 PCI slot .....	784
Figure 463:	Screw assignment on the back side of the SATA RAID controller .....	785
Figure 464:	Hard disk exchange .....	786
Figure 465:	Removing the APC620 front cover .....	787
Figure 466:	Mounting the APC620 front cover .....	788
Figure 467:	APC620 front cover label .....	789
Figure 468:	Removing the APC620 front cover .....	789
Figure 469:	Attaching the front cover .....	790
Figure 470:	Temperature sensor locations .....	791
Figure 471:	Connector location for external devices .....	792
Figure 472:	MTCX controller location .....	793
Figure 473:	Sample configuration for SDL timing .....	794
Figure 474:	SDL timing - Example for Automation Panel 900 with the number 0 .....	795
Figure 475:	B&R Key Editor screenshots Version 3.10 (representation picture) .....	797
Figure 476:	ADI development kit screenshots (Version 3.10) .....	799
Figure 477:	ADI .NET SDK Screenshots (Version 1.50) .....	801



Table 1:	Manual history.....	23
Table 2:	Environmentally-friendly separation of materials.....	35
Table 3:	Organization of safety notices.....	36
Table 4:	Model numbers - system units.....	37
Table 5:	Model numbers - 815E (ETX) CPU boards.....	38
Table 6:	Model numbers - 855GME (ETX) CPU boards.....	38
Table 7:	Model numbers - 855GME (XTX) CPU boards.....	39
Table 8:	Model numbers - Heat sinks.....	39
Table 9:	Model numbers - Main memory.....	40
Table 10:	Model numbers - Drives.....	40
Table 11:	Model numbers - Interfaces.....	42
Table 12:	Model numbers - Fan kits.....	42
Table 13:	Model numbers - AP Link graphics adapter.....	42
Table 14:	Model numbers - Supply voltage connectors.....	42
Table 15:	Model numbers - X2X and CAN plug.....	43
Table 16:	Model numbers - Batteries.....	43
Table 17:	Model numbers - CompactFlash cards.....	43
Table 18:	Model numbers - USB flash drives.....	45
Table 19:	Model numbers - Cables.....	45
Table 20:	Model numbers - UPS module + accessories.....	47
Table 21:	Model numbers - PCI Ethernet cards.....	47
Table 22:	Model numbers - Other items.....	47
Table 23:	Model numbers - Software.....	48
Table 24:	Technical data - APC620, 1 PCI slot variant.....	62
Table 25:	Technical data - APC620, 2 PCI slot variant.....	68
Table 26:	Technical data - APC620, 3 PCI slot variant.....	74
Table 27:	Technical data - APC620, 5 PCI slot variant.....	79
Table 28:	Technical data - APC620 embedded variant.....	85
Table 29:	Overview of humidity specifications for individual components.....	119
Table 30:	Pin assignments - COM1.....	123
Table 31:	COM1 - I/O address and IRQ.....	123
Table 32:	Pin assignments - COM2.....	124
Table 33:	COM2 - I/O address and IRQ.....	124
Table 34:	X2X pin assignments (only APC620 embedded).....	125
Table 35:	CAN pin assignments (only APC620 embedded).....	125
Table 36:	CAN node number switch (x1, x16) - only APC620 embedded.....	126
Table 37:	CAN terminating switch / LED (only APC620 embedded).....	126
Table 38:	Status LEDs CAN / X2X (only APC620 embedded).....	127
Table 39:	POWERLINK (only APC620 embedded).....	127
Table 40:	Status / Error LED as error LED - POWERLINK V2 operating mode.....	127
Table 41:	Status/Error LED as status LED - POWERLINK V2 operating mode.....	128
Table 42:	POWERLINK station number (x1, x16) - only APC620 embedded.....	129
Table 43:	Ethernet connection ETH (only APC620 embedded).....	129
Table 44:	Ethernet connection (ETH1).....	130
Table 45:	Ethernet cable length in conjunction with 5PC600.E855-xx CPU boards (ETX).....	131
Table 46:	Ethernet cable length in conjunction with 5PC600.E855-xx CPU boards.....	131

## Table index

Table 47:	Ethernet connection (ETH2).....	132
Table 48:	USB port.....	133
Table 49:	USB connections 4 x - only APC620 embedded.....	134
Table 50:	Power supply depending on the system unit.....	135
Table 51:	Starting currents in the voltage supply to the system units .....	136
Table 52:	System unit revisions for at least 10 seconds turn-off time .....	137
Table 53:	System unit revisions for any turn-off times .....	137
Table 54:	Pin assignments - Monitor / panel connection .....	139
Table 55:	Segment lengths, resolutions and SDL cables .....	139
Table 56:	Requirements for SDL cable with automatic cable adjustment (equalizer) .....	140
Table 57:	Requirements for SDL cable with extender and automatic cable adjustment (equalizer) .....	141
Table 58:	Technical data - MIC, Line IN and Line OUT port .....	144
Table 59:	Add-on interface slot .....	145
Table 60:	Add-on UPS module slot.....	146
Table 61:	Technical data - PCI bus.....	148
Table 62:	Technical data - Status LEDs.....	150
Table 63:	Status LEDs Power, CF, Link (only APC620 embedded) .....	151
Table 64:	Technical data - CompactFlash slot (CF1).....	152
Table 65:	Technical data - Hard disk / CompactFlash slot (HDD/CF2).....	153
Table 66:	CompactFlash slots (CF1 / CF2) - APC620 embedded .....	155
Table 67:	Technical data - Power button .....	156
Table 68:	Technical data - Reset button .....	156
Table 69:	Technical data - PS/2 keyboard/mouse (external PS/2) .....	157
Table 70:	Technical data - battery.....	158
Table 71:	Meaning of battery status.....	158
Table 72:	Technical data - Hardware security key .....	160
Table 73:	Hardware security key - I/O address and IRQ .....	160
Table 74:	Technical data - Slide-in slot 1 .....	161
Table 75:	Technical data - Slide-in slot 2 .....	162
Table 76:	Technical data - 1, 2, 3 and 5 PCI slot types .....	174
Table 77:	Technical data - APC620 embedded variations.....	176
Table 78:	Technical data - 815E CPU boards (ETX) .....	179
Table 79:	Technical data - CPU boards 855GME (ETX) .....	181
Table 80:	Technical data - CPU boards 855GME (XTX) .....	183
Table 81:	Technical data - Heat sink.....	185
Table 82:	Technical data - Main memory.....	186
Table 83:	Technical data - Add-on SSD - 5AC600.SSDI-00.....	188
Table 84:	Technical data - Replacement SSD - 5MMSSD.0128-00 .....	192
Table 85:	Technical data - Add-on hard disk 5AC600.HDDI-00 .....	195
Table 86:	Technical data - Add-on hard disk 5AC600.HDDI-01 .....	198
Table 87:	Technical data - add-on hard disk - 5AC600.HDDI-02.....	201
Table 88:	Technical data - add-on hard disk - 5AC600.HDDI-03.....	204
Table 89:	Technical data - add-on hard disk - 5AC600.HDDI-04.....	207
Table 90:	Technical data - Add-on hard disk 5AC600.HDDI-05 .....	210
Table 91:	Technical data - add-on hard disk - 5AC600.HDDI-06.....	213
Table 92:	Technical data - Add-on CompactFlash slot 5AC600.CFSI-00.....	216



Table 93:	Technical data - Slide-in CD-ROM 5AC600.CDXS-00.....	218
Table 94:	Technical data - Slide-in DVD-ROM/CD-RW 5AC600.DVDS-00.....	221
Table 95:	Technical data - slide-in DVD-R/RW, DVD+R/RW - 5AC600.DVRS-00 revision D0 and higher .....	224
Table 96:	Technical data - slide-in DVD-R/RW, DVD+R/RW - 5AC600.DVRS-00 revision D0 and lower.....	225
Table 97:	Technical data - Slide-in CF slot 2 - 5AC600.CFSS-00 .....	229
Table 98:	Technical data - Slide-in USB diskette drive - 5AC600.FDDS-00.....	231
Table 99:	Technical data - Slide-in hard disk - 5AC600.HDDS-00.....	234
Table 100:	Technical data - Slide-in hard disk - 5AC600.HDDS-01.....	237
Table 101:	Technical data - Slide-in hard disk - 5AC600.HDDS-02.....	240
Table 102:	Technical data - RAID controller - 5ACPCI.RAIC-00 .....	243
Table 103:	Contents of delivery - 5ACPCI.RAIC-00 .....	244
Table 104:	Technical data - RAID hard disk - 5ACPCI.RAIS-00.....	246
Table 105:	Technical data - RAID hard disk - 5ACPCI.RAIS-01 .....	249
Table 106:	Technical data - RAID hard disk - 5ACPCI.RAIC-01.....	252
Table 107:	Technical data - RAID hard disk - 5ACPCI.RAIC-02.....	256
Table 108:	Technical data - RAID hard disk - 5ACPCI.RAIC-03.....	260
Table 109:	Technical data - RAID hard disk - 5ACPCI.RAIC-04.....	264
Table 110:	Technical data - RAID Hard Disk - 5ACPCI.RAIC-05 .....	268
Table 111:	Technical data - RAID hard disk - 5MMHDD.0250-00 .....	271
Table 112:	Technical data - Add-on CAN interface - 5AC600.CANI-00.....	274
Table 113:	Pin assignments - CAN .....	275
Table 114:	Add-on CAN - I/O Adresse und IRQ .....	275
Table 115:	CAN address register .....	275
Table 116:	Bus length and transfer rate - CAN .....	276
Table 117:	CAN cable requirements .....	276
Table 118:	Pin assignments - RS232/RS422.....	278
Table 119:	Add-on RS232/422/485 - I/O address and IRQ .....	278
Table 120:	RS232 - Bus length and transfer rate.....	279
Table 121:	RS232 - Cable requirements.....	279
Table 122:	RS422 - Bus length and transfer rate.....	279
Table 123:	RS422 - Cable requirements.....	280
Table 124:	RS485 - Bus length and transfer rate.....	281
Table 125:	RS485 - Cable requirements.....	281
Table 126:	Technical data - 5PC600.FA01-00.....	282
Table 127:	Contents of delivery - 5PC600.FA01-00 .....	283
Table 128:	Technical data - 5PC600.FA02-00 .....	284
Table 129:	Contents of delivery - 5PC600.FA02-00 .....	284
Table 130:	Technical data - 5PC600.FA03-00 .....	285
Table 131:	Contents of delivery - 5PC600.FA03-00 .....	285
Table 132:	Technical data - 5PC600.FA05-00.....	286
Table 133:	Contents of delivery - 5PC600.FA05-00 .....	287
Table 134:	Model numbers - AP Link graphics adapter .....	288
Table 135:	AP Link slot (AP Link card inserted).....	288
Table 136:	Pin assignment for AP Link connection.....	289
Table 137:	Segment lengths, resolutions and SDL cables .....	290

## Table index

Table 138:	Requirements for SDL cable with automatic cable adjustment (equalizer) .....	290
Table 139:	Requirements for SDL cable with extender and automatic cable adjustment (equalizer) .....	291
Table 140:	Drilling templates - 1 and 2 PCI slots .....	294
Table 141:	Drilling templates - 3 and 5 PCI slots .....	295
Table 142:	Drilling templates - APC620 embedded .....	296
Table 143:	Selecting the display units .....	309
Table 144:	Possible combinations of system unit and CPU board .....	310
Table 145:	Link module for the configuration - One Automation Panel 900 via DVI .....	311
Table 146:	Cables for DVI configurations .....	311
Table 147:	Possible Automation Panel units, resolutions und segment lengths .....	311
Table 148:	Possible combinations of system unit and CPU board .....	313
Table 149:	Link module for the configuration - One Automation Panel 900 via SDL .....	314
Table 150:	Cables for SDL configurations .....	314
Table 151:	Segment lengths, resolutions and SDL cables .....	315
Table 152:	Requirements for SDL cable with automatic cable adjustment (equalizer) .....	315
Table 153:	Requirements for SDL cable with extender and automatic cable adjustment (equalizer) .....	316
Table 154:	Possible combinations of system unit and CPU board .....	317
Table 155:	Cables for SDL configurations .....	318
Table 156:	Segment lengths, resolutions and SDL cables .....	318
Table 157:	Requirements for SDL cable with automatic cable adjustment (equalizer) .....	319
Table 158:	Requirements for SDL cable with extender and automatic cable adjustment (equalizer) .....	319
Table 159:	Possible combinations of system unit and CPU board .....	320
Table 160:	Segment lengths, resolutions and SDL cables .....	321
Table 161:	Requirements for SDL cable with automatic cable adjustment (equalizer) .....	321
Table 162:	Requirements for SDL cable with extender and automatic cable adjustment (equalizer) .....	322
Table 163:	Possible combinations of system unit and CPU board .....	323
Table 164:	Link modules for the configuration: 4 Automation Panel 900 via SDL on 1 line .....	324
Table 165:	Cables for SDL configurations .....	324
Table 166:	Segment lengths, resolutions and SDL cables .....	325
Table 167:	Requirements for SDL cable with automatic cable adjustment (equalizer) .....	326
Table 168:	Requirements for SDL cable with extender and automatic cable adjustment (equalizer) .....	326
Table 169:	Possible combinations of system unit and CPU board .....	328
Table 170:	Link modules for the configuration: 1 Automation Panel 900 via SDL (optional) ....	329
Table 171:	Cables for SDL configurations .....	329
Table 172:	Segment lengths, resolutions and SDL cables .....	330
Table 173:	Requirements for SDL cable with automatic cable adjustment (equalizer) .....	330
Table 174:	Requirements for SDL cable with extender and automatic cable adjustment (equalizer) .....	331
Table 175:	Possible combinations of system unit and CPU board .....	332
Table 176:	Link modules for configuration: 4 Automation Panel 900 units via SDL (optional) on 1 line .....	333

Table 177:	Cables for SDL configurations .....	333
Table 178:	Segment lengths, resolutions and SDL cables .....	334
Table 179:	Requirements for SDL cable with automatic cable adjustment (equalizer) .....	335
Table 180:	Requirements for SDL cable with extender and automatic cable adjustment (equalizer) .....	335
Table 181:	Possible combinations of system unit and CPU board .....	337
Table 182:	Link modules for the configuration: 2 Automation Panel 900 units via SDL and SDL (optional) .....	338
Table 183:	Cables for SDL configurations .....	338
Table 184:	Segment lengths, resolutions and SDL cables .....	339
Table 185:	Requirements for SDL cable with automatic cable adjustment (equalizer) .....	339
Table 186:	Requirements for SDL cable with extender and automatic cable adjustment (equalizer) .....	340
Table 187:	Possible combinations of system unit and CPU board .....	342
Table 188:	Link modules for configuration: 8 Automation Panel 900 units via SDL and SDL (optional) .....	342
Table 189:	Cables for SDL configurations .....	343
Table 190:	Segment lengths, resolutions and SDL cables .....	343
Table 191:	Requirements for SDL cable with automatic cable adjustment (equalizer) .....	344
Table 192:	Requirements for SDL cable with extender and automatic cable adjustment (equalizer) .....	345
Table 193:	Possible combinations of system unit and CPU board .....	347
Table 194:	Link modules for configuration: 6 Automation Panel 900 units via SDL and SDL (optional) .....	347
Table 195:	Segment lengths, resolutions and SDL cables .....	348
Table 196:	Requirements for SDL cable with automatic cable adjustment (equalizer) .....	348
Table 197:	Requirements for SDL cable with extender and automatic cable adjustment (equalizer) .....	349
Table 198:	BIOS-relevant keys in the RAID Configuration Utility .....	351
Table 199:	Evaluation example using an APC810 2-slot .....	367
Table 200:	Compatibility / improvements from 855GME (XTX) to 855GME (ETX) .....	368
Table 201:	Keys relevant to 815E (ETX) BIOS during POST .....	373
Table 202:	Keys relevant to 815E (ETX) BIOS .....	373
Table 203:	Overview of 815E (ETX) BIOS menu items .....	374
Table 204:	815E (ETX) Main setting options .....	375
Table 205:	815E (ETX) IDE Channel 0 Master setting options .....	377
Table 206:	815E (ETX) IDE Channel 0 Slave setting options .....	378
Table 207:	815E (ETX) IDE Channel 1 Master setting options .....	380
Table 208:	815E (ETX) IDE Channel 1 Slave setting options .....	382
Table 209:	815E (ETX) Advanced Menu setting options .....	384
Table 210:	815E (ETX) Advanced Chipset/Graphics Control setting options .....	386
Table 211:	815E (ETX) PCI/PNP Configuration setting options .....	387
Table 212:	815E (ETX) PCI device, slot #1 setting options .....	389
Table 213:	815E (ETX) PCI device, slot #2 setting options .....	390
Table 214:	815E (ETX) PCI device, slot #3 setting options .....	391
Table 215:	815E (ETX) PCI device, slot #4 setting options .....	392
Table 216:	815E (ETX) Memory Cache setting options .....	393

## Table index

Table 217:	815E (ETX) I/O Device Configuration setting options .....	395
Table 218:	815E (ETX) Keyboard Features setting options.....	398
Table 219:	815E (ETX) CPU Board Monitor setting options .....	399
Table 220:	815E (ETX) Miscellaneous setting options .....	400
Table 221:	815E (ETX) Baseboard/Panel Features setting options .....	401
Table 222:	815E (ETX) Panel Control setting options .....	403
Table 223:	815E (ETX) Baseboard Monitor setting options.....	404
Table 224:	815E (ETX) Legacy Devices setting options.....	405
Table 225:	815E (ETX) Security setting options .....	407
Table 226:	815E (ETX) Power setting options .....	409
Table 227:	815E (ETX) ACPI Control setting options .....	411
Table 228:	815E (ETX) Thermal Management .....	412
Table 229:	815E (ETX) Boot setting options .....	414
Table 230:	815E (ETX) Exit setting options .....	415
Table 231:	815E (ETX) Profile overview .....	416
Table 232:	815E (ETX) Main Profile settings overview .....	417
Table 233:	815E (ETX) Advanced Chipset/Graphics Control Profile settings overview.....	418
Table 234:	815E (ETX) PCI/PNP Configuration Profile settings overview .....	418
Table 235:	815E (ETX) Memory Cache Profile settings overview .....	419
Table 236:	815E (ETX) I/O Device Configuration Profile settings overview.....	419
Table 237:	815E (ETX) Keyboard Features Profile settings overview .....	420
Table 238:	815E (ETX) CPU Board Monitor Profile settings overview.....	420
Table 239:	815E (ETX) Miscellaneous Profile settings overview .....	420
Table 240:	815E (ETX) Baseboard/Panel Features Profile settings overview .....	421
Table 241:	815E (ETX) Security Profile settings overview.....	422
Table 242:	815E (ETX) Power Profile settings overview .....	423
Table 243:	815E (ETX) Boot Profile settings overview .....	424
Table 244:	Keys relevant to 855GME (ETX) BIOS during POST .....	427
Table 245:	855GME (ETX) - BIOS relevant keys.....	427
Table 246:	Overview of 855GME (ETX) BIOS menu items.....	427
Table 247:	855GME (ETX) Main setting options.....	428
Table 248:	855GME (ETX) IDE Channel 0 Master setting options .....	430
Table 249:	855GME (ETX) IDE Channel 0 Slave setting options .....	432
Table 250:	855GME (ETX) IDE Channel 1 Master setting options .....	434
Table 251:	855GME (ETX) IDE Channel 1 Slave setting options .....	436
Table 252:	855GME (ETX) Advanced Menu setting options .....	438
Table 253:	855GME (ETX) Advanced Chipset Control setting options.....	439
Table 254:	855GME (ETX) PCI/PNP Configuration setting options.....	442
Table 255:	855GME (ETX) - PCI device, slot #1 - setting options .....	444
Table 256:	855GME (ETX) - PCI device, slot #2 - setting options .....	445
Table 257:	855GME (ETX) - PCI device, slot #3 - setting options .....	446
Table 258:	855GME (ETX) - PCI device, slot #4 - setting options .....	447
Table 259:	855GME (ETX) Memory Cache setting options .....	448
Table 260:	855GME (ETX) I/O Device Configuration setting options .....	450
Table 261:	855GME (ETX) Keyboard Features setting options.....	453
Table 262:	855GME (ETX) - CPU board monitor - setting options .....	454
Table 263:	855GME (ETX) miscellaneous - setting options .....	455

Table 264:	855GME (ETX) Baseboard/Panel Features setting options.....	456
Table 265:	855GME (ETX) Panel Control setting options.....	458
Table 266:	855GME (ETX) - baseboard monitor - setting options.....	459
Table 267:	855GME (ETX) Legacy Devices setting options.....	461
Table 268:	855GME (ETX) Security setting options.....	463
Table 269:	855GME (ETX) Main setting options.....	465
Table 270:	855GME (ETX) ACPI Control setting options.....	467
Table 271:	855GME (ETX) Boot setting options.....	469
Table 272:	855GME (ETX) - exit menu - setting options.....	470
Table 273:	855GME (XTX) profile overview.....	472
Table 274:	855GME (ETX) - main - profile setting overview.....	473
Table 275:	855GME (ETX) - advanced chipset/graphics control - profile settings overview.....	474
Table 276:	855GME (ETX) PCI/PNP Configuration Profile settings overview.....	474
Table 277:	855GME (ETX) - memory cache - profile settings overview.....	475
Table 278:	855GME (ETX) I/O Device Configuration Profile settings overview.....	476
Table 279:	855GME (ETX) - keyboard features - profile setting overview.....	476
Table 280:	855GME (ETX) - CPU board monitor - profile setting overview.....	477
Table 281:	855GME (ETX) - miscellaneous - profile setting overview.....	477
Table 282:	855GME (ETX) Baseboard/Panel Features profile settings overview.....	477
Table 283:	855GME (ETX) Security profile settings overview.....	479
Table 284:	855GME (ETX) - power - profile setting overview.....	479
Table 285:	855GME (ETX) - boot - profile setting overview.....	480
Table 286:	855GME (XTX) - keys relevant to BIOS during POST.....	482
Table 287:	855GME (XTX) keys relevant to BIOS in the BIOS menu.....	482
Table 288:	Overview of 855GME (XTX) BIOS menu items.....	483
Table 289:	855GME (XTX) Main menu setting options.....	484
Table 290:	855GME (XTX) Advanced menu setting options.....	485
Table 291:	855GME (XTX) Advanced ACPI Configuration setting options.....	487
Table 292:	855GME (XTX) Advanced PCI Configuration setting options.....	488
Table 293:	855GME (XTX) Advanced Graphics Configuration setting options.....	490
Table 294:	855GME (XTX) Advanced CPU Configuration setting options.....	492
Table 295:	855GME (XTX) - advanced chipset - setting options.....	493
Table 296:	855GME (XTX) Advanced I/O Interface Configuration setting options.....	494
Table 297:	855GME (XTX) Advanced Clock Configuration setting options.....	496
Table 298:	855GME (XTX) Advanced IDE Configuration setting options.....	497
Table 299:	855GME (XTX) Primary IDE Master setting options.....	499
Table 300:	855GME (XTX) - primary IDE slave - setting options.....	500
Table 301:	855GME (XTX) Secondary IDE Master setting options.....	502
Table 302:	855GME (XTX) Secondary IDE Slave setting options.....	503
Table 303:	855GME (XTX) Advanced USB Configuration setting options.....	505
Table 304:	855GME (XTX) USB mass storage device configuration.....	507
Table 305:	855GME (XTX) - advanced keyboard/mouse configuration - setting options...	508
Table 306:	855GME (XTX) - advanced remote access configuration - setting options.....	509
Table 307:	855GME (XTX) - advanced remote access configuration - setting options.....	511
Table 308:	855GME (XTX) Advanced Baseboard/Panel Features setting options.....	512
Table 309:	855GME (XTX) Panel Control setting options.....	514

## Table index

Table 310:	855GME (XTX) - baseboard monitor setting options .....	515
Table 311:	855GME (XTX) Legacy Devices setting options .....	516
Table 312:	855GME (XTX) Boot menu setting options .....	518
Table 313:	855GME (XTX) Security menu setting options .....	520
Table 314:	855GME (XTX) Hard disk security user password.....	521
Table 315:	855GME (XTX) Hard disk security master password.....	522
Table 316:	855GME (XTX) Power menu setting options .....	523
Table 317:	855GME - (XTX) Exit menu - Setting options .....	525
Table 318:	855GME (XTX) Profile overview .....	527
Table 319:	855GME (XTX) Main profile settings overview.....	528
Table 320:	855GME (XTX) - advanced profile setting options .....	528
Table 321:	855GME - (XTX) PCI configuration - profile setting overview .....	529
Table 322:	855GME - (XTX) Graphics configuration - profile setting overview.....	529
Table 323:	855GME - (XTX) CPU configuration - profile setting overview.....	530
Table 324:	855GME - (XTX) Chipset configuration - profile setting overview.....	530
Table 325:	855GME (XTX) - I/O interface configuration - profile settings overview.....	530
Table 326:	855GME - (XTX) Clock configuration - profile setting overview .....	530
Table 327:	855GME - (XTX) IDE configuration - profile setting overview .....	531
Table 328:	855GME - (XTX) USB configuration - profile setting overview.....	532
Table 329:	855GME (XTX) - keyboard/mouse configuration - profile setting overview.....	532
Table 330:	855GME - (XTX) remote access configuration - profile setting overview.....	533
Table 331:	855GME (XTX) - CPU board monitor - profile setting overview .....	533
Table 332:	855GME (XTX) - baseboard/panel features -profile setting overview .....	533
Table 333:	855GME (XTX) - boot - profile setting overview.....	535
Table 334:	855GME (XTX) - security - profile setting options .....	535
Table 335:	855GME (XTX) - power - profile setting overview.....	536
Table 336:	BIOS post code messages BIOS 815E (ETX) and 855GME (ETX).....	537
Table 337:	BIOS post code messages BIOS 855GME (XTX) .....	537
Table 338:	RAM address assignment .....	539
Table 339:	DMA channel assignment .....	539
Table 340:	I/O address assignment .....	540
Table 341:	IRQ interrupt assignments in PCI mode.....	541
Table 342:	IRQ interrupt assignments in APIC mode .....	542
Table 343:	Inter-IC (I <sup>2</sup> C) bus resources .....	545
Table 344:	Inter-IC (I <sup>2</sup> C) bus resources .....	545
Table 345:	CPU board software versions .....	547
Table 346:	Automation panel link software versions.....	547
Table 347:	Differentiating between 815E (ETX) and 855GME (ETX / XTX) CPU boards..	548
Table 348:	System unit support for buffering with Automation Runtime .....	564
Table 349:	Visual Components video output with different system units .....	565
Table 350:	Model numbers - MS-DOS.....	566
Table 351:	Tested resolutions and color depths for DVI and RGB signals .....	567
Table 352:	Model numbers - Windows XP Professional .....	568
Table 353:	Relationship between driver settings and graphics engine .....	573
Table 354:	Relationship between driver settings and graphics engine .....	575
Table 355:	Model numbers - Windows XP Embedded .....	584
Table 356:	Device functions in Windows XP Embedded with FP2007 .....	585

Table 357:	Model numbers - Windows Embedded Standard 2009.....	588
Table 358:	Device functions in Windows Embedded Standard 2009 .....	589
Table 359:	Model numbers - Windows CE.....	591
Table 360:	Windows CE 5.0 features.....	592
Table 361:	Windows CE 6.0 features.....	593
Table 362:	Overview of standards .....	609
Table 363:	Overview of limits and testing guidelines for emissions .....	611
Table 364:	Test requirements - Network-related emissions for industrial areas .....	612
Table 365:	: Test requirements - Electromagnetic emissions for industrial areas.....	613
Table 366:	Overview of limits and testing guidelines for immunity.....	614
Table 367:	Test requirements - Electrostatic discharge (ESD) .....	615
Table 368:	Test requirements - High-frequency electromagnetic fields (HF field) .....	615
Table 369:	Test requirements - High-speed transient electrical disturbances (burst) .....	616
Table 370:	Test requirements - Surge voltages .....	616
Table 371:	Test requirements - Conducted disturbances .....	616
Table 372:	Test requirements - Magnetic fields with electrical frequencies .....	617
Table 373:	Test requirements - Voltage dips, fluctuations, and short-term interruptions....	618
Table 374:	Test requirements - Damped vibration .....	618
Table 375:	Overview of limits and testing guidelines for vibration.....	619
Table 376:	Test requirements - Vibration during operation .....	619
Table 377:	Test requirements - Vibration during transport (packaged).....	620
Table 378:	Test requirements - Shock during operation .....	620
Table 379:	Test requirements - Shock during transport .....	620
Table 380:	Test requirements - Toppling .....	620
Table 381:	Test requirements - Toppling .....	621
Table 382:	Overview of limits and testing guidelines for temperature and humidity .....	622
Table 383:	Test requirements - Worst case during operation .....	622
Table 384:	Test requirements - Dry heat .....	622
Table 385:	Test requirements - Dry cold.....	622
Table 386:	Test requirements - Large temperature fluctuations .....	623
Table 387:	Test requirements - Temperature fluctuations during operation .....	623
Table 388:	Test requirements - Humid heat, cyclic.....	623
Table 389:	Test requirements - Humid heat, constant (storage).....	623
Table 390:	Overview of limits and testing guidelines for safety .....	624
Table 391:	Test requirements - Ground resistance.....	625
Table 392:	Test requirements - Insulation resistance .....	625
Table 393:	Test requirements - High voltage .....	626
Table 394:	Test requirements - Residual voltage .....	626
Table 395:	Test requirements - Leakage current .....	626
Table 396:	Test requirements - Overload .....	627
Table 397:	Test requirements - Defective component .....	627
Table 398:	Test requirements - Voltage range.....	627
Table 399:	Overview of limits and testing guidelines for other tests .....	628
Table 400:	Test requirements - Protection.....	628
Table 401:	Test requirements - Degree of pollution.....	628
Table 402:	International Certifications.....	631
Table 403:	Model numbers - Accessories.....	633

## Table index

Table 404:	Order data - TB103 .....	638
Table 405:	Technical data - TB103 supply plug .....	638
Table 406:	Order data - 0TB704.9 and 0TB704.91 .....	640
Table 407:	Technical data - TB103 supply plug .....	640
Table 408:	Order data - Lithium batteries .....	641
Table 409:	Technical data - Lithium batteries .....	641
Table 410:	Order data - APC620 interface cover .....	643
Table 411:	Order data - DVI - CRT adapter .....	644
Table 412:	Order data - CompactFlash cards .....	645
Table 413:	Technical data - 5CFCRD.xxxx-06 CompactFlash cards .....	646
Table 414:	Order data - CompactFlash cards .....	650
Table 415:	Technical data - CompactFlash cards 5CFCRD.xxxx-04 .....	651
Table 416:	Order data - CompactFlash cards .....	655
Table 417:	Technical data - CompactFlash cards 5CFCRD.xxxx-03 .....	656
Table 418:	Order data - CompactFlash cards 5CFCRD.xxxx-02 .....	659
Table 419:	Technical data - CompactFlash cards 5CFCRD.xxxx-02 .....	660
Table 420:	Technical data - USB Media Drive 5MD900.USB2-00 .....	669
Table 421:	Contents of delivery - USB Media Drive 5MD900.USB2-00 .....	672
Table 422:	Technical data - 5A5003.03 .....	673
Table 423:	Technical data - USB Media Drive 5MD900.USB2-01 .....	676
Table 424:	Contents of delivery - USB Media Drive - 5MD900.USB2-01 .....	679
Table 425:	Technical data - 5A5003.03 .....	680
Table 426:	Order data - USB flash drives .....	682
Table 427:	Technical data - USB flash drive 5MMUSB.xxxx-00 .....	683
Table 428:	Technical data - USB flash drive 5MMUSB.2048-01 .....	685
Table 429:	Model number - HMI Drivers & Utilities DVD .....	687
Table 430:	Model number - APC620 internal supply cable .....	692
Table 431:	Technical data - 5CAMSC.0001-00 .....	692
Table 432:	Model numbers - DVI cables .....	693
Table 433:	Technical data - DVI cable 5CADVI.0xxx-00 .....	694
Table 434:	Model numbers - SDL cables .....	696
Table 435:	Technical data - SDL cables 5CASDL.0xxx-00 .....	697
Table 436:	Model numbers - SDL cables with 45° plug .....	699
Table 437:	Technical data - SDL cable with 45° plug 5CASDL.0xxx-01 .....	700
Table 438:	Model numbers - SDL cable with extender .....	702
Table 439:	Technical data - SDL cable with extender 5CASDL.0x00-10 .....	703
Table 440:	Model numbers - SDL cable 5CASDL.0xxx-03 .....	706
Table 441:	Technical data - SDL cable 5CASDL.0xxx-03 .....	707
Table 442:	Structure - SDL cable 5CASDL.0xxx-03 .....	709
Table 443:	Model numbers - SDL flex cable with extender .....	711
Table 444:	Technical data - SDL flex cable with extender 5CASDL.0x00-13 .....	712
Table 445:	Model numbers - RS232 cables .....	716
Table 446:	Technical data - RS232 cables .....	716
Table 447:	Model numbers - USB cables .....	718
Table 448:	Technical data - USB cables .....	718
Table 449:	Order data - Uninterruptible power supply .....	721
Table 450:	System unit revisions - Add-on UPS module .....	721



Table 451:	Firmware and software required for the UPS .....	722
Table 452:	Technical data - 5AC600. UPSI-00 .....	724
Table 453:	Technical data - 5AC600. UPSB-00.....	726
Table 454:	Technical data - UPS connection cable .....	730
Table 455:	UPS - Order data .....	732
Table 456:	Ethernet connection ETH .....	733
Table 457:	Ethernet connections ETH1, ETH2, ETH3 .....	735
Table 458:	Model numbers - Replacement fan filters .....	737
Table 459:	Technical data - 5AC600.SRAM-00 .....	738
Table 460:	Single-phase power supplies .....	742
Table 461:	Three-phase power supplies .....	742
Table 462:	Meaning of battery status.....	744
Table 463:	Temperature sensor locations.....	791
Table 464:	Revision information for connecting an external device .....	792
Table 465:	Pin assignments - Connector on main board .....	792
Table 466:	Temperature limits for fan control .....	796



**0**

0AC201.91 .....	43, 158, 633, 641
0PS102.0 .....	48, 637, 742
0PS104.0 .....	48, 637, 742
0PS105.1 .....	48, 637, 742
0PS105.2 .....	48, 637, 742
0PS110.1 .....	48, 637, 742
0PS110.2 .....	48, 637, 742
0PS120.1 .....	48, 637, 742
0PS305.1 .....	48, 637, 742
0PS310.1 .....	48, 637, 742
0PS320.1 .....	48, 637, 742
0PS340.1 .....	48, 637, 742
0TB103.9 .....	42, 633, 638
0TB103.91 .....	42, 633, 638
0TB704.9 .....	633, 640
0TB704.91 .....	633, 640

**4**

4A0006.00-000 .....	43, 158, 633, 641
---------------------	-------------------

**5**

5A5003.03 .....	47, 633, 673, 680
5AC600.485I-00 .....	42
5AC600.CANI-00 .....	42
5AC600.CDXS-00 .....	41, 218
5AC600.CFSI-00 .....	41, 216
5AC600.CFSS-00 .....	41, 228
5AC600.DVDS-00 .....	41, 221
5AC600.DVRS-00 .....	41, 224, 225
5AC600.FA01-00 .....	47, 637, 737
5AC600.FA02-00 .....	48, 637, 737
5AC600.FA03-00 .....	48, 637, 737
5AC600.FA05-00 .....	48, 637, 737
5AC600.FDDS-00 .....	41, 231
5AC600.HDDI-00 .....	40, 195
5AC600.HDDI-01 .....	40, 198
5AC600.HDDI-02 .....	40, 201
5AC600.HDDI-03 .....	40, 204
5AC600.HDDI-04 .....	40, 207
5AC600.HDDI-05 .....	40, 210
5AC600.HDDI-06 .....	40, 213
5AC600.HDDS-00 .....	41
5AC600.HDDS-01 .....	41, 237

5AC600.HDDS-02 .....	41, 240
5AC600.HS01-00 .....	39, 185
5AC600.HS01-01 .....	39, 185
5AC600.HS01-02 .....	39, 185
5AC600.HS02-01 .....	39, 185
5AC600.HS02-02 .....	39, 185
5AC600.HS03-01 .....	39, 185
5AC600.ICOV-00 .....	47, 633, 643
5AC600.SDLO-00 .....	42, 288
5AC600.SRAM-00 .....	47, 633, 738
5AC600.SSDI-00 .....	40, 187
5AC600.UPSB-00 .....	47, 633, 721, 722, 726
5AC600.UPI-00 .....	47, 633, 721, 724
5AC900.1000-00 .....	47, 633, 644
5ACPCI.ETH1-01 .....	47, 633, 733
5ACPCI.ETH3-01 .....	47, 633, 735
5ACPCI.RAIC-00 .....	41, 243
5ACPCI.RAIC-01 .....	41, 251, 252
5ACPCI.RAIC-02 .....	41, 256, 257
5ACPCI.RAIC-03 .....	41, 259, 260, 268
5ACPCI.RAIC-04 .....	41, 264, 265, 272
5ACPCI.RAIC-05 .....	267
5ACPCI.RAIS-00 .....	41, 245
5ACPCI.RAIS-01 .....	41, 248, 249, 250
5CADVI.0018-00 .....	45, 634, 693
5CADVI.0050-00 .....	45, 634, 693
5CADVI.0100-00 .....	45, 634, 693
5CAMSC.0001-00 .....	45, 633, 692
5CASDL.0018-00 .....	45, 634, 696
5CASDL.0018-01 .....	45, 634, 699
5CASDL.0018-03 .....	45, 634, 706
5CASDL.0050-00 .....	45, 634, 696
5CASDL.0050-01 .....	45, 634, 699
5CASDL.0050-03 .....	45, 634, 706
5CASDL.0100-00 .....	45, 634, 696
5CASDL.0100-01 .....	46, 634, 699
5CASDL.0100-03 .....	46, 634, 706
5CASDL.0150-00 .....	46, 634, 696
5CASDL.0150-01 .....	46, 634, 699
5CASDL.0150-03 .....	46, 634, 706
5CASDL.0200-00 .....	46, 634, 696
5CASDL.0200-03 .....	46, 634, 706
5CASDL.0250-00 .....	46, 634, 696
5CASDL.0250-03 .....	46, 634, 706
5CASDL.0300-00 .....	46, 634, 696
5CASDL.0300-03 .....	46, 634, 706
5CASDL.0300-10 .....	46, 634, 702

## Model number index

5CASDL.0300-13.....	46, 634, 711	650	
5CASDL.0400-10.....	46, 635, 702	5CFCRD.8192-06.....	43, 635, 645
5CASDL.0400-13.....	46, 635, 711	5MD900.USB2-00 .....	47, 636, 668
5CAUPS.0005-00 .....	47, 635, 721, 730	5MD900.USB2-01 .....	47, 636, 675
5CAUPS.0030-00 .....	47, 635, 721, 730	5MMDDR.0256-00.....	40, 186
5CAUSB.0018-00 .....	46, 635, 718	5MMDDR.0512-00.....	40, 186
5CAUSB.0050-00 .....	46, 635, 718	5MMDDR.1024-00.....	40, 186
5CFCRD.0032-02.....	44, 636, 659	5MMHDD.0250-00.....	271
5CFCRD.0064-02.....	44, 636, 659	5MMSDR.0128-01.....	40, 186
5CFCRD.0064-03 ....	44, 152, 153, 155, 635, 655	5MMSDR.0256-01.....	40, 186
5CFCRD.0128-02.....	44, 636, 659	5MMSDR.0512-01.....	40, 186
5CFCRD.0128-03 ....	44, 152, 153, 155, 636, 655	5MMSSD.0128-00.....	40, 191
5CFCRD.016G-04 ...	44, 152, 153, 155, 635, 650	5MMUSB.0128-00.....	45, 636, 682
5CFCRD.016G-06 .....	43, 635, 645	5MMUSB.0256-00.....	45, 636, 682
5CFCRD.0256-02.....	44, 636, 659	5MMUSB.0512-00.....	45, 636, 682
5CFCRD.0256-03 ....	44, 152, 153, 155, 636, 655	5MMUSB.1024-00.....	45, 636, 682
5CFCRD.032G-06 .....	43, 635, 645	5MMUSB.2048-00.....	45, 636, 682
5CFCRD.0512-02.....	44, 636, 659	5MMUSB.2048-01 .....	45, 637, 682
5CFCRD.0512-03 ....	44, 152, 153, 155, 636, 655	5PC600.E815-00.....	38, 179
5CFCRD.0512-04 ....	43, 152, 153, 155, 635, 650	5PC600.E815-02.....	38, 179
5CFCRD.0512-06.....	43, 635, 645	5PC600.E815-03.....	38, 179
5CFCRD.1024-02.....	44, 636, 659	5PC600.E855-00.....	38, 181
5CFCRD.1024-03 ....	44, 152, 153, 155, 636, 655	5PC600.E855-01.....	38, 181
5CFCRD.1024-04 ....	43, 152, 153, 155, 635, 650	5PC600.E855-02.....	38, 181
5CFCRD.1024-06.....	43, 635, 645	5PC600.E855-03.....	38, 181
5CFCRD.2048-02.....	44, 636, 659	5PC600.E855-04.....	38, 181
5CFCRD.2048-03 ....	44, 152, 153, 155, 636, 655	5PC600.E855-05.....	38, 181
5CFCRD.2048-04 ....	43, 152, 153, 155, 635, 650	5PC600.FA01-00.....	42, 282
5CFCRD.2048-06.....	43, 635, 645	5PC600.FA02-00.....	42, 283
5CFCRD.4096-03 ....	44, 152, 153, 155, 636, 655	5PC600.FA03-00.....	42, 285
5CFCRD.4096-04 ....	43, 152, 153, 155, 635, 650	5PC600.FA05-00.....	42, 286
5CFCRD.4096-06.....	43, 635, 645	5PC600.SE00-00.....	37
5CFCRD.8192-03 ....	44, 152, 153, 155, 636, 655	5PC600.SE00-01.....	37
5CFCRD.8192-04 ....	43, 152, 153, 155, 635, 650	5PC600.SE00-02.....	37
		5PC600.SF03-00.....	37, 174
		5PC600.SX01-00.....	37, 174
		5PC600.SX02-00.....	37, 174
		5PC600.SX02-01.....	37, 174
		5PC600.SX05-00.....	37, 174
		5PC600.SX05-01.....	37, 174
		5PC600.X855-00.....	39, 183
		5PC600.X855-01.....	39, 183
		5PC600.X855-02.....	39, 183
		5PC600.X855-03.....	39, 183
		5PC600.X855-04.....	39, 183
		5PC600.X855-05.....	39, 183
		5SWHMI.0000-00.....	48, 637, 687

5SWWCE.0512-ENG.....	50, 591	9A0014.05 .....	46, 635, 716
5SWWCE.0513-ENG.....	50, 591	9A0014.10 .....	46, 635, 716
5SWWCE.0612-ENG.....	50, 591	9A0017.01 .....	732
5SWWCE.0613-ENG.....	50, 591	9A0017.02 .....	732
5SWWCE.0812-ENG.....	50, 591	9A0100.11 .....	732
5SWWCE.0813-ENG.....	50, 591	9A0100.14 .....	732
5SWWXP.0412-ENG.....	49, 584	9A0100.15 .....	732
5SWWXP.0413-ENG.....	49, 584	9S0000.01-010 .....	48, 566
5SWWXP.0500-ENG.....	49, 568	9S0000.01-020 .....	49, 566
5SWWXP.0500-GER.....	49, 568	9S0000.08-010 .....	49, 568
5SWWXP.0500-MUL.....	49, 569	9S0000.08-020 .....	49, 568
5SWWXP.0600-ENG.....	49, 568	9S0000.09-090 .....	49, 568
5SWWXP.0600-GER.....	49, 568	9S0001.19-020 .....	49, 584
5SWWXP.0600-MUL.....	49, 568	9S0001.20-020 .....	49, 584
5SWWXP.0712-ENG.....	50, 588	9S0001.27-020 .....	49, 584
5SWWXP.0713-ENG.....	50, 588	9S0001.28-020 .....	49, 584
		9S0001.29-020 .....	50
		9S0001.32-020 .....	50
		9S0001.34-020 .....	50
		9S0001.36-020 .....	50
<b>9</b>			
9A0014.02 .....	46, 635, 716		



**A**

AC97 sound 54, 144, 174, 176, 396, 451, 566  
 ACPI 409, 411, 465, 467, 541, 542, 566, 803  
 Add-on .....58, 62, 89, 95, 145  
 Add-on CAN interface .....274  
 Add-on CompactFlash slot .....216  
 Add-on hard disk .....195, 198  
 Add-on RS232/422/485 interface .....278  
 Add-on UPS .....54, 146  
 Add-on UPS module .....721, 724  
 Address register .....275  
 ADI .....595, 793, 794  
   .NET SDK .....801  
   Development kit .....799  
   Drivers .....595  
 Administrative Tools .....607  
 Air circulation .....297  
 Ambient temperature .....89  
   815E CPU board (ETX) .....89  
   855GME CPU board (ETX) .....93  
   855GME CPU board (XTX) .....93  
 AP Link .....58, 147, 288  
 AP Link cards .....288  
 AP Link Slot .....147  
 APC .....803  
 APC620 embedded .....83, 121  
 APC620 UPS .....720  
 APC620, 1 PCI slot variant .....60  
 APC620, 2 PCI slot variant .....66  
 APC620, 3 PCI slot variant .....72  
 APC620, 5 PCI slot variant .....77  
 API .....803  
 ATX power supply .....156  
 Audio driver .....582  
   Installation .....582  
 Automation Device Interface .....595  
 Automation Runtime .....564, 739, 803

**B**

B&R Automation Device Interface .....595  
 B&R Automation Runtime .....804  
 B&R Control Center .....595  
 B&R Embedded OS Installer .....594  
 B&R Key Editor .....797  
 Backup battery .....158, 641

Barcodes .....163  
 Battery .....158, 641  
   Change .....743  
 Battery operation .....599  
 Battery settings .....601, 603  
 Battery status .....158, 744  
 Battery unit .....47, 633, 726  
   Lifespan .....726  
   Maintenance interval .....726  
 Baud rate .....803  
 Beep codes .....537  
 Beeping code .....537  
 BIOS .....803  
 BIOS 815E (ETX) .....371  
   ACPI control .....411  
   Advanced .....384  
   Advanced chipset/graphics control .....385  
   BIOS setup keys .....373  
   Boot .....414  
   CPU board monitor .....399  
   Exit .....415  
   I/O Device Configuration .....395  
   IDE channel 0 master .....376  
   IDE channel 0 slave .....378  
   IDE channel 1 master .....380  
   IDE channel 1 slave .....382  
   Keyboard Features .....398  
   Legacy devices .....405  
   Main .....375  
   Main board monitor .....404  
   Main Board/Panel Features .....401  
   Memory cache .....393  
   Miscellaneous .....400  
   Panel control .....403  
   PCI device, slot #1 .....389  
   PCI device, slot #2 .....390  
   PCI device, slot #3 .....391  
   PCI device, slot #4 .....392  
   PCI/PNP Configuration .....387  
   Power .....409  
   Profile overview .....416  
   Security .....407  
   Summary screen .....373  
   Thermal management .....412  
 BIOS 855GME (ETX) .....425  
   ACPI control .....467  
   Advanced .....438





RS232 ..... 716  
 SDL ..... 696  
 SDL w/ extender ..... 702  
 SDL with 45° plug ..... 699  
 USB ..... 718  
 Cache ..... 179, 181, 183, 804  
 Cage clamps ..... 135, 638, 640  
 CAN ..... 54, 125, 145, 804  
   Bus length ..... 276  
   Cable type ..... 276  
   Terminating resistor ..... 277  
 CAN address register ..... 275  
 CAN controller ..... 274  
 CAN node ID ..... 126  
 CAN terminating switch ..... 126  
 CD-ROM ..... 804  
 CE mark ..... 804  
 Certifications ..... 631  
 Chipset ..... 179  
 Climate conditions ..... 622  
 CMOS ..... 805  
 CMOS battery ..... 641  
 COM ..... 805  
 COM1 ..... 123, 805  
 COM2 ..... 124, 805  
 COM3 ..... 805  
 CompactFlash ..... 659, 805  
   Calculating the lifespan ..... 662  
   Dimensions ..... 648, 653, 658, 661  
   General information ..... 645, 650, 655, 659  
   Order data ..... 645, 650, 655, 659  
   Technical data ..... 646, 651, 656, 659  
 CompactFlash slot ..... 152, 153, 155  
 Conducted disturbances ..... 616  
 Configure ..... 723  
 Connection cycles ..... 138, 288  
 Connection examples ..... 308  
 Control Center ..... 595, 600, 791  
 CPU ..... 805  
 CPU board 815E (ETX) ..... 179  
 CPU board 855GME (ETX) ..... 181  
 CPU board 855GME (XTX) ..... 183  
 Creating a CompactFlash card for B&R  
 upgrade files ..... 562  
 CTS ..... 806

## D

Damped vibration ..... 618  
 Data loss ..... 61, 67, 73, 78, 84, 156, 817  
 Data register ..... 275  
 DCD ..... 806  
 Deep discharge cycles ..... 27, 727  
 Deep discharge protection ..... 721  
 Deep discharge voltage ..... 726  
 Defective component ..... 627  
 Degree of pollution ..... 628  
 Derating ..... 91, 95  
 Development kit ..... 799  
 Device ID ..... 739  
 Device interfaces ..... 121  
 Dial-up ..... 806  
 Dimension standards ..... 36  
 Dimensions ..... 65  
   1 PCI slot variant ..... 65  
   2 PCI slot variant ..... 71  
   3 PCI slot variant ..... 76  
   5 PCI slot variant ..... 82  
   620 embedded variant ..... 88  
 DIMM ..... 806  
 DIP switch ..... 546  
 Direction of air flow ..... 748, 751, 754, 758  
 Directives ..... 36  
 Display Clone ..... 308  
 Disposal ..... 35  
 Distribution of resources ..... 539  
   DMA channel assignment ..... 539  
   I/O address assignment ..... 540  
   Interrupt assignments ..... 541, 542  
   RAM address assignment ..... 539  
 DMA ..... 806  
 Dongle ..... 160, 397, 452  
 Double layer ..... 224, 676  
 DRAM ..... 806  
 Drilling templates ..... 294  
 Drives ..... 187  
 Dry cold ..... 622  
 Dry heat ..... 622  
 DS1425 ..... 160  
 DSR ..... 806  
 DTR ..... 806  
 Dual display clone .. 316, 331, 340, 345, 349,  
 570, ..... 575, 578, 580

## Index

- DVD ..... 807  
DVI ..... 54, 142, 288, 291, 807  
DVI - CRT adapter ..... 644  
DVI - Monitor adapter ..... 644  
DVI cable ..... 693  
    Cable specifications ..... 695  
DVI-A ..... 807  
DVI-D ..... 807  
DVI-I ..... 807
- E**
- ECSD ..... 442  
EDID ..... 807  
    Data ..... 386, 439, 440  
EIDE ..... 807  
Electromagnetic emissions ..... 613  
Electrostatic discharge ..... 615  
Embedded OS Installer ..... 594  
EMC ..... 807  
Emissions ..... 611, 613  
Energy options ..... 607  
Entire device ..... 60  
EPROM ..... 807  
Equalizer ..... 598  
Error signals ..... 537  
ESD ..... 32, 615  
    Electrical components with housing ..... 32  
    Electrical components without housing .. 32  
    Individual components ..... 33  
    Packaging ..... 32  
    Proper handling ..... 32  
ETH1 ..... 130, 396, 451, 462, 467, 583  
ETH2 ..... 132, 406, 462, 467, 583  
Ethernet ..... 54, 808  
Ethernet cable lengths ..... 131  
ETX ..... 808  
European directives ..... 609  
Extended desktop ..... 58, 308, 316, 331, 337, 340, ..... 341, 345, 346, 349, 573, 578, 793
- F**
- Fan connection cable ..... 749  
Fan kit cover ..... 757  
Fan kit installation ..... 747  
Fan kit replacement ..... 747  
Fan kits ..... 282  
    1 PCI variant ..... 282  
    2 PCI variant ..... 283  
    5 PCI variant ..... 286  
Fastening bolts ..... 748  
FDD ..... 808  
Features ..... 54  
Fiber optic cable ..... 150  
Fiber optics ..... 808  
FIFO ..... 808  
Filter clasp ..... 42, 752, 756  
Firmware ..... 555, 722, 808  
Flex radius ..... 306, 630, 716, 718, 730  
Floating Point Unit ..... 179, 181, 183  
Floppy ..... 808  
FPC ..... 809  
FPD ..... 809  
Free fall ..... 621  
Front cover ..... 673, 680  
Front side bus ..... 179  
FTP ..... 809  
Full size ..... 27  
Full Speed ..... 133, 134
- G**
- GB ..... 809  
Graphics ..... 180, 182, 184  
Graphics driver installation ..... 570  
    815E CPU board ..... 570  
Graphics driver settings .. 312, 316, 319, 322, 327, ..... 331, 336, 340, 345, 349  
Graphics drivers ..... 570  
Graphics engine 1 .. 418, 439, 440, 474, 573, 575  
Graphics engine 2 ... 440, 474, 566, 573, 575  
Ground resistance ..... 625  
Grounding concept ..... 307
- H**
- Half-size ..... 54  
Handshake ..... 809  
Hard Disk ..... 153, 175, 195, 198, 233, 236  
Hardware Security Key ..... 160

- HDD ..... 150, 809  
Heat sink ..... 185  
    Exchanging ..... 185  
    Types ..... 185  
HF field ..... 615  
Hibernate ..... 150, 151  
High speed ..... 133, 134  
High voltage ..... 626  
High-frequency electromagnetic fields ..... 615  
High-speed transient elect. disturbance value  
616  
Hot Plug ..... 157  
Hot surface ..... 66, 72  
Humid heat, constant ..... 623  
Humid heat, cyclic ..... 623
- I**
- I/O address assignment ..... 540  
IDE ..... 809  
Identification ..... 163  
Immunity ..... 614  
Individual components ..... 174  
    AP Link cards ..... 288  
    CPU boards 815E (ETX) ..... 179  
    CPU boards 855GME (ETX) ..... 181  
    CPU boards 855GME (XTX) ..... 183  
    Drives ..... 187  
    Fan kits ..... 282  
    Heat sink ..... 185  
    Interface options ..... 274  
    Main memory ..... 186  
    RAID system ..... 242  
    System unit ..... 174  
Installation ..... 297  
Installing the UPS service ..... 599  
Insulation resistance ..... 625  
Interface cover ..... 643  
Interface options ..... 274  
Interrupt assignments ..... 541, 542  
ISA ..... 809  
ISO ..... 809
- J**
- Jitter ..... 810
- Jumper ..... 810
- K**
- KCF ..... 576  
Key configuration file ..... 576  
Key editor ..... 797  
Keyboard ..... 157
- L**
- L1 cache ..... 179, 181, 183  
L2 cache ..... 179, 181, 183  
LCD ..... 810  
Leakage current ..... 626  
LED ..... 150, 810  
Lifespan  
    CompactFlash ..... 662  
Line IN ..... 144  
Line OUT ..... 144  
Lithium battery ..... 158  
Locking time ..... 576  
Low battery shutdown ..... 608  
Low speed ..... 133, 134  
LPT ..... 810
- M**
- Magnetic fields with electrical frequencies ....  
617  
Main memory ..... 54, 186  
Maintenance Controller Extended .. 175, 177,  
793  
Maintenance free rechargeable batteries 721  
Maintenance interval ..... 27, 726  
Manual history ..... 23  
MAXIM ..... 160  
Maximum memory capacity ..... 186  
MB ..... 810  
Mechanical conditions ..... 619  
Memory capacity ..... 186  
Messages ..... 537, 607  
MIC ..... 144  
Microprocessor ..... 811  
MIPS ..... 811  
Mkey ..... 811

## Index

- Model numbers ..... 37
- Monitor / Panel ..... 138
- Motherboard ..... 811
- Mounting orientation ..... 293, 297
  - Optional mounting ..... 299
  - Standard mounting ..... 297
- Mounting plates ..... 293
- Mounting rail brackets ..... 668, 675
- Mounting screws ..... 66, 72
- Mounting the side cover ..... 781
  - APC620 with 1 PCI slot ..... 781
  - APC620 with 2 PCI slot ..... 782
  - APC620 with 3 PCI slot ..... 783
  - APC620 with 5 PCI slot ..... 784
- Mouse ..... 157
- MS-DOS ..... 566
- MS-DOS Boot diskette ..... 558
- MTBF ..... 811
- MTCX ..... 156, 175, 177, 793, 811
- Multi-language ..... 568
- Multitasking ..... 811
  
- N**
- Network driver ..... 583
  - Installation ..... 583
- Network-related emissions ..... 612
- NMI ..... 274
  
- O**
- OEM ..... 811
- OPC ..... 811
- OPC server ..... 812
- Optional mounting orientations ..... 299
- Over-current shutdown ..... 608
- Overload ..... 135, 627
  
- P**
- Panel ..... 812
- Panel locking time ..... 576, 578, 580
- Parallel port ..... 160
- Part subject to wear 158, 282, 283, 284, 285, 286, ..... 641, 726, 737
- PCI ..... 812
- PCI configuration space ..... 739
- PCI Ethernet card ..... 733, 735
- PCI half-size standard ..... 147
- PCI slot ..... 147
- PCMCIA ..... 812
- Permanent magnet ..... 61, 67, 73, 78, 84
- PLC ..... 812
- PnP ..... 812
- POH ..... 812
- POST ..... 813
- Post codes ..... 537
- Power ..... 97, 101, 150, 151
  - APC620 systems, 1 PCI slot ..... 97
  - APC620 systems, 2 PCI slots ..... 101
  - APC620 systems, 3 PCI slots ..... 107
  - APC620 systems, 5 PCI slots ..... 109
- Power button 97, 99, 101, 104, 107, 109, 113, ..... 117, 156, 175, 177, 410, 466
- Power management ..... 97, 101
- Power supplies ..... 741
- Power supply ..... 741
- POWERLINK ..... 53, 54, 127, 813
  - Station number ..... 129
  - Status / Error LED ..... 127
- Procedure following power failure ..... 608
- Programs ..... 35
- Protection type ..... 628
- PS/2 ..... 157
  - Keyboard ..... 157
  - Mouse ..... 157
  - Y-cable ..... 157
  
- Q**
- QUXGA ..... 813
- QVGA ..... 813
- QWUXGA ..... 813
- QXGA ..... 815
  
- R**
- RAID ..... 251, 259, 267
- RAM ..... 813
- Real time ..... 813
- Real-time clock .54, 158, 175, 177, 179, 182, 184

Removal strips .....	744, 745	Cable specifications .....	698
Replacement fan .....	737	SDL equalizer .....	598
Replacement PCI SATA RAID HDD .....	271	SDL flex cable with extender .....	711
Replacing the main memory .....	186	SDRAM .....	186, 814
Requirements for emissions .....	611	Security Key .....	160
Requirements for immunity to disturbances ..	614	Selection guide .....	56
Reset button .....	156, 175, 177	Self discharging .....	158, 743
Residual voltage .....	626	Sequential Function Chart .....	814
Reverse polarity protection .....	135	Serial number .....	163
RGB .....	54, 138, 142, 288, 567, 569, 576	Services .....	607
ROM .....	814	SFC .....	814
RS232 .....	279, 814	Shock during operation .....	620
Bus length .....	279	Shock during transport .....	620
Cable type .....	279	Short circuit protection .....	724
RS232 cable .....	716	Short-term interruptions .....	618
Cable specifications .....	717	Shutting down .....	607
RS232/422/485 .....	145	Side cover .....	757
RS422 .....	279, 814	Single-phase power supplies .....	742
Bus length .....	279	Slide-in CD-ROM .....	217
Cable type .....	279	Slide-in CF 2-slot .....	228
RS485 .....	280, 814	Slide-in DVD-ROM/CD-RW .....	220
Bus length .....	280	Slide-in hard disk .....	233, 236, 239
Cable type .....	280	Slide-in slot 1 .....	161
RTC .....	54, 158, 175, 177, 179, 182, 184	Slide-in slot 2 .....	162
RTS .....	814	Slide-in USB FDD .....	230
RXD .....	814	Slot PLC .....	815
		Smart Display Link .....	54, 138, 143, 292
		SO-DIMM .....	186
		Soft-off .....	150, 151
		SoftPLC .....	815
		SRAM .....	47, 633, 815
		SRAM module .....	738
		Driver support .....	739
		Installation .....	740
		Technical data .....	738
		Standard keypad module .....	815
		Standard mounting .....	297
		Standard shutdown .....	608
		Standards .....	609
		Overview .....	609
		Standards and certifications .....	609
		Starting current .....	136, 175, 177
		Station number .....	129
		Status LED .....	150
		CF .....	151
		HDD .....	150
		Link .....	151

## Index

Link 1 ..... 150, 151  
Link 2 ..... 150  
Power ..... 150, 151  
Status LEDs ..... 151  
Status LEDs CAN / X2X ..... 127  
Structure ..... 55  
Supply voltage ..... 54, 135  
Supply voltage connectors ..... 638  
Surface temperature .60, 66, 72, 77, 83, 218, 222  
Surge ..... 616  
Surge voltages ..... 616  
Suspend-to-disk ..... 150, 151  
SUXGA ..... 815  
SVGA ..... 815  
Switch ..... 815  
Switching power supply ..... 741  
SXGA ..... 815  
SXGA+ ..... 815  
System units ..... 815

## T

Task ..... 816  
TCP/IP ..... 816  
Temperature ..... 791  
Temperature fluctuations ..... 623  
    Operation ..... 623  
Temperature monitoring ..... 92, 96  
Temperature sensor ..... 721, 791  
Temperature sensor locations ..... 791  
Terminating LED ..... 126  
Terminating resistor ..... 126, 277  
Terminating switch ..... 126  
TFT display ..... 816  
Three-phase power supplies ..... 742  
Toppling ..... 620  
Torsion ..... 629  
Touch driver settings 312, 316, 319, 322, 327, ..... 331, 336, 340, 345, 349  
Touch screen ..... 816  
Touch screen driver  
    Dual display clone ..... 580  
    Extended desktop ..... 578  
Touch screen driver installation ..... 578  
Turn-off time ..... 607  
TXD ..... 816

## U

UART ..... 816  
UDMA ..... 816  
Uninterruptible power supply ..... 720  
UPS 47, 54, 97, 99, 101, 104, 107, 110, 114, 117, ..... 146, 150, 555, 765, 817  
UPS configuration ..... 599  
UPS connection cable ..... 722, 730  
UPS driver ..... 600  
UPS installation ..... 725, 765  
    APC620, 1 PCI slot ..... 765, 774  
    APC620, 2 PCI slot ..... 768, 776  
    APC620, 5 PCI slot ..... 771, 778  
UPS monitor ..... 600  
UPS status ..... 608  
UPS status values ..... 600  
UPS system settings ..... 604  
USB ..... 817  
USB 2.0 ..... 133, 134  
USB cable ..... 718  
    Cable specifications ..... 719  
USB flash drive ..... 682  
    General information ..... 682  
    Order data ..... 682  
    Technical data ..... 683, 685  
USB flash drive for B&R update files ..... 560  
USB Media Drive ..... 668, 675  
    Dimensions ..... 671, 678  
    Dimensions with front cover ..... 672, 679  
    Installation ..... 673, 680  
    Interfaces ..... 672, 679  
    Mounting orientation ..... 673, 680  
    Technical data ..... 669, 676  
USB peripheral devices ..... 359  
USB port ..... 133, 134  
User serial ID ..... 402, 457, 513  
UXGA ..... 817

## V

Vendor ID ..... 739  
Ventilation holes ..... 293  
VGA ..... 817  
Vibration during transport ..... 620  
Vibration operation ..... 619  
Video signals ..... 138

Viruses .....	35	Graphics drivers .....	586
Voltage dips .....	618	Installation .....	586
Voltage fluctuations .....	618	Network driver .....	587
Voltage range .....	627	Touch screen driver .....	586, 590
<b>W</b>		Windows XP Professional .....	568
Wake On LAN .....	467	Audio driver .....	582
White Paper .....	662	FAQ .....	569, 576
Windows CE .....	591, 817	Graphics drivers .....	570
Embedded OS Installer .....	594	Installation .....	569
General information .....	591	Network driver .....	583
Installation .....	594	Touch screen driver .....	578
Windows CE 5.0		Worst case .....	622
Features .....	592	WSXGA .....	817
Windows CE 6.0		WUXGA .....	817
Features .....	593	WXGA .....	818
Windows XP Embedded .....	584	<b>X</b>	
Audio driver .....	586	X2X .....	53, 54, 125
FAQ .....	587	XGA .....	818
General information .....	584	XTX .....	818

