

DE

Torsteuerung

BK 150 FUE - 1 / AK 500 FUE - 1

EN

Door control

BK 150 FUE - 1 / AK 500 FUE - 1

FR

Commande de porte

BK 150 FUE - 1 / AK 500 FUE - 1

NL

Deurbesturing

BK 150 FUE - 1 / AK 500 FUE - 1

ES

Cuadro de maniobra para puertas

BK 150 FUE - 1 / AK 500 FUE - 1

IT

Centralina di comando portone

BK 150 FUE - 1 / AK 500 FUE - 1

PT

Comando do portão

BK 150 FUE - 1 / AK 500 FUE - 1

Contents

1	About these Instructions 26	11	Overview of messages 38
1.1	Further applicable documents 26	11.1	General errors..... 38
1.2	Warnings used..... 26	11.2	Internal system-induced errors F.9x× 40
1.3	Symbols used..... 26	11.3	Information messages..... 40
1.4	Abbreviations used..... 26		
1.5	Colour codes for cables, individual strands and components 26	12	Application parameters
2	Safety Instructions 26	BK / BS 150 FUE-1 / AK/AS 500 FUE-1 43	
2.1	General description and intended use 27	12.1	Intermediate Stop..... 43
2.2	Qualification of personnel..... 27	12.2	UPS emergency opening..... 43
2.3	Standards and regulations 27	12.3	Input function IN3..... 43
2.4	General safety instructions..... 27	12.4	Applikationsparameter „Ampelfunktion“ A.710 / A.720 43
2.5	Safety instructions for operation 27	13	Technical data 43
2.6	Safety instructions for maintenance and troubleshooting 27	14	Plug-in type traffic detector 45
3	Fitting the control 27	General 45	
4	Electrical connection 28	14.1	General 45
4.1	Connecting the supply voltage BK/BS 150 FUE-1 29	14.2	Adjustment options 45
4.2	Connecting the supply voltage AK/AS 500 FUE-1 30	14.3	Connections 46
4.3	Motor connection 30	14.4	Outputs and LED display 46
4.4	Overview of outputs 31	14.5	Technical data 46
4.5	Overview of inputs 31	15	Radio remote control 868 MHz 46
4.6	Connecting the safety strip 31	15.1	Receiver..... 46
4.7	Connecting the limit switch 31	16	Light grille Lx×xF 47
5	Steuerungstausch 32	16.1	Initial start-up and adjustment 47
5.1	Steuerungstausch bei BK 150 FUE-1 / AK 500 FUE-1 32	16.2	Output logic 47
5.2	Steuerungstausch bei BS 150 FUE-1 / AS 500 FUE-1 32	16.3	LED display 47
6	General operation information for parameterisation 33	16.4	Troubleshooting..... 47
7	Customer parameters 33	17	RadioCrash switch 47
7.1	Counter..... 33	17.1	Technical data: Transmitter module..... 47
7.2	Hold-open phase..... 33	17.2	Technical data: Receiver module 47
7.3	Correct travel limit 33	17.3	Function description..... 48
7.4	Error memory..... 34		
7.5	Software version..... 34		
7.6	Serial number 34		
8	Initial Start-Up 34		
8.1	with absolute encoder..... 34		
8.2	with mechanical limit switches..... 34		
8.3	Requesting new teach-in for limit stops 34		
9	Parameters of the service level 34		
9.1	Parameter setting at service level 34		
9.2	Phases..... 34		
9.3	UPS self-test 35		
9.4	Motor settings 35		
9.5	Power increase / boost 35		
9.6	Limit stop correction 35		
9.7	Speeds 35		
9.8	Cross-traffic input P.5 × 0 / P.A × 0 = 9 optional..... 35		
9.9	Diagnostic display on the screen 36		
9.10	USB functions 36		
9.11	Maintenance counter..... 36		
9.12	Operating mode of the control..... 37		
9.13	Factory setting / original parameter 37		
9.14	Password..... 37		
10	Parameter overview 37		

With this edition, all previous editions become invalid.
The specifications in this document may be modified without notice.
The installation recommendations contained in this document are based on the assumption of most favourable surrounding conditions.

Dear Customer,
We are delighted that you have chosen a quality product from our company.

1 About these Instructions

These instructions are divided into a text section and an illustrated section. The illustrated section can be found after the text section.

These instructions are **original operating instructions** as outlined in the EC Directive 2006/42/EC. Read through all of the instructions carefully, as they contain important information about the product. Pay attention to and follow the instructions provided, particularly the safety instructions and warnings.

Please keep these instructions in a safe place and make sure that they are available to all users at all times.

The manufacturer is not liable for any damage caused as a result of non-compliance with the operating instructions and the information contained therein or due to non-customary use of the industrial door.





Competent operation and proper maintenance influence the performance and availability of your industrial door to a considerable degree. Operating errors and inadequate maintenance will lead to avoidable failures. Only competent operation and proper maintenance will guarantee satisfactory, long-term operational safety.

Our customer service department will be happy to assist you. Please contact them if you have any questions after working through these operating instructions.



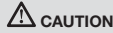

1.1 Further applicable documents

Depending on the ordered accessories, the delivery includes further instructions, e.g. a wiring diagram of the control. Also read these instructions carefully and thoroughly. Pay attention to and follow the instructions provided herein, particularly the safety instructions and warnings.

1.2 Warnings used

	The general warning symbol indicates a danger that can lead to injury or death . In the text section, the general warning symbol will be used in conjunction with the caution levels described below. In the illustrated section, an additional instruction refers back to the explanation in the text section.
	DANGER Indicates a danger that can immediately lead to death or serious injuries.
	WARNING Indicates a danger that can lead to death or serious injuries.
	CAUTION Indicates a danger that can lead to minor or moderate injuries.
	ATTENTION Indicates a danger that can lead to damage or destruction of the product .

1.3 Symbols used

	Warning of dangerous electrical voltage
	See separate fitting instructions for the control or for the additional electrical control elements
	Hot surface
	Danger from electrostatic discharge

1.4 Abbreviations used

EN	European standard
OFF	Finished floor level
DES	Absolute encoder
UPS	Uninterruptible power supply
r	Read only
w	Read and write

1.5 Colour codes for cables, individual strands and components

The colour abbreviations for cable and strand identification and for components conform to the international colour code in accordance with IEC 757:

BK	Black	PC	Pink
BN	Brown	RD	Red
BU	Blue	SR	Silver
GD	Gold	TQ	Turquoise
GN	Green	VT	Violet
GN / YE	Green / yellow	WH	White
GY	Grey	YE	Yellow
OG	Orange		

2 Safety Instructions

When used properly and for the intended purpose, industrial door controls are reliable and safe to operate. Nevertheless, when used incorrectly or for purposes other than those intended, they can pose a risk. We therefore expressly draw your attention to the safety instructions contained in the individual sections.

2.1 General description and intended use

The device described below consists of an electronic control for motor-operated doors used for industrial or commercial purposes in accordance with EN 13241. The control was designed for the operation of an asynchronous motor with a performance range of up to 1.5 kW with a 230 V power supply. Due to the complete integration of a frequency converter power amplifier, the door can be operated with variable opening and closing speeds without strain on the mechanics.

In addition to the control of the motor that operates the door, depending on the intended purpose the control unit can be used for the following additional tasks:

- Positioning the door on and between its travel limits (open, close and intermediate positions)
- Movement of the operator with different speeds (integrated frequency converter)
- Evaluation of safety sensors on the door (e.g. closing edge monitoring, intel trap guard, etc.)
- Evaluation of additional safety mechanisms on the door (e.g. photocells, light grilles, etc.)
- Evaluation of command units on the door (e.g. pull switches, radio, induction loops, etc.)
- Evaluation of emergency stop command units
- Supply of sensors and command units with electronically secure 24 V safety low voltage
- Supply of external devices with 230 V
- Control of application-specific outputs (e.g. relays for door position reporting)
- Creation and output of diagnosis reports
- Setting of application-specific parameters at various access levels for different user groups
- Control of input / output extension modules
- TST SFFE: Radio remote control plug-in module
- TST SUVEK: Induction loop evaluator plug-in module
- TST RFUxCom: Interface module for dock applications, etc..
- TST RFUxK: Universal display and input / output module
- TST LCD / Plain text: Plain text displays with 2x16 characters
- Evaluation of interface signals for the remote control of the door
- Diagnosis, parameterisation and programme update via an integrated USB interface

The intended use also includes paying attention to these instructions and observing inspection and maintenance conditions.

Any other or further use is regarded as non-intended use. The manufacturer / supplier is not liable for any damage resulting from this. The risk is borne solely by the user.

2.2 Qualification of personnel

Only qualified and instructed personnel may fit, operate and maintain the industrial door.

Before commencing work the assigned personnel must have read these instructions, particularly section 2.

For safety reasons, specify distinct responsibilities for operation, maintenance and repairs to ensure that there are no unclear assignments.

2.3 Standards and regulations

As the operator or owner of the door system, you are responsible for ensuring that the following regulations are observed and complied with (without any claim to completeness).

European Standards

EN 12445	Doors – Safety in use of power operated doors: Test methods
EN 12453	Doors – Safety in use of power operated doors: Requirements
EN 12604	Doors – Mechanical Aspects – Requirements
EN 12978	Doors – Protective Devices for Power-Operated Doors – Requirements and Test Methods
EN 13849	Safety of machinery – Safety-related parts of control systems
EN 60335-1	Safety of electrical equipment for domestic use and similar purposes – part 1: General requirements
EN 61000-6-2	Interference immunity, industrial sector
EN 61000-6-3	Interference emission, residential area
EN 61000-6-4	Interference emission, industrial sector
EN 61508	Functional safety of electrical / electronic / programmable electronic safety-related systems

VDE Regulations

VDE 0113	Electrical installations with electronic equipment
VDE 0700	Safety of electronic devices for domestic use and similar purposes

Accident prevention regulations

BGV A3	Electrical installations and equipment
ASR A1.7	Technical Rules for Workplaces

Type test

Confirmed by TÜV certificate and manufacturer's CE.

The standard version available at the time of the type test applies.

2.4 General safety instructions

- In addition, also observe the generally applicable statutory regulations and other binding regulations for accident prevention and environmental protection, country-specific regulations, and the recognised specialist technical rules for safe and competent working must be observed. Before beginning work, instruct personnel in accordance with these rules and regulations.
- Always keep these instructions ready at hand at the location where the industrial door is used.
- Without the supplier's prior approval, do not carry out any modification, attachment or conversion work on the industrial door which might compromise safety.
- Do not make any modifications to the software of programmable control systems.
- The location and operation of fire extinguishers must be indicated by appropriate information signs. Observe the statutory fire alarm and fire-fighting regulations.
- All work on the industrial door (such as maintenance, cleaning work and inspections) may only be performed during an operational shutdown.
- Only qualified electricians may work on the electrical connections.
- **Before undertaking any work, disconnect the system from the mains supply and ensure that it cannot be inadvertently turned on. If any, deactivate the emergency opening lever.**

2.5 Safety instructions for operation

- Before actuating the door, make sure that no persons or objects are located in the door's area of travel.
- Do not reach into the guide or guide area while the door is in operation.
- Only actuate the industrial door if it is safe and functional. All protective devices and safety-related devices (e.g. detachable protective devices and emergency-off devices) must be present and functioning.
- Do not modify or put the safety devices out of operation.

2.6 Safety instructions for maintenance and troubleshooting

- Perform the described inspection and maintenance work. Comply with the maintenance intervals and note the information on the replacement of parts / partial equipment.
- Maintenance and troubleshooting may only be carried out by specialist personnel.
- Only use spare parts that comply with the technical requirements specified by the manufacturer. This is always guaranteed when original spare parts are used.

3 Fitting the control

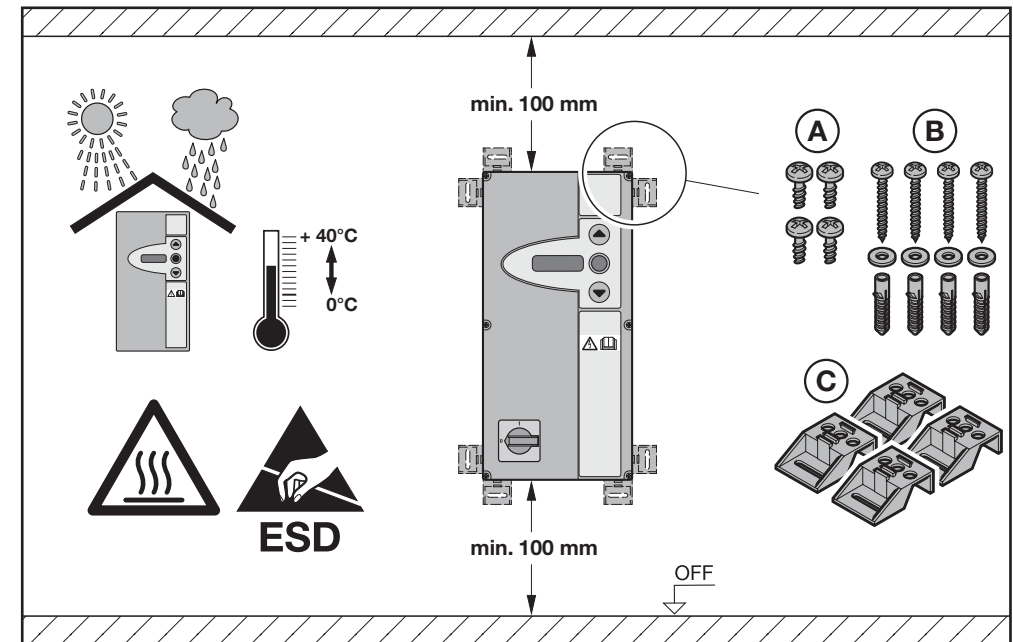

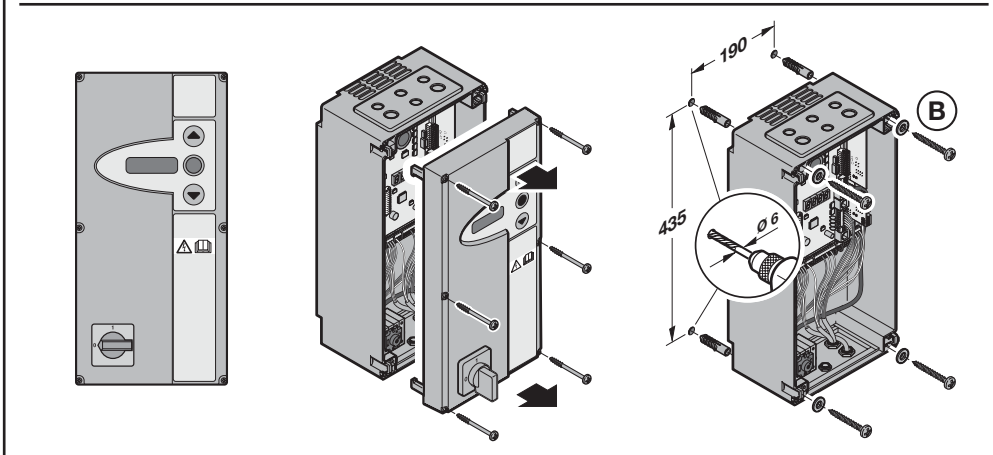
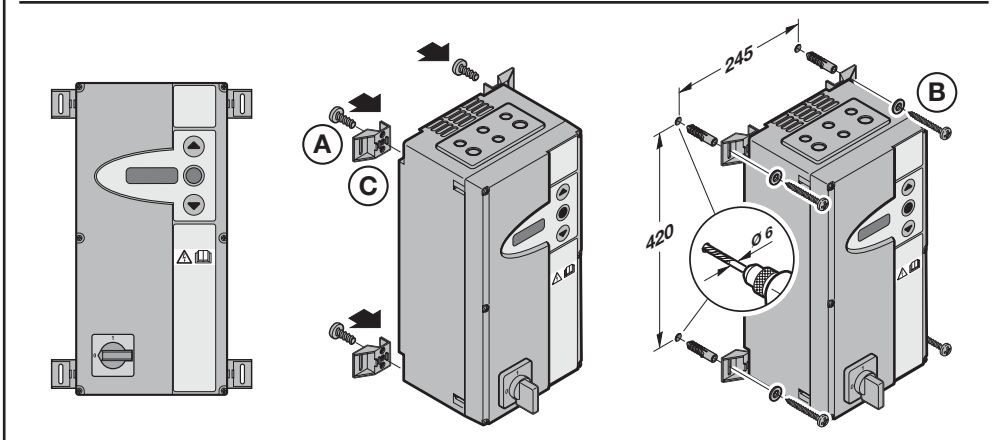
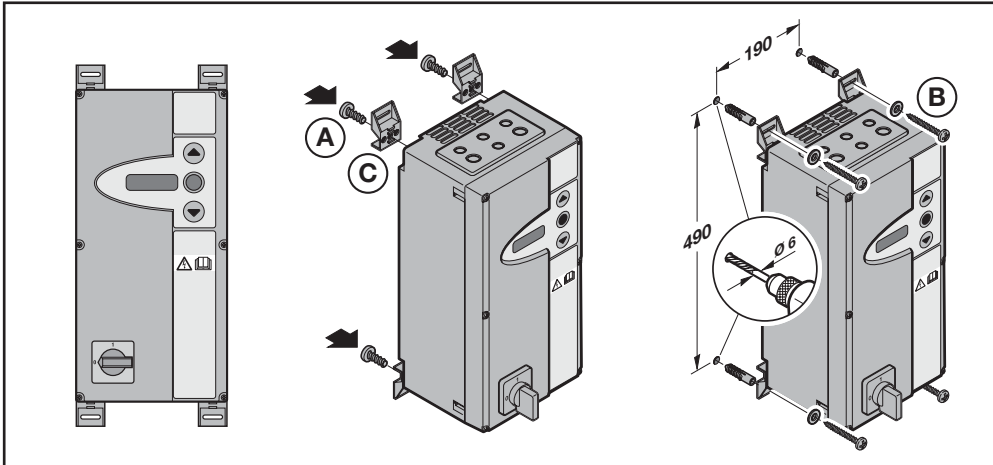

ATTENTION

- ▶ Touching the electronic components, especially those of the processor circuit, is prohibited. Electronic components may be damaged or destroyed by electrostatic discharge.
- ▶ Before opening the housing cover, make sure that no bore chips or similar objects, lying on the cover for example, can fall into the housing.
- ▶ Fit the control without distortion.
- ▶ Close unused cable entries by suitable measures to maintain the housing's IP 54 protection category. Do not subject the cable entry points to any loads, particularly tensile loads.
- ▶ Operating the control with a dismantled CEE plug is only permitted if the mains supply can be disconnected from the control at all poles via a suitable switch. The mains plug or the replacement switch used must be easily accessible.
- ▶ To avoid danger, the connecting cable of the unit, if damaged, must be replaced by the manufacturer or a similarly qualified person (in line with connection type Y according to EN 60335-1).
- ▶ When the door is moving in press-and-hold operation, ensure that the door area can be monitored by the operator. In this operating mode, safety equipment such as safety strips and photocells may not be functional. If this is not possible for constructional reasons, ensure that this operating mode is only accessible to staff that has been instructed accordingly or disable the function entirely.

⚠ WARNING

- ▶ The control may only be opened if the supply is disconnected at all poles. It is prohibited to connect or operate the control when it is open.
- ▶ Switch off all power supply circuits before accessing the connecting terminals.
- ▶ Before fitting, check the control for shipping damage or other damage. In some cases, damage inside the control may cause considerable consequential damage to the control and even endanger the health and safety of the user.

4 Electrical connection

ATTENTION

- ▶ After completing the wiring and before switching on the control for the first time, check whether all motor connections on the control side and on the motor side are tightened and the motor is correctly connected in star or triangle. Loose motor connections cause damage to the converter. If the 24 V control voltage is short-circuited or extremely overloaded, the power supply unit will not switch on even though the intermediate circuit capacitors are charged. The displays remain unlit. The power supply unit can only be switched on after the short-circuit or extreme overload has been remedied.
- ▶ For compliance with EMC directives, only shielded, separate motor cables may be used. The shield must be connected on both sides (motor and control) and no additional connections may be led in the cable. Maximum cable length: 20 m.
- ▶ If the control is covered in condensation, do not connect or operate it. This can destroy the control.
- ▶ Before connecting the control supply for the first time, ensure that the evaluator cards (plug-in modules) are plugged in the correct position. The control may be damaged if the cards are not plugged correctly or are twisted, or if non-approved cards from other manufacturers are used.
- ▶ Do not operate a control with damaged keypad or display. Damaged keypads and display must be replaced. To prevent damage to the keypad, do not operate it with sharp objects. The keypad is designed for finger operation only.
- ▶ **Maximum connection cross-sections of the circuit board terminals:**

	Single wire (rigid)	Finely stranded (with / without wire end ferrule)	Maximum fastening torque Nm
Motor plug terminals	2.5	2.5	0.5
Mains voltage & PE	2.5	1.5	0.5
Screw-type terminals (grid 5 mm)	2.5	1.5	0.5
Plug terminals (grid 5 mm)	1.5	1.0	0.4
Plug terminals (grid 3.5 mm)	1.5	1.0	0.25



WARNING

- ▶ After the control is switched off, dangerous voltage is still present for up to 5 minutes.
- ▶ A defective power supply unit may considerably increase the discharge time of the intermediate circuit capacitors. Discharge times of up to 10 minutes may result.
- ▶ After completion of the installation, make sure that the system is set correctly and that the safety system functions properly.
- ▶ Do not operate the control without a connected protective earth conductor. If the protective earth conductor is not connected, dangerously high voltages occur on metal control housings, due to leakage capacities. The protective earth conductor must be connected according to EN 50178, paragraph 5.2.11.1 for increased leakage currents >3.5 mA.
- ▶ Areas of the processor circuits are directly linked galvanically to the power supply. This must be considered when carrying out any possible control measurements (do not use measurement instruments with PE reference of the measuring circuit).
- ▶ If the voltage-free contacts of the relay outputs or other contact points are externally fed, e.g. operated with a dangerous voltage that may still be present after switching off the control or pulling the mains plug, a respective warning label must be clearly visible on the control housing.
- ▶ **“WARNING! Disconnect all power supply circuits before accessing the connecting terminals.”**
- ▶ Voltage may still be present at the motor terminals even when at a standstill or after the emergency-off has been actuated.

4.1 Connecting the supply voltage BK/BS 150 FUE-1

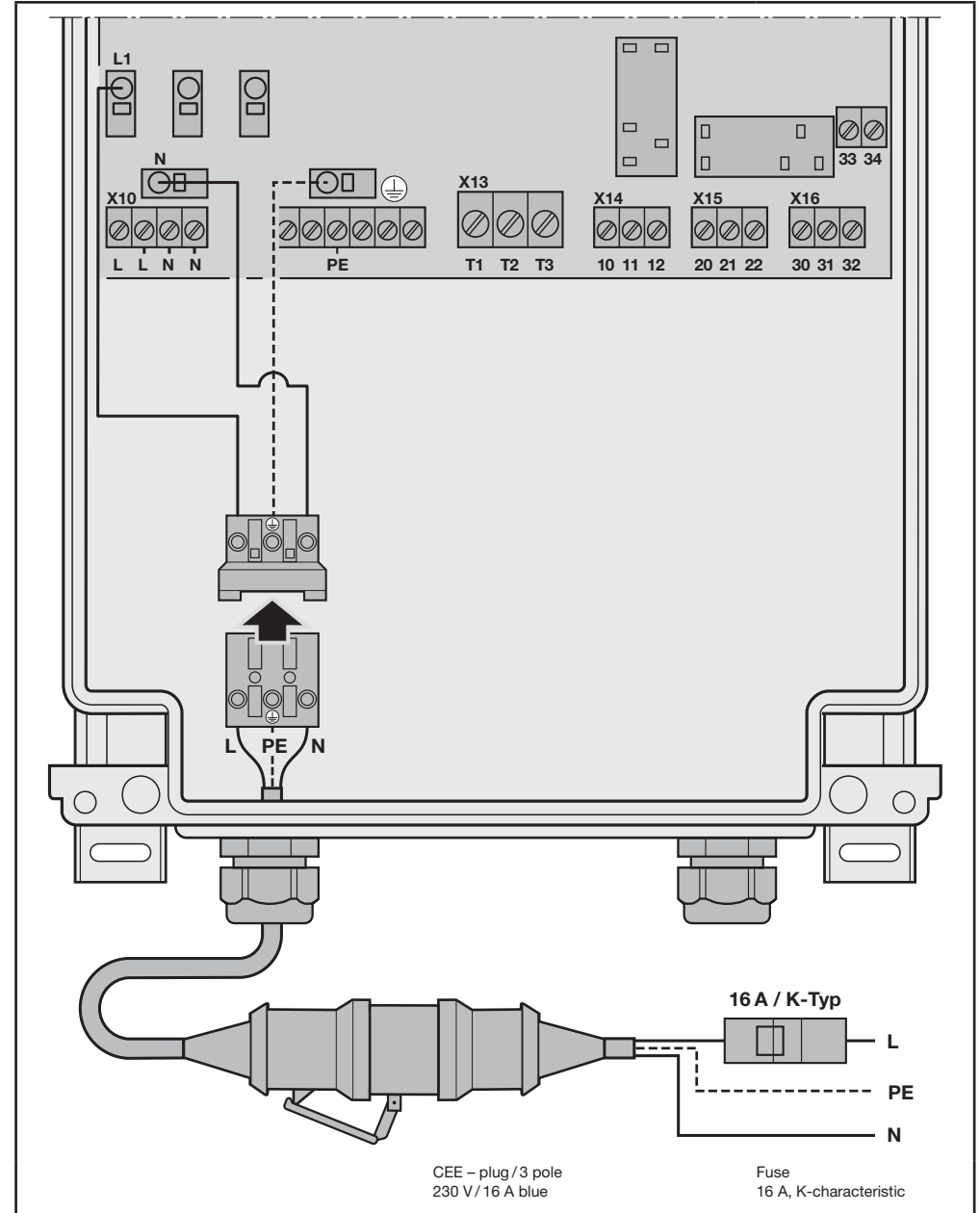

The mains plug must be visible and accessible from the control.

4.2 Connecting the supply voltage AK/AS 500 FUE-1

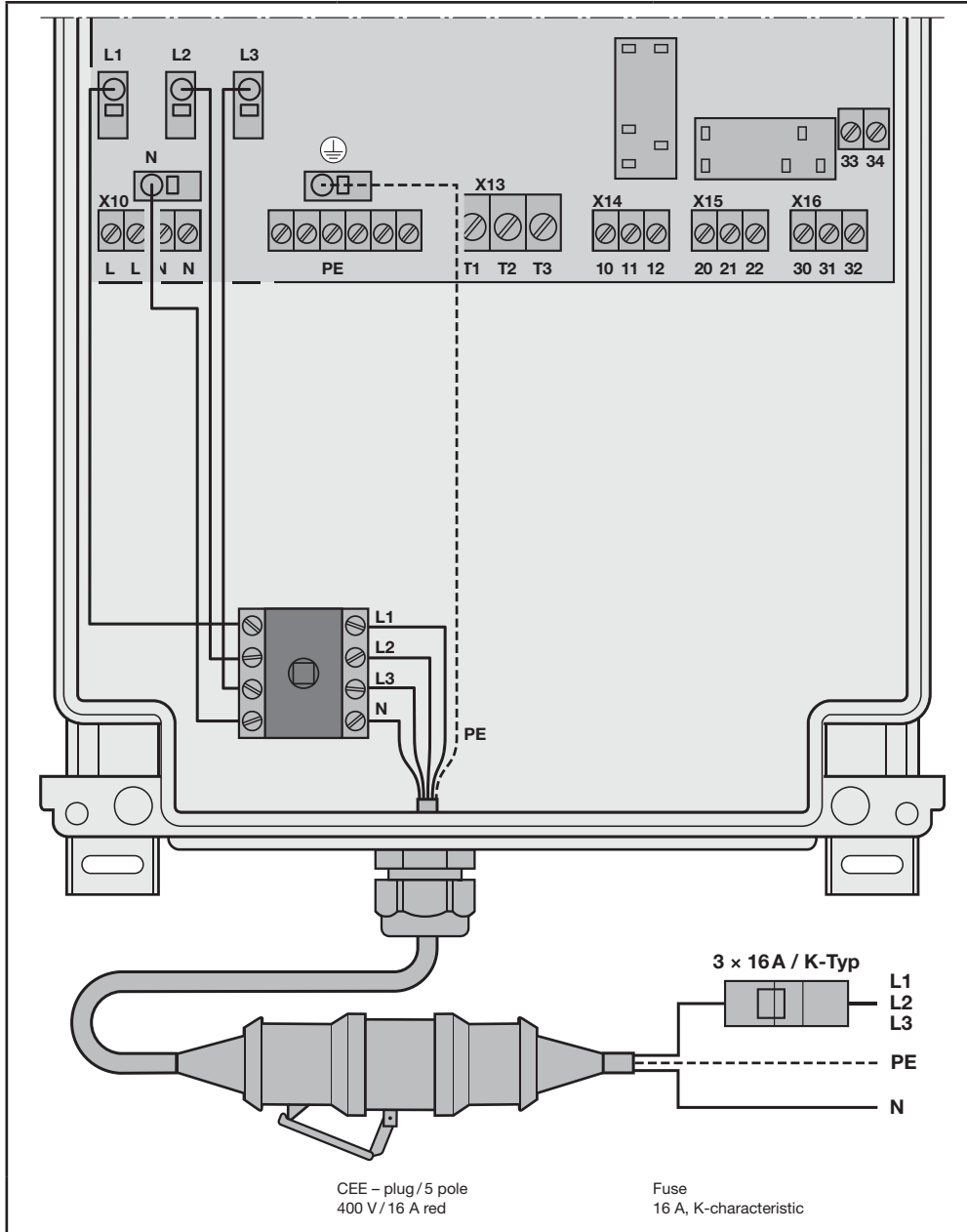

The mains plug must be visible and accessible from the control.

4.3 Motor connection

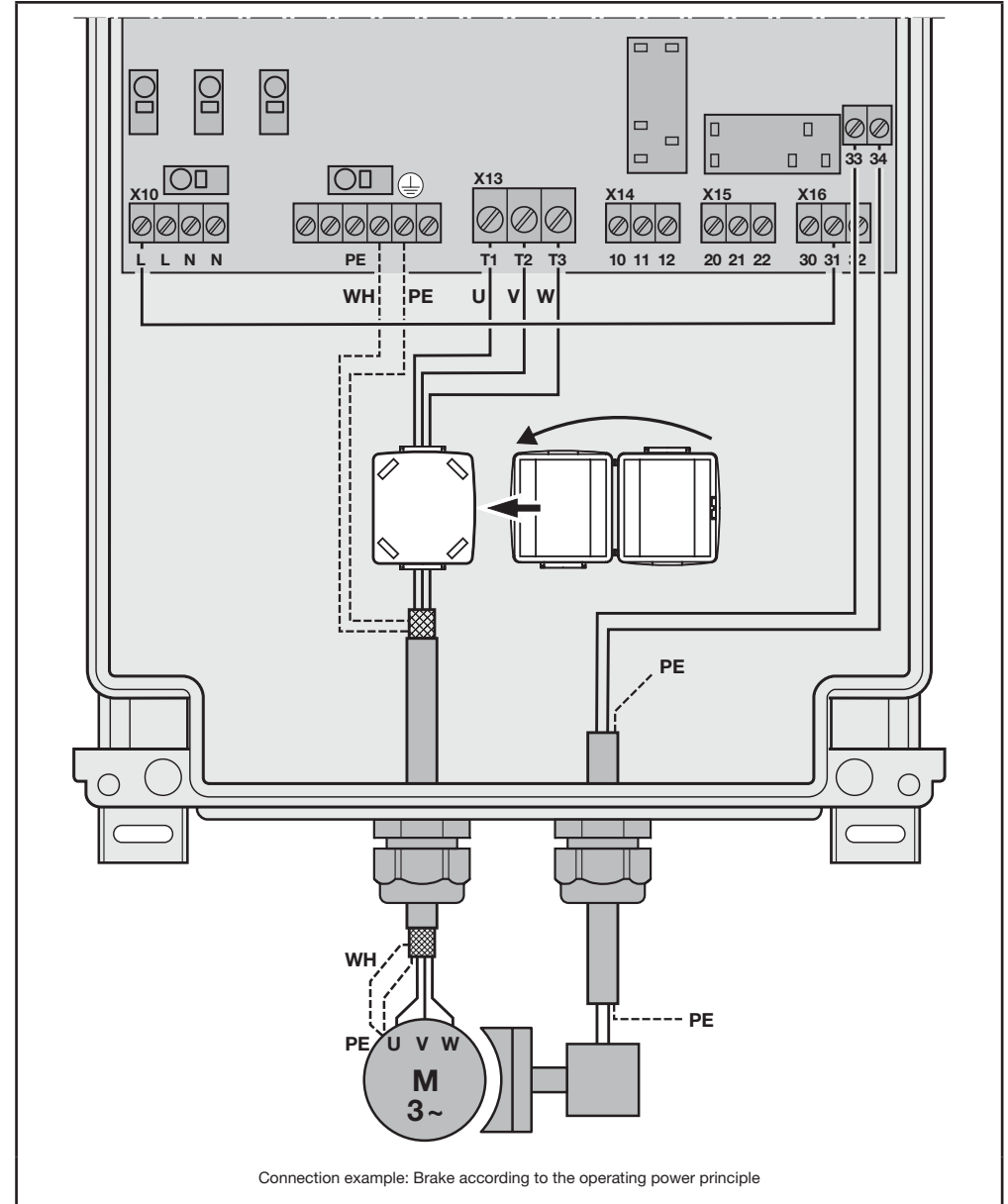

To ensure error-free operation of the door control BK / BS 150 FUE - 1 / AK/AS 500 FUE - 1, please use the enclosed motor cable. Do not run any leads other than those of the motor connection in this cable. The shield of the motor cable must be connected on both sides.

4.4 Overview of outputs

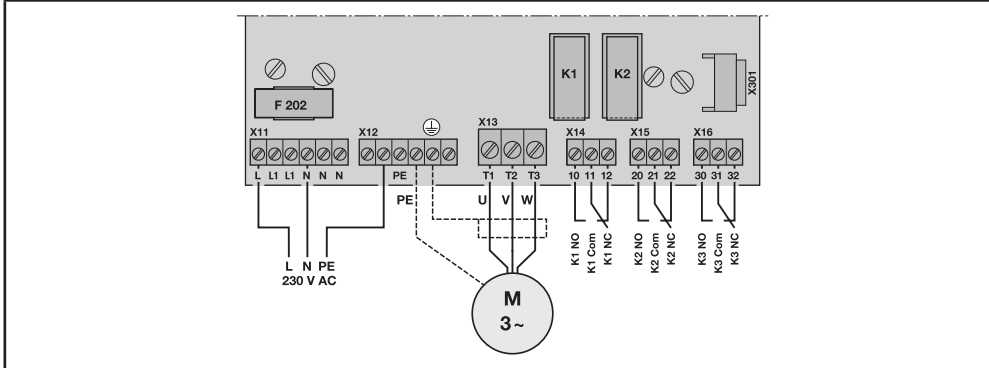

X14: Output relay – Function as ordered – Standard: Door in upper travel limit
 X15: Output relay – Function as ordered – Standard: Door in lower travel limit
 X16: Output relay – Function as ordered – Standard: no function

4.5 Overview of inputs

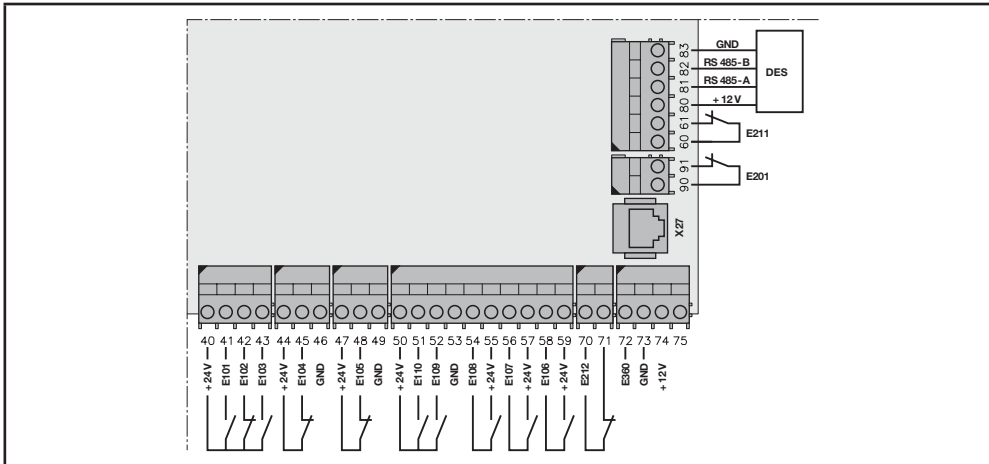

See wiring diagram for input functions
 For the use of mechanical limit switches see chapter 4.7.2

4.6 Connecting the safety strip

You can connect various types of safety strips, such as:

- Electrical safety strip with 8.2 kΩ terminating resistance.
- Dynamic optical systems.

The type of safety strip is specified in the control. The applied type and the correct connection are shown in the wiring diagram of the door system.

ATTENTION

► Automatic closing is not possible without a connected safety strip!

4.7 Connecting the limit switch

Different types of limit switch systems may be used with door control BK / BS 150 FUE - 1 / AK / AS 500 FUE - 1. An absolute encoder is used as a limit switch in the standard setting (section 4.7.1). In addition, you can use mechanical cam limit switches (section 4.7.2).

4.7.1 Absolute encoder

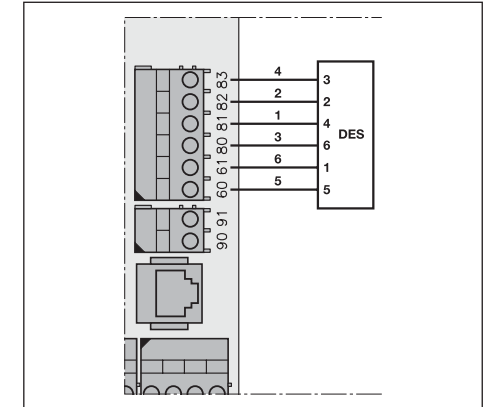
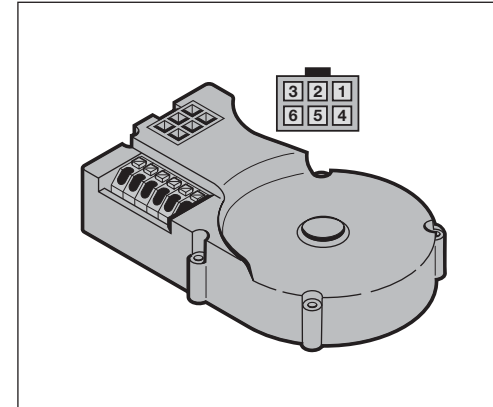

- | | | | |
|---|---------------------------|---|---------------------|
| 1 | +24 V Emergency-off chain | 4 | RS 485 – A |
| 2 | RS 485 – B | 5 | Emergency-off chain |
| 3 | GND | 6 | +12 V |

Sample connection

4.7.2 Mechanical limit switches

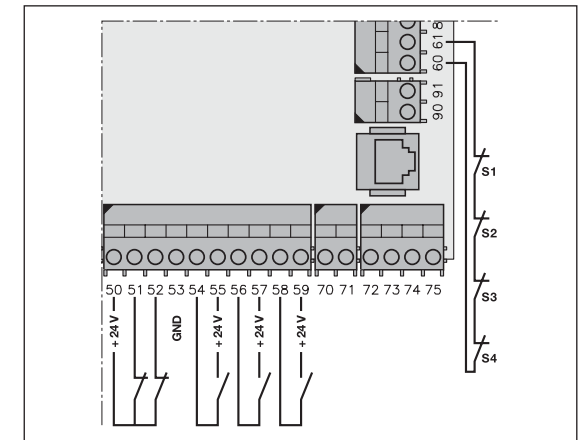
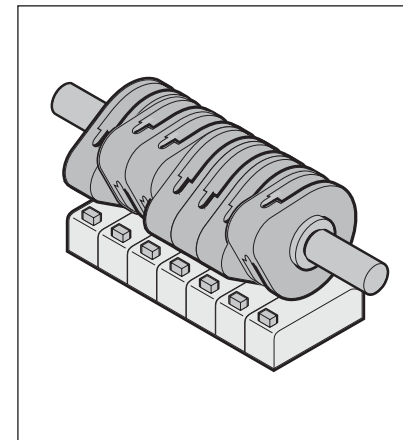

Input configuration

- | | | | |
|-----|-------------------------------------|----------|------------------------------|
| 51: | Lower limit switch | 60 – 61: | Emergency OFF circuit with |
| 52: | Upper limit switch | S1: | Lower emergency limit switch |
| 54: | Lower pre-limit switch | S2: | Upper emergency limit switch |
| 56: | Upper pre-limit switch | S3: | Thermal switch |
| 58: | Upper pre-limit switch safety strip | S4: | Crank handle switch |

5 Control replacement

Observe all safety regulations when performing any work on the electrical systems. The control may only be replaced by trained specialists.

5.1 Control replacement for BK 150 FUE-1 / AK 500 FUE-1

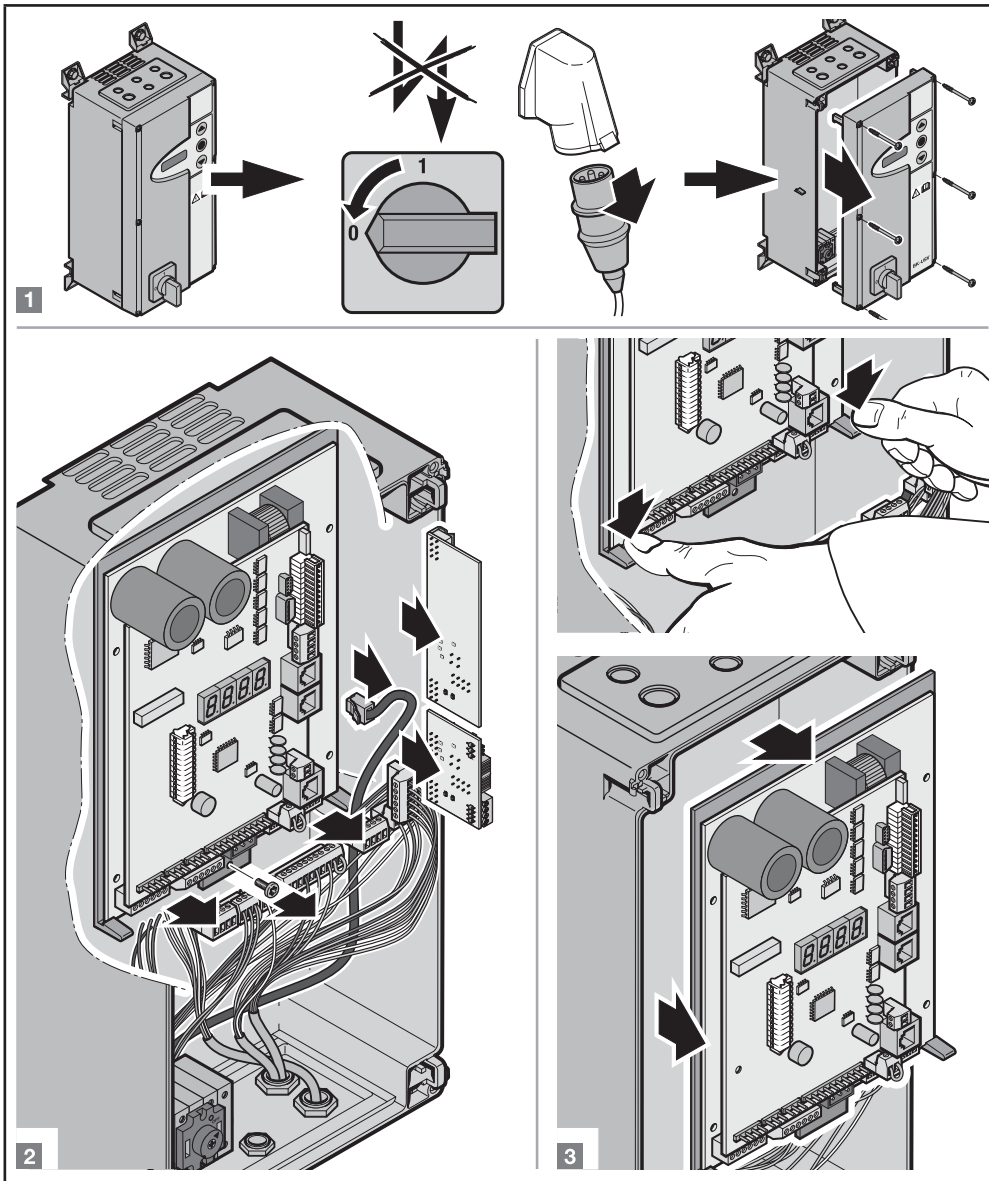

5.2 Control replacement for BS 150 FUE-1 / AS 500 FUE-1

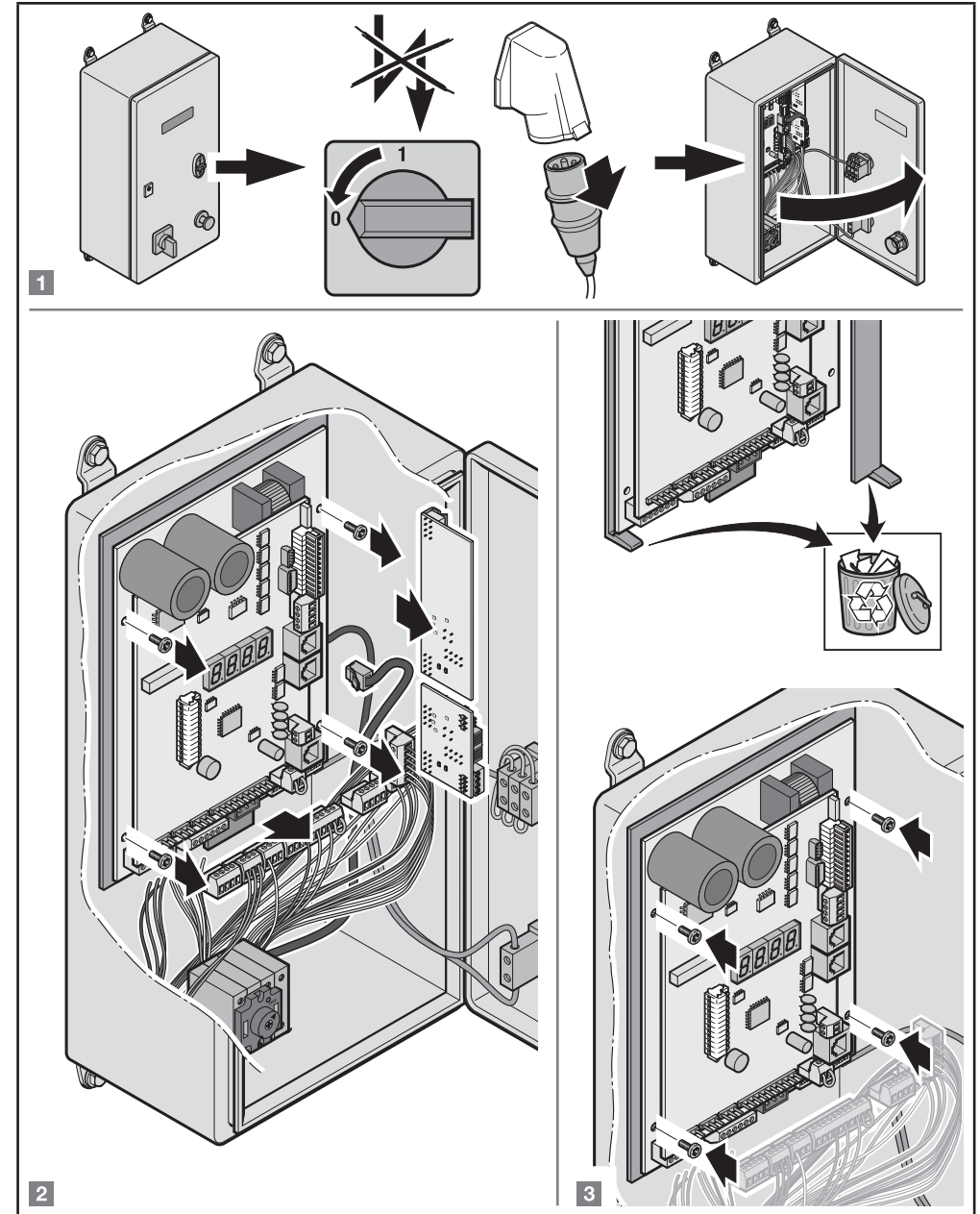

6 General operation information for parameterisation

Opening parameterisation mode			
1.		Activate STOP button and hold	Current messages will display, e.g.:
2.		Additionally activate OPEN button and hold	wait approx. 2 seconds: in parameterisation mode
Selecting parameters in open parameterisation mode			
		Select desired parameter	The parameter value can be viewed or modified (see below), display varies with selection
		ATTENTION: Not all parameters are directly visible or modifiable, depending on the password and the positioning type setting	
Parameter processing with selected parameter			
1.		Control is in parameterisation mode	Name of desired parameter displays
2.		Opening the parameter	The current parameter value is displayed:
3.		Use the OPEN button to increase the parameter value	If the currently valid parameter value is modified, the decimal points will flash
or		Use the CLOSE button to decrease the parameter value	
4.		Save set parameter value	The parameter is saved when all dots have stopped flashing
or		Discard set parameter value	Abort, the original parameter value is displayed
5.		Change to display of parameter name	Display of parameter name
Exiting parameterisation mode			
		Parameterisation mode is exited immediately, door mode is active again	The last saved value is automatically kept
		5 s	
Perform a reset of the control			
		Press simultaneously and hold approx. 3 seconds.	

7 Customer parameters

7.1 Counter

P.		Function	Description / notes
	n	Door cycle counter	Shows door cycle counter Illustration: 1234567 → 1234. ▼-actuate .567 Illustration: 67 → 67
	n	Maintenance counter	The content of this parameter specifies the number of door cycles still to be run until the maintenance is due. The setting -1 means that the maintenance counter has not been activated yet.
		Crash counter	The content of this parameter specifies the number of crashes counted so far. In case of an activated crash input the crash counter will be increased by a value of 1 and only press-and-hold operation is possible. The crash or the error caused by it has to be acknowledged.

7.2 Hold-open phase

P.		Function	Description / notes
	0 ... 9999 s	Hold-open phase 1 door OPEN	The door is held in the travel limit for the set time. Then, the closing is carried out automatically.
	0 ... 9999 s	Hold-open phase 2 intermediate stop / partial opening	
	0 ... 200 s	Minimum hold-open phase	Deviating from the hold-open phase 1 or 2, the door is held open for the minimum period of the set time. Then, the closing is carried out automatically.
	0 ... 20 s	Pre-warning phase before closing	Door closing will be delayed by the time indicated in this parameter if a CLOSE command is received or after the hold-open phase has elapsed (forced closure).

The hold-open phase that runs depends on the travel limit approached and the OPEN command used. You can separately set for each OPEN command whether a hold-open phase is started and if, which one.

7.3 Correct travel limit

P.		Function	Description / notes
	-125 ... 125 Inc	Correction value for door CLOSED	With this parameter, the entire travel limit is moved and therefore, the travel limit is moved together with the corresponding pre-limit switch. The adjustment of the parameter value in the positive direction moves the travel limit upwards. The adjustment of the parameter value in the negative direction moves the travel limit downwards.
	-60 ... 60 Inc	Correction value for door OPEN	

7.4 Error memory

P.		Function	Description / notes
P.920 r	1 ... 8	Error memory	<p>The control stores the last eight errors that have occurred in the error memory.</p> <p>After jumping to parameter P.920:</p> <ul style="list-style-type: none"> • Switch level using membrane key ▲ and membrane key ▼ • Open the error memory using the ● button • Close the error memory using the ● button • Exit the parameter P.920 using Eb - <p>Eb1 Error message 1 (most recent error) Eb8 Error message 8 Eb- Exit, jump back to P920 Er- no error entered</p>

7.5 Software version

P.		Function	Description / notes
P.925 r		Software version main processor	In these parameters the versions of the currently applied software are displayed.

7.6 Serial number

P.		Function	Description / notes
P.927 rw		Serial number	Display of serial number

8 Initial Start-Up

8.1 with absolute encoder

1. Open CALIBRATION mode by briefly pressing the ● button
2. Move door to door CLOSED position using ▼ on the membrane keypad and save by pressing the ● button for approx. 3 seconds.
3. Move door to door OPEN position using ▲ on the membrane keypad and save by pressing ● for approx. 3 seconds.

8.2 with mechanical limit switches

1. Move door with ▼ approximately 50 cm before the closed position.
If the door does not move, the motor is lacking in power or, if necessary, check if the brake is released.
The distance is very dependent on the door type and speed. For fast doors, increase the value. With incorrect direction of door movement: incorrect motor rotating field, switch off the control and swap the 2 motor connections.
2. Set the lower pre-limit switch so that it just triggers.
3. Move door with ▼ approximately 10 cm before the closed position.
The distance is very dependent on the door type and speed. For fast doors, increase the value.
4. Set the lower limit switch so that it just triggers.
Do not overshoot limit switch in end positions!
5. Move door with ▼ approximately 50 cm before the open position.
The distance is very dependent on the door type and speed. For fast doors, increase the value.
6. Set the upper pre-limit switch so that it just triggers.
7. Move door with ▼ key approximately 10 cm before the open position.
The distance is very dependent on the door type and speed. For fast doors, increase the value.
8. Set the upper limit switch so that it just triggers.
Do not overshoot limit switch in end positions!
9. Set EMERGENCY upper and lower limit switch.

10. Press the ● und ▲ buttons to skip to parameterisation mode. Select parameter P.980 "Service mode", open it, and set the parameter value "2" to "0" (automatic mode).
11. If required, correct the door OPEN and door CLOSED limit switch positions by fine-tuning the end positions in automatic mode.
To prevent door from moving unintentionally, only adjust the limit switches if EMERGENCY OFF is activated or control is disconnected!
12. Now, door may be moved in automatic mode.

8.3 Requesting new teach-in for limit stops

If electronic limit switches are used and the end-of-travel position teach-in was done in advance, but are not suitable for the door, a new end-of-travel position teach-in can be requested.

Adjust the following parameters for this purpose:
P.210 value 5 = New teach-in of all limit stops

9 Parameters of the service level

In addition to the parameters that are adjustable at the customer level, the service level settings that are required for initial start up and maintenance can only be achieved if the programming switch S1300 is switched to ON.

Customer level parameters are only mentioned below if additional functions are activated at service level.

9.1 Parameter setting at service level

Modification of the basic data is not necessary; this was set at the factory.

To change parameters, proceed as follows:

1. Switch off the control.
2. Switch on DIP switch S1300.
3. Switch on the control.
4. Simultaneously press the ● and ▲ buttons for approx. 3 s to enter the parameterisation mode of the door control.
5. Change the desired parameters.
6. After completing the settings, push the ● button for approx. 5 s to exit parameterisation mode.
7. After completion of work, it is imperative that the S1300 be switched off when the control is off.

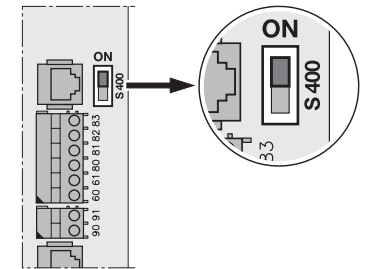

After approx. 1h, the service mode will automatically set back. To re-enter service mode, briefly disconnect the control and then connect it again, or carry out a reset.

9.2 Phases

P.		Function	Description / notes
P.017 w	0 ... 60 s	Memory time for OPEN commands	OPEN commands are saved for the time set here
P.025 w	0 ... 20 s	Pre-warning phase before CLOSE movement	Door closing is delayed by the time specified by this parameter after the input of a CLOSE command or after the hold-open phase (forced closing) has elapsed.

Hold-open phase see section 7.2

9.3 UPS self-test

P.		Function	Description / notes
P.040 w	0 ... 1	Activation of emergency opening self-testing	This parameter gives you the open to activate or deactivate emergency opening self-testing. 0: Emergency opening test deactivated 1: Emergency opening test activated NOTE: This parameter is only visible if A.490≠0.

9.4 Motor settings

P.		Function	Description / notes
P.130 w	0 ... 1	Motor phase rotation	The parameter determines the phase rotation for the opening. 0: Right phase rotation 1: Left phase rotation

9.5 Power increase / boost

The boost increases the performance of operators for lower number of revolutions.

Setting the boost too low or too high can lead to an error in door movement. If the value is too high, it results in an overload error (F510 / F410). In this case the boost must be reduced. If it is too low or 0 and the motor still does not have enough power to move the door, it must be increased.

Due to the numerous different operational conditions on site, the correct setting of the boost should be determined by trial and error. The diagnosis function for the engine power is helpful in this (see parameter P910 = 2). With the help of the power display it can be very easily determined whether the changed setting results in the desired outcome.

The boost should always be set as low as possible yet as high as needed.

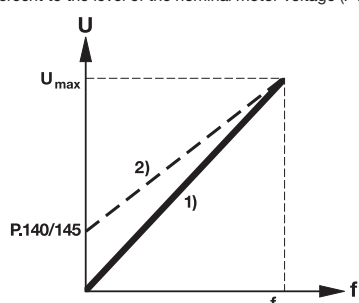
P.		Function	Description / notes
P.140 w	0 ... 30 %	Boost for OPEN movement	Increases the voltage output and thus the performance for lower numbers of revolutions, until the cut-off frequency (P100) is reached. The voltage is increased by the value entered in the parameter in percent to the level of the nominal motor voltage (P103).  <p>1) normal characteristic curve 2) boost characteristic curve</p>
P.145 w	0 ... 30 %	Boost for CLOSE movement	see P140

9.6 Limit stop correction

P.		Function	Description / notes
P.210 w	0 ... 5	New teach-in of the limit stops	Restart travel limit setting. The respective limit stops are moved to in press-and-hold operation after activating the sequence and saved by keeping the stop button pressed. The following settings are available: 0: Cancel, no limit stops have been taught in. 1: Teach-in of the limit switch down, limit switch up and, when required, limit switch intermediate stop. 2: Teach-in of limit switch up and, when required, limit switch intermediate stop are performed. 3: Teach-in of limit switch down and limit switch up is performed. 4: Teach-in of intermediate stop limit switch is performed. 5: Teach-in of all limit switches and the rotating direction is performed. Teach-in of the limit switch intermediate stop depends on the setting in application parameter A240.

9.7 Speeds

The automatic setting of the pre-limit switch and limit switch hinges is used. This way, the pre-limit switches and limit switches are automatically changed during the first travel cycles after teaching-in of the limit switches has been performed. A change in the travel speed results in a restart of the automatic limit switch correction.







P.		Function	Description / notes
P.350 w	6 ... 200 Hz	Operating frequency for fast CLOSE movement	Operating frequency to lower pre-limit switch Observe closing force at safety strip!
P.310 w	6 ... 200 Hz	Operating frequency for fast OPEN movement	Operating frequency to upper pre-limit switch

9.8 Cross-traffic input P.5 × 0 / P.A × 0 = 9 optional





Parameter P.5 × 0 / P.A × 0 must be set at 9, to activate the cross-traffic function for this input. x = number of the input that is to be parameterised.

P.		Function	Description / notes
P.810 w	0 ... 30 s	Block time detector channel 1 and OPEN 1	Detector channel 1 and OPEN 1 commands are blocked for the time specified in this parameter after activating a cross-traffic input.
P.820 w	0 ... 30 s	Block time detector channel 2 and OPEN 2	Detector channel 2 and OPEN 2 commands are blocked for the time specified in this parameter after activating a cross-traffic input.

9.9 Diagnostic display on the screen

P.		Function	Description / notes
 w	0 ... 22	Display mode selection	Using this parameter, the measurement variables at the bottom can be viewed direct in the door control display. 0: The control sequence is displayed (Automatic) 1: Present driving speed in Hz 2: Present motor current in A 3: Present motor voltage in V 4: Present intermediate current in A 5: Present intermediate voltage in V 6: Output temperature in °C 7: Output temperature in °F 8: Operating time of motor during last door cycle in s 9: Present position in Inc 10: Position of the reference in Inc 11: Value channel 1 of the absolute encoder 12: Value channel 2 of the absolute encoder 13: Present reference voltage in V 14: Temperature in housing in °C 15: Temperature in housing in °F 16: Transformation factor from the motor to the transmitter in the opening run 17: Transformation factor from the motor to the transmitter in the closing run 21: Number of position requests without valid replies from the position sensor. 32: Actual current of the 24 V mechanical brake connected to X17 39: Display of current cos phi
		Error memory	See customer level section 7.4 Ebcl: Delete the complete error memory
 r		Software version extension card	In these parameters the versions of the currently applied software are displayed.
 r		Software version IO processor	
	s	Operating time of the motor	Duration of the last door run.
 r	V	Input voltage	Value of the presently applied mains voltage.

9.10 USB functions

P.		Function	Description / notes
 -w	0 ... 1	Copy protection for parameter file	If copy protection is activated, a parameter file cannot be created to transfer the parameter set for this (source) control to a different (target) control. 0: Copy protection deactivated 1: Copy protection activated
 -w	0 ... 4	Save parameter file	The purpose of the parameter file to be saved is determined using the parameter value. 0: No parameter file selected 1: Save the parameters in a parameter file that can be loaded in another control. An existing file is overwritten. 2: Save the parameters in a parameter file as a backup for this control. One of the files available for this control will be overwritten. 3: Save parameter file to pass on to the door constructor (all parameters are included). A new file is created with a file name not already in use. 4: Save parameter file without encryption. Only the visible parameters are saved. A new file is created with a file name not already in use.
 -w	0 ... 4	Parameterdatei laden	The parameter file to be loaded is selected using the parameter value. 0: No parameter file selected 1: Load the parameter file on the USB stick to copy parameters from another control. 2: Load the parameter file stored as a backup for this control. 3: Load the parameter file with the number nnnn from the root directory of the USB stick.
 w	0 ... 1	Starting software update	The update is started automatically when a USB stick is inserted and the file name tst_fuh.bin is found. A reset is carried out automatically after a successful update. You can also exit the Bootloader by performing a hardware reset. Software version see section 7.5

9.11 Maintenance counter



Counter see section 7.1

P.		Function	Description / notes
 w	0 ... 1	Resetting the maintenance counter	Acknowledge the maintenance counter.



9.12 Operating mode of the control

P.		Function	Description / notes
 w	0 ... 5	Operating mode	<p>The following modes are possible:</p> <ul style="list-style-type: none"> 0: OPEN and CLOSE movement in press-and-release operation (Automatic) 1: OPEN movement in press-and-release operation, CLOSE movement in manual mode (Semi-automatic) 2: OPEN and CLOSE movement in manual mode (press-and-hold mode) 3: Press-and-hold-mode emergency run <p>ATTENTION In the emergency run mode, the door moves as long as a movement command exists and does not stop at the end-of-travel positions!</p> <ul style="list-style-type: none"> 4: Fatigue testing with safety devices. Automatic OPEN and CLOSE movement. Before each new movement, a new hold-open phase P010 is performed. <p>Settings 3 and 4 are lost after the control is disconnected. The control is then transferred to 2.</p>

9.13 Factory setting / original parameter













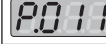





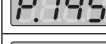

P.		Function	Description / notes
 w	0 ... 1	Factory setting	<p>The setting and saving of this parameter at 1 resets all parameters to their default values.</p> <p>ATTENTION The door profile and special settings will be lost! You must adjust P991 according to the door type!</p>
 w	0000 00FF	Door profile	Door type-specific settings.

9.14 Password

P.		Function	Description / notes
 w	FFEE	Bridging DIP switch	<p>Enter the pre-defined password to bridge the programming DIP switch. The switch becomes active if the correct password has been entered.</p> <p>NOTE: This parameter is only visible if a TST UT-H operating unit is connected.</p> <p>ATTENTION The parameters are not allowed to be modified without knowing their function. To avoid errors and risks resulting from unauthorised access, passwords are only handed out to trained personnel.</p>
 w	0 ... FFFF	Password	Access right to different parametric levels.

The passwords can be set on level 2.

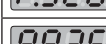
10 Parameter overview

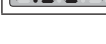
P.	Function	Modified by: _____ on: _____	Section
	Cycle counter		7.1
	Maintenance counter		7.1
	Hold-open phase 1		7.2
	Hold-open phase 2		7.2
	Minimum hold-open phase		7.2
	Memory time for OPEN commands		9.2
	Pre-warning phase before CLOSE movement		9.2
	Activation of emergency opening self-testing		9.3
	Motor phase rotation		7.4
	Boost for OPEN movement		9.5
	Boost for CLOSE movement		9.5
	New teach-in of the limit stops		9.6
	Correction value for door CLOSED		7.3
	Correction value for door OPEN		7.3
	Operating frequency for fast OPEN movement		9.4
	Operating frequency for fast CLOSE movement		9.7
	Block time detector channel 1 and OPEN 1		9.8
	Block time detector channel 2 and OPEN 2		9.8
	Crash counter		7.1
	Display mode selection		9.9
	Error memory		9.9
	Software version		7.5
	Serial number		7.6

P.	Function	Modified by: _____ on: _____	Section
P.930	Operating time of the motor		9.9
P.940	Input voltage		9.9
P.942	Copy protection for parameter file		9.10
P.943	Save parameter file		9.10
P.944	Load parameter file		9.10
P.973	Resetting the maintenance counter		9.11
P.980	Operating mode		9.12
P.989	Start software update		9.10
P.990	Factory setting		9.13
P.991	Door profile		9.13
P.996	Bridging DIP switch		9.14
P.999	Password		9.14

11 Overview of messages

11.1 General errors

If errors do not reset themselves, they may be acknowledged.

You must first eliminate the source of the error before you acknowledge the related notification.

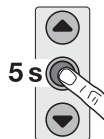

Press ● for approx. 5 seconds.

Incorrect travel limits		
F.000	Door position outside top	<ul style="list-style-type: none"> Mechanical brake is defective or incorrectly set Return to the permitted parameter range via press-and-hold operation Parameter value for top emergency limit switch is too small Upper limit switch range (limit switch band) is too small
F.005	Door position outside bottom	<ul style="list-style-type: none"> Mechanical brake is defective or incorrectly set Return to the permitted parameter range via press-and-hold operation Parameter value for bottom emergency limit switch is too small Lower limit switch range (limit switch band) is too small

Implausible door operation		
F.020	Operating time exceeded (during opening, closing or hold-open)	<ul style="list-style-type: none"> Current motor operation time has exceeded set maximum operation time Door may be sluggish or blocked If mechanical limit switches are used, one of the limit switches did not engage
F.021	Testing of the emergency opening failed	<ul style="list-style-type: none"> Call service department The max. permissible runtime during the testing period has been exceeded. Reset: Press the STOP button long Door is sluggish or blocked UPS batteries are too empty or defect
F.030	Contouring error (change in position of door is less than expected)	<ul style="list-style-type: none"> Door or motor is blocked Brake does not release (check connection / check brake rectifier) Power too low for starting torque (check voltage supply) Speed insufficient Mechanical limit switch was not passed or is defective Fixing to shaft of absolute encoder is not tightened Wrong door profile selected (P991)
F.031	Detected direction of rotation differs from the expected direction of rotation	<ul style="list-style-type: none"> When using increment encoders: Channel A and B have been swapped Rotational direction of the motor was switched relative to the calibration. Repeat teach-in door with P.210 = 5. Too much "sagging" when door starts to move, brake releases too soon, or torque is too low, boost may need to be adjusted.
F.033	Position sensor logs faulty	<ul style="list-style-type: none"> The position sensor bus is disrupted No position data received over a longer period
F.043	Malfunction of photocell's pre-limit switch	<ul style="list-style-type: none"> The photocell's pre-limit switch remains engaged also at centre travel limit or upper travel limit. For absolute encoders: Repeat teach-in of end-of-travel positions, distance between Eu and Eo at least 1 m.

Operator call crash system		
F.060	Crash recognised	<ul style="list-style-type: none"> The control was just connected, one-time reset of the error necessary The door was crashed <p>Reset procedure, see:</p> <ul style="list-style-type: none"> Fitting instructions Wiring diagram Control cabinet door outside <p>Only if the error cannot be reset:</p> <ul style="list-style-type: none"> With IR transmission <ul style="list-style-type: none"> Check optical distance in the side assembly. It must be free of dirt. Check battery voltage. With spiral cable <ul style="list-style-type: none"> Check spiral cable In case of radio crash <ul style="list-style-type: none"> Teach-in of both transmitters was not carried out on the receiver (see radio crash instruction) One of the transmitters is defect or the battery is empty
F.061	Belt break	<ul style="list-style-type: none"> An input (P.50 x = 0416) configured as a belt break detector has been activated Travel is not permitted as long as the display is flashing → acknowledgement required Press-and-hold operation to Close end-of-travel position is enabled by briefly pressing the STOP membrane push button If a broken belt is mechanically repaired and input is no longer active, self-acknowledgement will take place if the Close position has been reached in press-and-hold operation.

Maintenance counter is exceeded		
F.080	Malfunction: Maintenance is required	<ul style="list-style-type: none"> Service counter is run down

Parameter is not set		
F.090	Control is not parameterised	<ul style="list-style-type: none"> The basic parameters of the control were not set yet. See P990 and P991.

Safety chain malfunctions		
F.201	Internal emergency-off "mushroom button" activated or watchdog (processor monitoring)	<ul style="list-style-type: none"> Emergency stop chain was interrupted at the "internal emergency-off" input, but parameterisation mode was not selected Internal parameter or EEPROM tests failed. Activate the STOP membrane key for more information on the cause
F.211	External emergency-off 1 activated	<ul style="list-style-type: none"> Emergency stop chain interrupted at emergency-off input 1 (see wiring diagram)
F.212	External emergency-off 2 activated	<ul style="list-style-type: none"> Emergency stop chain interrupted at emergency-off input 2 (see wiring diagram)

Malfunction of the safety contact strip		
F.320	Obstacle blocking the opening run	<ul style="list-style-type: none"> During the OPEN movement the door encountered an obstacle (only with obstacle recognition via P480)
F.325	Obstacle blocking the closing run	<ul style="list-style-type: none"> During the CLOSE movement the door encountered an obstacle (only with obstacle recognition via P480)
F.360	Short circuit detected at strip input	<ul style="list-style-type: none"> The connection of the safety strip is short-circuited The light beam of the optical safety strip is interrupted The jumper 1K2/8K2 is positioned wrongly
F.361	Set limit for number of strip activations during closing has been reached	<ul style="list-style-type: none"> Parameterised, maximum number of safety strip triggers during a door cycle has been exceeded To reset the error, completely close the door once in press-and-hold operation
F.362	Redundancy error at short circuit	<ul style="list-style-type: none"> One of the evaluator channels for short circuit recognition does not respond identically to the second channel. Control unit circuit board defective Dynamic optical system connected but not set in parameter P.460.
F.363	Interruption at strip input	<ul style="list-style-type: none"> Connecting cable defective or not connected. Terminating resistor defective or missing. Jumper set incorrectly.
F.364	Safety strip – Testing failed.	<ul style="list-style-type: none"> Testing request did not activate safety strip as expected. The time period between testing request and testing is not adjusted.
F.365	Redundancy error at interruption	<ul style="list-style-type: none"> One of the evaluator channels for interruption recognition does not respond identically to the second channel. Control unit circuit board defective Dynamic optical system connected but not set in parameter P.460.
F.366	Impulse frequency too high for optical safety strip	<ul style="list-style-type: none"> Defective optical safety strip Defective input for internal safety strip.
F.36A	Redundancy error of the 8K2 wicket door switch on the internal safety strip evaluation unit	<ul style="list-style-type: none"> One of the redundant contacts in the 8k2 wicket door switch is defective The wicket door has not been completely opened or closed
F.369	Internal safety strip parameterised incorrectly	<ul style="list-style-type: none"> An internal safety strip is connected but deactivated, or vice versa.
F.385	Malfunction of safety strip's pre-limit switch	<ul style="list-style-type: none"> Pre-limit switch for safety switch deactivation, and/or reversal after safety switch activation, remains engaged also at upper travel limit.

Malfunction of the safety contact strip		
F.3A1	Number of activations exceeded, safety A	<ul style="list-style-type: none"> Parameterised maximum number of activations of safety A during one door cycle has been exceeded
F.3B1	Number of activations exceeded, safety B	<ul style="list-style-type: none"> Parameterised maximum number of activations of safety B during one door cycle has been exceeded
F.3C1	Number of activations exceeded, safety C	<ul style="list-style-type: none"> Parameterised maximum number of activations of safety C during one door cycle has been exceeded

General hardware errors		
F.400	Hardware reset of control recognised	<ul style="list-style-type: none"> Severe malfunctions in the supply voltage Internal watchdog has activated RAM error
F.406	Extension PCB communication error	<ul style="list-style-type: none"> Communication disrupted between the main circuit board and extension PCB
F.410	Overload (Motor current or intermediate circuit)	<ul style="list-style-type: none"> Incorrect nominal specifications set for motor Voltage increase / boost set not adjusted (P140 or P145) Motor incorrectly dimensioned for door used Door is sluggish Brake does not release (check connecting lead + brake rectifier)
F.420	Overload in intermediate circuit limit 1	<ul style="list-style-type: none"> Brake chopper malfunctioning / defective / not present Supply voltage much too high The motor feeds too much energy back during generator mode, the kinetic energy of the door cannot be sufficiently reduced.
F.425	Mains overvoltage	<ul style="list-style-type: none"> The supply voltage of the control is too high
F.426	Mains undervoltage	<ul style="list-style-type: none"> The supply voltage of the control is too low
F.430	Heat sink temperature is outside operating range limit 1	<ul style="list-style-type: none"> Load on output stage or brake chopper too high Ambient temperature too low for control operation. Output stage clock frequency too high (parameter P160)
F.435	Malfunction: Temperature in housing rising above 75°C	<ul style="list-style-type: none"> Too much load on the frequency converter / the switch Control cabinet not sufficiently cooled
F.440	Overload current in intermediate circuit limit 1	<ul style="list-style-type: none"> Set voltage increase ("boost") not adjusted Motor incorrectly dimensioned for door used Door is sluggish
F.510	Overload current in motor / intermediate circuit limit 2	<ul style="list-style-type: none"> Incorrect nominal specifications set for motor Voltage increase / boost set not adjusted (P140 or P145) Motor incorrectly dimensioned for door Door is sluggish
F.511	Malfunction in DC supply	<ul style="list-style-type: none"> DC supply not possible (overcurrent, IGBT error F.519, phase-to-earth fault, 24 V error, excess temperature) Emergency off is actuated
F.512	Offset motor current / intermediate circuit current faulty	<ul style="list-style-type: none"> Hardware faulty
F.513	Brake chopper overloaded, not available or is defective	<ul style="list-style-type: none"> Hardware faulty Dynamic travel has taken place for too long The brake chopper is defective or is not connected correctly
F.515	Motor protection function has recognised overload current	<ul style="list-style-type: none"> Incorrect motor characteristic curve (motor nominal current) set Voltage increase / boost set too high (P140 or P145) Motor incorrectly dimensioned

General hardware errors		
F.519	IGBT driver module has recognised overload current.	<ul style="list-style-type: none"> Supply voltage or construction power supply is too weak ensure correct supply: <ul style="list-style-type: none"> BK / BS 150 FUE - 1: Connecting lead at least 3 × 2,5 mm² AK / AS 500 FUE - 1: Connecting lead at least 5 × 2,5 mm² Short circuit or earth contact at motor terminals Motor nominal frequency set extremely incorrectly Voltage increase / boost extremely high (P140 or P145) Motor incorrectly dimensioned Motor winding defective Brief interruption of emergency-off circuit.
F.520	Overload in intermediate circuit Limit 2	<ul style="list-style-type: none"> Brake chopper malfunctioning / defective / not present Input supply voltage too high The motor feeds too much energy back during generator mode, as it needs to reduce the kinetic energy of the door.
F.521	Undervoltage in intermediate circuit	<ul style="list-style-type: none"> Input supply voltage too low, usually with load Load too high / output stage or brake chopper malfunction
F.522	Intermediate circuit current is too high for one-phase supply	<ul style="list-style-type: none"> A one-phase supply has been detected for the AK / AS 500 FUE - 1 and the permitted intermediate circuit current is too high for one-phase supply. This error always occurs in conjunction with F.520
F.524	External 24 V supply missing or too low	<ul style="list-style-type: none"> Overload, but no short circuit. If the 24 V short circuits, the control supply does not switch on and the V306 glow lamp lights up.
F.525	Overvoltage at the power input	<ul style="list-style-type: none"> The supply voltage is too high The supply voltage has a high fluctuation For controls with UPS: UPS in battery operation – restore power supply
F.530	Heat sink temperature is outside operating range limit 2	<ul style="list-style-type: none"> Load on output stage or brake chopper too high Clock frequency of output stage too high (P160) Ambient temperature of control too low
F.535	Malfunction: Temperature in housing rising above critical 80°C	<ul style="list-style-type: none"> Interior temperature too high
F.540	Overload current in intermediate circuit limit 2	<ul style="list-style-type: none"> Set voltage increase ("boost") not adjusted Motor incorrectly dimensioned for door used Door is sluggish

Error in positioning system		
F.700	Position detection defective	<p>For mechanical limit switches:</p> <ul style="list-style-type: none"> At least one limit switch does not correspond to parameterised active status. An implausible combination of at least 2 active limit switches. <p>For electronic limit switches:</p> <ul style="list-style-type: none"> After factory parameter activation was called up (parameter P.990), the corresponding positioning system was not parameterised. Calibration is incomplete or defective and must be repeated. The intermediate travel limit, when activated, is implausible. Synchronisation not completed or reference switch defective
F.752	Timeout during log transfer	<ul style="list-style-type: none"> Carry out hardware reset: Turn the control off, unplug DES, plug back in after a few minutes and turn the control back on Interface line defective / interrupted Evaluation electronics of absolute encoder are defective Defective hardware or an environment with a high level of electrical interference Check earthing of the door system Shield connection cable Fit RC module (100 Ω + 100 nF) to brake

Error in positioning system		
F.760	Position is outside range	<ul style="list-style-type: none"> Position sensor operator defective Evaluation electronics of absolute encoder are defective Defective hardware or an environment with a high level of electrical interference

Communication error		
F.782	Communication with the existing controls distorted	<ul style="list-style-type: none"> Missing, distorted connection between two interlocked doors or two doors operating in air lock mode Parameter A.831 programmed wrongly Doors without lock or dock function: Set A.831 = 0000











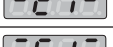

11.2 Internal system-induced errors F.9xx



These errors are internal errors that cannot be eliminated by the operator. If this type of error occurs, please contact customer service immediately.

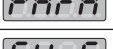
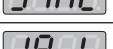

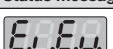

Internal error		
F.910	Communication not possible with the extension card	<ul style="list-style-type: none"> Communication with extension card is disrupted No extension card inserted CAN connection disrupted (cable break or no power supply for the extension card)
F.915	Communication error between main processor and I/O processor	<ul style="list-style-type: none"> Hardware defects Extremely disruptive environment Temperature too high
F.922	Emergency stop chain not complete	<ul style="list-style-type: none"> Not all EMERGENCY STOP inputs are bridged separately, even though the entire emergency chain is bridged. Redundant check of the emergency stop chain activated
F.926	Braking current is not OK	<ul style="list-style-type: none"> Braking current is not OK – The expected braking current set with parameter P.183 has been exceeded by at least +0.5 A. Incorrect brake
F.928	Erroneous input test	<ul style="list-style-type: none"> Testing of the monitoring function failed Check monitoring device connection
F.92A	Motor wiring test	<ul style="list-style-type: none"> Damaged motor cable Damaged motor
F.930	External watchdog faulty	<ul style="list-style-type: none"> 24 V voltage overloaded Defective hardware or an environment with a high level of electrical interference
F.937	Second cut-out option faulty	<ul style="list-style-type: none"> The second microcontroller no longer triggers the watchdog in the first microcontroller
F.960	Parameter check sum faulty	<ul style="list-style-type: none"> Connect and disconnect control Information to service



11.3 Information messages













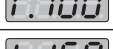
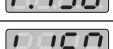



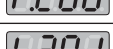

General messages	
SFOP	Stop / reset status, waiting for the next entered command
LEU	Lower travel limit
LEU?	Lower travel limit locked, no opening possible (e.g. air lock)
ZUF0	Active closing

General messages	
	Upper travel limit
	Upper travel limit locked, no closing possible (e.g. safety loop)
	Active opening
	Centre travel limit (intermediate travel limit)
	Centre travel limit locked, no closing possible (e.g. safety loop)
	Malfunction, only press-and-hold operation possible, and possibly automatic opening
	Calibration, adjustment of travel limits in press-and-hold travel (with absolute encoder), begin process via STOP button
	Emergency-off, no door operation possible, hardware safety chain interrupted
	Emergency operation, press-and-hold operation, ignores all safety devices, etc.
	Manual, press-and-hold operation
	Parameterisation
	Synchronisation
	Automatic, designates change of status from "Manual" to "Automatic"
	Semi-automatic, designates change of status from "Manual" to "Semi-automatic"
	First display after connecting (self-test)

Status messages during calibration	
	Request for calibration of lower travel limit
	Request for calibration of upper travel limit
	Calibration of the intermediate travel position

Status messages during press-and-hold operation	
	
	
	Lower travel limit reached

Status messages during press-and-hold operation	
	Upper travel limit reached
	beyond the permitted upper travel limit

Information message during automated operation	
	Emergency opening message
	Maintenance will be necessary / service counter will run down soon
	Speed too high when upper travel limit is reached
	Speed too high when lower travel limit is reached
	Permanent OPEN still active
	Open command encoder priority active, close movement only with a command encoder that has the same priority (see P5 x 4)
	Safety opening is being carried out
	Wait for the command of the membrane keypad
	Waiting for acknowledgement (service request)
	Door cycle counter implausible (re-initialise)
	Reference position corrected or recognised after calibration
	Reference position re-initialised
	Reference position missing
	Reference position incorrect
	Upper pre-limit switch implausible
	Lower pre-limit switch implausible
	OPEN command is transmitted to door 2
	Obstacle in the opening run recognised
	Obstacle in the closing run recognised
	Malfunction of the safety strip NC during the last closing, the message is deleted after the close position has been reached without malfunctions
	Malfunction of the safety strip NO during the last closing, the message is deleted after the close position has been reached without malfunctions

Information message during automated operation	
1.500	Upper limit switch is being corrected
1.510	Limit switch correction complete
1.515	Control is preparing automatic teach-in of limit switches
1.520	Max. speed during the automatic limit switch correction has not been reached.
1.555	Limit switch correction is being carried out
1.901	Waiting for USB stick
1.902	The update file could not be found on the stick
1.903	File cannot be opened
1.904	ROM will be deleted
1.905	ROM is being programmed
1.906	Update file has an incorrect format (not implemented yet)
1.916	Error accessing the USB stick (storage medium) <ul style="list-style-type: none"> • SPI or USB communication disrupted • USB stick is write protected, full or formatted with an unknown file system.
1.941	The parameter file cannot be written as no free directory entries have been found
1.942	The parameter file cannot be written because the storage medium is full

Information messages during the parameterisation	
noEr	Error memory: no error stored
Er--	Error memory: error is found without a corresponding message
Prog	Programmer message





General inputs – for function see wiring diagram	
E.000	OPEN button on membrane keypad
E.050	STOP button on membrane keypad
E.090	CLOSE button on membrane keypad
E.101	Input 1

General inputs – for function see wiring diagram	
E.102	Input 2
E.103	Input 3
E.104	Input 4
E.105	Input 5
E.106	Input 6
E.107	Input 7
E.108	Input 8
E.109	Input 9
E.110	Input 10
E.121	Input 21
E.128	Input 28

Safety / emergency stop chain	
E.201	Internal emergency-off "mushroom button"
E.211	External emergency-off 1
E.212	External emergency-off 2

General safety strip	
E.360	Internal safety strip

Radio control plug-in module	
E.401	Channel 1
E.402	Channel 2

Induction loop evaluator – plug-in module	
	Channel 1
	Channel 2
	Channel 3
	Channel 4
Internal inputs	
	Fault signal from drive module

12 Application parameters BK / BS 150 FUE-1 / AK/AS 500 FUE-1

12.1 Intermediate Stop

A.		Function	Description / notes
	0	No intermediate stop	
	1	Intermediate stop selection switch	See wiring diagram for connection
	2	Impulse generator "Opening height requested by user"	See wiring diagram for connection

12.2 UPS emergency opening

A.		Function	Description / notes
	0	No UPS emergency opening	
	1	UPS emergency opening with self-test, locking priority	See wiring diagram for connection; self-test activated
	2	UPS emergency opening with self-test, emergency opening test priority	See wiring diagram for connection, self-test active
	3	UPS emergency opening with self-test, only with RW kit	UPS emergency opening with self-test, only with RW kit

12.3 Input function IN3

A.		Function	Description / notes
	0	Impulse operation	NO contact required
	1	STOP	NC contact required
	2	Locking	NO contact required
	3	Release	NC contact required

12.4 "Traffic light function" application parameters A.710 / A.720

Up to software version FU_H30124

A		Function	Description / notes
A.710 / A.720	0	Deactivated	
A.710	1	"Door OPEN" signal	
A.720	1	"Door CLOSED" signal	
A.710 / A.720	2	Standard Red / Green traffic light	<ul style="list-style-type: none"> No dependence on direction Pre-warning phase P.025 = 3 s
A.710 / A.720	3	Flashing / rotating warning light	<ul style="list-style-type: none"> No dependence on direction Pre-warning phase P.025 = 3 s Active during door travel and pre-warning phase
A.710 / A.720	4	"Austria" traffic light	<ul style="list-style-type: none"> No dependence on direction Pre-warning phase P.025 = 3 s Active during door travel and pre-warning phase Acknowledgement after emergency OFF via STOP membrane push button
A.710 / A.720	5	Locking	<ul style="list-style-type: none"> "Door not CLOSED" signal No delay time

From software version FU_H30124

A		Function	Description / notes
A.710 / A.720	0	Deactivated	
A.710 / A.720	1	"Door OPEN" signal	<ul style="list-style-type: none"> No switching delay
A.710 / A.720	2	Standard Red / Green traffic light	<ul style="list-style-type: none"> No dependence on direction Pre-warning phase P.025 = 3 s
A.710 / A.720	3	Flashing / rotating warning light	<ul style="list-style-type: none"> No dependence on direction Pre-warning phase P.025 = 3 s Active during door travel and pre-warning phase
A.710 / A.720	4	"Austria" traffic light	<ul style="list-style-type: none"> No dependence on direction Pre-warning phase P.025 = 3 s Active during door travel and pre-warning phase Acknowledgement after emergency OFF via STOP membrane push button
A.710 / A.720	5	Release	<ul style="list-style-type: none"> "Door CLOSED" signal Power on delay 1 s NO contact
A.710 / A.720	6	Locking	<ul style="list-style-type: none"> "Door not CLOSED" signal Power off delay 1 s NO contact
A.710 / A.720	7	"Door CLOSED" signal	<ul style="list-style-type: none"> No switching delay

13 Technical data

Circuit board set dimensions (L × W × H)	Approx. 270 × 195 × 140 mm on frame with quick-release fastener, incl. heat sink excl. extension PCBs such as TST RFUxK or TST RFUxCom
Dimensions in standard housing (L × W × H)	BS 150 FUE-1 / AS 500 FUE-1 500 × 300 × 200 mm, RAL7035 + VA BK 150 FUE-1 / AK 500 FUE-1 450 × 230 × 230 mm
Fitting	Electronics and cooling system are suitable for low-vibration and vertical fitting, e.g. on a brickwork wall.
Heat sink	Aluminium, natural colour – fitted on the rear wall

Keypad (X400)	3 buttons "Open-Stop-Close" Malfunction if incorrectly inserted without destroying component. Connected via 4-pin uncoded plug connector. Switching to plus! Without lighting / without warning lights!		
Voltage supply (wire black (L1...3) / blue (N))	Variant	BK / BS 150 FUE - 1	AK / AS 500 FUE - 1
	Nominal voltage	1 N ~ 230 V	3 (N) ~ / 2~ 400 V
	Voltage range	110 to 240 V ± 10%	200 to 480 V ± 10%
	Safeguarding on-site	16 A, slow-acting	16 A, slow-acting
	Nominal frequency	50 to 60 Hz	
	Connections on the circuit board are not plug-in type!		
Control without operator	Max. 140 W at full use of the 24 V supply		
External supply 1 (X10: L'/N')	Transfer of phase L1 and N. (typical nominal voltage L' to N': 230 V AC) L' is fused on the printed circuit board: 4 AT Not with UL variants!		
Control voltage / external supply 2 (among others, terminal "+ 24 V": 40, 44, 47, 50, 55, 57, 59 . "GND": 36, 46, 49, 53, 73, 83)	24 V _{DC} ± 5 % max. 3,500 mA low safety voltage acc. to EN 60335-1 <ul style="list-style-type: none"> Incl. all external consumers, such as plug-in modules, I/O modules, 24 V brakes, switched transistor outputs and additional control voltages Fused and short-circuit-proof thanks to a self-resetting central switching regulator. GND potential internally earthed to PE (protective earth potential) 		
Control voltage / external supply 3 (tml. 74, 80)	For electronic limit switches and safety strip Nominal value 11.5 V / max. 130 mA		
Control inputs "Digital" IN 1 ... 10 (tml. 41, 42, 43, 45, 48, 49, 58, 56, 54, 52, 51)	24 V DC / typ. 15 mA, max. 26 V DC / 20 mA All inputs must have a volt-free connection or: < 5 V : inactive → logically 0 > 7 V : active → logically 1 Min. signal duration for input control commands: > 100 ms Galvanic separation via optoelectronic coupler on the printed circuit board.		
Communication interfaces			
Serial interface 1 "DoorCom" RS485-0 (X25 / 25b)	For electronic limit switches DES or TST PD/PE or other communication partners approved by HÖRMANN RS485 level (A, B), terminated by 120 Ω Recommended cable: shielded twisted-pair cable in disruptive environment, twisted pair in normal environment If using HÖRMANN limit switches TST PD / PE in parallel also e.g. for future I/O extensions		
Serial interface 2 "AdvDoorCom" CAN-2 (X28 / 28b)	For operating unit TST UTH, external operation of extension PCB TST RFUxK or another communication partner approved by HÖRMANN CAN level (CH, CL), terminated by 120 Ω Recommended cable: shielded twisted-pair cable in disruptive environment, twisted pair in normal environment		
Serial interface 3 CAN-1 for communication module TST RFUCom	For module TST RFUCom or other communication partners approved by HÖRMANN TTL level (Tx, Rx) Max. cable length: 10 cm for internal wiring to module		
Serial interface 4 RS485-1 for communication module TST RFUCom	For module TST RFUCom or another communication partner approved by HÖRMANN Typical for communication between two doors (loading house/locking) TTL level (Tx, Rx, DDR) Max. cable length: 10 cm for internal wiring to module		
Serial interface 5 CAN-0 (X701) for extension PCB TST RFUxK	Suitable for operation of the module TST RFUxK or another communication partner approved by HÖRMANN in the housing! TTL level (Cx, Rx) Max. cable length: 10 cm for internal wiring to module		

USB host (X403)	Low-power USB memory stick with FAT32 file structure. USB profile "Mass Storage Device" (8), Sub Class Code "SCSI transparent command set" (6), Interface log "Bulk-only transfer" (0x50), Logical Unit Number (LUN 0), SCSI "Request Sense" < 2.5 s, USB-Request-Time < 2.5 s, USB-NAK < 36684x, no Hubs / Compounds possible! Plug: USB type A Max. supply: 100 mA Max. cable length: 2 m Typical data record size per door cycle (log storage function): approx. 2 KByte The temperature range must be taken into account if the USB stick is used continually within the control, e.g. as a log memory. Recommendation: <ul style="list-style-type: none"> "Industrial grade" (typ.): 0°C ... + 70°C "Extended industrial grade" (typ.): -40 °C ... + 85°C. 	
Alternatively as a USB device (X401)	PC communication with HÖRMANN service protocol "Communication device → virtual serial port" Plug USB-type B (mini USB) Max. cable length: 2 m	
	Only one USB participant may be operated on the interface!	
Security chain / emergency off (X24a-70/71, X26-90/91, X23-60/61 or X25b)	All inputs must have a volt-free connection. Contact load: ± 26 V DC / ≤ 120 mA If the security chain is disrupted, the operator can no longer move, even in press-and-hold operation. ATTENTION: No parallel connection between X25 and X25b!	
Input safety strip 1 – "Si-Lei" (X24b – tml. 72 or X27)	For electrical safety strips with 8.2 kΩ terminating resistor and for dynamic optical systems. ATTENTION: No parallel connection between X24b and X27!	
Transistor output – Out 26 (TML. 75)	Main function: "Test" 24 V DC / min. 10 mA / max. 100 mA Normally open, + 24 V switching! Only resistive loads! Fused!	
Transistor outputs – Out 28 / 29 (X18 – tml. 35 / 37)	24 V DC / min. 10 mA / max. 200 mA Normally open, + 24 V switching! Only resistive loads! Fused!	
Brake 24 V – Out 4 (X17 – 33 / 34)	24 V DC / min. 100 mA / max. 2500 mA Fused! Incl. monitoring of switching behaviour! NOTE: If the security chain is disrupted, the output is switched to a voltage-free state!	
Relay outputs Out 1 / 2 (X14 / 15)	"Malfunction / door position signals / traffic light functions" If inductive loads are switched (e.g. additional relays or brakes), they must be equipped with the appropriate suppression measures (free-wheeling diodes, varistors, RC circuits)! Volt-free change-over contact <ul style="list-style-type: none"> Min. 10 mA Max. 230 V AC / 3 A (use fused phase L'!) Contacts used once for power switching can no longer switch small currents. NOTE: Flash functions limit the mechanical service life! Change-over contact to release electromechanical brakes with upstream brake rectifier. ATTENTION: no safety function Max. 230 V AC / 3 A (use fuse phase from L'!)	
	Alternative use as a brake relay (Out 1 or 2 / X14 / 15)	

Operator output (X13):	Variant	BK / BS 150 FUE-1	AK / AS 500 FUE-1
	Nominal voltage	3 ~ 230 V	3 ~ 400 V
	Voltage range	110 to 240 V ± 10%	200 to 480 V ± 10%
	Max. voltage output	< voltage supply	
	Max. motor rated current	10 A	12.5 A
	Max. motor nominal power @ U _{Nom}	1.5 kW	5 kW
	Overload for 0.5 s Frequency	> 2x	
	On-time in housing	50 % / 50 °C 100 % / 40 °C	
	Frequency	5 to 200 Hz	
		<ul style="list-style-type: none"> Max. length of motor cable: 20 m. Shielding required! Shield on motor and control side. Do not mix up the wires for the motor cable with other wires. Note derating or temperature ranges (50% on-time, tested at 10 s ON and 10 s OFF with automatic PWM frequency preselection) During single-phase operation of the TST FU3F controls, the max. performance is reduced by at least 30%. 	
	<p>NOTE: Voltage may still be present at the motor terminals even when at a standstill or after the emergency-off has been actuated.</p>		
Brake resistance load	Integrated brake resistance Max. 1.5 kW for max. 0.5 seconds Repeat rate >20 seconds	<p>ATTENTION: Temperatures of up to 85°C may occur at the heat sink/brake resistance on the rear of the housing. In the case of malfunctions, temperatures may briefly reach 280 °C (< 5 min.)!</p>	
	Electronic monitoring! Thermal predetermined breaking point in the case of overload!		
Temperature range Operation circuit board set without housing Operation in housing: Storage:	Ambient air temperature -20 ... + 70 °C		
	-20 ... + 50 °C		
	-25 ... + 50 °C		
	Ensure housing ventilation and observe self-heating in the housing!		
	<p>NOTE: Note the requirements in the fitting instructions before selecting the fitting location! Note the temperature-dependent reduction in on-time for the operator (see "Operator output").</p>		
Device mobility	Stationary		
Device type	Motor unit, external operator is not a part of the scope of delivery from HÖRMANN		
Protection category	Protection category IP54		
Weight	Approx. 5.0 kg		
Height	< 2500 m		
Standards & directives	For details, see the specific section		
	Machinery Directive	Europe, type test	
	Low Voltage Directive	Europe (separate variants for the US market with UL certificate)	
	EMC directive	Europe	
	RoHS/WEEE/REACH	Europe	

14 Plug-in type traffic detector

SUVEK1 – Simple detector
SUVEK2 – Double detector

- 1: Diagnosis
- 2: Green LED, CH1
- 3: Red LED, CH1
- 4: DIL switches
- 5: Green LED, CH2
- 6: Red LED, CH2
- 7: Loop connection

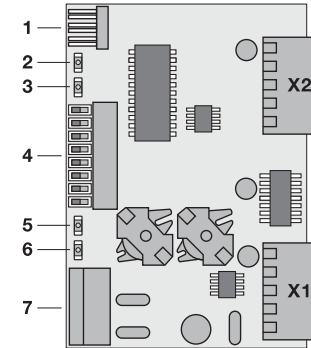





14.1 General

The induction loop detector SUVEK1 / 2 is a system for the inductive recognition of vehicles with the following properties:

- Evaluates 1 (SUVEK1) or 2 (SUVEK 2) loops
- Galvanic separation between the loop and detector electronics
- Automatic matching of the system after connecting
- Continuous readjustment of frequency drifts
- No mutual interference of loop 1 and loop 2 through multiplex method for SUVEK2
- Sensitivity independent of the loop inductivity
- Configured message by an LED display
- Galvanic separation via optoelectronic coupler on printed board outputs
- Additional looped input / output with galvanic separation via optoelectronic coupler
- Signalling of the loop frequency via LED
- Diagnosis option in conjunction with diagnosis device VEK FG2

14.2 Adjustment options

14.2.1 Sensitivity

Sensitivity level			Channel 1: DIL switch 1, 2 Channel 2: DIL switch 5, 6 (only SUVEK2)	
1	low	(0,27 % Δf / f)	ON 	OFF / OFF
2		(0,09 % Δf / f)	ON 	ON / OFF
3		(0,03 % Δf / f)	ON 	OFF / ON
4	high	(0,01 % Δf / f)	ON 	ON / ON



By adjusting the sensitivity, it is determined for each channel which inductivity change must be caused by a vehicle to cause the respective output of the detector.

Adjustment of the sensitivity is implemented separately for each channel via 2 DIL switches each.

14.2.2 Hold time

The hold time is fixed at a value of "indefinite". As long as a loop is activated, the output is connected. DIL switches 3 and 7 are without function.

14.2.3 Frequency setting and repeat adjustment

Frequency	Channel 1: DIL switch 4 Channel 2: DIL switch 8 (only SUVEK2)
Low	ON  OFF
High	ON  ON

The operating frequency of the detector can be adjusted in 2 stages via DIL switch 4 and 8.

The permissible frequency range is 30 kHz to 130 kHz. The frequency depends on the inductivity resulting from the loop geometry, number of windings and loop lead and the selected frequency level. You can initiate a readjustment manually by altering the frequency setting of a channel. When the power supply is connected, the detector independently carries out a matching of the loop frequencies. In case of short-term loss of power < 0.1 s, no readjustment will be carried out.

14.3 Connections

Connection	Designation
X1 / 1	GND supply
X1 / 2	24 V DC supply
X1 / 3	Optoelectronic coupler GND
X1 / 4	Optoelectronic coupler output channel 2 (only SUVEK2)
X1 / 5	Optoelectronic coupler output channel 1
X2 / 1	Additional optoelectronic coupler output
X2 / 2	Additional optoelectronic coupler input
X2 / 3	24 V DC output (connection X1 / 2)
X2 / 4 – X2 / 5	
X5 / 1 - X5 / 2	Loop channel 1
X5 / 3 – X5 / 4	Loop channel 2 (only SUVEK2)

14.4 Outputs and LED display

14.4.1 Outputs

Optoelectronic coupler output channel 1 / 2	Detector statuses
High	Loop free / reset / matching
Low	Loop configured / loop malfunction

The signal output takes place via the optoelectronic coupler outputs PIN 4 and 5 to the plug X1. GND reference is X1 Pin 3.

14.4.2 LED display

Green LED loop control	Red LED loop status	Detector status
Off	Off	Voltage supply missing
Flashes	Off	Matching or frequency output
On	Off	Detector ready, loop free
On	On	Detector ready, signal output
Off	On	Loop malfunction

The green LED signals that the detector is ready for operation. The red LED indicates the activation of the relay output depending on the configuration status of the loop.

14.4.3 Output of the loop frequency

Approx. 1 second after the matching of the detector, the loop frequency is displayed via flashing signals of the green LED.

Example of 57kHz loop frequency:

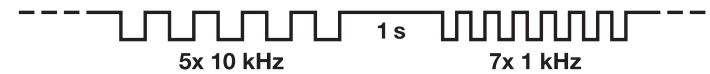

14.5 Technical data

Dimensions (L x W x H)	72.5 x 50 x 18 mm
Protection category	IP 00
Supply	24 V DC ± 20 % max. 2.0 W
Operating temperature	-20°C to +70°C
Storage temperature	-20°C to +70°C
Humidity	maximum 95% non-dewing
Loop inductivity	20 – 800 µH, recommended 75 – 400 µH
Frequency range	30 – 130 kHz in 2 stages
Sensitivity	0.01 % to 0.27 % (Δf / f) in 4 stages 0.02 % to 0.54 % (ΔL / L)
Hold time	∞
Loop lead	Max. 100 m
Loop resistance	max. 20 Ω (incl. lead)
Optoelectronic coupler output	45 V / 10 mA / 100 mW
Slow operation	50 ms SUVEK1, 100 ms SUVEK2 > 200 ms
Signal duration slow release	25 ms SUVEK1, 50 ms SUVEK2
Connection	2 x MOLEX socket series 3215, 5-pole 1 x plug terminal 4-pole, RM 3.81

15 Radio remote control 868 MHz

15.1 Receiver

NOTE:

When used at the same time, GSM 900 mobile phones can affect the range of the radio remote control.

- Briefly press the red button (programming button) on the receiver – the red LED begins to flash slowly.
- Press the hand transmitter button to be programmed at least 1 second. There must be a distance of at least 1 m between the transmitter and the receiver.
- Upon completed programming the red LED on the receiver begins to flash faster.
- Release the hand transmitter button.

After the flashing has stopped, the receiver is ready to receive.

To verify, push the programmed button of the transmitter, the red LED of the receiver lights up.

NOTE:

If no programming takes place for 30 seconds after the programming button has been pressed, the slowly flashing red LED in the receiver will be turned off again.

Canceling of the programming

If the programming button is pressed briefly 3 times within 2 seconds, the red LED is turned off and the programming procedure is abandoned.

Reception

If the receiver receives the transmitted codes, the signal output becomes active for 0.5 s. During this time, the LED on the receiver is lit.

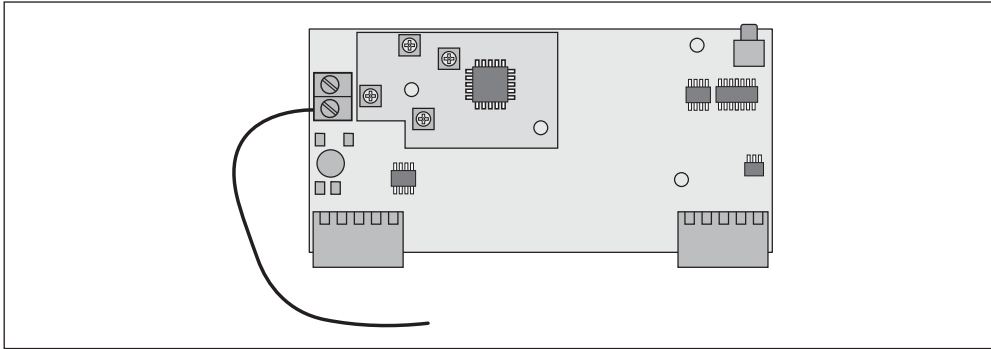

16 Light grille Lx×xF

16.1 Initial start-up and adjustment

1. Connect control
2. The status display (red LED on the receiver) flashes quickly during the adjustment process.
3. The system is ready for operation once the green LEDs are lit.
At least one light beam is interrupted if the status display (red LED on the receiver) is lit.

ATTENTION

The light grille elements may no longer be moved after initial start-up!

16.2 Output logic

Object	Output	Yellow LED
Present	Open	OFF
Not present	Closed	ON

16.3 LED display

Red	Status
Yellow	Output
Green	Operating voltage

16.4 Troubleshooting

Possible cause	Troubleshooting
The red status LED in the SGT receiver is continually lit	<ul style="list-style-type: none"> • Transmitter is inactive, check the wiring, check the test signal • Bottommost beam is interrupted, remove the obstruction • Extraneous light in the bottommost beam
Yellow output LED flickering	<ul style="list-style-type: none"> • Extraneous light from another system, change the fitting position of the other system, eliminate the light from the other system

17 RadioCrash switch

17.1 Technical data: Transmitter module

Frequency band	433 MHz, FM
Coding	Hard coded, max. 65000 different transmission codes
Protection category	IP 65, embedded
Application temperature	-20°C - +60°C
Range	outdoors 100 metres
Housing material	TPE / DuPont Hytel 7246, black
Pressure-sensitive pad material	Silicone, translucent
LED display	Red, shining through the pressure-sensitive pad
Battery	Lithium CR 1 / 3 1A2H, 3.0 V, 170 mAh, permanently installed Battery service life approx. 3 years
Module - disposal	Hazardous waste because of the embedded battery

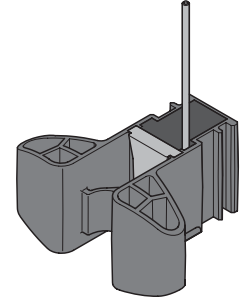

17.2 Technical data: Receiver module

Reception channels	2
Contact time	minimum 35 ms (without malfunctions of the radio distance)
Protection category	IP 65, screwed
Housing material	ABS transparent grey, PA6 GF30, TPE
Dimensions	75 x 40 x 13 mm without cable
Connection	3-core connection cable LIYY 3 x 0.14², configuration see door control wiring diagram
Output signal	Transistor output Status OK +24 V (current limited) Status crash / error Open
LED display	Green

- 1 Programming button
- 2 Status LED
- 3 Lid made of grey transparent plastic
- 4 Connection cable, configuration see door control wiring diagram
- 5 Antenna

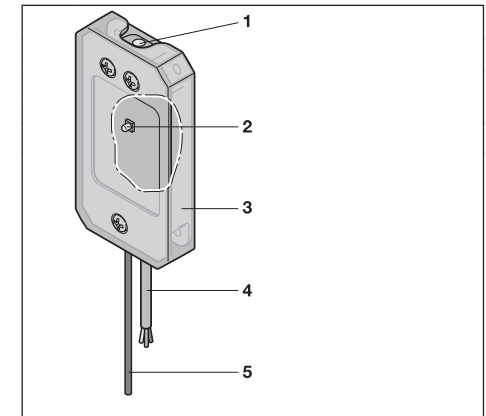

17.3 Function description

Delivery condition

Transmitter hard coded, receiver not programmed, must be programmed first. After the receiver is switched on, the LED in the receiver is permanently green. Brief flashing if a signal is received from any compatible transmitter – then permanently in green – transistor output remains open – no door function.

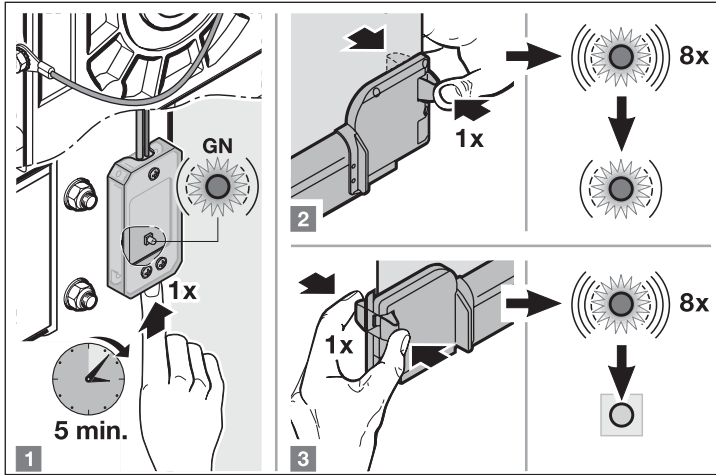

Programming

Briefly press the programming button, the LED flashes slowly. Within the next 5 minutes, first actuate the **first and then the second** crash switch. When the radio signal of the **first** crash switch is received, the LED flashes 8 x very quickly while the code is being stored. During this time, you cannot teach in a second code yet. The LED then flashes again slowly and you can teach in the second transmitter. When the radio signal of the **second** crash switch is received, the LED flashes again 8 x and goes out. You have to always teach in two **different** crash switches on a receiver.

Delete programming

Switch on voltage supply. Push and hold the programming button. LED flashes slowly. Switch off voltage supply. Now no more transmitters are taught in.

Normal transmission operation

Upon actuation of the crash switch, the transmitter generates the radio code and sends it to the receiver. The LED of the transmitter flashes once. When receiving the signal, the LED of the receiver lights up for 4 seconds. At the same time, the release signal of the transistor output is disconnected for 4 seconds.

The total number of actuations (max. 65000) of each individual crash switch is contained encrypted in the radio data log.

Decreasing battery voltage

If the voltage of the fitted battery falls below a certain value, the LED in the crash switch blinks twice instead of once after actuation in normal operation. The LED in the receiver signals this by continuous flashing. This switch should no longer be applied as new.

If the value drops below a second, lower threshold, the flashing of the receiver slows down and the release signal for the door control is interrupted.

The concerned crash switch must be replaced immediately in case of this display.

LED Displays

Transmitter	Receiver	Note
Off	Off	Resting state
Flashes 1 x	Flashes 1 x	Upon actuation: Function OK, crash signal is transmitted
Flashes 2 x	Continuous flashing	Upon actuation: Battery voltage decreased, crash signal is transmitted, replace transmitter
Flashes 2 x	Continuous flashing	Upon actuation: Battery voltage very low, crash signal is transmitted – replace transmitter
–	Constant light	Unit is not programmed – teach-in 2 transmitters