

User Manual

P Line Touch Panel

Part Number: 80860.761

Version: 7

Date: 2014-03-12

Valid for:

- TP057ZTV
- TP057GTV
- TP070ZTW
- TP070GTW
- TP090ZTW
- TP090GTW
- TP105ZTS
- TP105GTS
- TP121ZTS
- TP121GTS
- TP121ZTM
- TP121GTM
- TP150ZTX
- TP150GTX
- TP154ZTM
- TP154GTM

Version	Date	Modifications
1	2010-05-18	First Edition
2	2010-10-15	TP070ZTW, TP090ZTW, TP121ZTS added.
3	2011-09-13	TP057ZTV, TP121ZTM, TP151ZTX added.
4	2012-12-12	TP154ZTM, TP070GTW, TP090GTW, TP121GTM, TP154ZTM added.
5	2013-05-15	RS232 / RS485 COM ports updated.
6	2013-08-08	TP057ZTV, TP121GTS, TP150GTX added.
7	2014-03-12	TP105ZTS, TP105GTS added.

This manual, including all illustrations contained herein, is copyright protected. Use of this manual by any third party in departure from the copyright provision is forbidden. No part of this manual may be reproduced, translated or electronically or photographically archived or altered without the express written consent from Süttron electronic GmbH. Violations shall be cause for damage liability.
Süttron electronic reserves the right to make any changes that contribute to technical improvement.

Overall Table of Contents

1	Important Notes	7
1.1	Symbols	7
1.2	Safety Notes	7
1.3	Intended Use.....	8
1.4	Target Group.....	8
2	Installation and Commissioning.....	9
2.1	Unpacking the Device	9
2.2	Mounting the Device	9
2.2.1	Front Panel Dimensions	10
2.2.1.1	TP057ZTV / TP057GTV	10
2.2.1.2	TP070ZTW / TP070GTW	11
2.2.1.3	TP090ZTW / TP090GTW	12
2.2.1.4	TP105ZTS / TP105GTS	13
2.2.1.5	TP121ZTS / TP121GTS	14
2.2.1.6	TP121ZTM / TP121GTM	15
2.2.1.7	TP150ZTX / TP150GTX	16
2.2.1.8	TP154ZTM / TP154GTM	17
2.2.2	Mounting Cutout	18
2.2.2.1	TP057ZTV / TP057GTV	18
2.2.2.2	TP070ZTW / TP070GTW	19
2.2.2.3	TP090ZTW / TP090GTW	20
2.2.2.4	TP105ZTS / TP105GTS	21
2.2.2.5	TP121ZTS / TP121GTS	22
2.2.2.6	TP121ZTM / TP121GTM	23
2.2.2.7	TP150ZTX / TP150GTX	24
2.2.2.8	TP154ZTM / TP154GTM	25
2.2.3	Side View, Mounting Depth	26
2.2.3.1	TP057ZTV / TP057GTV	26
2.2.3.2	TP070ZTW / TP070GTW	27
2.2.3.3	TP090ZTW / TP090GTW	28
2.2.3.4	TP105ZTS / TP105GTS	29
2.2.3.5	TP121ZTS / TP121GTS	30
2.2.3.6	TP121ZTM / TP121GTM	31
2.2.3.7	TP150ZTX / TP150GTX	32
2.2.3.8	TP154ZTM / TP154GTM	33
2.3	Connecting the Device.....	34
2.3.1	Supply Voltage.....	34
2.3.2	Grounding	35
2.4	Switching On.....	36
2.4.1	Cockpit.....	36
2.4.1.1	Menu Structure	37
2.4.1.2	Settings and Functions	37
2.4.1.2.1	Language Selection.....	37
2.4.1.2.2	Date and Time.....	38
2.4.1.2.3	Administration.....	38

2.4.1.2.4	Network	38
2.4.1.2.5	Password	39
2.4.1.2.6	Display	39
2.4.1.2.7	Write Filter	39
2.5	Identification	41
3	Control and Display Elements	43
3.1	Touch Screen	43
3.2	Display	43
4	Interfaces of the Device	45
4.1	Ethernet.....	46
4.1.1	Pin Assignment	46
4.1.2	Cable.....	46
4.1.3	Diagnosis	47
4.2	USB.....	47
4.2.1	Cable.....	47
4.3	Serial Interfaces	48
4.3.1	RS-422 / RS-485 (X14).....	49
4.3.1.1	Pin Assignment.....	49
4.3.1.2	Termination.....	50
4.3.1.3	Transmitter Control.....	51
4.3.1.4	Diagnosis.....	51
4.3.2	RS232 (X15)	52
4.3.2.1	Pin Assignment.....	52
4.3.2.2	Diagnosis.....	52
4.4	Field Bus Interfaces	53
4.4.1	CAN (X12, X13)	53
4.4.1.1	Pin Assignment.....	54
4.4.1.2	Cable	54
4.4.1.3	Termination.....	55
4.4.1.4	Diagnosis.....	55
4.5	Memory Card	56
4.5.1	Inserting the memory card	56
4.5.2	Ejecting the memory card	56
4.6	Shielding D-SUB Connectors.....	57
5	Maintenance and Servicing	59
5.1	Maintenance Interval.....	59
5.2	Front Panel.....	59
5.3	Fuse	59
5.4	Battery.....	59
5.4.1	Changing the Battery	60
5.4.2	Battery Disposal	61

6	Technical Data.....	63
6.1	General	63
6.2	TP057ZTV.....	65
6.3	TP057GTV.....	67
6.4	TP070ZTW.....	69
6.5	TP070GTW.....	71
6.6	TP090ZTW.....	73
6.7	TP090GTW.....	75
6.8	TP105ZTS.....	77
6.9	TP105GTS.....	79
6.10	TP121ZTS.....	81
6.11	TP121GTS.....	83
6.12	TP121ZTM.....	85
6.13	TP121GTM.....	87
6.14	TP150ZTX.....	89
6.15	TP150GTX.....	91
6.16	TP154ZTM.....	93
6.17	TP154GTM.....	95
7	Ordering Data.....	97
A	Index.....	99

1 Important Notes

1.1 Symbols

The symbols in this manual are used to draw your attention on notes and dangers.



This is the safety alert symbol. It is used to alert you to potential personal injury hazards. Obey all safety messages that follow this symbol to avoid possible injury or death.



DANGER

This indicates a hazardous situation which, if not avoided, will result in death or serious injury.



WARNING

This indicates a hazardous situation which, if not avoided, could result in death or serious injury.



CAUTION

This indicates a hazardous situation which, if not avoided, could result in minor or moderate injury.



NOTICE

This symbol together with the signal word NOTE and the accompanying text alert the reader to a situation which may cause damage or malfunction to the device, hardware/software, or surrounding property.



This symbol and the accompanying text provide the reader with additional information or refer to detailed sources of information.

1.2 Safety Notes

- Read this manual carefully before using the operating device. Keep this manual in a place where it is always accessible to all users.
- Proper transportation, handling and storage, placement and installation of this product are prerequisites for its subsequent flawless and safe operation.
- This user manual contains the most important information for the safe operation of the device.
- The user manual, in particular the safety notes, must be observed by all personnel working with the device.
- Observe the accident prevention rules and regulations that apply to the operating site.
- Installation and operation must only be carried out by qualified and trained personnel.

1.3 Intended Use

- The device is designed for use in the industry.
- The device is state-of-the art and has been built to the latest standard safety requirements. However, dangerous situations or damage to the machine itself or other property can arise from the use of this device.
- The device fulfills the requirements of the EMC directives and harmonized European standards. Any modifications to the system can influence the EMC behavior.

**NOTICE: Radio Interference**

This is a class A device. This device may cause radio interference in residential areas. In this case, the user may be required to introduce appropriate countermeasures, and to bear the cost of same.

1.4 Target Group

The use of products described in this manual is oriented exclusively to:

- Qualified electricians or persons instructed by them, who are familiar with applicable standards and other regulations regarding electrical engineering and, in particular, the relevant safety concepts.
- Qualified application programmers and software engineers, who are familiar with the safety concepts of automation technology and applicable standards.

2 Installation and Commissioning

2.1 Unpacking the Device

Unpack all parts carefully and check the contents for any visible damage in transit. Also check whether the shipment matches the specifications on your delivery note.

If you notice damages in transit or discrepancies, please contact us immediately.

2.2 Mounting the Device



NOTICE: Damage

When installing the device, leave a gap of at least 30 mm (1.181") around the device to ensure sufficient air circulation.



NOTICE: Damage

When the operating device is installed horizontally, please note that additional sources of heat beneath the operating device may result in heat accumulation. Make sure to allow sufficient heat dissipation!

Please observe the permissible temperature range specified in the technical data of the user manual when operating the device.



NOTICE: Damage

In order to ensure the degree of protection specified in the technical data, always make sure that the seal lies flat against the mounting surface and the threaded pins of the mounting brackets are tightened uniformly to a maximum torque of 1 Nm.

The device can be easily and quickly mounted from the rear of the device. A panel thickness of 1 mm to 6 mm (0.039" to 0.236") is permitted for proper mounting.

1. Insert the device in the mounting cutout from the front.

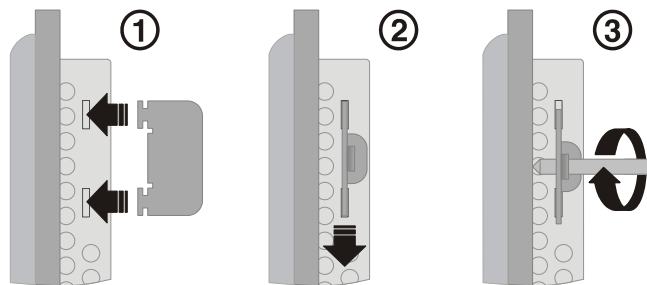

Figure 2-1 Mounting the device using a mounting bracket

2. Insert the mounting brackets into the appropriate openings (figure 1) and pull the brackets downwards until they lock in place (2).
3. Fasten the device into position using the threaded pins (3).

2.2.1 Front Panel Dimensions

2.2.1.1 TP057ZTV / TP057GTV

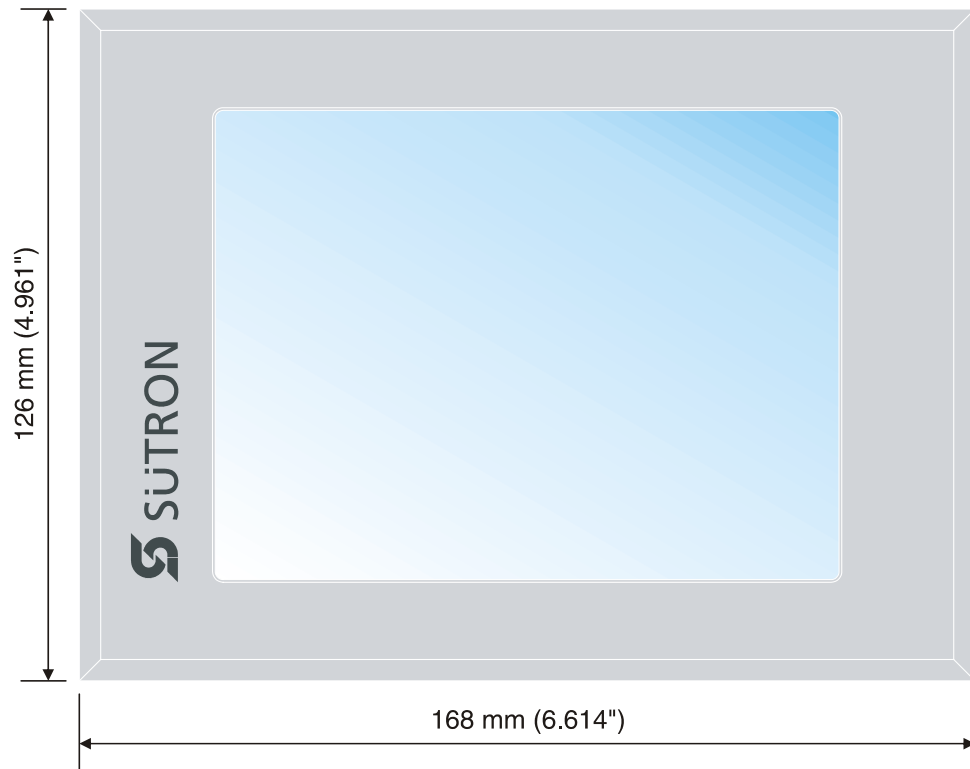

Figure 2-2 TP057ZTV / TP057GTV

2.2.1.2 TP070ZTW / TP070GTW

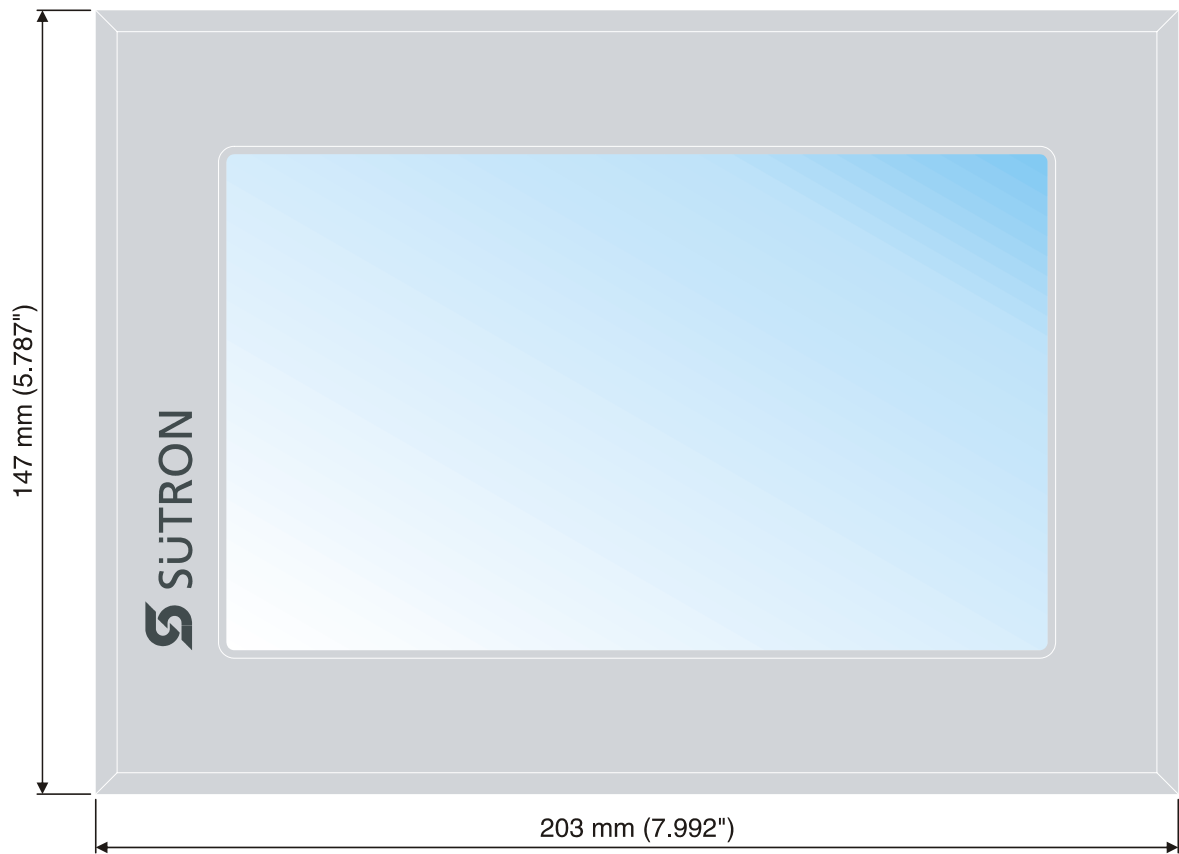

Figure 2-3 TP070ZTW / TP070GTW

2.2.1.3 TP090ZTW / TP090GTW



Figure 2-4 TP090ZTW / TP090GTW

2.2.1.4 TP105ZTS / TP105GTS

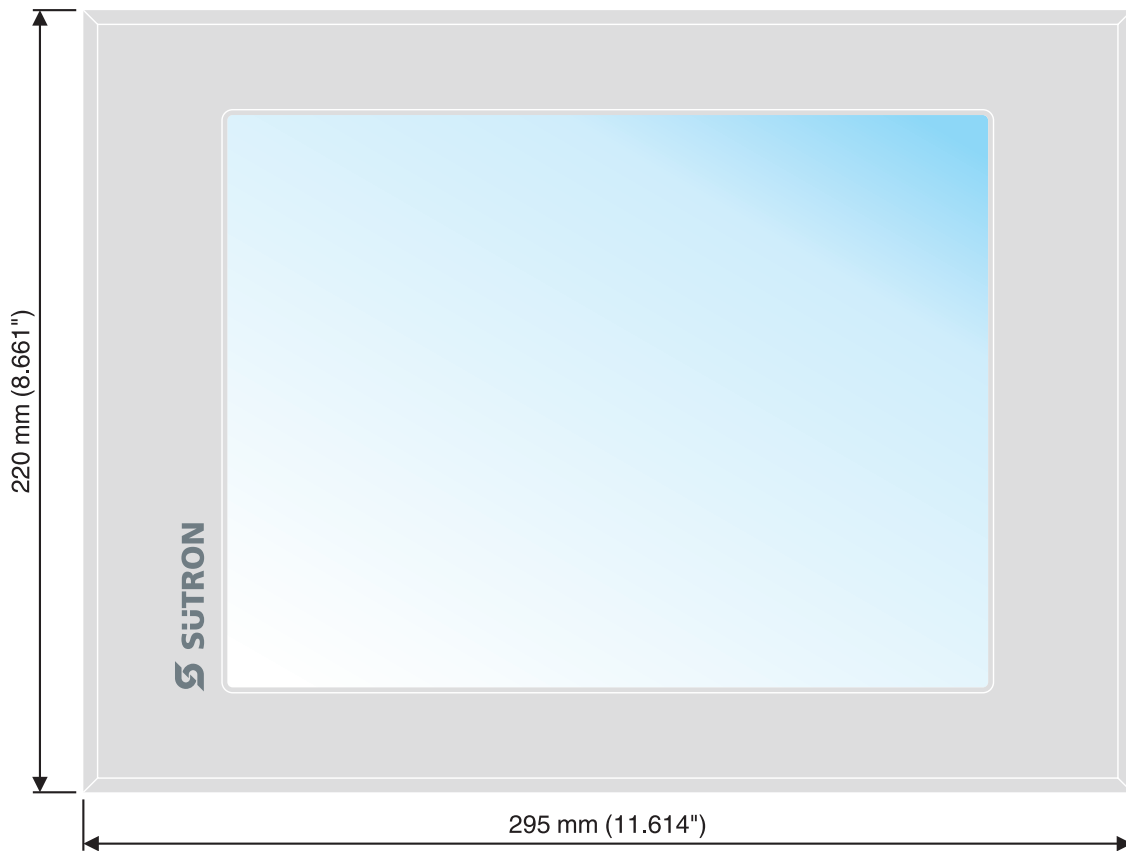

Figure 2-5 TP105ZTS / TP105GTS

2.2.1.5 TP121ZTS / TP121GTS

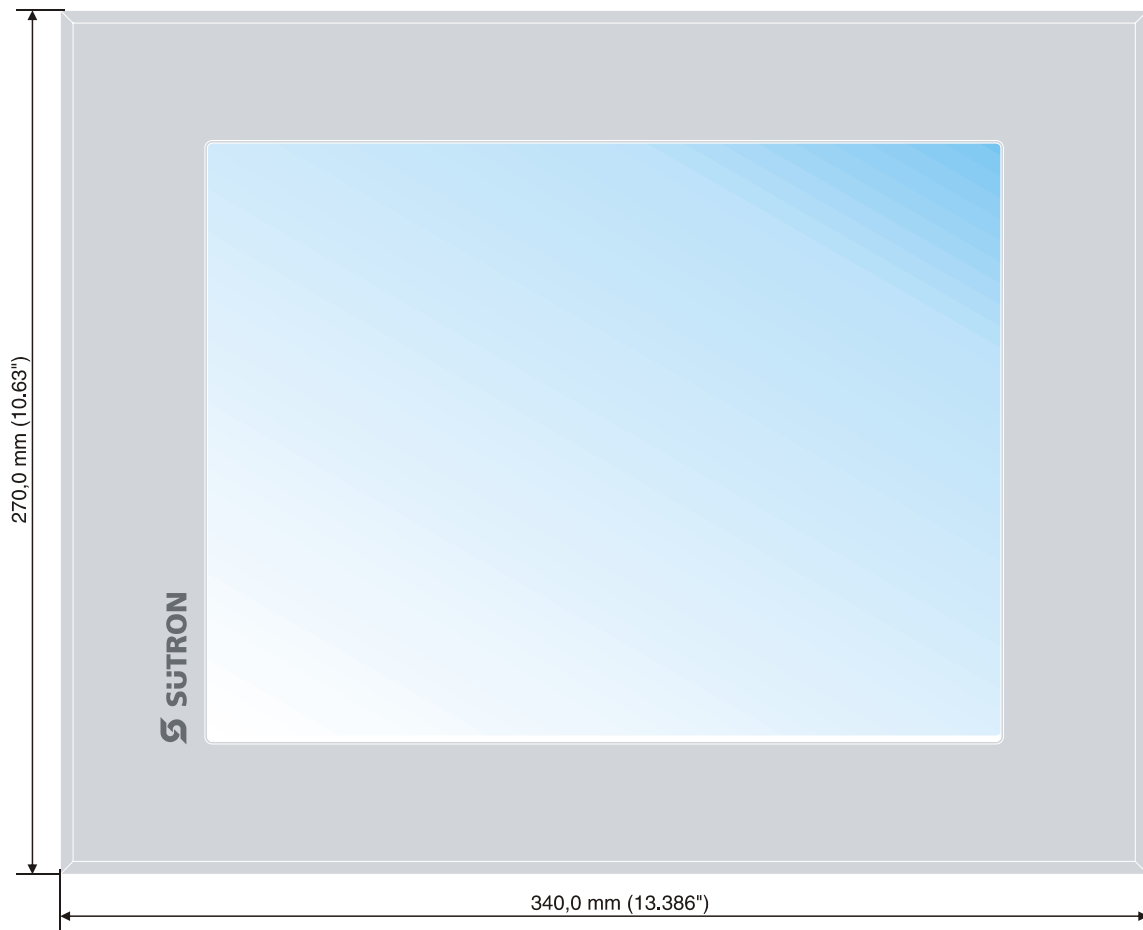

Figure 2-6 TP121ZTS / TP121GTS

2.2.1.6 TP121ZTM / TP121GTM



Figure 2-7 TP121ZTM / TP121GTM

2.2.1.7 TP150ZTX / TP150GTX

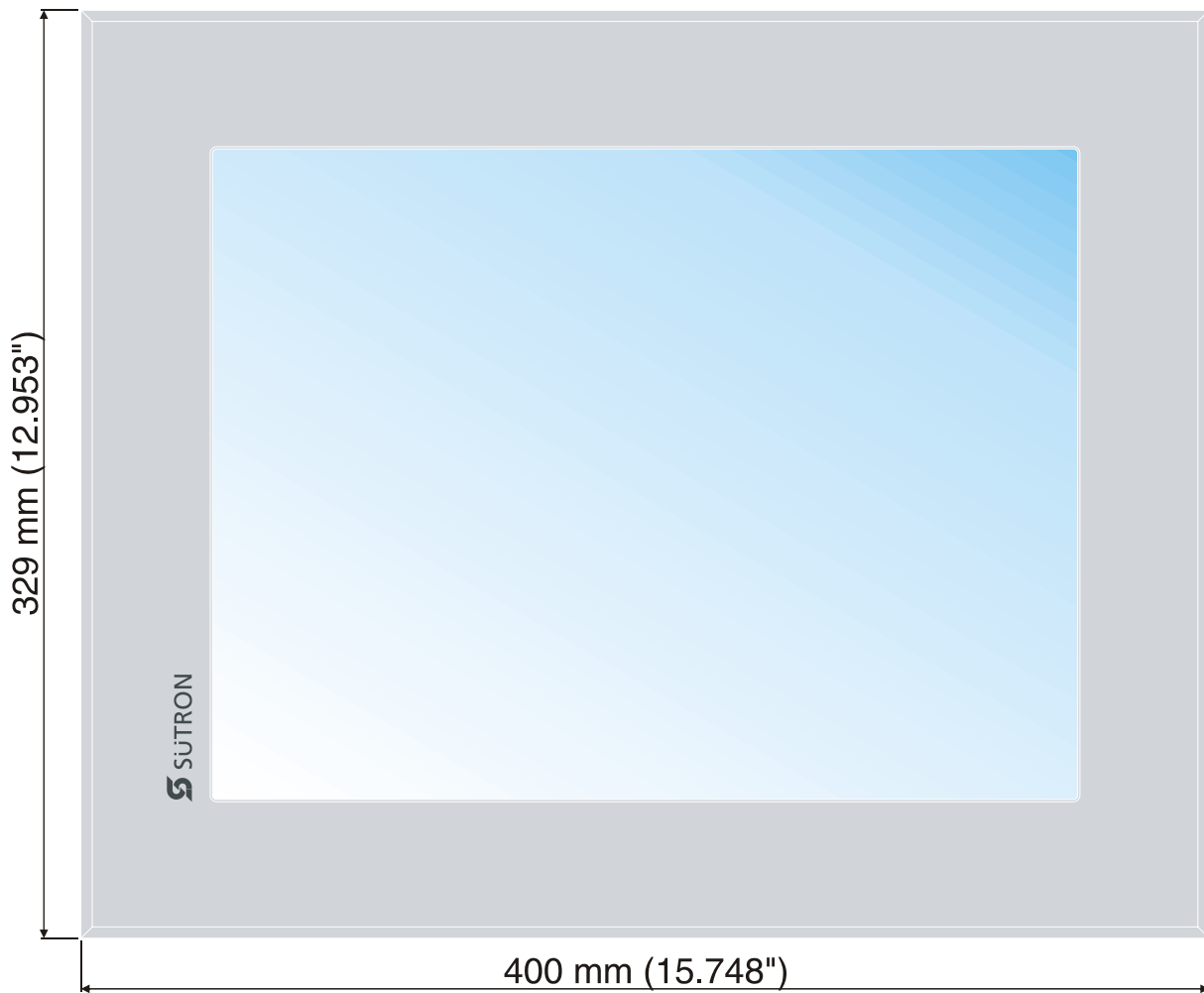

Figure 2-8 TP150ZTX / TP150GTX

2.2.1.8 TP154ZTM / TP154GTM



Figure 2-9 TP154ZTM / TP154GTM

2.2.2 Mounting Cutout

2.2.2.1 TP057ZTV / TP057GTV

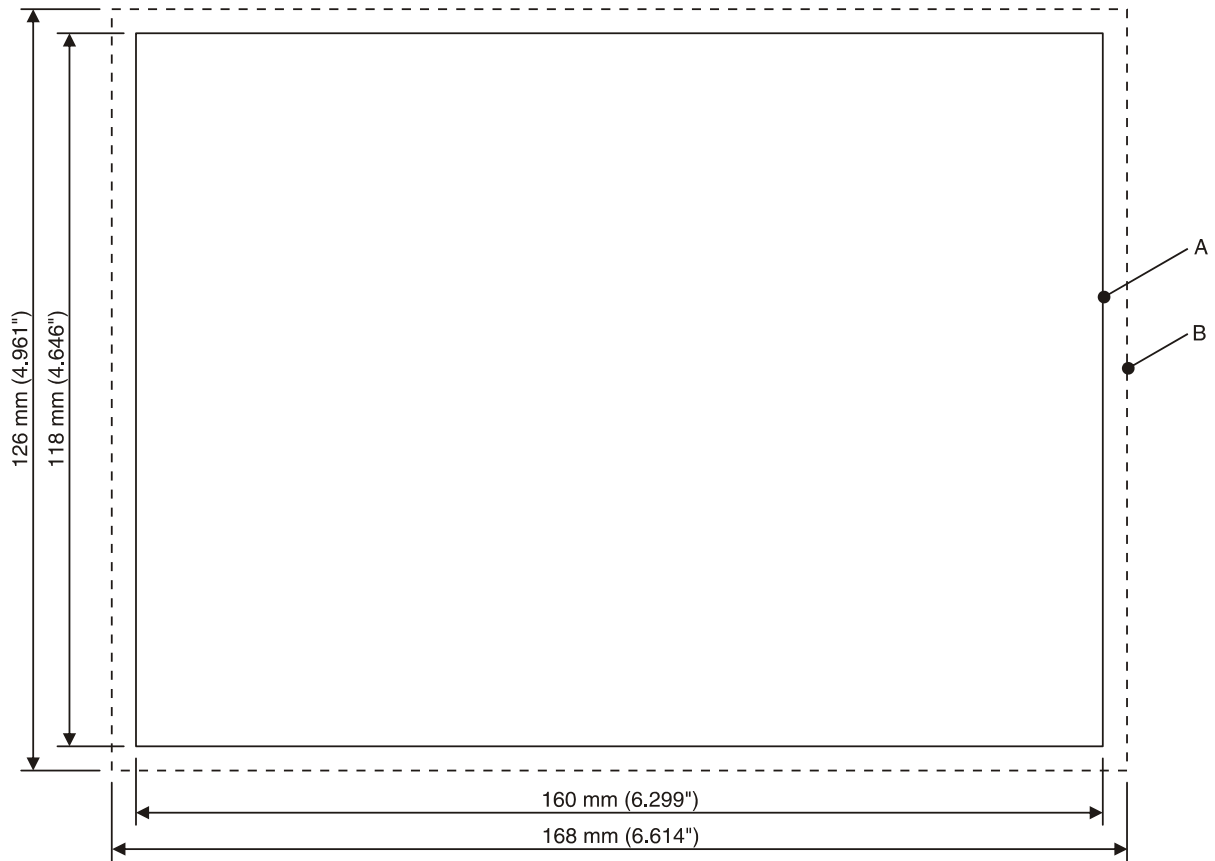

Figure 2-10 TP057ZTV / TP057GTV

- A** Mounting Cutout
- B** Front Panel

2.2.2.2 TP070ZTW / TP070GTW

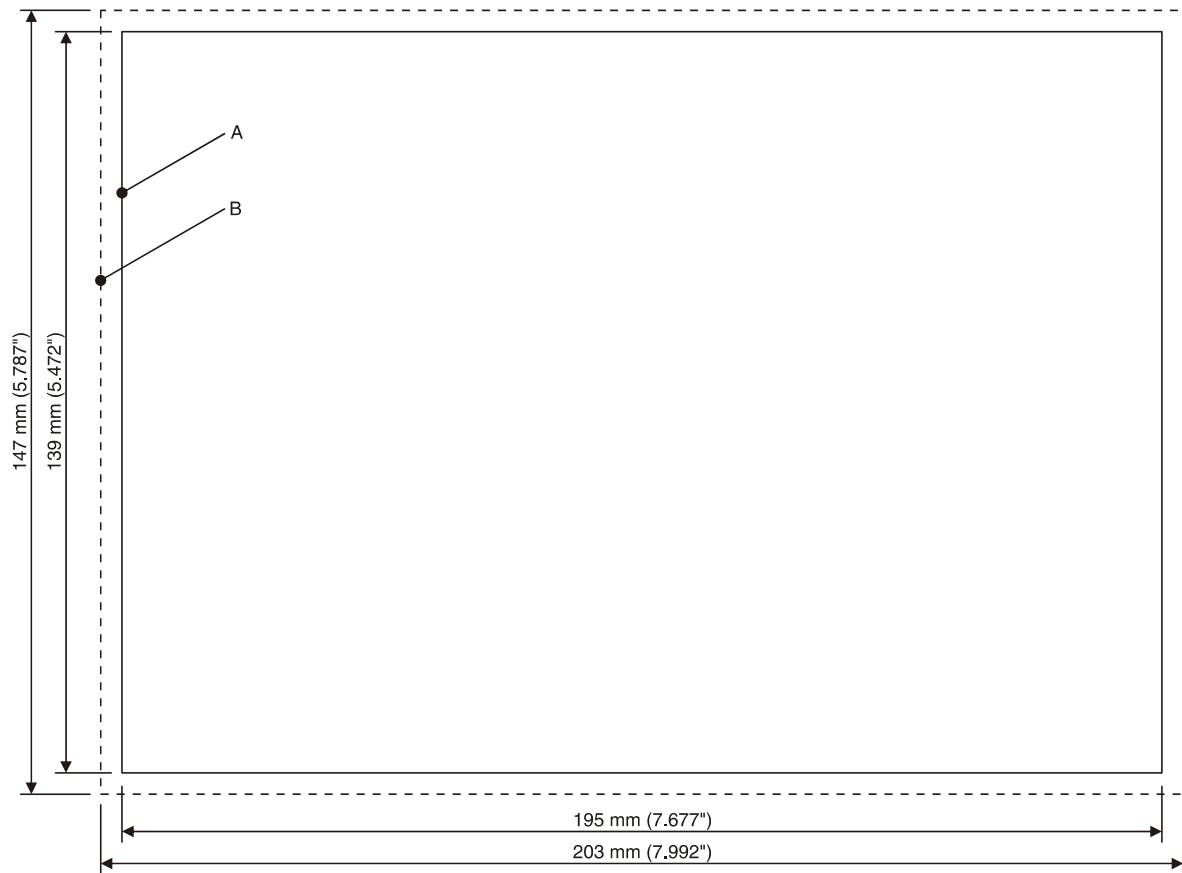

Figure 2-11 TP070ZTW / TP070GTW

- A Mounting Cutout
- B Front Panel

2.2.2.3 TP090ZTW / TP090GTW



Figure 2-12 TP090ZTW / TP090GTW

- A Mounting Cutout
- B Front Panel

2.2.2.4 TP105ZTS / TP105GTS

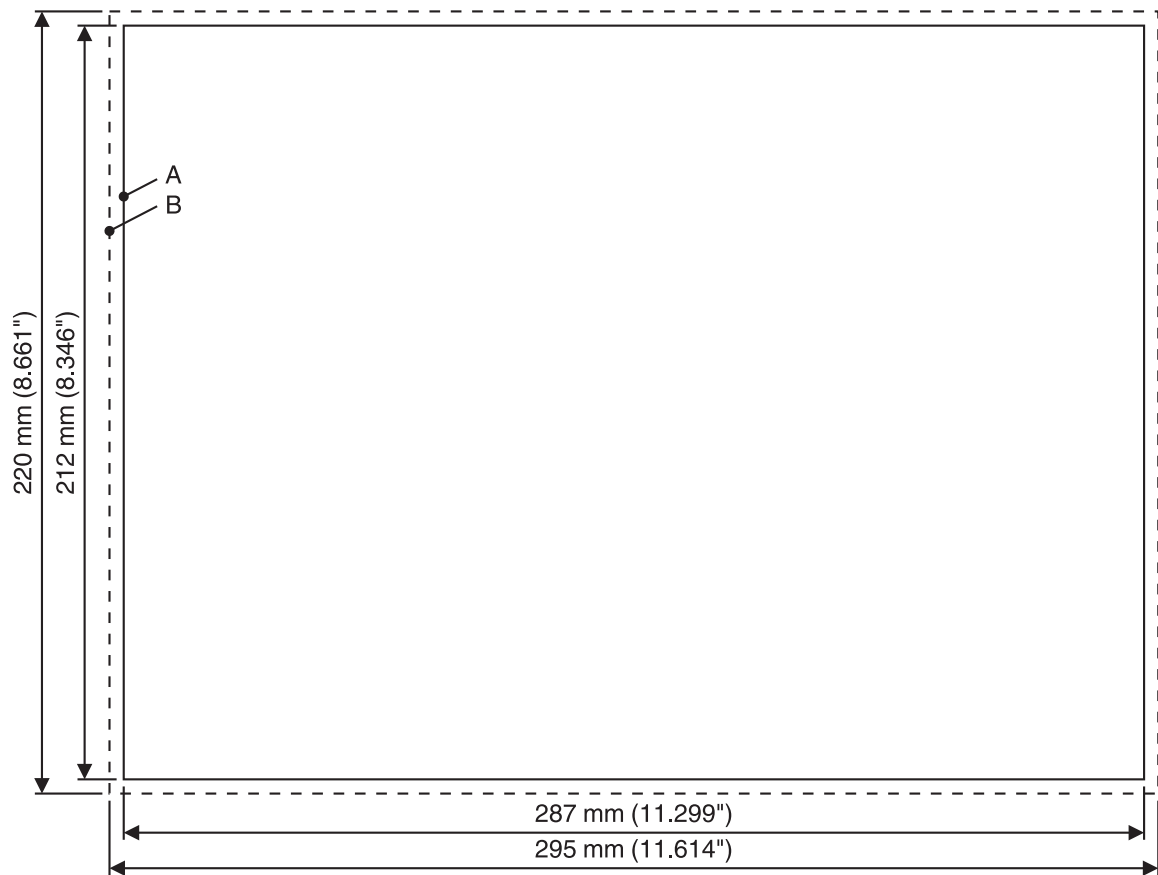

Figure 2-13 TP105ZTS / TP105GTS

A Mounting Cutout

B Front Panel

2.2.2.5 TP121ZTS / TP121GTS

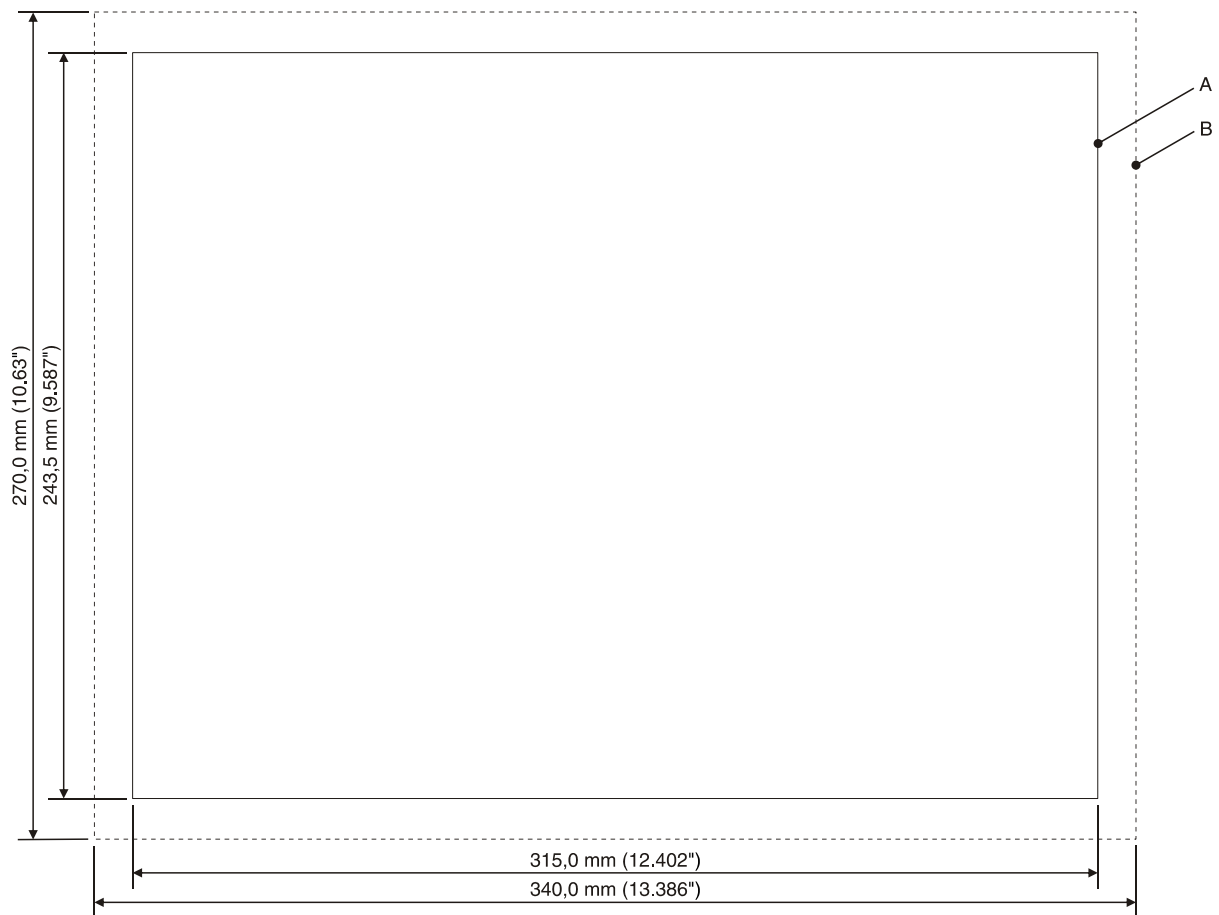

Figure 2-14 TP121ZTS / TP121GTS

- A Mounting Cutout
- B Front Panel

2.2.2.6 TP121ZTM / TP121GTM

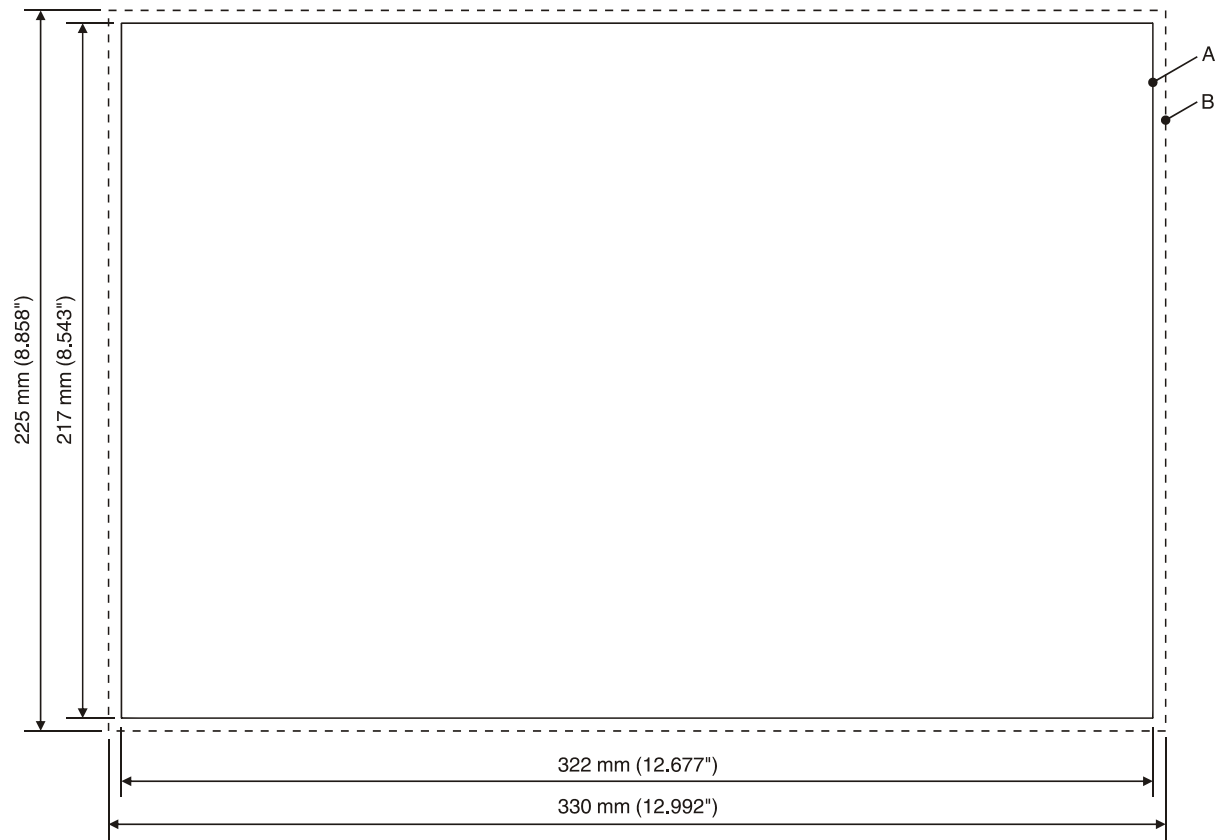

Figure 2-15 TP121ZTM / TP121GTM

- A** Mounting Cutout
- B** Front Panel

2.2.2.7 TP150ZTX / TP150GTX

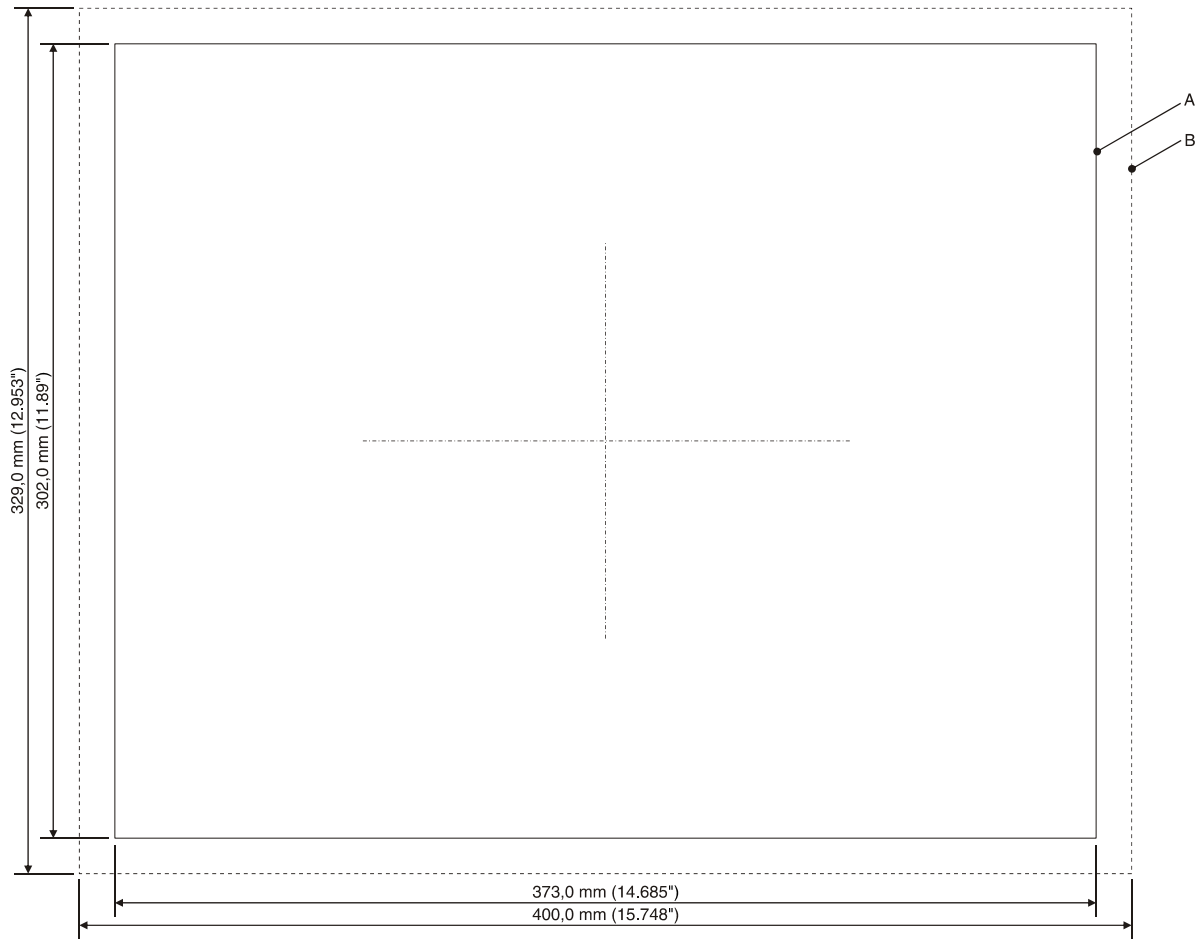

Figure 2-16 TP150ZTX / TP150GTX

- A Mounting Cutout
- B Front Panel

2.2.2.8 TP154ZTM / TP154GTM



Figure 2-17 TP154ZTM / TP154GTM

- A** Mounting Cutout
- B** Front Panel

2.2.3 Side View, Mounting Depth

2.2.3.1 TP057ZTV / TP057GTV

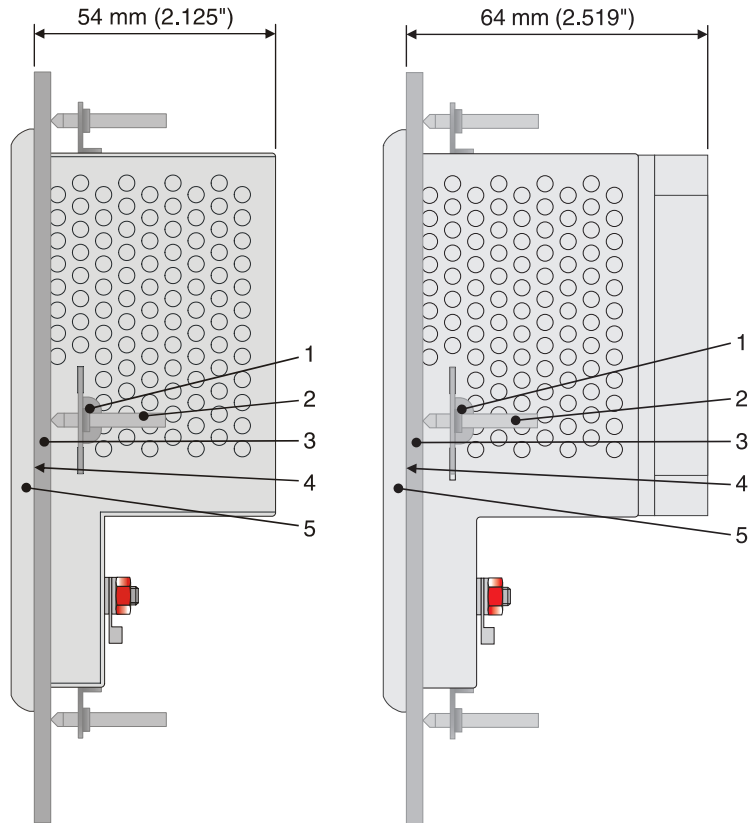

Figure 2-18 TP057ZTV / TP057GTV

- 1 Mounting Bracket
- 2 Threaded Pin
- 3 Mounting Surface Thickness 1 mm to 6 mm
- 4 Circumferential Seal
- 5 Front Panel

2.2.3.2 TP070ZTW / TP070GTW

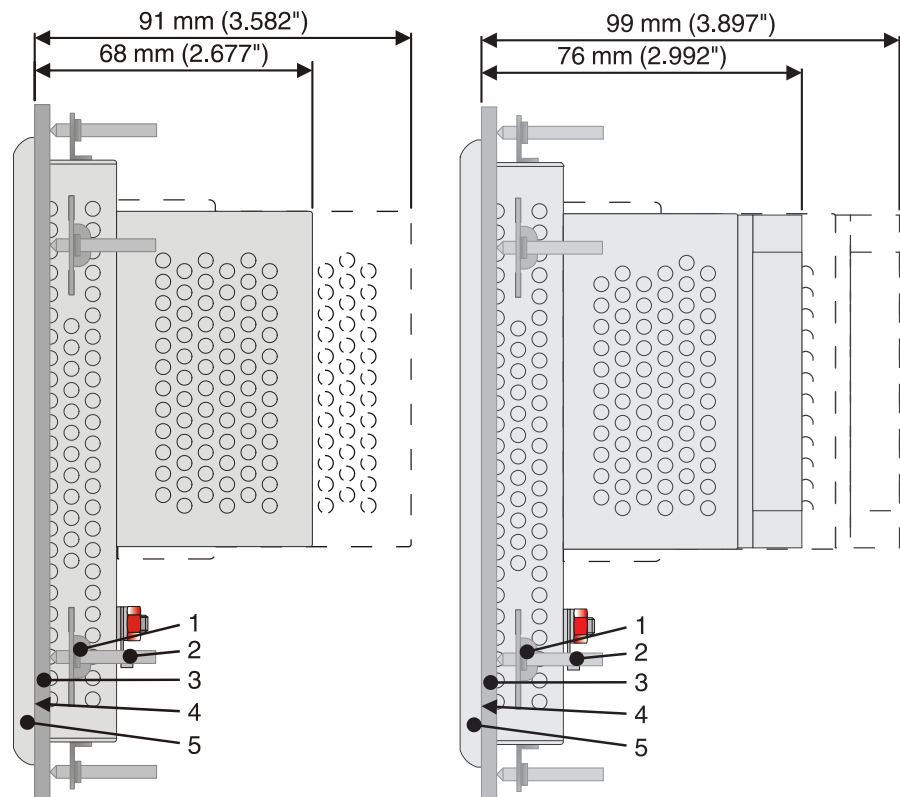

Figure 2-19 TP070ZTW / TP070GTW

- 1 Mounting Bracket
- 2 Threaded Pin
- 3 Mounting Surface Thickness 1 mm to 6 mm
- 4 Circumferential Seal
- 5 Front Panel

2.2.3.3 TP090ZTW / TP090GTW

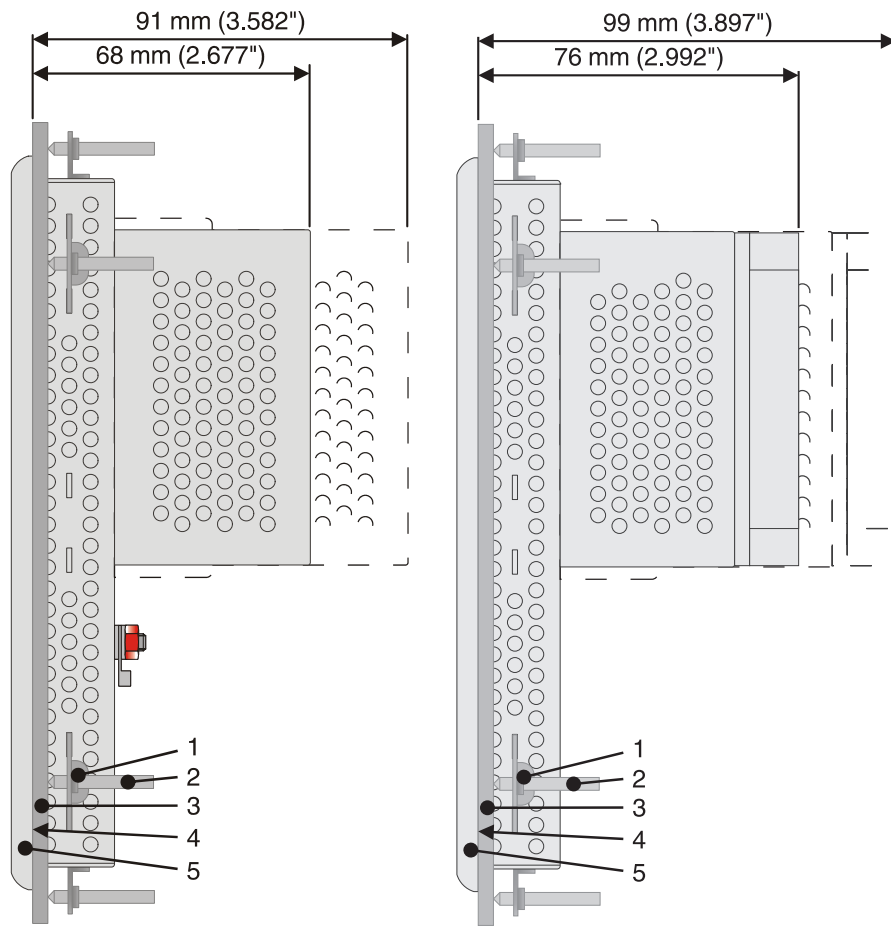

Figure 2-20 TP090ZTW / TP090GTW

- 1 Mounting Bracket
- 2 Threaded Pin
- 3 Mounting Surface Thickness 1 mm to 6 mm
- 4 Circumferential Seal
- 5 Front Panel

2.2.3.4 TP105ZTS / TP105GTS

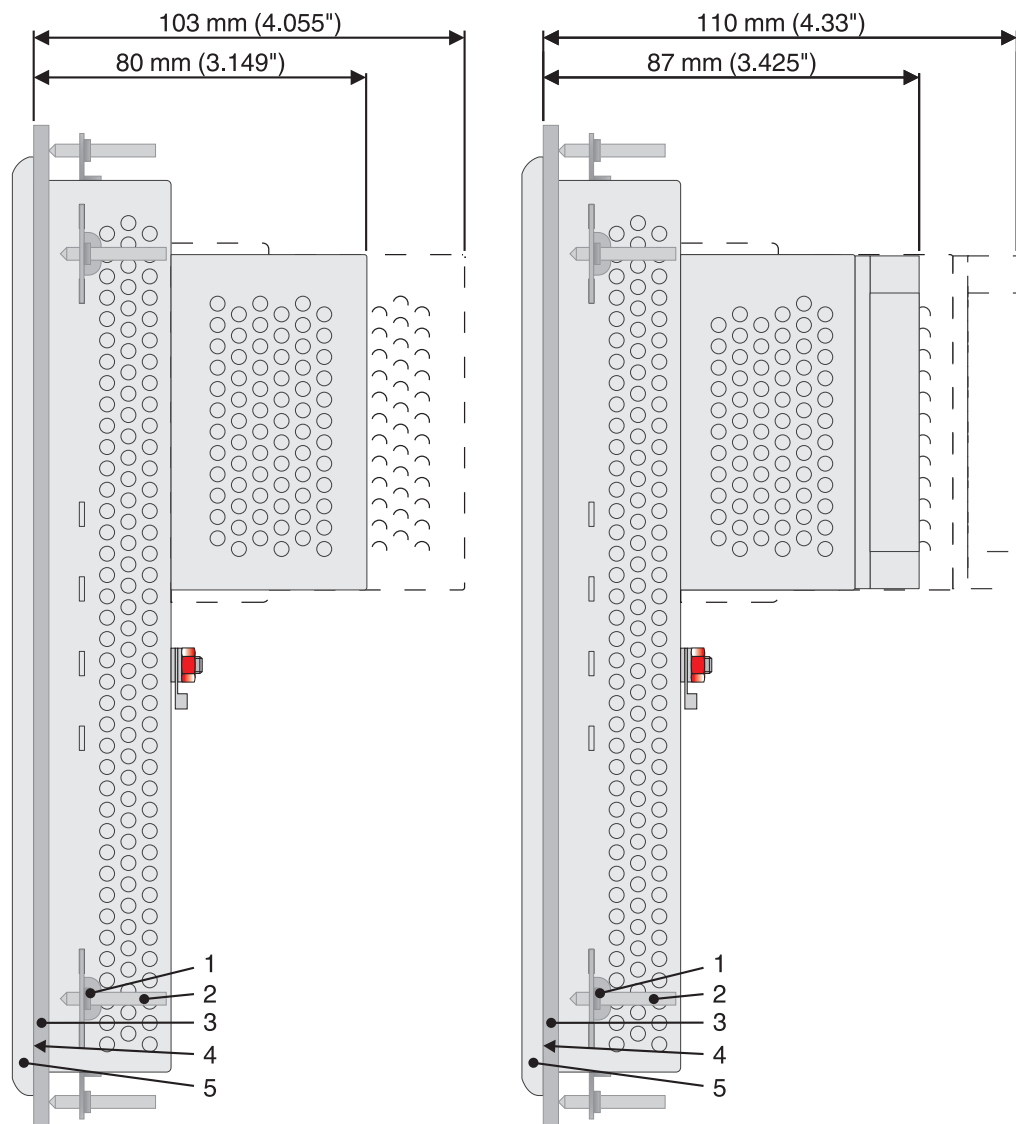

Figure 2-21 TP105ZTS / TP105GTS

- 1 Mounting Bracket
- 2 Threaded Pin
- 3 Mounting Surface Thickness 1 mm to 6 mm
- 4 Circumferential Seal
- 5 Front Panel

2.2.3.5 TP121ZTS / TP121GTS

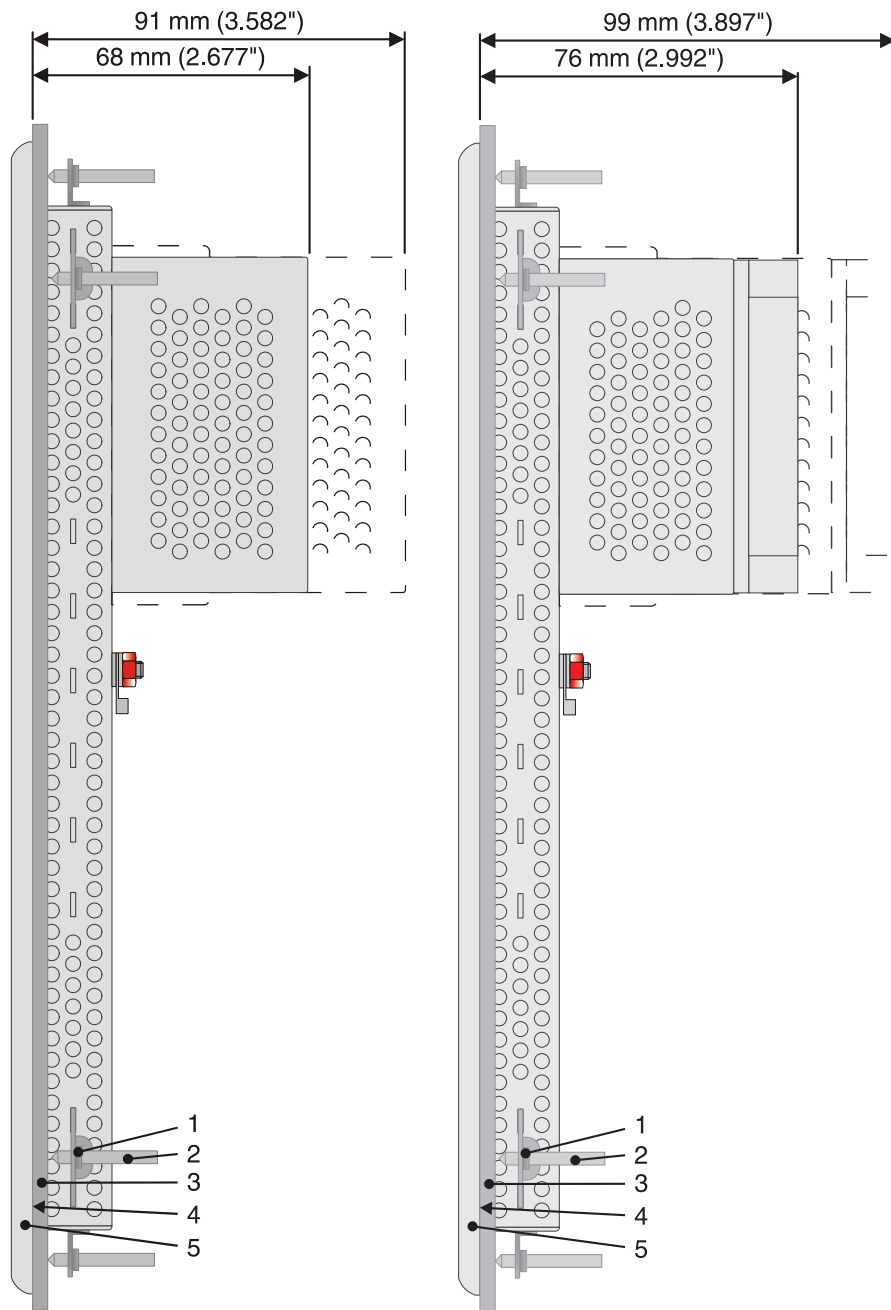

Figure 2-22 TP121ZTS / TP121GTS

- 1 Mounting Bracket
- 2 Threaded Pin
- 3 Mounting Surface Thickness 1 mm to 6 mm
- 4 Circumferential Seal
- 5 Front Panel

2.2.3.6 TP121ZTM / TP121GTM

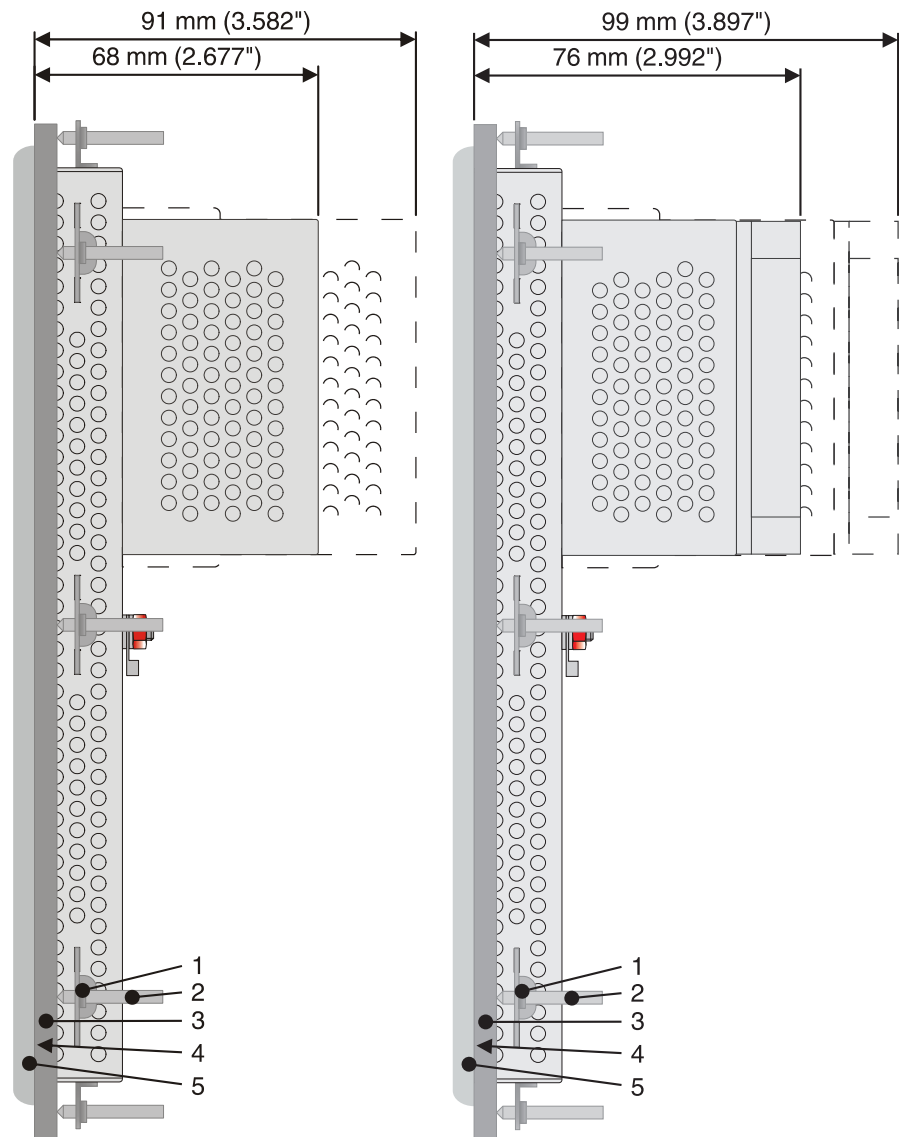

Figure 2-23 TP121ZTM / TP121GTM

- 1 Mounting Bracket
- 2 Threaded Pin
- 3 Mounting Surface Thickness 1 mm to 6 mm
- 4 Circumferential Seal
- 5 Front Panel

2.2.3.7 TP150ZTX / TP150GTX

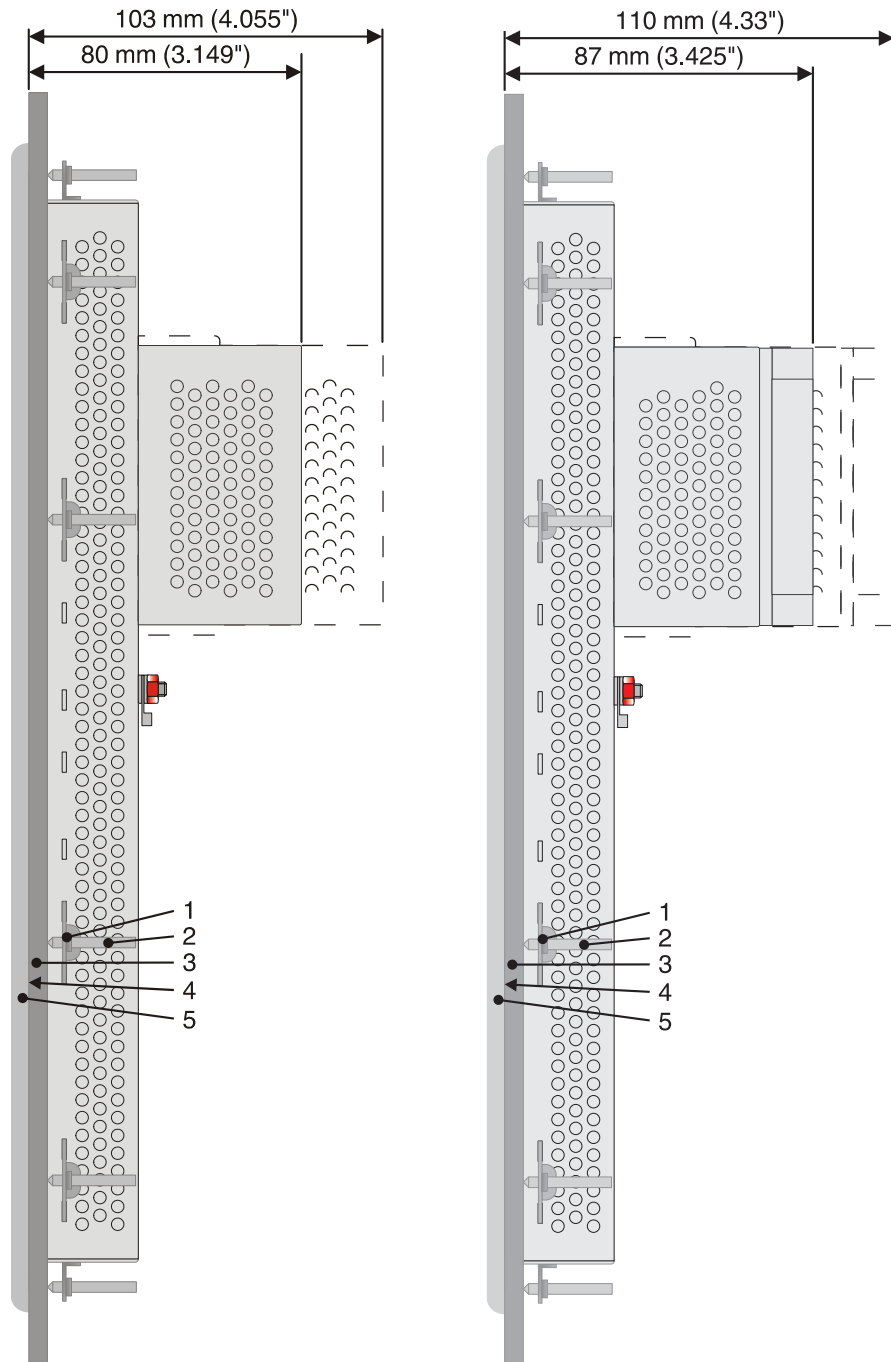

Figure 2-24 TP150ZTX / TP150GTX

- 1 Mounting Bracket
- 2 Threaded Pin
- 3 Mounting Surface Thickness 1 mm to 6 mm
- 4 Circumferential Seal
- 5 Front Panel

2.2.3.8 TP154ZTM / TP154GTM

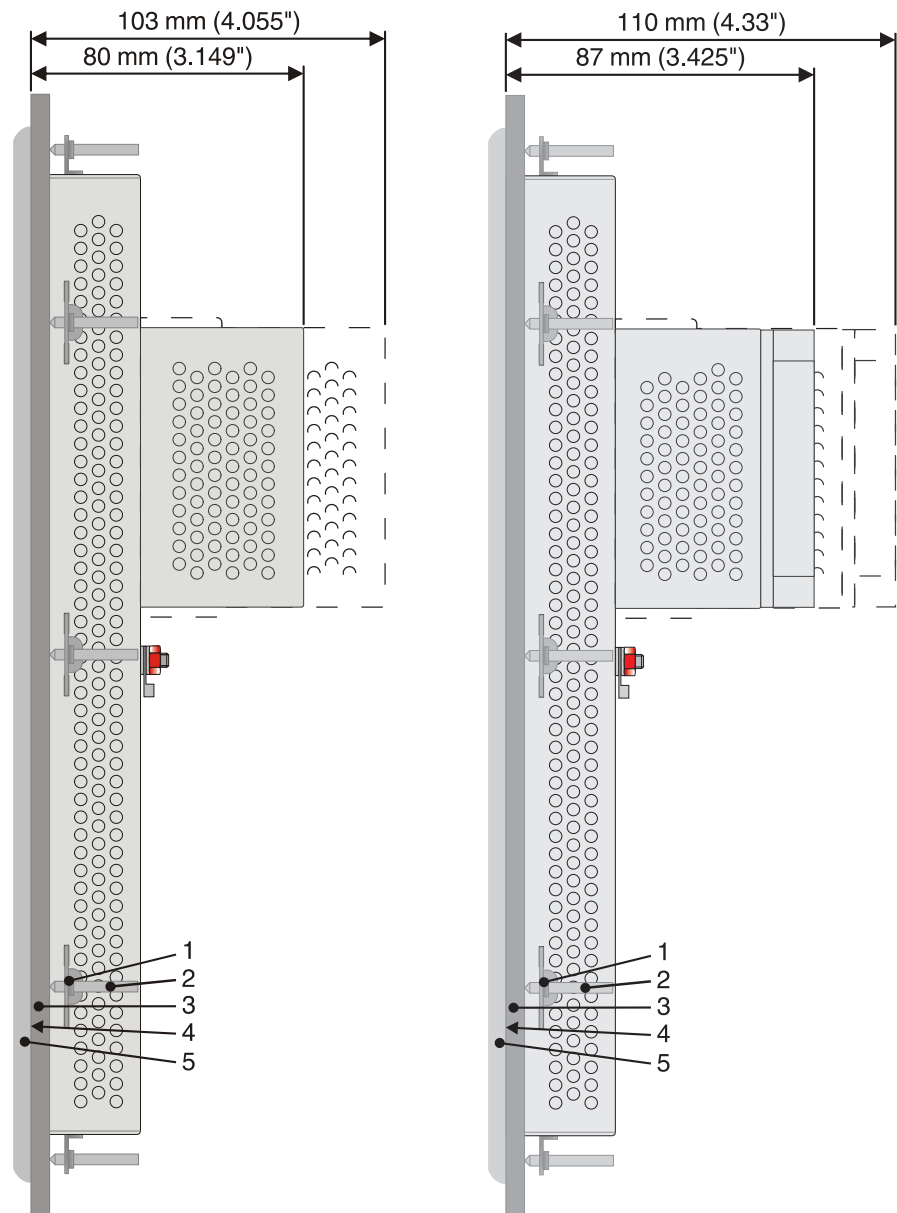

Figure 2-25 TP154ZTM / TP154GTM

- 1 Mounting Bracket
- 2 Threaded Pin
- 3 Mounting Surface Thickness 1 mm to 6 mm
- 4 Circumferential Seal
- 5 Front Panel

2.3 Connecting the Device

2.3.1 Supply Voltage

The supply voltage is supplied via pin strip X1. A suitable socket strip is supplied. Refer to the technical data for the permissible supply voltage of the operating device.



The device has reverse polarity protection. In case of wrong polarity, the device will not operate.



This is a protection class I device. For safe operation, safety extra-low voltage (SELV) in accordance with DIN EN 61131 must be used for the supply voltage.

Connector in the operating device: 3 pin pin strip

Table 2-1 Pin assignment supply voltage

Pin	Designation	Function
1		Noiseless ground / functional earth ground (FE)
2	0 V	Supply voltage 0 V (GND)
3	=== 24 V	Supply voltage === 24 V



NOTICE: Damage

Cables with finely stranded copper conductors with a minimum cross-section of 0.75 mm² (18 AWG) and a maximum cross-section of 2.5 mm² (14 AWG) must be used for the supply voltage.

You must adhere to the following torques at the connector:

Screw connection of terminal blocks: 0.22 Nm (minimal) to 0.25 Nm (maximum)
Screw flange: 0.3 Nm (maximum)



DANGER: Hazardous voltages

Hazardous voltages can exist inside electrical installations that can pose a danger to humans. Coming in contact with live parts may result in electric shock!

Use the following procedure to connect the device to the supply voltage:

- Strip approx. 30 mm (1.181") off the outer cable sheath and approx. 5 mm (0.197") off the wires.

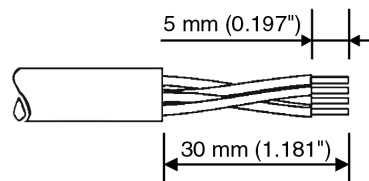

Figure 2-26 Preparing the cable

- Fit the wires with wire end ferrules and connect the wires to the socket strip.
- Plug the socket strip onto pin strip X1.
- Secure the socket strip in place with a screw-type locking to prevent it from slipping out.

2.3.2 Grounding

The grounding is performed - depending on the type of device - with a slip-on sleeve (noiseless ground / functional earth ground) or a ring cable lug (protective ground).

**NOTICE: Damage**

A separate copper conductor must always be provided for the grounding. The conductor must have a minimum cross-section of 1.5 mm² (16 AWG) and must be kept as short as possible.

You must adhere to a maximum torque of 1 Nm at a protective grounding on the threaded bolt.

1. Strip approx. 5 mm (0.197") off the wires.
2. Fit the stripped wires - depending on the type of device - with a slip-on sleeve or a ring cable lug.
3. Plug the slip-on sleeve on the flat tab or mount the ring cable lug with the nut to the threaded bolt.

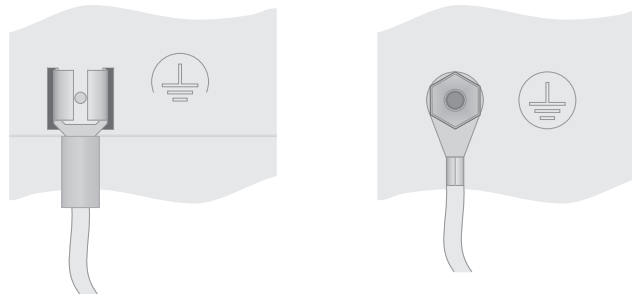

Figure 2-27 Noiseless ground / protective ground

2.4 Switching On

When switching on the operating system loads. The interface for SD/SDHC cards is available for applications and other data.

2.4.1 Cockpit

The operating device allows you - by starting the cockpit during the startup phase - to make changes to the device configuration.

Start cockpit at system startup

To start the cockpit, do the following:

1. Wait during the startup phase until the following dialog is displayed:

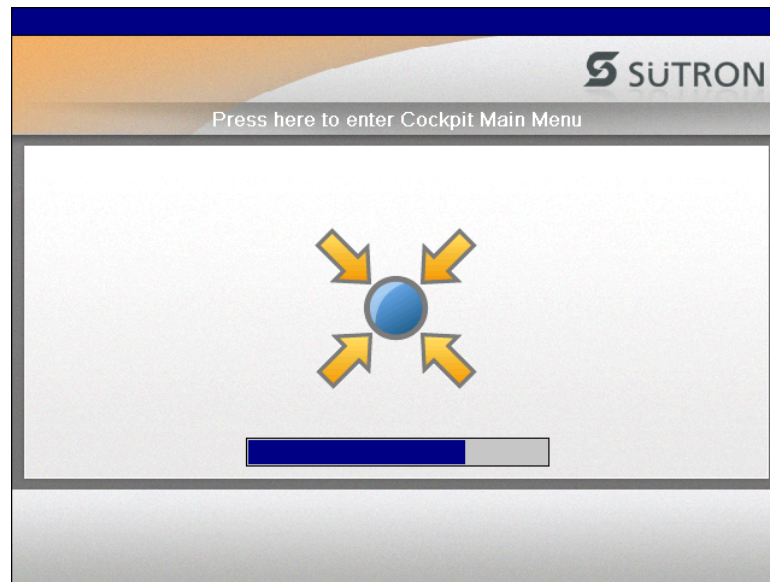

Figure 2-28 Cockpit startup phase



2. Press the button to start the cockpit before the progress bar is down.

You can customize the language of the cockpit interface at the language menu item.



3. Press the button **Language Selection**.

4. Select the desired language.



5. Confirm your selection with the green check.

Using desktop icon to start cockpit

You can start the cockpit via the desktop icon at already started operating devices with active desktop:



1. Briefly press twice on the desktop icon.



2. Press the button to start the cockpit before the progress bar is down.

You can customize the language of the cockpit interface at the language menu item.



3. Press the button **Language Selection**.

4. Select the desired language.



5. Confirm your selection with the green check.

2.4.1.1 Menu Structure

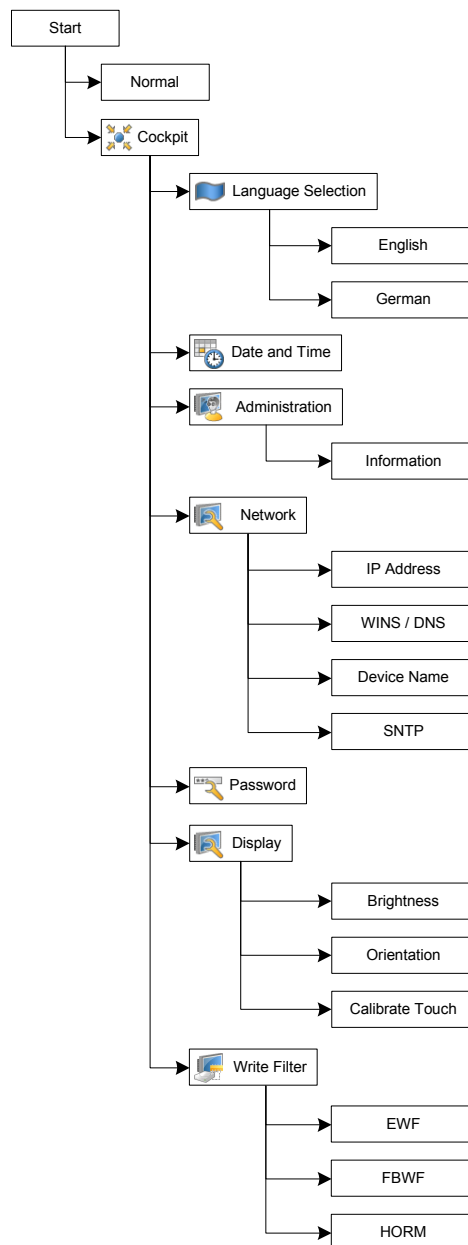

2.4.1.2 Settings and Functions



Some settings are password-protected. The default password is "+-+-".

2.4.1.2.1 Language Selection



You can customize the language of the cockpit interface at the language menu item.

1. Select the desired language.
2. Confirm your selection with the green check.



2.4.1.2.2 Date and Time



You set up date, time and time zone via the **Date and Time** menu item.

2.4.1.2.3 Administration



The **Administration** menu shows device information.

Information

The following informations are displayed:

- Device type
- Hardware version,
- Serial number,
- Image name,
- Image date,
- Operating system.

2.4.1.2.4 Network



You can configure the network settings with the **Network** menu item.

IP Address

Use Dynamic IP (DHCP)

The network configuration is automatically obtained from the DHCP server.



Confirm your selection with the green check.

Use Static IP

Manually assign an ip address, subnet mask and gateway of the operating device.



Confirm your selection with the green check.

WINS / DNS

Optionally, enter the addresses for the WINS / DNS server.



Confirm your selection with the green check.



The input fields are only active when you set up a static ip.

Device Name

You can define a device name with a maximum of 15 characters. Via network, the device can be accessed with the device name instead of the ip address.



Confirm your selection with the green check.

SNTP

Enter the address of an intranet or internet time server. Define an interval in milliseconds for time synchronization.



Confirm your selection with the green check.

2.4.1.2.5 Password



The menu item **Password** allows you to protect certain menu items in the cockpit with a password.

Current password



1. Enter a password for the protected menu items.
2. Confirm your selection with the green check.

Password protected



1. Select the menu items which shall get a password protection.
2. Confirm your selection with the green check.

2.4.1.2.6 Display



This category offers the following functions:

- Brightness and orientation of the display
- Calibration of the touch

Brightness



1. Adjust the brightness using the slider or the arrow symbols.
2. Confirm your selection with the green check.

Orientation



1. Turn the orientation using the buttons **Turn left** and **Turn right** to the desired position.
2. Confirm your selection with the green check.

Depending on device type, the new orientation is accepted immediately or after a reboot of the operating device.

3. Press the **OK** button.

Calibrate Touch

1. Press the **Recalibrate** button.

Depending on device type the calibration is automatically started immediately or after a reboot of the operating device.

2. Press the displayed marks to calibrate the touch.

2.4.1.2.7 Write Filter



This category offers the following functions:

- Enhanced write filter (EWF)
- File based write filter (FBWF)
- Hibernate once, resume many (HORM)

EWF

The enhanced write filter (EWF) protects your system from write access and instead writes the data to the main memory.



NOTICE

With enabled write protection, all data in the main memory of the operating device are lost after a restart.

Enable EWF



1. Press the **Enable EWF** button.
2. Confirm your selection with the green check.
3. Restart the operating device for the changes to take effect.

Disable EWF

1. Press the **Disable EWF** button.
2. Confirm your selection with the green check.
3. Restart the operating device for the changes to take effect.

FBWF

The file based write filter (FBWF) protects your system from write access and instead writes the data to the main memory. The selected folders are not protected.

**NOTICE**

With enabled write protection, all data in the main memory of the operating device are lost after a restart.

Enable FBWF

1. Press the **Enable FBWF** button.
2. Confirm your selection with the green check.
3. Restart the operating device for the changes to take effect.

Disable FBWF

1. Press the **Disable FBWF** button.
2. Confirm your selection with the green check.
3. Restart the operating device for the changes to take effect.

Exclude Folders

1. Select the folders that should be not write protected.
2. Press the **Exclude Folders** button.
3. Confirm your selection with the green check.
4. Restart the operating device for the changes to take effect.

HORM

The current state of the system can be saved and restored automatically at every startup. The boot process is accelerated by this function.

Enable HORM

To use HORM, EWF must be active.

1. Press the **Enable HORM** button.
2. Press the **Hibernate System** button to save the current state.

Disable HORM

1. Press the **Disable HORM** button.
2. Confirm your selection with the green check.
3. Restart the operating device for the changes to take effect.

Hibernate System

1. Press the **Hibernate System** button.

The operating device is set to hibernation. Thereby the current state of the system is saved and restored automatically at every startup.

2.5 Identification

The operating device can be identified using the nameplate on the rear of the device.



Figure 2-29 Nameplate (example)

- 1 Device Type
- 2 Software Version (Version on Delivery)
- 3 MAC Addresses
- 4 Voltage and Current
- 5 Serial Number

3 Control and Display Elements

3.1 Touch Screen

The device is equipped with a resistive 4 wire touch screen. You operate the device using this touch screen.

**NOTICE: Damage**

Pointed or sharp objects, such as pens or fingernails, can lead to irreparable damages of the touch screen. Exclusively therefore use the fingertips or the aids indicated in the technical data for the operation.

**NOTICE: Damage**

To protect the touch screen you can use special protection foils. You receive corresponding protection foils directly from Süttron electronic.

3.2 Display

**DANGER: Toxic**

If the display is damaged, avoid touching, swallowing or breathing in the liquids or gases which may leak out!

**DANGER: Corrosive**

If the display is damaged, avoid touching, swallowing or breathing in the liquids or gases which may leak out!

The operating device is equipped with different displays depending on variant.

4 Interfaces of the Device

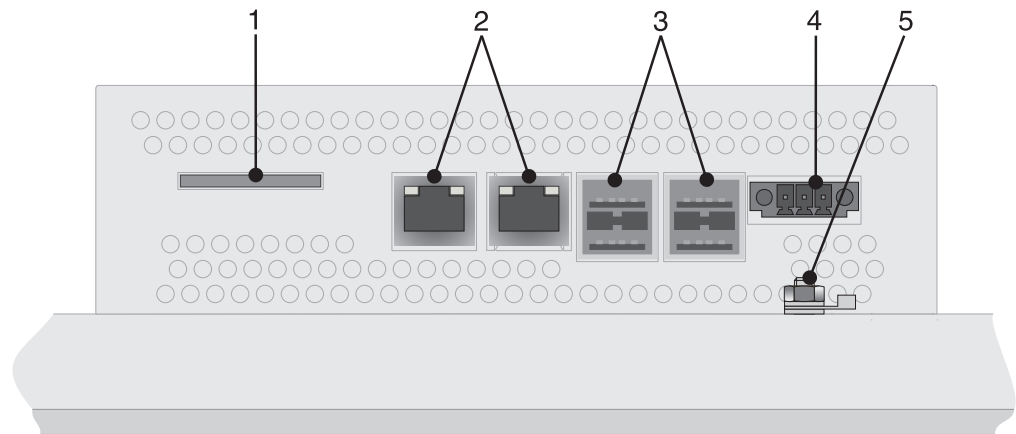

Figure 4-1 Rear view

- 1 Slot for SD / SDHC Memory Card
- 2 Ethernet X7, X6 (10/100/1000 MBit)
- 3 Female Connector X2 - X5 (USB Host - Type A)
- 4 Supply Voltage
- 5 Threaded Bolt For Protective Grounding

4.1 Ethernet

10/100/1000 Base-T Ethernet interfaces are available at the operating device.

4.1.1 Pin Assignment

Connector in the operating device: RJ45 female connector.

Table 4-1 Pin assignment of the Ethernet interface

Pin	Designation	Function
1	D1+	Data Line 1, Positive Polarity
2	D1-	Data Line 1, Negative Polarity
3	D2+	Data Line 2, Positive Polarity
4	D3+	Data Line 3, Positive Polarity
5	D3-	Data Line 3, Negative Polarity
6	D2-	Data Line 2, Negative Polarity
7	D4+	Data Line 4, Positive Polarity
8	D4-	Data Line 4, Negative Polarity

4.1.2 Cable

**ACHTUNG**

Use a twisted pair cable of category 5 or 6 (CAT 5 or 6). Use twisted pair cable of category 6 for optimal transfer rate at 1000 Base-T. The maximum cable length is 100 m (328.084 feet).



See the IEEE 802.3 standard for further information.

4.1.3 Diagnosis

Ethernet diagnostics LEDs are located at the ethernet interface of the operating device.

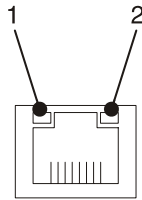

Figure 4-2 Arrangement of the Ethernet diagnostics LEDs

Table 4-2 Function of Ethernet diagnostics LEDs

No.	Color	State	Function
1	Yellow	Flashing	Sending / Receiving activity 100/1000 MBit
	Green	Flashing	Sending / Receiving activity 10 MBit
2	Yellow	On	1000 MBit
	Green	On	100 MBit
	-	Off	10 MBit

4.2 USB

USB interfaces are available at the operating device to connect periphery equipment (for example: Mass memory, printer, scanner, mouse, keyboard etc.).



NOTICE

Using hardware not suitable for industrial use (e.g. keyboard, mouse, memory card) may decrease safety of operation. This includes hardware intended for home and office use.

4.2.1 Cable



For the specification of a suitable cable, please refer to the „Universal Serial Bus Specification Rev. 2.0“.



NOTICE

Use industrial-suited USB cables with a length of maximally 2.5 m (8.202 feet).

4.3 Serial Interfaces

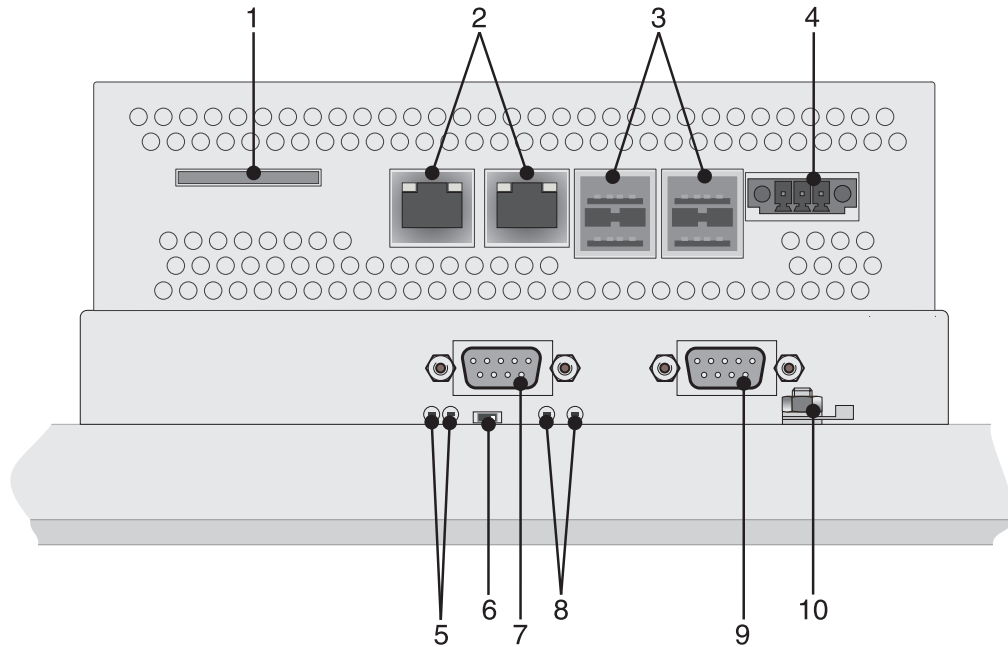

Figure 4-3 Rear view RS-422 / RS-485, RS-232

- 1 Slot for SD / SDHC Memory Card
- 2 Ethernet X7, X6 (10/100/1000 MBit)
- 3 Female Connector X2 - X5 (USB Host - Type A)
- 4 Supply Voltage
- 5 Diagnostics LEDs (RS-422/RS-485)
- 6 Termination Switch (RS-422/RS-485)
- 7 Male Connector X14 (RS-422/RS-485)
- 8 Diagnostics LEDs (RS-232)
- 9 Male Connector X15 (RS-232)
- 10 Threaded Bolt For Protective Grounding

4.3.1 RS-422 / RS-485 (X14)

The interface standard RS-422 / RS-485 is suitable for point-to-point and multi-point connections.

The wires belonging together are marked with „A“ and „B“. Some descriptions refer to the pins with „-“ and „+“, where A = - and B = +.

Signal Logic 1 $U_A - U_B \leq -0.3 \text{ V}$ i.e. ($U_A < U_B$)

Signal Logic 0 $U_A - U_B \geq +0.3 \text{ V}$ i.e. ($U_A > U_B$)

The interface is assigned to the port COM4. At an image version before 181 and operating system Windows CE 6.0 the port COM1 is assigned.

4.3.1.1 Pin Assignment

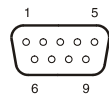

Figure 4-4 9 pin D-SUB male connector strip

Connector in the operating device: 9 pin D-SUB male connector strip.

Table 4-3 Pin assignment RS-422/RS-485

Pin	Designation	Function		
1	SGND	Signal Ground		
2	T(B)	Transmitted Data	+	P
3	T(A)	Transmitted Data	-	N
4	R(A)	Received Data	-	N
5	R(B)	Received Data	+	P
6	nc	Not Connected		
7	nc	Not Connected		
8	nc	Not Connected		
9	nc	Not Connected		



NOTICE

The D-SUB connector strips must be shielded sufficiently. See chapter "Shielding D-SUB Connectors" on page 4-57.

4.3.1.2 Termination

Always turn on the termination in a 4-wire point-to-point connection (RS-422 / RS-485). A sender termination for the quiescent level of the receiver must exist on the remote station.

Turn on the termination only at the two ends of the lines in a 2 or 4-wire multi-point connection (RS-422 / RS-485).

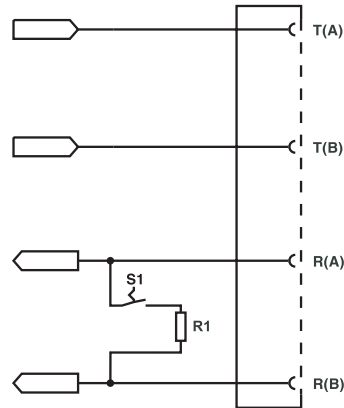

Figure 4-5 Termination possibilities RS-422 / RS-485 (intern)

Table 4-4 Resistance values termination RS-422 / RS-485

Designation	Value
R1	120 Ohm



The switch positions for ON or OFF are printed onto the operating device. Only the specified switch positions are allowed.

Table 4-5 Termination switch RS-422 / RS-485

Switch position	Function
ON	Receiver termination (120 Ohm)
OFF	No receiver termination

4.3.1.3 Transmitter Control

Switching between half-duplex and full-duplex is carried out by the DTR signal.

Full-duplex (DTR inactive / off):

The transmitter is always active and is not turned off on intermissions.
The receiver is always active.

Full-duplex (DTR active / on):

The transmitter is activated during the transmission. On intermissions, the transmitter is highly resistive.

The receiver is disabled during the transmission. The operating device does not receive the own transmit data at the receiver.

4.3.1.4 Diagnosis

Diagnostics LEDs are located on the rear of the operating device.

The diagnostic LEDs at the operating device have the following functions:

Table 4-6 Functions of the RS-422 / RS-485 diagnostics LEDs

Designation	Color	State	Function
Rx	Green	Flashes	Data transfer active
Tx	Yellow	Flashes	Data transfer active

4.3.2 RS232 (X15)

The serial RS-232 interface is suitable to establish a point-to-point connection. The interface is assigned to the port COM3. At an image version before 181 and operating system Windows CE 6.0 the port COM0 is assigned.

4.3.2.1 Pin Assignment

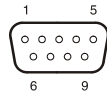

Figure 4-6 9 pin D-SUB male connector strip

Connector in the operating device: 9 pin D-SUB male connector strip.

Table 4-7 Pin assignment RS-232

Pin	Designation	Function
1	nc	Not Connected
2	RD	Received Data
3	TD	Transmitted Data
4	nc	Not Connected
5	GND	Ground
6	nc	Not Connected
7	RTS	Request to Send
8	CTS	Clear to Send
9	nc	Not Connected



NOTICE

The D-SUB connector strips must be shielded sufficiently. See chapter “Shielding D-SUB Connectors” on page 4-57.

4.3.2.2 Diagnosis

Diagnostics LEDs are located on the rear of the operating device.

The diagnostic LEDs at the operating device have the following functions:

Table 4-8 Functions of the RS-232 diagnostics LEDs

Designation	Color	State	Function
RD	Green	Flashes	Data transfer active
TD	Yellow	Flashes	Data transfer active

4.4 Field Bus Interfaces

4.4.1 CAN (X12, X13)

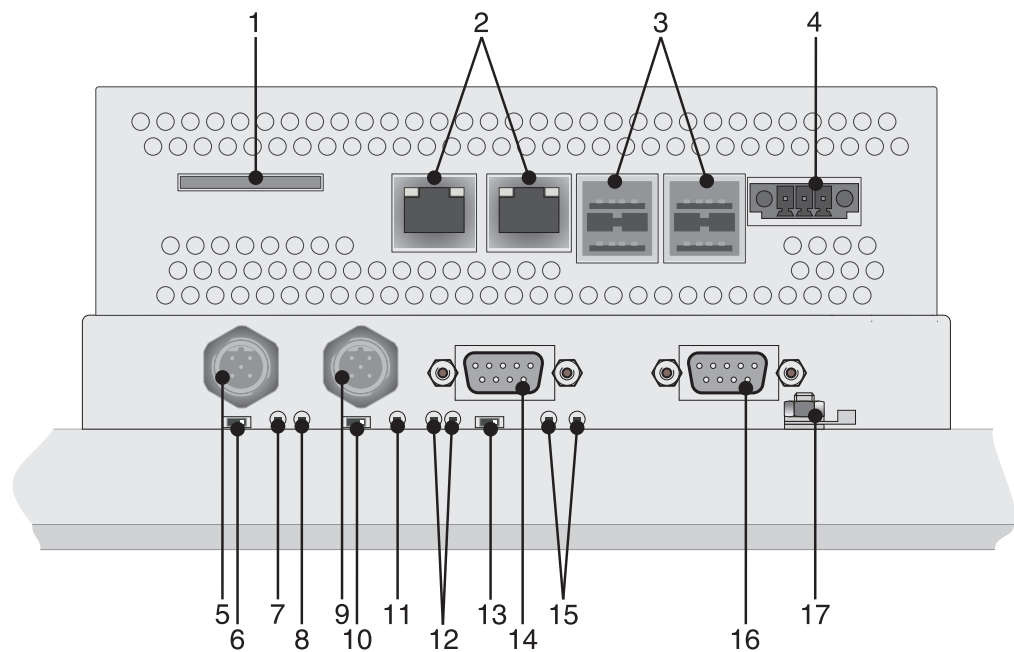

Figure 4-7 Rear view CAN

- 1 Slot for SD / SDHC Memory Card
- 2 Ethernet X7, X6 (10/100/1000 MBit)
- 3 Female Connector X2 - X5 (USB Host - Type A)
- 4 Supply Voltage
- 5 Male Connector X12 (CAN1)
- 6 Termination Switch (CAN1)
- 7 Diagnostics LEDs (CAN1)
- 8 Diagnostics LEDs (Microcontroller)
- 9 Male Connector X13 (CAN2)
- 10 Termination Switch (CAN2)
- 11 Diagnostics LEDs (CAN2)
- 12 Diagnostics LEDs (RS-422/RS-485)
- 13 Termination Switch (RS-422/RS-485)
- 14 Male Connector X14 (RS-422/RS-485)
- 15 Diagnostics LEDs (RS-232)
- 16 Male Connector X15 (RS-232)
- 17 Threaded Bolt For Protective Grounding

4.4.1.1 Pin Assignment



Figure 4-8 5 pin M12 male connector

Connector in the operating device: 5 pin M12 male connector.

Table 4-9 Pin assignment CAN 1

Pin	Designation	Function
1	PE	Shielding
2	Reserved	Reserved for DeviceNet
3	CAN1_GND	CAN Ground
4	CAN1_H	CAN_H Bus Line
5	CAN1_L	CAN_L Bus Line

Table 4-10 Pin assignment CAN 2

Pin	Designation	Function
1	PE	Shielding
2	Reserved	Reserved for DeviceNet
3	CAN2_GND	CAN Ground
4	CAN2_H	CAN_H Bus Line
5	CAN2_L	CAN_L Bus Line



NOTICE
The M12 connectors must be connected to the cable shield.

4.4.1.2 Cable



NOTICE
A shielded twisted-pair cable complying with ISO 11898-2 must be used.



A suitable cable with the designation „SAC-5P- 2,0-920/FS SCO“ is offered by Phoenix Contact GmbH with article number 1518216.

The maximum cable length depends on the data transfer rate used.

Table 4-11 Bit rate CAN

Bit rate	Cable length
125 kBit/s	500 m
500 kBit/s	100 m
1 MBit/s	40 m

4.4.1.3 Termination

Terminate the CAN bus at both ends by terminating resistors (120 Ohm).



The switch positions for ON or OFF are printed onto the operating device. Only the specified switch positions are allowed.

Table 4-12 Termination switch CAN

Switch position	Function
ON	Termination (120 Ohm)
OFF	No termination

4.4.1.4 Diagnosis

Diagnostics LEDs are located on the rear of the operating device. The LEDs show the states of the bus system.

The diagnostics LEDs at the operating device have the following functions:

Table 4-13 Functions of the CAN diagnostics LEDs

Designation	Color	State	Function
CAN1	Green	On	Node is operational
	Green	Flashes	Node is not operational
CAN2	Green	Ein	Node is operational
	Green	Flashes	Node is not operational
μC	Green	Off	Microcontroller inactive
	Green	Flashes slowly	Microcontroller is operational
	Green	Flashes slowly and fast	Microcontroller is operational Requests of the host CPU are received and processed

4.5 Memory Card

At the underside of the operating device you can plug in an SD card.



NOTICE

Using hardware not suitable for industrial use (e.g. keyboard, mouse, memory card) may decrease safety of operation. This includes hardware intended for home and office use.

4.5.1 Inserting the memory card

If you insert the memory card, the back side (side with contacts) of the memory card must be visible. Insert the memory card until it clicks.

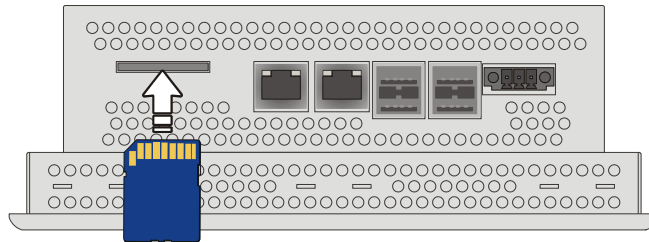

Figure 4-9 Inserting the memory card

4.5.2 Ejecting the memory card

To remove, push the memory card into the operating device until it clicks. The memory card bounces when released automatically out of the operating device. Now you can remove the memory card.

4.6 Shielding D-SUB Connectors

You must shield D-SUB connectors as follows:

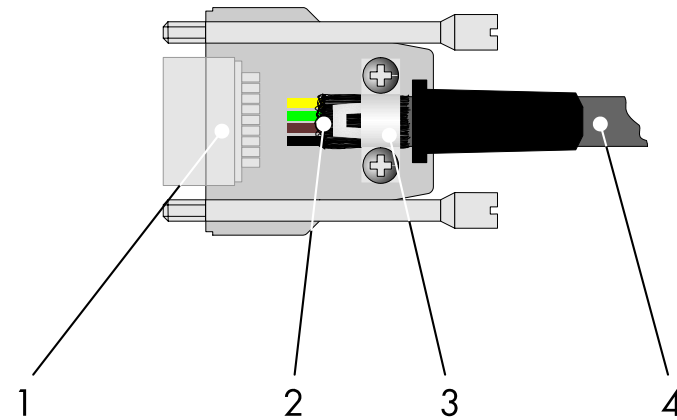

Figure 4-10 Shielding D-SUB connectors

- 1 D-SUB connector
- 2 Shield
- 3 Cable clip
- 4 Cable

The shield must be folded back into a flat position over the cable sheath.

When fastening the cable with the cable clip, as much of the shielding as possible must be in contact with the housing and sufficient strain relieve must be ensured.

5 Maintenance and Servicing

5.1 Maintenance Interval

The following maintenance intervals are recommended for this operating device:

Table 5-1 Maintenance interval

Maintenance work	Interval
Changing the Battery	4 Years

5.2 Front Panel

Only use a damp cloth to remove any dirt from the front panel.

5.3 Fuse

**NOTICE: Damage**

The semiconductor fuse cannot be replaced!

A semiconductor fuse is used to protect the device. Once the fuse has been tripped, the device must be disconnected from the supply voltage to allow the semiconductor fuse to regenerate. At an ambient temperature of 20 °C (68 °F), the regeneration takes approximately 20 seconds. The higher the ambient temperature, the longer the regeneration takes.

5.4 Battery

The minimum battery life is 5 years, even under unfavorable operating conditions.

We recommend you change the battery approximately every 4 years as part of the regular maintenance work.

5.4.1 Changing the Battery

**NOTICE: Damage**

Batteries must only be changed by authorized and trained experts!

**NOTICE: Damage**

Electrostatic discharge can damage electronic components. Observe the ESD protective measures!

**CAUTION: Explosive**

Do not throw lithium batteries into fire, do not heat to 100 °C or higher and do not recharge.

**CAUTION: Toxic**

Do not open lithium batteries.

After a battery change, you must set the date and time newly!

1. Remove the connector of the supply voltage.
2. Remove the screws with the help of a screwdriver (see picture).
3. Remove the enclosure.
4. Disconnect the connector from the battery and remove the dead battery.
5. Plug in the cable of the new battery.
6. Use a provided glue strip to attach the new battery.
7. Place the enclosure cover back onto the device,
8. Carefully tighten the screws of the enclosure cover.



Take care at the assembly of the enclosure cover that all enclosure latches click into the corresponding slits of the underlying enclosure.

9. Put the connector for the supply voltage on again.
10. Set the current date and time.

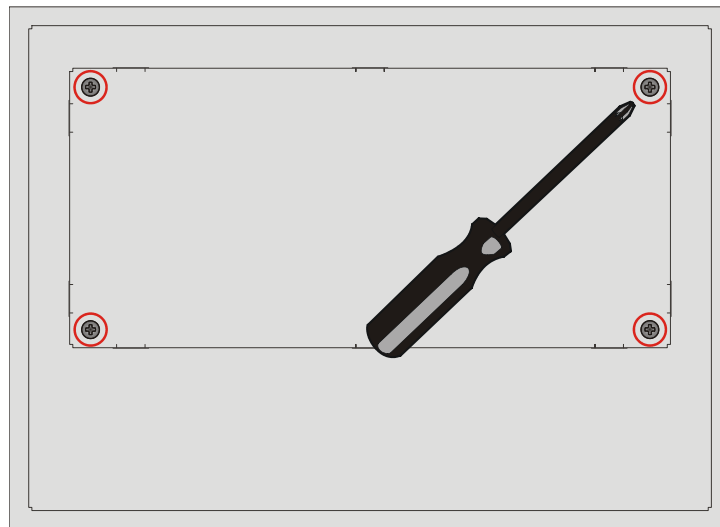
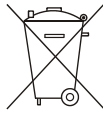

Figure 5-1 Enclosure screws at the operating device

5.4.2 Battery Disposal



The manufacturer is obliged to mark batteries with this symbol before first placing into market. The symbol is extended by the chemical symbols if the following limiting values are exceeded:

More than 0.0005 mass percent mercury	Hg
More than 0.002 mass percent cadmium	Cd
More than 0.004 mass percent lead	Pb

Batteries can be given back free of charge after use at the place of purchase.

According to the §11 of the battery law, final consumers are obliged to give old batteries back to gathering points which attached to the common take back system or manufacturer-specific take back systems.

**NOTICE: Damage**

To prevent short circuitry in the collection boxes, insulate the poles of each battery with insulation tape or put each single battery into a plastic bag.

6 Technical Data

6.1 General

Touch Screen	
Type	Analog resistive, 4 wire technology
Activation force	15 g (Standard) With R8 HS60 silicon rubber
Durability	No damages or malfunctions after 3 million keystrokes as the following: Keystroke element: R8, HS40 silicon rubber Keystroke load: 150 g Keystroke frequency: 3 Hz

Ethernet	
Ethernet	10/100/1000 Mbit/s

USB	
In accordance with the „Universal Serial Bus Specification Rev. 2.0“	
Min.: 1.5 Mbit/s Max.: 12 Mbit/s Max. output current: 100 mA per output	

Connection Method	
Female and male connector strip PHOENIX CONTACT MINI COMBICON, 3 pin	
RJ45 female connector	
USB female connector A	

Environmental Conditions	
Temperature during operation	0 °C to 50 °C (32 °F to 122 °F)
Temperature during storage, transport	- 25 °C to + 70 °C (-13°F to + 158°F)
Relative air humidity for operation and storage	20 % to 85 %, no condensation
Application area	Degree of pollution 2, overvoltage category III No direct solar radiation

Standards and Guidelines	
Interference immunity	EN 61000-4-2 EN 61000-4-3 EN 61000-4-4 EN 61000-4-5 EN 61000-4-6 EN 61000-6-2
Emitted interference	EN 61000-6-4 EN 50011 limit class value A EN 50022 limit class value A
Equipment requirements	EN 61131
Storage and transportation	EN 61131 part 2
Power supply	EN 61131 part 2
Electromagnetic compatibility	2004/108/EG
Degree of protection	EN 60529
Impact load, shocks	EN 60068 part 2-27
Sinusoidal vibrations	EN 60068 part 2-6
Corrosion protection	IEC 60068



NOTICE: Radio Interference

This is a class A device. This device may cause radio interference in residential areas. In this case, the user may be required to introduce appropriate countermeasures, and to bear the cost of same.

Approvals
CE

6.2 TP057ZTV

Central Processing Unit	
Central processing unit	Intel® Atom™
Clock frequency	1.6 GHz

Display	
Size (diagonal) in cm (inch)	14.48 (5.7)
Type	TFT (color)
Resolution (pixels)	640 x 480
Colors	262144
Reading angle (vertical / horizontal)	107° / 130°
Half-life backlighting	40,000 h
Brightness in cd/m ²	400
Display area (H x W) in mm (Inch)	86.4 x 115.2 (3.402 x 4.535)

Memory	
RAM	1 GByte DDR2
Flash	2 GByte / 8 GByte
SD/SDHC interface	2 GByte / 32 GByte maximum

Electrical Data	
Supply voltage	24 V DC (SELV / PELV in accordance with DIN EN 61131)
Residual ripple	10 % maximum
Power consumption (typical at 24 V)	0.5 A
Connected load	12 W
Fuse	Semiconductor fuse, self-resetting
Protection against polarity reversal	Integrated

Front Panel and Enclosure	
Enclosure	Steel sheet, galvanized
Front panel material	Aluminium, brushed, anodized natural finish
Front panel (H x W x D) in mm (Inch)	126 x 168 x 5 (4.961 x 6.614 x 0.197)
Seal	Circumferential rubber seal on the rear
Mounting cutout (H x W) in mm (Inch)	118 x 160 (4.645 x 6.299)
Mounting depth in mm (Inch)	About 54 (2.125)
Degree of protection	Front: IP65 Rear: IP20
Total weight	About 800 g

6.3 TP057GTV

Central Processing Unit	
Central processing unit	AMD embedded G-Series
Clock frequency	1 GHz single / dual-core

Display	
Size (diagonal) in cm (inch)	14.48 (5.7)
Type	TFT (color)
Resolution (pixels)	640 x 480
Colors	262144
Reading angle (vertical / horizontal)	107° / 130°
Half-life backlighting	40,000 h
Brightness in cd/m ²	400
Display area (H x W) in mm (Inch)	86.4 x 115.2 (3.402 x 4.535)

Memory	
RAM	2 GByte DDR2
Flash	8 GByte / 16 GByte / 32 GByte / 64 GByte
SD/SDHC interface	2 GByte / 32 GByte maximum

Electrical Data	
Supply voltage	24 V DC (SELV / PELV in accordance with DIN EN 61131)
Residual ripple	10 % maximum
Power consumption (typical at 24 V)	0.5 A
Connected load	12 W
Fuse	Semiconductor fuse, self-resetting
Protection against polarity reversal	Integrated

Front Panel and Enclosure	
Enclosure	Steel sheet, galvanized
Front panel material	Aluminium, brushed, anodized natural finish
Front panel (H x W x D) in mm (Inch)	126 x 168 x 5 (4.961 x 6.614 x 0.197)
Seal	Circumferential rubber seal on the rear
Mounting cutout (H x W) in mm (Inch)	118 x 160 (4.645 x 6.299)
Mounting depth in mm (Inch)	About 64 (2.519)
Degree of protection	Front: IP65 Rear: IP20
Total weight	About 800 g

6.4 TP070ZTW

Central Processing Unit	
Central processing unit	Intel® Atom™
Clock frequency	1.6 GHz

Display	
Size (diagonal) in cm (inch)	17.78 (7)
Type	TFT (color)
Resolution (pixels)	800 x 480
Colors	262144
Reading angle (vertical / horizontal)	130° / 140°
Half-life backlighting	40,000 h
Brightness in cd/m ²	350
Display area (H x W) in mm (Inch)	91.4 x 152.4 (3.598 x 6.0)

Memory	
RAM	1 GByte DDR2
Flash	2 GByte / 8 GByte
SD/SDHC interface	2 GByte / 32 GByte maximum

Electrical Data	
Supply voltage	24 V DC (SELV / PELV in accordance with DIN EN 61131)
Residual ripple	10 % maximum
Power consumption (typical at 24 V)	0.7 A
Connected load	16.8 W
Fuse	Semiconductor fuse, self-resetting
Protection against polarity reversal	Integrated

Front Panel and Enclosure	
Enclosure	Steel sheet, galvanized
Front panel material	Aluminium, brushed, anodized natural finish
Front panel (H x W x D) in mm (Inch)	147 x 203 x 5 (5.787 x 7.992 x 0.197)
Seal	Circumferential rubber seal on the rear
Mounting cutout (H x W) in mm (Inch)	139 x 195 (5.472 x 7.677)
Mounting depth in mm (Inch) - (standard / field bus)	About 68 / 91 (2.677 / 3.582)
Degree of protection	Front: IP65 Rear: IP20
Total weight	About 1100 g

6.5 TP070GTW

Central Processing Unit	
Central processing unit	AMD embedded G-Series
Clock frequency	1 GHz single / dual-core

Display	
Size (diagonal) in cm (inch)	17.78 (7)
Type	TFT (color)
Resolution (pixels)	800 x 480
Colors	262144
Reading angle (vertical / horizontal)	130° / 140°
Half-life backlighting	40,000 h
Brightness in cd/m ²	350
Display area (H x W) in mm (Inch)	91.4 x 152.4 (3.598 x 6.0)

Memory	
RAM	2 GByte DDR2
Flash	8 GByte / 16 GByte / 32 GByte / 64 GByte
SD/SDHC interface	2 GByte / 32 GByte maximum

Electrical Data	
Supply voltage	24 V DC (SELV / PELV in accordance with DIN EN 61131)
Residual ripple	10 % maximum
Power consumption (typical at 24 V)	0.8 A
Connected load	19.2 W
Fuse	Semiconductor fuse, self-resetting
Protection against polarity reversal	Integrated

Front Panel and Enclosure	
Enclosure	Steel sheet, galvanized
Front panel material	Aluminium, brushed, anodized natural finish
Front panel (H x W x D) in mm (Inch)	147 x 203 x 5 (5.787 x 7.992 x 0.197)
Seal	Circumferential rubber seal on the rear
Mounting cutout (H x W) in mm (Inch)	139 x 195 (5.7472 x 7.677)
Mounting depth in mm (Inch) - (standard / field bus)	About 76 / 99 (2.992 / 3.897)
Degree of protection	Front: IP65 Rear: IP20
Total weight	About 1300 g

6.6 TP090ZTW

Central Processing Unit	
Central processing unit	Intel® Atom™
Clock frequency	1.6 GHz

Display	
Size (diagonal) in cm (inch)	22.86 (9)
Type	TFT (color)
Resolution (pixels)	800 x 480
Colors	16.77 million
Reading angle (vertical / horizontal)	170° / 170°
Half-life backlighting	70.000 h
Brightness in cd/m ²	400
Display area (H x W) in mm (Inch)	118 x 197 (4.645 x 7.755)

Memory	
RAM	1 GByte DDR2
Flash	2 GByte / 8 GByte
SD/SDHC interface	2 GByte / 32 GByte maximum

Electrical Data	
Supply voltage	24 V DC (SELV / PELV in accordance with DIN EN 61131)
Residual ripple	10 % maximum
Power consumption (typical at 24 V)	0.9 A
Connected load	21.6 W
Fuse	Semiconductor fuse, self-resetting
Protection against polarity reversal	Integrated

Front Panel and Enclosure	
Enclosure	Steel sheet, galvanized
Front panel material	Aluminium, brushed, anodized natural finish
Front panel (H x W x D) in mm (Inch)	172 x 260 x 5 (6.772 x 10.236 x 0.197)
Seal	Circumferential rubber seal on the rear
Mounting cutout (H x W) in mm (Inch)	164 x 252 (6.456 x 9.921)
Mounting depth in mm (Inch) - (standard / field bus)	About 68 / 91 (2.677 / 3.582)
Degree of protection	Front: IP65 Rear: IP20
Total weight	About 1400 g

6.7 TP090GTW

Central Processing Unit	
Central processing unit	AMD embedded G-Series
Clock frequency	1 GHz single / dual-core

Display	
Size (diagonal) in cm (inch)	22.86 (9)
Type	TFT (color)
Resolution (pixels)	800 x 480
Colors	16.77 million
Reading angle (vertical / horizontal)	170° / 170°
Half-life backlighting	70.000 h
Brightness in cd/m ²	400
Display area (H x W) in mm (Inch)	118 x 197 (4.645 x 7.755)

Memory	
RAM	2 GByte DDR2
Flash	8 GByte / 16 GByte / 32 GByte / 64 GByte
SD/SDHC interface	2 GByte / 32 GByte maximum

Electrical Data	
Supply voltage	24 V DC (SELV / PELV in accordance with DIN EN 61131)
Residual ripple	10 % maximum
Power consumption (typical at 24 V)	1.2 A
Connected load	28.8 W
Fuse	Semiconductor fuse, self-resetting
Protection against polarity reversal	Integrated

Front Panel and Enclosure	
Enclosure	Steel sheet, galvanized
Front panel material	Aluminium, brushed, anodized natural finish
Front panel (H x W x D) in mm (Inch)	172 x 260 x 5 (6.772 x 10.236 x 0.197)
Seal	Circumferential rubber seal on the rear
Mounting cutout (H x W) in mm (Inch)	164 x 252 (6.456 x 9.921)
Mounting depth in mm (Inch) - (standard / field bus)	About 76 / 99 (2.992 / 3.897)
Degree of protection	Front: IP65 Rear: IP20
Total weight	About 1600 g

6.8 TP105ZTS

Central Processing Unit	
Central processing unit	Intel® Atom™
Clock frequency	1.6 GHz

Display	
Size (diagonal) in cm (inch)	26.42 (10.4)
Type	TFT (color)
Resolution (pixels)	800 x 600
Colors	262144
Reading angle (vertical / horizontal)	110° / 140°
Half-life backlighting	50,000 h
Brightness in cd/m ²	340
Display area (H x W) in mm (Inch)	158 x 211 (6.22 x 8.307)

Memory	
RAM	1 GByte DDR2
Flash	2 GByte / 8 GByte
SD/SDHC interface	2 GByte / 32 GByte maximum

Electrical Data	
Supply voltage	24 V DC (SELV / PELV in accordance with DIN EN 61131)
Residual ripple	10 % maximum
Power consumption (typical at 24 V)	0.8 A
Connected load	19.2 W
Fuse	Semiconductor fuse, self-resetting
Protection against polarity reversal	Integrated

Front Panel and Enclosure	
Enclosure	Steel sheet, galvanized
Front panel material	Aluminium, brushed, anodized natural finish
Front panel (H x W x D) in mm (Inch)	220 x 295 x 5 (8.661 x 11.614 x 0.196)
Seal	Circumferential rubber seal on the rear
Mounting cutout (H x W) in mm (Inch)	212 x 287 (8.346 x 11.299)
Mounting depth in mm (Inch) - (standard / field bus)	About 80 / 103 (3.149 / 4.055)
Degree of protection	Front: IP65 Rear: IP20
Total weight	About 2400 g

6.9 TP105GTS

Central Processing Unit	
Central processing unit	AMD embedded G-Series
Clock frequency	1 GHz single / dual-core

Display	
Size (diagonal) in cm (inch)	26.42 (10.4)
Type	TFT (color)
Resolution (pixels)	800 x 600
Colors	262144
Reading angle (vertical / horizontal)	110° / 140°
Half-life backlighting	50,000 h
Brightness in cd/m ²	340
Display area (H x W) in mm (Inch)	158 x 211 (6.22 x 8.307)

Memory	
RAM	2 GByte DDR2
Flash	8 GByte / 16 GByte / 32 GByte / 64 GByte
SD/SDHC interface	2 GByte / 32 GByte maximum

Electrical Data	
Supply voltage	24 V DC (SELV / PELV in accordance with DIN EN 61131)
Residual ripple	10 % maximum
Power consumption (typical at 24 V)	0.9 A
Connected load	21.6 W
Fuse	Semiconductor fuse, self-resetting
Protection against polarity reversal	Integrated

Front Panel and Enclosure	
Enclosure	Steel sheet, galvanized
Front panel material	Aluminium, brushed, anodized natural finish
Front panel (H x W x D) in mm (Inch)	220 x 295 x 5 (8.661 x 11.614 x 0.196)
Seal	Circumferential rubber seal on the rear
Mounting cutout (H x W) in mm (Inch)	212 x 287 (8.346 x 11.299)
Mounting depth in mm (Inch) - (standard / field bus)	About 87 / 110 (3.425 / 4.33)
Degree of protection	Front: IP65 Rear: IP20
Total weight	About 2400 g

6.10 TP121ZTS

Central Processing Unit	
Central processing unit	Intel® Atom™
Clock frequency	1.6 GHz

Display	
Size (diagonal) in cm (inch)	30.73 (12.1)
Type	TFT (color)
Resolution (pixels)	800 x 600
Colors	262144
Reading angle (vertical / horizontal)	140° / 160°
Half-life backlighting	50,000 h
Brightness in cd/m ²	350
Display area (H x W) in mm (Inch)	184.5 x 246 (7.263 x 9.685)

Memory	
RAM	1 GByte DDR2
Flash	2 GByte / 8 GByte
SD/SDHC interface	2 GByte / 32 GByte maximum

Electrical Data	
Supply voltage	24 V DC (SELV / PELV in accordance with DIN EN 61131)
Residual ripple	10 % maximum
Power consumption (typical at 24 V)	0.8 A
Connected load	19.2 W
Fuse	Semiconductor fuse, self-resetting
Protection against polarity reversal	Integrated

Front Panel and Enclosure	
Enclosure	Steel sheet, galvanized
Front panel material	Aluminium, brushed, anodized natural finish
Front panel (H x W x D) in mm (Inch)	270 x 340 x 5 (10.63 x 13.386 x 0.197)
Seal	Circumferential rubber seal on the rear
Mounting cutout (H x W) in mm (Inch)	243,5 x 315 (9.587 x 12.402)
Mounting depth in mm (Inch) - (standard / field bus)	About 68 / 91 (2.677 / 3.582)
Degree of protection	Front: IP65 Rear: IP20
Total weight	About 2400 g

6.11 TP121GTS

Central Processing Unit	
Central processing unit	AMD embedded G-Series
Clock frequency	1 GHz single / dual-core

Display	
Size (diagonal) in cm (inch)	30.73 (12.1)
Type	TFT (color)
Resolution (pixels)	800 x 600
Colors	262144
Reading angle (vertical / horizontal)	140° / 160°
Half-life backlighting	50,000 h
Brightness in cd/m ²	350
Display area (H x W) in mm (Inch)	184.5 x 246 (7.263 x 9.685)

Memory	
RAM	2 GByte DDR2
Flash	8 GByte / 16 GByte / 32 GByte / 64 GByte
SD/SDHC interface	2 GByte / 32 GByte maximum

Electrical Data	
Supply voltage	24 V DC (SELV / PELV in accordance with DIN EN 61131)
Residual ripple	10 % maximum
Power consumption (typical at 24 V)	1.2 A
Connected load	28.8 W
Fuse	Semiconductor fuse, self-resetting
Protection against polarity reversal	Integrated

Front Panel and Enclosure	
Enclosure	Steel sheet, galvanized
Front panel material	Aluminium, brushed, anodized natural finish
Front panel (H x W x D) in mm (Inch)	270 x 340 x 5 (10.63 x 13.386 x 0.197)
Seal	Circumferential rubber seal on the rear
Mounting cutout (H x W) in mm (Inch)	243,5 x 315 (9.587 x 12.402)
Mounting depth in mm (Inch) - (standard / field bus)	About 76 / 99 (2.992 / 3.897)
Degree of protection	Front: IP65 Rear: IP20
Total weight	About 2400 g

6.12 TP121ZTM

Central Processing Unit	
Central processing unit	Intel® Atom™
Clock frequency	1.6 GHz

Display	
Size (diagonal) in cm (inch)	30.73 (12.1)
Type	TFT (color)
Resolution (pixels)	1280 x 800
Colors	262144
Reading angle (vertical / horizontal)	176° / 176°
Half-life backlighting	50,000 h
Brightness in cd/m ²	320
Display area (H x W) in mm (Inch)	163.2 x 261.12 (6.425 x 10.28)

Memory	
RAM	1 GByte DDR2
Flash	2 GByte / 8 GByte
SD/SDHC interface	2 GByte / 32 GByte maximum

Electrical Data	
Supply voltage	24 V DC (SELV / PELV in accordance with DIN EN 61131)
Residual ripple	10 % maximum
Power consumption (typical at 24 V)	0.9 A
Connected load	21.6 W
Fuse	Semiconductor fuse, self-resetting
Protection against polarity reversal	Integrated

Front Panel and Enclosure	
Enclosure	Steel sheet, galvanized
Front panel material	Aluminium, brushed, anodized natural finish
Front panel (H x W x D) in mm (Inch)	225 x 330 x 5 (8.858 x 12.992 x 0.197)
Seal	Circumferential rubber seal on the rear
Mounting cutout (H x W) in mm (Inch)	217 x 322 (8.543 x 12.677)
Mounting depth in mm (Inch) - (standard / field bus)	About 68 / 91 (2.677 / 3.582)
Degree of protection	Front: IP65 Rear: IP20
Total weight	About 2100 g

6.13 TP121GTM

Central Processing Unit	
Central processing unit	AMD embedded G-Series
Clock frequency	1 GHz single / dual-core

Display	
Size (diagonal) in cm (inch)	30.73 (12.1)
Type	TFT (color)
Resolution (pixels)	1280 x 800
Colors	262144
Reading angle (vertical / horizontal)	176° / 176°
Half-life backlighting	50,000 h
Brightness in cd/m ²	320
Display area (H x W) in mm (Inch)	163.2 x 261.12 (6.425 x 10.28)

Memory	
RAM	2 GByte DDR2
Flash	8 GByte / 16 GByte / 32 GByte / 64 GByte
SD/SDHC interface	2 GByte / 32 GByte maximum

Electrical Data	
Supply voltage	24 V DC (SELV / PELV in accordance with DIN EN 61131)
Residual ripple	10 % maximum
Power consumption (typical at 24 V)	1.0 A
Connected load	24 W
Fuse	Semiconductor fuse, self-resetting
Protection against polarity reversal	Integrated

Front Panel and Enclosure	
Enclosure	Steel sheet, galvanized
Front panel material	Aluminium, brushed, anodized natural finish
Front panel (H x W x D) in mm (Inch)	225 x 330 x 5 (8.858 x 12.992 x 0.197)
Seal	Circumferential rubber seal on the rear
Mounting cutout (H x W) in mm (Inch)	217 x 322 (8.543 x 12.677)
Mounting depth in mm (Inch) - (standard / field bus)	About 76 / 99 (2.992 / 3.897)
Degree of protection	Front: IP65 Rear: IP20
Total weight	About 2300 g

6.14 TP150ZTX

Central Processing Unit	
Central processing unit	Intel® Atom™
Clock frequency	1.6 GHz

Display	
Size (diagonal) in cm (inch)	38.1 (15)
Type	TFT (color)
Resolution (pixels)	1024 x 768
Colors	262144
Reading angle (vertical / horizontal)	140° / 160°
Half-life backlighting	50,000 h
Brightness in cd/m ²	320
Display area (H x W) in mm (Inch)	228 x 304 (8.976 x 11.969)

Memory	
RAM	1 GByte DDR2
Flash	2 GByte / 8 GByte
SD/SDHC interface	2 GByte / 32 GByte maximum

Electrical Data	
Supply voltage	24 V DC (SELV / PELV in accordance with DIN EN 61131)
Residual ripple	10 % maximum
Power consumption (typical at 24 V)	1.0 A
Connected load	24 W
Fuse	Semiconductor fuse, self-resetting
Protection against polarity reversal	Integrated

Front Panel and Enclosure	
Enclosure	Steel sheet, galvanized
Front panel material	Aluminium, brushed, anodized natural finish
Front panel (H x W x D) in mm (Inch)	329 x 400 x 5 (12.953 x 15.748 x 0.197)
Seal	Circumferential rubber seal on the rear
Mounting cutout (H x W) in mm (Inch)	302 x 373 (11.89 x 14.685)
Mounting depth in mm (Inch) - (standard / field bus)	About 80 / 103 (3.149 / 4.055)
Degree of protection	Front: IP65 Rear: IP20
Total weight	About 3700 g

6.15 TP150GTX

Central Processing Unit	
Central processing unit	AMD embedded G-Series
Clock frequency	1 GHz single / dual-core

Display	
Size (diagonal) in cm (inch)	38.1 (15)
Type	TFT (color)
Resolution (pixels)	1024 x 768
Colors	262144
Reading angle (vertical / horizontal)	140° / 160°
Half-life backlighting	50,000 h
Brightness in cd/m ²	320
Display area (H x W) in mm (Inch)	228 x 304 (8.976 x 11.969)

Memory	
RAM	2 GByte DDR2
Flash	8 GByte / 16 GByte / 32 GByte / 64 GByte
SD/SDHC interface	2 GByte / 32 GByte maximum

Electrical Data	
Supply voltage	24 V DC (SELV / PELV in accordance with DIN EN 61131)
Residual ripple	10 % maximum
Power consumption (typical at 24 V)	1.3 A
Connected load	31.2 W
Fuse	Semiconductor fuse, self-resetting
Protection against polarity reversal	Integrated

Front Panel and Enclosure	
Enclosure	Steel sheet, galvanized
Front panel material	Aluminium, brushed, anodized natural finish
Front panel (H x W x D) in mm (Inch)	329 x 400 x 5 (12.953 x 15.748 x 0.197)
Seal	Circumferential rubber seal on the rear
Mounting cutout (H x W) in mm (Inch)	302 x 373 (11.89 x 14.685)
Mounting depth in mm (Inch) - (standard / field bus)	About 87 / 110 (3.425 / 4.33)
Degree of protection	Front: IP65 Rear: IP20
Total weight	About 3900 g

6.16 TP154ZTM

Central Processing Unit	
Central processing unit	Intel® Atom™
Clock frequency	1.6 GHz

Display	
Size (diagonal) in cm (inch)	39.1 (15.4)
Type	TFT (color)
Resolution (pixels)	1280 x 800
Colors	262144
Reading angle (vertical / horizontal)	140° / 160°
Half-life backlighting	50,000 h
Brightness in cd/m ²	360
Display area (H x W) in mm (Inch)	207 x 331 (8.149 x 13.031)

Memory	
RAM	1 GByte DDR2
Flash	2 GByte / 8 GByte
SD/SDHC interface	2 GByte / 32 GByte maximum

Electrical Data	
Supply voltage	24 V DC (SELV / PELV in accordance with DIN EN 61131)
Residual ripple	10 % maximum
Power consumption (typical at 24 V)	1.0 A
Connected load	24 W
Fuse	Semiconductor fuse, self-resetting
Protection against polarity reversal	Integrated

Front Panel and Enclosure	
Enclosure	Steel sheet, galvanized
Front panel material	Aluminium, brushed, anodized natural finish
Front panel (H x W x D) in mm (Inch)	297 x 420 x 5 (11.692 x 16.535 x 0.197)
Seal	Circumferential rubber seal on the rear
Mounting cutout (H x W) in mm (Inch)	273 x 396 (10.748 x 15.59)
Mounting depth in mm (Inch) - (standard / field bus)	About 80 / 103 (3.149 / 4.055)
Degree of protection	Front: IP65 Rear: IP20
Total weight	About 3700 g

6.17 TP154GTM

Central Processing Unit	
Central processing unit	AMD embedded G-Series
Clock frequency	1 GHz single / dual-core

Display	
Size (diagonal) in cm (inch)	39.1 (15.4)
Type	TFT (color)
Resolution (pixels)	1280 x 800
Colors	262144
Reading angle (vertical / horizontal)	140° / 160°
Half-life backlighting	50,000 h
Brightness in cd/m ²	360
Display area (H x W) in mm (Inch)	207 x 331 (8.149 x 13.031)

Memory	
RAM	2 GByte DDR2
Flash	8 GByte / 16 GByte / 32 GByte / 64 GByte
SD/SDHC interface	2 GByte / 32 GByte maximum

Electrical Data	
Supply voltage	24 V DC (SELV / PELV in accordance with DIN EN 61131)
Residual ripple	10 % maximum
Power consumption (typical at 24 V)	1.4 A
Connected load	33.6 W
Fuse	Semiconductor fuse, self-resetting
Protection against polarity reversal	Integrated

Front Panel and Enclosure	
Enclosure	Steel sheet, galvanized
Front panel material	Aluminium, brushed, anodized natural finish
Front panel (H x W x D) in mm (Inch)	297 x 420 x 5 (11.692 x 16.535 x 0.197)
Seal	Circumferential rubber seal on the rear
Mounting cutout (H x W) in mm (Inch)	273 x 396 (10.748 x 15.59)
Mounting depth in mm (Inch) - (standard / field bus)	About 87 / 110 (3.425 / 4.33)
Degree of protection	Front: IP65 Rear: IP20
Total weight	About 3900 g

7 Ordering Data

Tabelle 7-1 Accessories

Description	Part No.
SD card 512 MB	81152.513
USB 2.0 stick 1 GB	81152.100
USB 2.0 stick 2 GB	81152.200
USB 2.0 stick 8 GB	81152.800
Battery, assembled with cable and connector (Type: CR2450)	66779.100
Protective foil for touch screen 5.7" (Set with 10 protective foils, scraper and instructions)	81251.056
Protective foil for touch screen 7" (Set with 10 protective foils, scraper and instructions)	81251.070
Protective foil for touch screen 9" (Set with 10 protective foils, scraper and instructions)	81251.090
Protective foil for touch screen 10.4" (Set with 10 protective foils, scraper and instructions)	81251.104
Protective foil for touch screen 12.1" (Set with 10 protective foils, scraper and instructions)	81251.121
Protective foil for touch screen 15" (Set with 10 protective foils, scraper and instructions)	81251.150

A Index

A

Accessories	97
Administration	38

B

Battery	59
Battery disposal	61

C

Cable	
CAN	54
Ethernet	46
USB	47
Changing the battery	60
Cockpit	
Structure	37
Connecting	34

D

Date	38
Diagnosis	
CAN	55
RS-232	52
RS-422	51
RS-485	51
Dimensions	
Cutout	18
Front panel	10
Display	39, 43

E

Ethernet	46
----------------	----

F

Functions	37
Fuse	59

I

Identification	41
Intended use	8
Interface	
CAN	53
RS-232	52
RS-422	49
RS-485	49
USB	47

M

Maintenance	59
Maintenance interval	59
Memory card	56
Mounting	9

N

Nameplate	41
Network	38

O

Ordering data	97
---------------------	----

P

Password	39
Pin assignment	
CAN	54
Ethernet	46
RS-232	52
RS-422	49
RS-485	49

R

Rear view	
CAN	53
RS-422 / RS-485, RS-232	48

S

Safety notes	7
Servicing	59
Settings	37
Standards	64
Structure	
Cockpit	37
Supply Voltage	34
Switching on	36

T

Target group	8
Technical data	63
Termination	
CAN	55
RS-485	50
Time	38
Touch screen	43

U

Unpacking	9
-----------------	---

V

Version	41
---------------	----



SÜTRON electronic GmbH

Kurze Straße 29

D-70794 Filderstadt

Phone: 0049 711 / 77098-0

Fax: 0049 711 / 77098-305

E-Mail: doku@suetron.de

Internet: www.suetron.com