

HMI

PPC | 67S-RSL0 | Manual

HB160 | PPC | 67S-RSL0 | en | 22-20

Panel PC - PPC021 ES



YASKAWA Europe GmbH
Hauptstraße 185
65760 Eschborn
Germany
Tel.: +49 6196 569-300
Fax: +49 6196 569-398
Email: info@yaskawa.eu.com
Internet: www.yaskawa.eu.com

Table of contents

1	General	4
1.1	Copyright © YASKAWA Europe GmbH.....	4
1.2	About this manual.....	5
1.3	Safety information.....	6
2	Hardware description	7
2.1	Safety information for users.....	7
2.2	Properties.....	8
2.3	Structure.....	9
2.3.1	Overview.....	9
2.3.2	Interfaces.....	11
2.3.3	Memory management.....	15
2.4	Dimensions.....	16
2.5	General data.....	17
2.6	Use in difficult operating conditions.....	18
2.7	Technical data.....	18
2.7.1	67S-RSL0-JB.....	18
2.7.2	67S-RSL0-JX.....	21
3	Deployment Panel PC	24
3.1	Installation.....	24
3.2	Installation of the CFast card.....	25
3.3	Commissioning.....	26
3.3.1	Firmware update.....	26
3.3.2	Startup-Manager.....	27
3.4	Connection to a PLC system.....	30
3.5	Operating system Windows Embedded Standard 7.....	31
3.5.1	General.....	31
3.5.2	Structure.....	32
4	BIOS setup	37
4.1	Overview.....	37
4.2	Main.....	38
4.3	Advanced.....	39
4.4	Chipset.....	49
4.5	Boot.....	54
4.6	Security.....	55
4.7	Save and Exit.....	57
5	Industrial Security and Installation guidelines	58
5.1	Industrial security in information technology.....	58
5.1.1	Protection of hardware and applications.....	59
5.1.2	Protection of PC-based software.....	60
5.2	Installation guidelines.....	60
5.2.1	Basic rules for the EMC-equitable assembly of installations.....	60
5.2.2	EMC-equitable assembly.....	64
5.2.3	EMC-equitable cabling.....	65
5.2.4	Special precautions providing high noise immunity.....	68
5.2.5	Checklist for the EMC-compliant installation of controllers.....	69
	Appendix	70
A	History of changes.....	72

1 General

1.1 Copyright © YASKAWA Europe GmbH

All Rights Reserved	<p>This document contains proprietary information of Yaskawa and is not to be disclosed or used except in accordance with applicable agreements.</p> <p>This material is protected by copyright laws. It may not be reproduced, distributed, or altered in any fashion by any entity (either internal or external to Yaskawa) except in accordance with applicable agreements, contracts or licensing, without the express written consent of Yaskawa and the business management owner of the material.</p> <p>For permission to reproduce or distribute, please contact: YASKAWA Europe GmbH, European Headquarters, Hauptstraße 185, 65760 Eschborn, Germany</p> <p>Tel.: +49 6196 569 300 Fax.: +49 6196 569 398 Email: info@yaskawa.eu.com Internet: www.yaskawa.eu.com</p>
EC conformity declaration	<p>Hereby, YASKAWA Europe GmbH declares that the products and systems are in compliance with the essential requirements and other relevant provisions. Conformity is indicated by the CE marking affixed to the product.</p>
Conformity Information	<p>For more information regarding CE marking and Declaration of Conformity (DoC), please contact your local representative of YASKAWA Europe GmbH.</p>
Trademarks	<p>VIPA is a registered trademark of YASKAWA Europe GmbH.</p> <p>All Microsoft Windows, Office and Server products mentioned are registered trademarks of Microsoft Inc., USA.</p> <p>All other trademarks, logos and service or product marks specified herein are owned by their respective companies.</p>
General terms of use	<p>Every effort has been made to ensure that the information contained in this document was complete and accurate at the time of publishing. We cannot guarantee that the information is free of errors, and we reserve the right to change the information at any time. There is no obligation to inform the customer about any changes. The customer is requested to actively keep his documents up to date. The customer is always responsible for the deployment of the products with the associated documentation, taking into account the applicable directives and standards.</p> <p>This documentation describes all hardware and software units and functions known today. It is possible that units are described that do not exist at the customer. The exact scope of delivery is described in the respective purchase contract.</p>
Document support	<p>Contact your local representative of YASKAWA Europe GmbH if you have errors or questions regarding the content of this document. You can reach YASKAWA Europe GmbH via the following contact:</p> <p>Email: Documentation.HER@yaskawa.eu.com</p>

Technical support

Contact your local representative of YASKAWA Europe GmbH if you encounter problems or have questions regarding the product. If such a location is not available, you can reach the Yaskawa customer service via the following contact:

YASKAWA Europe GmbH,
European Headquarters, Hauptstraße 185, 65760 Eschborn, Germany
Tel.: +49 6196 569 500 (hotline)
Email: support@yaskawa.eu.com

1.2 About this manual**Objective and contents**

This manual describes the Panel PC 67S-RSL0-....

- It describes the structure, configuration and application.
- The manual is written for users with basic knowledge of automation technology.
- The manual consists of chapters. Each chapter describes a completed topic.
- The following guides are available in the manual:
 - An overall table of contents at the beginning of the manual.
 - References with pages numbers.

Validity of the documentation

Product	Order number	as of version:		
PPC021 ES	67S-RSL0-...	HW: 01	FW: V1.0.0	Windows® Embedded Standard 7

Icons Headings

Important passages in the text are highlighted by following icons and headings:

**DANGER!**

Immediate or likely danger. Personal injury is possible.

**CAUTION!**

Damages to property is likely if these warnings are not heeded.



Supplementary information and useful tips.

1.3 Safety information

Applications conforming with specifications

The system is constructed and produced for:

- communication and process control
- general control and automation tasks
- industrial applications
- operation within the environmental conditions specified in the technical data
- installation into a cubicle



DANGER!

This device is not certified for applications in

- in explosive environments (EX-zone)

Documentation

The manual must be available to all personnel in the

- project design department
- installation department
- commissioning
- operation



CAUTION!

The following conditions must be met before using or commissioning the components described in this manual:

- Hardware modifications to the process control system should only be carried out when the system has been disconnected from power!
- Installation and hardware modifications only by properly trained personnel.
- The national rules and regulations of the respective country must be satisfied (installation, safety, EMC ...)

Disposal

National rules and regulations apply to the disposal of the unit!

2 Hardware description

2.1 Safety information for users

Handling of electrostatic sensitive modules

The modules make use of highly integrated components in MOS-Technology. These components are extremely sensitive to over-voltages that can occur during electrostatic discharges. The following symbol is attached to modules that can be destroyed by electrostatic discharges.



The Symbol is located on the module, the module rack or on packing material and it indicates the presence of electrostatic sensitive equipment. It is possible that electrostatic sensitive equipment is destroyed by energies and voltages that are far less than the human threshold of perception. These voltages can occur where persons do not discharge themselves before handling electrostatic sensitive modules and they can damage components thereby, causing the module to become inoperable or unusable. Modules that have been damaged by electrostatic discharges can fail after a temperature change, mechanical shock or changes in the electrical load. Only the consequent implementation of protection devices and meticulous attention to the applicable rules and regulations for handling the respective equipment can prevent failures of electrostatic sensitive modules.

Shipping of modules

Modules must be shipped in the original packing material.

Measurements and alterations on electrostatic sensitive modules

When you are conducting measurements on electrostatic sensitive modules you should take the following precautions:

- Floating instruments must be discharged before use.
- Instruments must be grounded.

Modifying electrostatic sensitive modules you should only use soldering irons with grounded tips.



CAUTION!

Personnel and instruments should be grounded when working on electrostatic sensitive modules.

2.2 Properties

General

The Panel PC is a combination of industrial PC with state of the art performance features and a touch panel with ideal display capabilities. The Panel PC is a compact and modular embedded PC based on Windows® Embedded Standard 7 - WES7. Besides the extensive WES7 functions the Panel PC offers varied communication possibilities.



- Windows® Embedded Standard 7
- Movicon 11 Win 32 I/O (67S-RSL0-JB)
- 21.5" 16:9 TFT panel 16.7 M color
- PCAP, multitouch
- Display resolution 1920 x 1080
- Processor: Baytrail Intel® Celeron J1900, Quad core 2GHz
- Work memory: 2x 204Pin DDR3 SO-DIMM Socket, 4GB DDR3
- User memory: 16GB SSD SLC
- CFast slot
- 2 RS232/RS422/RS485 (switchable), 3 USB-A-, 2 Ethernet interfaces, VGA port and Audio out, connector for remote Power switch
- Metal case
- Passive cooling
- Easy mounting via integrated pivoted lever
- Protection class IP66 (frontal)

Order data

Type	Order number	Description
PPC021 ES	67S-RSL0-...	21.5" TFT color, 2x RS232/RS422/RS485, 3x USB-A, 2x Ethernet RJ45, VGA, Audio out

2.3 Structure

2.3.1 Overview

Front view



- 1 Slot for voltage supply (DC 12-30V)
- 2 VGA interface
- 3 Reset button
- 4 RS232/RS422/RS485 interface COM 2
- 5 RS232/RS422/RS485 interface COM 1
- 6 USB-A interface USB 3.0
- 7 2x USB-A interface USB 2.0
- 8 RJ45 jack for Ethernet communication LAN 2
- 9 RJ45 jack for Ethernet communication LAN 1
- 10 2 pin connector for remote Power switch
- 11 3.5mm Audio Line out
- 12 Power switch (pushbutton)
- 13 Slot for CFast storage media
- 14 Display with touch sensitive area (touch screen)

Bottom view

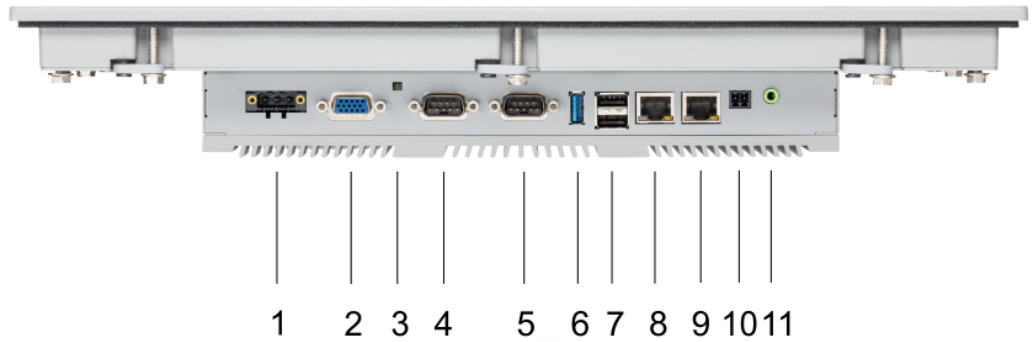

- 1 Slot for voltage supply (DC 12-30V)
- 2 VGA interface
- 3 Reset button
- 4 RS232/RS422/RS485 interface COM 2
- 5 RS232/RS422/RS485 interface COM 1
- 6 USB-A interface USB 3.0
- 7 2x USB-A interface USB 2.0
- 8 RJ45 jack for Ethernet communication LAN 2
- 9 RJ45 jack for Ethernet communication LAN 1
- 10 2 pin connector for remote Power switch
- 11 3.5mm Audio Line out



Please make sure that the Panel PC always has to be supplied with external voltage!

Top view



- 1 Slot for CFAST storage media
- 2 Power switch (pushbutton)



The Panel PC starts automatically when the power supply is switched on. But you can change the configuration in the BIOS setup so that the Panel PC has to be switched off by the power switch. ↪ 'Restore AC Power Loss' page 50

After a Windows® 'Shut down' the Panel PC can be switched on again by means of the power switch at any time.

During operation the Panel PC switches to the sleep mode by briefly pushing the power switch. By pushing the power switch again the sleep mode is switched off.

2.3.2 Interfaces

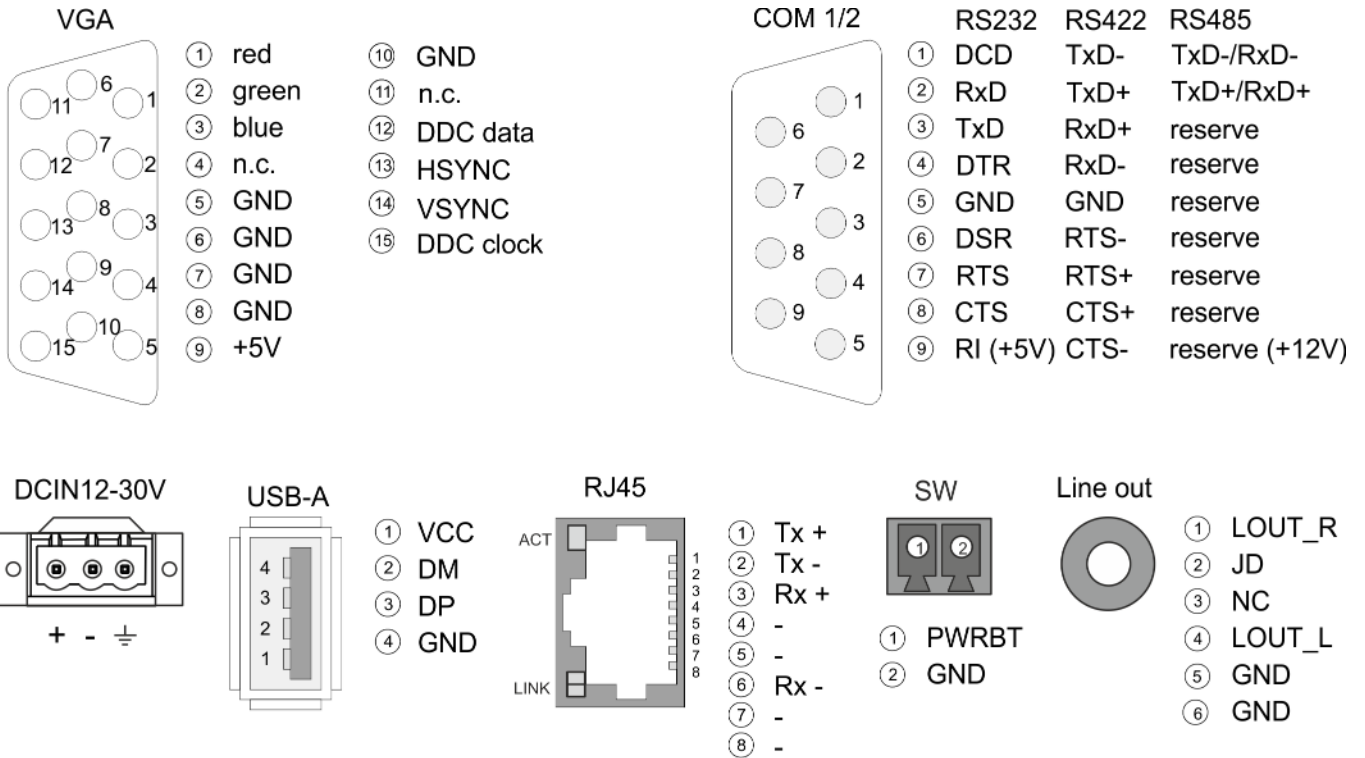

Power supply

The Panel PC has got an integrated power supply. The power supply has to be provided with DC 12... 30V. For this you find an according DC 24V slot at the back. The power supply is protected against inverse polarity and overcurrent. The matching 3-pin plug connector is included in the scope of delivery.

VGA interface

VGA SubD HD15 jack to connect a second display.

RS232/RS422/RS485 interface (switchable)

The 9-pin male SubD connector may be switched with BIOS. Here also the termination resistor of the RS422 and RS485 interface may be activated or deactivated. ↗ *'Submenu "Serial Port 2 Configuration" page 43*

RS232 interface

- Logical conditions as voltage level
- Point-to-point connection with serial full-duplex transfer
- Data transfer up to a distance of 15m
- Data transfer rate up to 115.2kbit/s

RS422 interface

- Logical conditions as voltage difference between 2 twisted lines
- Serial bus connection full-duplex four-wire operation
- Line length: 250m at 115.2kbit/s ... 1200m at 19.2kbit/s
- Data transfer rate up to 115.2kbit/s

RS485 interface

- Logical conditions as voltage difference between 2 twisted lines
- Serial bus connection half-duplex two-wire operation
- Line length: 250m at 115.2kbit/s ... 1200m at 19.2kbit/s
- Data transfer rate up to 115.2kbit/s

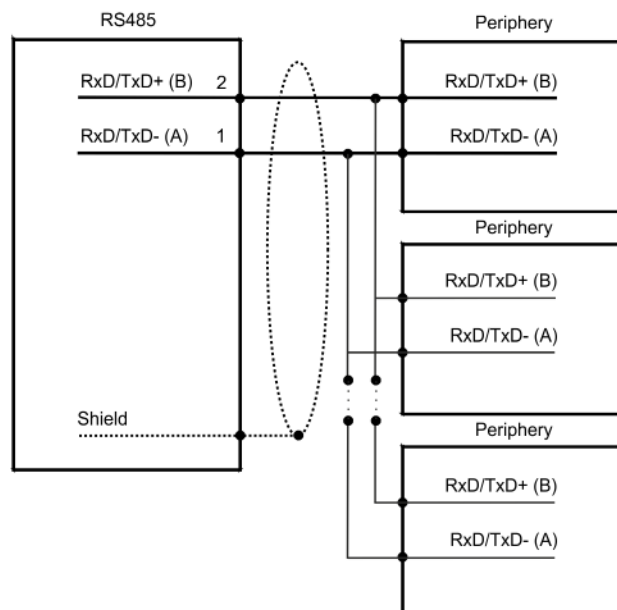
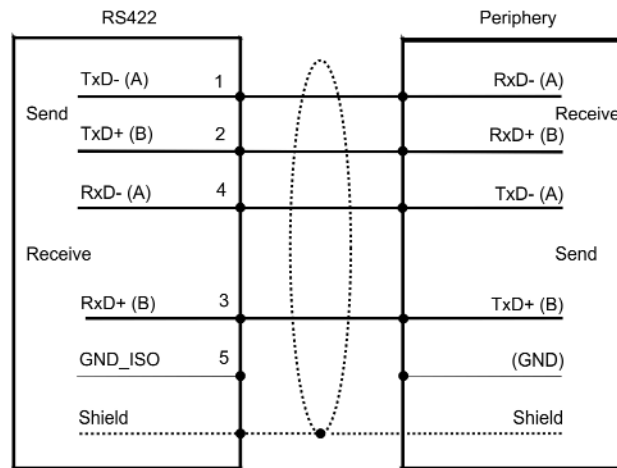
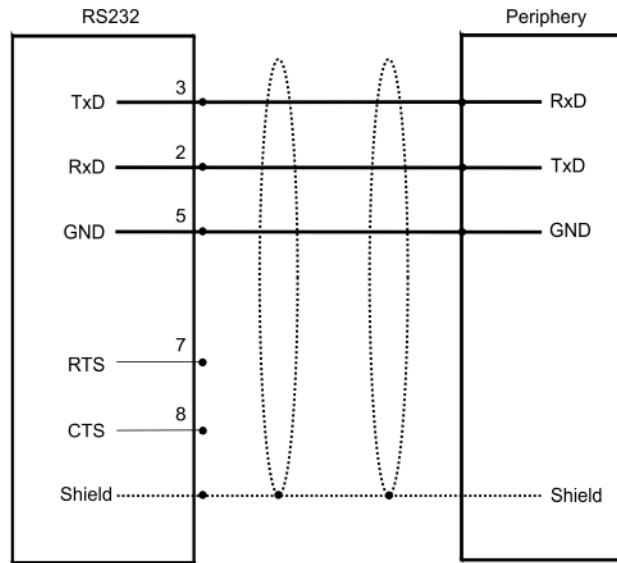









"Host"-USB-A

The Panel PC has a USB 3.0 and two USB 2.0 interfaces. The fast USB 3.0 interface can be recognized by the blue connector. USB 2.0 works half-duplex, the data can only be transmitted in one direction. USB 3.0 works full-duplex, meaning that data can be transferred simultaneously in both directions. Using the "Host"-USB-A interfaces USB mouse, keyboard, stick or USB hard discs can be connected.

Ethernet connection

The two RJ45 jacks provide the interface to the twisted pair cable, required for Ethernet.

LEDs

Activity	Link	Link	Description
 yellow	 green	 orange	
 blinks		<input type="checkbox"/>	1000Mbit/s link
 blinks	<input type="checkbox"/>		100Mbit/s link
 blinks	<input type="checkbox"/>	<input type="checkbox"/>	10Mbit/s link or no link
<input type="checkbox"/>	<input type="checkbox"/>	<input type="checkbox"/>	not active

Remote Power switch connection (SW)

At this connection, you can connect an additional pushbutton as a remote Power switch to switch the PPC on or off from any location. The matching 2-pin plug connector is included in the scope of delivery. [↪ further information page 10](#)

Line out

3.5 mm stereo jack to connect an active speaker system or an earphone.

2.3.3 Memory management

Overview

- 4GB work memory
- 16GB SSD SLC user memory
- USB storage media using "Host"-USB-A interface
- Slot for CFast memory card

Work memory

The Panel PC has a work memory with a size of 4GB. The work memory is not buffered and is deleted after shut down.

User memory

As internal permanent storage medium the Panel PC has a 16GB flash module (4GB user data).

USB storage media

The Panel PC has got three USB-A interfaces (1x USB 3.0 and 2x USB 2.0). The connection of USB sticks and USB drives are supported by the Panel PC.

Slot for CFast

At the back of the Panel PC there is a card slot for a memory card. At this slot you can plug storage modules of the type CFast 2.0 - 600 MB/s (6Gbit/s) - SATA protocol - not hot-swap compatible.

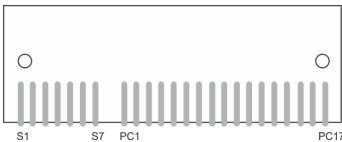

Pin	Assignment	Pin	Assignment
S1	GND	PC6	n.c.
S2	SATA_TX1+	PC7	GND
S3	SATA_TX1-	PC8	CFAST_LED1_C
S4	GND	PC9	CFAST_LED2_C
S5	SATA_RX1+	PC10	n.c.
S6	SATA_RX1-	PC11	n.c.
S7	GND	PC12	n.c.
PC1	CFAST_CDI	PC13	VCC3
PC2	GND	PC14	VCC3
PC3	n.c.	PC15	GND
PC4	n.c.	PC16	GND
PC5	n.c.	PC17	CFAST_CDO



Prior to removing the CFast card, make sure the unit's power is off and disconnected from the power supply.

2.4 Dimensions

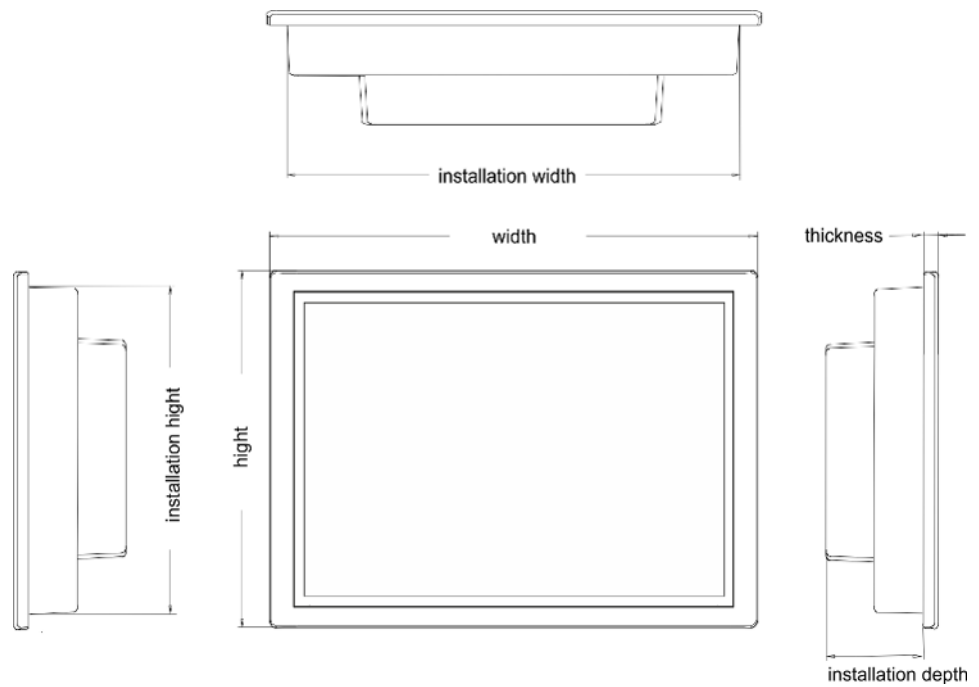

Installation dimensions

For the installation of the Panel PC in control cabinets and desks the following dimensions are necessary:

21.5" - 67S-RSL0-...

Front panel thickness	3 ... 12mm
Installation cutting (W x H)	547 x 367mm
Front panel (W x H x T)	562.40 x 382.40 x 6.70mm
Rear panel (W x H x D)	542 x 362 x 54.20mm
Installation depth	54.20mm



The degrees of protection are only guaranteed when the following is observed:

- *The material thickness of the installation cut-out is 3 ... 12mm*
- *The deviation from the plane for the panel cut-out is $\leq 0.5\text{mm}$*
- *Permissible surface roughness in the area of the seal: $\leq 120\mu\text{m}$ (friction coefficient 120)*

2.5 General data

Conformity and approval

Conformity		
CE	2014/30/EU	EMC directive
Approval		
UL		Refer to Technical Data
others		
RoHS	2011/65/EU	Restriction of the use of certain hazardous substances in electrical and electronic equipment

Protection of persons and device protection

Type of protection	-	IP20
Electrical isolation		
to the field bus	-	electrically isolated
to the process level	-	electrically isolated
Insulation resistance		-
Insulation voltage to reference earth		
Inputs / outputs	-	AC / DC 50V, test voltage AC 500V
Protective measures	-	against short circuit

Environmental conditions to EN 61131-2

Climatic		
Storage / transport	EN 60068-2-14	-20...+75°C
Operation		
Horizontal installation	EN 61131-2	-10...+60°C
Vertical installation	EN 61131-2	-10...+60°C
Air humidity	EN 60068-2-30	RH1 (without condensation, rel. humidity 10...95%)
Pollution	EN 61131-2	Degree of pollution 2
Mechanical		
Oscillation	EN 60068-2-6	1g, 9Hz ... 150Hz
Shock	EN 60068-2-27	15g, 11ms

Mounting conditions

Mounting place	-	In the control cabinet
Mounting position	-	Horizontal and vertical

EMC	Standard	Comment	
Emitted interference	EN 61000-6-4	Class A (Industrial area)	
Noise immunity zone B	EN 61000-6-2	Industrial area	
		EN 61000-4-2	ESD 8kV at air discharge (degree of severity 3), 4kV at contact discharge (degree of severity 2)
		EN 61000-4-3	HF field immunity (casing) 80MHz ... 1000MHz, 10V/m, 80% AM (1kHz) 1.4GHz ... 2.0GHz, 3V/m, 80% AM (1kHz) 2GHz ... 2.7GHz, 1V/m, 80% AM (1kHz)
		EN 61000-4-6	HF conducted 150kHz ... 80MHz, 10V, 80% AM (1kHz)
		EN 61000-4-4	Burst, degree of severity 3
		EN 61000-4-5	Surge, degree of severity 3 ¹

1) Due to the high-energetic single pulses with Surge an appropriate external protective circuit with lightning protection elements like conductors for lightning and overvoltage is necessary.

2.6 Use in difficult operating conditions



Without additional protective measures, the products must not be used in locations with difficult operating conditions; e.g. due to:

- dust generation
- chemically active substances (corrosive vapors or gases)
- strong electric or magnetic fields

2.7 Technical data

2.7.1 67S-RSL0-JB

Order no.	67S-RSL0-JB
Type	Panel PC PPC021 ES
Display	
Display size (diagonal)	21.5 "
Display size (width)	478 mm
Display size (height)	269 mm
Resolution	1080 x 1920 / 1920 x 1080
Aspect ratio	16:9
Type of display	TFT color (16.7M colors)
MTBF Backlights (25°C)	50000 h

Order no.	67S-RSL0-JB
System properties	
Processor	Intel Celeron Quad core 2 GHz
Operating system	Windows embedded Standard 7
User software	-
Work memory	4 GB
User memory	16 GB
Available memory (user data)	4 GB
SD/MMC Slot	-
CF Card Slot Typ II	-
CFast Slot	✓
Time	
Real-time clock buffered	✓
Clock buffered period (min.)	4 y
Type of buffering	lithium battery
Load time for 50% buffering period	-
Load time for 100% buffering period	-
Accuracy (max. deviation per day)	10 s
Operating controls	
Touchscreen	PCAP
Touch function	Multi Touch
Keyboard	external via USB
Mouse	external via USB
Interfaces	
MPI, PROFIBUS-DP	-
MPI, PROFIBUS-DP connector	-
Serial, COM1	RS232 / RS422 / RS485
COM1 connector	Sub-D, 9-pin, male
Serial, COM2	RS232 / RS422 / RS485
COM2 connector	Sub-D, 9-pin, male
Number of USB-A interfaces	3
USB-A connector	USB-A (host)
Number of USB-B interfaces	-
USB-B connector	-
Number of ethernet interfaces	2
Ethernet	Ethernet 10/100/1000 MBit
Ethernet connector	2 x RJ45

Technical data > 67S-RSL0-JB

Order no.	67S-RSL0-JB
Integrated ethernet switch	-
Video connectors	VGA SubD HD15
Audio connections	Line out, stereo jack 3.5 mm
Technical data power supply	
Power supply (rated value)	DC 24 V
Power supply (permitted range)	DC 20.4...28.8 V
Reverse polarity protection	✓
Current consumption (no-load operation)	1.2 A
Current consumption (rated value)	1.3 A
Inrush current	1.3 A
I ² t	0.35 A ² s
Power loss	32 W
Status information, alarms, diagnostics	
Status display	none
Supply voltage display	none
Mechanical data	
Housing / Protection class	
Material	coated aluminium steel plate
Mounting	via integrated pivoted lever
Protection class IP front side	IP 66
Protection class IP back side	IP 20
Protection class NEMA front side	-
Protection class NEMA back side	-
Dimensions	
Front panel	562.4 mm x 382.4 mm x 6.7 mm
Rear panel	542 mm x 362 mm x 54.2 mm
Installation cut-out	
Width	547 mm
Height	367 mm
Minimum	3 mm
Maximum front panel thickness	12 mm
Net weight	9.1 kg
Weight including accessories	-
Gross weight	-
Environmental conditions	
Operating temperature	-10 °C to 60 °C

Order no.	67S-RSL0-JB
Storage temperature	-20 °C to 75 °C
Certifications	
UL certification	yes
KC certification	-

2.7.2 67S-RSL0-JX

Order no.	67S-RSL0-JX
Type	Panel PC PPC021 ES
Display	
Display size (diagonal)	21.5 "
Display size (width)	478 mm
Display size (height)	269 mm
Resolution	1080 x 1920 / 1920 x 1080
Aspect ratio	16:9
Type of display	TFT color (16.7M colors)
MTBF Backlights (25°C)	50000 h
System properties	
Processor	Intel Celeron Quad core 2 GHz
Operating system	Windows embedded Standard 7
User software	-
Work memory	4 GB
User memory	16 GB
Available memory (user data)	4 GB
SD/MMC Slot	-
CF Card Slot Typ II	-
CFast Slot	✓
Time	
Real-time clock buffered	✓
Clock buffered period (min.)	4 y
Type of buffering	lithium battery
Load time for 50% buffering period	-
Load time for 100% buffering period	-
Accuracy (max. deviation per day)	10 s
Operating controls	
Touchscreen	PCAP

Technical data > 67S-RSL0-JX

Order no.	67S-RSL0-JX
Touch function	Multi Touch
Keyboard	external via USB
Mouse	external via USB
Interfaces	
MPI, PROFIBUS-DP	-
MPI, PROFIBUS-DP connector	-
Serial, COM1	RS232 / RS422 / RS485
COM1 connector	Sub-D, 9-pin, male
Serial, COM2	RS232 / RS422 / RS485
COM2 connector	Sub-D, 9-pin, male
Number of USB-A interfaces	3
USB-A connector	USB-A (host)
Number of USB-B interfaces	-
USB-B connector	-
Number of ethernet interfaces	2
Ethernet	Ethernet 10/100/1000 MBit
Ethernet connector	2 x RJ45
Integrated ethernet switch	-
Video connectors	VGA SubD HD15
Audio connections	Line out, stereo jack 3.5 mm
Technical data power supply	
Power supply (rated value)	DC 24 V
Power supply (permitted range)	DC 20.4...28.8 V
Reverse polarity protection	✓
Current consumption (no-load operation)	1.2 A
Current consumption (rated value)	1.3 A
Inrush current	1.3 A
I^2t	0.35 A ² s
Power loss	32 W
Status information, alarms, diagnostics	
Status display	none
Supply voltage display	none
Mechanical data	
Housing / Protection class	
Material	coated aluminium steel plate
Mounting	via integrated pivoted lever

Order no.	67S-RSL0-JX
Protection class IP front side	IP 66
Protection class IP back side	IP 20
Protection class NEMA front side	-
Protection class NEMA back side	-
Dimensions	
Front panel	562.4 mm x 382.4 mm x 6.7 mm
Rear panel	542 mm x 362 mm x 54.2 mm
Installation cut-out	
Width	547 mm
Height	367 mm
Minimum	3 mm
Maximum front panel thickness	12 mm
Net weight	9.1 kg
Weight including accessories	-
Gross weight	-
Environmental conditions	
Operating temperature	-10 °C to 60 °C
Storage temperature	-20 °C to 75 °C
Certifications	
UL certification	yes
KC certification	-

3 Deployment Panel PC

3.1 Installation

Overview

The Panel PC is suitable for the installation in operating tables and control cabinet fronts. The installation happens via the back. The Panel PC is provided with a fixing technique with not losable screws that allows an easy connection with a crosstip screwdriver. A fast and easy device change is possible. It is also possible to install the Panel PC in a VESA holder (VESA 75/100).

Installation cutting

For the installation into a operating tableau and control cabinet fronts, the Panel PC requires the following front panel cutting:

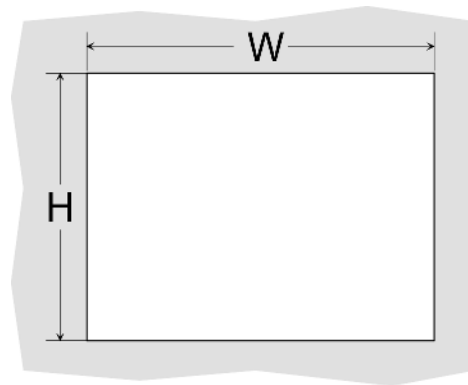

Panel PC	W x H in mm
67S-RSL0-...	547 x 367mm



The material thickness of the installation cut-out is 3 ... 12mm.

Installation

For the installation of the panel pivoted lever are integrated. For the installation, a crosstip screwdriver is required.

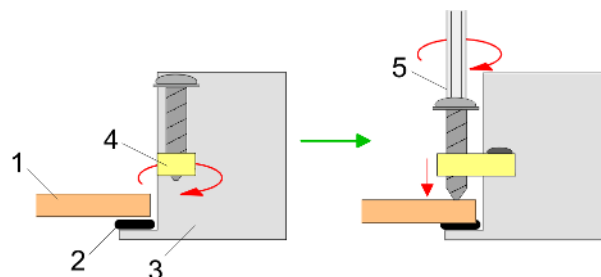

- 1.** ➤ Push the Panel PC [3] from the front side into the front panel cutting [1] until it touches the panel with the seal [2].
- 2.** ➤ Rotate the pivoted lever 90 degrees to the outside [4].
- 3.** ➤ Screw the screws with the crosstip screwdriver [5].

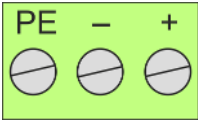
Connect power supply

For the cabling of the power supply DC 12-30V a green plug is used. The connector is a plug with screw contacts. The plug has the following assignment:

- + DC 24V
- DC 0V
- PE Protective earth

3.2 Installation of the CFast card**Installation**

The CFast card slot is located on the rear top side of the Panel PC. It is closed with a cover plate.



1. ➤ Remove the cover plate of the slot by removing the screws and pulling the plate.



2. ➤ With the label facing up, insert the CFast card until it is completely seated in the slot and reinstall the cover plate.

⇒ After installation the CFast card is automatically recognized.

**Demounting**

1. ➤ Remove the screws.
2. ➤ Pull the holding plate from the card slot.
3. ➤ Push the CFast card to remove the card.
4. ➤ Reinstall the cover plate.

**CAUTION!**

Prior to removing the CFast card, make sure the unit's power is off and disconnected from the power supply.

3.3 Commissioning

**CAUTION!**

- Before commissioning the device must be brought to room temperature.
- At condensation the device must be absolutely dry before connected to power.
- To avoid overheat during operation the device must not be laid open to direct sun light.
- After opening the control cabinet or desk, there are parts with possible dangerous voltage available.
- For all signal connections only screened cables are permitted.
- Signal cables must not be let within the same cable shaft as high voltage cables.

3.3.1 Firmware update

Firmware update without Startup Manager

To execute the firmware update an external keyboard and an USB stick (memory size 4GB) is necessary. The new image file for your Panel PC should be on the USB stick. You will find the file and a detailed description of the firmware update on www.yaskawa.eu.com in the Download Center under 67S-RSL0-....

Firmware update with Startup Manager

In the "Startup Manager", run the Firmware update of your Panel PCs via the [Info/Update] button.

3.3.2 Startup-Manager

Start screen

As soon as the Panel PC is provided by power supply, the *Startup-Manager* will be loaded. At the first startup of the *Startup-Manager* the following *start screen* appears.

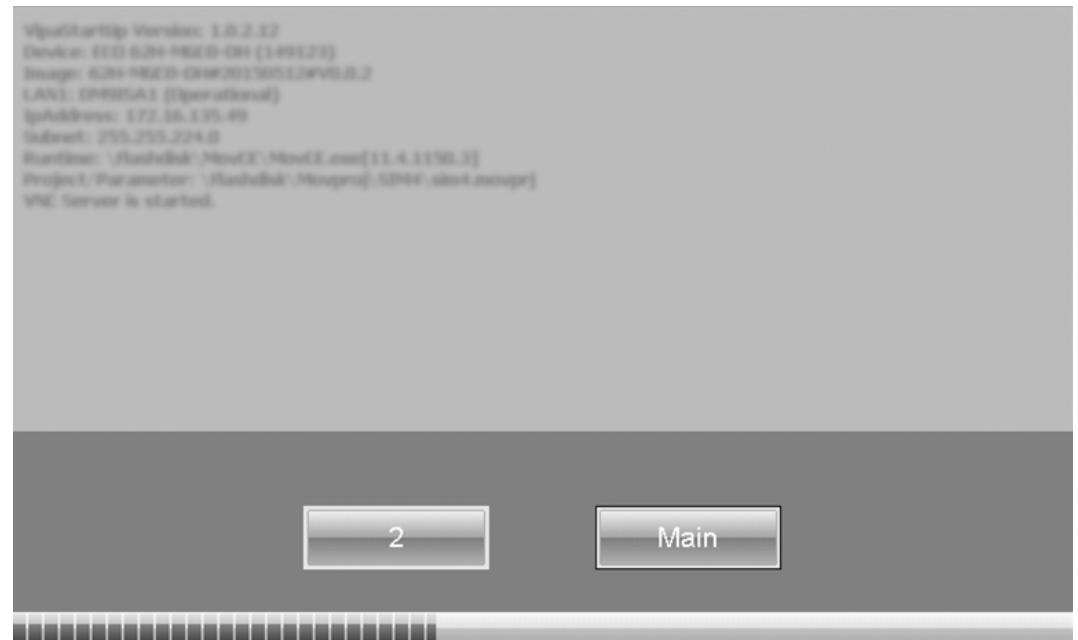

- There is a button on the *initial screen* with a counter, which counts backwards. If you click on this button within this time, the project will start. If the time expires, the project will start automatically. With the button [Main] you get to the *selection menu*.
- A delay time of 5 seconds is default. In the *selection menu* under [Autostart] you can adjust this time.

Selection menu

There are following buttons in the *selection menu*:

- Settings
- Info/Update
- Autostart
- Backup
- Exit
- Back

Settings

- In [Settings] under '*Change Settings*' you can set a password for the Startup-Manager. The password will be requested when interrupting the start countdown. By default, no password is defined. In [Settings] the system settings can be set exactly like via Windows '*Start → Control Panel*'.
- Under *Backlight control* you can adjust the brightness and dimming of the backlight.

Info/Update (firmware)

- To execute the firmware update press the button [Info/Update]. After clicking [Info/Update] the current image is displayed under '*Image Version*' with panel name, creation date and version number. With [Create Screenshot] you can make a screen shot of the panel information and select a destination for its storage.
- To execute the firmware update an external keyboard and an USB stick (memory size 4GB) is necessary. The new image file for your Panel PC should be on the USB stick. You will find the file and a detailed description of the firmware update on www.yaskawa.eu.com under "Service / Support" in the download area.

Autostart

With [Autostart] you define which runtime and which project will be started automatically together with the panel startup.

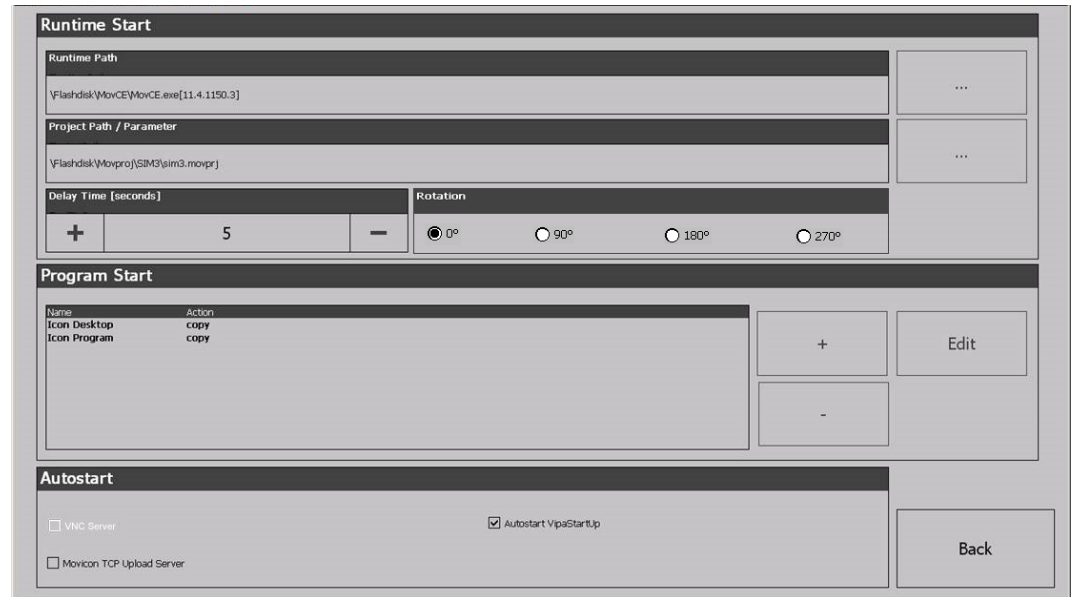

- With [...] at 'Runtime path' res. 'Project path' all existing runtimes res. projects on the panel and the storage media will be listed.
- Under 'Delay Time' you can adjust a delay time > 0 by using the buttons [+] and [-]. 5 seconds are default.
- Via 'Rotation' the orientation of the panel can be changed.
- Via 'Program Start' with [+] you can add programmes, which have to start automatically.

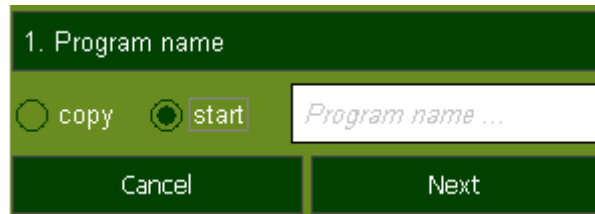

1. Select 'Start' and assign a name for the program.

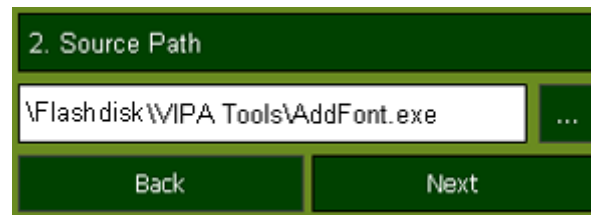

2. Upload your program with [...].

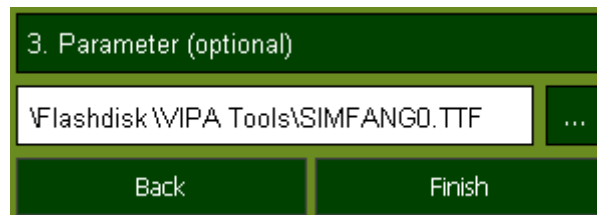

3. You can optionally set parameters.

4. Exit with [Finish].

- With *'Copy'* [...] files can be copied on the panel from a source path to a destination path.
- With *'Autostart'* you can select the automatic startup of the Movicon-TCP upload server, the VNC server und the Startup-Manager. With [Back] you can return to the *select menu*.

Backup

By default, the configuration of the Startup-Manager, the registry settings for the back-light, the local settings and the LAN settings will be saved by [Backup] in *'Flashdisk → Backup'*. The name of the backup file is "backup.bkv". Which settings will be saved and the storage location are defined in the file "ToDoList.xml" under *'Flashdisk → VipaStartup'*. These can be adjusted accordingly.

Exit

The Startup-Manager will be closed by [Exit] and the system returns to the Windows® screen.

Back

With [Back] you get back to the start screen of the Startup-Manager.

3.4 Connection to a PLC system

Overview

- For the inclusion into your PLC system several HMI/SCADA project-engineering platforms are at your disposal that has to be installed at an external PC. Here you may create your project, where appropriate simulate it and transfer it to the Panel PC that you've entered before. Via the at the Panel PC pre-installed runtime version of the HMI/SCADA project engineering platforms your project is run able.
- By using the according communication driver, the Panel PC supports connecting options to the PLC via Ethernet.
- During operation your operating device communicates with the according PLC and reacts to the application courses in the PLC according to the configured processes. Via dialogues configured before, process values may be monitored graphically, altered and evaluated.

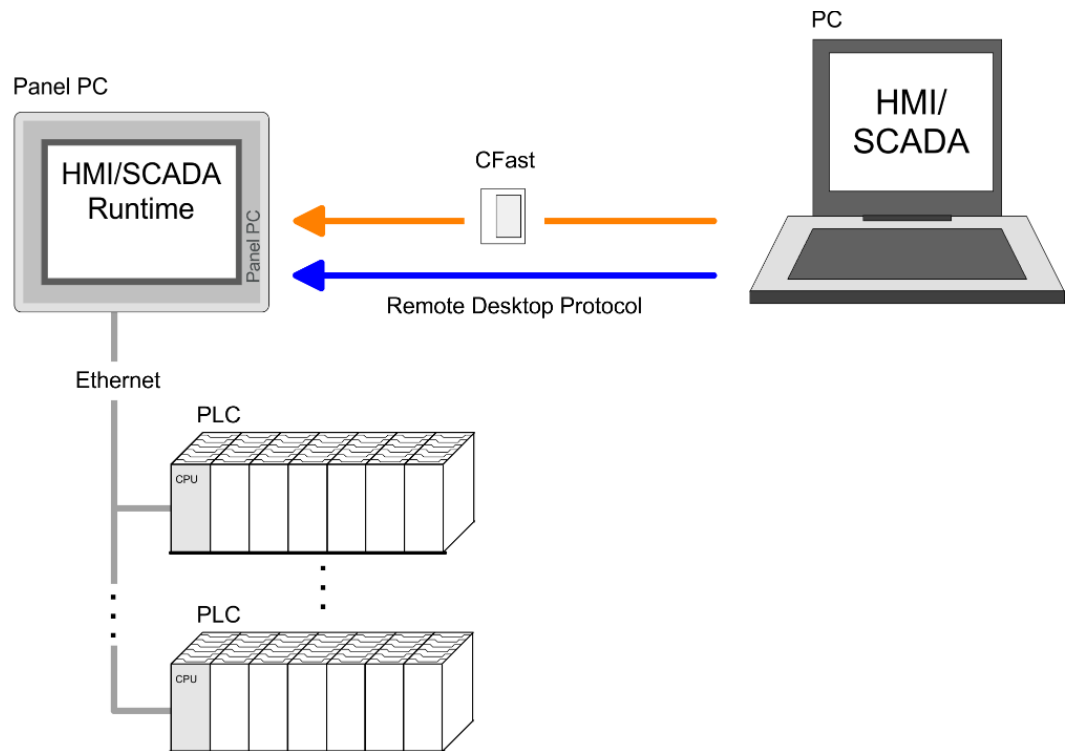

3.5 Operating system Windows Embedded Standard 7

3.5.1 General

Windows® Embedded Standard 7 - WES7 - delivers all the power, familiarity, and reliability of the Windows 7 operating system in a componentized form.

Features

- ftp-Server and IIS-Webserver
- File viewer for Word and Excel
- RDP (Remote Desktop Protocol)
- Internet Explorer
- WordPad
- Mouse pointer
- USB keyboard driver

Differences to the standard Windows® operation

Please regard that for the deployment of Windows® Embedded Standard 7 a thorough knowledge of operating Windows® are assumed. Here are only shown the differences to a "standard" Windows® operating system.

Pen entry

You're operating the Panel by means of a pencil for capacitive touch screen res. with the finger. When touching an area at the touch screen this area is recognized and the program reacts accordingly. The following types of entry are differentiated:

- *Double click*
A double click has to be executed like mouse operation by touching the area at the screen twice. A double click on an object opens res. executes this.
- *Drag*
By tapping on an object and then dragging you may move the object on the screen. If no object is selected, a frame is created by the dragging that selects the touched objects.

Mouse functions

In this version mouse functions are fully supported. As soon as the touch screen is touched with the pen, a mouse pointer is shown on the desktop at the pen position.

Navigation within the dialog window

The windows may be moved via the head bar. Here you may also find the [OK] button to confirm entries and the [X] button for exiting the dialog.

Exit WES7 (shut down)

Don't turn off the Panel PC with the power switch. Always exit WES7 via "Shut down".

3.5.2 Structure



1	<i>Icon</i>	Via icons on the desktop you gain direct access to the application related to the icon.
2	<i>Desktop</i>	The desktop is the screen that is shown after login at Windows®. It contains e.g. links to the mostly used applications res. system components.
3	<i>Task bar</i>	The task bar is part of the desktop. When opening an application, a document or a window, every running object is displayed as button on the task bar. Via this buttons you may easily change between the open windows.

Task bar

Basically the taskbar has the following structure:



1	<i>Start button</i>	This button offers you access to all components of your Panel PC such as applications, system settings, file browser etc.
2	<i>Windows Explorer</i>	The Windows Explorer is shown.
3	<i>Internet Explorer</i>	The Internet Explorer is shown.
4	<i>Open applications</i>	For every open application a button is to be found in the task bar. The switch between the applications is performed via this buttons.
5	<i>Software keyboard</i>	This button displays a keyboard at the screen.
6	<i>Keyboard layout</i>	If you've connected a keyboard you may choose the requested language layout via this button.

7	Network connection	As soon as your Panel PC is connected via Ethernet you can see here the Ethernet address. If there is no connection via Ethernet, the symbol is displayed crossed out.
8	Time, Date	This area shows time and date that you may change via double click.

Software keyboard

The button  allows you to select a software keyboard. The software keyboard allows you to enter key entries without connecting an external keyboard. As soon as an entry is required the software keyboard is automatically shown.

At the moment the following keyboards are implemented:

Software Keyboard

The button  allows you to select the normal software keyboard.



Expanded Software Keyboard

Via 'Tools → Show expanded keyboard' you may open the expanded keyboard.

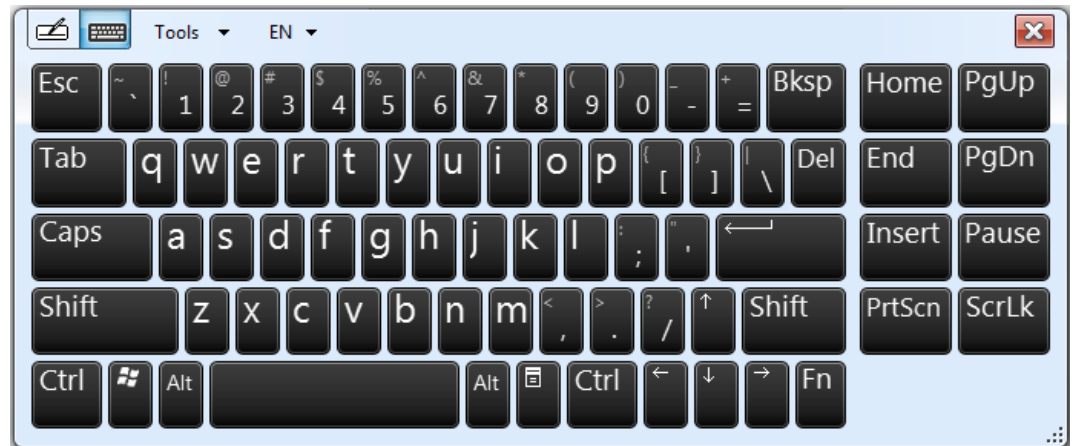

Control Panel

The description of the *Control Panel* components relevant for operating the Panel PC can be found in the following:

- *Change display language*
Per default, the PC is delivered with the display language "English". You can change the language in 'Start → Control Panel → Clock, Language and Region → Change display language'.
- *Ethernet parameters*
The dialog field for pre-setting an Ethernet address can be found in 'Start → Control Panel → Network and Internet → Network and Sharing Center → Change adapter settings'. By double-click on the network the dialog window for network properties opens. Here you can enter the Ethernet address via [Properties] after double-click on [Internet Protocol Version ..]. The default setting is address assignment via DHCP.
- *Switch function*
If you select both Ethernet adapters under 'Start → Control Panel → Network and Internet → Network and Sharing Center → Change adapter settings', you can establish a network bridge via 'Bridge Connections' in the context menu. A further Ethernet adapter called 'Network Bridge' will be displayed. Here you can make all settings.
- *System properties*
Via 'Start → Settings → System and Security → System' you receive information about the version of the current Windows® operating system and the copyright.
Via 'System Protection' or 'Change settings' under 'Change' you can change the device name that is shown during Ethernet communication for instance.
- *Allow remote access*
By default, remote access to the Panel PC is disabled. For release, open the window 'Remote' via 'Start → Control Panel → System and Security → System → Allow remote access', choose one of the release options and confirm with [OK].

Disable automatic log-in

By default, the Panel PC automatically logs in with the user name *VIPA* and the password *vipatp*. If the user needs to enter name and password to use the Panel PC, the procedure is as follow:

1. ➤ Type "cmd" under 'Start → Run'.

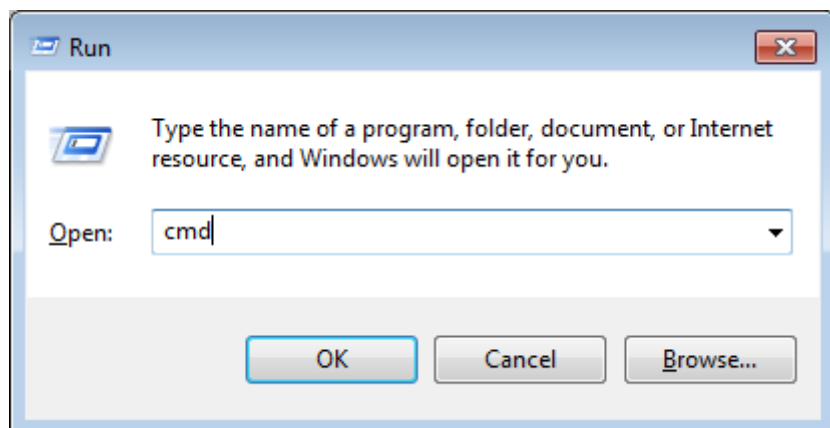

2. ➤ In the next window type "control userpasswords2".

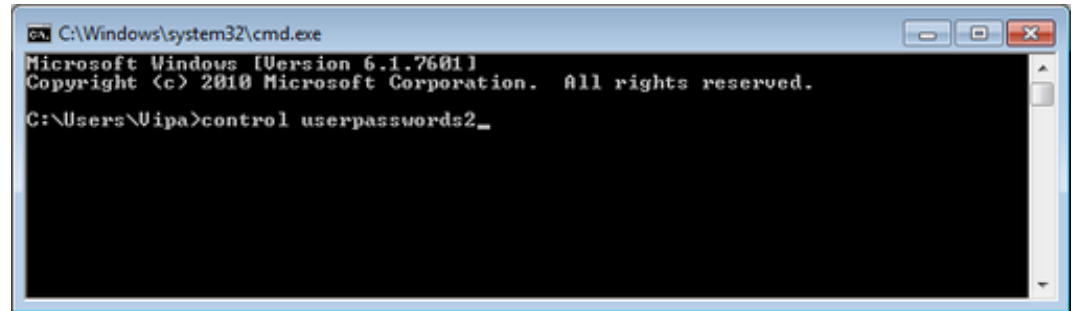

3. In the opening dialog window check the box 'User must enter a user name and password to use this computer.' and confirm with [Apply]. You can also change the password in this section under [Reset Password] at any time.

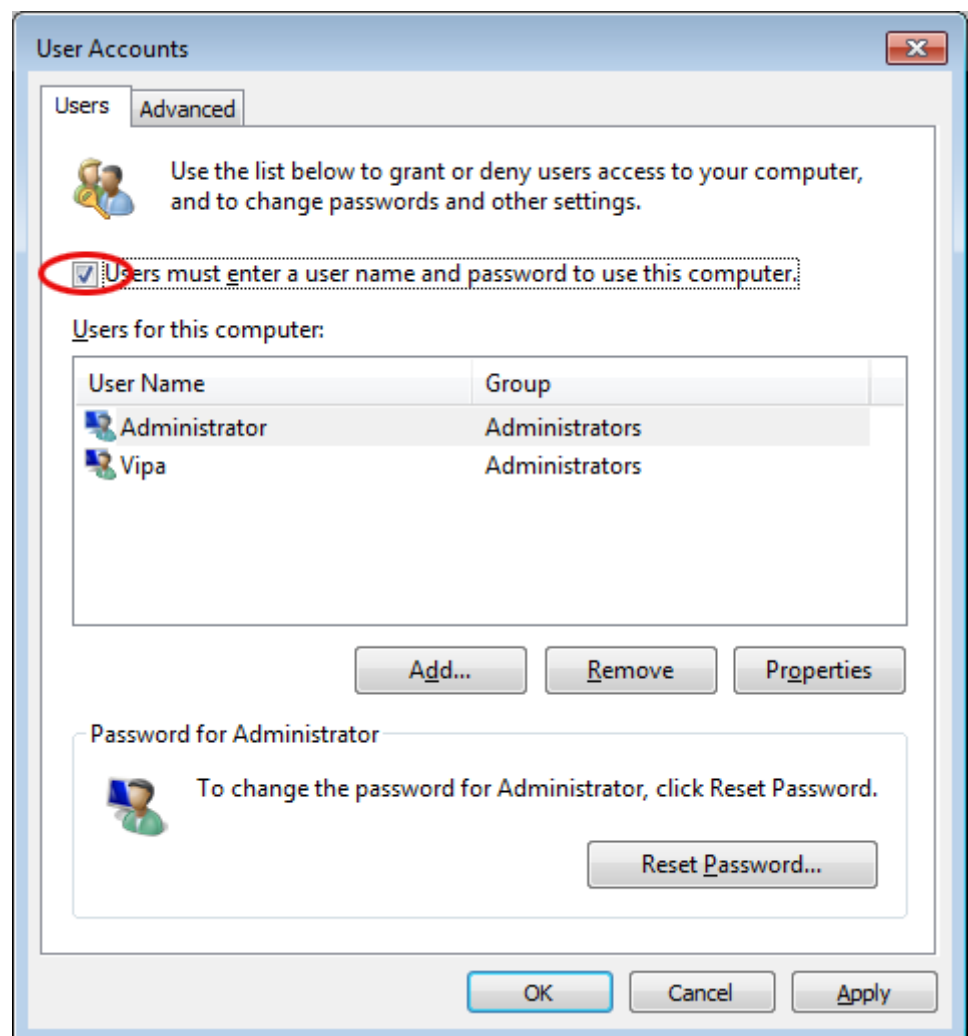

At the next start-up the user has to select the user name and enter the 'Password'.

Enable automatic log-in

1. Type "cmd" under 'Start → Run'.
2. In the next window type "control userpasswords2".
3. In the opening dialog window uncheck the box 'User must enter a user name and password to use this computer' and confirm with [Apply].
4. A new dialog window opens asking you to enter the log-in data. Select here your 'User Name' and enter the corresponding 'password'. Confirm with [OK].

The next start-up takes place without requesting the log-in data.

Enhanced Write Filter

The *'Enhanced Write Filter'* is a tool which can be used to disable permanent writing accesses to the internal drive "C:". It can be written to the drive but the data is not stored permanently.

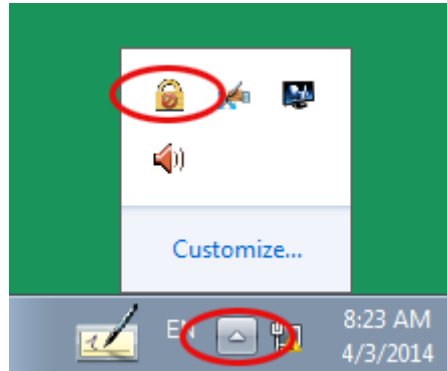

1. Open the configuration window of the Enhanced Write Filter by clicking  icon in the system tray.
2. In the next window click on [Configure].
3. In the following window select *enable* under *'Pending command'* to enable the Enhanced Write Filter.

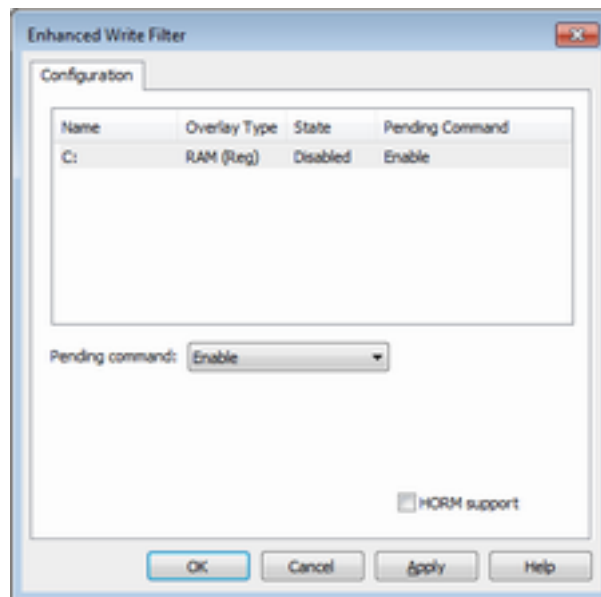

4. Confirm with [Apply] and [OK].
5. To disable the Enhanced Write Filters select *Commit and disable live* under *'Pending command'*.



Please note that a status change of the Enhanced Write Filter will only take effect after a restart of the system.

4 BIOS setup

4.1 Overview

- In this chapter you will find information, required for calling the BIOS setup and the possible settings.
- The BIOS (Basic Input and Output System) setup program is a menu driven utility that enables you to make changes to the system configuration and tailor your system to suit your individual work needs. It is a ROM-based configuration utility that displays the system's configuration status and provides you with a tool to set system parameters.
- These parameters are stored in non-volatile battery-backed-up CMOS RAM that saves this information even when the power is turned off. When the system is turned back on, the system is configured with the values found in CMOS.
- With easy-to-use pull down menus, you can configure such items as:
 - Hard drives, diskette drives, and peripherals
 - Video display type and display options
 - Password protection from unauthorized use
 - Power management features

Configure the BIOS

This program should be executed under the following conditions:

- Changing the system configuration
- A configuration error is detected by the system and you are prompted to make changes to the setup program
- Resetting the system clock
- Redefining the communication ports to prevent any conflicts
- Making changes to the power management configuration
- Changing the password or making other changes to the security setup

Normally, CMOS setup is needed when the system hardware is not consistent with the information contained in the CMOS RAM, whenever the CMOS RAM has lost power or the system features need to be changed.

Default Configuration

Most of the configuration settings are either predefined according to the *'Load Optimal Defaults'* settings which are stored in the BIOS or are automatically detected and configured without requiring any actions. There are a few settings that you may need to change depending on your system configuration.

Entering BIOS setup

When the system is powered on, the BIOS will enter the Power-On Self Test (POST) routines. These routines perform various diagnostic checks; if an error is encountered, the error will be reported in one of two different ways:

- If the error occurs before the display device is initialized, a series of beeps will be transmitted.
- If the error occurs after the display device is initialized, the screen will display the error message.

Powering on the computer and immediately pressing *[Del]* allows you to enter Setup.

Selection boot medium

Powering on the computer and immediately pressing *[F7]* allows you, as long as the loading screen is shown, to change to the boot medium selection.

Legends

Key	Function
←→	Moves the highlight left or right to select a menu
↑↓	Moves the highlight up or down between submenus or fields
Ecs	Exits the BIOS setup utility
+ -	Scrolls forward or backward through the values or options of the highlighted field
Tabulator	Selects a field
F1	Displays General Help
F2	Load previous values
F3	Load optimized default values
F4	Saves and exits the setup program
Enter	Enters the highlighted submenu. When ► appears on the left of a particular field, it indicates that a submenu which contains additional options are available for that field.

BIOS setup utility

- Main - Basic system configuration
- Advanced - Extended system configuration
- Chipset - Configuration chipset
- Boot - Boot sequence
- Security - Security settings
- Save and Exit - Save and exit

4.2 Main

The Main menu is the first screen that you will see when you enter the BIOS setup utility.



System Date

The date format is *day month/date/year* an.

- Day displays a day, from Monday to Sunday.
- Month displays the month, from January to December.
- Date displays the date, from 1 to 31.
- Year displays the year, from 1999 to 2099.

System Time

The time format is *hour:minute:second*.

- hour displays hours from 00 to 23.
- minute displays minutes from 00 to 59.
- second displays seconds from 00 to 59.

4.3 Advanced

This menu allows you to configure the system's extended functions. Here you can configure the CPU and the periphery.



CAUTION!

Setting incorrect field values may cause the system to malfunction.



Submenu "ACPI Settings"

This section is used to configure *Advanced Configuration and Power Interface (ACPI) Settings*.

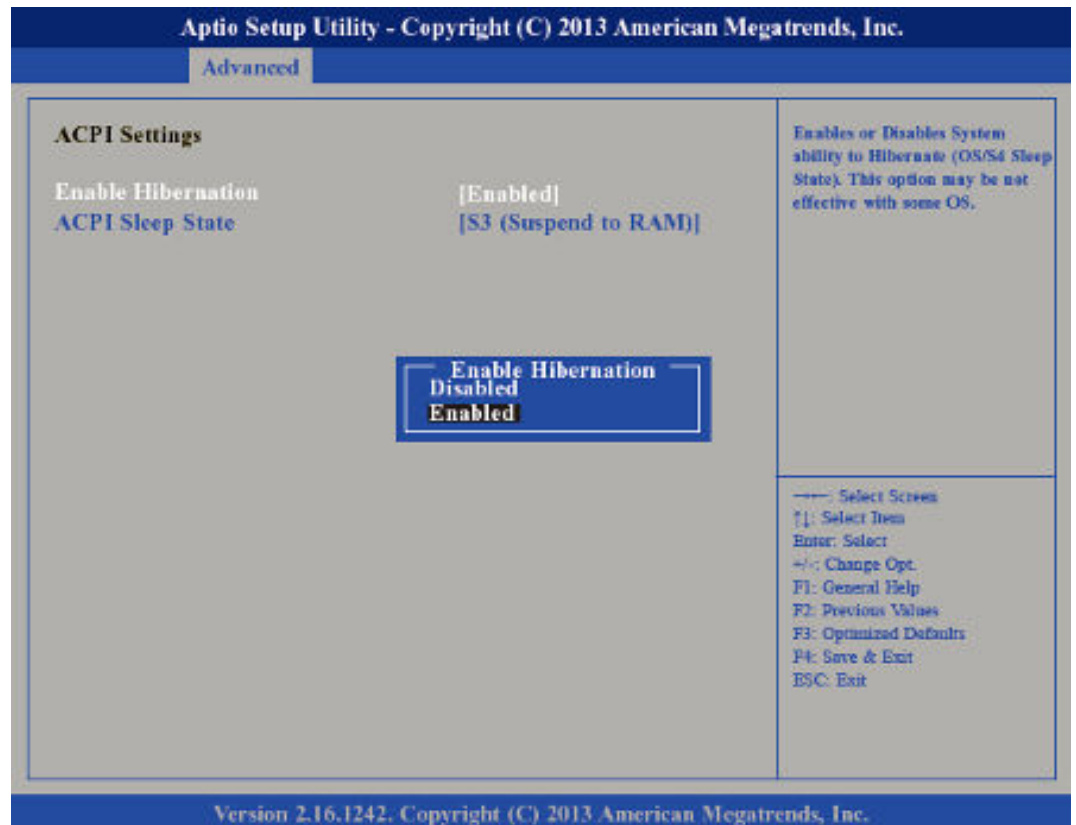

Enable Hibernation

Enables or disables (default) system ability to hibernate (*S4 Sleep State*).

ACPI Sleep State

Select the highest *ACPI Sleep State* the system will enter when the suspend button is pressed.

Suspend Disabled - Sleep state disabled

S3 (Suspend to RAM) - Standby mode enabled, Windows saves the system state in RAM.

Submenu "IT8786E Super IO Configuration"

This section is used to configure serial ports.

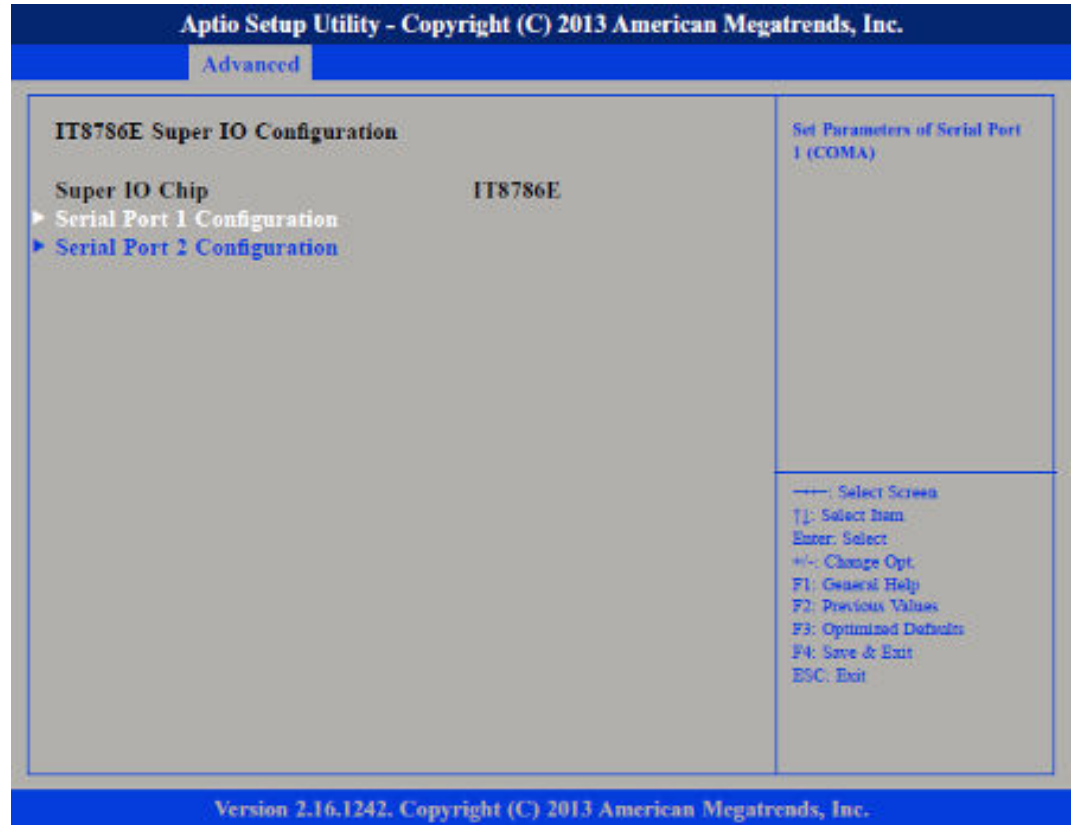

Super IO Chip

Displays the *Super I/O Chip* used on the board.

Submenu "Serial Port 1 Configuration"

This section is used to configure serial port 1.



Serial Port Enables or disables the serial port.
 Disabled - Serial port is not available
 Enabled - (default) Serial port is available

Device Settings Selects an optimal setting for the *Super IO Device*.

Onboard Serial Port Mode This field is used to configure the mode of serial port 0 as RS232 (default), RS422, RS485 or RS485 AUTO.

Terminal resistor Enables or disables the terminal resistor.
 Disabled - Terminal resistor not activated
 Enabled - (default) Terminal resistor activated

Submenu "Serial Port 2 Configuration" This section is used to configure serial port 2.



Serial Port Enables or disables the serial port.
 Disabled - Serial port is not available
 Enabled - (default) Serial port is available

Device Settings Selects an optimal setting for the *Super IO Device*.

Advanced

Onboard Serial Port Mode This field is used to configure the mode of serial port 1 as RS232, RS422 (default), RS485 or RS485 AUTO.

Terminal resistor Enables or disables the terminal resistor.
 Disabled - Terminal resistor not activated
 Enabled - (default) Terminal resistor activated

Submenu "H/W Monitor" This section 'Pc Health Status' is used to configure the hardware temperature and voltages.

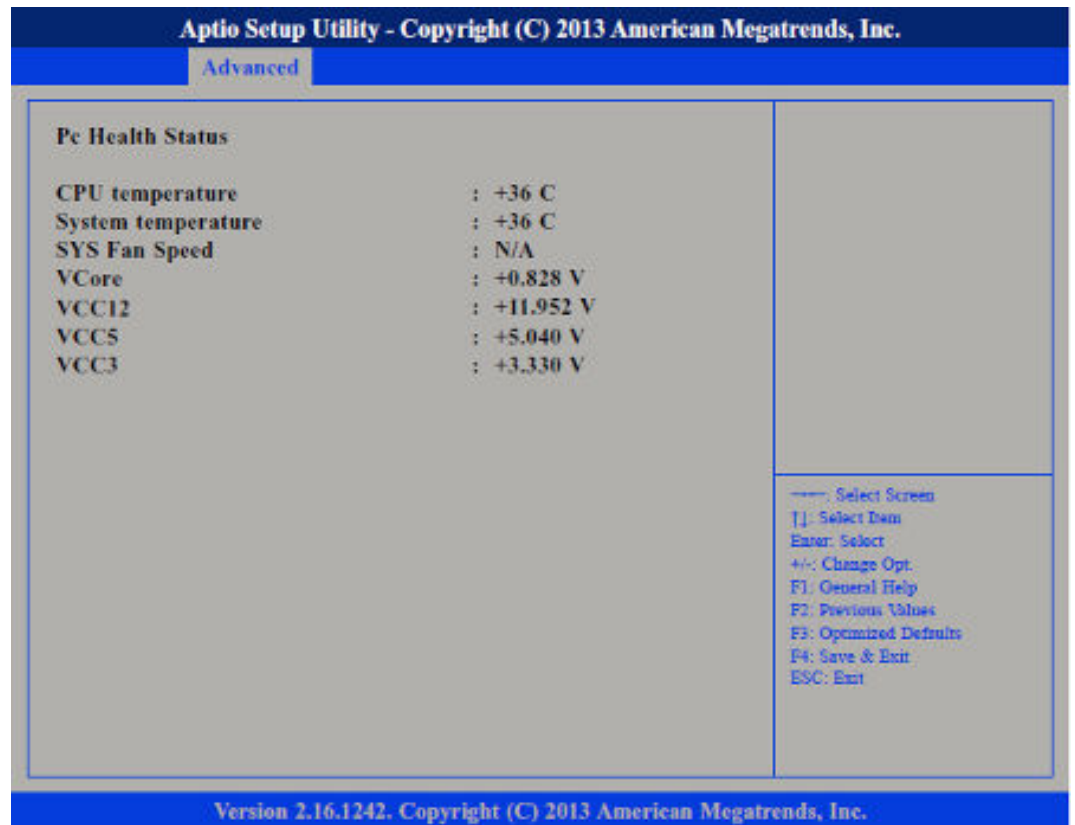

Submenu "CPU Configuration" This section is used to configure the CPU.



Active Processors Cores Select the number of cores to enable in each processor package.

Limit CPUID Maximum The *CPUID* instruction of some newer CPUs will return a value greater than 3. The default is disabled because this problem does not exist in the Windows series operating systems. If you are using an operating system other than Windows, this problem may occur. To avoid this problem, enable this field to limit the return value to 3 or less than 3.

Disabled - (default) All of the CPUID functions are supported.

Enabled - Limit the return value to 3 or less than 3.

Execute Disable Bit XD can prevent certain classes of malicious buffer overflow attacks.

Enabled - Permit the switching on of the execute disable function by the OS.

Disabled - Prevents the switching on of the execute disable function by the OS; it will force the XD feature flag to always return to 0.

Intel® Virtualization Technology Enables or disables *Intel Virtualization Technology*.

Submenu "Socket 0 CPU Information" Display information on the CPU installed on socket 0.

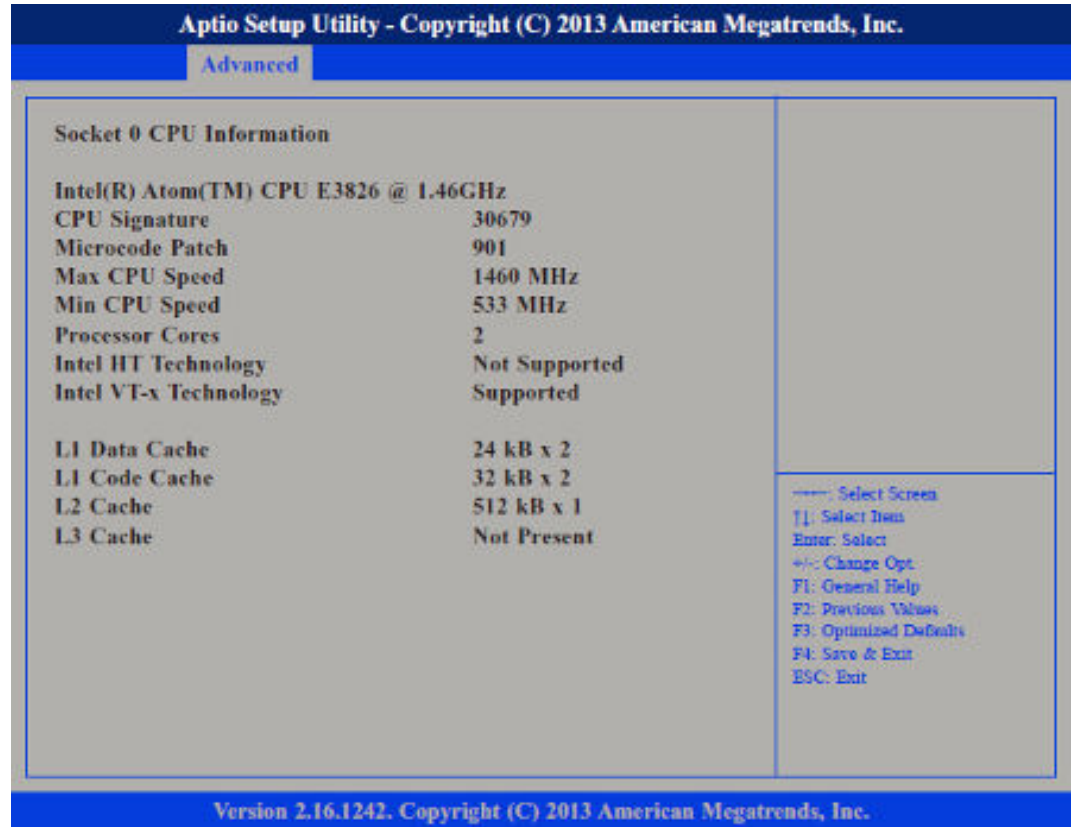

Submenu "PPM Configuration"

This section is used to configure the *Processor Power Management (PPM)* configuration.



EIST Enables or disables *Intel® SpeedStep*.

Submenu "IDE Configuration" This section is used to configure the IDE devices.



Serial-ATA (SATA) Enables or disables SATA controller.

SATA Speed Support Configures the *SATA controller* as Gen1 or Gen2.

SATA Mode Configures the SATA as IDE or AHCI mode.

IDE - This option configures the serial ATA drives as parallel ATA physical storage device.

AHCI - This option configures the serial ATA drives to use *AHCI (Advanced Host Controller Interface)*. AHCI allows the storage driver to enable the advanced serial ATA features which will increase storage performance.

Serial-ATA Port 0 Enables or disables SATA port 0.

SATA Port0 HotPlug Enables or disables *Hot Pluggable Support* on SATA port 0.

Serial-ATA Port 1 Enables or disables SATA port 1.

SATA Port1 HotPlug Enables or disables *Hot Pluggable Support* on SATA port 1.

Submenu "USB Configuration"

This section is used to configure USB devices, such as keyboard, mouse and hub.



Legacy USB Support

Support of USB keyboard, mouse and storage media in EFI and DOS environments.

- Enable - (Default) Enables *Legacy USB*.
- Auto - Disables *Legacy USB Support* when no USB devices are connected.
- Disable - Keeps USB devices available only for EFI applications.

USB3.0 Support

- Enabled - (Default) Enables USB 3.0 controller support.
- Disabled - Disables USB 3.0 controller support.

XHCI Hand-off and EHCI Hand-off

- Enabled - Enables *XHCI* (USB 3.0) or *EHCI* (USB 2.0) support.
- Disabled - Disables *XHCI* (USB 3.0) or *EHCI* (USB 2.0) support.

 *When installing Windows 7 from USB, USB 3.0 will not be supported. Please disable XHCI and enable EHCI to allow USB installation of Windows 7.*

4.4 Chipset

This section is used to configure the system based on the specific features of the chipset.

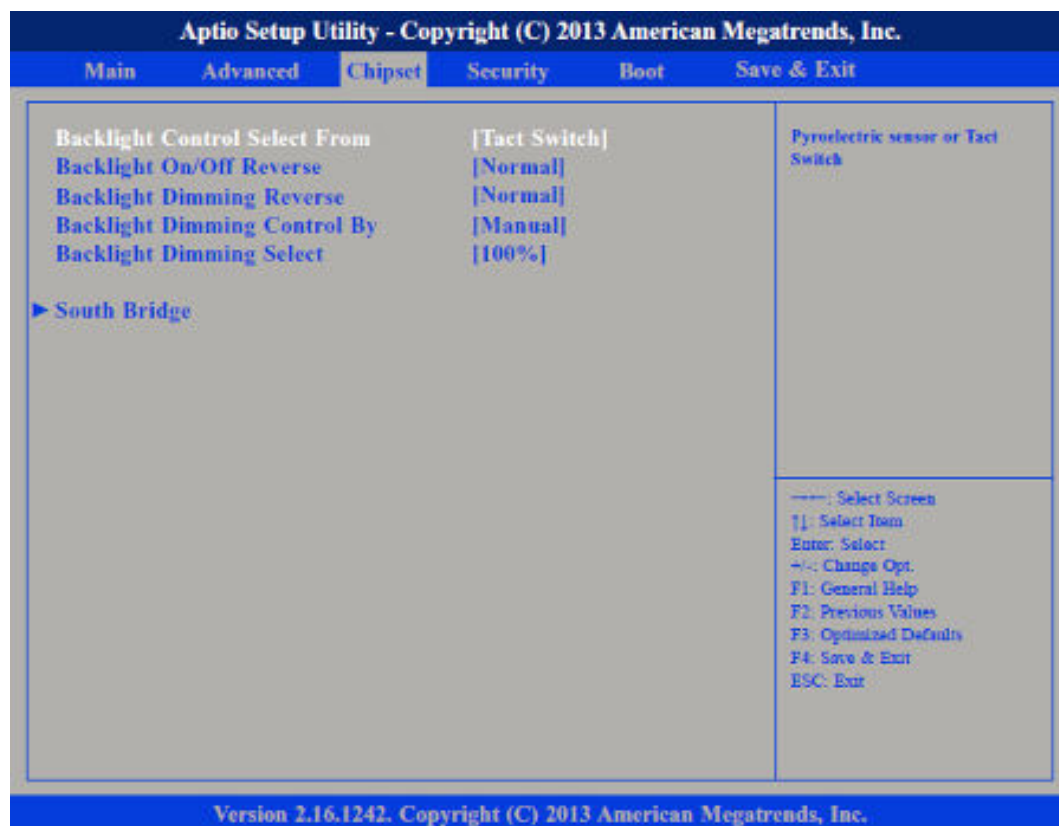

CAUTION!

Setting incorrect field values may cause the system to malfunction.

Backlight Control Select From

The available options are 'Pyroelectric sensor' and 'Tact Switch'. The default setting is 'Tact Switch'.

Backlight On/Off Reverse

Please configure this option only when changing the panel, otherwise the display may not work.

Backlight Dimming Control By

The options are 'Tact Switch', 'Manual' and 'Light Sensor'. The default setting is 'Manual' and the Backlight option below will be configurable.

Backlight Dimming Select

Adjust the brightness of the backlight.

Submenu "South Bridge"

This field is used to configure the *South Bridge* chipset.



High Precision Timer

This section is used to configure *High Precision Event Timer*.

Restore AC Power Loss

System response when power returns after an AC power failure.

- Last State - The system will return to the state where you left off before power failure occurs.
- Power Off - The system's power is off. You must press the power button to Power On the system.
- Power On - (default) The system will automatically Power On.

Submenu "Azalia HD Audio"

This section disables Azalia or enables HD Audio.

**Audio Controller**

Control detection of the Azalia device.

Disabled - Azalia will be unconditionally disabled.

Enabled - Azalia will be unconditionally enabled.

Azalia HDMI Codec

Enables or disables internal HDMI Codec for Azalia.

Chipset

Submenu "USB Configuration"

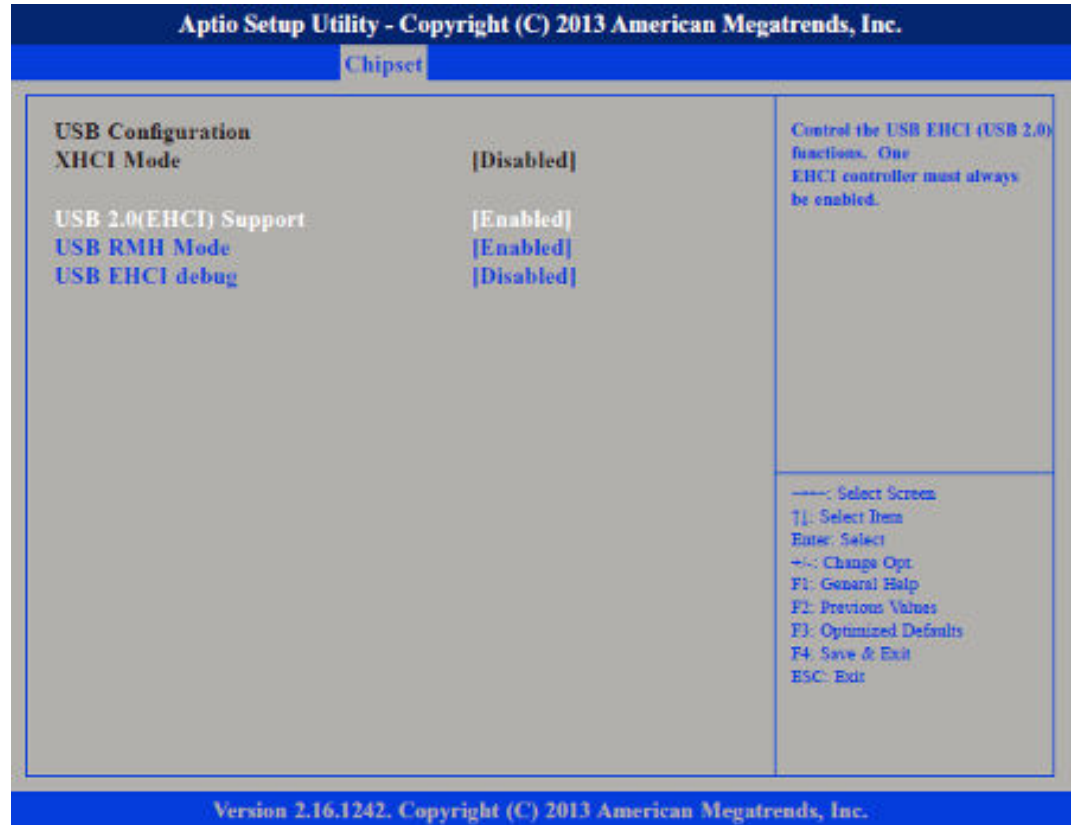

USB 2.0(EHCI) Support

Enables or disables the Enhanced Host Controller Interface (USB 2.0), one EHCI controller must always be enabled.

USB RMH Mode

Enables or disables PCH USB rate matching hubs mode.

USB EHCI debug

Enables or disables *PCH EHCI debug* capability.

Submenu "PCI Express Configuration"

**PCI Express Port 0 ... PCI Express Port 3**

Enables or disables the PCI Express ports 0 ... 3 on the chipset.

4.5 Boot

This section is used to configure the boot features.



Bootup NumLock State

This allows you to determine the default state of the numeric keypad.
 On - (default) The function of the numeric keypad is the number keys.
 Off - The function of the numeric keypad is the arrow keys.

Fast Boot

When enabled, the BIOS will shorten or skip some check items during POST. This will decrease the time needed to boot the system.

Network

Controls the execution of UEFI and legacy PXE OpROM.

Onboard LAN PXE

Enables or disables the boot option for legacy network devices connected to LAN1 or LAN2.

Disabled - (default) Starts no LAN PXE ROM

Enabled - Starts the LAN PXE ROM, to be able to boot about PXE

Boot Option Priorities

Adjust the boot sequence of the system.

Hard Drive BBS Priorities

Sets the order of the legacy devices in this group.

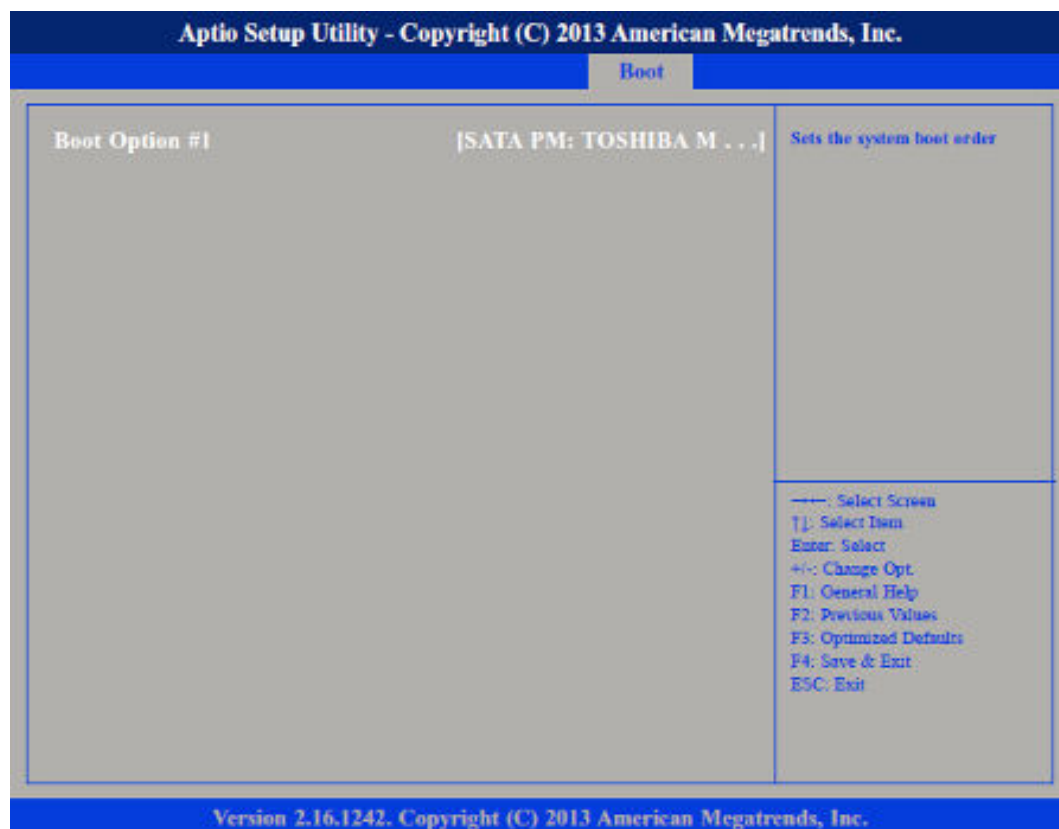

4.6 Security

If ONLY the Administrator's password is set

If only the Administrator's password is set, then this only limits access to setup and is only asked for when entering setup.

If ONLY the User's password is set

If only the User's password is set, then this is a power on password and must be entered to boot or enter setup. In Setup the user will have administrator rights.



Administrator Password

Select this to reconfigure the administrator's password. Your password must contain at least 3 characters and should be maximal 20 characters long.

User Password

Select this to reconfigure the user's password. Your password must contain at least 3 characters and should be maximal 20 characters long.

4.7 Save and Exit



Save Changes and Reset

To save the changes and reset, select this field then press *[Enter]*. A dialog box will appear. Confirm by selecting *[Yes]*. A restart follows and the new settings become effective.

Discard Changes and Reset

To exit the Setup utility and reboot the system without saving the changes, select this field then press *[Enter]*. You may be prompted to confirm again before exiting. The BIOS setup exits and a restart follows.

Restore Defaults

To restore the BIOS to default settings, select this field then press *[Enter]*. A dialog box will appear. Confirm by selecting *[Yes]*.

Save Changes and Exit

To save the changes and exit the setup utility press *[F4]*.

Discard Changes and Exit

To exit the Setup utility without saving the changes *[Esc]*. The BIOS setup exits and the POST continued.

5 Industrial Security and Installation guidelines

5.1 Industrial security in information technology

Latest version

This chapter can also be found as a guide '*Industrial IT Security*' at www.yaskawa.eu.com

Hazards

The topic of data security and access protection has become increasingly important in the industrial environment. The increased networking of entire industrial systems to the network levels within the company together with the functions of remote maintenance have all served to increase vulnerability. Hazards can arise from:

- Internal manipulation such as technical errors, operating and program errors and deliberate program or data manipulation.
- External manipulation such as software viruses, worms and Trojans.
- Human carelessness such as password phishing.

Precautions

The most important precautions to prevent manipulation and loss of data security in the industrial environment are:

- Encrypting the data traffic by means of certificates.
- Filtering and inspection of the traffic by means of VPN - "Virtual Private Networks".
- Identification of the user by "Authentication" via safe channels.
- Segmenting in protected automation cells, so that only devices in the same group can exchange data.
- Deactivation of unnecessary hardware and software.

Further Information

You can find more information about the measures on the following websites:

- Federal Office for Information Technology www.bsi.bund.de
- Cybersecurity & Infrastructure Security Agency us-cert.cisa.gov
- VDI / VDE Society for Measurement and Automation Technology www.vdi.de

5.1.1 Protection of hardware and applications

Precautions

- Do not integrate any components or systems into public networks.
 - Use VPN "Virtual Private Networks" for use in public networks. This allows you to control and filter the data traffic accordingly.
- Always keep your system up-to-date.
 - Always use the latest firmware version for all devices.
 - Update your user software regularly.
- Protect your systems with a firewall.
 - The firewall protects your infrastructure internally and externally.
 - This allows you to segment your network and isolate entire areas.
- Secure access to your plants via user accounts.
 - If possible, use a central user management system.
 - Create a user account for each user for whom authorization is essential.
 - Always keep user accounts up-to-date and deactivate unused user accounts.
- Secure access to your plants via secure passwords.
 - Change the password of a standard login after the first start.
 - Use strong passwords consisting of upper/lower case, numbers and special characters. The use of a password generator or manager is recommended.
 - Change the passwords according to the rules and guidelines that apply to your application.
- Deactivate inactive communication ports respectively protocols.
 - Only the communication ports that are used for communication should be activated.
 - Only the communication protocols that are used for communication should be activated.
- Consider possible defence strategies when planning and securing the system.
 - The isolation of components alone is not sufficient for comprehensive protection. An overall concept is to be drawn up here, which also provides defensive measures in the event of a cyber attack.
 - Periodically carry out threat assessments. Among others, a comparison is made here between the protective measures taken and those required.
- Limit the use of external storage media.
 - Via external storage media such as USB memory sticks or SD memory cards, malware can get directly into a system while bypassing a firewall.
 - External storage media or their slots must be protected against unauthorized physical access, e.g. by using a lockable control cabinet.
 - Make sure that only authorized persons have access.
 - When disposing of storage media, make sure that they are safely destroyed.
- Use secure access paths such as HTTPS or VPN for remote access to your plant.
- Enable security-related event logging in accordance with the applicable security policy and legal requirements for data protection.

5.1.2 Protection of PC-based software

Precautions

Since PC-based software is used for programming, configuration and monitoring, it can also be used to manipulate entire systems or individual components. Particular caution is required here!

- Use user accounts on your PC systems.
 - If possible, use a central user management system.
 - Create a user account for each user for whom authorization is essential.
 - Always keep user accounts up-to-date and deactivate unused user accounts.
- Protect your PC systems with secure passwords.
 - Change the password of a standard login after the first start.
 - Use strong passwords consisting of upper/lower case, numbers and special characters. The use of a password generator or manager is recommended.
 - Change the passwords according to the rules and guidelines that apply to your application.
- Enable security-related event logging in accordance with the applicable security policy and legal requirements for data protection.
- Protect your PC systems by security software.
 - Install virus scanners on your PC systems to identify viruses, trojans and other malware.
 - Install software that can detect phishing attacks and actively prevent them.
- Always keep your software up-to-date.
 - Update your operating system regularly.
 - Update your software regularly.
- Make regular backups and store the media at a safe place.
- Regularly restart your PC systems. Only boot from storage media that are protected against manipulation.
- Use encryption systems on your storage media.
- Perform security assessments regularly to reduce the risk of manipulation.
- Use only data and software from approved sources.
- Uninstall software which is not used.
- Disable unused services.
- Activate a password-protected screen lock on your PC systems.
- Always lock your PC systems as soon as you leave your PC workstation.
- Do not click any links that come from unknown sources. If necessary ask, e.g. on e-mails.
- Use secure access paths such as HTTPS or VPN for remote access to your PC system.

5.2 Installation guidelines

5.2.1 Basic rules for the EMC-equitable assembly of installations

General

The installation guidelines contain information about the interference free deployment of a PLC system. There is the description of the ways, interference may occur in your PLC, how you can make sure the electromagnetic compatibility (EMC), and how you manage the isolation.

What does EMC mean?

Electromagnetic compatibility (EMC) means the ability of an electrical device, to function error free in an electromagnetic environment without being interfered respectively without interfering the environment.

The components are developed for the deployment in industrial environments and meets high demands on the EMC. Nevertheless you should project an EMC planning before installing the components and take conceivable interference causes into account.

Possible interference causes

Electromagnetic interferences may interfere your control via different ways:

- Electromagnetic fields (RF coupling)
- Magnetic fields with power frequency
- Bus system
- Power supply
- Protected earth conductor

Depending on the spreading medium (lead bound or lead free) and the distance to the interference cause, interferences to your control occur by means of different coupling mechanisms.

There are:

- galvanic coupling
- capacitive coupling
- inductive coupling
- radiant coupling

Coupling mechanisms and interference sources

The following table shows the four different coupling mechanisms, their causes and possible interference sources.

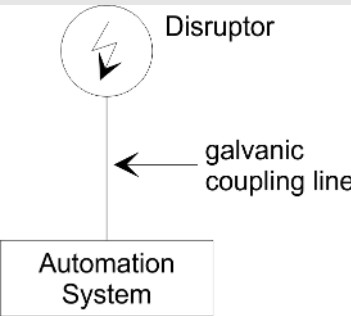
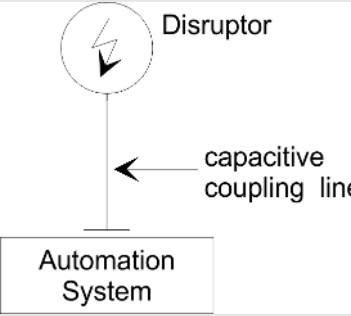
Coupling mechanism	Cause	Typical source
<p>Galvanic coupling</p> 	Galvanic or metallic coupling always occurs, when two current circuits have a common line.	<ul style="list-style-type: none"> ■ Pulsed devices (Net influence from transducers and foreign net devices) ■ Starting motors ■ Different potential of component cubicles with common current supply ■ Static discharges
<p>Capacitate coupling</p> 	Capacitate or electric coupling occurs between conductors with different potential. The coupling is proportionate to the temporal change of the voltage.	<ul style="list-style-type: none"> ■ Interference through parallel signal lines ■ Static discharge of the personnel ■ Contactors

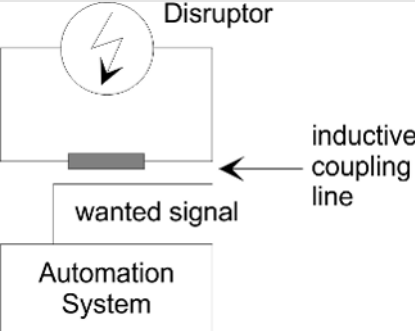
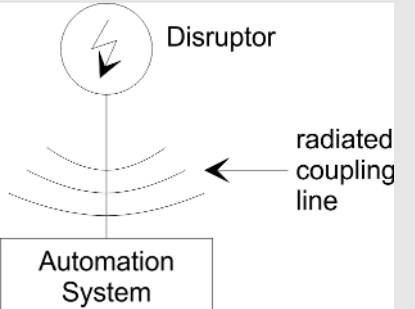
Coupling mechanism	Cause	Typical source
<p>Inductive coupling</p> 	<p>Inductive or magnetic coupling occurs between two current active line loops. The magnetic flows associated with the currents induct interference voltages. The coupling is proportional to the time related change of the current.</p>	<ul style="list-style-type: none"> ■ Transducers, motors, electric welding devices ■ Parallel net cables ■ Cables with toggled currents ■ Signal cable with high frequency ■ Unused coils
<p>Radiate power coupling</p> 	<p>One talks of radiate power coupling, when an electromagnetic wave meets a line circuit. The hit of the wave inducts currents and voltages.</p>	<ul style="list-style-type: none"> ■ Sender in the neighbourhood (e.g. walkie-talkie) ■ Sparking lines (sparking plugs, collector of electric motors, welding devices)

Basic rules for EMC

In the most times it is enough to take care of some elementary rules to guarantee the EMC. Please regard the following basic rules when installing your PLC.

- Take care of a correct area-wide grounding of the inactive metal parts when installing your components.
 - Install a central connection between the ground and the protected earth conductor system.
 - Connect all inactive metal extensive and impedance-low.
 - Please try not to use aluminium parts. Aluminium is easily oxidizing and is therefore less suitable for grounding.
- When cabling, take care of the correct line routing.
 - Organize your cabling in line groups (high voltage, current supply, signal and data lines).
 - Always lay your high voltage lines and signal respectively data lines in separate channels or bundles.
 - Route the signal and data lines as near as possible beside ground areas (e.g. suspension bars, metal rails, tin cabinet).
- Proof the correct fixing of the lead isolation.
 - Data lines must be shielded.
 - Analog lines must be shielded. When transmitting signals with small amplitudes the one sided laying of the isolation may be favourable.
 - Cables for frequency inverters, servo and stepper motors must be shielded.
 - Lay the line isolation extensively on an isolation/protected earth conductor rail directly after the cabinet entry and fix the isolation with cable clamps.
 - Make sure that the isolation/protected earth conductor rail is connected impedance-low with the cabinet.
 - Use metallic or metallised plug cases for isolated data lines.

- In special use cases you should appoint special EMC actions.
 - Consider to wire all inductivities with erase links.
 - Please consider luminescent lamps can influence signal lines.
- Create a homogeneous reference potential and ground all electrical operating supplies when possible.
 - Please take care for the targeted employment of the grounding actions. The grounding of the PLC serves for protection and functionality activity.
 - Connect installation parts and cabinets with your PLC in star topology with the isolation/protected earth conductor system. So you avoid ground loops.
 - If there are potential differences between installation parts and cabinets, lay sufficiently dimensioned potential compensation lines.

5.2.2 EMC-equitable assembly

Mostly, measures for suppressing interference voltages are only taken, when the control is already in commission and the perfect receive of a wanted signal is disturbed. Causes for such interference's are in the most cases inadequate reference potentials, coming from mistakes at the device assembly and installation.

Guidelines for assembling and grounding of inactive metal parts

When assembling the devices, you have to ensure the large-surface grounding of the inactive metal parts. A correctly done grounding supports an unambiguous reference potential for the control and reduces the impact of coupled interferences.

Grounding means the conducting connection of all inactive metal parts. The sum of all interconnected inactive parts is called ground.

Inactive parts are all conductive parts electrically separated from all active parts by means of a basic isolation and that may only get voltage in case of an error.

The ground must not adopt dangerous contact voltage even in case of an error. Thus you have to connect the ground with the protected earth conductor. To avoid ground loops, local distant ground constructions (cubicles, construction and machine parts) have to be connected with the protected earth conductor system in star-topology.

Please regard at grounding:

- Connect the inactive metal parts as carefully as the active ones.
- Take care of impedance-low metal-metal-connections, e.g. with large-surface and well conductive contacts.
- If you include coated or anodized metal parts in the grounding, you have to come through the isolating protection layers. For this you may use special contact washers or remove the isolation layer.
- Protect the connection points from corrosion, e.g. with grease.
- Moveable grounding parts (e.g. cubicle doors) have to be connected via flexible ground strips. The ground strips should be short and have a large surface, because the surface is decisive for the diversion of high frequency interferences.

5.2.3 EMC-equitable cabling

Line routing

Content of this section is the line routing of bus, signal and supply lines. Object of the line routing is to suppress the "slurring" at parallel lines.

Line routing inside and outside of cubicles

For an EMC-equitable routing of the lines it is convenient to divide the cables in different groups and install each group itself:

Group A

- screened bus and data lines
- screened analog lines
- unshielded lines for direct voltage $\leq 60V$
- unshielded lines for alternating voltage $\leq 25V$
- Coaxial cables for monitors

Group B

- unshielded lines for direct voltage $>60V$ and $\leq 400V$
- unshielded lines for alternating voltage $>25V$ and $\leq 400V$

Group C

- unshielded lines for direct and alternating voltage $>400V$

Group D

- Lines for H1 respectively TCP/IP

Combination of groups

Following the table you may see the conditions for the cabling of the line groups by combining the single groups:

	Group A	Group B	Group C	Group D
Group A	[1]	[2]	[3]	[4]
Group B	[2]	[1]	[3]	[4]
Group C	[3]	[3]	[1]	[4]
Group D	[4]	[4]	[4]	[1]

[1]	The lines may be installed in common bundles or cable trusses.
[2]	The lines have to be installed in different bundles or cable trusses (without min. distance).
[3]	The lines have to be installed in different bundles or cable trusses inside of cubicles and outside of the cubicle but inside the building in separated cable trusses with a min. distance of 10cm.
[4]	The lines have to be installed in different bundles or cable trusses with a min. distance of 50cm.

Line routing outside of buildings

Wherever possible, exterior cabling should be installed on metallic cable trays. A galvanic connection must be provided for joints between cable trays. You must abide by the applicable lightning protection and grounding regulations when installing exterior cables.

Lightning protection



CAUTION!

Where cables and signal lines for PLC equipment are installed outside of buildings, the conditions for internal and external lightning protection must be satisfied.

- Exterior lines should either be installed in metallic conduit pipes that is grounded on both ends or in steel-reinforced concrete cable trunks with continuously connected reinforcing.
- Signal lines should be protected against overvoltage by varistors or by lightning arrester filled with rare gas.
- Install these protective elements at the location where the cables enter the building.



Any lightning protection system must be based on an individual assessment of the entire plant. For questions please contact Yaskawa.

Equipotential bonding

Potential differences can occur between different sections when controllers and peripheral equipment are connected by means of non-isolated connections or the screens of screened cables are connected at both ends and grounded on different sections of the plant. One reason for a potential difference can be that different sections of the plant are powered from different power sources. These potential differences must be reduced by means of equipotential bonding conductors to ensure that the electronic equipment employed on the plant operates properly.

Rules for equipotential bonding

- The lower the impedance of the equipotential bonding conductor, the higher the effectiveness of potential equalization.
- The impedance of the equipotential bonding conductor must not exceed 10% of the impedance of the screen where screened signal lines are connected between the different sections of the plant and the screening is connected to ground/neutral on both sides.
- The cross-sectional area of the equipotential bonding conductor must be calculated to carry the maximum equalization current. The following cross-sections have been successfully employed:
 - 16mm² Cu for equipotential bonding conductors up to 200m
 - 25mm² Cu equipotential bonding conductors exceeding 200m.
- Use copper or galvanized steel for equipotential bonding conductors. These must be connected to ground/neutral by means of large-surface connections that are protected from corrosion.
- The equipotential bonding conductor should be installed in such a manner that it includes the smallest surface between the bonding conductor and the signal lines.

Screening of lines and cables

Screening is one method commonly used to reduce (attenuate) the interference pick-up from magnetic, electrical or electromagnetic fields.

- Interference on screens is conducted to ground by the conductive connection between the screen and the screening rain/enclosure. To avoid interference from these currents it is very important that the neutral connection is a low-impedance connection.
- You should only use cables that are provided with a braided screen. The degree of screening should be more than 80%.

- Avoid cables with foil-type screens as the foil can be easily damaged by tension and pressure at the point of attachment; this can result in reduced effectiveness of the screening action.
- As a rule you should always ground the screens of cables on both ends. This is the only way in which you can ensure that high frequency interference is attenuated properly.

One-sided grounding of screens

In exceptional cases it may be necessary to ground the screen on one side only. However, this will only attenuate the lowest frequencies. The one-sided grounding of screens may provide advantages when:

- It is not possible to install an equipotential bonding conductor
- Analogue signals (a few mV or mA) must be transmitted
- Foil-type screening (static screening) is employed.

You should always use metallic or metallised covers for serial data lines. Connect the screen of the data line to the cover. Do **not** connect the screen to PIN 1 of the connector! In case of stationary operations it is recommended that the remove the insulation from the screened cable without cutting the screen and to attach this point to the screening/neutral rail.



Potential differences can give rise to an equalization current via the screen connected between the two ground connections. In this case you must install an additional equipotential bonding conductor.

Connecting the screen

Please observe the following points when you handle the screens:

- Use only metallic cable clamps when connecting the screening of cables. These clamps must provide a good electrical contact and a large-surface connection to the screen.
- Attach the screens to the screening rail directly at the point where the cables enter the enclosure. The screening conductor must be continued to the module without interruption, however, it must not be connected to the module!

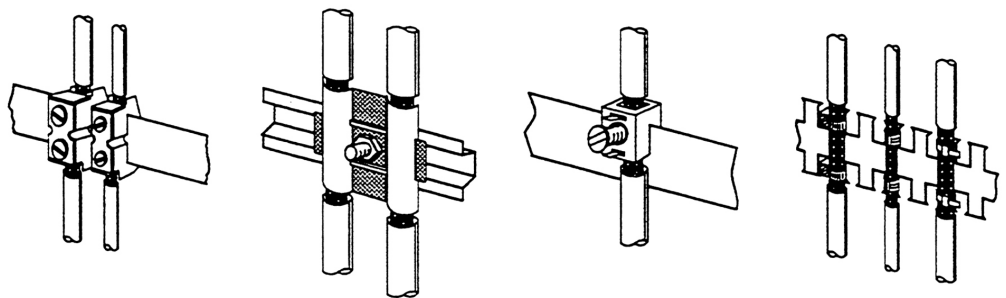

5.2.4 Special precautions providing high noise immunity

Inductors require snubber networks

Inductors controlled by your programmable controller (e.g. contactors and relays) do not normally require additional snubber networks or suppressors as the respective modules have been provided with the required components.

Equipotential bonding

Snubber networks must only be connected to inductors when output circuits can be disabled by means of additional contacts (e.g. relay contacts). In this case the integrated suppressors on the module are also disabled. You can connect diodes to suppress back-emf, varistors or RC-networks to the inductors.

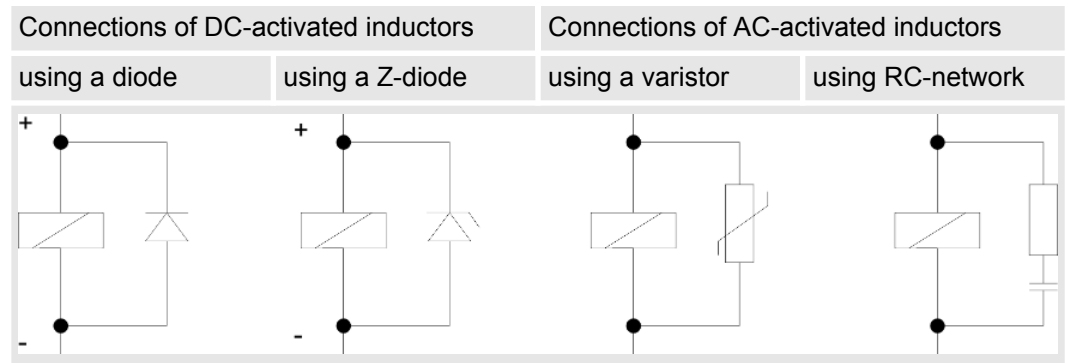

Power outlet for PGs

Every cubicle must be provided with a power outlet for the PU. These outlets must be wired to the distribution system, which is also used to connect the neutral conductor for the cubicle.

Cubicle illumination

The cubicle illumination should consist of incandescent lights, e.g. LINESTRA-lamps. Avoid using fluorescent lamps as these lamps can cause interference. If you can not avoid using fluorescent lamps you should implement the steps outlined in the following figure.

Suppression of fluorescent lamps in cubicles

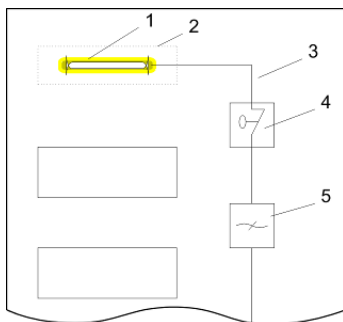

- 1 Fluorescent lamp
- 2 Screen above the lamp
- 3 Screened cable
- 4 Switch with metallic cover
- 5 Line filter or screened power cable

5.2.5 Checklist for the EMC-compliant installation of controllers

EMC-measures	Space for Notes
Connection of the inactive parts	
You should take special care to check the connections of:	
<ul style="list-style-type: none"> ■ Module racks ■ Frames ■ Screen and protected earth conductor 	
Are all the inactive metal parts interconnected by means of large-surface and low-impedance connections?	
Has a proper connection been installed with respect to the ground/protected earth conductor system?	
Has the isolation been removed from varnished and anodized surfaces or have these connections been fitted with special contact washer?	
Have the connection been protected from corrosion, e.g. by means of grease?	
Have doors been grounded by means of grounding straps connected to the body of the cubicle?	
Cable routing	
Cabling divided into groups?	
Power cables (230 ... 400V) and signal lines installed in separate channels or bunches?	
Potential compensating	
When installing the equipment at separate locations, check the installation of the potential compensating line.	
Cable screen	
All covers of plugs are metallic?	
All analog and data lines installed screened?	
Line screens attached to the screening or the protected earth conductor?	
Have the screens been connected by means of large-surface and low-impedance cable clamps?	
Cable screens grounded both-sided where possible?	
Inductors	
Have the coils of contactors controlled by means of contacts been connected to snubber networks?	

Appendix

Content

A	History of changes.....	72
----------	--------------------------------	-----------

A History of changes

Rev.	Changes
18-25	The manual was created.
20-20	CI adjustment was done.
22-20	Chapter "Hardware description" <ul style="list-style-type: none">■ Description "General Data" was changed.■ Description "Use in difficult operating conditions" was added. Chapter "Industrial Security and Installation guidelines" <ul style="list-style-type: none">■ Description "Industrial security and Installation guidelines" was added.