

Panasonic[®]



Compact Inverter VF0 Series 400V class

Instruction Manual

Read this manual carefully before attempting to operate the inverter and store it for future reference.

Panasonic Electric Works Co., Ltd.

Important User Information

The variety of uses for this equipment and difference between this solid state equipment and electromechanical equipment, means that the user of and those responsible for the applying of this equipment must ensure that the application and use of this product is acceptable and safe. Under no circumstances will Matsusita Electric Works, Ltd. (MEW) be responsible or liable for indirect or consequential damages resulting from the use of application of this equipment.

The diagrams and illustrations within this manual are solely intended to illustrate the text of this document. Such are the variables associated with the application of this product to any given installation, that MEW can not assume responsibility or liability for actual use based on the illustrated uses and applications shown herein.

No patent liability is assumed by MEW with concern to the use of information, equipment or circuits outlined in this text.

Reproduction of this manual in whole/part or otherwise is prohibited without the express permission of MEW.

Please follow the information and instructions as laid out in this manual carefully to avoid damage to equipment or risk to personal injury.



ATTENTION ; Indicate situations that could lead to personal injury or death, property damage or financial loss.

Attention will help the user to :

Identify hazard.

Avoid hazard.

Realize the consequences of ignoring the warnings given.

1. PREFACE

Important information relative to this manual

Manufactures and their respective engineering departments responsible for design and specification of electrical control equipment must refer to applicable industry standards and codes for specific safety guidelines and interface requirements.

The installer/user of this product is responsible to assume compliance with appropriate machine and operator safety codes or regulations within the factory environment which are beyond the scope and purpose of this documents.

General precautions

Added to the precautions listed within this document.

The following statements common to the system must be read and understood.



ATTENTION ; Only qualified personnel familiar with the VF0 and its application should plan, install, start up or maintain the system.

Failure to comply may result in personal injury and/or equipment damage.



ATTENTION ; This assembly contains parts that may be sensitive to static discharge. Static control precautions will be required if performing repairs, tests or servicing of this equipment otherwise component damage may result.



ATTENTION ; A product that has been incorrectly applied or installed could result in component damage and a reduction in product life. Malfunction of system may be as a result of wiring or application errors, such as incorrect or inadequate AC supply, excessive temperature or an undersized motor.

Safety Precautions

Read this manual and related documents before attempting to install, operate, service or inspect this inverter.

Make sure that you have an understanding of the device, the safety information and all precautions before starting use.

1. INSTALLATION



ATTENTION

Install the unit on a non-combustible material such as metal.

Installing it on other material could lead to fires.

Do not place the unit near flammable materials.

Doing so could lead to fires.

Do not hold by the terminal cover during transportation.

Doing so could cause the unit to drop and lead to injuries.

Do not allow foreign matter such as metal swarf enter the unit.

Entry of this type of matter could lead to fires.

Install the unit according to the instruction manual on a place where the weight can be withstood.

Failure to do so could lead to dropping of the unit and to injuries.

Do not install or operate an inverter that is damaged or missing parts.

Doing so could lead to injuries.

CE Mark Conditions

VF-0 inverter meets overvoltage category II of the standard EN50178.

The inverter should be supplied with power from mains via a transformer with at least basic insulation.

The complete machine has to comply to overvoltage category III of the standard EN50178.

This inverter is not a self-contained operating unit according to the EMC directive. Only after integrating the inverter into a machine including filters can the complete system be evaluated with respect to electromagnetic compatibility.

2. WIRING



ATTENTION

Always confirm that the input power is OFF before starting wiring.

Failure to do so could lead to electric shocks or fires.

Always connect the earth.

Failure to do so could lead to electric shocks or fires.

Wiring work must be carried out by a qualified technician.

Failure to do so could lead to electric shocks or fires.

Always install the unit before wiring.

Failure to do so could lead to electric shocks or fire.



ATTENTION

Do not connect an AC power supply to the output terminals (U, V, W).

Doing so could lead to injuries or fire.

Confirm that the product's rated voltage and the AC power supply voltage match.

Failure to do so could lead to injuries or fire.

Tighten the terminal screws to the designated tightening torque.

Failure to do so could lead to fire.

3. OPERATION



ATTENTION

Always close the terminal cover before turning the input power ON. Do not open the terminal cover while the power is ON.
Doing so could lead to electric shock.

Do not operate the switches with wet hands.
Doing so could lead to electric shock.

Do not touch the inverter terminals when the inverter power is ON or even when the inverter is stopped.
Doing so could lead to electric shock.

The STOP button is not designed for emergency stop purposes. Prepare a separate emergency stop button.
Failure to do so could lead to injury.

Depending on the start mode and ride-through function settings, if the run signal is on and the power is turned ON or the power is restored after a power failure, the unit may start (restart) suddenly. Bear this in mind before conducting maintenance.
(Design the machine so that personal safety can be ensured even if the unit starts suddenly.)
Failure to do so could lead to injury.

Depending on the start mode function setting, if the fault trip is reset with the run signal present, the unit may restart suddenly.
(Reset the trip after ensuring personal safety.)
Failure to do so could lead to injury.

When the retry function is used, the unit may automatically start (restart) suddenly so do not approach the unit.
(Secure personal safety before using this function.)
Failure to do so could lead to injury



ATTENTION

The heat sink fins and brake resistor (dedicated option) can reach high temperatures, so allow to cool before touching.

Doing so could lead to burns.

The inverter can be easily set to run from low speeds to high speeds.

Confirm the tolerable range of the motor and machine before starting operation.

Failure to do so could lead to injury.

Prepare holding brakes when required.

Failure to do so could lead to injury.

4. MAINTENANCE, INSPECTION AND PART REPLACEMENT



ATTENTION

Wait at least five minutes after turning the input power OFF before starting inspections.

Failure to do so could lead to electric shock.

Maintenance, inspection and part replacement must be done by qualified persons.

[Remove all metal personal belongings (watches, bracelets, etc.) before starting the work.] (Use tools treated with insulation.)

Failure to do so could lead to electric shocks or injury.



ATTENTION

Have an electrician periodically tighten the terminal screws.

Loosening of the terminal screws could lead to overheating or fire.

5. OTHERS



ATTENTION

Never modify the unit.
Doing so could lead to electric shock or injury.

General Precautions

All diagrams in this instruction manual show the state with the cover or safety partitions removed to explain the details. Before operating the product, replace the covers and partitions to the positions specified, and operate the unit according to the instruction manual.

Contents

Points for Handing	9
Special Precautions	10
Installation	12
Outline Dimensions	13
Parts Identification	14
Main Circuit Wiring	17
Control Circuit Wiring	20
Basic Operation	22
Function of each mode	30
Setting and Changing Functions	31
Functional Descriptions (Parameter Table)	34
Functional Descriptions (By Parameter)	37
To Effectively Use the Inverter (contents)	64
Changing from Local Control to External Control	65
Changing and Setting the Maximum Output Frequency.....	66
Boosting Torque at Low Speeds	67
Supplementary Explanation for Multi-function Terminal	
Input.....	68
0V Stop Function	73
Resetting Fault Trips.....	73
Individual Details and Remedies for Fault Trips.....	74
Troubleshooting (1)	76
Troubleshooting (2)	78
Maintenance and Inspection	79
Specifications	83

Points for Handling

Follow this manual and precautions when handling this unit. Incorrect handling could lead to inhibited operation or a drop operating life. In the worst case, the inverter could be damaged.



Power supply

Use within +10%, -15% of the tolerable input voltage range, and within $\pm 5\%$ of the tolerable input frequency range.



Circuit breaker (MCCB)

Size a breaker from the selection table on page 19.

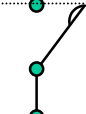

Magnet contactor (MC)

A magnetic contactor is not required in normal use. If installed, do not start or stop the inverter with the magnet contactor.

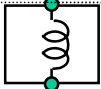

Power factor improvement reactor

Connect this when the power factor must be improved. (Option for input side)

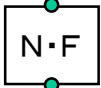

Input noise filter

Connect this when noise to the peripheral devices is a problem. (Option for input side)

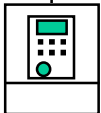

Inverter

The ambient temperature is a particularly important factor for the installation site. Make sure that the tolerable value is not exceeded. (See page 10 to 12.)

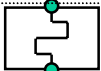

Thermal relay for open phase protection

The thermal relay built into the inverter is used to protect against overloads. Use an open phase protection thermal relay for open phase protection.

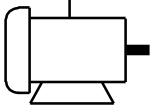

Motor

3-phase induction motor

Special Precautions

- ◆ **Use your inverter only within tolerable ambient temperature range. (–10°C to 50°C)**

Because the life of the inverter is greatly affected by ambient temperature, do not use it outside the specifications. Also, pay attention to the installation direction's and conditions. (See page 12.)

- ◆ **The inverter will be damaged if the power voltage is applied to its output terminal.**

Applying power voltage to the output terminal U, V or W will damage the inverter. Check for miswiring and operation sequence (commercial changeover circuit, etc.). Never apply a voltage that exceeds the tolerable voltage of the inverter.

- ◆ **Never touch the inside of the inverter during operation.**

This is extremely dangerous the inverter contains high-voltage circuit. Be sure to wait at least 5 minutes after the inverter power has been turned OFF, before making an internal check. Do not touch the heat sink fins or brake resistor during operation as these parts will become hot during operation.

- ◆ **Radio interference**

The main circuit of the inverter contains a higher harmonic component and may interfere with communications equipment such as AM radios if these are used nearby. The amount of radio interference depends on the field strength in the area where the inverter is used. While it is difficult to completely eliminate radio interference, it may be reduced by changing the angle of your radio antenna, using a noise filter with the inverter, housing the inverter in a metallic shield box, or routing inverter cables in metal conduit. (Please inquire separately.)

- ◆ **Do not attempt insulation testing between the inverter cables.**

To measure the insulation resistance of the power supply cables or the motor cables, disconnect them from the inverter. Never conduct insulation testing on the control circuits. However, insulation testing can be performed between the charging unit and the ground.

- ◆ **Do not connect a power factor capacitor or suppressor to the output terminal of the inverter.**

Such devices can damage the inverter, its capacitors and other parts. Remove the device if one is connected.

- ◆ **If a magnetic contactor is connected to the power supply side or the load side of the inverter, never use it to start or stop the motor (inverter).**

Switching the inverter on the power supply side ON and OFF frequently by a magnetic contactor, can cause the inverter to malfunction. Do not turn the inverter on the load side ON and OFF during operation as this causes inverter fault trips. Start or stop the motor only by means of inverter start input signals.

- ◆ **Do not use this inverter for loads other than a motor or for single-phase motors.**

- ◆ **Precautions regarding inverter's protection function**

Various protection functions, such as stall prevention, current limiting and overcurrent protection, are incorporated in the inverter.

These protection functions are used to protect the inverter from unexpected faults that could occur during use of the inverter, and are not the control functions normally used.

Thus, during normal usage, avoid applications that activate these protection functions.

Depending on the state, the inverter life could drop, or damage could occur. Before using the inverter, measure the output current, etc., with a measuring instrument, and check the details of the fault trip memory. Make sure that there are no problems in respect to the all precautions listed in this instruction manual, including those above, and in respect to the product specifications.

- ◆ **The CE Mark attached to the inverter complies with the Low Voltage Directive.**

- ◆ **Measure the electromagnetic compatibility (EMC) in the state assembled in the machine.**

- ◆ **Only basic insulation (Protection against Electric Shock Class I, Overvoltage category II, Pollution degree 2) is provided on the control circuit terminals.**

The supplementary insulation must be provided on the final product to comply with CE Marking requirements.

- ◆ **Make sure to ground the supply neutral.**

- ◆ **Always connect protective devices such as fuses for overcurrent, short circuits and leakage protection to the power supply input.**

- ◆ **Always use a ring crimp terminal for the main circuit wiring (R/L1, S/L2, T/L3, U, V, W).**

- ◆ **Only for machinery with fixed connection.**

Installation

ATTENTION

Install the unit on a non-combustible material such as metal.

Installing it on other material could lead to fire.

Do not place the unit near flammable materials.

Failure to do so could lead to fire.

Do not hold the terminal cover during transportation.

Failure to do so could cause the unit to drop and lead to injuries.

Do not allow foreign matter such as metal swarf enter the unit.

Entry of this type of matter could lead to fire.

Mount the unit according to the instruction manual in a place where the weight can be withstood.

Failure to do so could lead to dropping of the unit and to injuries.

Do not install or operate an inverter that is damaged or with parts missing.

Failure to do so could lead to injury.

[Install the inverter vertically.]

Installing the inverter in any other way decreases its heat dissipation effect and results in malfunction.

[Make sure the ambient temperature stays within the specification.]

The ambient temperature surrounding the inverter will increase when it is installed near a heating unit or housed inside a panel. This may reduce the life of the inverter. If you want to house the inverter inside a panel, give careful consideration to the cooling method and panel size.

Tolerable ambient temperature

-10°C to 50°C

Note) Ambient temperatures should be measured at a point 5 cm from the inverter.

Space around the inverter

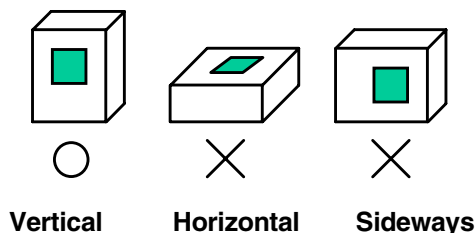
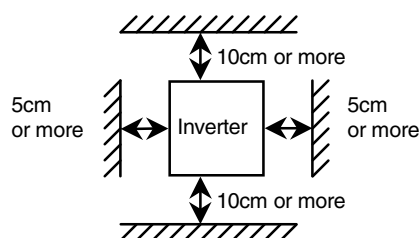

[Avoid installing the inverter in the following locations.]

Areas subject to direct sunlight.

Areas subject to water or high levels of humidity.

Areas with large amounts of oil mist, dust or fiber dust.

Areas where rain water, water drops or oil drops may come in contact.

Areas where corrosive gases, explosive gases or flammable gases are present.

Installation onto flammable materials such as wood, or near flammable materials.

Areas subject to vibration.

Outline Dimensions

4- ϕ 5 (Mounting holes)

Unit: mm

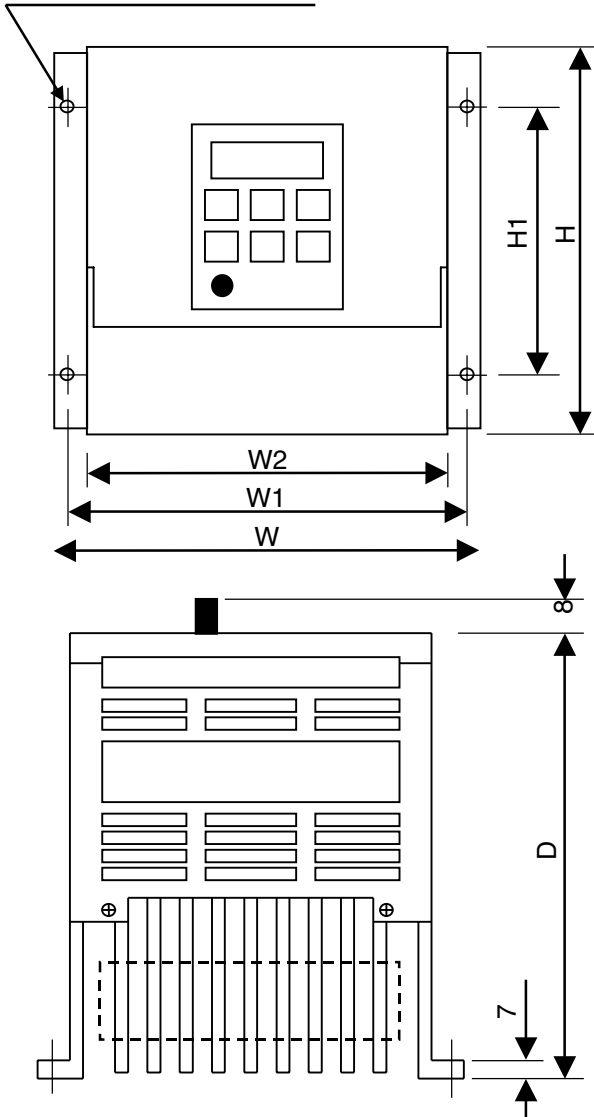

Note) The 1.5, 2.2 and 3.7kW capacities have a cooling fan at the broken line section shown on the left.

• 3-phase 400V input type

Unit: mm

Inverter capacity	W	W1	W2	H	H1	D
0.75kW	130	121	110	130	90	148
1.5, 2.2kW	130	121	110	130	90	161
3.7kW	160	151	140	130	90	161

Parts Identification

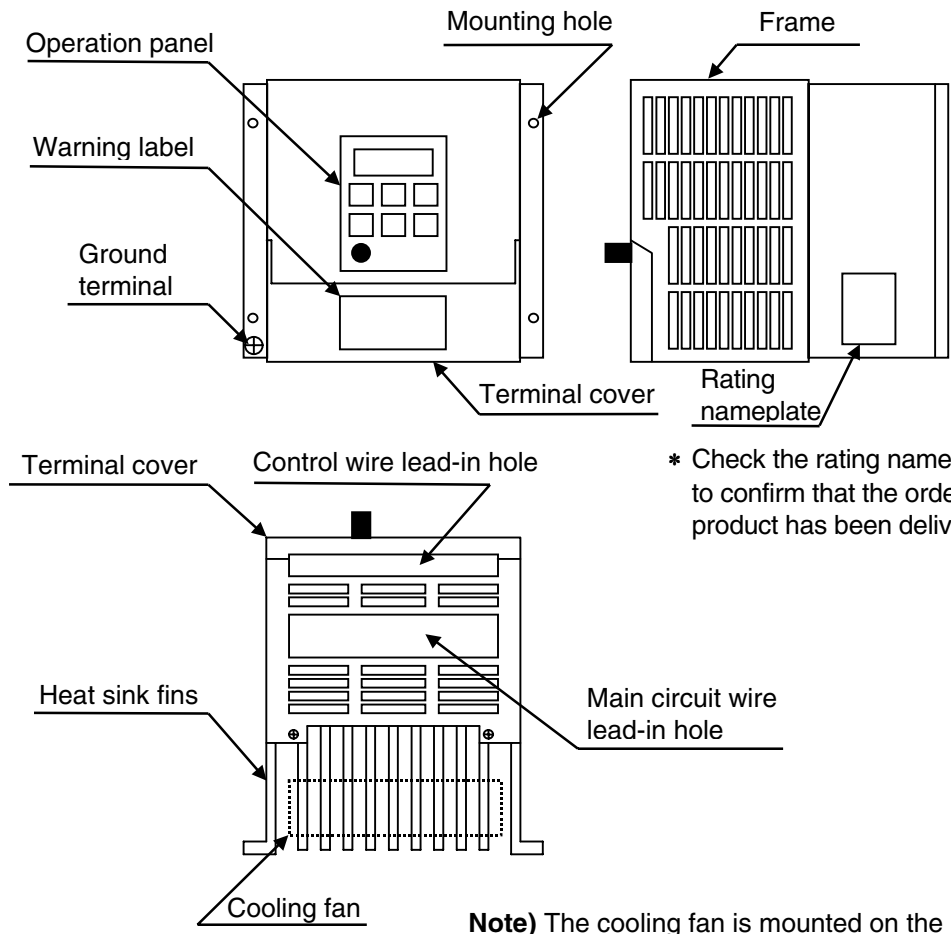

* Check the rating nameplate to confirm that the ordered product has been delivered.

Note) The cooling fan is mounted on the 1.5 to 3.7kW capacities. It is not mounted on the 0.75kW capacity.

Input power	Applicable motor capacity (kW)	Part No.	Brake
3-phase 400V	0.75	BFV00074	Only circuit built in (Brake resistor is an option)
	1.5	BFV00154	
	2.2	BFV00224	
	3.7	BFV00374	

Explanation of inside of terminal cover

Note) This explanatory drawing shows the state with the terminal cover removed. During normal use, do not remove the terminal cover.

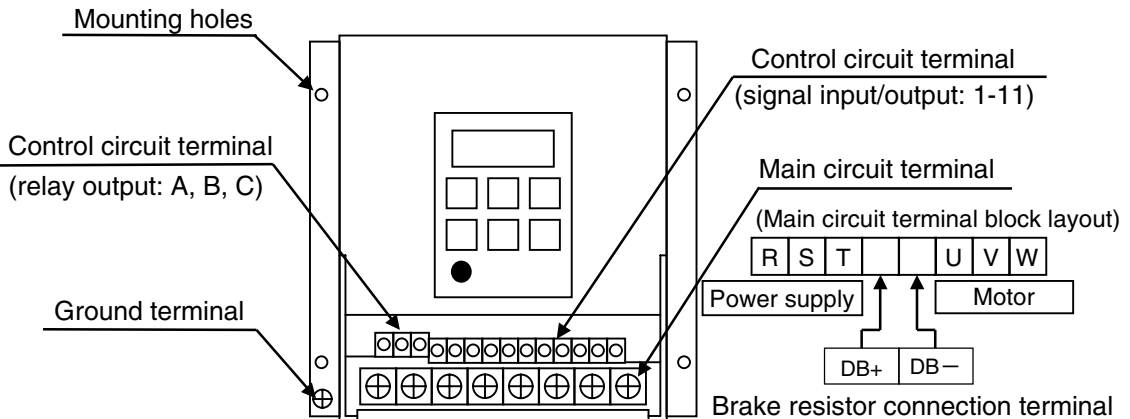

[Precautions for installation of brake resistor (option)]

- Wait at least 5 minutes after turning the power OFF before connecting the resistor. (There is a risk of electric shock.)
- Always securely connect the resistor to the metal plate with metal screws, etc. (There is a risk of fires.)
- Install the resistor at a position separated at least 5cm from the inverter edges and 10cm or more from the top. (Resistor cannot be installed at the bottom.)
- Note that the resistor will become very hot.

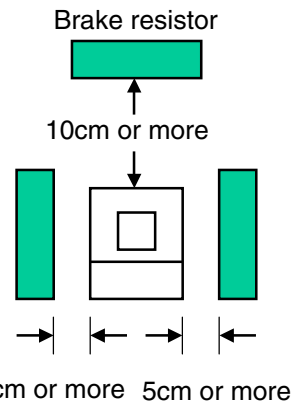

Opening and closing the terminal cover

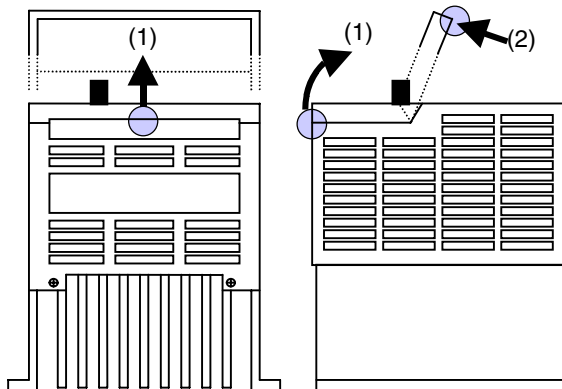

- (1) **Opening the terminal cover**
Lightly press up the center bottom edge of the terminal cover.
- (2) **Closing the terminal cover**
Lightly press down on the center top edge of the terminal cover.

Note) After closing the terminal cover, confirm that it is securely closed.

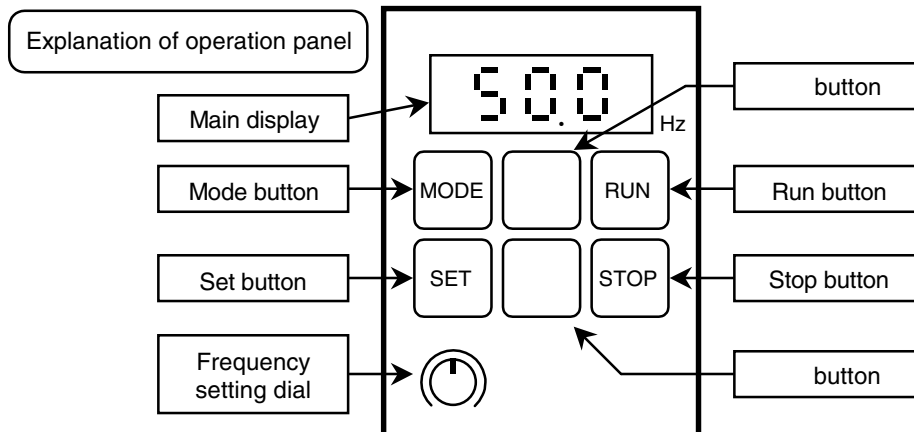

Main display	The output frequency, current, line speed, error details, data for function setting and parameter numbers are displayed.
Run button	This switch is used to start the inverter.
Stop button	This switch is used to stop the inverter.
Mode button	This switch is used to change to each "output frequency, current display", "frequency setting, monitor", "rotation direction setting" and "function setting" mode, and to switch the display from the data to mode display.
Set button	This switch is used to change the display between the parameter No. and data display, and to save the data. In the "output frequency, current display mode", this switch changes the display between the frequency and current.
(up) button	This switch is used to change the data and output frequency, and to set forward run direction when carrying out forward rotation with the operation panel.
(down) button	This switch is used to change the data and output frequency, and to set reverse run direction when carrying out reverse rotation with the operation panel.
Frequency setting dial	This is the dial for the potentiometer used to set the operating frequency with the operation panel.

[Handling when output current is displayed]

- 1) The displayed output current is not intended for precise measurement. Use this only as a guide value. (Use a separate measuring instrument when precise values are required.)
- 2) A relatively large value may be displayed especially at approx. 40% or less of the rated current. (For example, even if there is no output current, a certain level may be displayed. Note that when the inverter is stopped, "0A" will be displayed.)

Main Circuit Wiring



CAUTION

Always confirm that the input power is OFF before starting wiring.

Failure to do so could lead to electric shock or fire.

Always connect the ground wire.

Failure to do so could lead to electric shock or fire.

Wiring work must be carried out by a qualified technician.

Failure to do so could lead to electric shock or fire.

Always install the unit before wiring.

Failure to do so could lead to electric shock or injury.



ATTENTION

Do not connect an AC power supply to the output terminals (U, V, W).

Failure to do so could lead to injury or fire.

Confirm that the product's rated voltage and the AC power supply voltage match.

Failure to do so could lead to injury or fire.

Tighten the terminal screws to the designated tightening torque.

Failure to do so could lead to fire.

Precautions

Note the following points carefully to prevent miswiring and misuse of the inverter. (Devices may be broken.)

- 1) Connect the power supply to input terminals (R/L1, S/L2, T/L3) and the motor to output terminals (U, V, W).
- 2) Make sure to ground the supply neutral.
- 3) Do not connect anything other than the optional brake resistor across terminals DB+ and DB-. Never short these terminals to each other as this will damage the internal electronics of the inverter.
- 4) Use sleeved round crimp terminals for power supply and motor connections.
- 5) After wiring the main circuit, double check for tightness as access will be limited once control circuit wiring is in place.
- 6) When connecting directly to a large capacity power transformer (500kVA or more), always install a power factor improvement reactor (option) on the inverter's input side.
- 7) Select connected devices and wire size according to the table on page 19.

Wiring

Note: ⊕ Ground marking

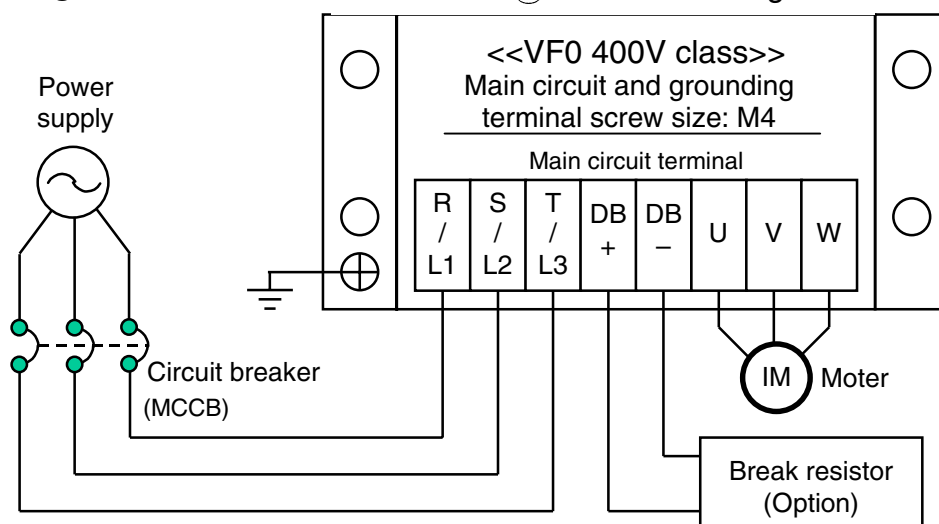

Always connect protective devices such as fuse for overcurrent, short circuits and leakage protection to the input.

<<Precautions for using regenerative brakes>>

- 1) When using the regenerative brakes, set the parameter P18 setting data to "0". The brakes will not operate when the default data "1" is set.
- 2) Always use the Matsushita-dedicated option for the brake resistor. Refer to the precautions on page 15 for installing the brake resistor, etc.
- 3) The regenerative brake specifications are shown below. Always consider the working conditions carefully before using.

Note that the inverter could be damaged if the specifications are exceeded during use.

- Maximum duty factor (%ED) : 2%
- Maximum working time : 3 seconds
- Maximum torque : 100%

■ **Connected device, wire size and main circuit terminal tightening torque**

Inverter capacity	Circuit breaker (MCCB)	Tightening torque	Wire size
0.75 kW	5A	1.2 N·m (12.2 kgf·cm)	2mm ² (14AWG)
1.5 kW	10A		
2.2 kW	15A		
3.7 kW	20A		

Note 1) If the breaker's overcurrent trip is a magnetic type, the device could overheat due to higher harmonics. Use a load rate of 50% or less in this case.

Note 2) When using an installed circuit breaker with motor protection, remove it.

Note 3) Crimp connectors used must be ring terminals.

Control Circuit Wiring

Wiring * Only basic insulation (Protection against Electric Shock Class I, Overvoltage category II, Pollution degree 2) is provided on the control circuit terminals. The supplementary insulation must be provided on the final product to comply with CE Marking requirements.

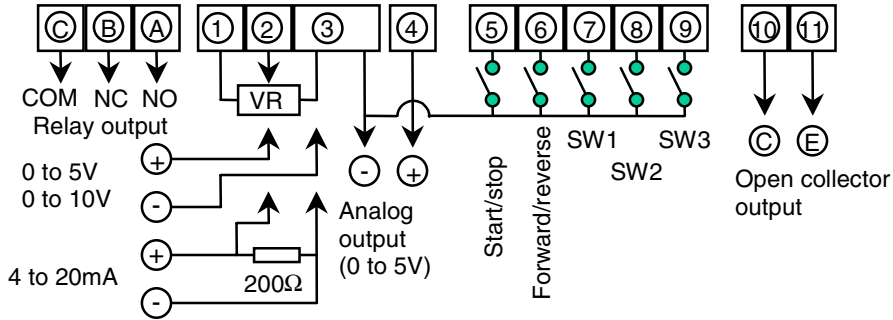

- ◆ Terminal specifications: "Screw size: M3 (minus screw)"
"Tightening torque: 0.5 to 0.6N·m"
- ◆ Frequency setting potentiometer (VR) specifications: "10kΩ, 1/4W or more potentiometer"
- ◆ Relay output contact specifications: 1c no-voltage contact, 250VAC, 0.5A (resistance load)
- ◆ Open collector output specifications: Maximum rating 50VDC, 50mA

Note 1) When using a 4 to 20mA signal for the frequency setting, always connect a 200Ω, 1/4W resistor. (The inverter could be damaged if the resistor is not connected.)

Note 2) Always read each function explanation for the parameters related to each terminal before starting use.

Terminal No.	Terminal function	Related parameter No.
①	Frequency setting potentiometer connection terminal (+5V)	P09
②	Frequency setting analog signal input terminal	P09
③	Common terminal for ①, ②, ④ to ⑨ signals	
④	Multi-function analog signal output terminal (0 to 5V/PWM)	P58, P59
⑤	Start/stop, forward run signal input terminal	P08
⑥	Forward/reverse, reverse run signal input terminal	P08
⑦	Multi-function control signal SW1 input terminal	P19, P20, P21
⑧	Multi-function control signal SW2 input terminal Frequency setting signal changeover input terminal	P19 to P21 P22 to P24
⑨	Multi-function control signal SW3 input terminal PWM signal input terminal	P19 to P21 P22 to P24
⑩	Open collector output terminal (C: collector)	P25
⑪	Open collector output terminal (E: emitter)	P25
A	Relay contact output terminal (NO: at factory setting)	P26
B	Relay contact output terminal (NC: at factory setting)	P26
C	Relay contact output terminal (COM)	P26

- ◆ By using terminals No. 8 and 9, the output frequency can be controlled with the PWM signal.
 - No. 8: Frequency setting signal changeover input terminal (SW2) (OFF: PWM signal, ON: controlled with signal set in parameter P09)
 - No. 9: PWM signal input terminal

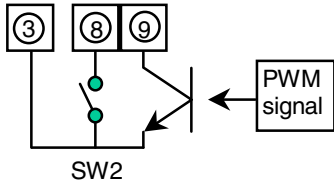

Note 1) When controlling the output frequency with the PWM signal, parameters P22, P23 and P24 must be set.

Note 2) Use a PWM signal transistor (Tr) that has the following capabilities:

- Maximum rated voltage : 50VDC or more
- Rated current : 50mA or more

Precautions

1. Use shielded wires for all control signal wires and keep them more than 20 cm from power wiring.
2. Maximum control signal wire length is 30m or less.
3. The control circuit's input signal is a minute signal, so use two minute signal contacts in parallel or use a twin contact to prevent contact faults when inputting the contact.
4. No-voltage contact signal or open-collector outputs signal should be used with control terminals No. 5 to 9.
(If a voltage signal is applied across these terminals, the internal electronics may be damaged.)
 - * Input circuit specifications are shown below. Take special care to avoid loop or leakage current.
5. When an inductive load is to be driven by an open-collector output, be sure to use a freewheel diode.

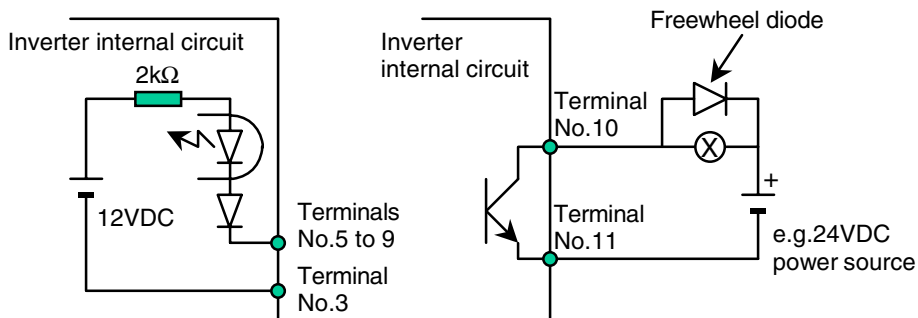

Basic Operation



CAUTION

Always close the terminal cover before turning the input power ON.

Do not open the terminal cover while the power is ON.

Failure to do so could lead to electric shock.

Do not operate the switches or dials with wet hands.

Failure to do so could lead to electric shock.

Do not touch the inverter terminals when the inverter power is ON or even when the inverter is stopped.

Failure to do so could lead to electric shock.

The STOP button is not designed for emergency stop purposes. Prepare a separate emergency stop button.

Failure to do so could lead to injury.



ATTENTION

The heat sink fins and brake resistor (dedicated option) can reach high temperatures, so do not touch them.

Failure to do so could lead to burns.

The inverter can be easily set to run from low speeds to high speeds. Confirm the tolerable speed range of the motor and machine before starting operation.

Failure to do so could lead to injury.

Prepare holding brakes when required.

Failure to do so could lead to injury.

Before turning power ON, check the following points again.

1) Check that all wiring is correct.

Reversed wiring between the power supply and the load, in particular, can result in damage to the inverter.

2) Make sure the inverter rating and power supply voltages match each other.

3) Make sure no power factor capacitor is connected to the motor, as it can damage the inverter.

4) Before starting a trial run, check the set frequency.

Setting the frequency and forward/reverse run operation with the operation panel

There are two methods for setting the frequency and carrying out forward/reverse run operation with the operation panel.

- Frequency setting: "Potentiometer setting method",
"Digital setting method"
- Forward/reverse run operation: "Forward run/reverse run method",
"Start/ stop, rotation direction mode setting method"

1. Setting the frequency

1) Potentiometer setting method (Parameter P09 set to "0": Factory setting)
Set with the rotation angle of the frequency setting dial on the panel. The operation will stop at the Min. position (0V stop: refer to page 73), and the maximum frequency will be attained at the Max. position.

2) Digital setting method (Parameter P09 set to "1")
Press the MODE button on the panel to enter the frequency setting mode (Fr). Press the SET button, set the frequency to be set with the ▲ (up) button and ▼ (down) button, and then press the SET button to enter the data.

The frequency can be changed by holding down the ▲ (up) button and ▼ (down) button during operation. (Hereafter, this function is called the MOP function.)

This MOP function cannot be used when parameter P08 is set to "1".

2. Forward/reverse run operation

- 1) Forward run/reverse run method (Parameter P08 set to "1")
Press the ▲ button (forward run) or ▼ button (reverse run) on the panel to select the rotation direction. Operation will start when the RUN button is pressed, and will stop when the STOP button is pressed.
 - * The inverter will not start running just by pressing the RUN button.
 - * The MOP function cannot be used if the frequency is set with the digital method.
- 2) Start/stop, rotation direction mode setting method (Parameter P08 set to "0")
First, press the MODE button twice to enter the rotation direction setting mode. Press the SET button to display the rotation direction data, change the rotation direction with the ▲ (up) button and ▼ (down) button, and then press the SET button to enter the data. (Forward run is set as the factory setting.)
Operation will start when the RUN button is pressed, and will stop when the STOP button is pressed.

3. Combination of "MOP function", "rotation direction setting mode", and forward/reverse run operation

Forward/reverse run operation	MOP function	Details of rotation direction setting mode
Forward run/reverse run method	× (Cannot be used)	Only monitor function
Start/stop, rotation direction mode setting method	○ (Can be used)	Monitor function and direction setting

Note) When the forward/reverse run operation is set to "forward run/reverse run method", the MOP function cannot be used even if the frequency is set with the digital method.

Operating with the operation panel - 1 (Factory setting state)

- Forward/reverse run operation:
Start/stop, rotation direction mode setting
(Parameter P08=0)
- Frequency setting: Potentiometer setting (Parameter P09=0)

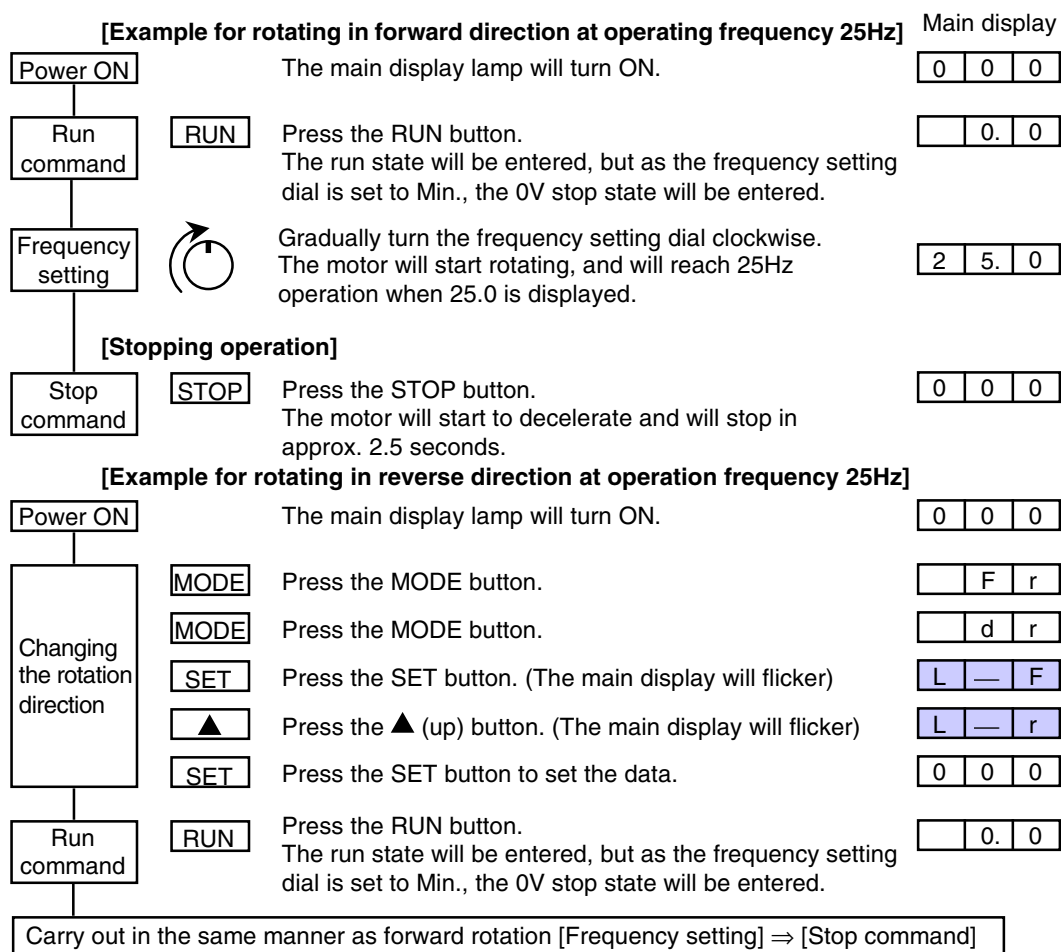

[Changing the rotation direction during operation]

Use the same procedures as [Changing the rotation direction] explained above.

In this case, when the SET button is pressed last the display will change to the output frequency display, the motor will decelerate and then will start rotating in the reverse direction.

Operating with the operation panel - 2

- Forward/reverse run operation: Forward run/reverse run (Parameter P08=1)
- Frequency setting: Potentiometer setting (Parameter P09=0)

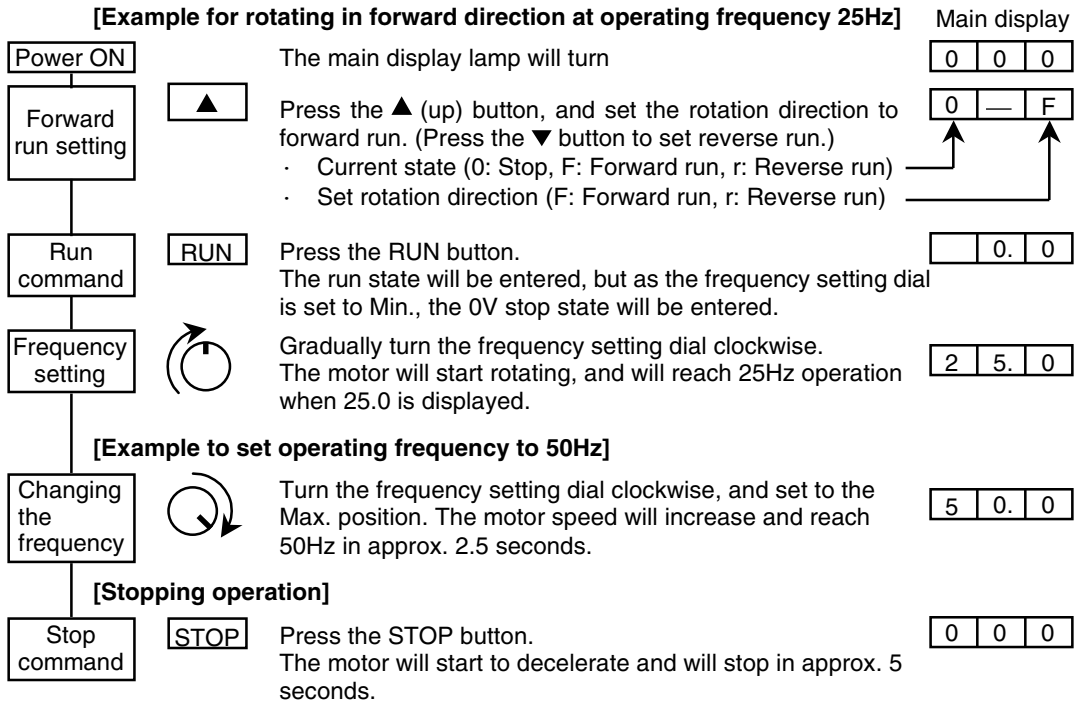

[Monitoring and setting the potentiometer frequency command before operation]

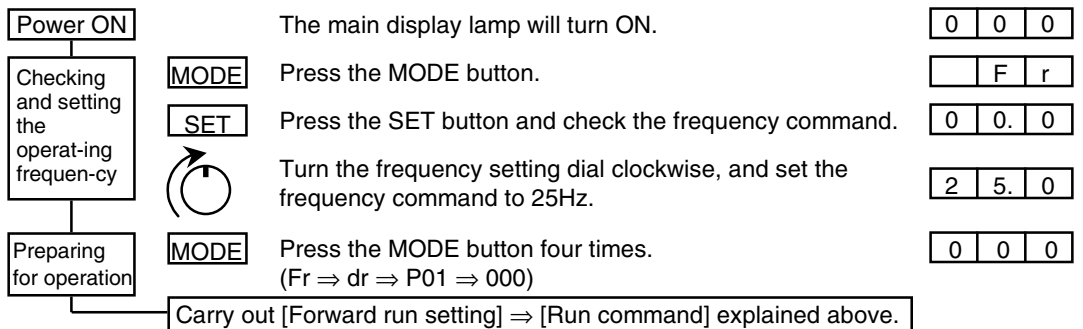

[Continued from previous page, Example to rotate in reverse at operating frequency 50Hz]

Reverse run setting  Press the ▼ (down) button, and set the rotation direction to reverse run.

- Current state (0: Stop)
- Set rotation direction (r: Reverse run)

Main display

0	—	r
---	---	---

Run command  Press the RUN button.
 As the frequency setting dial is at the Max. position, the motor will start rotating and will reach 50Hz in approx. 5 seconds.

Main display

5	0.	0
---	----	---

[Example to rotate in reverse at operating frequency 25Hz]

Changing the frequency  Gradually turn the frequency setting dial counterclockwise. The motor will gradually decelerate, and the motor will attain 25Hz operation when 25.0 is displayed.

Main display

2	5.	0
---	----	---

[Example to change from reverse run to forward run during operation]

Forward run setting  Press the ▲ (up) button, and set the rotation direction to forward run.

- Current state (r: Reverse run)
- Set rotation direction (F: Forward run)

Main display

r	—	F
---	---	---

Run command  Press the RUN button.
 The motor will gradually decelerate, and will start forward rotation at 25Hz again.

Main display

2	5.	0
---	----	---

 Reverse run

	0.	0
--	----	---

 Forward run

2	5.	0
---	----	---

[Stopping operation]

Stop command  Press the STOP button.
 The motor will start to decelerate and will stop in approx. 2.5 seconds.

Main display

0	0	0
---	---	---

[Canceling the rotation direction setting]

After setting with the ▲ and ▼ buttons, the rotation direction can be canceled by pressing the same button again.

★ **Example:** When rotating in forward direction at 25Hz

Main display

2	5.	0
---	----	---

Reverse run setting  Press the ▼ (down) button, and set the rotation direction to reverse run.

Canceling the setting  When the ▼ (down) button is pressed, the display will change from the rotation direction to the frequency display, and the rotation direction setting will be canceled.

Main display

F	—	r
---	---	---

F	—	r
---	---	---



2	5.	0
---	----	---

- Note 1)** The setting can be canceled with the same procedure even when stopped.
- Note 2)** If the RUN button is not pressed after setting the rotation direction, the rotation direction will not change.

Operating with the operation panel - 3

- Forward/reverse run operation:
Start/stop, rotation direction mode setting
(Parameter P08=0)
- Frequency setting: Digital setting (Parameter P09=1)

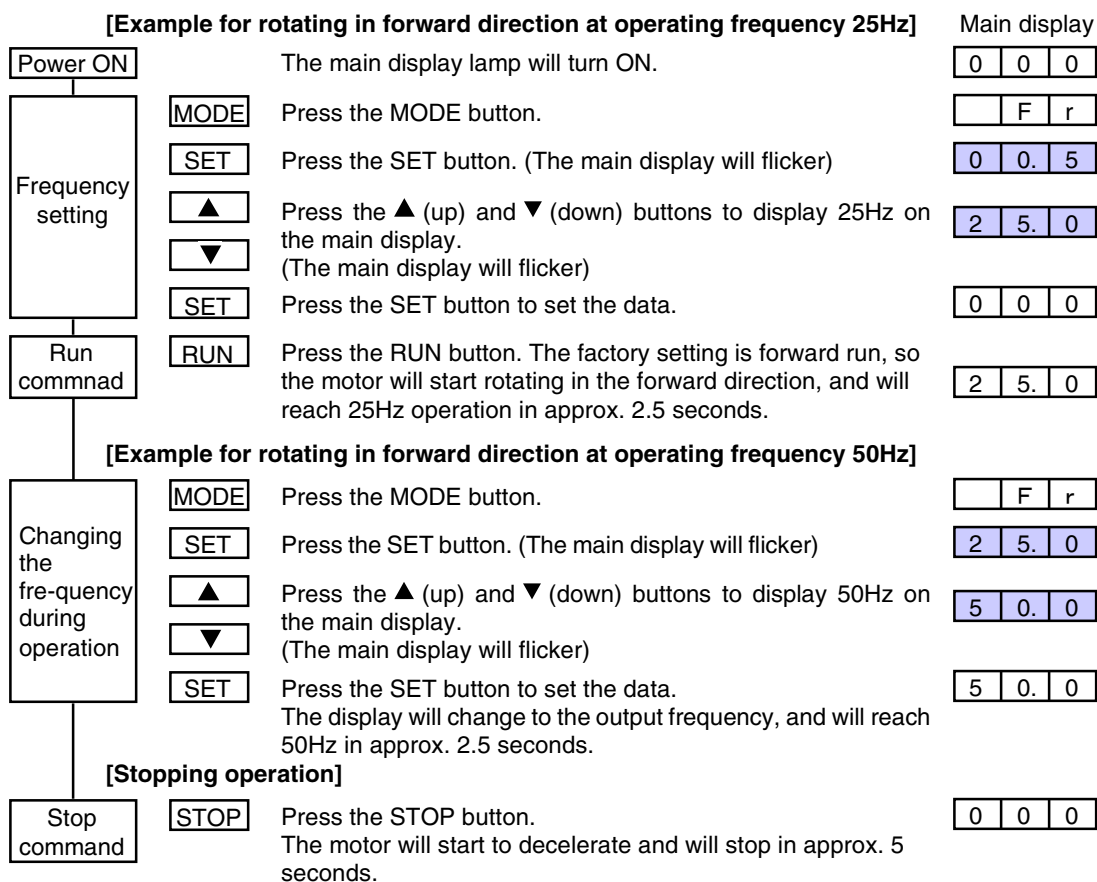

[Changing the frequency with the ▲ and ▼ buttons during operation (MOP function)]

The operating frequency can be changed with the ▲ and ▼ buttons during operation.

- If the ▲ (up) button is held down, the operating frequency will increase.
- If the ▼ (down) button is held down, the operating frequency will decrease.

Note) Once the operating frequency is determined, press the MODE button and then press the SET button twice to set the operating frequency.

If this is not carried out, this frequency will not be saved when the power is turned OFF.

[Continued from previous page, Example to rotate in reverse at operating frequency 50Hz]

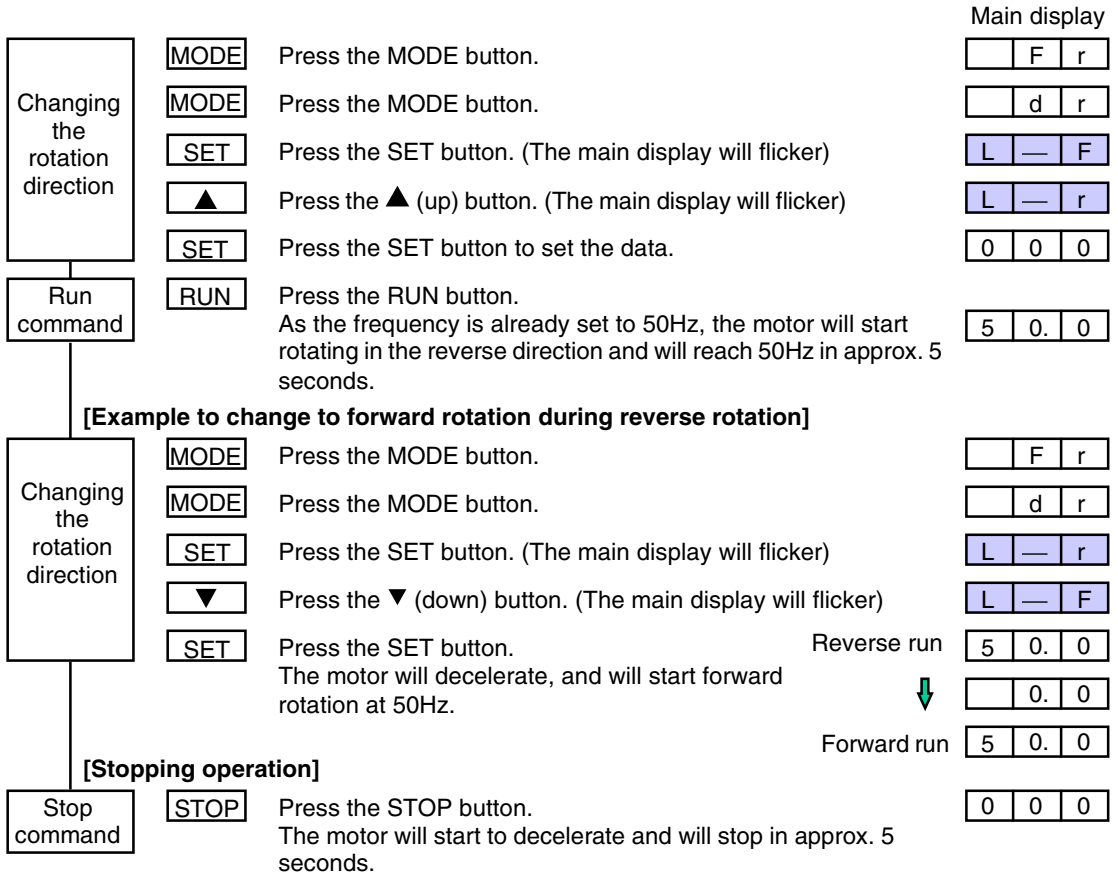

Operating with the operation panel - 4

- Forward/reverse run operation: Forward run/reverse run (Parameter P08=1)
- Frequency setting: Digital setting (Parameter P09=1)

1. Carry out the same operation as "Operating with the operation panel - 2" for forward run/reverse run, stopping.
2. Carry out the same operations as "Operating with the operation panel - 3" to set and change the frequency.

Note 1) The rotation direction cannot be set with the "rotation direction setting mode (dr)" in this Operating with the operation panel - 4. In the "rotation direction setting mode (dr)", only the rotation direction and local/external operation control state can be monitored.

Note 2) The MOP function cannot be used with this Operating with the operation panel - 4.

Function of Each Mode

The VF0 has the following four modes.

- (1) Output frequency, current display mode, (2) Frequency setting, monitor mode, (3) Rotation direction setting mode, (4) Function setting mode

Normally, use in the output frequency, current display mode.

This mode is entered when the power is turned ON.

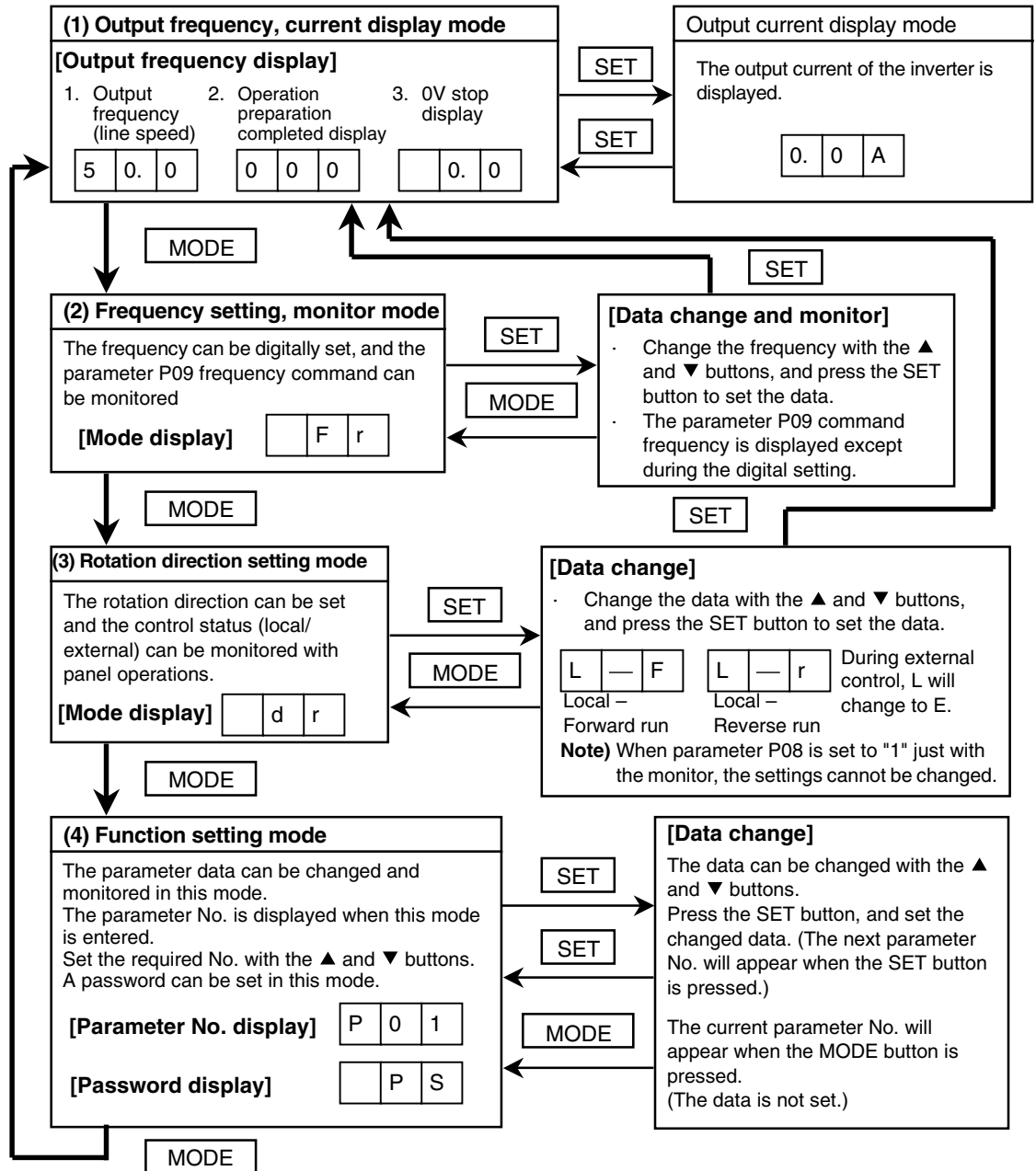

Setting and Changing Functions

Various function data can be changed and set when the operation is stopped. Note that some functions can be changed during operation. (See page 32.)

Setting functions when operation is stopped.

[Setting example: Change the maximum frequency from 50Hz to 60Hz]

(Changing the parameter P03 data from "50" to "60")

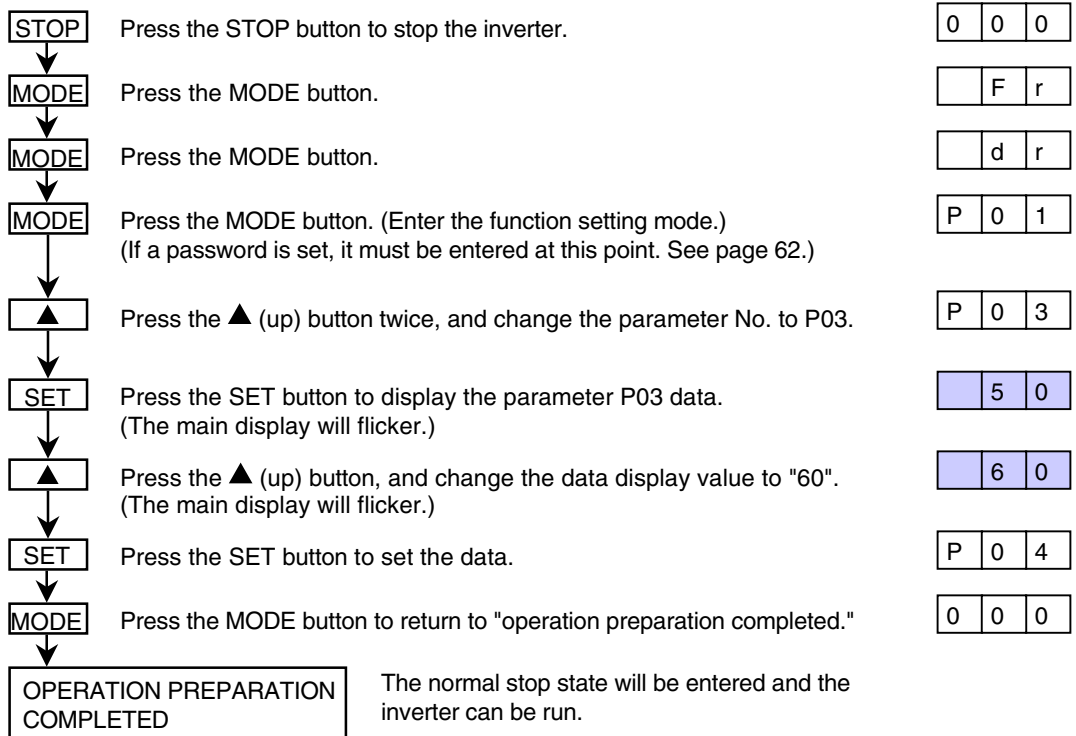

[Setting precautions]

1. After the function is set, the inverter will not run unless the MODE button is pressed and the "operation preparation completed" state is returned to.
2. If the function setting returns to the "operation preparation completed" state during data changing, while a start input signal is being applied through external control, an "OP" error will be displayed, causing the inverter to remain inoperative.
 - * Reset the fault indication using the instructions under "Resetting Fault Trips" on page 73.
3. The set data will be stored in the memory even after the power supply has been turned OFF.

Setting functions during operation



CAUTION

The motor and motor load fluctuation could change significantly and the motor may suddenly start or stop when data is being changed during operation. (Before making changes, ensure personal safety at all times.) Failure to do so could lead to injury.

[Parameters that can be changed during operation]

- Parameter P01, P02 : 1st acceleration/deceleration time
- Parameter P05, P42 : Torque boost level/2nd torque Boost level
- Parameter P29 to P31 : Jog frequency, acceleration/deceleration time
- Parameter P32 to P38 : Preset frequency 2 to 8
- Parameter P39, P40 : 2nd acceleration/deceleration time
- Parameter P56, P57 : Bias/Gain frequency
- Parameter P59 : Analog, PWM output compensation
- Parameter P61 : Line speed multiplier
- Parameter P64 : Carrier frequency

Note) 0V stop may occur if the "preset frequency 2 to 8 is set to 000", the "bias frequency is set to 0Hz or less" or the "gain frequency is set to 000".
(When changing the above data or changing to the above data, the motor will start and stop simultaneously with the setting of the data, so always ensure surrounding safety.)

[Setting example: To change torque boost level from 5 (%) to 15 (%)]

Operation state (for 50Hz operation)

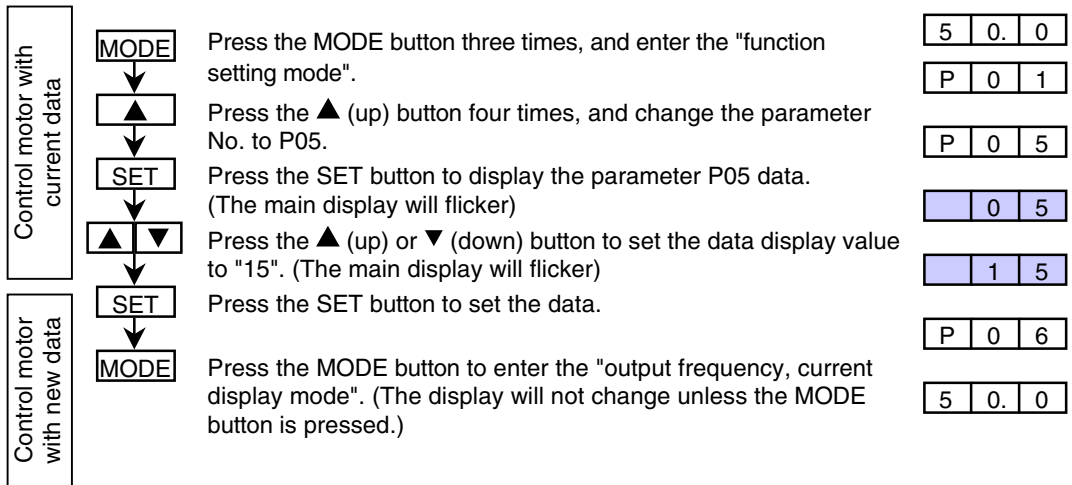

[Setting precautions]

1. During operation, the parameters other than those that can be changed will show data, but the data cannot be changed.
2. If a stop signal is input while changing the data and the inverter stops, the "operation preparation completed" state will be returned to.
3. If the inverter stops at 0V while the data is being changed, the function setting will be returned to the "0V stop state".
4. If the inverter starts operation while the data is being changed in the "0V stop state", the "output frequency, current display mode" will be returned to.

Functional Descriptions (Parameter Table)

No.	Parameter name	Setting range	Factory setting data
P01	1ST ACCELERATION TIME (sec)	0•0.1 to 999	05.0
P02	1ST DECELERATION TIME (sec)	0•0.1 to 999	05.0
P03	FREQUENCY RANGE (V/F PATTERN)	50•60•FF	50
P04	V/F CURVE	0•1	0
P05	TORQUE BOOST LEVEL (%)	0 to 40	04
P06	OVERLOAD FUNCTION	0•1•2•3	2
P07	OVERLOAD CURRENT (A)	0.1 to 100	*
P08	LOCAL/EXTERNAL CONTROL	0 to 5	0
P09	LOCAL/EXTERNAL FREQUENCY	0 to 5	0
P10	REVERSE LOCKOUT	0•1	0
P11	STOP MODE SELECT	0•1	0
P12	STOP FREQUENCY (Hz)	0.5 to 60	00.5
P13	DC BRAKE TIME (sec)	0•0.1 to 120	000
P14	DC BRAKE LEVEL	0 to 100	00
P15	MAX. OUTPUT FREQUENCY (Hz)	50 to 250	50.0
P16	BASE FREQUENCY (Hz)	45 to 250	50.0
P17	ACCELERATION FREQUENCY HOLD	0•1	1
P18	DECELERATION FREQUENCY HOLD	0•1	1
P19	SW1 FUNCTION SELECT	0 to 7	0
P20	SW2 FUNCTION SELECT	0 to 7	0
P21	SW3 FUNCTION SELECT	0 to 8	0
P22	PWM CONTROL FUNCTION SELECT	0•1	0
P23	PWM SIGNAL AVERAGING	1 to 100	01
P24	PWM SIGNAL CYCLE (ms)	1 to 999	01.0
P25	OUTPUT TR FUNCTION SELECT	0 to 7	0
P26	OUTPUT RY FUNCTION SELECT	0 to 6	5
P27	DETECT FREQUENCY (OUTPUT TR)	0•0.5 to 250	00.5
P28	DETECT FREQUENCY (OUTPUT RY)	0•0.5 to 250	00.5
P29	JOG FREQUENCY (Hz)	0.5 to 250	10.0
P30	JOG ACCELERATION TIME (sec)	0•0.1 to 999	05.0
P31	JOG DECELERATION TIME (sec)	0•0.1 to 999	05.0
P32	PRESET FREQUENCY 2 (Hz)	0•0.5 to 250	20.00

No.	Parameter name	Setting range	Factory setting data
P33	PRESET FREQUENCY 3 (Hz)	0•0.5 to 250	30.0
P34	PRESET FREQUENCY 4 (Hz)	0•0.5 to 250	40.0
P35	PRESET FREQUENCY 5 (Hz)	0•0.5 to 250	15.0
P36	PRESET FREQUENCY 6 (Hz)	0•0.5 to 250	25.0
P37	PRESET FREQUENCY 7 (Hz)	0•0.5 to 250	35.0
P38	PRESET FREQUENCY 8 (Hz)	0•0.5 to 250	45.0
P39	2ND ACCELERATION TIME (sec)	0.1 to 999	05.0
P40	2ND DECELERATION TIME (sec)	0.1 to 999	05.0
P41	2ND BASE FREQUENCY (Hz)	45 to 250	50.0
P42	2ND TORQUE BOOST LEVEL (%)	0 to 40	04
P43	SKIP FREQUENCY 1 (Hz)	0•0.5 to 250	000
P44	SKIP FREQUENCY 2 (Hz)	0•0.5 to 250	000
P45	SKIP FREQUENCY 3 (Hz)	0•0.5 to 250	000
P46	SKIP FREQUENCY BAND WIDTH (Hz)	0 to 10	0
P47	CURRENT LIMIT FUNCTION (sec)	0•0.1 to 9.9	00
P48	POWER LOSS START MODE	0•1•2•3	1
P49	INSTANTANEOUS POWER FAILURE RESTART SELECT	0•1•2	0
P50	WAIT TIME (sec)	0.1 to 100	00.1
P51	RETRY FUNCTION SELECT	0•1•2•3	0
P52	NO. OF RETRIES	1 to 10	1
P53	LOWER FREQUENCY CLAMP (Hz)	0.5 to 250	00.5
P54	UPPER FREQUENCY CLAMP (Hz)	0.5 to 250	250
P55	BIAS/GAIN FUNCTION SELECT	0•1	0
P56	BIAS FREQUENCY (Hz)	-99 to 250	00.0
P57	GAIN FREQUENCY (Hz)	0•0.5 to 250	50
P58	ANALOG/PWM OUTPUT FUNCTION SELECT	0•1	0
P59	ANALOG/PWM OUTPUT COMPENSATION (%)	75 to 125	100
P60	MONITOR SELECT	0•1	0
P61	LINE SPEED MULTIPLIER	0.1 to 100	03.0
P62	MAX. OUTPUT VOLTAGE (V)	0•1 to 500	000
P63	OCS LEVEL (%)	1 to 200	140
P64	CARRIER FREQUENCY (kHz)	0.8 to 10	1.6

No.	Parameter name	Setting range	Factory setting data
P65	PASSWORD	0•1 to 999	000
P66	DATA SETTING CLEAR	0•1	0
P67	FAULT DISPLAY 1	Latest	Refer to page 74.
P68	FAULT DISPLAY 2	Previous	
P69	FAULT DISPLAY 3	Second to latest	
P70	FAULT DISPLAY 4	Third to latest	

Note 1) The asterisk * indicates the inverter's rated current.

Note 2) The star mark indicates parameters that can be changed during operation.

Functional Descriptions (By Parameter)

1st ACCELERATION TIME (Parameter P01)

Used to set the time to accelerate to the maximum output frequency from 0.5Hz.

Data setting range (sec)	0.04 • 0.1 to 999
Setting unit (sec)	0.1 (0.1 to 100) 1 (100 to 999)

The display code for 0.04 sec. is "000".

The maximum output frequency is set with parameters P03 and P15.

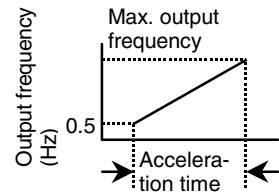

1st DECELERATION TIME (Parameter P02)

Used to set the time to decelerate from the maximum output frequency to 0.5Hz.

Data setting range (sec)	0.04 • 0.1 to 999
Setting unit (sec)	0.1 (0.1 to 100) 1 (100 to 999)

The display code for 0.04 sec. is "000".

The maximum output frequency is set with parameters P03 and P15.

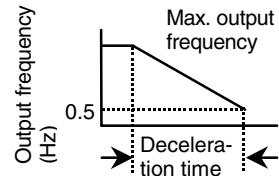

FREQUENCY RANGE (V/F PATTERN) (Parameter P03)

A frequency range of 50/60Hz or 50 to 250Hz can be set independently from the maximum output frequency (50 to 250Hz).

Data setting value	Name	Remarks
50	50Hz mode	The frequency range is set regardless of the parameter P15 and P16 settings.
60	60Hz mode	
FF	Free mode	The frequency range is set according to the parameter P15 and P16 settings. The maximum output frequency is set in parameter P15 and the base frequency is set in parameter P16.

[50Hz mode]

- Max. output frequency = 50Hz
- Base frequency = 50Hz

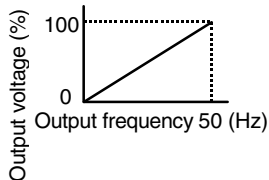

[60Hz mode]

- Max. output frequency = 60Hz
- Base frequency = 60Hz

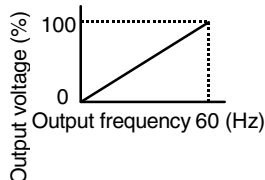

[Free mode]

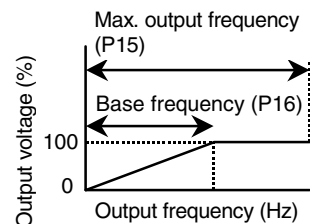

Note 1) Both the maximum output frequency and base frequency are set to 50Hz as the factory setting data.

Note 2) Take note of the upper frequency clamp (parameter P54) when changing the maximum output frequency setting.

V/F CURVE (Parameter P04)

Used to select either the constant or square torque mode.

Data setting value	Name	Remarks
0	Constant torque mode	For machine applications
1	Square torque mode	For fan and pump applications

[Constant torque mode]

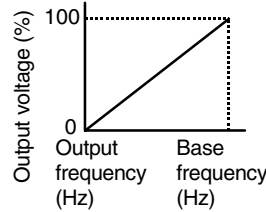

[Square torque mode]

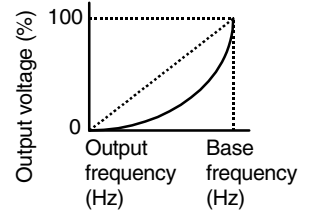

TORQUE BOOST LEVEL (Parameter P05)

Used to select a torque boost level that best fits the load characteristics.

Data setting range	0 to 40 (A larger value causes a higher output voltage and stronger boost.)
---------------------------	--

[Constant torque mode]

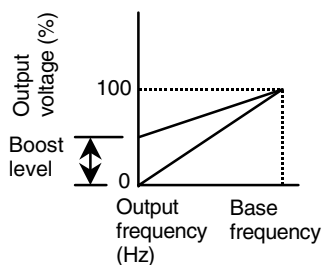

[Square torque mode]

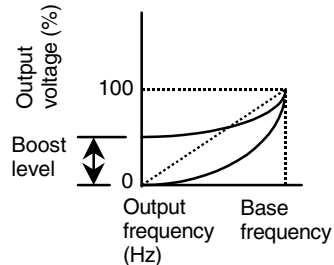

OVERLOAD FUNCTION and OVERLOAD CURRENT (Parameter P06 and P07)

Used to set the operation level of the electronic thermal relay when the motor overload is detected and the inverter output is to be stopped. Set these parameters according to the rated current of applicable motor.

[Parameter P06: Setting of electronic thermal relay function details]

Data setting value	Validity of function	Details of function (Operation coasts to stop when OL is displayed)
0	Invalid	Note that the OL trip will occur if a current that is 140% of the rated inverter current flows for one minute.
1	Valid	Without output frequency derating
2	Valid	With output frequency derating
3	Valid	Forced ventilation motor specifications

[Parameter P07: Setting of thermal relay current]

Data setting range (A)	0.1 to 100
------------------------	------------

* Set current and thermal relay function

- Set current $\times 100\%$
 \Rightarrow Does not trip
- Set current $\times 125\% \Rightarrow$ Trips

* What is derating?

Function to automatically compensate operation level when motor cooling performance drops during low-speed operation.

[Parameter P06 = 1]

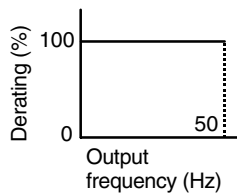

[Parameter P06 = 2]

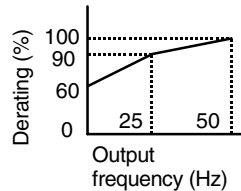

[Parameter P06 = 3]

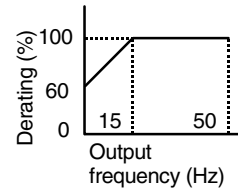

LOCAL/EXTERNAL CONTROL (Parameter P08)

Used to select whether to carry out start/stop and forward/reverse with the operation panel (local) or with signals input from external devices.

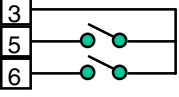
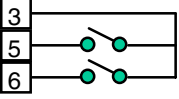
Data setting value	Local/ External	Panel reset function	Operation method and control terminal connection diagram
0	Local	Provided	Start: RUN Stop: STOP Forward/reverse: Set in dr mode
1			Forward run: ▲, RUN Reverse run: ▼, RUN Stop: STOP
2	External	Not provided	 Common terminal ON: Start/OFF: Stop ON: Reverse/OFF: Forward
4		Provided	
3	External	Not provided	 Common terminal ON: Forward run/OFF: Stop ON: Reverse run/OFF: Stop
5		Provided	

* Panel reset function

When a fault trip occurs, the state cannot be reset with the external stop signal. Instead use "function to reset with the stop SW signal on the operation panel". Note that if the reset lock out function is used, that function will have the priority. The reset function is also valid.

LOCAL/EXTERNAL FREQUENCY (Parameter P09)

Used to select whether the frequency signal is to be set from the operation panel (local) or with an input signal (external).

Data setting value	Local/ External	Frequency setting signal details	Operation method and control terminal connection diagram
0	Local	Potentiometer (panel)	Frequency setting dial Max. : maximum frequency (Refer to P03, 15) Min. : Minimum frequency (or 0V stop)
1		Digital setting (panel)	Set with the "Fr mode" using the MODE, ▲, ▼ and SET buttons.
2	External	Potentiometer	Terminals No. 1, 2, 3 (connect potentiometer's center tap to 2)
3		0-5(V) voltage signal	Terminals No.2 and 3 (2:+,3:-)
4		0-10(V) voltage signal	Terminals No.2 and 3 (2:+,3:-)
5		4-20(mA) current signal	Terminals No. 2 and 3, (2:+,3:-) Connect 200Ω across 2-3

Note 1) When using the 4 to 20mA signal, always connect a "200Ω resistor" across terminals No. 2 and 3. (The inverter could be damaged if the 200Ω resistor is not connected.)

Note 2) When using an analog signal set to a value other than "1", the inverter will start and stop at a boundary of approx. 1/100 of the input signal's full scale. (0V stop function: refer to page 73.)

REVERSE LOCKOUT (Parameter P10)

Used to prevent reverse rotation when the motor is to be used only in the forward rotation.

Data setting value	Details
0	Reverse rotation enabled (both forward/reverse rotation enabled)
1	Reverse rotation prohibited (only forward rotation enabled)

Note) When the reverse rotation prohibit setting is made, reverse rotation will be impossible in both the local and external modes.

STOP MODE SELECT (Parameter P11)

Used to select whether to ramp-to-stop or coast-to-stop when stopping the inverter.

Data setting value	Details	Explanation of operation
0	Ramp-to-stop	The frequency is decelerated by the stop signal according to the deceleration time, and then the motor stops.
1	Coast-to-stop	The inverter output is shut off immediately by the stop signal.

STOP FREQUENCY (Parameter P12)

Used to set the frequency which the inverter output stops when the inverter decelerate to a stop.

Data setting range (Hz)	0.5 to 60 (set in 0.1Hz increments)
--------------------------------	-------------------------------------

DC BRAKE TIME and DC BRAKE LEVEL (Parameter P13 and P14)

The DC brake can be applied when the inverter output frequency drops below the stop frequency during ramp-to-stop or when switching between forward run and reverse run. When used with jog operation, positioning control can be carried out.

[Parameter P13: The DC brake time is set.]

Data setting range (sec)	000•0.1 to 120 (The brakes are not applied when 000 is set.)
---------------------------------	--

[Parameter P14: The DC brake level is set.]

Data setting range	0 to 100 (Set in increments of 5. The braking force will increase when a larger value is set.)
---------------------------	--

[Ramp-to-stop] [Forward/reverse]

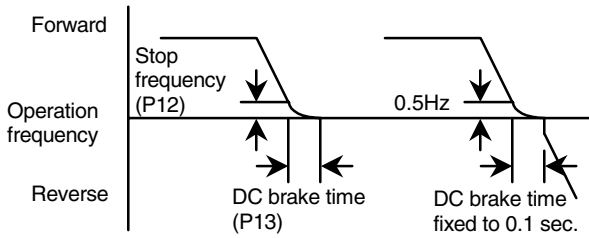

- * The frequency for applying the DC brake is set by parameter P12 stop frequency.
- * The DC brake time when switching between forward run and reverse run is fixed to 0.1 sec.

**MAX. OUTPUT FREQUENCY and BASE FREQUENCY
(Parameter P15 and P16)**

Used to set the maximum output frequency and base frequency.
(These parameters are valid only when "FF" is set in parameter P03)

**[Parameter P15:
The maximum output frequency is set.]**

Data setting range (Hz)	50.0 to 250
--------------------------------	-------------

**[Parameter P16:
The base frequency is set.]**

Data setting range (Hz)	45.0 to 250
--------------------------------	-------------

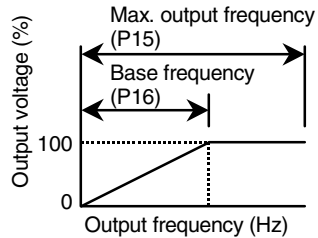

- Note 1)** A frequency higher than the upper frequency clamp (parameter P54) cannot be output.
- Note 2)** Read the precautions given on page 66 when setting a value other than 50Hz or 60Hz.

ACCELERATION FREQUENCY HOLD (Parameter P17)

When the set acceleration time is too short for the inertial load, this parameter can be used to temporarily reduce the acceleration rate to prevent an overcurrent trip.

Setting data	Function details
0	Stall prevention function disabled
1	Stall prevention function enabled

Note)
The level that the stall prevention functions at can be set with parameter P63 OCS level.

DECELERATION FREQUENCY HOLD (Parameter P18)

When the set deceleration time is too short for the inertial load, this parameter can be used to temporarily reduce the deceleration rate to prevent an overvoltage trip.

Data setting value	Function details
0	Stall prevention function disabled
1	Stall prevention function enabled

Note 1) Always set the setting data to "0" when using the regenerative brakes.
(The regenerative brake function will not operate when the default data "1" is set.)

Note 2) The regenerative brake specifications are shown below. Always consider the working conditions carefully before using.

Note that the inverter could be damaged if the specifications are exceeded during use.

- 1) Maximum duty factor (%ED): 2% 2) Maximum working time: 3 seconds
3) Braking torque: 100%

Note 3) Always use the Matsushita-dedicated option for the brake resistor.
Refer to the precautions on page 15 for installing the brake resistor, etc.

SW1, SW2, SW3 FUNCTION SELECT (Parameter P19, P20 and P21)

Used to set the control functions of SW1, SW2 and SW3 (control circuit terminals No. 7, 8 and 9).

(Also read the supplementary details on pages 68 to 72.)

Function setting switch	SW1 (terminal No. 7)	SW2 (terminal No. 8)	SW3 (terminal No. 9)
Setting parameter No.	P19	P20	P21

Setting data	0	Multi-speed SW1 input	Multi-speed SW2 input	Multi-speed SW3 input
	1	Reset input	Reset input	Reset input
	2	Reset lockout input	Reset lockout input	Reset lockout input
	3	Jog selection input	Jog selection input	Jog selection input
	4	Auxiliary stop input	Auxiliary stop input	Auxiliary stop input
	5	Coast-to-stop input	Coast-to-stop input	Coast-to-stop input
	6	Frequency signal changeover input	Frequency signal changeover input	Frequency signal changeover input
	7	2nd characteristics selection input	2nd characteristics selection input	2nd characteristics selection input
	8	_____	_____	Frequency ▲, ▼ setting

[Multi-speed SW function]

The combination of the SW inputs for when the SW function is set to multi-speed function is shown below.

SW1 (Terminal No. 7)	SW2 (Terminal No. 8)	SW3 (Terminal No. 9)	Operating frequency
OFF	OFF	OFF	Speed 1
ON	OFF	OFF	Speed 2
OFF	ON	OFF	Speed 3
ON	ON	OFF	Speed 4
OFF	OFF	ON	Speed 5
ON	OFF	ON	Speed 6
OFF	ON	ON	Speed 7
ON	ON	ON	Speed 8

Note 1) Speed 1 will be the command value of the frequency setting signal set with parameter P09.

Note 2) The speed 2 to 8 frequencies will be the frequencies set with parameters P32 to P38.

[Reset function]

If a fault trip occurs, the fault trip state can be reset by turning the SW signal input ON and OFF.

[Reset lockout]

Resetting of the fault trip state by the stop signal can be prohibited. In that case, after the details of the trip are confirmed and measures are taken, resetting can be done with this SW signal.

- Always input the SW signal at ON (closed).
- Even if the stop signal or reset signal is input during a fault trip, the trip state will be held.
- Confirm the details of the trip and take measures, and then reset the state by OFF (opened) this SW signal.

[Jog function]

The signal input terminal is set for executing jog operation from external connection.

- The "jog operation mode" is entered by turning the signal input ON (closed).
- Jog operation can be carried out with the details set in parameters P29, P30 and P31 (jog frequency, jog acceleration time, jog deceleration time) by inputting the start/stop and forward/reverse signals from terminals No. 5 and 6.

[Auxiliary stop function]

A signal input terminal is set to carry out fault stop (emergency stop) from a device other than the inverter.

- if the SW signal is turned OFF (opened) with the b contact input, "AU" will appear and the inverter output will immediately stop.

[Coast-to-stop function]

A signal input terminal is set to carry out coast-to-stop from an external location.

- If the signal input is turned ON (closed) during operation, "0.0" will appear and the inverter output will immediately stop.
- If the input signal is turned OFF (opened) and the run signal is ON, the inverter will immediately start operation.

Note) The inverter will start as soon as the signal is turned OFF, so take sufficient means to ensure safety.

- If the signal input is turned OFF (opened) and the run signal is OFF, the inverter will normally stop.

[Frequency signal changeover function]

A signal input terminal is set so that the frequency setting command can be changed from the "command set with parameter P09" to the "external potentiometer".

(The state will not change if parameter P09 is set to "2 (potentiometer)".)

- When signal input is OFF (opened) : Parameter P09 setting command
- When signal input is ON (closed) : External potentiometer signal

[2nd characteristics selection function]

The inverter will run with the data set in the 2nd acceleration time (parameter P39), 2nd deceleration time (parameter P40), 2nd base frequency (parameter P41), and 2nd torque boost level (parameter P42) when the SW signal is ON (closed).

[Set frequency ▲, ▼ setting function]

When the frequency setting is "digital setting with operation panel (P09=1)", the frequency can be changed with SW1 and SW2 by setting parameter P21 to "8". The changed frequency can be saved with SW3.

* When parameter P21 is set to "8":

The terminals will be forcibly changed to the "SW1: frequency up SW", "SW2: frequency down SW" and "SW3: frequency save SW" function input terminals.

- When SW1 is ON (closed) : The frequency will increase. (The current frequency will be maintained when OFF)
- When SW2 is ON (closed) : The frequency will decrease. (The current frequency will be maintained when OFF)
- By turning SW3 ON (closed) and OFF (opened):

The frequency at that time will be saved.

(This frequency will be saved even if the power is turned OFF.)

Note) The operating frequency will not be saved unless the "frequency is saved with SW3" and the "frequency is set with frequency setting mode" using the operation panel.

PWM CONTROL FUNCTION SELECT, PWM SIGNAL AVERAGING and PWM SIGNAL CYCLE (Parameters P22, 23, 24)

With this VF0, the operating frequency can be controlled with the PWM signals output from the PLC, etc.

(Note that the tolerable PWM signal cycle is between 0.9ms and 1100ms.)

[Parameter P22: PWM control function select]

Data setting value	Details
0	PWM control function selection disabled
1	PWM control function selection enabled

Note) If the PWM control function is selected, the SW2 (terminal No. 8) and SW3 (terminal No. 9) functions will be forcibly changed to PWM control dedicated functions.

◆ Explanation of control circuit terminal connection and functions

- 1) Terminal No. 8: Frequency signal changeover input terminal
 ON : Signal set with parameter P09
 OFF : PWM signal
- 2) Terminal No. 9: PWM signal input terminal
 Input with an open collector signal having a capability of the maximum rated voltage and current: 50VDC, 50mA or more.

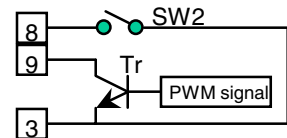

◆ Relation of PWM signal and frequency command value

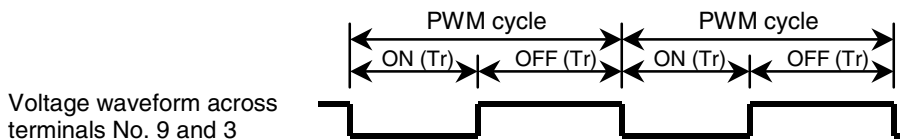

$$\text{Frequency command value (Hz)} = \frac{\text{ON time}}{\text{PWM cycle}} \times \text{maximum output frequency (Hz)}$$

* The maximum output frequency will be "50Hz" when parameter P03 is set to "50", "60Hz" when set to "60", and "parameter P15 value" when "FF" is set.

[Parameter P23: PWM signal averaging]

Setting data range (times)	1 to 100
-----------------------------------	----------

The inverter measures and calculates the ON time and OFF time per PWM cycle, and recognizes the results as the frequency command value.

This parameter is used to stabilize the frequency command value recognized by the inverter. For example, if the setting data is set to "5", the inverter will average five successive frequency command values, and will recognize the results as the final frequency command value.

- * The frequency command value will stabilize when the setting value is increased, but the response speed will drop.

[Parameter P24: PWM signal cycle]

Setting data range (ms)	1 to 999
--------------------------------	----------

The cycle of the input PWM signal is set with this parameter.

Set a value within $\pm 12.5\%$ of the PWM signal cycle to be input.

- * For example, if the PWM signal period input is 100ms, the setting value will be between 88 and 112.

Note 1) The output frequency is the "0V stop or minimum frequency" when the PWM signal is in "the state without ON", and is the "maximum frequency" when the PWM signal is in "the state without OFF".

Note 2) The linearity of the output frequency in respect to the input signal will drop near the minimum frequency or near the maximum frequency. Avoid using this for applications requiring precise frequency control.

OUTPUT TR FUNCTION SELECT (Parameter P25)

Used to set the functions of the open collector output (control terminals No. 10 -11).

Data setting value	Function	Conditions for open collector output to turn ON (Setting data "7" is the PWM signal output)
0	Run signal	ON when start input signal is ON or during inverter output
1	Arrival signal	ON when the output frequency is within the set frequency $\pm 2\text{Hz}$
2	Overload prealarm	ON when the output current is 140% of the rated current or higher or when the electronic thermal level is reached
3	Frequency detection signal	ON when the output frequency exceeds the detected frequency (set in parameter P27)
4	Reverse run signal	ON when the inverter is running in reverse
5	Fault warning signal (1)	ON when the inverter is in the fault trip state
6	Fault warning signal (2)	ON when the inverter is in the normal state (OFF when the fault trip state is entered)
7	Output status signal	PWM signal proportional to the output frequency or output current is constantly output

Note) The output frequency proportion or output current proportion for setting data "7" is set with parameter P58.

OUTPUT RY FUNCTION SELECT (Parameter P26)

Used to set the functions of the relay output (control terminals A, B and C).

Data setting value	Function	Conditions for relay to turn ON (across terminals A-C: ON, across terminals B-C: OFF)
0	Run signal	ON when start input signal is ON or during inverter output
1	Arrival signal	ON when the output frequency is within the set frequency $\pm 2\text{Hz}$
2	Overload prealarm	ON when the output current is 140% of the rated current or higher or when the electronic thermal level is reached
3	Frequency detection signal	ON when the output frequency exceeds the detected frequency (set in parameter P28)
4	Reverse run signal	ON when the inverter is running in reverse
5	Fault warning signal (1)	ON when the inverter is in the fault trip state
6	Fault warning signal (2)	ON when the inverter is in the normal state (OFF when the fault trip state is entered)

DETECT FREQUENCIES [OUTPUT TR], [OUTPUT RY] (Parameter P27 and P28)

Used to set the frequency to be detected when outputting the frequency detection signal with the open collector output or relay output.

[Parameter P27 : Open collector output detection frequency setting]

[Parameter P28 : Relay output detection frequency setting]

Data setting range	(Hz)	000 • 0.5 to 250
Setting unit	(Hz)	0.1 (0.5 to 100Hz) 1 (100 to 250Hz)

◆ Relation of output frequency and each output signal

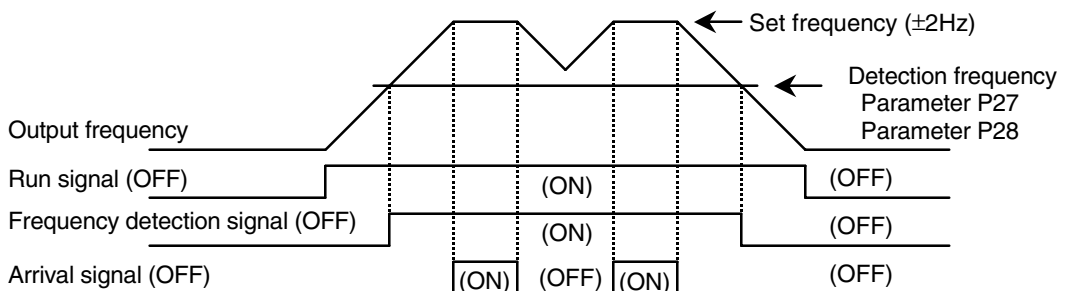

JOG FREQUENCY, JOG ACCELERATION TIME, JOG DECELERATION TIME (Parameter P29, P30 and P31)

Used to set the operating frequency, acceleration/deceleration time when jog operation is executed.

[Parameter P29: Jog frequency setting]

Data setting range	(Hz)	0.5 to 250
---------------------------	-------------	------------

[Parameter P30 : Jog acceleration time setting]

[Parameter P31 : Jog deceleration time setting]

Data setting range	(sec.)	0.04 • 0.1 to 999
---------------------------	---------------	-------------------

Note) "000" is displayed for 0.04 seconds.

[Jog operation]

- The operation command select must be set to external control. (The data for parameter P08 must be set between "2 and 5".)
- The SW select function must be set to the jog function.
- If the SW set for the jog function turns ON (closed), the inverter will enter the jog operation preparation completed state.
- Carry out jog operation start/stop and forward/reverse with control terminals No. 5 and 6.

PRESET FREQUENCIES 2 to 8 (Parameter P32 to P38)

Used to program the speeds 2 to 8, frequencies for multi-step speed operation.

[Parameter P32 : Speed 2 frequency setting]

[Parameter P33 : Speed 3 frequency setting]

[Parameter P34 : Speed 4 frequency setting]

[Parameter P35 : Speed 5 frequency setting]

[Parameter P36 : Speed 6 frequency setting]

[Parameter P37 : Speed 7 frequency setting]

[Parameter P38 : Speed 8 frequency setting]

Data setting range	(Hz)	000 • 0.5 to 250 ("000" sets 0V stop)
Setting unit	(Hz)	0.1 (0.5 to 100Hz) 1 (100 to 250Hz)

Note) Frequencies that exceed the maximum output frequency and the upper frequency clamp will not be output.

2nd ACCELERATION TIME and 2nd DECELERATION TIME (Parameters P39 and P40)

Used to set the 2nd acceleration/deceleration time selected with the 2nd characteristics selection switch.

[Parameter P39 : 2nd acceleration time setting]

[Parameter P40 : 2nd deceleration time setting]

Data setting range	(sec)	0.1 to 999
Setting unit	(sec)	0.1 (0.1 to 100sec) 1 (100 to 999sec)

2nd BASE FREQUENCY (Parameter P41)

Used to set the 2nd base frequency selected with 2nd characteristics select switch.

Data setting range	(Hz)	45.0 to 250
---------------------------	-------------	-------------

Note) The maximum output frequency will be the value set in parameter P03 (frequency range) or parameter P15 (max. output frequency).

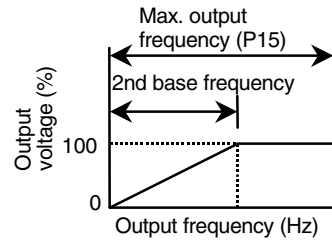

2nd TORQUE BOOST LEVEL (Parameter P42)

Used to set the 2nd torque boost level selected with 2nd characteristics select switch.

Data setting range	0 to 40 (The output voltage will increase and the boost level will increase when a larger value is set.)
---------------------------	--

[Constant torque mode]
(Parameter P04: 0)

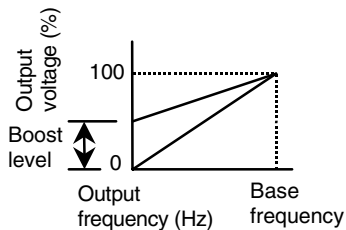

[Square torque mode]
(Parameter P04: 1)

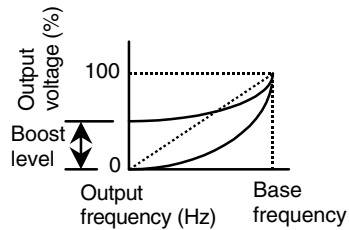

SKIP FREQUENCIES 1 to 3 (Parameter P43 to P45) and SKIP FREQUENCY BAND WIDTH (Parameter P46)

If the load mechanism resonates at a specific inverter output frequency, a continuous operation in that frequency band can be avoided by setting the skip frequency and the skip frequency band.

- * Up to three skip frequencies can be set, and the skip frequency band can be set between 1 and 10Hz.

[Parameter P43 : Skip frequency 1 setting]

[Parameter P44 : Skip frequency 2 setting]

[Parameter P45 : Skip frequency 3 setting]

Data setting range (Hz)	000 • 0.5 to 250 ("000" is set when the skip frequency is to be disabled)
--------------------------------	--

[Parameter P46 :
Skip frequency band width setting]

Data setting range (Hz)	0 • 1 to 10 ("0" is set when the skip frequency is to be disabled)
--------------------------------	---

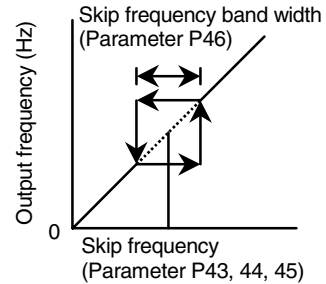

CURRENT LIMIT FUNCTION (Parameter P47)

If the output current reaches the overcurrent stall level due to an overload operation, the frequency is automatically reduced. When the load returns to the correct level, the frequency is automatically returned to the original setting, and the operation is continued.

This function is effective for preventing overcurrent trips in machines that knead glutinous materials, etc.

- * The function's validity and the deceleration time for automatically lowering the frequency when the output current reaches the overcurrent stall level are set with this parameter.
- * The operation level (overcurrent stall level) can be set with parameter P63 (OCS level).

Data setting range (sec.)	00 • 0.1 to 9.9 ("00" is set when the current limit function is disabled.)
----------------------------------	---

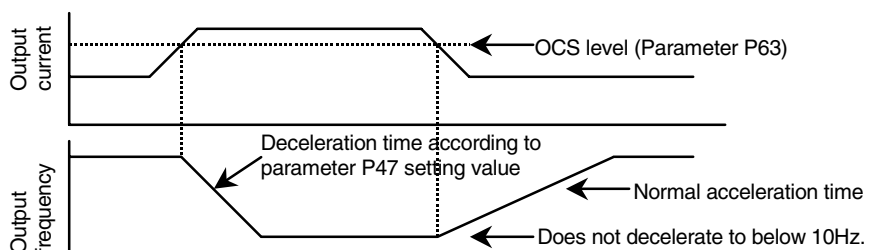

POWER LOSS START MODE (Parameter P48)



CAUTION:

Depending on the start mode function setting, if the run signal is ON and the power is turned ON or the power is restored after a power failure, the unit may start (restart) suddenly. (Design the machine so that personal safety can be ensured even if the unit starts suddenly.)

Failure to do so could lead to injury.

Depending on the start mode function setting, if the fault trip is reset with the run signal present, the unit may restart suddenly.

(Reset the trip after ensuring personal safety.)

Failure to do so could lead to injury.

This parameter sets the starting operation for when an externally set run signal is input when the power is turned ON.

* The factory setting is "1" (OP stop).

* When set to "0" : Operation starts immediately when the power is turned ON.

* When set to "2" : Operation starts after the wait time has elapsed after the power is turned ON.

Data setting value	Outline operation	Details of operation
0	Run	Operation starts immediately when the power is turned ON and the low voltage level (LU level) is exceeded.
1	"OP" stop	The inverter OP trips when the power is turned ON and the low voltage level (LU level) is exceeded. Turn the start input signal OFF once, reset the inverter and then turn the run signal ON again to resume operation.
2	Operate after wait time	The inverter starts when the power is turned ON, the low voltage level (LU level) is exceeded and the wait time is passed. (The wait time is set with parameter P50.)
3	"OP" stop	The inverter OP trips when the power is turned ON and the low voltage level (LU level) is exceeded. Turn the run signal OFF once, reset the inverter and then turn the run signal ON again to resume operation. (This setting will function in the same manner as data "1" if the run signal is ON when the power is turned ON. However, starting after the wait time has elapsed is possible during normal startup.)

[When power is turned ON with run signal ON]

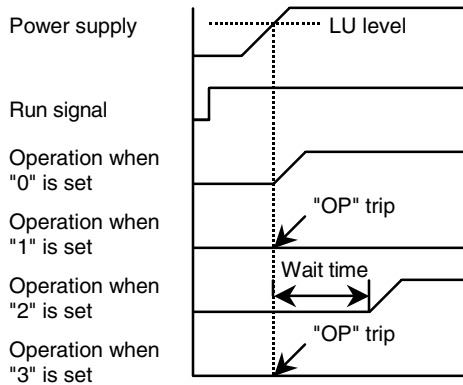

[When run signal is turned ON after power is turned ON]

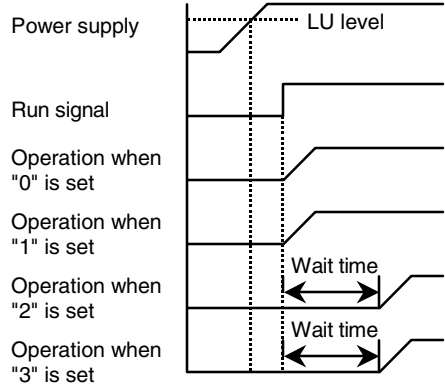

Note) The wait time can be set with parameter P50.

RIDE-THROUGH RESTART (Parameter P49)



CAUTION:

Depending on the ride-through restart function settings, the motor may restart suddenly after the power is restored.
 (Ensure personal safety before restarting.)
 Failure to do so could lead to injury.

Used to select the restart mode after an instantaneous power failure occurs, according to the load conditions and system. A wait timer function is built-in.

Data setting value	Inverter operation in regard to instantaneous power failure time			
	Min. 15ms or less (Note 1)	Exceeding min. 15ms (Note 1)	Min. 100ms or less (Note 2)	Exceeding min. 100ms (Note 2)
0	Operation continues	<ul style="list-style-type: none"> The LU trips, and the inverter operates according to the start mode settings. "LU" will be displayed, and a fault warning signal will be output. 		
1		<ul style="list-style-type: none"> Restarts from 0Hz after the wait time has elapsed. "LU" will be displayed, but a fault warning signal will not be output. 	Operation takes place according to the details set in the start mode.	
2		<ul style="list-style-type: none"> After the wait time has elapsed, the inverter restarts at the frequency applied before the ride-through restart occurred. "LU" will be displayed, but a fault warning signal will not be output. 		

Note 1) This is the min. time for operation at the rated output current.
 (This time may be longer depending on the model.)

Note 2) This is the min. time. (This time may be longer if the rated capacity is larger.)
 Even if the power failure time is relatively long (approx. 1 min.), the inverter may restart after the power is restored. Wait at least four min. (wait time + 2 min.) after the power is restored before handling the inverter, motor or load facility.

Note 3) The wait time can be set between 0.1 to 100 sec. with parameter P50.

[When voltage drop time is more than 15ms but less than 100ms.]

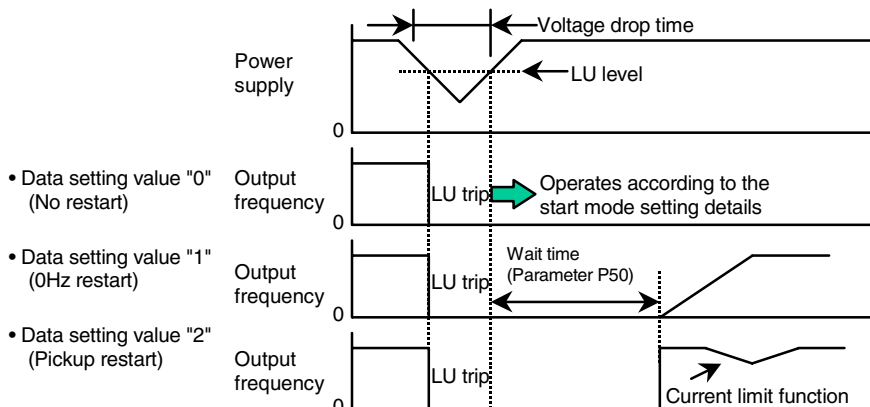

WAIT TIME (Parameter P50)

Used to set the wait time for the start mode, the ride-through restart and retry functions.

Data setting range (sec)	0.1 to 100
---------------------------------	------------

RETRY FUNCTION SELECT, NO. OF RETRIES (Parameters P51 and P52)



CAUTION:

When the retry function is used, the unit may automatically start (restart) suddenly so do not approach the unit.

(Secure personal safety before using this function.)

Failure to do so could lead to injury.

- ◆ If an inverter fault trip occurs, the retry function will automatically reset the fault and will restart (start) operation after the wait time has elapsed.
Use this function to continue operation.
- Select the "retry function validity" and the details of the fault for carrying out retry with parameter P51.
- Set the "number of times to retry" with parameter P52.
- The time interval for retrying is set with parameter P50 (wait time).
- The fault warning signal will not be output during retry.
If a fault occurs even when the set number of retries has been carried out, a fault warning signal will be issued.
- If a fault not selected occurs during retry, a fault warning signal will be output, and the counted number of retries will be cleared.
- The counted number of retries will be cleared when the power is turned OFF.
- If a fault does not occur for 5 or more minutes, the counted number of retries will be cleared.

[Parameter 51: Retry selection setting]

Data setting value	Details
0	Retry function disabled (Retry is not carried out)
1	Execute retry only for overcurrent fault and heat sink fin abnormal overheating (SC1, 2, 3, OC1, 2, 3)
2	Execute retry only for overvoltage fault (OU1, 2, 3)
3	Execute retry for overcurrent fault and heat sink fin abnormal overheating (SC1, 2, 3, OC1, 2, 3) and overvoltage fault (OU1, 2, 3)

[Parameter 52: No. of retries setting]

Data setting range (times)	1 to 10
-----------------------------------	---------

LOWER and UPPER FREQUENCY CLAMP

(Parameter P53 and P54)

Used to set the lower and upper limits of the output frequency.

[Parameter P53 : Lower frequency clamp setting]

[Parameter P54 : Upper frequency clamp setting]

Data setting range	(Hz)	0.5 to 250
Setting unit	(Hz)	0.1 (0.5 to 100Hz), 1 (100 to 250Hz)

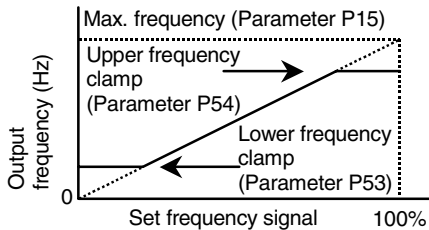

Note 1) If the upper frequency clamp is lower than the maximum output frequency (parameter P15), the upper frequency clamp will have the priority.

Note 2) If the lower frequency clamp is higher than the upper frequency clamp, the upper frequency clamp will have the priority.

BIAS/GAIN FUNCTION SELECT, BIAS FREQUENCY, GAIN FREQUENCY (Parameter P55, P56 and P57)

The relation with the output frequency and frequency setting signal (panel potentiometer, external potentiometer, 0 to 5V, 0 to 10V, 4 to 20mA), can be changed randomly. Use this function according to the application.

[Parameter P55: Bias/gain function select]

Data setting range	Function details
0	Bias/gain function disabled
1	Bias/gain function enabled

[Parameter P56: Bias frequency setting]

Data setting range	(Hz)	-99 to 250
--------------------	------	------------

[Parameter P57: Gain frequency setting]

Data setting range	(Hz)	000 and 0.5 to 250
--------------------	------	--------------------

* (When "000" is set, 0V stop will function.)

Note 1) A frequency exceeding the maximum output frequency or upper frequency clamp cannot be output.
The frequency will not drop below the lower frequency clamp.

Note 2) Even if a minus frequency setting signal is input, the inverter will not run in reverse.

[When bias frequency setting is positive]

[When bias frequency setting is negative]

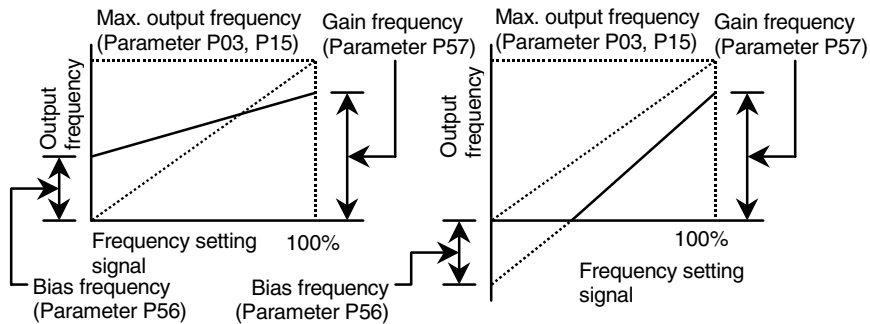

ANALOG/PWM OUTPUT FUNCTION SELECT (Parameter P58)

The "0 to 5V voltage signal" output from the control circuit terminal No. 4 and the functions of the "output status signal (PWM)" output from terminals No. 10-11 can be set.

Data setting value	Details of function
0	Signal proportional to output frequency is output
1	Signal proportional to output current is output

- ◆ Relation of 0 to 5V voltage signal and output frequency/output current

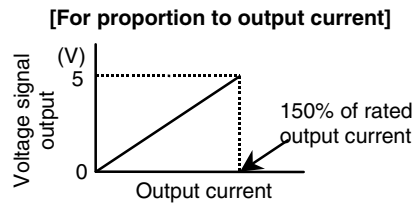
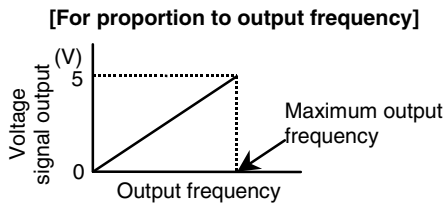

- ◆ Relation of PWM output signal and output frequency/output current

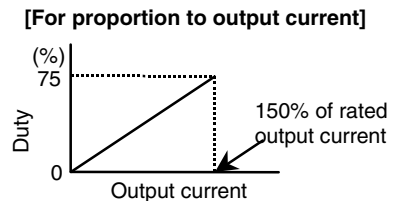
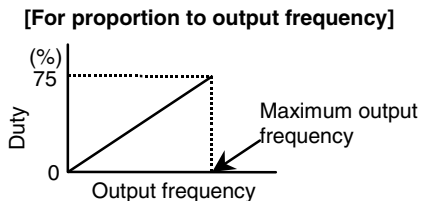

Note 1) The parameter P25 (output TR function selection) data must be "7" for the "PWM output" to be attained from terminals No. 10-11.

Note 2) The PWM output signal cycle is "1ms".

[Handling of 0 to 5V voltage output, and output status signal (PWM)]

- 1) The output signal is not intended for precise measurement. Use this only as a guide value. (Use a separate measuring instrument when precise values are required.)
- 2) The signal proportional to the output current may output a relatively large value at approx. 40% or less of the rated current.
(For example, even if there is no output current, a certain signal level may be output. Note that when the inverter is stopped, the "0 level" will be output.)

ANALOG/PWM OUTPUT COMPENSATION (Parameter P59)

The "0 to 5V voltage signal" and "output status signal (PWM)" output can be compensated.

Data setting range (%)	75 to 125
Setting unit (%)	1

<<Adjustment range (Full scale value)>>

- 1) Voltage signal : 3.75 to 5 to 6.25 (V)
- 2) PWM signal : 56.3 to 75 to 93.8 (%)

MONITOR SELECT and LINE SPEED MULTIPLIER (Parameter P60 and P61)

Used to select the details of the operation panel's main display.

[Parameter P60: Monitor details selection]

Data setting value	Details displayed on operation panel
0	Output frequency
1	Line speed

[Parameter P61: Line speed multiplier setting]

Used to set the multiplier with respect to the frequency when the line speed is displayed on the operation panel's main display.

Data setting range	0.1 to 100 (can be set in 0.1 units)
---------------------------	--------------------------------------

[Example: Display line speed] ⇒ Line speed (m/min) = F (Hz) × K (multiplier)

- To display the line speed 25 (m/min) for 50Hz, set the multiplier (K) to "0.5".

Note) A line speed exceeding "999" cannot be displayed.
(The 4-pole motor speed cannot be displayed.)

MAX. OUTPUT VOLTAGE (Parameter P62)

Used to set the max. output voltage.

Data setting range (V)	0 • 1 to 500 (When "0" is set, the power voltage will be output.)
-------------------------------	--

Note 1) A voltage exceeding the power voltage cannot be output.

Note 2) This setting does not affect the DC brake level.

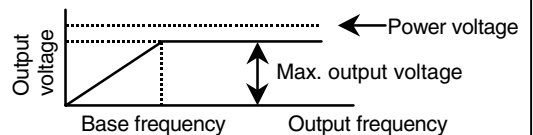

OCS LEVEL (Parameter P63)

The OCS level (overcurrent stall prevention operation level) and current clamp function level can be set with a percent (%) to the inverter's rated current.

Data setting range (%)	1 to 200 (can be set in 1 units)
-------------------------------	----------------------------------

Note 1) The OCS level and current clamp levels are the same.

Note 2) This setting is not related to the electronic thermal relay level and overload detection level.

CARRIER FREQUENCY (Parameter P64)

This carrier frequency can be changed to "reduce motor noise" and to "avoid mechanical resonance". The carrier frequency is set to 1.6kHz before shipment from the factory.

Data setting range (kHz)	0.8 • 1.1 • 1.6 • 2.5 • 5.0 • 7.5 • 10.0 (Seven types of settings are possible.)
---------------------------------	---

Note 1) This setting can be changed during operation, but changes in the following [Low frequency group] and [High frequency group] can be made only when operation is stopped.

[Low frequency group] : 0.8 to 1.6 (kHz)

[High frequency group] : 2.5 to 10.0 (kHz)

Note 2) When the data value is set to "10.0", the rated output current for only the 3.7kW capacitor inverter must be reduced. Refer to the precautions on page 83, and use correctly.

Note 3) When the carrier frequency is set to 7.5kHz or 10.0kHz, the carrier frequency will change according to the output frequency.

- When set to 7.5kHz, the carrier frequency will be output at 5.0kHz between the output frequency 0.5 to 7Hz.

- When set to 10.0kHz, the carrier frequency will be output at 5.0kHz between the output frequency 0.5 to 7Hz, and will be output at 7.5kHz between the output frequency 7 to 17Hz.

PASSWORD (Parameter P65)

A password can be set to prevent unintentional changes to the parameter data after it has been set.

Data setting range	000 • 1 to 999 ("000" indicates that there is no password.)
---------------------------	--

[Procedures for changing parameter data after setting password]

* Example when password is set to "777"

Main display

STOP Press the STOP button to stop the inverter. 0 | 0 | 0

MODE When the MODE button is pressed three times, the password input display (PS) will appear, and the main display will flicker.

 F r → d r → P S

▲ Press the ▲ (up) and ▼ (down) buttons to display the previously set password. (The main display will flicker.) 7 | 7 | 7

SET The parameter No. will appear when the SET button is pressed. P | 0 | 1

* After this step, the data is changed with the normal changing procedures.

Note) After the parameter is set, the "function setting mode" cannot be called without inputting the password. (Write down the password so that you do not forget it.)

SETTING DATA CLEAR (Parameter P66)

The set data can be changed to the factory setting data in a batch.

Data setting range	Details
0	Data value that indicates normal state.
1	Changes all data to the factory settings.

Note) When "1" is displayed and the SET button is pressed, the display will automatically change to "0" after the data is changed, and the changing procedure will be completed.

FAULT DISPLAY 1 to 4 (Parameter P67 to P70)

Up to four causes of trips are saved even when the power is turned OFF.

The details of the faults can be confirmed with parameter P67 (latest fault details), P68 (previous fault details), P69 (second to last fault details) and P70 (third to last fault details).

Note) See "Individual Details and Remedies for Fault Trips" on page 74 for details on the faults.

To Effectively Use the Inverter

Contents

	<<Page>>
● Changing from Local Control to External Control.....	65
● Changing and Setting the Maximum Output Frequency	66
● Boosting Torque at Low Speeds	67
● Supplementary Explanation for Multi-function Terminal Input	68
● 0V Stop Function	73
● Resetting Fault Trips	73

Changing from Local Control to External Control

- To enable external control by an external switch or PLC, follow the procedure below.

- Enabling external control for start/stop and forward/reverse(Parameter P08)
 (To change parameter P08 from "0" to "2")

[Changing procedure]

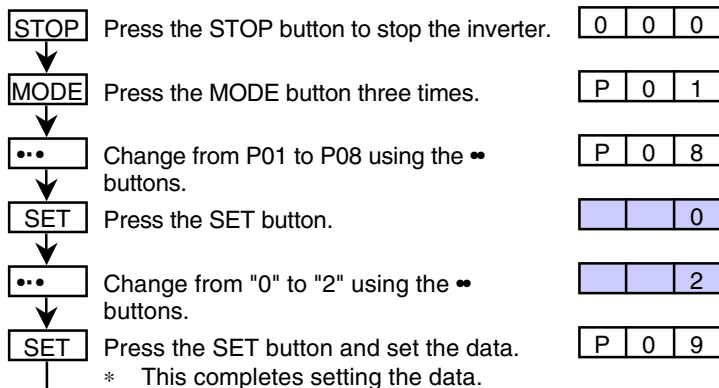

[Terminal connection (P08=2)]

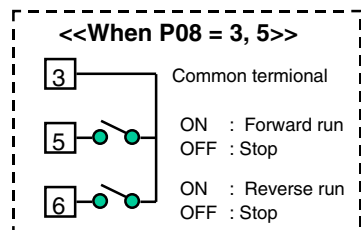
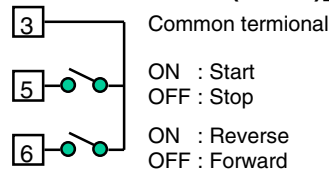

- Enabling external control for frequency setting signals (0 to 10V)(Parameter P09)
 (To change parameter P09 from "0" to "4".)

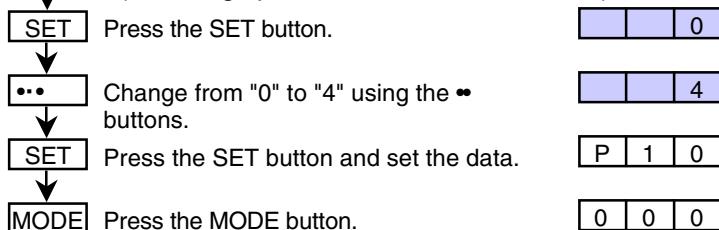

[Terminal connection (P09=4)]

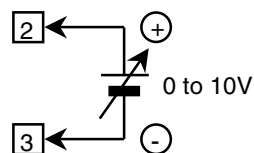

* Operation can be started when the data has been set.

<<Potentiometer: P09=2>> <<0 to 5V: P09=3>> <<4 to 20mA: P09=5>>

[Other signal connections]

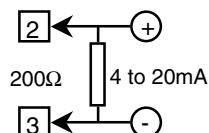
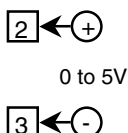
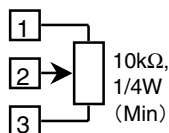

(Important)

When using the 4 to 20mA signal, always connect a "200Ω resistor". The inverter could be damaged if the 200Ω resistor is not connected.

Changing and Setting the Maximum Output Frequency

- The factory setting for the maximum output frequency is 50Hz. When changing the maximum output frequency, set the frequency range (V/F pattern) (parameter P03) to FF, and then change the max. output frequency setting (parameter P15).

[Example to change maximum output frequency from 50Hz to 100Hz]

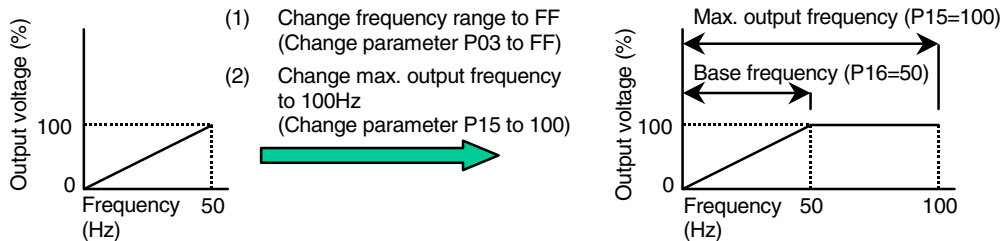

- * If the frequency range is "50" or "60", the max. output frequency and base frequency will be fixed.
- * When the frequency range is "FF", the frequency range will be determined according to the max. output frequency and base frequency.

- Note 1)** A frequency exceeding the upper frequency clamp (parameter P54) cannot be output.
- Note 2)** If a general-purpose motor with a rated frequency of 50 or 60Hz is run at a frequency exceeding the rated frequency, the motor may be damaged. Always set the frequency to match the motor characteristics.
- Note 3)** If the base frequency must be changed together with the max. output frequency for a high-speed exclusive motor, etc., change parameter P16 with the procedure given above.
- Note 4)** When running a general-purpose motor with a frequency higher than the commercial frequency, the base frequency will be set to the normal motor's rated output frequency (50 or 60Hz).
- Note 5)** When using the general-purpose motor at a level higher than the base frequency (normally 50 or 60Hz), the motor will enter the rated output characteristics, and the generated torque will drop in inverse proportion to the frequency.

Boosting Torque at Low Speeds

- If a large torque is required at low speeds, increase the torque boost level (parameter P05) setting data value to increase the output voltage and thereby increase the torque.

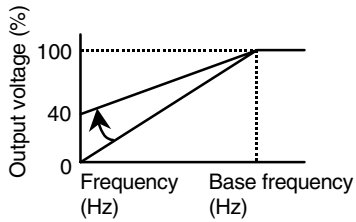

Note 1) If the boost level is too high, an overcurrent fault, overload fault or motor overheating could occur or the noise could increase.

Note 2) The motor current will increase when the boost level is increased.

Carefully consider the settings for the overload function and overload current (parameters P06, P07).

Supplementary Explanation for Multi-function Terminal Input

- Nine types of functions can be selected for the multi-function input terminals No. 7, 8, 9 (SW1, SW2, SW3). Refer to the following explanation and use these functions effectively.

1. Multi-speed SW function (Parameters: P19, P20, P21/Data setting value: 0)
Eight types of frequencies can be selected, changed and controlled with the three switch signals SW1, 2 and 3.
(Speed 1: Parameter P09 setting signal, Speeds 2 to 8: Parameter P32 to P38 set frequency)

<<Example>> When Speed 1 is set to 50Hz, and speeds 2 to 8 are set to factory setting

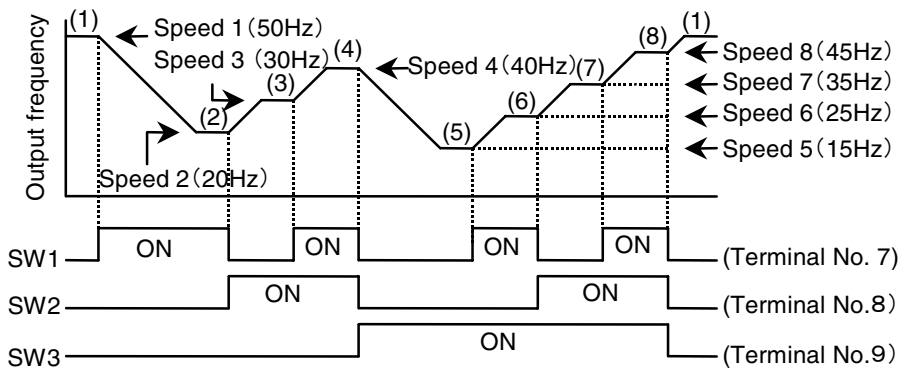

- * When using one switch input for this function, there will be two speeds, and when two switches are used, there will be four speeds. (Example: When only SW1 is used, the speeds will change between speed 1 and speed 2. When SW1 and SW2 are used, the speeds will change between speeds 1 and 4.)
- * If "000" is set for the speeds 2 to 8 frequency (parameters P32 to P38), the inverter will stop (0V stop) when that multi-speed frequency is selected.

2. Reset input function (Parameters: P19, P20, P21/Data setting value: 1)
This function resets the fault stop state from an external device when the inverter trips (stops) with a fault.

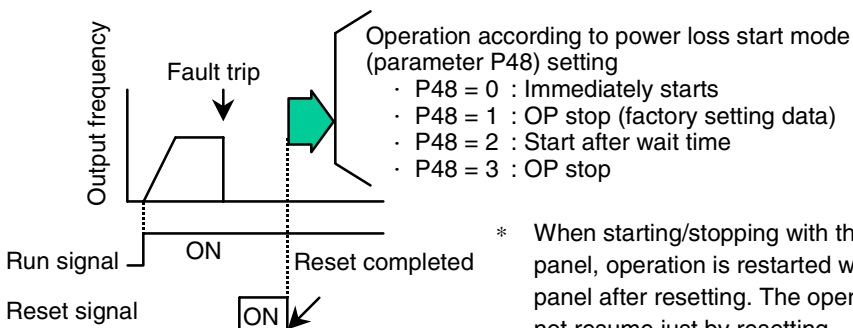

- * When starting/stopping with the operation panel, operation is restarted with the panel after resetting. The operation will not resume just by resetting.
- * The fault trip can also be reset by turning the run signal OFF (stopping).

3. Reset lockout function (Parameters: P19, P20, P21/Data setting value: 2)
 This function holds the inverter's fault trip state. When this signal is input (ON), the fault cannot be reset with means other than turning the power OFF. This is effective for checking the details of the fault.

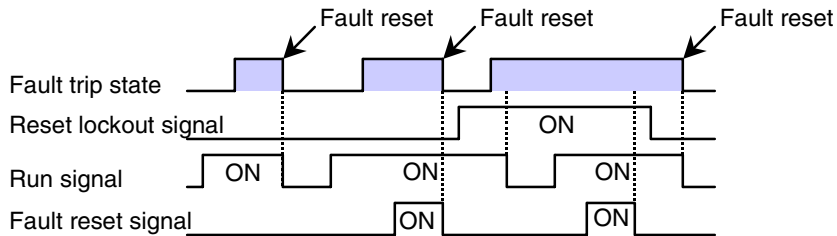

- * If the reset lockout signal is ON, the fault trip state cannot be reset even by issuing the stop signal (STOP button ON/OFF) on the operation panel.
 To reset the fault, turn the reset lockout signal OFF and then press the STOP button.

4. Jog function (Parameters: P19, P20, P21/Data setting value: 3)
 Jog operation for positioning can be carried out with external signals.
 Note that the local/external control (parameter P08) must be set to external.

<<Example>> When SW1 (parameter P19=3) is set to jog function, and local/external control is set to "2"

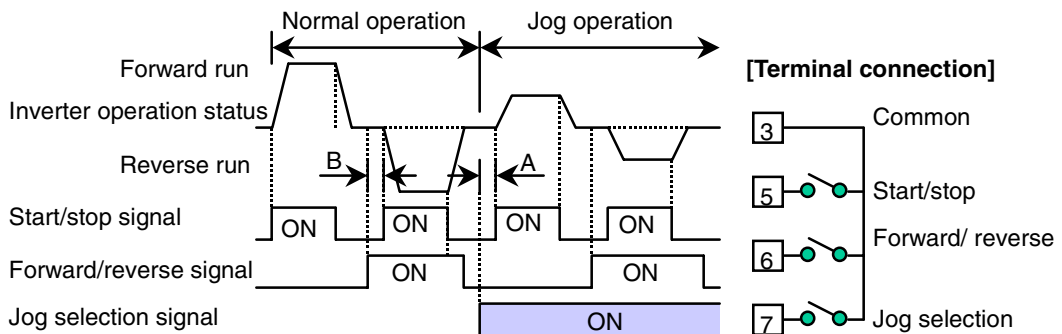

* The A and B times are 50ms or more

- Note 1)** To carry out jog operation, turn the jog selection signal ON, and then turn the start/stop signal ON.
Note 2) To rotate in reverse, turn the forward/reverse signal ON, and then turn the start/stop signal ON.

5. Auxiliary stop function (Parameters: P19, P20, P21/Data setting value: 4)
 This function is used to carry out fault stop (emergency stop) from a source outside of the inverter.
 In the normal state, the ON signal is input. A fault stop will occur when this is turned OFF. (The fault display is "AU".)

<<Example>> When SW1 (parameter P19=4) is set to auxiliary stop, and local/external control is set to "2"

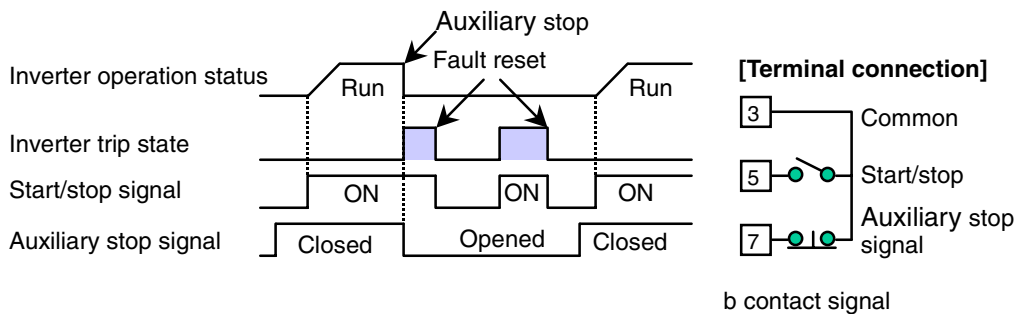

b contact signal

* Even if the auxiliary stop signal is "opened", the fault can be reset by turning the start/stop signal OFF. However, a fault trip will occur when the start/stop signal is turned ON again. Normal operation can be resumed by "closed" the auxiliary stop signal and then turning the start/stop signal ON.

6. Coast-to-stop function (Parameters: P19, P20, P21/Data setting value: 5)
 This function is used to coast the inverter to a stop with a signal from an external source.
 (The fault display and fault warning output are not output.)

<<Example>> When SW1 (parameter P19=5) is set to coast to a stop, and local/external control is set to "2"

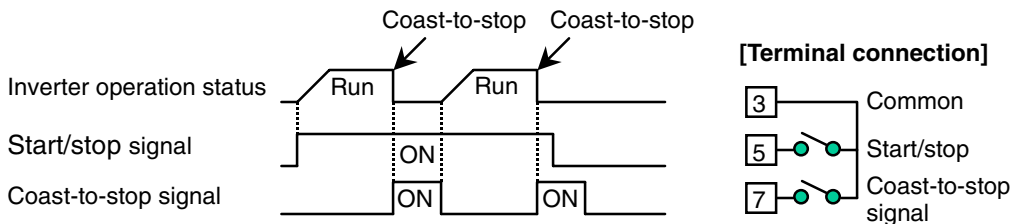

[Important] The inverter will restart immediately if the start/stop signal is ON when the coast-to-stop signal changes from ON to OFF. Provide sufficient safety means.

7. Frequency signal changeover input function (Parameters: P19, P20, P21/Data setting value: 6)
 The frequency setting signal can be changed between the "external potentiometer" and "parameter P09 selection signal".

<<Example>> When SW1 (parameter P19=6) is set to frequency changeover

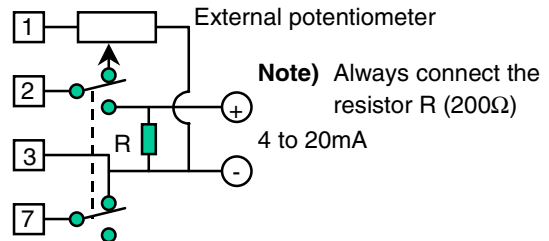
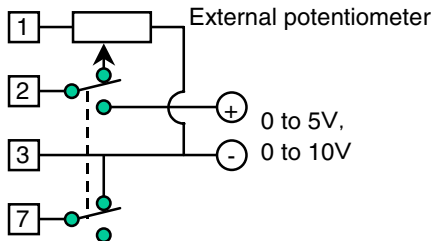

8. 2nd characteristic selection function (Parameters: P19, P20, P21/Data setting value: 7)
 The acceleration time, deceleration time, torque boost and base frequency can be changed to the 2nd characteristics with the switch signal from an external source.

Changeover switch OFF		Changeover switch ON	
Operation characteristics	· 1st acceleration time (parameter P01)	Operation characteristics	· 2nd acceleration time (parameter P39)
	· 1st deceleration time (parameter P02)		· 2nd deceleration time (parameter P40)
	· Torque boost level (parameter P05)		· 2nd torque boost level (parameter P42)
	· Base frequency (parameter P16)		· 2nd base frequency (parameter P41)

Note) Provide sufficient safety means when changing the characteristics.

9. Frequency •(up) · •(down) setting function (Parameter: P21/Data setting value: 8)
 When the frequency setting is "digital setting with operation panel (parameter P09=1)",
 the frequency can be changed and saved with the external switch signals.

- * When parameter P21 is set to "8", SW1, 2 and 3 will forcibly change to the following functions.
- * SW1: •(up) button * SW2: •(down) button * SW3: Save switch

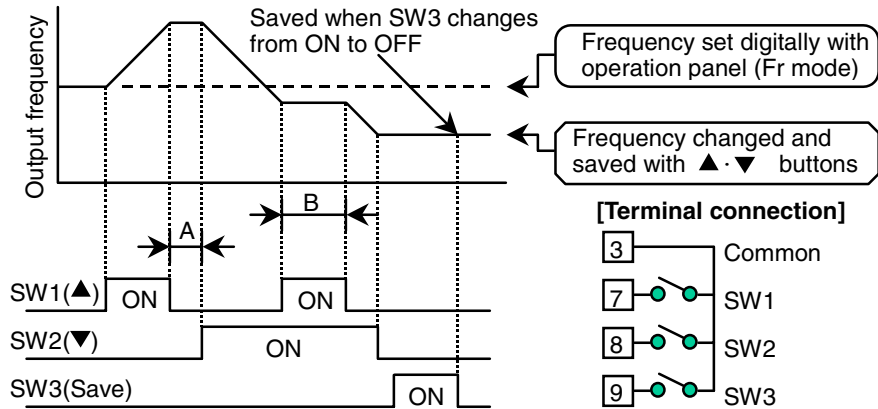

- Note 1)** When both the • button (SW1) and • button (SW2) are "OFF" and "ON" (in A or B regions, etc.), the operating frequency will not change.
- Note 2)** The frequency is saved when the save switch (SW3) "changes from ON to OFF".
 (The frequency at that point will be saved even if the frequency is changing.)
- Note 3)** The operating frequency can also be saved by carrying out operations in the "Fr mode (frequency setting, monitor mode)" using the operation panel.
- Note 4)** The operating frequency will not be saved when the power is turned OFF unless the data is saved with the "Fr mode" using the operation panel or the data is saved with SW3.
 (The frequency set initially with the operation panel will be saved.)

0V Stop Function

- If the frequency setting signal is a command (panel potentiometer, external potentiometer, 0 to 5V, 0 to 10V, 4 to 20mA) other than the "digital setting with operation panel (parameter P09 = 1)", the inverter will start and stop at a boundary of approx. 1/100 of the input signal's full scale using the factory set data.
- * 0V stop will not take place if the bias/gain function selection (parameter P55) is set to "1", and the bias frequency (parameter P56) is set to "0.1" or more.

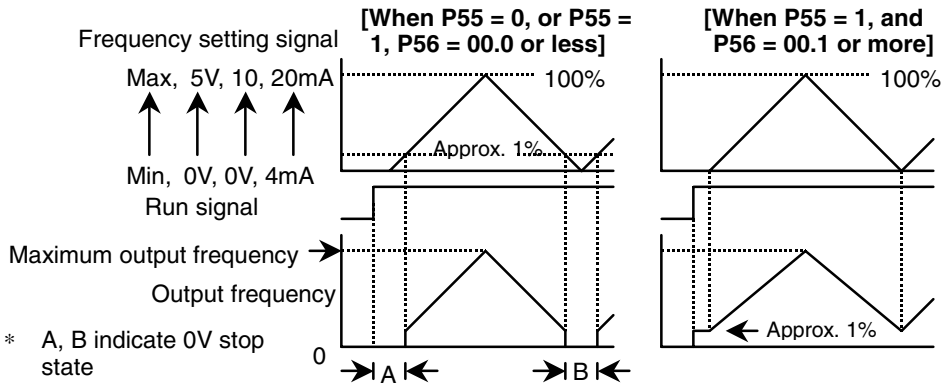

Resetting Fault Trips

- If a fault is displayed on the operation panel's display and the inverter is stopped, remedy the fault before resetting.

Power reset	Turn OFF the power once, then turn it ON again. (Operation can be started when the power is turned ON again.)
Resetting by stop signal	<ol style="list-style-type: none"> (1) When operation is set to local (Parameter P09 set to "0" or "1") The fault will be reset when the "STOP button" on the operation panel is pressed. Operation can be restarted after this. (2) When operation is set to external (Parameter P09 set to "2" or "3") The fault will be reset when the "run command switch" is turned OFF from the external source. Operation can be restarted after this.
Resetting by panel	<ol style="list-style-type: none"> (1) When operation is set to external (Parameter P09 set to "4" or "5") The fault will not be reset even if the "run command switch" is turned OFF from an external source. The fault will be reset when the "STOP button" on the operation panel is pressed. Operation can be restarted after this.
Multi-function terminal reset	<ol style="list-style-type: none"> (1) When setting data is set to "1" for parameters P19, P20 and P21 The fault will be reset when the switch set for the function is turned "ON" and "OFF". Operation can be restarted after this. (Refer to page 68.)

Individual Details and Remedies for Fault Trips

- Fault trip memory ... The cause of the trip is saved in parameters P67 to P70. The details on the latest trip and the three prior trips is saved even if the power is turned OFF. (The details of the shipment inspection are saved when the unit is shipped.)

Display	Details and cause of faults	Remedies
SC1	<ul style="list-style-type: none"> • Instantaneous overcurrent during acceleration or abnormal heating of heat sink fins 	<ul style="list-style-type: none"> • Check for an output short-circuit or ground fault • Check the ambient temperature and fan operation • Increase the acceleration time
SC2	<ul style="list-style-type: none"> • Instantaneous overcurrent during constant speed or abnormal heating of heat sink fins 	<ul style="list-style-type: none"> • Check for output short-circuit and ground fault • Check ambient temperature and fan operation • Eliminate excessive changes in load
SC3	<ul style="list-style-type: none"> • Instantaneous overcurrent during deceleration or abnormal heating of heat sink fins 	<ul style="list-style-type: none"> • Check for output short-circuit and ground fault • Check ambient temperature and fan operation • Increase the deceleration time
OC1	<ul style="list-style-type: none"> • Overcurrent during acceleration 	<ul style="list-style-type: none"> • Check for an open output phase • Increase the acceleration time • Adjust the torque boost level
OC2	<ul style="list-style-type: none"> • Overcurrent during constant speed 	<ul style="list-style-type: none"> • Check for an open output phase • Eliminate excessive changes in load
OC3	<ul style="list-style-type: none"> • Overcurrent during deceleration 	<ul style="list-style-type: none"> • Check for an open output phase • Increase the deceleration time
OU1	<ul style="list-style-type: none"> • Excessive internal DC voltage during acceleration 	<ul style="list-style-type: none"> • Increase the acceleration time
OU2	<ul style="list-style-type: none"> • Excessive internal DC voltage during constant speed 	<ul style="list-style-type: none"> • Eliminate excessive changes in load
OU3	<ul style="list-style-type: none"> • Excessive internal DC voltage during deceleration 	<ul style="list-style-type: none"> • Increase the deceleration time
LU	<ul style="list-style-type: none"> • Power supply voltage drops to less than 85% of rating 	<ul style="list-style-type: none"> • Measure the power supply voltage • Consider using the instantaneous power failure restart function
OL	<ul style="list-style-type: none"> • An output current exceeding 125% of the electronic thermal setting current or 140% or more of the inverter rated current occurs for more than 1 minute 	<ul style="list-style-type: none"> • Check the electronic thermal setting current • Check and adjust the torque boost level • Reduce the load

Display	Details and cause of faults	Remedies
AU	<ul style="list-style-type: none"> • An auxiliary stop signal was input from control circuit terminal 	<ul style="list-style-type: none"> • Check the sequence circuit to confirm that the auxiliary stop signal is correct.
OP	<ul style="list-style-type: none"> • The power was turned ON while the run signal was ON • The run signal was turned ON while setting data in the stopped mode, or the mode was returned to the operation mode with the MODE button 	<ul style="list-style-type: none"> • Check the power loss start mode (parameter P48) • Check the run signal when the data is being set
CPU	<ul style="list-style-type: none"> • Excessive noise was applied on the inverter 	<ul style="list-style-type: none"> • Reduce the noise around the inverter

Note) Refer to "Troubleshooting (1) and (2)" on pages 76 and 78.

Troubleshooting (1)



CAUTION

- Wait at least 5 minutes after turning the input power OFF before starting inspection.
Failure to do so could lead to electric shock.
- Maintenance, inspection and part replacement must be done by qualified persons.
(Remove all metal personal belongings (watches, bracelets, etc.) before starting work.)
(Use tools treated with insulation.)
Failure to do so could lead to electric shock or injury.

1. The motor does not rotate (when fault display is not lit)

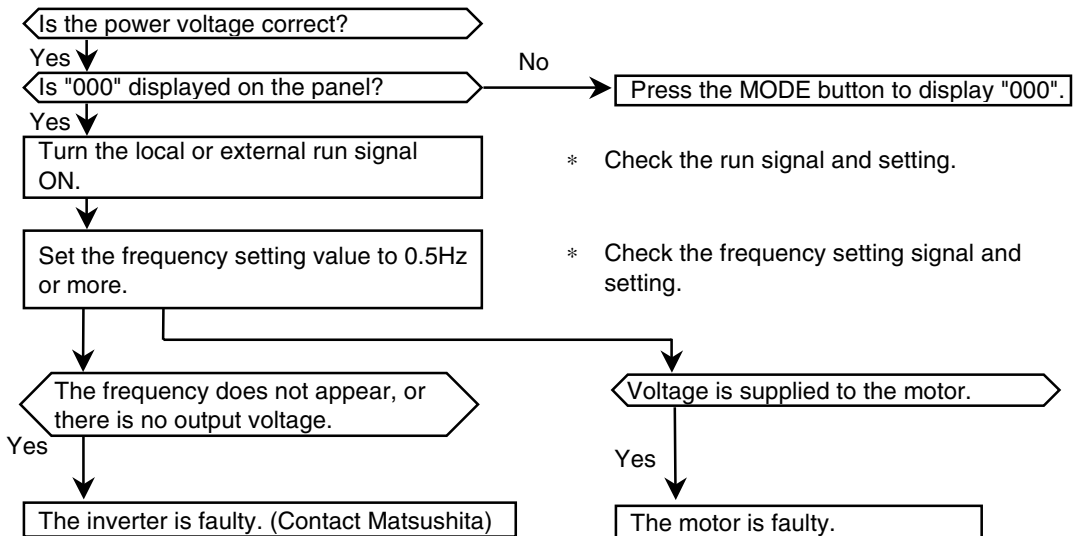

2. The motor does not rotate (when fault display is lit)

When one of the faults on pages 74 and 75 is displayed and the motor has not rotated, check the following:

- (1) Is this the first time (or immediately after installation) power has been applied to the inverter? Check whether it has been in use.
- (2) Check if this is an inverter malfunction (failure), a wiring, or motor malfunction.

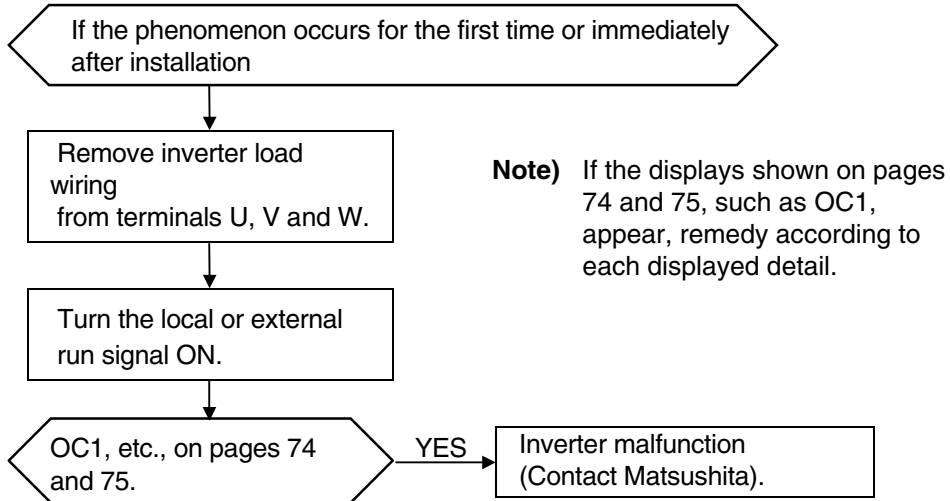

Troubleshooting (2)

1. MCCB trips.

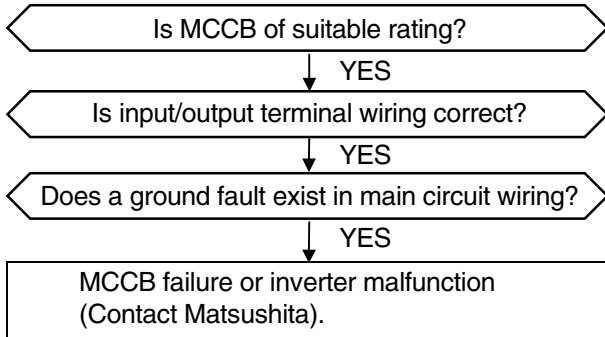

2. Motor has over temperature

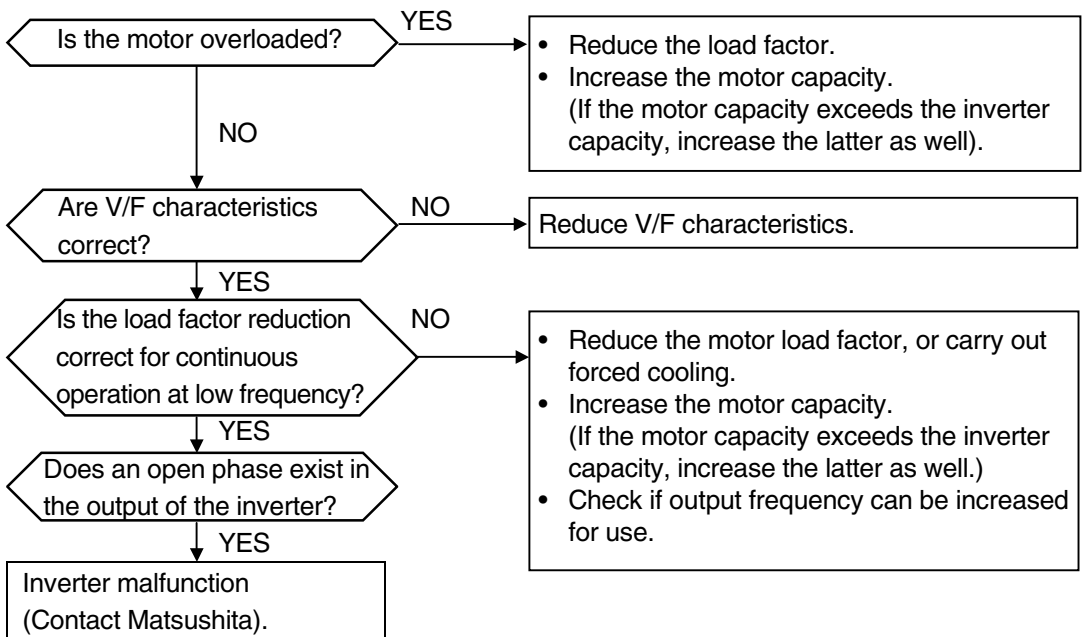

Maintenance and Inspection



CAUTION

- Wait at least 5 minutes after turning the input power OFF before starting inspection.
Failure to do so could lead to electric shock.
- Maintenance, inspection and part replacement must be done by qualified persons.
(Remove all metal personal belongings (watches, bracelets, etc.) before starting the work.) (Use tools treated with insulation.)
Failure to do so could lead to electric shock or injury.



ATTENTION

- Have an electrician periodically tighten the terminal screws.
Loosening of the terminal screws could lead to overheating or fire.

1. Precautions for inspections

- When measuring the insulation between the power line and motor line, always disconnect the wires connected to the inverter first. Do not perform a megger test on the control circuit.
- The inverter is mainly configured of semiconductor elements. So, daily inspections must be carried out to prevent the effect of the working environment such as the temperature, humidity, dust and vibration, to prevent problems that occur due to the passage of part usage and part life.
The standard replacement term that apply when the inverter is used in a general environment (ambient average annual temperature 30°C, load rate of 80% or less, and 12 working hours or less a day) are given on the next page.

2. Inspection items

- 1) Daily inspection : Check that the inverter is operating as intended.
Check the input and output voltages of the inverter during operation using a voltmeter.
- 2) Periodic inspection : Check all locations where inspection can only be performed when the inverter is stopped.

3. Parts replacement

Wear fault (lifetime) ... The lifetime is greatly dependent on the installation conditions.

For example:

- 1) The lifetime of a relay depends on the wear condition of its contact surfaces.
The contact current and load inductance are major factors.
- 2) The capacitor inside the inverter is used mainly as a smoothing filter and its lifetime varies greatly with temperature as internal chemical reactions take place.
Generally, when the temperature of the aluminum electrolytic capacitor increases by 10°C, the life is halved. Thus, the temperature determines the inverter life span.
If the inverter is used at high temperatures, the aluminum electrolytic capacitor could wear out before the other parts. In this case, the capacitor must be replaced to extend the inverter's life.

Part name	Standard replacement	Replacement procedure and others
Cooling fan	2 or 3 years	Replace with a new part
Smoothing capacitor	5 years	Investigate and replace with new part if necessary.
Relays	—	Investigate and replace with new part if necessary.

4. Maintenance and inspection table

Note) Symbols in the check frequency field have the following meanings: ☆ means daily, ○ means yearly and ⊙ means every two years.

Location	Inspection item	Check item	Check frequency			Check method	Test criteria	Instrument
Whole system	Installation condition	Ambient temperature, relative humidity, dust, etc.	☆			See installation precautions.	Ambient temp.: -10 to 50°C Relative humidity: 90% max.	Thermometer Hygrometer
	Whole system	Is there any abnormal vibration or noise?	☆			Visual inspection and audible check	Normal appearance and noise	
	Power voltage	Is the main circuit voltage normal?	☆			Measure the input voltage	323 to 506VAC	Voltmeter
Main circuit	General	(1) Check if all fastenings are tight.		○		(1) Tighten fastenings	(1), (2) Normal	
		(2) Any indication of overheating on any part?		○		(2) Visual inspection		
		(3) Clean		○				
	Connected electrical conductors and wires	(1) Are electrical conductors crooked?		○		(1), (2) Visual inspection	(1), (2) Normal	
		(2) Is the cover broken?		○				
	Transformer reactor	Strange smells?	☆			By smell	Normal	
	Terminal blocks	Is there any damage?		○		Visual inspection	Normal	
	Transistor diode	Check the resistance between terminals.			⊙	Disconnect main circuit wires and measure at terminal		Ohm meter
Smoothing capacitor	(1) Are there any liquid leaks?	☆			(1), (2) Visual inspection	(1), (2) Normal	Capacitance meter	
	(2) Is the safety valve normal?	☆			(3) Using a capacitance meter			(3) Minimum 85% of rated capacity
Relays	(1) Is the operational noise normal?		○		(1) Audible check	(1), (2) Normal		
	(2) Check the state of contact roughness.		○		(2) Visual inspection			
Resistor	(1) Are the insulators cracked?		○		(1), (2) Visual inspection	(1), (2) Normal		
	(2) Are any wires disconnected?		○					

Continued on following page.

Location	Inspection item	Check item	Check frequency	Check method	Test criteria	Instrument
Control and protection circuits	Operation checks	(1) Check output line voltage balance between phases during inverter operation without application. (2) Check the protection and display circuits with the sequence protection operation test.	○ ○	(1) Measure voltage between output terminals. (2) Simulate a short-circuit between the inverter warning outputs.	(1) Line output balance is 4V max. (2) The sequence protection circuit must function correctly.	Rectifier type voltmeter
	All parts	(1) Any strange smells or discoloration? (2) Is there heavy rusting?	○ ○	(1), (2) Visual inspection and smell	(1), (2) Normal	
	Capacitor	Any trace of liquid leaks or deformation?	☆	Visual inspection	Normal	
Cooling system	Cooling fan	(1) Is there any abnormal vibration or abnormal noise? (2) Are any of the connections loose?	☆ ○	(1) Audible check (2) Tighten fastenings	(1), (2) Normal	
Display	Display unit	Are any LEDs not working?	☆	Visual inspection	Normal	
	Meter	Are all readings correct?	☆	Check indicated value	Must be within standard value and control value.	Voltmeter Ammeter
Motor	General	(1) Is there any abnormal vibration or abnormal noise? (2) Strange smells?	☆ ☆	(1), (2) Visual, audible and smell test	(1), (2) Normal	

Specifications

● **Rated specifications**

Three-phase 400V type

Product No.	Applied motor output	Rated output current	Rated output capacity	Power supply capacity	Mass
BFV00074	0.75 kW	2.1 A	1.7 kVA	2.6 kVA	1.4 kg
BFV00154	1.5 kW	3.8 A	3.0 kVA	3.6 kVA	1.4 kg
BFV00224	2.2 kW	5.4 A	4.3 kVA	6.4 kVA	1.4 kg
BFV00374	3.7 kW	8.7 A Note 1)	6.9 kVA	10.4 kVA	2.1 kg

Note 1) The rated output current for the 3.7kW capacity is that for when the carrier frequency is 7.5kHz or less.

When using at 10.0kHz, the rated output current must be reduced by 10%.
(When set to 10kHz: rated output current × 0.9 = 7.83A)

Note 2) The rated output capacity is that for the output voltage 460V.

Note 3) The power supply capacity will change according to the impedance on the power supply side. Prepare a power supply larger than the values given in the table.

● **Standard specifications**

Three-phase 400V type

Applied motor output		0.75 to 3.7kW
Rated output	Rated output voltage	3-phase, 380 to 460VAC (proportional to power supply voltage)
	Overload current rating	150% of rated output current for 1 minute
Input power supply	Number of phases, voltage, frequency	3-phase, 380 to 460VAC: 50/60Hz
	Tolerable voltage variations	+10%, -15% of rated AC input voltage
	Tolerable frequency variations	±5% of rated input frequency
	Instantaneous voltage drop resistance capacity	<ul style="list-style-type: none"> · Continuous operation at 323V or more · Continuous operation at less than 323V for 15 ms.

● Common specifications

Protection against Electric Shock		Class I
Overvoltage category		II
Pollution degree		2
Output frequency	Output frequency range	0.5 to 250Hz
	Frequency display	Digital display
	Frequency accuracy	±0.5% of selected maximum set frequency (25±10°C) for analog setting
	Frequency setting resolution	Digital setting : 0.1Hz (1Hz over 100Hz) Analog setting : 0.1Hz (50/60Hz mode)
Inverter control method		High carrier frequency sinusoidal PWM control (V/F control method)
Carrier frequency		Select from seven types (The output current must be reduced when the 3.7kW capacity is set to 10kHz.) 0.8, 1.1, 1.6, 2.5, 5.0, 7.5, 10.0kHz
Operation	Start/Stop	Operation panel buttons or 1a contact signal (wait time setting possible)
	Forward/Reverse	Operation panel buttons or 1a contact signal (reverse rotation prohibit setting possible)
	Jog operation	Operating frequency: Optional setting for 0.5 to 250Hz Acceleration/deceleration time: Optional setting each for 0.04 to 999 seconds
	Stop mode	Select from ramp-to-stop or coast-to-stop (selection changeover)
	Reset function	Stop signal reset, external reset, panel reset (setting possible) and power supply reset
	Stop frequency	Optional setting from 0.5 to 60Hz
	Instantaneous power failure restart	Function OFF, and 0Hz restart, operating frequency restart (selection changeover)
	Retry function	Retry selection : Select function OFF and details of retry fault No. of retries : Optional setting for 1 to 10 times
Control	Frequency setting signal	Local setting: Potentiometer, digital setting (operation panel) External analog setting signal: · Potentiometer (10kΩ, 1/4W or more) · 0 to 5V, 0 to 10V · 4 to 20mA (Connect a 200Ω, 1/4W or more external resistor) External digital setting signal: · PWM signal (signal cycle: 0.9 to 1100ms) · Frequency up SW, down SW, save SW signal
	Voltage/frequency characteristics	Base frequency : 50, 60Hz fixed and optional setting between 45 and 250Hz V/F curve : Constant torque, square torque pattern (selection changeover)

Control	2nd voltage/ frequency characteristics	Optional base frequency setting for 45 to 250Hz
	Torque boost	Optional setting for 0 to 40%
	2nd torque boost level	Optional setting for 0 to 40%
	Accel./Decel. time	0.04 to 999 sec. (individual accel. and decel. time setting)
	Accel./Decel. characteristics	Linear
	2nd accel./Decel. time	0.1 to 999 sec. (individual accel. and decel. time setting)
	Multi-speed frequency setting	Up to 8 preset frequency settings (optional setting)
	Skip frequency setting	Up to 3 place settings (skip frequency band setting from 1 to 10Hz)
	Upper frequency setting	Optional setting from 0.5 to 250Hz
	Lower frequency setting	Optional setting from 0.5 to 250Hz
	Bias/gain frequency settings	Bias frequency : set from -99 to 250Hz Gain frequency : set from 0 to 250Hz
External stop function	Select from auxiliary stop or coast-to-stop (selection setting)	
Braking	Regenerative braking torque	20% or more 100% or more when brake resistor (option) is connected.
	DC braking	Operates when less than stop frequency Braking torque level : 0 to 100 (set between 20 levels) Braking time : Optional setting for 0.1 to 120 seconds
Output signal	Analog output	Output specifications : 0 to 5V (max. 1mA) Output functions : Output frequency, output current proportional (selection changeover)
	Open collector output	Output specifications : Max. rating 50VDC, 50mA Output functions : Run signal, arrival signal, overload prealarm, frequency detection, reverse run signal, fault warning, output frequency/current proportional PWM signal (cycle 1ms)

Output signal	Relay output	Output specifications : 1c contact (contact capacity 250VAC, 0.5A resistance load) Output functions : Run signal, arrival signal, overload prealarm, frequency detection, reverse run signal, fault warning,
	Display	Operating condition : Output frequency or line speed (selection changeover), output current, rotation direction Fault details : Symbol indicated when protective function activates (last 4 faults are stored).
Protection	Current limit	Current limit can be set from 1 to 200% of rated output current
	Shut-off (stop)	Instantaneous overcurrent, over temperature (SC1 to 3), overcurrent (OC1 to 3), overload/electronic thermal overload (OL), low voltage (LU), overvoltage (OU1 to 3), auxiliary stop (AU), , operation error (OP)
	Stall prevention function	Overcurrent stall prevention, regenerative overvoltage stall prevention
Environment	Working ambient temperature and humidity	-10°C to +50°C (with no freezing), 90% RH or less (with no dew condensation)
	Transportation/ storage temperature and humidity	-25°C to +65°C, 95% RH or less
	Altitude and vibration	1000 m or less, 5.9 m/s ² (0.6G) or less
	Atmosphere	Indoors, with no corrosive gases, explosive gases, oil mist or dust present
Enclosure		IP00
Cooling method		Self-cooling : 0.75kW, Forced-air cooling : 1.5 to 3.7kW

ATTENTION

- This product is not designed or manufactured to be used in equipment or systems in situations that can affect or endanger human life.
When considering this product for operation in special applications such as machinery or systems used in movable body, medical, aerospace, nuclear energy, or submarine relay applications, please contact your nearest Matsushita dealer.
- Although this product was manufactured under strict quality control conditions, it is strongly advised to install safety devices to forestall serious accidents when used in facilities where a breakdown of this product is likely to cause a serious human injury or generate major losses.
- Consult with your Matsushita dealer when using this product for loads other than a 3-phase AC motor.

Panasonic Electric Works Co., Ltd.

AUTOMATION CONTROLS GROUP

Head Office : 1048, Kadoma, Kadoma-shi, Osaka 571-8686, Japan
Telephone : Japan (81) Osaka (06) 6908-1050
Facsimile : Japan (81) Osaka (06) 6908-5781

Panasonic Electric Works Europe AG,

Rudolf-Diesel-Ring 2, D-83607 Holzkirchen, Germany
Telephone : 49-8024-648-0
Facsimile : 49-8024-648-111

Panasonic Electric Works Corporation of America,

629 Central Avenue, New Providence, New Jersey 07974, U.S.A.
Telephone : 1-908-464-3550
Facsimile : 1-908-771-5658

Panasonic Electric Works Asia Pacific Pte. Ltd.

101 Thomson Road, #25-03/05, United Square, Singapore 307591
Telephone : 65-255-5473

Panasonic Electric Works (China) Co., Ltd.

Suite 201 Level 2, Tower W3, The Towers, Oriental Plaza, No.1, East Chang An Avenue, Dong Cheng District, Beijing, 100005, China
Telephone : 86-10-6590-8646

COPYRIGHT © 2002 All Rights Reserved