

CNC SYSTEMS

OSP-U100M

OSP-U10M

MX-V SERIES

MAINTENANCE MANUAL

(1st Edition)

Pub. No. 4194-E (ME34-040-R1) May 1998



SAFETY PRECAUTIONS

The machine is equipped with safety devices which serve to protect personnel and the machine itself from hazards arising from unforeseen accidents. However, operators must not rely exclusively on these safety devices: they must also become fully familiar with the safety guidelines presented below to ensure accident-free operation.

This instruction manual and the warning signs attached to the machine cover only those hazards which Okuma can predict. Be aware that they do not cover all possible hazards.

1. Precautions Relating to Machine Installation

- (1) Install the machine at a site where the following conditions (the conditions for achievement of the guaranteed accuracy) apply.
 - Ambient temperature: 17 to 25°C
 - Ambient humidity: 40% to 75% at 20°C (no condensation)
 - Site not subject to direct sunlight or excessive vibration; environment as free of dust, acid, corrosive gases, and salt spray as possible.
- (2) Prepare a primary power supply that complies with the following requirements.
 - Voltage: 200 V
 - Voltage fluctuation: ± 10% max.
 - Power supply frequency: 50/60 Hz
 - Do not draw the primary power supply from a distribution panel that also supplies a major noise source (for example an electric welder or electric discharge machine) since this could cause malfunction of the CNC unit.
 - If possible connect the machine to a ground not used by any other equipment. If there is no choice but to use a common ground, the other equipment must not generate a large amount of noise (such as an electric welder or electric discharge machine).
- (3) Installation Environment

Observe the following points when installing the control enclosure.

 - Make sure that the CNC unit will not be subject to direct sunlight.
 - Make sure that the control enclosure will not be splashed with chips, water, or oil.
 - Make sure that the control enclosure and operation panel are not subject to excessive vibrations or shock.
 - The permissible ambient temperature range for the control enclosure is 0 to 40°C.
 - The permissible ambient humidity range for the control enclosure is 30 to 95% (no condensation).
 - The maximum altitude at which the control enclosure can be used is 1000 m (3281 ft.).

2. Points to Check before Turning on the Power

- (1) Close all the doors of the control enclosure and operation panel to prevent the entry of water, chips, and dust.
- (2) Make absolutely sure that there is nobody near the moving parts of the machine, and that there are no obstacles around the machine, before starting machine operation.
- (3) When turning on the power, turn on the main power disconnect switch first, then the CONTROL ON switch on the operation panel.

3. Precautions Relating to Operation

- (1) After turning on the power, carry out inspection and adjustment in accordance with the daily inspection procedure described in this instruction manual.
- (2) Use tools whose dimensions and type are appropriate for the work undertaken and the machine specifications. Do not use badly worn tools since they can cause accidents.
- (3) Do not for any reason touch the spindle or tool while spindle indexing is in progress since the spindle could rotate: this is dangerous.
- (4) Check that the workpiece and tool are properly secured.
- (5) Never touch a workpiece or tool while it is rotating: this is extremely dangerous.
- (6) Do not remove chips by hand while machining is in progress since this is dangerous. Always stop the machine first, then remove the chips with a brush or broom.
- (7) Do not operate the machine with any of the safety devices removed. Do not operate the machine with any of the covers removed unless it is necessary to do so.
- (8) Always stop the machine before mounting or removing a tool.
- (9) Do not approach or touch any moving part of the machine while it is operating.
- (10) Do not touch any switch or button with wet hands. This is extremely dangerous.
- (11) Before using any switch or button on the operation panel, check that it is the one intended.

4. Precautions Relating to the ATC

- (1) The tool clamps of the magazine, spindle, etc., are designed for reliability, but it is possible that a tool could be released and fall in the event of an unforeseen accident, exposing you to danger: do not touch or approach the ATC mechanism during ATC operation.
- (2) Always inspect and change tools in the magazine in the manual magazine interrupt mode.
- (3) Remove chips adhering to the magazine at appropriate intervals since they can cause misoperation.
Do not use compressed air to remove these chips since it will only push the chips further in.
- (4) If the ATC stops during operation for some reason and it has to be inspected without turning the power off, do not touch the ATC since it may start moving suddenly.

5. On Finishing Work

- (1) On finishing work, clean the vicinity of the machine.
- (2) Return the ATC, APC and other equipment to the predetermined retraction position.
- (3) Always turn off the power to the machine before leaving it.
- (4) To turn off the power, turn off the CONTROL ON switch on the operation panel first, then the main power disconnect switch.

6. Precautions during Maintenance Inspection and When Trouble Occurs

In order to prevent unforeseen accidents, damage to the machine, etc., it is essential to observe the following points when performing maintenance inspections or during checking when trouble has occurred.

- (1) When trouble occurs, press the emergency stop button on the operation panel to stop the machine.
- (2) Consult the person responsible for maintenance to determine what corrective measures need to be taken.
- (3) If two or more persons must work together, establish signals so that they can communicate to confirm safety before proceeding to each new step.
- (4) Use only the specified replacement parts and fuses.
- (5) Always turn the power off before starting inspection or changing parts.
- (6) When parts are removed during inspection or repair work, always replace them as they were and secure them properly with their screws, etc.
- (7) When carrying out inspections in which measuring instruments are used – for example voltage checks – make sure the instrument is properly calibrated.
- (8) Do not keep combustible materials or metals inside the control enclosure or terminal box.
- (9) Check that cables and wires are free of damage: damaged cables and wires will cause current leakage and electric shocks.
- (10) Maintenance inside the Control Enclosure
 - a) Switch the main power disconnect switch OFF before opening the control enclosure door.
 - b) Even when the main power disconnect switch is OFF, there may be some residual charge in the servo amplifier and spindle drive unit, and for this reason only service personnel are permitted to perform any work on these units. Even then, they must observe the following precautions.
 - Servo amplifier
Discharge the residual voltage one minute after turning off the breaker inside the unit.
 - Spindle drive unit
Discharge the residual voltage one minute after turning off the main power disconnect switch.
 - c) The control enclosure contains the NC unit, and the NC unit has a printed circuit board whose memory stores the machining programs, parameters, etc. In order to ensure that the contents of this memory will be retained even when the power is switched off, the memory is supplied with power by a battery. Depending on how the printed circuit boards are handled, the contents of the memory may be destroyed and for this reason only service personnel should handle these boards.

(11) Periodic Inspection of the Control Enclosure

a) Cleaning the cooling unit

The cooling unit in the door of the control enclosure serves to prevent excessive temperature rise inside the control enclosure and increase the reliability of the NC unit. Inspect the following points every three months.

- Is the fan motor inside the cooling unit working?

The motor is normal if there is a strong draft from the unit.

- Is the external air inlet blocked?

If it is blocked, clean it with compressed air.

7. General Precautions

- (1) Keep the vicinity of the machine clean and tidy.
- (2) Wear appropriate clothing while working, and follow the instructions of someone with sufficient training.
- (3) Make sure that your clothes and hair cannot become entangled in the machine. Machine operators must wear safety equipment such as safety shoes and safety goggles.
- (4) Machine operators must read the instruction manual carefully and make sure of the correct procedure before operating the machine.
- (5) Memorize the position of the emergency stop button so that you can press it immediately at any time and from any position.
- (6) Do not access the inside of the control panel, transformer, motor, etc., since they contain high-voltage terminals and other components which are extremely dangerous.
- (7) If two or more persons must work together, establish signals so that they can communicate to confirm safety before proceeding to each new step.

8. Symbols Used in This Manual

The following warning indications are used in this manual to draw attention to information of particular importance. Read the instructions marked with these symbols carefully and follow them.



: Indicates an imminent hazard which, if not avoided, will result in death or serious injury.



: Indicates hazards which, if not avoided, could result in death or serious injury.



: Indicates hazards which, if not avoided, could result in minor injuries or damage to devices or equipment.



: Indicates precautions relating to operation or use.

TABLE OF CONTENTS

	<u>PAGE</u>
SECTION 1 OUTLINE OF OSP	1
1. System Configuration	1
2. I/O Link and Servo Link	2
3. Construction and Outline of Units	3
3-1. CPU Unit	3
3-2. NC Rack	3
3-3. NC PCB's	4
3-4. Power Supply Unit	5
3-5. FieldNet Unit (I/O Unit)	6
3-6. Servo Unit	18
3-7. Motors and Position Encoders	18
3-8. Floppy Disk Drive Unit	18
3-9. Operation Panel	19
3-10. Cooling Unit	19
3-11. Control Enclosure	19
SECTION 2 MAINTENANCE AND INSPECTION	20
1. Inspection during Installation	20
1-1. Installation Site	20
1-2. Environmental Requirements	20
1-3. Primary Power Supply	21
1-4. Input Voltage Range Including Voltage Variation	21
1-5. Momentary Voltage Variation Rate and Power Source Inductance	22
2. Daily Inspection	24
2-1. Daily Inspection	24
2-2. Every Three-month Inspection	24
2-3. Cleaning the Floppy Disk Drive	24
SECTION 3 TROUBLES AND TROUBLESHOOTING	26
1. General Check Procedure When Trouble Occurs	26
2. Trouble Analysis	27

	<u>PAGE</u>
3. Checking the Input/Output Signals	28
3-1. Checking the Input/Output Signals at the CHECK DATA Screen	28
4. CPU Status Indication	31
5. Power Supply Unit Status Indication	33
6. Inspection of Overload Relay	35
7. Releasing Travel-end Limit	36
8. Check by Machine Diagnosis Messages	37
SECTION 4 SELF-DIAGNOSTIC FUNCTION	38
1. Alarm and Error Display	39
2. Check Data Display	40
2-1. NC Axis Data	42
2-2. Machine Axis Data	43
2-3. I/O Check	44
3. CNC Diagnostic Screen	69
4. Machine Diagnostic Screen	69
SECTION 5 MACHINE OPERATION CONDITIONS, DIAGNOSIS MESSAGES, AND LOGIC TABLES	70
1. Machine Operation Conditions	70
2. Machine Diagnosis Messages	72
3. ATC/APC Operation	83
4. ATC/ACP Logic Table	86
4-1. How to Read Logic Tables	86
4-2. ATC Logic Table (MX-45VA/45VB/55VA/55VB)	89
4-3. APC Logic Table (MX-45VA/45VB/55VA/55VB)	96
SECTION 6 PLC MONITOR FUNCTION	103
1. Outline of PLC Monitor Function	103
2. Calling the PLC Monitor Function	104
3. Function Details	105
3-1. PLC Data Display Function	105
3-2. Ladder Diagram Monitor Function	116

	<u>PAGE</u>
3-3. Data Trace Function	125
SECTION 7 PLC PROGRAM INSTRUCTIONS	137
1. Outline of PLC Program Instructions	137
1-1. Basic Instructions	137
1-2. Application Instructions	137
1-3. System Function Module	148
SECTION 8 INSTALLING SOFTWARE	158
1. Outline of Install	158
2. Glossary of Technical Terms	159
2-1. Flash Memory (FR)	159
2-2. Memory Disk (MD)	159
2-3. Install	159
2-4. Package Floppy Disk	160
2-5. Custom Floppy Disk	160
2-6. System Backup Floppy Disk	160
2-7. Work Disk	160
3. Media Necessary for Installing Software	161
3-1. Control Floppy Disks	161
3-2. System Backup Floppy Disk	166
3-3. Work Disk	166
4. Steps for Installing Software	167
5. Procedure for Installing Software	168
5-1. Checking the Hardware Configuration	168
5-2. MD Initialization Processing	169
5-3. Data Backup	171
5-4. Installing the Control Software	174
5-5. Loading the Backup Data	177
SECTION 9 CHANGING THE BATTERY	179
1. Battery Life Warning	179
2. Changing the Battery	180

	<u>PAGE</u>
SECTION 10 APPENDIX	184
1. Accessories	184
1-1. Check Sheet (Control System)	184
1-2. OSP Control Card	184
1-3. Floppy Disks	184
2. NC Operation Panel	185
3. Machine Operation Panel	188
4. Other Operation Panels	190

SECTION 1 OUTLINE OF OSP

1. System Configuration

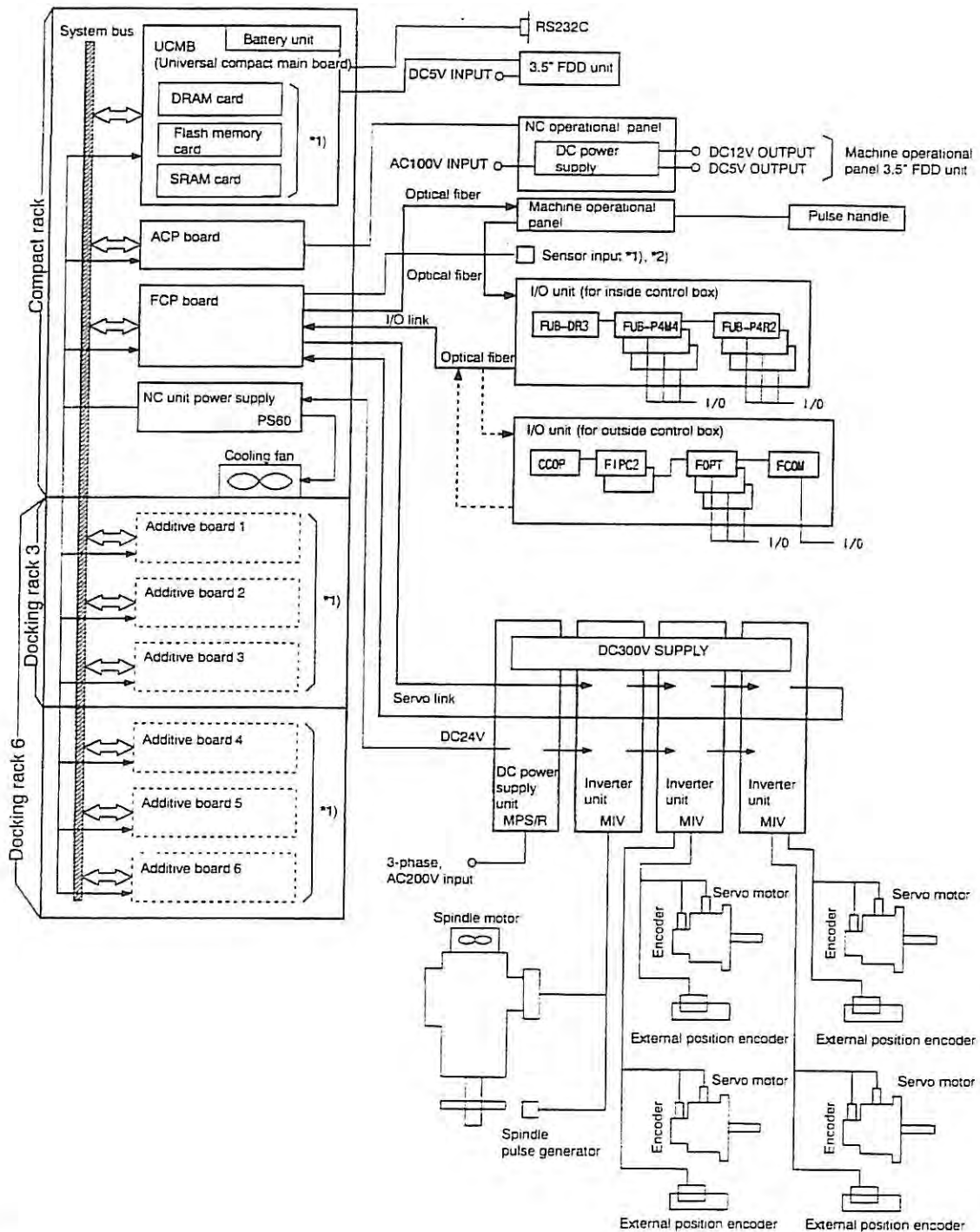

Note:

*1) A quantity and unit selection change by the specification.

*2) Existence is chosen by the specification.

Fig. 1-1 System Configuration

2. I/O Link and Servo Link

In the I/O link, network is formed between an I/O unit (slave station) and an FCP board (master station) to transfer the data. At an I/O unit, communications of the data is executed via the input from pushbutton switches, output to lamps, input from limit switches, output to solenoids, etc.

In the servo link, network is formed between a servo/spindle control unit and an FCP board to execute high-speed data communications. The servo/spindle control unit controls feed axes and the spindle.

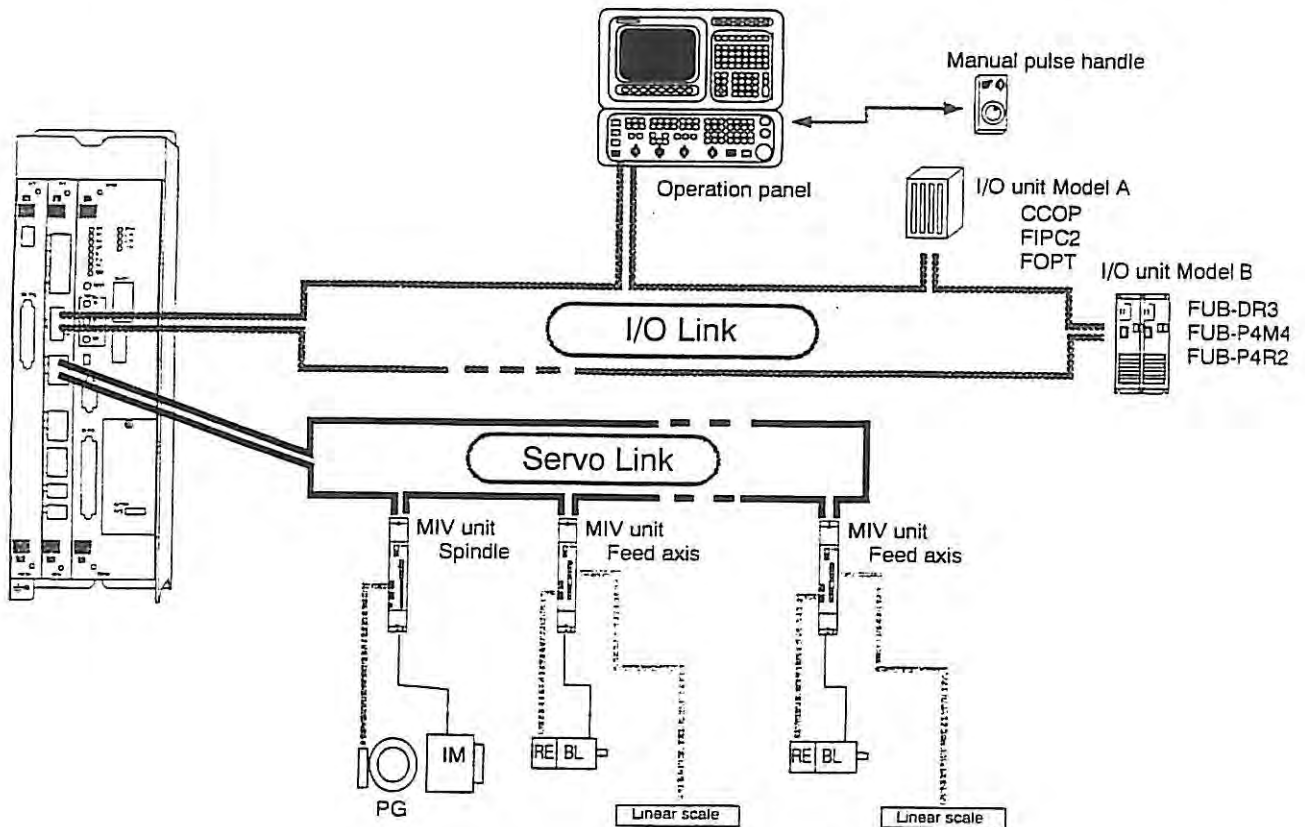

Fig. 1-2 I/O Link and Servo Link

3-3. NC PCB's

(1) UCMB (Universal Compact Main Board)

The UCMB functions as the first main CPU to control the entire system.

As an interface, the UCMB has one channel of RS232C interface and the 3.5-inch floppy disk drive interface.

DRAM is used as the main memory and a DRAM card is installed. For the system memory, flash memory and SRAM are used, and a flash memory card and an SRAM card are installed. A battery unit is installed to back up the SRAM memory card.



: When removing the UCMB from the NC rack with the battery unit connected to it, pay attention so that IC pins and connector pins will not be short circuited. Short circuit of these pins could cause malfunctioning, battery wear, and loss of information stored in memory.

(2) FCP Board

The FCP board has the following on it; CPU and memory of the built-in PLC, I/O link interface, servo link interface, sensor interface, and timing generator.

(3) ACP Board

The ACP board controls the operation panel including key operation at the keyboard and also the screen display at the NC operation panel.



: IC's and other electronic devices used in an NC PCB are susceptible to static electricity. Therefore, an NC PCB must be handled very carefully when it is removed from the NC rack.
Since removal of an NC PCB from the NC rack while power is on could cause malfunctioning of a power supply unit and the NC PCB, do not remove an NC PCB from the NC rack while power is on.

3-4. Power Supply Unit

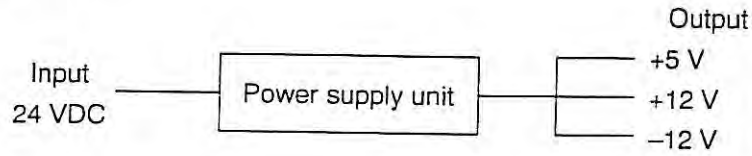

Fig. 1-4

Receiving 24 VDC, the power supply unit supplies the CPU DC power (+5 V, +12 V, -12V) as shown in Fig. 1-4.

The power supply unit is located at the upper right part in the compact rack (OSP CPU unit) and connection to 24 VDC input and other devices are made through the connectors using special cables.

The power supply unit has the monitor function to check input and output voltages constantly. It stops the CPU if an error is detected in the 24 VDC input or the +5 VDC output. For details, refer to SECTION 3, 5. "Power Supply Unit Status Indication".

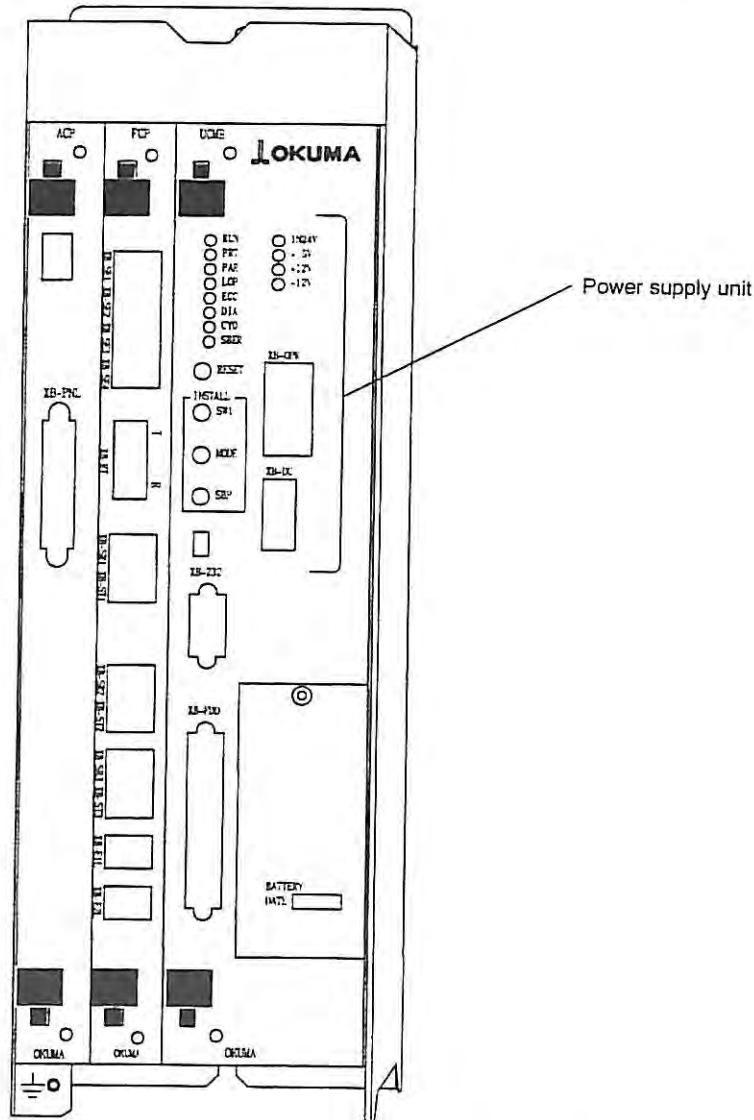

Fig. 1-5 Power Supply Unit

3-5. FieldNet Unit (I/O Unit)

The FieldNet unit controls inputs and outputs between the machine and the CNC unit.

Two types of FieldNet units, Model A and Model B, are provided according to the purpose of the control.

Model B

- FUB-DR3

The unit having the FieldNet interface and the power sequence function. It has a built-in optical conversion module.

- FUB-P4M4

The unit controlling inputs and outputs for external devices.

It has built-in inputs and outputs indicated below:

Photocoupler inputs (P): 4 bytes

Power MOS IC outputs (M): 4 bytes

- FUB-P4R2

The unit controlling inputs and outputs for external devices.

It has built-in inputs and outputs indicated below:

Photocoupler inputs (P): 4 bytes

Relay outputs (R): 2 bytes

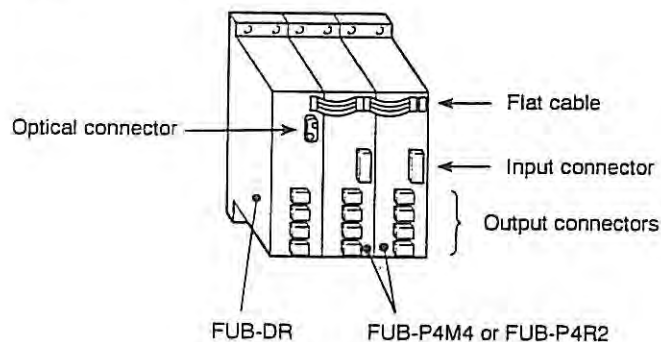

Model A

- CCOP

The interface which incorporates an optical conversion module. One card is necessary for each slave station.

- F1PC2

The card inputting signals from an external device.

Photocoupler inputs: 2 bytes

- FOPT

The card outputting signals to an external device.

Power transistor output: 1 byte

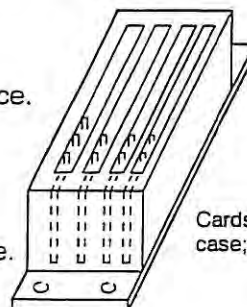

Cards are mounted in the terminal box type case; tab type terminals are provided.

(1) FUB-DR3

Equivalent relay circuit:

The circuit diagram in Fig. 1-6 shows the power sequence circuit of FUB-DR3 in the form of equivalent relay circuit.

With exceptions of several relay outputs, outputs are power MOS IC outputs.

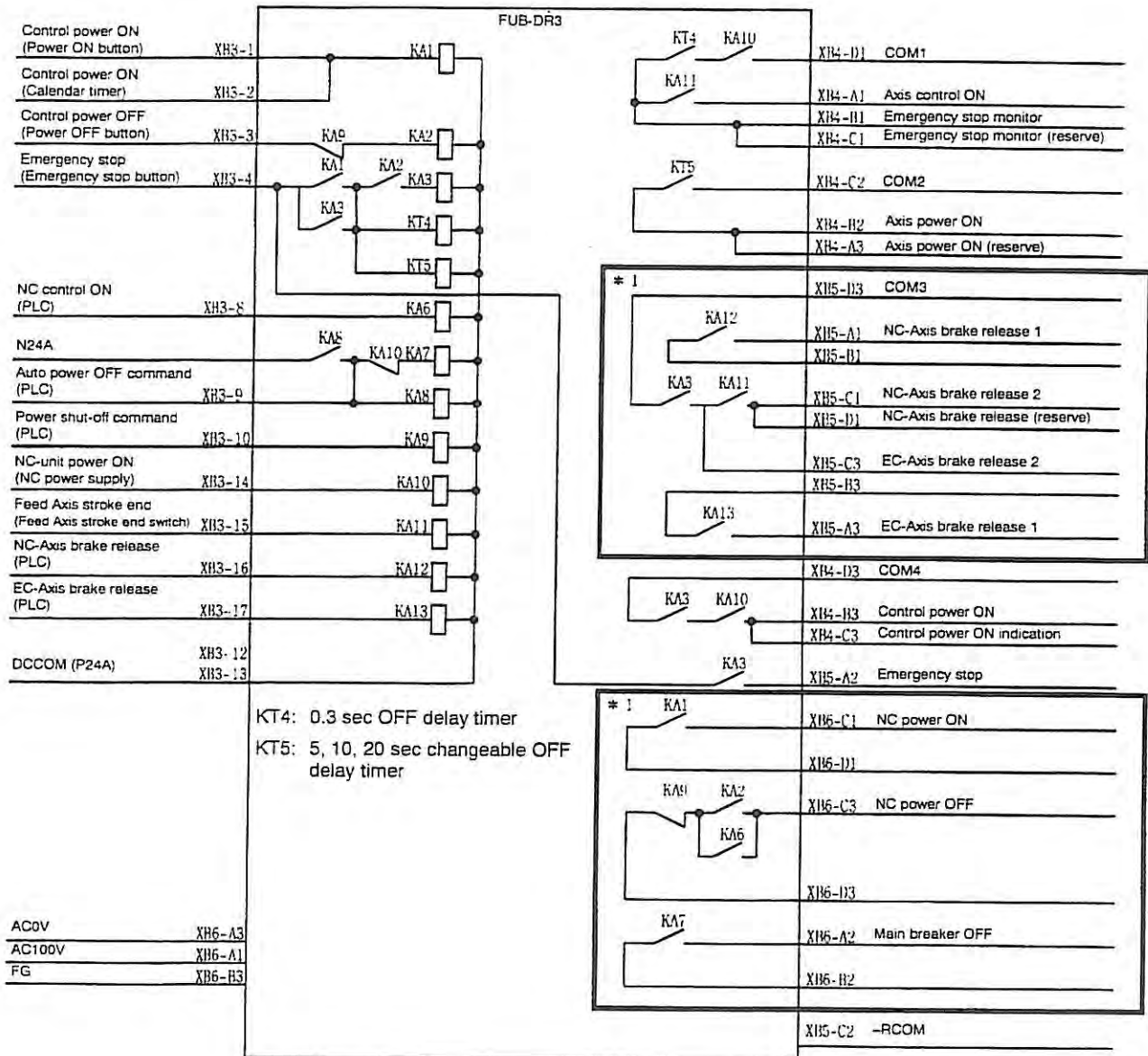

Fig. 1-6

Input section:

Rating of input: 24 VDC, 14 mA typ.

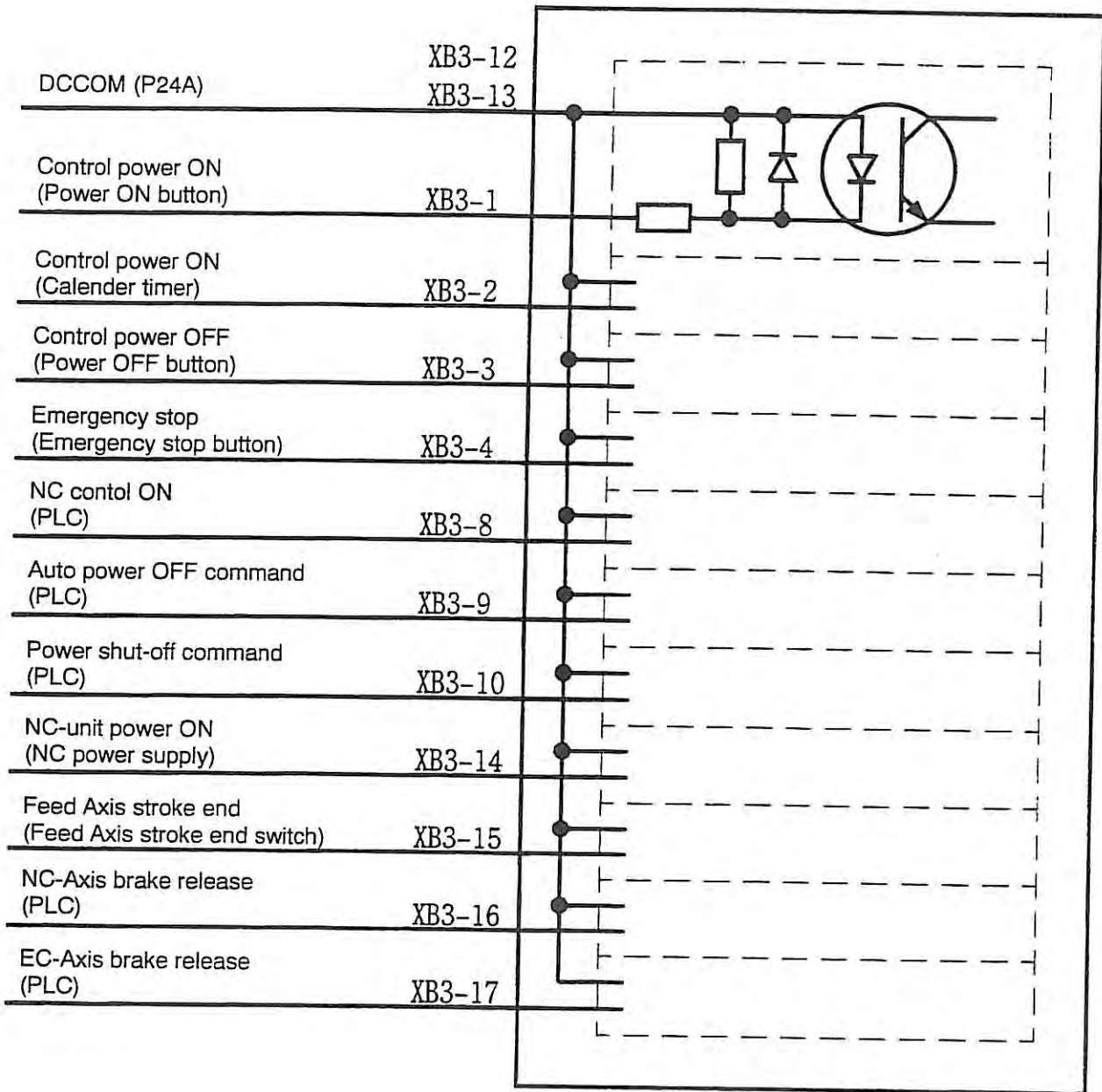

Fig. 1-7

Power MOS IC output section:

Rating of output: 2 A (24 VDC)

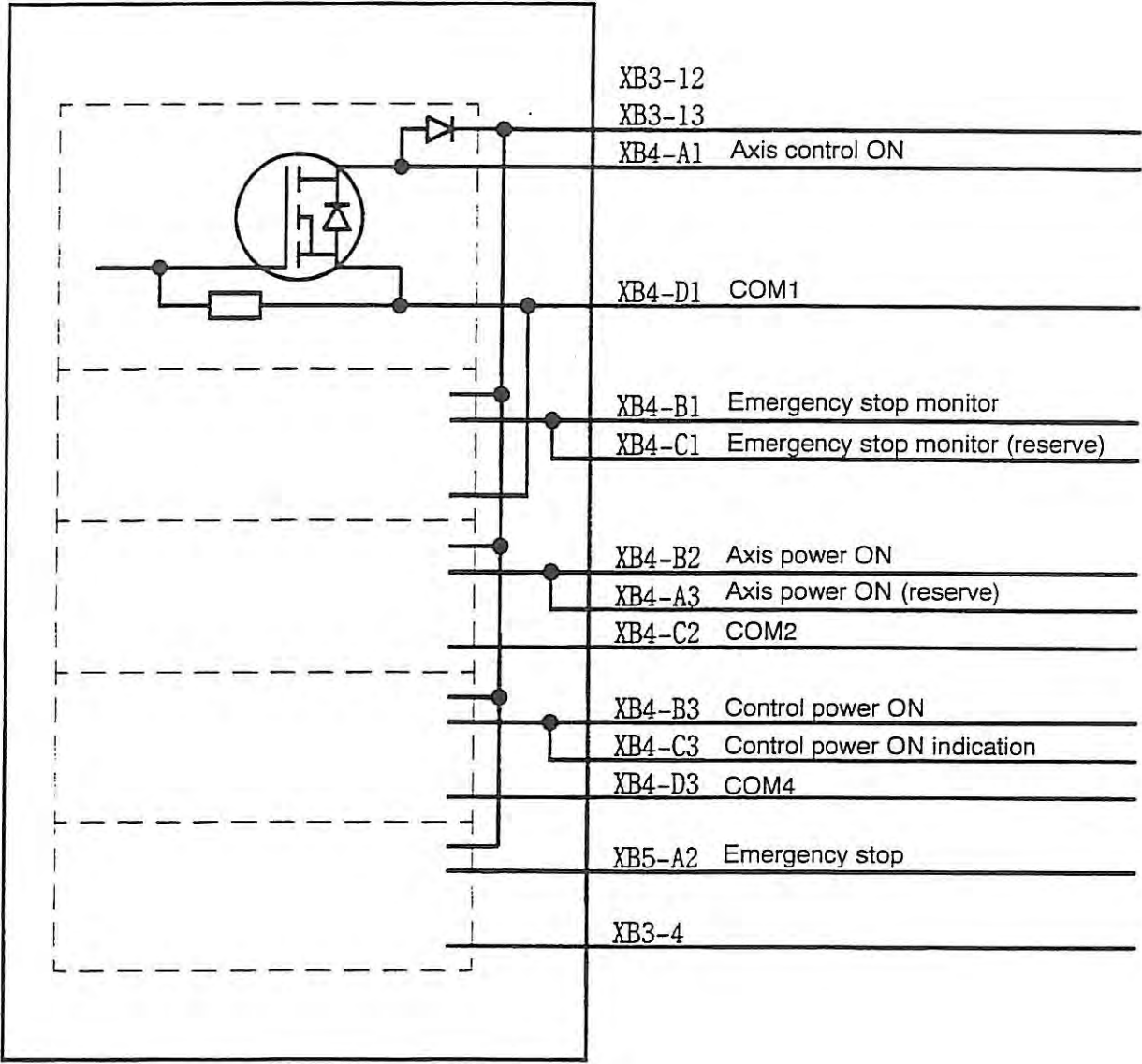

Fig. 1-8

Relay output section:

Allowable max. relay contact current:

Contacts marked with "*1" 5 A (30 VDC, 250 VAC, resistance load)

Contacts marked with "*2" 2 A (30 VDC, 250 VAC, resistance load)

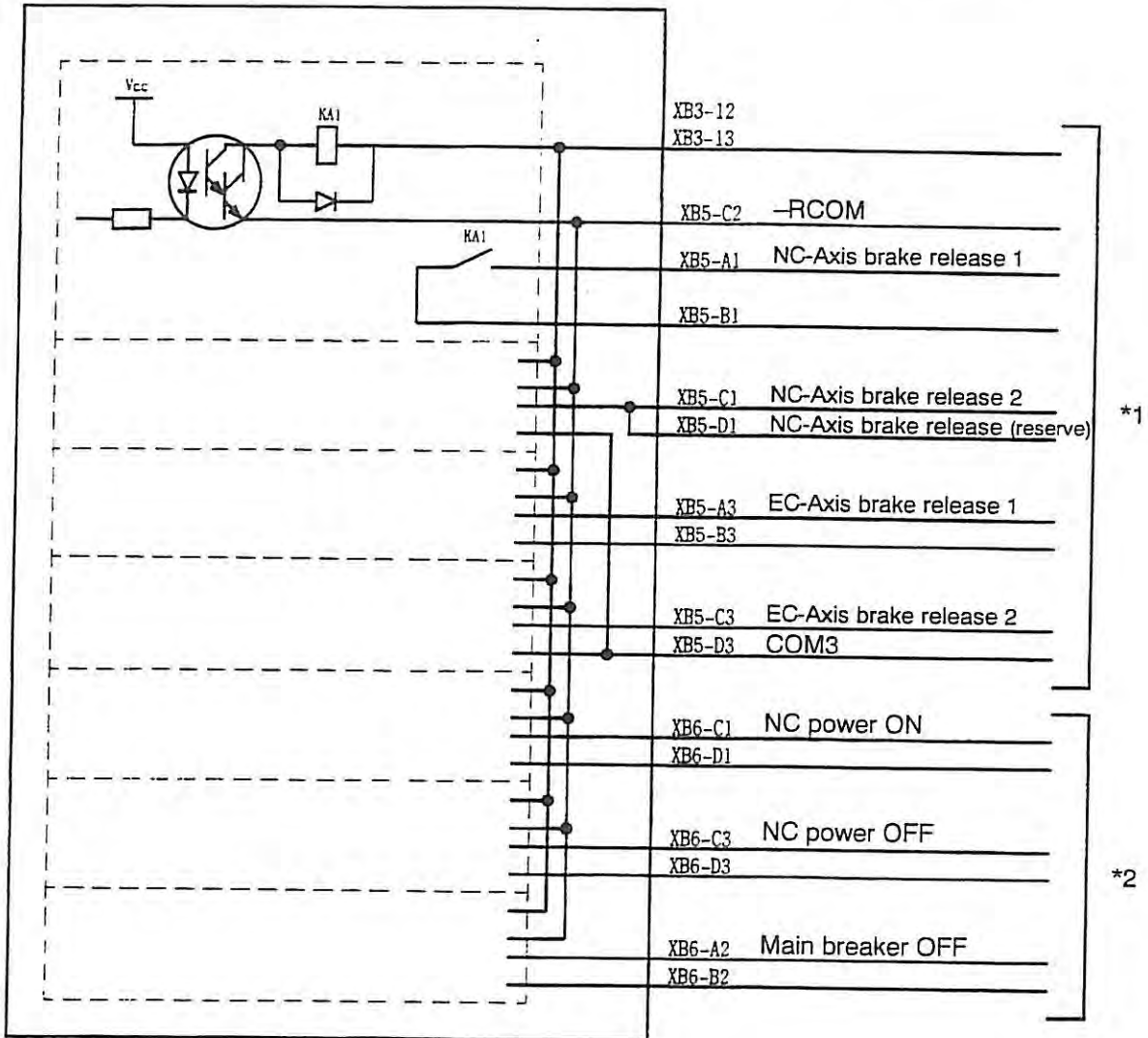

Fig. 1-9

LED display circuit:

On the FUB-DR3, when an output signal is turned ON, the corresponding green LED (OUT1 - OUT12) is lit. The table below shows the correspondence between the LED indicators and output signals.

Indicator (Green LED)	Output Signal
OUT1	Axis control ON
OUT2	Emergency stop monitor
OUT3	Axis power ON
OUT4	NC-Axis brake release 1
OUT5	NC-Axis brake release 2
OUT6	EC-Axis brake release 1
OUT7	EC-Axis brake release 2
OUT8	Control power ON/Power ON indication LED
OUT9	NC power ON
OUT10	NC power OFF
OUT11	Main breaker OFF
OUT12	Emergency stop

The FUB-DR3 has an oscillator of 100 Hz and the yellow LED (OSCSTP) lights if the oscillator stops.

Indicator (Yellow LED)	Conditions for Lighting
OSCSTP	Stopping of oscillator

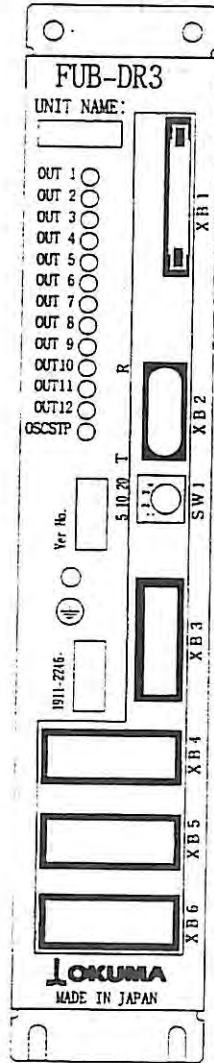

Fig. 1-10

(2) Input Section of FUB-P4M4 and FUB-P4R2

The photocoupler input circuit is common to these two types of cards.

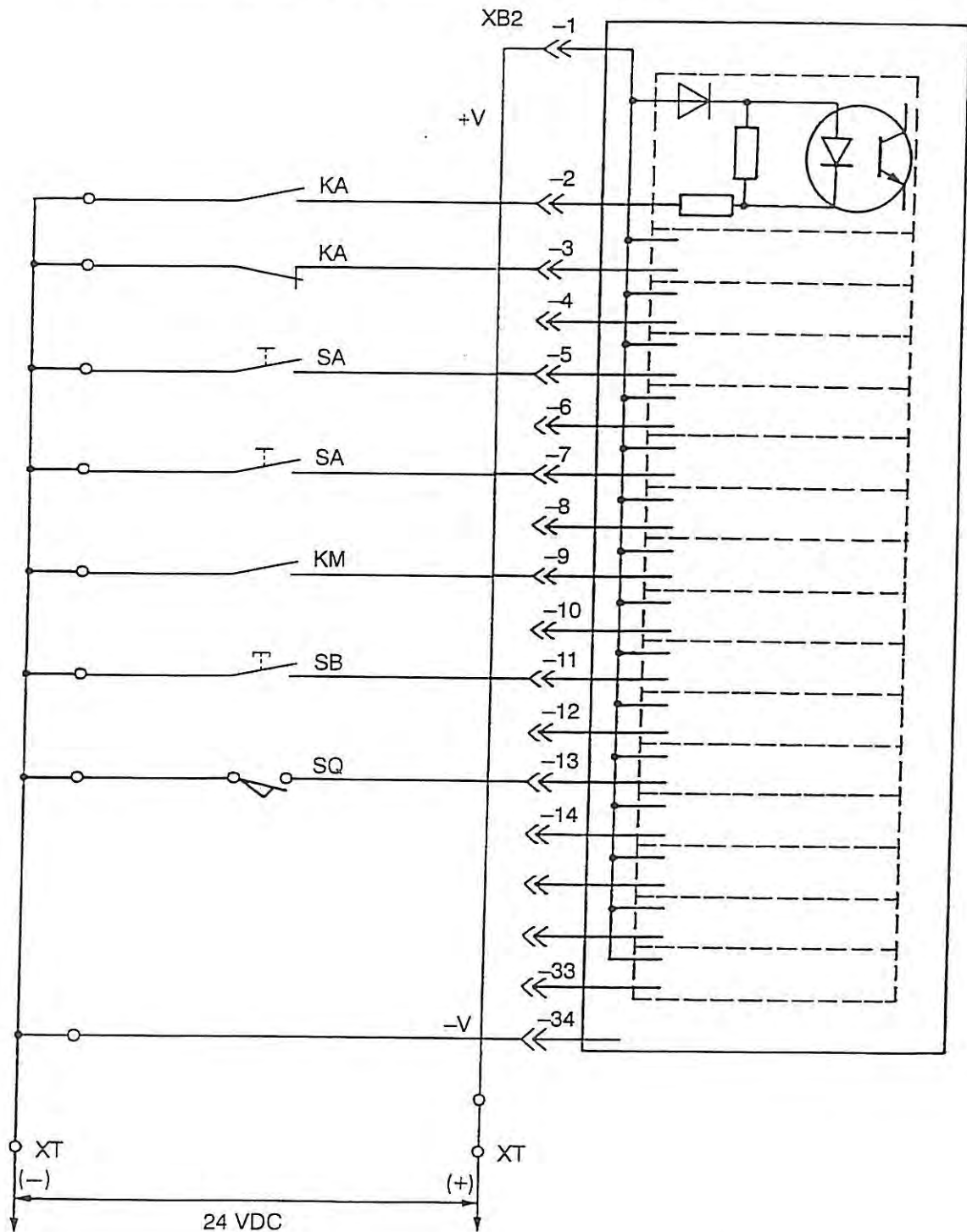
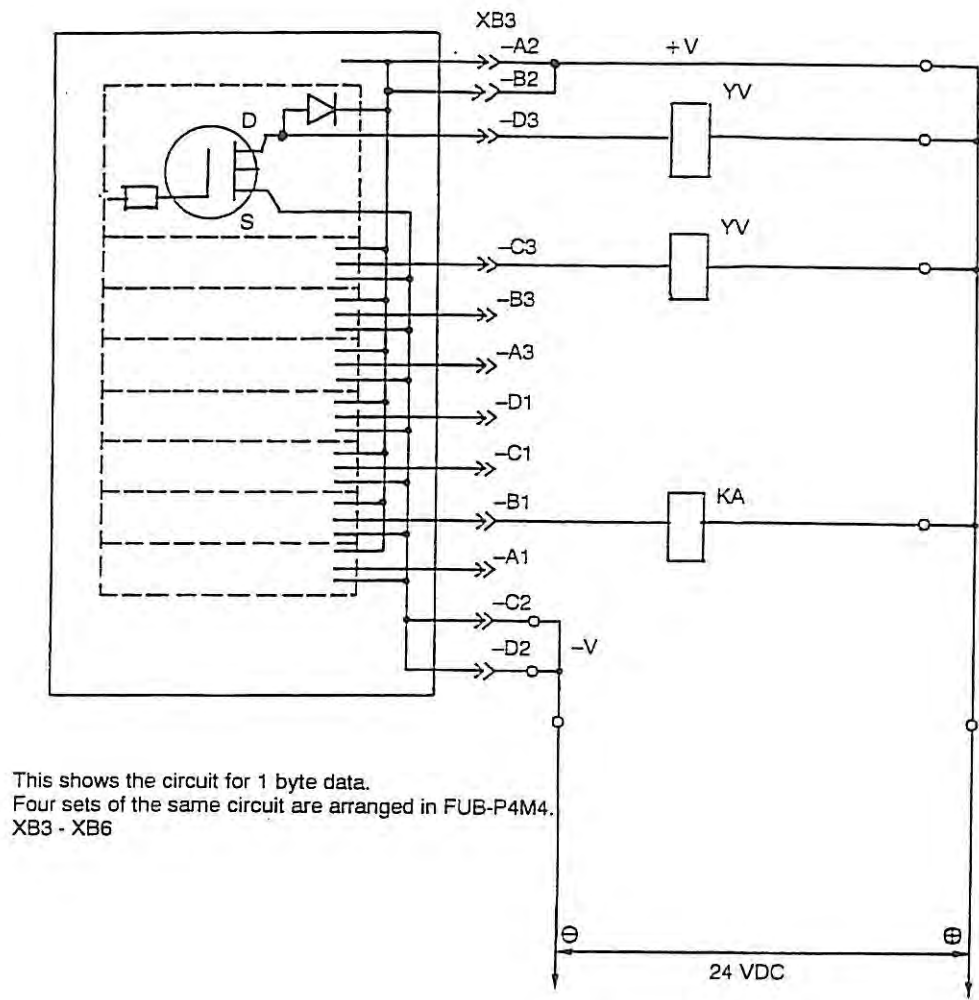

Fig. 1-11 FUB-P4M4, -P4R2 Card Input Circuits

(3) Output Section of FUB-P4M4

The illustration below shows the output circuit of 1 byte data in the power MOS IC output section.

Output rating: 2 A/bit



This shows the circuit for 1 byte data.
Four sets of the same circuit are arranged in FUB-P4M4.
XB3 - XB6

Fig. 1-12 FUB-P4M4 Card Output Circuits

(4) Output Section of FUB-P4R2

The maximum allowable current of relay contact is 2 A (30 VDC, 125 VAC, resistance load).

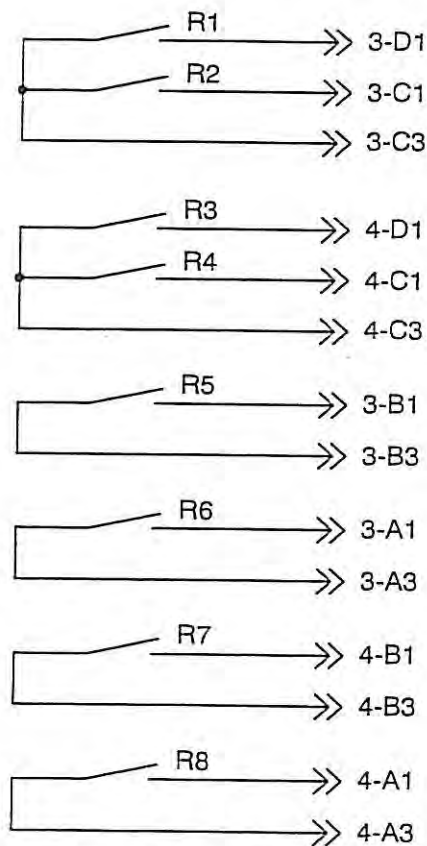
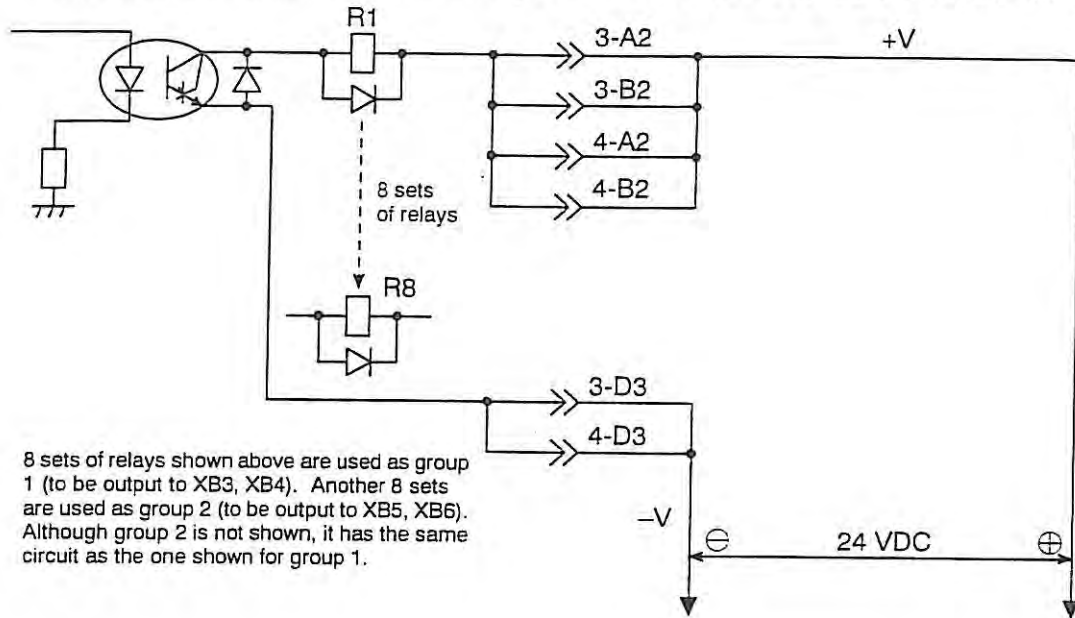

Fig. 1-13 FUB-P4R2 Card Output Circuits

(5) Photocoupler Input Card (FIPC2)

One card can handle a total of 16 points and up to two cards can be used at one slave station.

The card is used for reading signals input from switches such as limit switches and relay contacts.

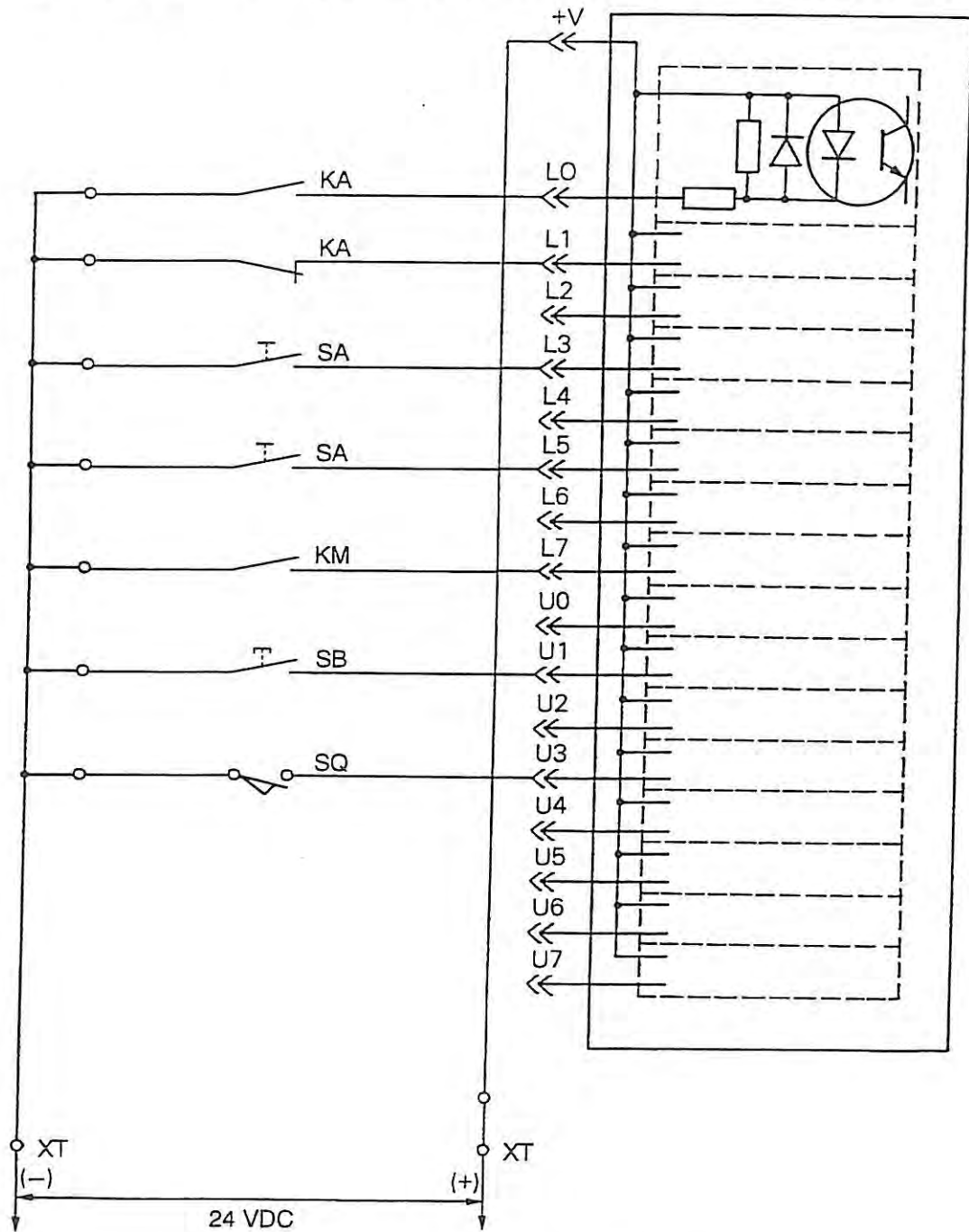

Fig. 1-14 Field Net Input Photocoupler Card (FIPC2)

(6) Power Transistor Output Card (FOPT)

One card can handle a total of 8 points and up to four cards can be used for each communication card.

The card is used for driving DC load such as solenoids, relays, and lamps.

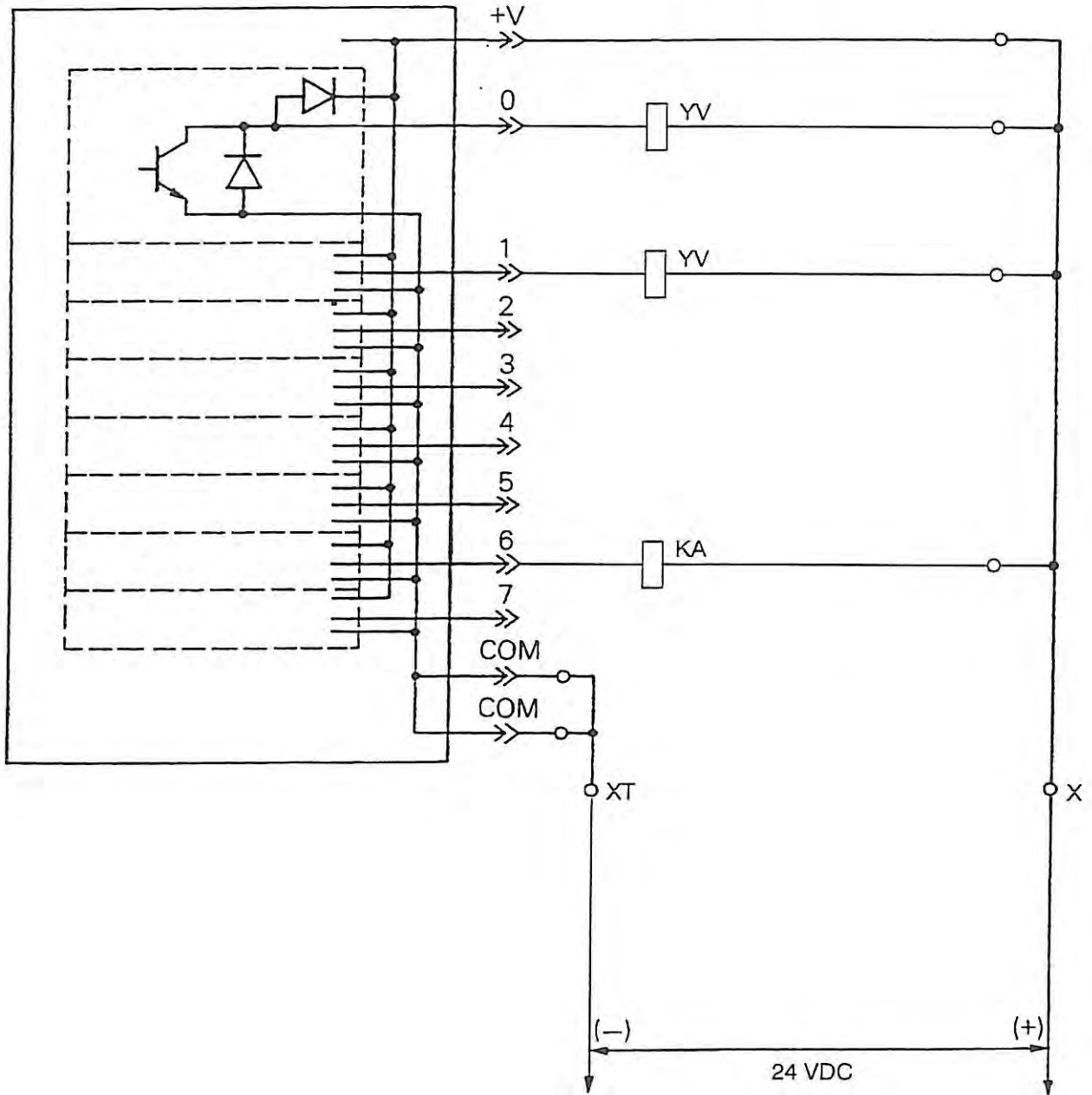

Fig. 1-15 Field Net Output Power Transistor Card (FOPT)

3-6. Servo Unit

Servo unit consist of a DC power supply unit (MPS, MPR) and inverter units (MIV) which control the spindle and numerically controlled axes.

For the maintenance of the servo unit, refer to the Maintenance Manual for MCS (Motion Control System).

3-7. Motors and Position Encoders

BL motors which drive numerically controlled axes have Type-J position encoder as a standard position sensing device. Optionally, an absolute scale which reads the position of a numerically controlled axis directly is available.

A magnetic pulse generator which detects the speed and position of the spindle is attached to the spindle.

3-8. Floppy Disk Drive Unit

(1) 3.5" Floppy Disk Drive Unit

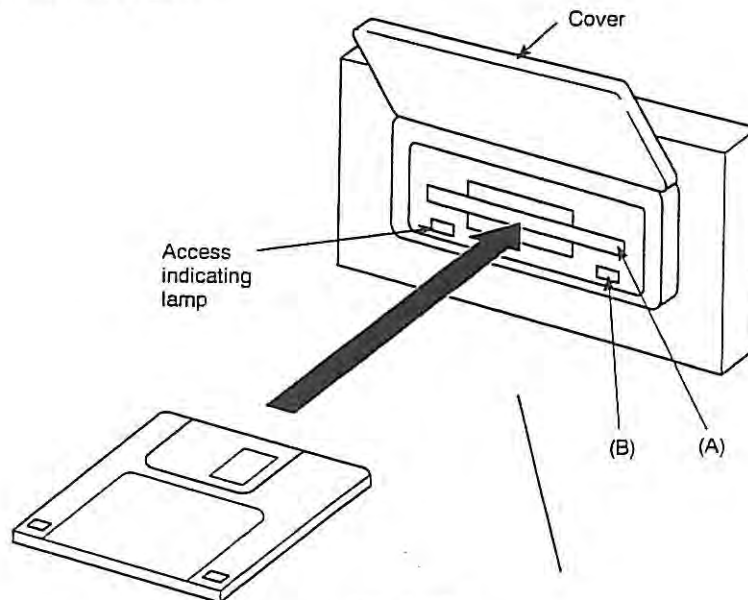

Fig. 1-16

- (a) Open the cover
- (b) Insert a floppy disk into opening (A) shown above. Before inserting a floppy disk, make sure that the floppy disk is facing the correct direction, otherwise it cannot be inserted completely.
- (c) The floppy disk drive unit is ready for reading the floppy disk when it is inserted into the floppy disk drive unit correctly.
- (d) Push projection (B) to remove a floppy disk.
- (e) Close the cover.



- : (1) Before switching power off, make sure that a floppy disk is not left in the floppy disk drive unit.
- (2) Keep the cover closed.
- (3) The access indicating lamp does not light even when a floppy disk is set in the floppy disk drive unit. The lamp lights when reading/writing processing is executed using the floppy disk.

3-9. Operation Panel

All controls necessary for operation, such as operation switches, manual switches, and pulse handle are arranged on the operation panel, including the display unit.

3-10. Cooling Unit

A cooling unit is mounted to the door of the control enclosure so that temperature in the control enclosure will not rise excessively, thereby the reliability of the CNC unit can be improved.

For some machine models, a cooling unit may not be used.

3-11. Control Enclosure

CNC unit, servo units, I/O units, and electric control circuits are installed in the control enclosure.

Totally enclosed construction provides reliable protection for electronic components in the enclosure against the entry of oil mist, chips, dust and other foreign matter, ensuring stable operation of them.

SECTION 2 MAINTENANCE AND INSPECTION

Daily checks greatly help to keep your CNC operating properly at all times. The self-diagnostic function, integrated in the CNC, help you locate the trouble if the machine malfunctions, allowing the user to take appropriate corrective action to minimize down time.

Consult also the following section: Section 3 "TROUBLES AND TROUBLESHOOTING"

1. Inspection during Installation

1-1. Installation Site

When determining the installation place of the machine and the CNC unit, accessibility to the machine for easy operation is an important factor to be carefully attended to. In addition, easy access to the CNC unit and the control enclosure for the purpose of maintenance and inspection must also be taken into consideration.

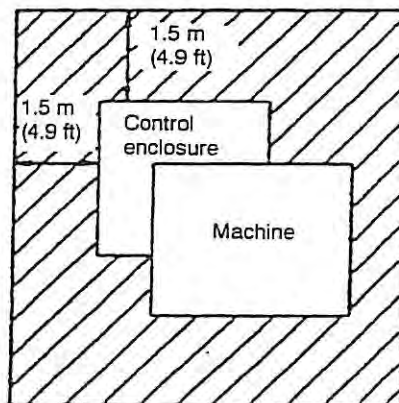

Fig. 2-17 Layout

Arrange the machine and the CNC unit in the manner shown above.

For the inspection and maintenance, space as shown in the illustration must be secured to allow doors of the control enclosure to be opened with sufficient area for working. Do not install the enclosure close to the shop wall.

1-2. Environmental Requirements

Observe the following points when installing the CNC unit and the control enclosure.

- Make sure that the CNC unit will not be subject to direct sunlight.
- Make sure that the control enclosure will not be splashed with chips, water, or oil.
- Make sure that the control enclosure and the operation panel will not be subject to excessive vibration or shock.
- Permissible ambient temperature range of the control enclosure is 0 to 40°C.
- Permissible humidity range of the control enclosure is 75% or lower (no condensation).
- The maximum altitude at which the control enclosure can be installed is 1000 m (3281 ft.).

1-3. Primary Power Supply

Prepare the primary power supply that complies with the following requirements.

- Voltage: 200 V
- Voltage fluctuation: $\pm 10\%$ max.
- Power supply frequency: 50/60 Hz
- Do not draw the primary power supply from the distribution panel that also supplies the power to a major noise source (for example, an electric welder and electric discharge machine) since this could cause malfunctioning of the CNC unit.
- If possible, connect the control enclosure to a ground independently. If there is no choice but to use a ground with other equipment, avoid connection to the ground where noise generating equipment such as an electric welder or an electric discharge machine is connected.

Main motor	kW	Please prepare the power source conforming to the items specified in the final specifications.
Apparent power	kVA	
Power requirements	kW	
Cable size	mm ²	
Momentary voltage variation rate		Refer to 1-4 and 1-5.
Power source inductance	μH	

1-4. Input Voltage Range Including Voltage Variation

Make sure that the voltage of the power source, including the momentary voltage variation, is within the range indicated below. If the input voltage is outside the range indicated below, acceleration/deceleration time of the spindle will be elongated.

Input voltage range: 200 VAC -10% to 230 VAC $+10\%$

1-5. Momentary Voltage Variation Rate and Power Source Inductance

Table 2-1 indicates the permissible inductance of the power source for MPS and MIP units. If the inductance of the power source is larger than the permissible value, acceleration/deceleration time of the spindle will be elongated even if the power source voltage is within the range indicated above.

Since it will be difficult to measure the inductance of the power source, measure the rate of momentary voltage variation caused by acceleration and deceleration of the spindle instead of the inductance and ensure that the measured value is within the momentary voltage variation rate indicated in Table 2-1. If the inductance of the power source is large, momentary voltage variation rate gets larger accordingly.

Table 2-1

Unit	Power Source Inductance			Momentary Voltage Variation Rate		
	230 V Power Source	220 V Power Source	200 V Power Source	230 V Power Source	220 V Power Source	200 V Power Source
MPS60	(70 μ H or less)	(70 μ H or less)	(70 μ H or less)	15% or less	15% or less	15% or less
MPS30	(140 μ H or less)	(140 μ H or less)	(140 μ H or less)			
MPS10	400 μ H or less	400 μ H or less	400 μ H or less			
MIP22	(110 μ H or less)	110 μ H or less	230 μ H or less	(6% or less)	6% or less	15% or less
MIP11	(230 μ H or less)	230 μ H or less	480 μ H or less			

Note: A value in () shows an estimated value.



- (1) If more than one machine is connected to the same power source, the value of "inductance of power source" for each machine is obtained by dividing the value in the table by the number of the machines to be connected.
- (2) Wiring inductance in 50-meter cable (164.05 ft) is approximately 12 μ H when general KIV cable is used.

[Calculating momentary voltage variation rate]

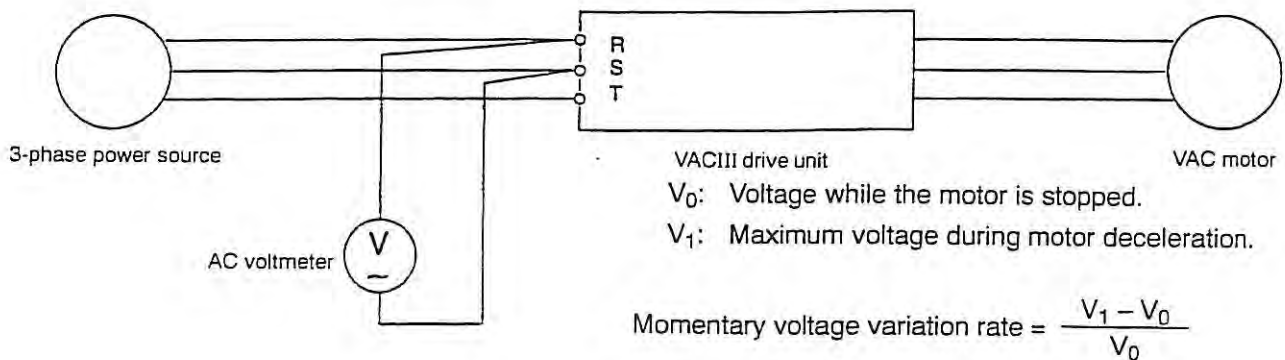

- (1) Connect an AC voltmeter to the power supply terminals at the spindle drive motor controller as shown above.
- (2) Measure the voltage while the spindle motor is stopped and take this value as "V0".
- (3) Measure the maximum voltage while the spindle motor is decelerating and take this value as "V1".
- (4) Calculate the momentary voltage variation rate using the following formula. Momentary voltage variation rate = $(V_1 - V_0)/V_0$

- [Supplement]
1. Since a digital AC voltmeter has slow response, momentary voltage variation rate obtained using the values measured with the digital AC voltmeter is smaller than the actual value. To obtain the precise value, it is recommended to use an analog AC voltmeter.
 2. Voltage "V1" cannot be measured accurately if motor deceleration time is short. Therefore, it is recommended to start deceleration from as high spindle speed as possible.

2. Daily Inspection

The CNC unit incorporates electronic devices which are susceptible to moisture, oil, dirt, dust, and chips, and also elevated temperatures in the enclosure caused by clogging of filters in the cooling unit. Therefore, daily inspection and maintenance of the CNC unit is important.

2-1. Daily Inspection

(1) Inspection of Appearance of Control Enclosure and Operation Box

Visually check the control enclosure and the operation box for adhesion of water, oil, dust, and chips and also the cooling unit filter for clogging.

If the control enclosure and the operation box are dirty, clean them. At the same time check the inside of the control enclosure and the operation box.

2-2. Every Three-month Inspection

(1) Cleaning the Cooling Unit

Make sure that the cooling unit mounted at the control enclosure door operates to blow air hard. If the filter is clogged, clean it.

2-3. Cleaning the Floppy Disk Drive

(1) Cleaning the 3.5" Floppy Disk Drive Head

A dirty read/write head may sometimes cause the floppy disk read/write error. Clean the head using a head cleaning disk.

The head cleaning disk may be either a market product or the one ordered from Okuma.

Okuma part No.: E0241-602-003

Okuma part name: Floppy head cleaning disk FCD-3.5W (Maker: Nippon Microcoating)

(2) Head Cleaning Procedure

To clean the head with the above cleaning disk, proceed as follows. When using the other maker's cleaning disk, follow the attached instructions.

(a) Insert the head cleaning disk into the floppy disk drive unit.

(b) Drive the cleaning disk using the disk initializing function.

1) Press EDIT AUX key.

2) Press the function key [F8] (EXTEND).

3) Press the function key [F2] (INIT).

4) Key in as follows:

=IN FDO:

Initialization OK (Y/N) ! Y

Formatting (Y/N) ! Y

Format (2DD - 720K = 0, 2HD - 1.44M = 1) ! 0

5) The drive unit's LED blinks when cleaning is started.

- 6) After 90 seconds, the floppy disk read/write error occurs and the cleaning is finished. This error occurs because no data can be written onto the cleaning disk as a matter of course.
- (c) This is the end of cleaning. If no good effect is found, repeat cleaning a maximum of five times.
- (d) If satisfactory result is not obtained after five times of cleaning, the drive unit or the floppy disk may be faulty.

(3) Precautions for Cleaning

Excessive head cleaning will give damage to the floppy disk unit head.

When using the above recommended disk, remember that the adequate frequency is once in three months and do not exceed the limit of four times a month.

(4) Cleaning Disk Life

The above cleaning disk will lose effect when used for a total of one hour (40 times) because the disk is clogged with dirt.

SECTION 3 TROUBLES AND TROUBLESHOOTING

The purpose of this section is to minimize downtime of the machine through speedy detection and remedies of the cause of any trouble that might occur.

It is extremely important to make detailed checks on the condition of the machine and CNC system when the trouble arose and to carry out various kinds of tests described in this section. Thus, the customer himself will be able to fix the machine in most cases. The test results reported to your local Okuma representative will be a great help in determining the nature and extent of the trouble and the remedies to be applied.

1. General Check Procedure When Trouble Occurs

Generally, check the following matters:

- (1) When Trouble Occurs,
 - (a) Mode of operation
 - (b) Current position and command position
 - (c) What STATUS display lamp is going on?
 - (d) Is the ALARM lamp on?

When the ALARM lamp is on, the cause of the alarm can be known from the contents of the alarm message given on the CRT.

- (2) After Resetting the CNC System,
 - (a) Does the trouble occur at the same situation repeatedly?
 - (b) Does the same trouble occur in other modes of operation?
 - (c) How about frequency of the trouble?
 - (d) Does the trouble arise regularly in terms of time, temperature, etc.?

2. Trouble Analysis

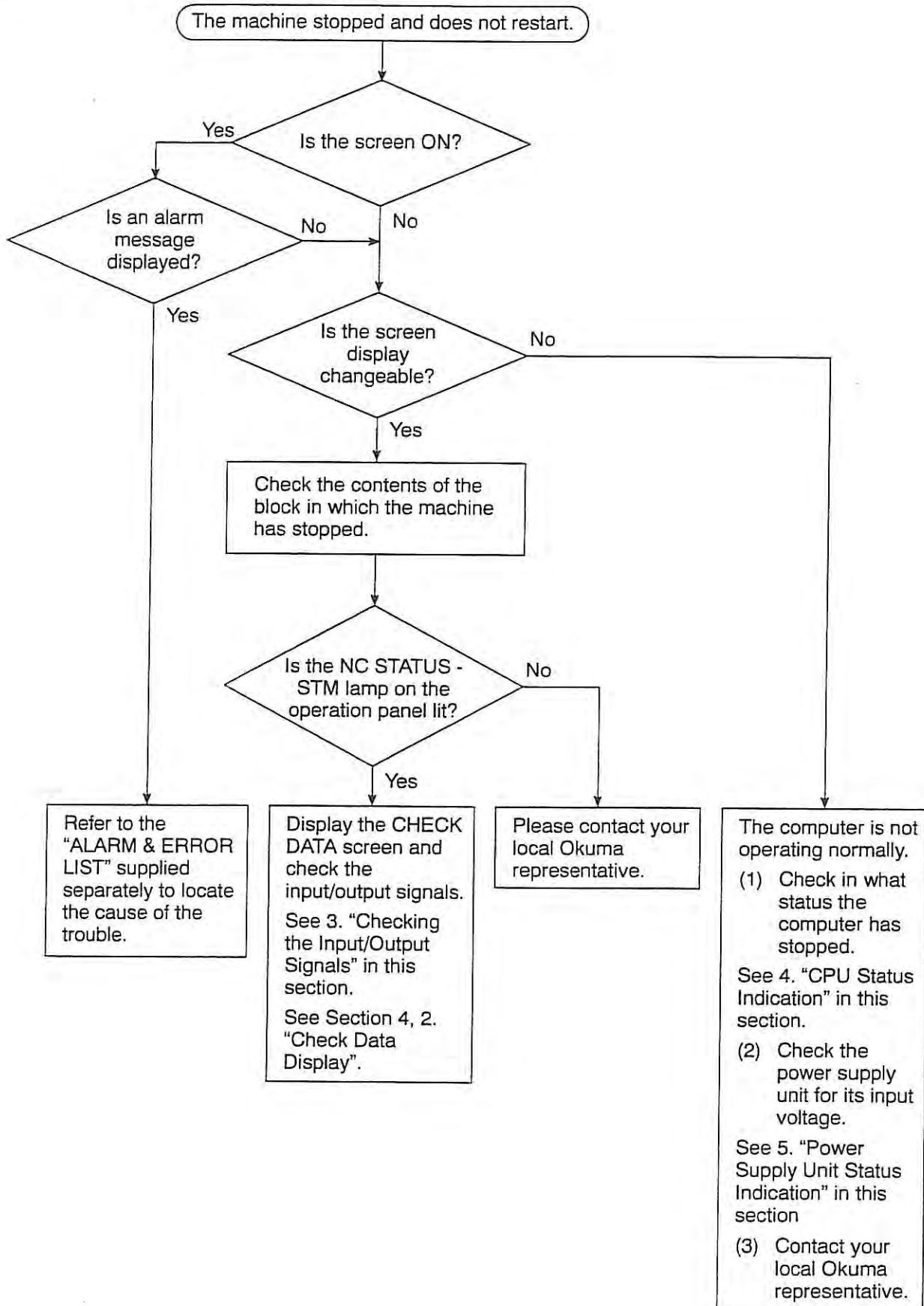

3. Checking the Input/Output Signals

A variety of electric parts such as limit switches, proximity switches, solenoid valves, and motors is mounted in the machine, and these machine-mounted electric parts are placed in very severe environment affected by chips, coolant, oil, dirt, and dust. Although water- and dust-proof construction is adopted to protect these electric parts, electrical trouble causes a high rate of the CNC troubles.

However, most of the electric parts are relatively simple in their operation and can be easily checked and repaired by the user's maintenance technicians.

This section describes the practical methods for checking the input/output signals.

3-1. Checking the Input/Output Signals at the CHECK DATA Screen

(1) Displaying the I/O CHECK Screen

The ON/OFF status of the input and output signals of the CNC unit can be checked at the I/O CHECK screen.

< Procedure >

(1) Select an operation mode (automatic, MDI, manual).

(2) Press function key [F7] (CHECK DATA).

The CHECK DATA screen is displayed.

(3) Press the page selection key  to display the I/O CHECK screen.

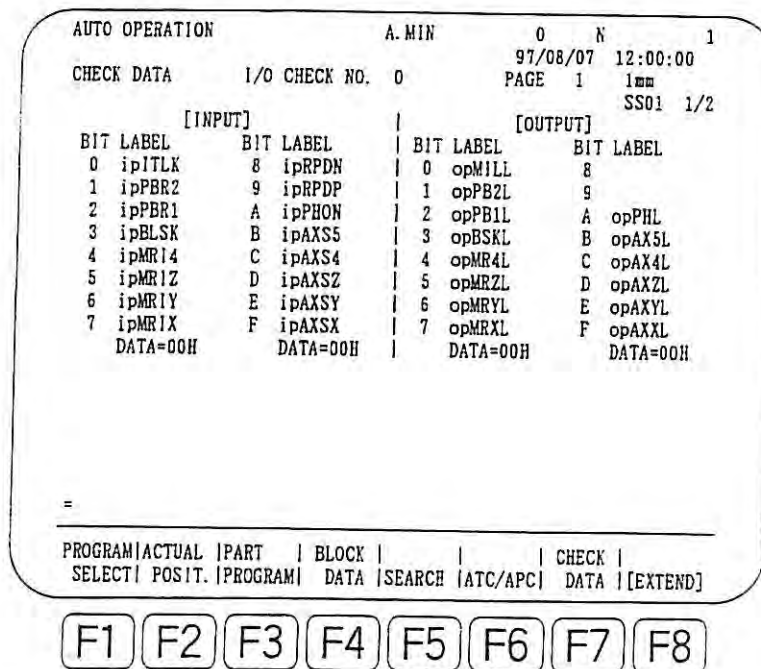
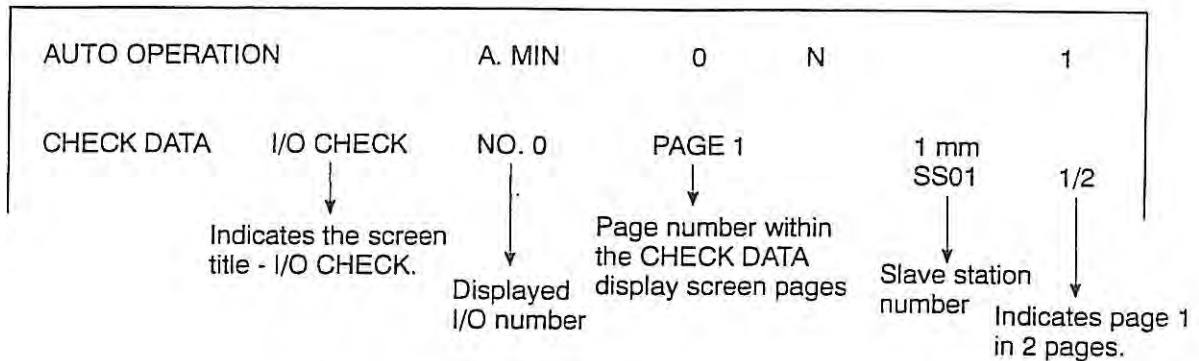

Fig. 3-1

< Contents of display >



If an I/O bit is ON, the label section (9 characters) is highlighted.

ipAXSY : Signal ON status

ipAXSX : Signal OFF status

At the bottom line in each column, the value of 8 bits of that column is displayed in hexadecimal.

DATA = 41H : BIT7 BIT6 BIT5 BIT4 BIT3 BIT2 BIT1 BIT0

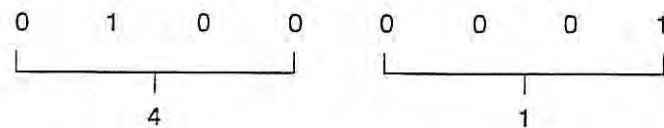

(2) Checking the Input Signals

The procedure for checking the status of the proximity switch that checks the spindle tool clamp using the I/O CHECK screen is explained below as an example. Other input signals can be checked in the same manner.

From the Field Net input wiring diagram, supplied separately, it is found that the spindle tool clamp confirmation signal is input to check No. 29, bit 8.

So, display the CHECK DATA screen for I/O CHECK No. 29 and see the label "IISCL" of bit 8 of INPUT. When the label is highlighted, it indicates that the input signal is ON. Conversely, when the label is not highlighted, it indicates that the input signal is OFF.

If the spindle tool clamp confirmation input signal is OFF (label not highlighted) in the state the signal must be ON, the spindle tool clamp confirmation proximity switch will be faulty.

(3) Checking the Output Signals

The procedure for checking the status of the spindle tool internal cylinder unclamp solenoid using the I/O CHECK screen is explained below as an example. Other output signals can be checked in the same manner.

From the Field Net input wiring diagram, supplied separately, it is found that the signal for operating the spindle tool internal cylinder unclamp solenoid is output from check No. 29, bit 8.

So, display the CHECK DATA screen for I/O CHECK No. 29 and see the label "oISUC" of bit 8 of OUTPUT. When the label is highlighted, it indicates that the output signal is ON. Conversely, when the label is not highlighted, it indicates that the output signal is OFF.

If the spindle tool internal cylinder unclamp solenoid has not operated although the output signal for operating the spindle tool internal cylinder unclamp solenoid is ON (label highlighted), the spindle tool internal cylinder unclamp solenoid will be faulty.

4. CPU Status Indication

Whether the computer is running normally or not can be checked by simply observing the display in the screen at the operation panel. If it is operating, the computer is judged to be running normally. For example, changeover the screen display and when the screen display changes accordingly, you can judge that the computer is running normally.

To check the status of the computer, status indicating LED lamps are provided on the UCMB (UC main board) (see Fig. 3-2).

(1) Contents of Indication

RUN: RUN	The CPU is running to execute an instruction (calculating an instruction).
PRT: PROTECT ERROR	The CPU has accessed an address area in the prohibited mode, or it has accessed an unused address area.
PAR: PARITY ERROR	During the access to the system bus by the CPU in this board, a parity error was detected in the read data.
LOP: LOOP ERROR	An interruption processing occurring in a predetermined cycle (RTC) has not finished before the occurrence of the next interruption.
ECC: ERROR CHECK & CORRECT ERROR	In the access to the main memory, there was an error in the contents of the memory at the specified address.
DIA: DIAGNOSTIC ERROR	The output diagnose data differed from the normal data (\$55).
CYO: CYCLE OVER ERROR	The CPU bus cycle of this board has not finished within a preset time.
SBER: SYSTEM BUS ERROR	A slave station detected an error while the CPU of this board was accessing the system bus as the bus master.

(2) CPU Operating Status Indication

- (a) While the CPU is running normally, only the RUN lamp (green) is lit.
- (b) At the occurrence of a bus error, an LED lamp (red) showing the cause of the error lights. The RUN lamp (green) stays lit during bus error processing.
- (c) If the CPU enters the halt state due to double-bus error, the RUN lamp (green) goes off. The LED lamp (red) showing the cause of the double-bus error lights.
- (d) If all of the LED lamps are lit, either the 5 V power is not supplied or the CPU is in the reset state.
- (e) An error indication shows the trouble of the CPU and it is not cleared by the CNC reset operation.
- (f) To restart the CNC, turn off the power once and then turn it back on. If the trouble which has occurred continues, the same error occurs again and the CNC stops. If the CNC operates normally, allow the CNC operating to observe the situation.

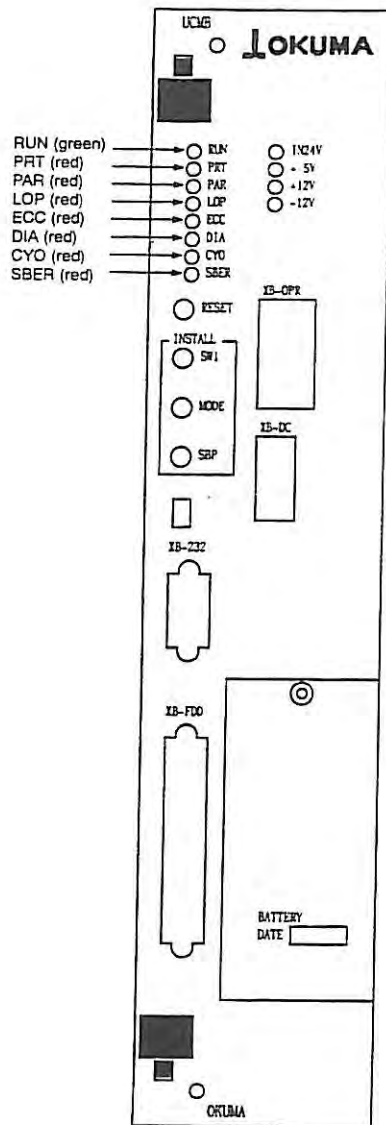

Fig. 3-2 LED Indication on UCMB (UC Main Board)

5. Power Supply Unit Status Indication

(1) Check by LED Indication

The power supply unit has the function which monitors the input/output voltage and the output current constantly and the function turns off the status indicating LED lamp if an error is detected. To check the status of the power supply unit, check the indication of the LED lamps on the power supply unit. See Fig. 3-3.

Indicating lamp (green LED)	(A)	(B)	(C)	(D)	(E)
IN24 V	○	○	○	○	
+5 V	○		○	○	
+12 V	○	○		○	
-12 V	○	○	○		

○: LED ON

(A): The power supply unit is operating normally.

(B): Over current, over voltage, or low voltage of output due to an error of +5 V.

(C): Over current of output due to an error of +12 V.

(D): Over current of output due to an error of -12 V.

(E): 24 VDC input has lowered to 2.4 V or lower (at 19.2 V or lower, LED status is indefinite.).

(2) Alarm Indication by LED

- (a) If a power supply unit alarm occurs due to an error of the +5 V (status indicating LED is OFF), power supply to the CPU is shut off to stop the CPU.
- (b) A power supply alarm (status indicating LED is OFF) indicates a trouble related to the power supply unit and the input/output of the power supply unit.
- (c) To start the CNC unit, turn the power off once (pressing the CONTROL OFF switch on the NC operation panel) and turn the power on again (pressing the CONTROL ON switch on the NC operation panel). The CPU automatically starts running and the CNC starts operating.
- (d) If the trouble which has occurred continues, the same error occurs again and the CNC stops. If the CNC operates normally, allow the CNC operating to observe the situation.

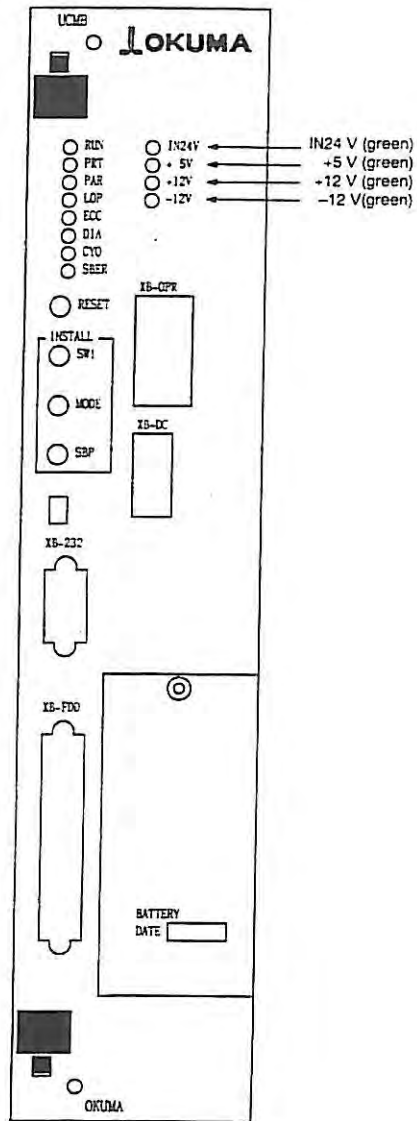

Fig. 3-3 LED Indication on the Power Supply Unit

6. Inspection of Overload Relay

For protecting motors and solenoids, etc., from overcurrent and overload, an overload relay is used.

To reset the tripped relay, push in the reset rod. Note that pushing in the reset rod right after the relay has been tripped, cannot reset the relay. Allow the switch to cool before resetting it.

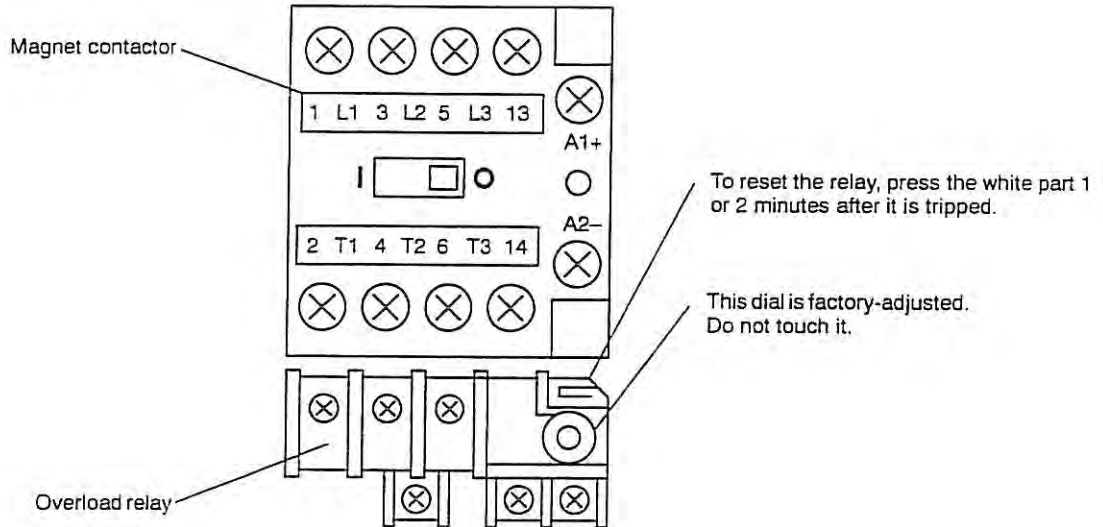

Fig. 3-4 Overload Relay

The circuit breaker and fuses prevent overcurrents from surging through the control circuit.

With circuit breakers, functions of the circuit can be recovered by simply resetting the tripped breaker by holding up the lever.

7. Releasing Travel-end Limit

The system panel shown below is provided in the control enclosure and the O.T. RELEASE switch can be used to release the overtravel alarm state caused by the actuation of the overtravel limit switch.

If an overtravel limit switch of an axis is tripped, an alarm message is displayed on the screen and power supply to the servo drive unit is shut off for all axes. To release the overtravel alarm state, follow the procedure indicated below.

< Procedure >

(1) Turn the O.T. RELEASE switch up to the "I" position.

(2) Press the RESET button on the NC operation panel.

Power supply to the servo drive is turned on for all axes and an alarm message is displayed on the screen. In this state, pulse handle operation only is allowed.

(3) Move the axis, causing the overtravel alarm, in the direction away from the travel-end by turning the pulse handle.

(4) Turn the O.T. RELEASE switch down to the "O" position, then press the RESET button.

This completes the overtravel alarm release operation.



Fig. 3-5

8. Check by Machine Diagnosis Messages

If the machine unit such as ATC and APC fails to operate, the self diagnostic function of the CNC displays insufficient conditions for the required operation on the screen, facilitating the check.

For details, refer to Section 5, 2. "Machine Diagnosis Messages".

SECTION 4 SELF-DIAGNOSTIC FUNCTION

The CNC unit has the self-diagnostic function using the performance of the built-in computer. The self-diagnostic function provides the following four check functions.

- Check function using the alarm and error display
- Check function using the check data display
- Check function using the CNC diagnostic display
- Check function using the machine diagnostic display

(1) Check Function Using the Alarm and Error Display

This function constantly monitors any defect including programming, operational errors and NC malfunctions.

When any defect such as the programming error and CNC malfunction requiring stop of the machine operation occurs, the ALARM lamp goes on, the machine is stopped, and the contents of the alarm will be displayed on the screen. When the defect is an operational error during editing operation, etc. not requiring the machine to be stopped, the ALARM lamp does not go on, but the contents of the error only will be displayed on the screen. From these displays, the contents of the defect can be judged.

(2) Check Function Using the Check data Display

With check data displayed on the screen, it is possible to check internal conditions of the CNC, input/output signals of the CNC and so on. This is a useful function to adjust and check the CNC.

(3) Check Function Using the CNC Diagnostic Display

This is the function to constantly monitor the memory in the CNC in the display form of decimal numbers, hexadecimal numbers, floating-point number, bit-string, etc.

(4) Check Function Using the Machine Diagnostic Display

When the machine does not operate because of any of the requirements for the operation of the machine not fulfilled, that unfulfilled condition will be displayed in characters to facilitate operator's inspection work.

1. Alarm and Error Display

The CNC constantly monitors the operating conditions of the machine, the program data and the operation of the machine operator. When any problem takes place, it gives the operator a warning by displaying an alarm message or error message.

(1) Alarm Display

The machine is stopped. The ALARM lamp under NC STATUS goes on. The corresponding alarm message is displayed on the 2nd line of the screen.

(2) Error Display

Mainly warning against any of the items input by the operator, and does not cause the machine to be stopped.

The ALARM lamp does not go on and the error message is displayed on the 18th to 22nd line on the screen.

(3) CPU Alarm

This alarm indicates CPU malfunction. When this type of alarm occurs, machine operation cannot be resumed until power supply is turned on again. Naturally, the machine instantly stops.

When the CPU does not function normally, the message is displayed below the central portion on the screen.

Note: For alarm and error messages, refer to Alarm & Error List.

2. Check Data Display

The CNC constantly monitors internal conditions of the CNC and input/output signals of the NC, and the operator can see these data through check data displayed on the screen.

Check data displayed on the screen and its contents are shown in the following display screens.

Operation procedures for check data display are as follows:

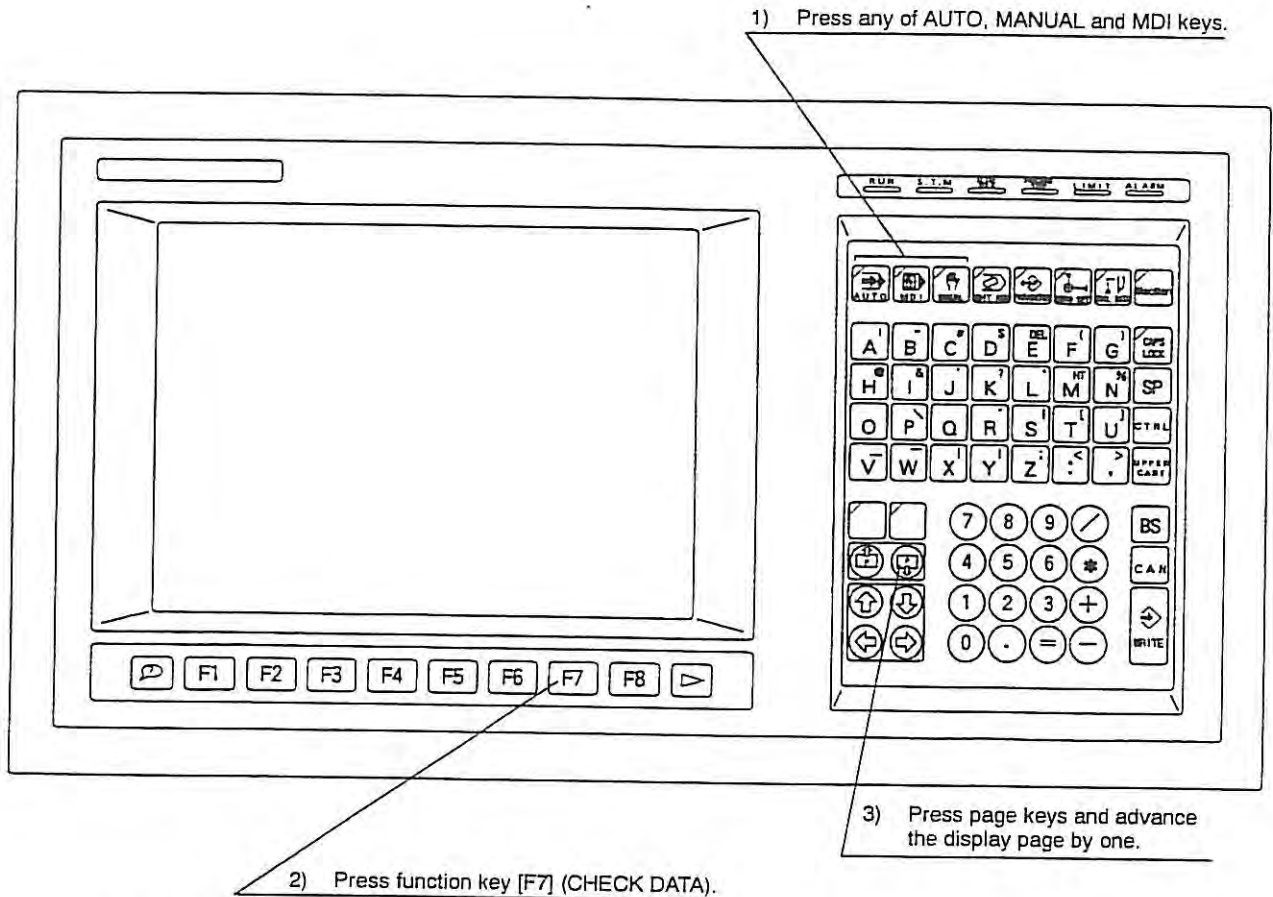



- 1) Press any of AUTO, MANUAL and MDI keys.

The function keys are assigned the same functions for [F2] through [F7]. Functions available with function key [F1] depends on the mode selected:

=CH						
=						
PROGRAM SELECT	ACTUAL POSIT.	PART PROGRAM	BLOCK DATA	SEARCH	CHECK DATA	[EXTEND]
F1	F2	F3	F4	F5	F6	F7
						F8

AUTO : PROGRAM SELECT
MDI : DATA INPUT
MANUAL: None

- 2) Press function key [F7] (CHECK DATA).
- 3) Press page keys  and  with the desired display screen is obtained.

 advances the display screen by one.

 returns the display screen by one.

Note that required display screen can be accessed using the search command instead of using page keys.

Procedure to display the required display screen using the search command is as follows:

First follow steps (1) and (2) above to select the check display screen display mode.

- 4) Press function key [F5] (SEARCH).

Prompt "=F" will be displayed on the console line.

- 5) Key in the display screen number of the required display screen through the keyboard.

The data key-in is displayed following "= F".

Example: =F__ 10

- 6) Press WRITE key.

The required check data display screen will be displayed. The data accessed on the check data display screens is summarized on the following display screens.

2-1. NC Axis Data

AUTO OPERATION				N 1			
CHECK DATA		NC AXIS DATA		97/07/15 14:10:00			
				PAGE 4 1mm			
		X	Y	Z			
RDIF		0.001	0.001	0.001			
ODIF		0.000	0.000	0.000			
RCON		35999.999	35999.999	28799.999			
RAPA		35999.998	35999.998	28799.998			
RSAPA		0.000	0.000	0.000			
RSVPVAR1		0.000	0.000	0.000			
RSVPVAR2		0.000	0.000	0.000			
RLEDATA		00000000	00000000	00000000			
RFEDIDC		00000000	00000000	00000000			
FIDFR(AK)		0000	0000	0000			

PROGRAM SELECT	ACTUAL POSIT.	PART PROGRAM	BLOCK DATA	SEARCH	ATC/APC	CHECK DATA	[EXTEND]
----------------	---------------	--------------	------------	--------	---------	------------	----------

F1 F2 F3 F4 F5 F6 F7 F8

AUTO OPERATION				N 1			
CHECK DATA		NC AXIS DATA		97/07/15 14:10:00			
				1mm			
		ODIF	RAPA	LOAD	%		
X		0.000	35999.998	0			
Y		0.000	35999.998	0			
Z		0.000	28799.998	0			

PROGRAM SELECT	ACTUAL POSIT.	PART PROGRAM	BLOCK DATA	SEARCH	ATC/APC	CHECK DATA	[EXTEND]
----------------	---------------	--------------	------------	--------	---------	------------	----------

F1 F2 F3 F4 F5 F6 F7 F8

- RDIF Difference between calculated value and detected value
- ODIF Difference between calculated value with acceleration/deceleration taken into account and detected value
- RCON Calculated value
- RAPA Detected value
- RSAPA Position detected value when contact with touch sensor
- RSVPVAR1 } Servo processor data
- RSVPVAR2 } (values designated by NC optional parameter (word) No. 10)
- RLEDATA Absolute scale data
- RFEDIDC Position encoder data
- FIDFR(AK) Inductosyn scale ON/OFF state

2-2. Machine Axis Data

AUTO OPERATION						N	1
CHECK DATA						97/07/15 14:10:00	
MC AXIS DATA						PAGE	6
		TS	TI	MA			1mm
RDIF		0.001	0.001	0.000			
ODIF		0.000	0.000	0.000			
RCON		12711.935	26288.127	0.000			
RAPA		12711.935	26288.126	0.000			
RCOM		0.000	0.000	0.000			
RCCON		0.000	0.000	0.000			
RCAPA		0.000	0.000	0.000			
RSYVAR1		10.259	10.259	0.000			
RSYVAR2		0.000	0.000	0.000			

PROGRAM SELECT	ACTUAL POSIT.	PART PROGRAM	BLOCK DATA	SEARCH	ATC/APC	CHECK DATA	[EXTEND]
----------------	---------------	--------------	------------	--------	---------	------------	----------

F1 F2 F3 F4 F5 F6 F7 F8

AUTO OPERATION						N	1
CHECK DATA						97/07/15 14:10:00	
MC AXIS DATA							1mm
		ODIF	RAPA	LOAD			%
TS		0.000	12711.935	0			
TI		0.000	26288.126	0			
MA		0.000	0.000	0			

PROGRAM SELECT	ACTUAL POSIT.	PART PROGRAM	BLOCK DATA	SEARCH	ATC/APC	CHECK DATA	[EXTEND]
----------------	---------------	--------------	------------	--------	---------	------------	----------

F1 F2 F3 F4 F5 F6 F7 F8

- TS ATC tool hange arm rotation axis
- TI ATC tool change arm insert/extract axis
- MA Magazine axis
- RDIF Difference between calculated value and detected value
- ODIF Difference between calculated value with acceleration/deceleration taken into account and detected value
- RCON Calculated value
- RAPA Detected value
- RCOM Commanded value
- RCCON RCON including the position detection offset of the axis changeover specification.
- RCAPA RAPA including the position detection offset of the axis changeover specification.

RSVVAR1 } Servo processor data
RSVVAR2 } (values designated by NC optional parameter (word) No. 10)

2-3. I/O Check

The I/O CHECK screen displays the ON/OFF status of the switches on the machine operation panel and also switches mounted in the machine.

The correspondence between the label names displayed on the screen and the switches is shown below.

The highlighted labels indicate that the signal is ON: for input signals, the signal input from the corresponding device is ON, and for output signals, the signal output to the corresponding device is ON.

The character string shown following "DATA" indicates the status of the eight (1 byte) signals in that column in hexadecimal.

Two pages of I/O CHECK screen are provided for each slave station.

The ON/OFF status of the input and output signals is identified by whether or not the label of the signal is highlighted.

- Input/output signal is ON Label is highlighted.
- Input/output signal is OFF Label is not highlighted.

(1) XM-45VA/45VB/55VA/55VB

I/O CHECK No. 0 < Slave station 1 SS01 1/2 >

[INPUT]		[OUTPUT]	
BIT LABEL	BIT LABEL	BIT LABEL	BIT LABEL
0 ipITLK	8 ipRPDN	0 opMILL	8
1 ipPBR2	9 ipRPDP	1 opPB2L	9
2 ipPBR1	A ipPHON	2 opPB1L	A opPHL
3 ipBLSK	B ipAXS5	3 opBSKL	B opAX5L
4 ipMRI4	C ipAXS4	4 opMR4L	C opAX4L
5 ipMRIZ	D ipAXSZ	5 opMRZL	D opAXZL
6 ipMRIY	E ipAXSY	6 opMRYL	E opAXYL
7 ipMRIX	F ipAXSX	7 opMRXL	F opAXXL
DATA=00H	DATA=00H	DATA=00H	DATA=00H

AUTO OPERATION A. MIN 0 N 1
97/08/07 12:00:00
CHECK DATA I/O CHECK NO. 0 PAGE 1 Inm
SS01 1/2

PROGRAM|ACTUAL |PART | BLOCK | | CHECK |
SELECT| POSIT. |PROGRAM| DATA |SEARCH |ATC/APC| DATA |[EXTEND]

F1 F2 F3 F4 F5 F6 F7 F8

bit	[INPUT]			[OUTPUT]		
	label	address	signal name	label	address	signal name
bit0	ipITLK	0000	Interlock release PB	opMILL	0000	Interlock release PL
bit1	ipPBR2	0001	Program branch 2 PB	opPB2L	0001	Program branch 2 PL
bit2	ipPBR1	0002	Program branch 1 PB	opPB1L	0002	Program branch 1 PL
bit3	ipBLSK	0003	Block skip PB	opBSKL	0003	Block skip PL
bit4	ipMRI4	0004	Mirror image 4 PB	opMR4L	0004	Mirror image 4th axis PL
bit5	ipMRIZ	0005	Mirror image Z PB	opMRZL	0005	Mirror image Z axis PL
bit6	ipMRIY	0006	Mirror image Y PB	opMRYL	0006	Mirror image Y axis PL
bit7	ipMRIX	0007	Mirror image X PB	opMRXL	0007	Mirror image X axis PL
bit8	ipRPDN	0008	Rapid feed N PB		0008	
bit9	ipRPDP	0009	Rapid feed P PB		0009	
bitA	ipPHON	000A	Pulse handle ON PB	opPHL	000A	Pulse handle select PL
bitB	ipAXS5	000B	Axis select 5th axis PB	opAX5L	000B	Axis select 5th axis PL
bitC	ipAXS4	000C	Axis select 4th axis PB	opAX4L	000C	Axis select 4th axis PL
bitD	ipAXSZ	000D	Axis select Z axis PB	opAXZL	000D	Axis select Z axis PL
bitE	ipAXSY	000E	Axis select Y axis PB	opAXYL	000E	Axis select Y axis PL
bitF	ipAXSX	000F	Axis select X axis PB	opAXXL	000F	Axis select X axis PL

I/O CHECK No. 1 < Slave station 1 SS01 2/2 >

AUTO OPERATION		A. MIN	0	N	1
CHECK DATA		I/O CHECK NO. 1	97/08/07	12:00:00	
			PAGE 2	1mm	
				SS01 2/2	
[INPUT]			[OUTPUT]		
BIT LABEL	BIT LABEL	BIT LABEL	BIT LABEL	BIT LABEL	
0 ipSCCW	8 ipJOGN	0 opCCWL	8 opJGNL		
1 ipSSP	9 ipJGF	1	9		
2 ipSCW	A ipJOGP	2 opSCWL	A opJGPL		
3 ipSNTR	B ipZLOK	3 opNTRL	B opZLKL		
4 ipSORT	C ipSTML	4 opORTL	C opSLKL		
5 ipDIRS	D ipSSTP	5 opFOVL	D opSSTL		
6 ipDILE	E ipDRYR	6 opSOVL	E opDRYL		
7 ipRST	F ipMLOK	7 opROVL	F opMLKL		
DATA=00H	DATA=00H	DATA=00H	DATA=00H		

PROGRAM | ACTUAL | PART | BLOCK | | CHECK |
SELECT | POSIT. | PROGRAM | DATA | SEARCH | ATC/APC | DATA | [EXTEND]

F1 F2 F3 F4 F5 F6 F7 F8

bit	[INPUT]			[OUTPUT]		
	label	address	signal name	label	address	signal name
bit0	ipSCCW	0010	Spindle CCW PB	opCCWL	0010	Spindle CCW PL
bit1	ipSSP	0011	Spindle STOP PB		0011	
bit2	ipSCW	0012	Spindle CW PB	opSCWL	0012	Spindle CW PL
bit3	ipSNTR	0013	Spindle neutral PB	opNTRL	0013	Spindle neutral PL
bit4	ipSORT	0014	Spindle orientation PB	opORTL	0014	Spindle orientation PL
bit5	ipDIRS	0015	Door interlock RESTART PB	opFOVL	0015	Jog feed override rate 100% PL
bit6	ipDILE	0016	Door interlock OFF PB	opSOVL	0016	Spindle override rate 100% PL
bit7	ipRST	0017	NC RESET PB	opROVL	0017	Rapid feed override rate 100% PL
bit8	ipJOGN	0018	Jog feed N PB	opJGNL	0018	Jog feed N PL
bit9	ipJGF	0019	Jog feed OFF PB		0019	
bitA	ipJOGP	001A	Jog feed P PB	opJGPL	001A	Jog feed P PL
bitB	ipZLOK	001B	Axis feed cancel PB	opZLKL	001B	Axis feed cancel PL
bitC	ipSTML	001C	STM lock PB	opSLKL	001C	STM lock PL
bitD	ipSSTP	001D	Schedule cycle stop PB	opSSTL	001D	Schedule cycle stop PL
bitE	ipDRYR	001E	Dry run PB	opDRYL	001E	Dry run PL
bitF	ipMLOK	001F	Machine lock PB	opMLKL	001F	Machine lock PL

I/O CHECK No. 2 < Slave station 2 SS02 1/2 >

```

AUTO OPERATION          A.MIN          0      N      1
                        97/08/07 12:00:00
CHECK DATA      I/O CHECK NO. 2      PAGE 3      1mm
                                                SS02 1/2

      [INPUT]          |          [OUTPUT]
BIT LABEL      BIT LABEL | BIT LABEL      BIT LABEL
0 ipSTRW       8 ipNTS/  | 0 opSRL1       8
1 ipSTAV       9 ipNCST  | 1 opSAL1       9
2 ipRTCY       A ipRSTR  | 2 opRTCL       A
3 ipCYST       B ipPHAD  | 3 opCYL1       B opPHAL
4 ipILKR       C ipMINT  | 4              C opMINL
5 ipAACZ       D ipSBLK  | 5 opACL        D opSBLL
6 ipAPC        E ipOPST  | 6 opAPCL       E opOPSL
7 ipATCX       F ipCRTF  | 7 opATCL       F opCTRL
DATA=00H      DATA=00H | DATA=00H     DATA=00H
    
```

```

PROGRAM|ACTUAL|PART | BLOCK | | | CHECK |
SELECT| POSIT.|PROGRAM| DATA |SEARCH |ATC/APC| DATA |[EXTEND]
    
```

F1 F2 F3 F4 F5 F6 F7 F8

[INPUT]				[OUTPUT]		
bit	label	address	signal name	label	address	signal name
bit0	ipSTRW	0020	ATC step back PB	opSRL1	0020	ATC one step back enable PL
bit1	ipSTAV	0021	ATC step advance PB	opSAL1	0021	ATC one step advance enable PL
bit2	ipRTCY	0022	ATC return cycle PB	opRTCL	0022	ATC return cycle enable PL
bit3	ipCYST	0023	ATC one cycle PB	opCYL1	0023	ATC one cycle enable PL
bit4	ipILKR	0024	ATC interlock release PB		0024	
bit5	ipAAC	0025	AAC select PB	opACL	0025	AAC select PL
bit6	ipAPC	0026	APC select PB	opAPCL	0026	APC select PL
bit7	ipATC	0027	ATC select PB	opATCL	0027	ATC select PL
bit8	ipNTS/	0028	NC temporary stop PB		0028	
bit9	ipNCST	0029	NC start PB		0029	
bitA	ipRSTR	002A	Sequence restart PB		002A	
bitB	ipPHAD	002B	Pulse handle addition PB	opPHAL	002B	Pulse handle addition PL
bitC	ipMINT	002C	Manual int PB	opMINL	002C	Manual int PL
bitD	ipSBLK	002D	Single block PB	opSBLL	002D	Single block PL
bitE	ipOPST	002E	Optional stop PB	opOPSL	002E	Optional Stop PL
bitF	ipCRTF	002F	CRT off PB	opCTRL	002F	CRT off PL

I/O CHECK No. 3 < Slave station 2 SS02 2/2 >

```

AUTO OPERATION          A.MIN      0      N      1
                        97/08/07 12:00:00
CHECK DATA            I/O CHECK NO. 3      PAGE 4      1mn
                        SS02 2/2

[INPUT]                |                | [OUTPUT]
BIT LABEL              | BIT LABEL      | BIT LABEL      | BIT LABEL
0 ipSHWN               | 8 ipPNIP       | 0 opSHWL       | 8
1 ipOHP                | 9 ipPNPP       | 1 opOHHL       | 9
2 ipOHLM               | A ipSP3        | 2 opOHLL       | A opSP3L
3 ipOLMN               | B ipCHPN       | 3 opOLML       | B opCHPL
4 ipSP2                | C ipCHCC       | 4 opSP2L       | C opCCPL
5 ipWAAN               | D ipSP1        | 5 opWAAL       | D opSP1L
6 ipWANN               | E ipLUBE       | 6 opWANL       | E opLUBL
7 ipCOLN               | F ipLION       | 7 opCOLL       | F opLITL
DATA=00H               | DATA=00H     | DATA=00H     | DATA=00H
    
```

PROGRAM|ACTUAL|PART|BLOCK|CHECK|
SELECT|POSIT.|PROGRAM|DATA|SEARCH|ATC/APC|DATA|[EXTEND]

F1 F2 F3 F4 F5 F6 F7 F8

bit	[INPUT]			[OUTPUT]		
	label	address	signal name	label	address	signal name
bit0	ipSHWN	0030	Work shower PB	opSHWL	0030	Work shower PL
bit1	ipOHP	0031	Oilhole high PB	opOHHL	0031	Oilhole high PL
bit2	ipOHLM	0032	Oilhole PB	opOHLL	0032	Oilhole PL
bit3	ipOLMN	0033	Oil mist PB	opOLML	0033	Oil mist PL
bit4	ipSP2	0034	Water gun PB	opSP2L	0034	Spare 2
bit5	ipWAAN	0035	Airblow adapter PB	opWAAL	0035	Air blow adapter PL
bit6	ipWANN	0036	Airblow nozzle PB	opWANL	0036	Air blow nozzle PL
bit7	ipCOLN	0037	Coolant PB	opCOLL	0037	Coolant PL
bit8	ipPNIP	0038	Panel interlock 2 SW		0038	
bit9	ipPNPP	0039	Panel interlock 1 SW		0039	
bitA	ipSP3	003A	Chip flush-out PB	opSP3L	003A	Chip flush-out PL
bitB	ipCHPN	003B	Chip conveyer PB	opCHPL	003B	Chip conveyer PL
bitC	ipCHCC	003C	Chip conveyer temp CCW PB	opCCPL	003C	Chip conveyer temp CCW PL
bitD	ipSP1	003D	Through air blow PB	opSP1L	003D	Through air blow PL
bitE	ipLUBE	003E	Lubrication PB	opLUBL	003E	Lubrication PL
bitF	ipLION	003F	Light PB	opLITL	003F	Light ON PL

I/O CHECK No. 4 < Slave station 3 SS03 1/2 >

```

AUTO OPERATION          A.MIN          0      N      1
                        97/08/07 12:00:00
CHECK DATA      I/O CHECK NO. 4      PAGE 5  1mm
                                                SS03 1/2

  [INPUT]          |          [OUTPUT]
BIT LABEL  BIT LABEL | BIT LABEL  BIT LABEL
0          8          | 0 opALML   8 opBUZZER
1          9          | 1 opLIMT   9
2          A          | 2 opPSTP   A
3          B          | 3 opNTST   B
4          C          | 4 opSTME   C
5          D          | 5 opPEXE   D
6          E          | 6 opSPLB   E
7          F          | 7 opSPLA   F
DATA=00H      DATA=00H | DATA=00H  DATA=00H
    
```

```

PROGRAM|ACTUAL|PART | BLOCK |          | CHECK |
SELECT| POSIT.|PROGRAM| DATA |SEARCH |ATC/APC| DATA |[EXTEND]
    
```

F1 F2 F3 F4 F5 F6 F7 F8

bit	[INPUT]			[OUTPUT]		
	label	address	signal name	label	address	signal name
bit0		0040	Rapid feed & spindle override	opALML	0040	ALARM PL
bit1		0041	Rapid feed & spindle override	opLIMT	0041	AXIS LIMIT PL
bit2		0042	Rapid feed & spindle override	opPSTP	0042	PROGRAM STOP PL
bit3		0043	Rapid feed & spindle override	opNTST	0043	NC TEMPORARY STOP PL
bit4		0044	Rapid feed & spindle override	opSTME	0044	S/T/M EXECUTING PL
bit5		0045	Rapid feed & spindle override	opPEXE	0045	PROGRAM EXECUTING PL
bit6		0046	Rapid feed & spindle override	opSPLB	0046	spare B
bit7		0047	Rapid feed & spindle override	opSPLA	0047	spare A
bit8		0048	Rapid feed & spindle override	opBUZZER	0048	BUZZER ON
bit9		0049	Rapid feed & spindle override		0049	
bitA		004A	Rapid feed & spindle override		004A	
bitB		004B	Rapid feed & spindle override		004B	
bitC		004C	Rapid feed & spindle override		004C	
bitD		004D	Rapid feed & spindle override		004D	
bitE		004E	Rapid feed & spindle override		004E	
bitF		004F	Rapid feed & spindle override		004F	

I/O CHECK No. 5 < Slave station 3 SS03 2/2 >

```

AUTO OPERATION          A.MIN          0      N      1
                        97/08/07 12:00:00
CHECK DATA      I/O CHECK NO. 5      PAGE 6      1mm
                                                SS03 2/2

  [INPUT]
BIT LABEL      BIT LABEL      |      BIT LABEL      BIT LABEL
0              8              |      0              8 opMAMA
1              9              |      1              9 opTDST
2              A              |      2              A opODST
3              B              |      3              B opPDST
4              C              |      4              C opPROP
5              D              |      5              D opMAN
6              E              |      6              E opMDI
7              F              |      7              F opAUT
DATA=00H      DATA=00H      |      DATA=00H      DATA=00H

=

PROGRAM|ACTUAL|PART | BLOCK | | CHECK |
SELECT| POSIT.|PROGRAM| DATA |SEARCH |ATC/APC| DATA |[EXTEND]
    
```

F1 F2 F3 F4 F5 F6 F7 F8

bit	[INPUT]			[OUTPUT]		
	label	address	signal name	label	address	signal name
bit0		0050	Feed speed RS & feed override		0050	
bit1		0051	Feed speed RS & feed override		0051	
bit2		0052	Feed speed RS & feed override		0052	
bit3		0053	Feed speed RS & feed override		0053	
bit4		0054	Feed speed RS & feed override		0054	
bit5		0055	Feed speed RS & feed override		0055	
bit6		0056	Feed speed RS & feed override		0056	
bit7		0057	Feed speed RS & feed override		0057	
bit8		0058	Feed speed RS & feed override	opMAMA	0058	Mode select' Machine management'
bit9		0059	Feed speed RS & feed override	opTDST	0059	Mode select' Tool data set'
bitA		005A	Feed speed RS & feed override	opODST	005A	Mode select' Origin position set'
bitB		005B	Feed speed RS & feed override	opPDST	005B	Mode select' Parameter data set'
bitC		005C	Feed speed RS & feed override	opPROP	005C	Mode select' Program operation'
bitD		005D	Feed speed RS & feed override	opMAN	005D	Mode select' Manual operation'
bitE		005E	Feed speed RS & feed override	opMDI	005E	Mode select' Manual Data Input'
bitF		005F	Feed speed RS & feed override	opAUT	005F	Mode select' Auto operation'

I/O CHECK No. 6 < Slave station 4 SS04 1/2 >

AUTO OPERATION		A. MIN	0	N	1
CHECK DATA	I/O CHECK NO.	6	97/08/07	12:00:00	
			PAGE 7	1ma	
				SS04 1/2	
[INPUT]		[OUTPUT]			
BIT LABEL	BIT LABEL	BIT LABEL	BIT LABEL	BIT LABEL	BIT LABEL
0	8 ipPHZ2	0	8		
1	9	1	9		
2	A ipPH6	2	A		
3	B ipPH5	3	B		
4	C ipPH4	4	C		
5 ipPH10	D ipPHZ	5	D		
6 ipPH50	E ipPHY	6	E		
7 ipP100	F ipPHX	7	F		
DATA=00H	DATA=00H	DATA=00H	DATA=00H	DATA=00H	DATA=00H
=					
PROGRAM	ACTUAL	PART	BLOCK	CHECK	
SELECT	POSIT.	PROGRAM	DATA	SEARCH	ATC/APC
				DATA	[EXTEND]

F1 F2 F3 F4 F5 F6 F7 F8

bit	[INPUT]			[OUTPUT]		
	label	address	signal name	label	address	signal name
bit0		0060			0060	
bit1		0061			0061	
bit2		0062			0062	
bit3		0063			0063	
bit4		0064			0064	
bit5	ipPH10	0065	Pulse handle X10		0065	
bit6	ipPH50	0066	Pulse handle X50		0066	
bit7	ipP100	0067	Pulse handle X100		0067	
bit8	ipPHZ2	0068	Pulse handle Z2		0068	
bit9		0069			0069	
bitA	ipPH6	006A	Pulse handle select 6th axis SW		006A	
bitB	ipPH5	006B	Pulse handle select 5th axis SW		006B	
bitC	ipPH4	006C	Pulse handle select 4th axis SW		006C	
bitD	ipPHZ	006D	Pulse handle select Z axis SW		006D	
bitE	ipPHY	006E	Pulse handle select Y axis SW		006E	
bitF	ipPHX	006F	Pulse handle select X axis SW		006F	

I/O CHECK No. 7 < Slave station 4 SS04 2/2 >

```

AUTO OPERATION          A.MIN          0      N      1
                        97/08/07 12:00:00
CHECK DATA      I/O CHECK NO. 7      PAGE 8      100
                                      SS04 2/2

      [INPUT]          |          [OUTPUT]
BIT LABEL  BIT LABEL  |  BIT LABEL  BIT LABEL
0          8          |  0          8
1          9          |  1          9
2          A          |  2          A
3          B          |  3          B
4          C          |  4          C
5          D          |  5          D
6          E          |  6          E
7          F          |  7          F
DATA=00H    DATA=00H |  DATA=00H  DATA=00H
    
```

=

```

PROGRAM|ACTUAL |PART | BLOCK | | CHECK |
SELECT| POSIT. |PROGRAM| DATA |SEARCH |ATC/APCI| DATA |[EXTEND]
    
```

F1 F2 F3 F4 F5 F6 F7 F8

bit	[INPUT]			[OUTPUT]		
	label	address	signal name	label	address	signal name
bit0		0070			0070	
bit1		0071			0071	
bit2		0072			0072	
bit3		0073			0073	
bit4		0074			0074	
bit5		0075			0075	
bit6		0076			0076	
bit7		0077			0077	
bit8		0078			0078	
bit9		0079			0079	
bitA		007A			007A	
bitB		007B			007B	
bitC		007C			007C	
bitD		007D			007D	
bitE		007E			007E	
bitF		007F			007F	

I/O CHECK No. 8 < Slave station 5 SS05 1/2 >

```

AUTO OPERATION          A.MIN      0      N      1
                        97/08/07 12:00:00
CHECK DATA      I/O CHECK NO. 8      PAGE 9      1mm
                                      SS05 1/2

  [INPUT]          |          [OUTPUT]
BIT LABEL  BIT LABEL | BIT LABEL  BIT LABEL
0 iFD20    8 iFD10   | 0          8 oFD1L
1 iFD21    9 iFD11   | 1          9 oFD2L
2 iFD22    A iFD12   | 2          A oFD3L
3 iFD23    B iFD13   | 3          B oFD4L
4 iFD24    C iFD14   | 4          C oFD5L
5 iFD25    D iFD15   | 5          D oFD6L
6 iFD26    E iFD16   | 6          E oFD7L
7 iFD27    F iFD17   | 7          F oFD8L
DATA=00H   DATA=00H | DATA=00H DATA=00H
    
```

```

PROGRAM|ACTUAL |PART | BLOCK | | CHECK |
SELECT| POS1T. |PROGRAM| DATA |SEARCH |ATC/APC| DATA |[EXTEND]
    
```

F1 F2 F3 F4 F5 F6 F7 F8

[INPUT]				[OUTPUT]		
bit	label	address	signal name	label	address	signal name
bit0	iFD20	0080	F1-digit feed F2		0080	
bit1	iFD21	0081	F1-digit feed F2		0081	
bit2	iFD22	0082	F1-digit feed F2		0082	
bit3	iFD23	0083	F1-digit feed F2		0083	
bit4	iFD24	0084	F1-digit feed F2		0084	
bit5	iFD25	0085	F1-digit feed F2		0085	
bit6	iFD26	0086	F1-digit feed F2		0086	
bit7	iFD27	0087	F1-digit feed F2		0087	
bit8	iFD10	0088	F1-digit feed F1	oFD1L	0088	F1-digit feed F1 HL
bit9	iFD11	0089	F1-digit feed F1	oFD2L	0089	F1-digit feed F2 HL
bitA	iFD12	008A	F1-digit feed F1	oFD3L	008A	F1-digit feed F3 HL
bitB	iFD13	008B	F1-digit feed F1	oFD4L	008B	F1-digit feed F4 HL
bitC	iFD14	008C	F1-digit feed F1	oFD5L	008C	F1-digit feed F5 HL
bitD	iFD15	008D	F1-digit feed F1	oFD6L	008D	F1-digit feed F6 HL
bitE	iFD16	008E	F1-digit feed F1	oFD7L	008E	F1-digit feed F7 HL
bitF	iFD17	008F	F1-digit feed F1	oFD8L	008F	F1-digit feed F8 HL

I/O CHECK No. 9 < Slave station 5 SS05 2/2 >

```

AUTO OPERATION          A. MIN      0      N      1
                        97/08/07 12:00:00
CHECK DATA            I/O CHECK NO. 9      PAGE 10      1mm
                                                SS05 2/2

  [INPUT]                |                [OUTPUT]
BIT LABEL              BIT LABEL | BIT LABEL | BIT LABEL
0 iFD40                8 iFD30  | 0         | 8
1 iFD41                9 iFD31  | 1         | 9
2 iFD42                A iFD32  | 2         | A
3 iFD43                B iFD33  | 3         | B
4 iFD44                C iFD34  | 4         | C
5 iFD45                D iFD35  | 5         | D
6 iFD46                E iFD36  | 6         | E
7 iFD47                F iFD37  | 7         | F
DATA=00H              DATA=00H | DATA=00H | DATA=00H
    
```

=

```

PROGRAM|ACTUAL|PART | BLOCK | | CHECK |
SELECT|POSIT.|PROGRAM| DATA |SEARCH |ATC/APC| DATA |[EXTEND]
    
```

F1 F2 F3 F4 F5 F6 F7 F8

bit	[INPUT]			[OUTPUT]		
	label	address	signal name	label	address	signal name
bit0	iFD40	0090	F1-digit feed F4		0090	
bit1	iFD41	0091	F1-digit feed F4		0091	
bit2	iFD42	0092	F1-digit feed F4		0092	
bit3	iFD43	0093	F1-digit feed F4		0093	
bit4	iFD44	0094	F1-digit feed F4		0094	
bit5	iFD45	0095	F1-digit feed F4		0095	
bit6	iFD46	0096	F1-digit feed F4		0096	
bit7	iFD47	0097	F1-digit feed F4		0097	
bit8	iFD30	0098	F1-digit feed F3		0098	
bit9	iFD31	0099	F1-digit feed F3		0099	
bitA	iFD32	009A	F1-digit feed F3		009A	
bitB	iFD33	009B	F1-digit feed F3		009B	
bitC	iFD34	009C	F1-digit feed F3		009C	
bitD	iFD35	009D	F1-digit feed F3		009D	
bitE	iFD36	009E	F1-digit feed F3		009E	
bitF	iFD37	009F	F1-digit feed F3		009F	

I/O CHECK No. 10 < Slave station 6 SS06 1/2 >

```

AUTO OPERATION          A.MIN          0      N      1
                        97/08/07 12:00:00
CHECK DATA      I/O CHECK NO. 10      PAGE 11      1mm
                                                SS06 1/2

  [INPUT]          |          [OUTPUT]
BIT LABEL      BIT LABEL | BIT LABEL      BIT LABEL
0 iFD60        8 iFD50   | 0              8
1 iFD61        9 iFD51   | 1              9
2 iFD62        A iFD52   | 2              A
3 iFD63        B iFD53   | 3              B
4 iFD64        C iFD54   | 4              C
5 iFD65        D iFD55   | 5              D
6 iFD66        E iFD56   | 6              E
7 iFD67        F iFD57   | 7              F
DATA=00H      DATA=00H | DATA=00H      DATA=00H
    
```

```

PROGRAM|ACTUAL|PART | BLOCK | | CHECK |
SELECT| POSIT.|PROGRAM| DATA |SEARCH |ATC/APC| DATA |[EXTEND]
    
```

F1 F2 F3 F4 F5 F6 F7 F8

[INPUT]				[OUTPUT]		
bit	label	address	signal name	label	address	signal name
bit0	iFD60	0100	F1-digit feed F6		0100	
bit1	iFD61	0101	F1-digit feed F6		0101	
bit2	iFD62	0102	F1-digit feed F6		0102	
bit3	iFD63	0103	F1-digit feed F6		0103	
bit4	iFD64	0104	F1-digit feed F6		0104	
bit5	iFD65	0105	F1-digit feed F6		0105	
bit6	iFD66	0106	F1-digit feed F6		0106	
bit7	iFD67	0107	F1-digit feed F6		0107	
bit8	iFD50	0108	F1-digit feed F5		0108	
bit9	iFD51	0109	F1-digit feed F5		0109	
bitA	iFD52	010A	F1-digit feed F5		010A	
bitB	iFD53	010B	F1-digit feed F5		010B	
bitC	iFD54	010C	F1-digit feed F5		010C	
bitD	iFD55	010D	F1-digit feed F5		010D	
bitE	iFD56	010E	F1-digit feed F5		010E	
bitF	iFD57	010F	F1-digit feed F5		010F	

I/O CHECK No. 11 < Slave station 6 SS06 2/2 >

```

AUTO OPERATION          A.MIN          0      N      1
                        97/08/07 12:00:00
CHECK DATA            I/O CHECK NO. 11  PAGE 12  1mm
                                                SS06 2/2

  [INPUT]
BIT LABEL  BIT LABEL  | BIT LABEL  BIT LABEL
0 iFD80    8 iFD70    | 0          8
1 iFD81    9 iFD71    | 1          9
2 iFD82    A iFD72    | 2          A
3 iFD83    B iFD73    | 3          B
4 iFD84    C iFD74    | 4          C
5 iFD85    D iFD75    | 5          D
6 iFD86    E iFD76    | 6          E
7 iFD87    F iFD77    | 7          F
DATA=00H   DATA=00H | DATA=00H  DATA=00H

=

PROGRAM|ACTUAL|PART | BLOCK | | CHECK |
SELECT| POSIT.|PROGRAM| DATA |SEARCH |ATC/APC| DATA |[EXTEND]
  
```

F1 F2 F3 F4 F5 F6 F7 F8

bit	[INPUT]			[OUTPUT]		
	label	address	signal name	label	address	signal name
bit0	iFD80	0110	F1-digit feed F8		0110	
bit1	iFD81	0111	F1-digit feed F8		0111	
bit2	iFD82	0112	F1-digit feed F8		0112	
bit3	iFD83	0113	F1-digit feed F8		0113	
bit4	iFD84	0114	F1-digit feed F8		0114	
bit5	iFD85	0115	F1-digit feed F8		0115	
bit6	iFD86	0116	F1-digit feed F8		0116	
bit7	iFD87	0117	F1-digit feed F8		0117	
bit8	iFD70	0118	F1-digit feed F7		0118	
bit9	iFD71	0119	F1-digit feed F7		0119	
bitA	iFD72	011A	F1-digit feed F7		011A	
bitB	iFD73	011B	F1-digit feed F7		011B	
bitC	iFD74	011C	F1-digit feed F7		011C	
bitD	iFD75	011D	F1-digit feed F7		011D	
bitE	iFD76	011E	F1-digit feed F7		011E	
bitF	iFD77	011F	F1-digit feed F7		011F	

I/O CHECK No. 12 < Slave station 7 SS07 1/2 >

```

AUTO OPERATION          A. MIN          0 N          1
CHECK DATA          I/O CHECK NO. 12    PAGE 13    1mm    12:00:00
                                      SS07 1/2

  [INPUT]          |          [OUTPUT]
BIT LABEL          |          BIT LABEL          |          BIT LABEL          |          BIT LABEL
0                  |          8                  |          0                  |          8
1                  |          9                  |          1                  |          9
2                  |          A                  |          2                  |          A
3                  |          B                  |          3                  |          B
4                  |          C                  |          4                  |          C
5                  |          D                  |          5                  |          D
6                  |          E                  |          6                  |          E
7                  |          F                  |          7                  |          F
DATA=00H          |          DATA=00H          |          DATA=00H          |          DATA=00H
  
```

=

```

PROGRAM|ACTUAL |PART |BLOCK | |CHECK |
SELECT|POSIT. |PROGRAM| DATA |SEARCH |ATC/APC| DATA |[EXTEND]
  
```

F1 F2 F3 F4 F5 F6 F7 F8

bit	[INPUT]			[OUTPUT]		
	label	address	signal name	label	address	signal name
bit0		0120			0120	
bit1		0121			0121	
bit2		0122			0122	
bit3		0123			0123	
bit4		0124			0124	
bit5		0125			0125	
bit6		0126			0126	
bit7		0127			0127	
bit8		0128			0128	
bit9		0129			0129	
bitA		012A			012A	
bitB		012B			012B	
bitC		012C			012C	
bitD		012D			012D	
bitE		012E			012E	
bitF		012F			012F	

I/O CHECK No. 13 < Slave station 7 SS07 2/2 >

```

AUTO OPERATION          A.MIN          0      N      1
                        97/08/07 12:00:00
CHECK DATA      I/O CHECK NO. 13      PAGE 14      1mm
                                                SS07 2/2

      [INPUT]          |          [OUTPUT]
BIT LABEL          BIT LABEL          |          BIT LABEL          BIT LABEL
0                  8 iIGON             |          0                  8 oIGTL
1                  9 iIGWG             |          1                  9 oIGPL
2                  A iIGTG              |          2                  A oIGML
3                  B iIGPS              |          3                  B oIGAL
4                  C iIGMS              |          4                  C
5                  D iIGAT              |          5                  D
6                  E                   |          6                  E
7                  F                   |          7                  F
DATA=00H          DATA=00H          |          DATA=00H          DATA=00H
    
```

=

```

PROGRAM|ACTUAL |PART | BLOCK |          | CHECK |
SELECT| POSIT. |PROGRAM| DATA |SEARCH |ATC/APC| DATA |[EXTEND]
    
```

F1 F2 F3 F4 F5 F6 F7 F8

bit	[INPUT]			[OUTPUT]		
	label	address	signal name	label	address	signal name
bit0		0130			0130	
bit1		0131			0131	
bit2		0132			0132	
bit3		0133			0133	
bit4		0134			0134	
bit5		0135			0135	
bit6		0136			0136	
bit7		0137			0137	
bit8	iIGON	0138	Interactive Gauging: gauging SW	oIGTL	0138	Interactive Gauging: touch signal
bit9	iIGWG	0139	Interactive Gauging: work gauging SW	oIGPL	0139	Interactive Gauging: + block mode PL
bitA	iIGTG	013A	Interactive Gauging: tool gauging SW	oIGML	013A	Interactive Gauging: - block mode PL
bitB	iIGPS	013B	Interactive Gauging: + block mode PB	oIGAL	013B	Interactive Gauging: auto mode PL
bitC	iIGMS	013C	Interactive Gauging: - block mode PB		013C	
bitD	iIGAT	013D	Interactive Gauging: auto mode PB		013D	
bitE		013E			013E	
bitF		013F			013F	

I/O CHECK No. 18 < Slave station 10 SS10 1/2 >

```

AUTO OPERATION          A.MIN          0      N      I
                        97/08/07    12:00:00
CHECK DATA      I/O CHECK NO. 18    PAGE 15    100
                                                SS10 1/2

  [INPUT]          |          [OUTPUT]
BIT LABEL          | BIT LABEL          | BIT LABEL          | BIT LABEL
0 iPN01            | B iPN09            | 0 oPN01            | 8 oPN09
1 iPN02            | 9 iPN10            | 1 oPN02            | 9 oPN10
2 iPN03            | A iPN11            | 2 oPN03            | A oPN11
3 iPN04            | B iPN12            | 3 oPN04            | B oPN12
4 iPN05            | C iPN13            | 4 oPN05            | C oPN13
5 iPN06            | D iPN14            | 5 oPN06            | D oPN14
6 iPN07            | E iPN15            | 6 oPN07            | E oPN15
7 iPN08            | F iPN16            | 7 oPN08            | F oPN16
DATA=00H          | DATA=00H          | DATA=00H          | DATA=00H
  
```

=

```

PROGRAM|ACTUAL |PART | BLOCK | | | CHECK |
SELECT|POSIT. |PROGRAM| DATA |SEARCH |ATC/APC| DATA |[EXTEND]
  
```

F1 F2 F3 F4 F5 F6 F7 F8

[INPUT]				[OUTPUT]		
bit	label	address	signal name	label	address	signal name
bit0	iPN01	0180	External program select PN01	oPN01	0180	External program select PN01
bit1	iPN02	0181	External program select PN02	oPN02	0181	External program select PN02
bit2	iPN03	0182	External program select PN03	oPN03	0182	External program select PN03
bit3	iPN04	0183	External program select PN04	oPN04	0183	External program select PN04
bit4	iPN05	0184	External program select PN05	oPN05	0184	External program select PN05
bit5	iPN06	0185	External program select PN06	oPN06	0185	External program select PN06
bit6	iPN07	0186	External program select PN07	oPN07	0186	External program select PN07
bit7	iPN08	0187	External program select PN08	oPN08	0187	External program select PN08
bit8	iPN09	0188	External program select PN09	oPN09	0188	External program select PN09
bit9	iPN10	0189	External program select PN10	oPN10	0189	External program select PN10
bitA	iPN11	018A	External program select PN11	oPN11	018A	External program select PN11
bitB	iPN12	018B	External program select PN12	oPN12	018B	External program select PN12
bitC	iPN13	018C	External program select PN13	oPN13	018C	External program select PN13
bitD	iPN14	018D	External program select PN14	oPN14	018D	External program select PN14
bitE	iPN15	018E	External program select PN15	oPN15	018E	External program select PN15
bitF	iPN16	018F	External program select PN16	oPN16	018F	External program select PN16

I/O CHECK No. 19 < Slave station 10 SS10 2/2 >

```

AUTO OPERATION          A.MIN          0      N      1
                        97/08/07 12:00:00
CHECK DATA      I/O CHECK NO. 19      PAGE 16      1mm
                                                SS10 2/2

[INPUT]
BIT LABEL      BIT LABEL      |      BIT LABEL      BIT LABEL
0              8 iPRSR        |      0              8 oPRSA
1              9 iERST        |      1              9 oPRNA
2              A              |      2              A oPRER
3              B              |      3              B
4              C              |      4              C
5              D              |      5              D
6              E              |      6              E
7              F iPRTY        |      7              F
DATA=00H        DATA=00H      |      DATA=00H        DATA=00H

=

PROGRAM|ACTUAL |PART | BLOCK |      |      | CHECK |
SELECT| POSIT. |PROGRAM| DATA |SEARCH |ATC/APC| DATA |[EXTEND]
    
```

F1 F2 F3 F4 F5 F6 F7 F8

bit	[INPUT]			[OUTPUT]		
	label	address	signal name	label	address	signal name
bit0		0190			0190	
bit1		0191			0191	
bit2		0192			0192	
bit3		0193			0193	
bit4		0194			0194	
bit5		0195			0195	
bit6		0196			0196	
bit7		0197			0197	
bit8	iPRSR	0198	External program select STB	oPRSA	0198	External program select complete
bit9	iERST	0199	External program reset	oPRNA	0199	External program select number agreement
bitA		019A		oPRER	019A	External program select unusual end
bitB		019B			019B	
bitC		019C			019C	
bitD		019D			019D	
bitE		019E			019E	
bitF	iPRTY	019F	External program select bit parity		019F	

I/O CHECK No. 20 < Slave station 11 SS11 1/2 >

```

AUTO OPERATION          A. MIN          0      N      1
                        97/08/07 12:00:00
CHECK DATA      I/O CHECK NO. 20      PAGE 17      1mm
                                                SS11 1/2

  [INPUT]          |          [OUTPUT]
BIT LABEL          | BIT LABEL          | BIT LABEL          | BIT LABEL
0 iESP/            | 8 iOPOF/           | 0 oOPON1           | 8 oPWON1
1 iPUT/            | 9 iEMMON           | 1 oOPON2           | 9 oPWON2
2 iTHP/            | A                  | 2 oPWOFF           | A oZUBR
3 iAXE/            | B iCONP/           | 3 oNCUOF           | B oMGUB
4 iSTEN            | C iTROH/           | 4 oWRKL             | C oHMT2
5 iWARI            | D                  | 5 oAMLT             | D oHMT3
6 iPOFF            | E                  | 6 oDPL3             | E oNCRUN
7 iTMOF            | F                  | 7 oBUZZ             | F oWRKC
DATA=00H          | DATA=00H          | DATA=00H          | DATA=00H
  
```

```

PROGRAM|ACTUAL|PART | BLOCK | | CHECK |
SELECT| POSIT.|PROGRAM| DATA |SEARCH |ATC/APC| DATA |[EXTEND]
  
```

F1 F2 F3 F4 F5 F6 F7 F8

[INPUT]			[OUTPUT]			
bit	label	address	signal name	label	address	signal name
bit0	iESP/	0200	Emergency stop (Power on) KA	oOPON1	0200	Axis Control ON 1 KA
bit1	iPUT/	0201	Light Power unit OK QF	oOPON2	0201	Axis Control ON 2 KA
bit2	iTHP/	0202	Temperature unusual ST	oPWOFF	0202	Power off control ON KA
bit3	iAXE/	0203	NC axis stroke end limit KA	oNCUOF	0203	NC Power Supply OFF KA
bit4	iSTEN	0204	Axis stroke end limit release SB	oWRKL	0204	Working fin lamp HL
bit5	iWARI	0205	Warming up ON KA	oAMLT	0205	Alarm lamp HL
bit6	iPOFF	0206	Auto Power Off SW	oDPL3	0206	3rd condition lamp (NC executing) HL
bit7	iTMOF	0207	Thermal offset SW	oBUZZ	0207	Working fin buzzer KA
bit8	iOPOF/	0208	Operate Power OFF SB	oPWON1	0208	Axis Power ON 1 KA
bit9	iEMMON	0209	Emergency stop monitor FR	oPWON2	0209	Axis Power ON 2 KA
bitA		020A		oZUBR	020A	Z-axis unbrake KA
bitB	iCONP/	020B	Operation Power OK FR	oMGUB	020B	MG-axis unbrake KA
bitC	iTROH/	020C	Transformer Overheat FR	oHMT2	020C	2nd hour meter (NC executing) KA
bitD		020D		oHMT3	020D	3rd hour meter (KIENZLE) KA
bitE		020E		oNCRUN	020E	NC Control KA
bitF		020F		oWRKC	020F	Work counter KA

I/O CHECK No. 21 < Slave station 11 SS11 2/2 >

```

AUTO OPERATION          A. MIN          0      N      1
                        97/08/07 12:00:00
CHECK DATA          I/O CHECK NO. 21    PAGE 18    1nn
                                                SS11 2/2

      [INPUT]          |          [OUTPUT]
BIT LABEL  BIT LABEL  |  BIT LABEL  BIT LABEL
0 iCHFL    8          |  0          8
1 iCOLM    9          |  1          9
2 iOCR/    A          |  2          A
3 iHDM/    B          |  3          B
4 iOLHM    C          |  4          C
5 iWKGK    D          |  5          D
6 iCIPN    E iDBCO    |  6          E
7 iWKSW    F iDBBO    |  7          F
DATA=00H   DATA=00H | DATA=00H   DATA=00H

PROGRAM|ACTUAL|PART | BLOCK |          | CHECK |
SELECT| POSIT.|PROGRAM| DATA |SEARCH |ATC/APC| DATA |[EXTEND]
    
```

F1 F2 F3 F4 F5 F6 F7 F8

bit	[INPUT]			[OUTPUT]		
	label	address	signal name	label	address	signal name
bit0	iCHFL	0210	Chip flush-out motor ON KM		0210	
bit1	iCOLM	0211	Coolant motor ON KM		0211	
bit2	iOCR/	0212	Spindle head cooling unit OK KM		0212	
bit3	iHDM/	0213	Hydraulic unit ON KM		0213	
bit4	iOLHM	0214	Oilhole motor ON KM		0214	
bit5	iWKGK	0215	Work wash gun motor ON KM		0215	
bit6	iCIPN	0216	Chip conveyer motor ON KM		0216	
bit7	iWKSW	0217	Work shower motor ON KM		0217	
bit8		0218			0218	
bit9		0219			0219	
bitA		021A			021A	
bitB		021B			021B	
bitC		021C			021C	
bitD		021D			021D	
bitE	iDBCO	021E	DNC-B communication connect SA		021E	
bitF	iDBBO	021F	DNC-B buffer drive operation ON SA		021F	

I/O CHECK No. 22 < Slave station 12 SS12 1/2 >

AUTO OPERATION		A. MIN	0	N	1
CHECK DATA		I/O CHECK NO. 22	97/08/07	PAGE 19	12:00:00
					1mm
					SS12 1/2
[INPUT]			[OUTPUT]		
BIT LABEL	BIT LABEL		BIT LABEL	BIT LABEL	
0 iAON4	8 iCLP/		0 oACL4	8 oCPFL	
1 iACL4	9 iOCF/		1 oACL5	9 oCOLM	
2 iAUC4	A iHDL/		2 oTSAR	A oHDUN	
3 iAON5	B iOHT/		3 oFDRO	B oOHLM	
4 iACL5	C iOHFL		4 oFDRC	C oWSGN	
5 iAUC5	D		5	D oCPCW	
6 iEXAB	E iOAO/		6 oODLK	E oWSWM	
7 iTPBA	F		7	F	
DATA=00H	DATA=00H		DATA=00H	DATA=00H	

=

PROGRAM	ACTUAL	PART	BLOCK		CHECK
SELECT	POSIT.	PROGRAM	DATA	SEARCH	[ATC/APC] DATA [[EXTEND]

[INPUT]			[OUTPUT]			
bit	label	address	signal name	label	address	signal name
bit0	iAON4	0220	A/C(4th) axis connect confirmation SQ	oACL4	0220	A/C(4th) axis clamp YV
bit1	iACL4	0221	A/C(4th) axis clamp SQ	oACL5	0221	A/C(5th) axis clamp YV
bit2	iAUC4	0222	A/C(4th) axis unclamp SQ	oTSAR	0222	Touch sensor air blow YV
bit3	iAON5	0223	A/C(5th) axis connect confirmation SQ	oFDRO	0223	Front door open YV
bit4	iACL5	0224	A/C(5th) axis clamp SQ	oFDRC	0224	Front door close YV
bit5	iAUC5	0225	A/C(5th) axis unclamp SQ		0225	
bit6	iEXAB	0226	External M command answer back KA	oODLK	0226	Door lock YV
bit7	iTPBA	0227	Touch probe battery alarm KA		0227	
bit8	iCLP/	0228	Coolant tank oil level OK SL	oCPFL	0228	Chip flush-out motor on KM
bit9	iOCF/	0229	Sp-head cooling unit oil level OK SL	oCOLM	0229	Coolant motor on KM
bitA	iHDL/	022A	Hydraulic unit oil level OK SL	oHDUN	022A	Hydraulic, spindle cooling unit on KM
bitB	iOHT/	022B	Hi-pressure oil hole tank oil level OK SL	oOHLM	022B	Oil hole motor on KM
bitC	iOHFL	022C	Hi-pressure oil hole tank filter choke SL	oWSGN	022C	Work washing gun motor on KM
bitD		022D		oCPCW	022D	Chip conveyer motor on KM
bitE	iOAO/	022E	Oil air lube unit OK SL	oWSWM	022E	Work shower motor on KM
bitF		022F	022F		022F	

I/O CHECK No. 23 < Slave station 12 SS12 2/2 >

```

AUTO OPERATION          A. MIN          0      N          1
                        97/08/07 12:00:00
CHECK DATA      I/O CHECK NO. 23      PAGE 20      100
                                                SS12 2/2

  [INPUT]
BIT LABEL      BIT LABEL      BIT LABEL      BIT LABEL
0 iOULK        8 iTCRP          | 0 oEXM1        8 oTCRL
1 iCPOL        9 iTCPB          | 1 oEXM2        9 oSPUL
2 iODUL        A iTUPB          | 2 oEXM3        A oSPCL
3              B              | 3 oEXM4        B oDBCO
4 iCHCQ        C              | 4 oEXM5        C oDBBO
5 iCHUQ        D              | 5 oEXM6        D
6 iCHCS        E              | 6 oEXM7        E
7 iCHUS        F              | 7 oEXM8        F
DATA=00H      DATA=00H      | DATA=00H      DATA=00H
  
```

=

```

PROGRAM|ACTUAL |PART | BLOCK | | CHECK |
SELECT| POSIT. |PROGRAM| DATA |SEARCH |ATC/APC| DATA |[EXTEND]
  
```

F1 F2 F3 F4 F5 F6 F7 F8

bit	[INPUT]			[OUTPUT]		
	label	address	signal name	label	address	signal name
bit0	iOULK	0230	CE Operation door interlock restart SA	oEXM1	0230	External M command 1 (M181) KA
bit1	iCPOL	0231	CE Chip conveyer OL FR	oEXM2	0231	External M command 2 (M182) KA
bit2	iODUL	0232	CE Door lock release SA	oEXM3	0232	External M command 3 (M183) KA
bit3		0233		oEXM4	0233	External M command 4 (M184) KA
bit4	iCHCQ	0234	Chuck Clamp LS	oEXM5	0234	External M command 5 (M185) KA
bit5	iCHUQ	0235	Chuck Unclamp LS	oEXM6	0235	External M command 6 (M186) KA
bit6	iCHCS	0236	Chuck Clamp SB	oEXM7	0236	External M command 7 (M187) KA
bit7	iCHUS	0237	Chuck Unclamp SB	oEXM8	0237	External M command 8 (M188) KA
bit8	iTCRP	0238	Spindle tool change preparation SB	oTCRL	0238	Tool change preparation HL
bit9	iTCPB	0239	Spindle tool clamp SB	oSPUL	0239	Spindle tool unclamp HL
bitA	iTUPB	023A	Spindle tool unclamp SB	oSPCL	023A	Spindle tool clamp HL
bitB		023B		oDBCO	023B	DNC-B communication on HL
bitC		023C		oDBBO	023C	DNC-B buffer drive on HL
bitD		023D			023D	
bitE		023E			023E	
bitF		023F		oPPON	023F	Touch probe power on KA

I/O CHECK No. 26 < Slave station 14 SS14 1/2 >

AUTO OPERATION		A. MIN	0	N	1
CHECK DATA		I/O CHECK NO. 26	97/08/07	PAGE 21	12:00:00
					1mm
					SS14 1/2
[INPUT]			[OUTPUT]		
BIT LABEL	BIT LABEL		BIT LABEL	BIT LABEL	
0 iPLLD	8 iPADS		0 oPARS	8 oENSL	
1 iPULD	9 iPBKS		1 oSGOS	9 oENTL	
2 iPALS	A iPMIT		2 oSGCS	A oWKPL	
3 iPBLs	B iPRST		3 oPLDS	B oAPMI	
4 iPLEM	C iDOPN		4 oPULS	C oAPIL	
5 iPLCL	D iDCLS		5 oPLSA	D	
6 iPUCL	E iWPRE		6 oPLSB	E	
7 iPSIT	F iHCPO		7 oPLCS	F	
DATA=00H	DATA=00H		DATA=00H	DATA=00H	
=					
PROGRAM ACTUAL PART BLOCK CHECK					
SELECT POSIT. PROGRAM DATA SEARCH ATC/APC DATA [EXTEND]					

F1 F2 F3 F4 F5 F6 F7 F8

bit	[INPUT]			[OUTPUT]		
	label	address	signal name	label	address	signal name
bit0	iPLLD	0260	Pallet load SQ	oPARS	0260	Pallet air blow YV
bit1	iPULD	0261	Pallet unload SQ	oSGOS	0261	Splash guard open YV
bit2	iPALS	0262	Pallet advance SQ	oSGCS	0262	Splash guard close YV
bit3	iPBLs	0263	Pallet back SQ	oPLDS	0263	Pallet load YV
bit4	iPLEM	0264	Pallet exist SQ	oPULS	0264	Pallet unload YV
bit5	iPLCL	0265	Pallet clamp SQ	oPLSA	0265	Pallet advance YV
bit6	iPUCL	0266	Pallet unclamp SQ	oPLSB	0266	Pallet back YV
bit7	iPSIT	0267	Pallet sit SP	oPLCS	0267	Pallet clamp YV
bit8	iPADS	0268	Pallet advance PB SA	oENSL	0268	External NC start HL
bit9	iPBKS	0269	Pallet back PB SA	oENTL	0269	External NC temp stop HL
bitA	iPMIT	026A	APC manual int ON PB SA	oWKPL	026A	Work preparation fin HL
bitB	iPRST	026B	APC restart PB SB	oAPMI	026B	APC manual int HL
bitC	iDOPN	026C	Splash guard open PB SA	oAPIL	026C	APC interlock HL
bitD	iDCLS	026D	Splash guard close PB SA		026D	
bitE	iWPRE	026E	Work preparation fin PB SA		026E	
bitF	iHCPO	026F	Hydraulic coupler exist SQ		026F	

I/O CHECK No. 27 < Slave station 14 SS14 2/2 >

```

AUTO OPERATION          A. MIN          0      N          1
CHECK DATA          I/O CHECK NO. 27    PAGE 22    1mm    97/08/07 12:00:00
                                          SS14 2/2
[INPUT]
BIT LABEL           BIT LABEL           |           BIT LABEL           BIT LABEL
0                   8 iSPGO           | 0           8 oPLUS
1                   9 iSPGC           | 1           9
2                   A iAPDC           | 2           A
3                   B                   | 3           B
4                   C                   | 4           C
5                   D                   | 5           D
6                   E                   | 6           E
7                   F                   | 7           F
DATA=00H           DATA=00H           |           DATA=00H           DATA=00H
=
PROGRAM|ACTUAL|PART|BLOCK| | |CHECK|
SELECT|POSIT.|PROGRAM|DATA|SEARCH|ATC/APC|DATA|[EXTEND]
    
```

F1 F2 F3 F4 F5 F6 F7 F8

bit	[INPUT]			[OUTPUT]		
	label	address	signal name	label	address	signal name
bit0		0270			0270	
bit1		0271			0271	
bit2		0272			0272	
bit3		0273			0273	
bit4		0274			0274	
bit5		0275			0275	
bit6		0276			0276	
bit7		0277			0277	
bit8	iSPGO	0278	Splash guard open SQ	oPLUS	0278	Pallet unclamp YV
bit9	iSPGC	0279	Splash guard close SQ		0279	
bitA	iAPDC	027A	Tooling area door close SQ		027A	
bitB		027B			027B	
bitC		027C			027C	
bitD		027D			027D	
bitE		027E			027E	
bitF		027F			027F	

I/O CHECK No. 28 < Slave station 15 SS15 2/2 >

```

AUTO OPERATION          A. MIN          0      N      1
                        97/08/07 12:00:00
CHECK DATA          I/O CHECK NO. 28    PAGE 23  1mm
                                                SS15 1/2

[INPUT]                |                [OUTPUT]
BIT LABEL             | BIT LABEL       | BIT LABEL       | BIT LABEL
0 iMRST               | 8 iMDC/         | 0 oMGMI         | 8 oTSCH
1 iFDCL               | 9 iPVRT         | 1 oMGD          | 9 oMACH
2 iFDOP               | A iPHOR         | 2 oLCHC         | A oMPTD
3 iDRCP               | B iTSCH         | 3              | B oMPH
4 iDROP               | C iMACH         | 4              | C
5 iDULC               | D iMGIN         | 5              | D
6 iSRDC               | E iMGCW         | 6              | E oLBPLS
7                    | F iMGCC         | 7 oLIHT         | F oSPRV
DATA=00H              | DATA=00H       | DATA=00H       | DATA=00H

PROGRAM|ACTUAL|PART | BLOCK | | CHECK |
SELECT| POSIT.|PROGRAM| DATA |SEARCH |ATC/APC| DATA |[EXTEND]
    
```

F1 F2 F3 F4 F5 F6 F7 F8

[INPUT]				[OUTPUT]		
bit	label	address	signal name	label	address	signal name
bit0	iMRST	0280	Magazine door interlock restart PB SB	oMGMI	0280	Magazine manual int HL
bit1	iFDCL	0281	Front door close SQ	oMGD	0281	Magazine door interlock HL
bit2	iFDOP	0282	Front door open SQ	oLCHC	0282	Chuck Clamp HL
bit3	iDRCP	0283	Front door close SA		0283	
bit4	iDROP	0284	Front door open SA		0284	
bit5	iDULC	0285	Door Lock Pin Unlock		0285	
bit6	iSRDC	0286	Safety Relay Door close		0286	
bit7		0287		oLIHT	0287	Light on HL
bit8	iMDC/	0288	Magazine manual door close SQ	oTSCH	0288	ATC action position YV
bit9	iPVRT	0289	Magazine pot DOWN position SQ	oMACH	0289	Magazine movable position YV
bitA	iPHOR	028A	Magazine pot UP position SQ	oMPTD	028A	Magazine pot DOWN YV
bitB	iTSCH	028B	Tool arm movable SQ	oMPH	028B	Magazine pot UP YV
bitC	iMACH	028C	Magazine movable SQ		028C	
bitD	iMGIN	028D	Magazine manual int PB SA		028D	
bitE	iMGCW	028E	Magazine manual operation CW PB SB	oLBPLS	028E	Oil air lube unit run YV
bitF	iMGCC	028F	Magazine manual operation CCW PB SB	oSPRV	028F	Oil air lube unit air supply valve

I/O CHECK No. 29 < Slave station 15 SS15 1/2 >

```

AUTO OPERATION          A.MIN          0      N          1
                        97/08/07 12:00:00
CHECK DATA            I/O CHECK NO. 29  PAGE 24  1mm
                                                SS15 2/2

[INPUT]                |                [OUTPUT]
BIT LABEL              | BIT LABEL      | BIT LABEL      | BIT LABEL
0                      | 8 iISCL       | 0 oCHCY       | 8 oISUC
1                      | 9 iISUC       | 1 oCHUY       | 9 oOSUC
2                      | A iOSUC       | 2             | A oSPAR
3                      | B iSCLP       | 3             | B oNSAR
4                      | C iSTNE       | 4             | C oADAR
5                      | D iDRRP       | 5             | D oOHAR
6                      | E iATDO       | 6 oRDPR       | E oOLMS
7                      | F iATDC       | 7 oTHPR       | F
DATA=00H              | DATA=00H     | DATA=00H     | DATA=00H
    
```

```

PROGRAM|ACTUAL |PART | BLOCK |          | CHECK |
SELECT| POSIT. |PROGRAM| DATA |SEARCH |ATC/APC| DATA |[EXTEND]
    
```

F1 F2 F3 F4 F5 F6 F7 F8

bit	[INPUT]			[OUTPUT]		
	label	address	signal name	label	address	signal name
bit0		0290		oCHCY	0290	Chuck Clamp YV
bit1		0291		oCHUY	0291	Chuck Unclamp YV
bit2		0292			0292	
bit3		0293			0293	
bit4		0294			0294	
bit5		0295			0295	
bit6		0296		oRDPR	0296	Radial pressure YV
bit7		0297		oTHPR	0297	Thrust pressure YV
bit8	iISCL	0298	Spindle tool in cylinder clamp LS	oISUC	0298	Spindle tool in cylinder unclamp YV
bit9	iISUC	0299	Spindle tool in cylinder unclamp LS	oOSUC	0299	Spindle tool out cylinder unclamp YV
bitA	iOSUC	029A	Spindle tool out cylinder unclamp LS	oSPAR	029A	Spindle air blow YV
bitB	iSCLP	029B	Spindle tool cylinder retreat SQ	oNSAR	029B	Work air blow (nozzle) YV
bitC	iSTNE	029C	Spindle tool exist SQ	oADAR	029C	Work air blow (adapter) YV
bitD	iDRRP	029D	Insert Safety Door Lock Pin	oOHAR	029D	Through Spindle air blow
bitE	iATDO	029E	ATC Magazine Shutter open	oOLMS	029E	Oil mist YV
bitF	iATDC	029F	ATC Magazine Shutter close		029F	

3. CNC Diagnostic Screen

The status of the memory in the CNC can be found by displaying the CHECK DATA MEMORY screen. This diagnostic function is very convenient since the display format can be selected from among decimal number, hexadecimal, floating-point number, bit-string, etc.

When using the CHECK DATA MEMORY screen, please consult your local Okuma representative.

AUTO OPERATION		N		1
CHECK DATA		MEMORY DATA		97/07/15 14:10:00
				PAGE 8 1mm
MACHINE COORDS	X	Y	Z	
	-0.001	-0.001	-0.001	
DCM-P0	\$00000000			
1	\$00000000			
DCM 2	\$00000000			
3	\$00000000			
HEX 4	\$00000000			
5*	\$00000000			
FLW 6	\$00000000			
7	\$00000000			
BIT 8	\$00000000			
9	\$00000000			
=				
PROGRAM SELECT	ACTUAL POSIT.	PART PROGRAM	BLOCK DATA	SEARCH
				CHECK DATA [EXTEND]

F1 F2 F3 F4 F5 F6 F7 F8

4. Machine Diagnostic Screen

When any of the requirements for the operation of the machine is not fulfilled, it can be seen through diagnostic data displayed on the screen which condition is not fulfilled, preventing the operation. The cause of the machine trouble will be easily found out by checking the input and output signal status display with this machine diagnostic display. For the operation of displaying the machine diagnostic data, refer to SECTION 5, 2. "Machine Diagnosis Messages".

SECTION 5 MACHINE OPERATION CONDITIONS, DIAGNOSIS MESSAGES, AND LOGIC TABLES

1. Machine Operation Conditions

(1) MX-45/55VA

Item		Condition
Spindle rotation		1) Air blow adapter is not operating. 2) The MA-axis is at the operation enabled position. The TS-axis is not at the operation enabled position. 3) The tool change arm is at the retract position. 4) The internal cylinder clamp LS is ON. The internal cylinder unclamp LS is OFF. 5) The external cylinder unclamp LS is OFF. (double-cylinder specification) 6) The cylinder retract end LS is ON. 7) Spindle air blow is not operating. 8) VAC is in the ready state. 9) Through-spindle air blow is not operating. 10) Actual tool exists, spindle tool not-exist interlock is valid, and spindle tool not-exist LS is ON (spindle tool existence detection specification). 11) Chuck clamp is completed (chuck control specification). 12) Tailstock operation is completed (tailstock specification).
Spindle orientation		Same as the spindle rotation conditions.
Axis movement allowable range	All axes	1) Interlock by ATC sequence is released. 2) Interlock by APC sequence is released.
	X-axis	1) Workpiece change request is given (robot interface specification). 2) Robot is at the retract position (robot interface specification).
	Y-axis	1) The MA-axis is at the operation enabled position. The TS-axis is not at the operation enabled position. 2) The tool change arm is at the retract position. 3) Workpiece change request is given (robot interface specification). 4) Robot is at the retract position (robot interface specification).

SECTION 5 MACHINE OPERATION CONDITIONS, DIAGNOSIS MESSAGES, AND LOGIC TABLES

Item		Condition
Axis movement allowable range	Z-axis	<ol style="list-style-type: none"> 1) The MA-axis is at the operation enabled position. The TS-axis is not at the operation enabled position. 2) The tool change arm is at the retract position. 3) Workpiece change request is given (robot interface specification). 4) Robot is at the retract position (robot interface specification).
Magazine rotation		<ol style="list-style-type: none"> 1) Magazine pot is in the horizontal position. Magazine pot is not in the upright position. 2) The MA-axis is valid. The TS-axis is not valid. 3) The MA-axis drive is in the ready state.

2. Machine Diagnosis Messages

The diagnosis message display function displays the conditions required for the intended operation but not satisfied on the screen.

These messages can be displayed in the automatic, MDI, and manual modes of operation.

< Procedure >

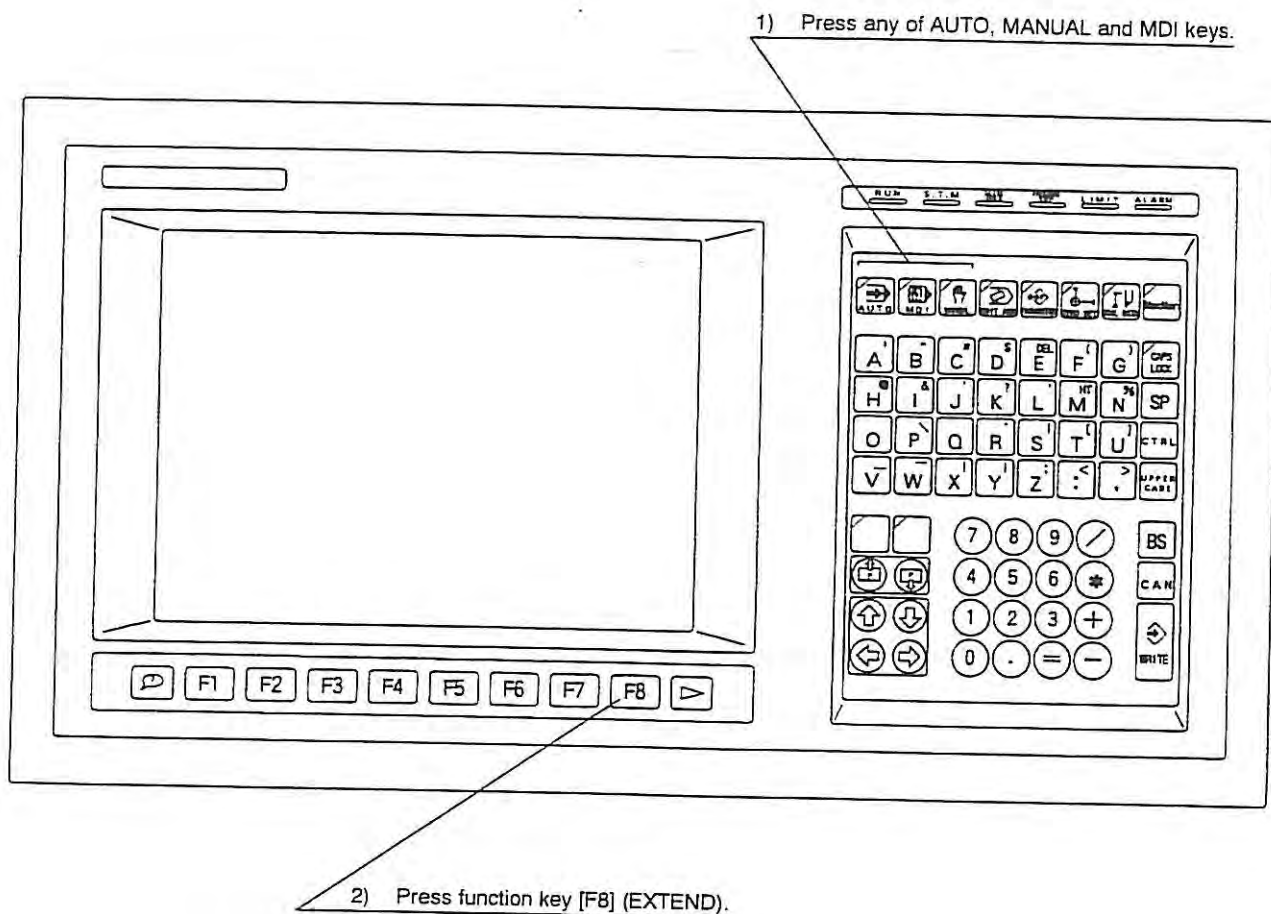

1) Press any of AUTO, MDI and MANUAL keys.

The function keys are assigned the same functions for [F2] through [F8]. Functions available with function key [F1] depends on the mode selected:

=CH							
=							
PROGRAM SELECT	ACTUAL POSIT.	PART PROGRAM	BLOCK DATA	SEARCH		CHECK DATA	[EXTEND]
F1	F2	F3	F4	F5	F6	F7	F8

AUTO : PROGRAM SELECT
 MDI : DATA INPUT
 MANUAL: None

SECTION 5 MACHINE OPERATION CONDITIONS, DIAGNOSIS MESSAGES, AND LOGIC TABLES

- 2) Press function key [F8] (EXTEND).

This changes function key guide messages.

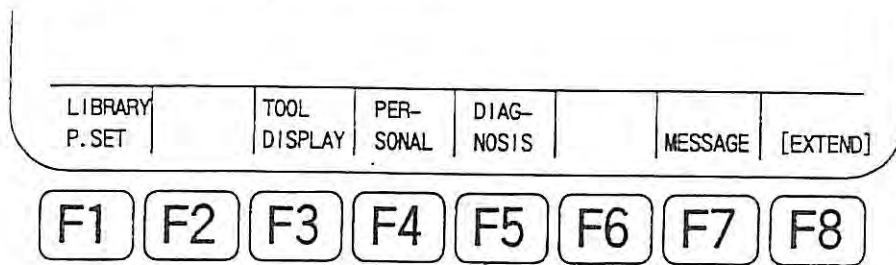

- 3) Press function key [F5] (DIAGNOSIS).

- 3) Press function key [F5] (DIAGNOSIS).

The diagnose messages will be displayed on the screen.

The messages displayed are indicated on the following pages.

(1) MX-45VA/45VB/55VA/55VB

Machine Diagnosis Messages

- 15101 Operation door INTERLOCK ON.
 This message is displayed when the operator's door close confirmation LS is turned OFF.
 If this alarm occurs, it stops the ATC and the APC and disables the starting of the CNC.
- 15102 Spindle tool outer cylinder UNCLAMP LS is not ON.
 During ATC operation, the external cylinder unclamp LS is OFF at the timing the external cylinder unclamp LS should go ON.
- 15103 Spindle tool UNCLAMP LS is not ON.
 During ATC operation, the unclamp LS is OFF at the timing the external cylinder unclamp LS should go ON.
- 15104 Spindle tool CLAMP LS is not ON.
 During ATC operation, the unclamp LS is OFF at the timing the external cylinder unclamp LS should go ON.
- 15105 Magazine pot DOWNWARD LS is not ON.
 During ATC operation, the magazine pot downward LS is OFF at the timing the magazine pot turns downward.
- 15106 Spindle tool UNCLAMP LS is not OFF (out side cylinder).
 During ATC operation, the external cylinder unclamp LS is ON at the timing the external cylinder unclamp LS should go OFF.
- 15107 Spindle index is not completed.
 When changing tools, the spindle is not oriented to the position where tool change cycle can be executed.
- 15108 HP1 is not completed.
 When changing tools, the NC axes are not at the position where tool change cycle can be executed.
- 15109 APC door CLOSE LS is not ON.
 At the execution of an APC cycle, the splash guard door has not closed.
- 15110 APC door CLOSE LS is not OFF.
 At the execution of an APC cycle, splash guard door open operation has not been performed.
- 15111 APC door OPEN LS is not ON.
 At the execution of an APC cycle, the splash guard door has not opened.
- 15112 APC door OPEN LS is not OFF.
 At the execution of an APC cycle, splash guard door close operation has not been performed.
- 15202 Chuck close LS is not ON.
 A spindle operation command was executed in the automatic, MDI, or manual mode while the chuck close confirmation signal was OFF.

SECTION 5 MACHINE OPERATION CONDITIONS, DIAGNOSIS MESSAGES, AND LOGIC TABLES

-
- 15203 Spindle has not stopped.
The CHUCK UNCLAMP button was pressed or the chuck unclamp command (M149) was executed while the spindle was operating.
- 15301 Robot is not on STANDBY POSITION.
The robot (peripheral equipment) has not returned to the retract position.
- 15302 Tool change arm is not on STANDBY POSITION.
The tool change arm has not returned to the standby position.
- 15303 X-axis servo is not OK.
The X-axis servo drive unit ON signal is not ON in the normal state (in other than the machine lock, power save, system check, and alarm A state).
- 15304 Y-axis servo is not OK.
The Y-axis servo drive unit ON signal is not ON in the normal state (in other than the machine lock, power save, system check, and alarm A state).
- 15305 Z-axis servo is not OK.
The Z-axis servo drive unit ON signal is not ON in the normal state (in other than the machine lock, power save, system check, and alarm A state).
- 15307 A-axis servo is not OK.
The A-axis servo drive unit ON signal is not ON in the normal state (in other than the machine lock, power save, system check, and alarm A state).
- 15308 B-axis servo is not OK.
The B-axis servo drive unit ON signal is not ON in the normal state (in other than the machine lock, power save, system check, and alarm A state).
- 15309 C-axis servo is not OK.
The C-axis servo drive unit ON signal is not ON in the normal state (in other than the machine lock, power save, system check, and alarm A state).
- 15310 A-axis CLAMP LS is not ON.
The A-axis clamp confirmation LS was not ON when an A-axis rotation command was executed.
- 15311 A-axis CLAMP LS is not OFF.
The A-axis clamp confirmation LS was not OFF when an A-axis rotation command was executed.
- 15312 A-axis UNCLAMP LS is not ON.
The A-axis unclamp confirmation LS was not ON when an A-axis rotation command was executed.
- 15313 A-axis UNCLAMP LS is not OFF.
The A-axis unclamp confirmation LS was not OFF when an A-axis rotation command was executed.
- 15314 B-axis CLAMP LS is not ON.
The B-axis clamp confirmation LS was not ON when a B-axis rotation command was executed.

- 15315 B-axis CLAMP LS is not OFF.
 The B-axis clamp confirmation LS was not OFF when a B-axis rotation command was executed.
- 15316 B-axis UNCLAMP LS is not ON.
 The B-axis unclamp confirmation LS was not ON when a B-axis rotation command was executed.
- 15317 B-axis UNCLAMP LS is not OFF.
 The B-axis unclamp confirmation LS was not OFF when a B-axis rotation command was executed.
- 15318 C-axis CLAMP LS is not ON.
 The C-axis clamp confirmation LS was not ON when a C-axis rotation command was executed.
- 15319 C-axis CLAMP LS is not OFF.
 The C-axis clamp confirmation LS was not OFF when a C-axis rotation command was executed.
- 15320 C-axis UNCLAMP LS is not ON.
 The C-axis unclamp confirmation LS was not ON when a C-axis rotation command was executed.
- 15321 C-axis UNCLAMP LS is not OFF.
 The C-axis unclamp confirmation LS was not OFF when a C-axis rotation command was executed.
- 15322 Axis change: Magazine axis efficiency LS is not ON.
 At the changeover of an axis, the magazine axis valid LS which enables magazine operation is not ON.
- 15323 Axis change: Tool change arm axis efficiency LS is not ON.
 At the changeover of an axis, the tool change arm rotation valid LS which enables tool change arm operation is not ON.
- 15324 Tool change arm is not on STANDBY POSITION.
 Manual operation was attempted although the tool change arm was not in the standby position.
- 15325 ATC is not start position.
 An attempt was made to execute an ATC operation, which is permitted only at ATC step No. 1, although ATC step No. is not 1.
- 15326 ATC sequence is in axis move inhibit.
 An axis movement command was executed although the ATC operation sequence number was in the axis movement prohibition range.
- 15327 APC sequence is in axis move inhibit.
 An axis movement command was executed although the APC operation sequence number was in the axis movement prohibition range.

SECTION 5 MACHINE OPERATION CONDITIONS, DIAGNOSIS MESSAGES, AND LOGIC TABLES

- 15401 Spindle tool CLAMP LS is not ON.
During ATC operation, the clamp LS is ON at the timing the external cylinder unclamp LS should go ON.
- 15402 Spindle tool UNCLAMP LS is not OFF.
During ATC operation, the spindle tool unclamp LS is not OFF at the timing it should go OFF.
- 15403 Spindle tool UNCLAMP LS is not OFF (out side cylinder).
During ATC operation, the external cylinder unclamp LS is ON at the timing it should go OFF.
- 15404 Inside cylinder retract LS is not ON (Spindle tool clamp).
During ATC operation, the internal cylinder retraction confirmation LS is not ON at the timing it should go ON.
- 15405 Spindle tool EXIST LS is not ON.
When the spindle tool not-existing interlock specification is selected, a spindle rotation command was executed although there is no tool in the spindle.
- 15410 Air blow through-spindle is working.
An attempt was made to operate the spindle although the air blow (through-spindle) signal was output.
- 15411 Air blow adapter is working.
An attempt was made to operate the spindle although the air blow (adaptor) signal was output.
- 15412 Tool change arm is not on STANDBY POSITION.
An ATC operation was attempted in the state the tool change arm was not in the standby position.
- 15413 Spindle drive unit is not ready.
When a spindle rotation command was executed, the spindle ready signal of the spindle drive unit was not ON.
- 15418 ATC sequence is in spindle rotation inhibit.
An attempt was made to operate the spindle although the tool change arm was not in the standby position.
- 15422 Tool change is in cycle.
This message indicates that an ATC cycle is executed.
- 15424 Spindle tool EXIST LS is not OFF.
When the spindle tool not-existing interlock specification is selected, the spindle tool exist LS is ON although there is no actual tool.
- 15501 Coolant motor is not ON.
The coolant motor ON confirmation signal is not ON although the coolant motor is operating.
- 15502 Through-the-tool coolant motor is not ON.
The oil-hole coolant motor ON confirmation signal is not ON although the oil-hole coolant motor is operating.

- 15503 Work shower motor is not ON.
The workpiece shower coolant motor ON confirmation signal is not ON although the workpiece shower coolant motor is operating.
- 15504 External M command answer back is not ON.
When an external M command was executed, the external M command completion signal did not go ON.
- 15505 External M command answer back is not OFF.
When an external M command was executed, the external M command completion signal remained ON and it did not go OFF.
- 15601 Spindle has not stopped.
A tool change command (M06) was executed while the spindle was rotating although the machine is not equipped with the ATC.
- 15602 HP1 is not completed.
Numerically controlled axes have not moved to the ATC home position when a tool change cycle was going to be executed.
- 15603 Spindle tool outer cylinder UNCLAMP LS is not ON.
When changing a tool manually, the external cylinder unclamp LS remained OFF in the timing it should go ON.
- 15604 Spindle tool CLAMP LS is not ON.
When changing a tool manually, the spindle clamp LS remained OFF in the timing it should go ON.
- 15605 Spindle tool CLAMP LS is not OFF.
When changing a tool, the spindle tool clamp LS remained ON.
- 15606 Spindle tool UNCLAMP LS is not ON.
When changing a tool, the spindle unclamp LS remained OFF in the timing it should go ON.
- 15607 Spindle tool UNCLAMP LS is not OFF (out side cylinder).
When changing a tool manually, the external cylinder unclamp LS remained ON in the timing it should go OFF.
- 15608 Spindle tool UNCLAMP LS is not OFF.
When changing a tool, the spindle tool unclamp LS remained ON.
- 15701 Magazine pot DOWNWARD LS is not ON.
During ATC operation, the magazine pot downward LS remained OFF in the timing the magazine pot should move downward.
- 15702 Magazine pot HORIZONTAL LS is not ON.
During ATC operation, the magazine pot horizontal-position LS remained OFF in the timing the magazine pot should move to the horizontal position.
- 15703 Spindle tool UNCLAMP LS is not OFF (out side cylinder).
During ATC operation, the external cylinder unclamp LS was ON in the timing the external cylinder unclamp LS should go OFF.

SECTION 5 MACHINE OPERATION CONDITIONS, DIAGNOSIS MESSAGES, AND LOGIC TABLES

-
- 15704 Spindle tool outer cylinder UNCLAMP LS is not ON.
During ATC operation, the external cylinder unclamp LS was OFF in the timing the external cylinder unclamp LS should go ON.
- 15705 Spindle tool CLAMP LS is not ON.
During ATC operation, the clamp LS was OFF in the timing the external cylinder unclamp LS should go ON.
- 15706 Spindle tool UNCLAMP LS is not ON.
During ATC operation, the unclamp LS was OFF in the timing the external cylinder unclamp LS should go ON.
- 15707 Inside cylinder retract LS is not ON (Spindle tool clamp).
During ATC operation, the internal cylinder retract confirmation LS was not ON in the timing it should go ON.
- 15708 Magazine manual interruption is not OFF.
An ATC related operation was attempted although the magazine manual interruption signal was ON.
- 15709 Spindle tool EXIST LS is not ON.
When the spindle tool not-existing interlock specification is selected, the spindle tool exist LS is not ON.
- 15710 Switching over to MA axis is not completed.
In the axis changeover operation from the TS-axis to the MA-axis, axis changeover to the magazine rotation has not been completed.
- 15711 Switching over to TS axis is not completed.
In the axis changeover operation from the TS-axis to the MA-axis, axis changeover to the tool change arm rotation has not been completed.
- 15712 Spindle index is not completed.
When changing tools, the spindle is not oriented to the position where tool change cycle can be executed.
- 15713 Spindle has not stopped.
During ATC operation, the spindle remains rotating (5 rpm or higher).
- 15714 Magazine index is not completed.
In ATC operation, the magazine pot has not been positioned to the normal position.
- 15715 Magazine pot is safety tool.
The pot where a dummy tool is specified in the tool/pot correspondence table was indexed.
- 15716 HP1 is not completed.
During ATC operation, any of axes is not at the tool change position.
- 15717 Exchange arm RETRACT POS. is not completed.
The tool change arm has not rotated to the retract position.
- 15718 Exchange arm GRIP POS. is not completed.
The tool change arm has not rotated to the tool gripping position.

SECTION 5 MACHINE OPERATION CONDITIONS, DIAGNOSIS MESSAGES, AND LOGIC TABLES

- 15719 Exchange arm PULL OUT POS. is not completed.
The tool change arm has not moved to the tool extract position.
- 15720 Exchange arm 180° TURN is not completed.
The tool change arm has not rotated to the 180-deg. position.
- 15721 Exchange arm MAGAZINE TOOL INSERT POS. is not completed.
The tool change arm has not rotated to the tool insert position.
- 15722 Tool change arm door OPEN LS is not OFF.
In ATC operation, the tool change arm door open confirmation LS is not ON.
- 15725 ATC is not start position.
An attempt was made to execute an ATC operation, which is permitted only at ATC step No. 1, although ATC step No. is not 1.
- 15727 Spindle tool UNEXIST LS is not OFF.
When a spindle rotation command was executed, the spindle tool not-existing confirmation LS was not OFF.
- 15728 Magazine pot HORIZONTAL LS is not OFF.
During ATC operation, the magazine pot in the horizontal position confirmation LS remained ON at the timing the magazine pot downward position confirmation LS should be ON.
- 15730 Spindle tool EXIST LS is not OFF.
When the spindle tool not-existing interlock specification is selected, the spindle tool exist LS is not OFF.
- 15731 Magazine pot DOWNWARD LS is not OFF.
In ATC operation, the magazine pot downward LS remains ON at the timing the magazine pot is in the horizontal position.
- 15732 The conditions in relation to ATC is insufficient.
There are insufficient conditions for ATC related operation.
- 15801 APC manual interruption is not OFF.
The APC MANUAL INT switch was turned ON during APC operation, or an APC operation switch on the APC operation panel was operated while the APC MANUAL INT switch was set ON.
- 15802 Work preparation completion LS is not ON.
In APC operation, workpiece has not been set up for the pallet to be loaded into the machine.
- 15803 Pallet CLAMP LS is not ON.
With the machine equipped with an NC rotary table for the B-axis, the pallet clamp LS was not ON when a B-axis rotation command was executed.
- 15804 Pallet index is not completed.
In APC operation, the pallet to be changed has not been indexed.
- 15805 APC is in safety door interlock.
During APC operation, the APC setup door close LS is OFF.

SECTION 5 MACHINE OPERATION CONDITIONS, DIAGNOSIS MESSAGES, AND LOGIC TABLES

- 15808 Shifter advance is not completed.
During APC operation, shifter advance operation has not completed.
- 15809 Shifter retract is not completed.
During APC operation, shifter retract operation has not completed.
- 15810 Shifter standby is not completed.
During APC operation, the shifter is not at the standby position.
- 15821 Pallet CLAMP LS is not OFF.
In APC operation, the pallet clamp LS remained ON in the sequence it should go OFF.
- 15822 Pallet UNCLAMP LS is not OFF.
In APC operation, the pallet unclamp LS remained ON in the sequence it should go OFF.
- 15823 Pallet UNCLAMP LS is not ON.
In APC operation, the pallet unclamp LS remained OFF in the sequence it should go ON.
- 15824 Pallet seated PS is not ON.
In APC operation, the pallet seated PS remained OFF in the sequence it should go ON.
- 15825 Pallet seated PS is not OFF.
In APC operation, the pallet seated PS remained ON in the sequence it should go OFF.
- 15826 APC door OPEN LS is not ON.
In APC operation, the pallet door open LS remained OFF in the sequence it should go ON.
- 15827 Pallet ADVANCE LS is not ON.
In APC operation, the pallet advance LS remained OFF in the sequence it should go ON.
- 15828 Pallet RETRACT LS is not ON.
In APC operation, the pallet retract LS remained OFF in the sequence it should go ON.
- 15829 Pallet UNLOADING LS is not ON.
In APC operation, the pallet unloading LS remained OFF in the sequence it should go ON.
- 15830 Pallet LOADING LS is not ON.
In APC operation, the pallet loading LS remained OFF in the sequence it should go ON.
- 15831 Pallet EXIST LS is not OFF.
In APC operation, the pallet exist LS remained ON in the sequence it should go OFF.
- 15832 Pallet EXIST LS is not ON.
In APC operation, the pallet exist LS remained OFF in the sequence it should go ON.
- 15833 HP3 is not completed.
An axis has not moved to the left pallet change position (HP3).

SECTION 5 MACHINE OPERATION CONDITIONS, DIAGNOSIS MESSAGES, AND LOGIC TABLES

- 15834 APC door CLOSE LS is not ON.
At the execution of an APC cycle, the splash guard door has not closed.
- 15835 APC door CLOSE LS is not OFF.
At the execution of an APC cycle, splash guard door open operation has not been performed.
- 15836 APC door OPEN LS is not OFF.
At the execution of an APC cycle, the splash guard door has not closed.
- 15837 APC interlock LS is not ON.
APC operation is impossible since the APC interlock LS is not ON.
- 15838 APC hydraulic fixture coupler present LS is not ON.
An attempt was made to operate the APC although the APC hydraulic fixture was mounted.
- 15845 Tool change arm is not on STANDBY POSITION.
An attempt was made to move the axes to the APC home position although the tool change arm was not at the retract position.
- 15901 Magazine pot HORIZONTAL LS is not ON.
In the state the magazine operation is disabled, the magazine pot in the horizontal position LS is OFF.
- 15902 Magazine pot DOWNWARD LS is not OFF.
In the state the magazine operation is disabled, the magazine pot in the downward position LS is OFF.
- 15903 Axis change: Magazine axis efficiency LS is not ON.
In the state the magazine operation is disabled, the magazine axis valid LS is OFF.
- 15904 Axis change: Tool change arm axis efficiency LS is not ON.
In the state the magazine operation is disabled, the tool change arm rotation axis valid LS is OFF.
- 15905 Magazine axis servo is not OK.
In the state the magazine operation is disabled, the servo is OFF.
- 15906 Magazine is in indexing cycle.
Positioning of the magazine is executed.
- 15907 Magazine is in door-interlock.
While the ATC magazine door interlock was valid, the magazine door was opened during manual magazine interruption operation.
- 15908 ATC sequence is in magazine index inhibit.
In ATC operation, magazine indexing was prohibited while a magazine pot was in the upright position.

3. ATC/APC Operation

(1) MX-45VA/45VB/55VA/55VB

① ATC

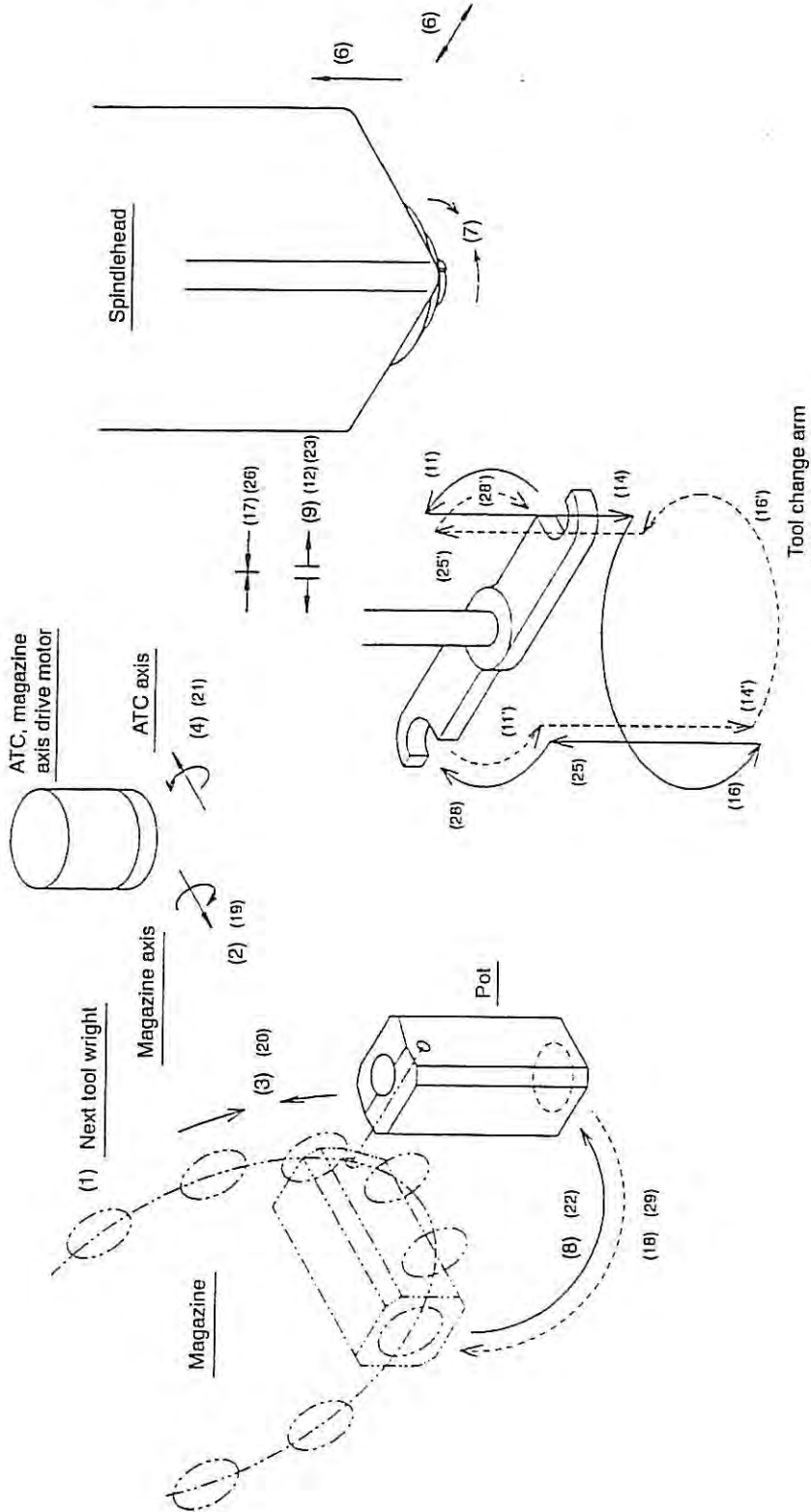

- Nos. 1 to 29 indicate the ATC operation sequence numbers.
- When changing a tool from a small diameter tool (active tool) to a small diameter tool (next tool), Nos. 17 to 24 are skipped.
- When changing tool from a small diameter tool to a large diameter tool or from a large diameter tool to a small diameter tool, the operation sequence indicated above (Nos. 1 to 29) is executed.

SECTION 5 MACHINE OPERATION CONDITIONS, DIAGNOSIS MESSAGES, AND LOGIC TABLES

Sequence number for ATC operation

Sequence No.	Operation	Sequence No.	Operation
1	Next tool write	16	Tool change arm 180° rotation
2	Axis change (TS-axis → MA-axis)	17	CONTINUE (no actual operation)
3	Magazine index	18	Tool-pot horizontal position
4	Axis change (MA-axis → TS-axis)	19	Axis change (TS-axis → MA-axis)
5	Waiting for machine completion	20	Active (return) tool magazine index
6	To the tool change stand-by position (HP1) Z- and Y-axis	21	Axis change (MA-axis → TS-axis)
7	Spindle index	22	Tool-pot vertical position
8	Tool-pot vertical position	23	Inner cylinder unclamp
9	Outer cylinder unclamp	24	CONTINUE (no actual operation)
10	CONTINUE (no actual operation)	25	Tool change arm insert position (next tool mounting)
11	Tool change arm tool grip position (tool gripping position)	26	Inner/outer cylinder clamp
12	Inner/outer cylinder unclamp	27	CONTINUE (no actual operation)
13	CONTINUE (no actual operation)	28	Tool change arm retract position
14	Tool change arm extract position (tool removal from spindle)	29	Tool-pot horizontal position
15	CONTINUE (no actual operation)		

Note: Operations 17 to 24 are for handling a large diameter tool.

SECTION 5 MACHINE OPERATION CONDITIONS, DIAGNOSIS MESSAGES, AND LOGIC TABLES

② APC

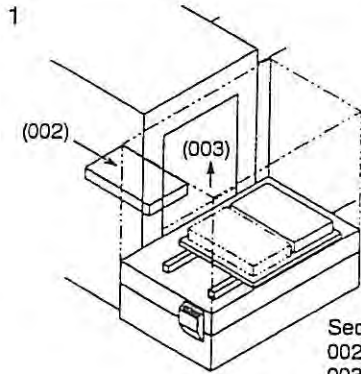

Seq. No.
002: Table slides.
003: APC door opens.

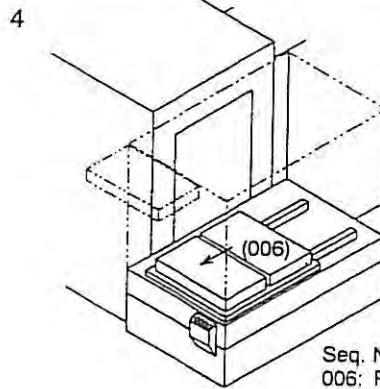

Seq. No.
006: Pallet is advanced.

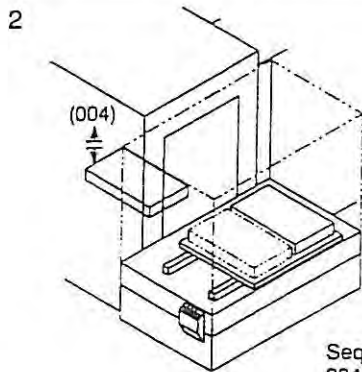

Seq. No.
004: Pallet unclamped.

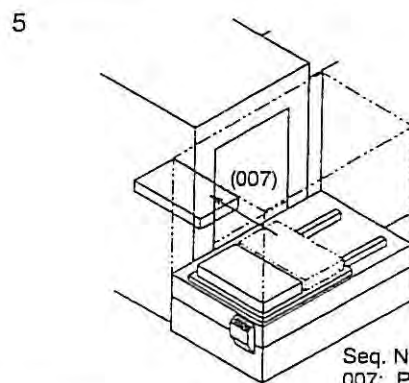

Seq. No.
007: Pallet is loaded.

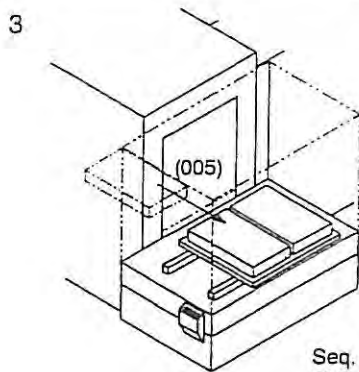

Seq. No.
005: Pallet is unloaded.

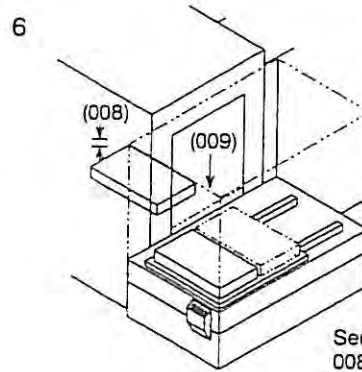

Seq. No.
008: Pallet clamped.
009: APC door closes.

4. ATC/ACP Logic Table

4-1. How to Read Logic Tables

(1) Input Logic Table

ATC (APC) operation sequence numbers are indicated at the leftmost column from the top to bottom sequentially. Input conditions corresponding to the given ATC (APC) sequence are indicated by circles.

When the automatic tool (pallet) change cycle is carried out continuously in the automatic operation mode, the sequence advances by one step when all these input conditions are met. That is, the table indicates the input conditions in the automatic mode operation.

"O/" and "/O" indicate the input conditions in the A mode and the B mode, respectively.

(2) Output Logic Table

ATC (APC) operation sequence numbers are indicated at the leftmost column from the top to bottom sequentially. Outputs given at the given ATC (APC) sequence are indicated by circles.

(3) Manual Interlock Table

ATC (APC) operation sequence numbers are indicated at the leftmost column from the top to bottom sequentially.

Interlock conditions for each ATC (APC) sequence are indicated by circles.

When the automatic tool (pallet) change cycle is carried out in the 1 step advance/reverse mode, the sequence advances or returns by one step when all these input conditions are met.

SECTION 5 MACHINE OPERATION CONDITIONS, DIAGNOSIS MESSAGES, AND LOGIC TABLES

(4) System Condition

The test below are used for checking the insufficient condition at the machine side when machine operation stops halfway or the machine fails to operate even when a command is given.

- A-TEST FUNCTION

This is the function to check whether unfulfilled conditions will exist or not. The actual input data is compared with the test at each operation step (sequence). If they match, the step will advance to the next.

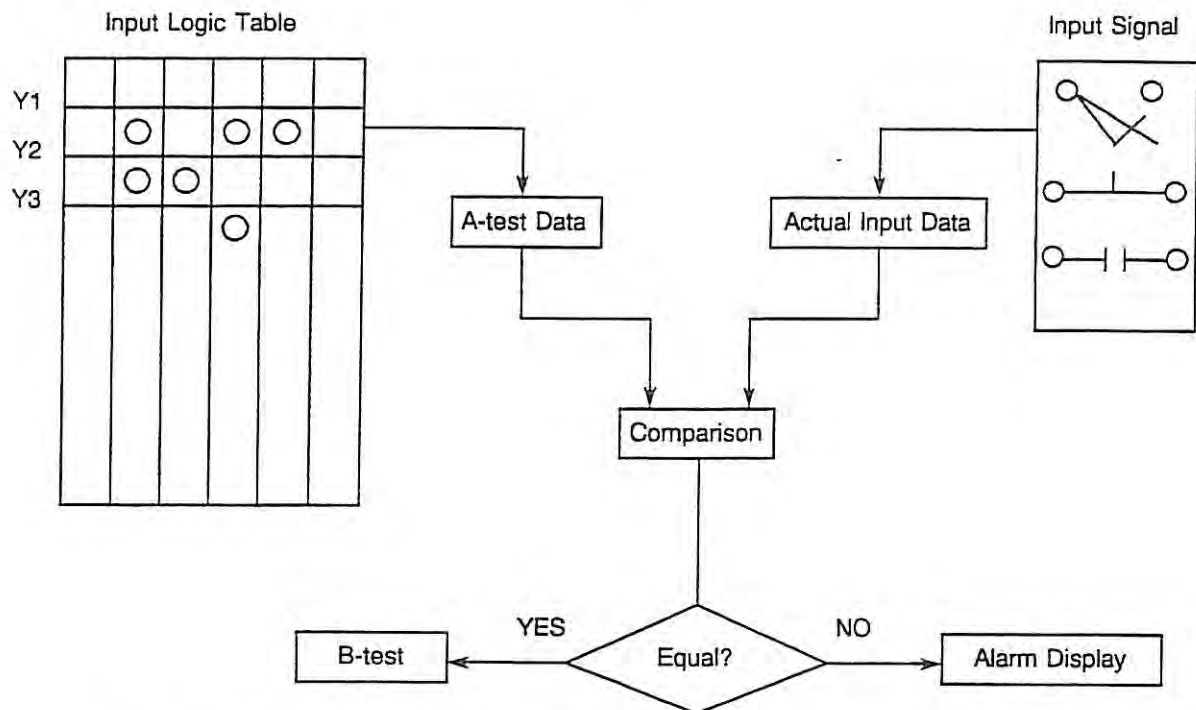

- B-TEST FUNCTION

This is the function to check whether there are unnecessary input conditions. The input conditions indicated as B-test data in the Input Logic Table are checked irrespective of the operation sequence number. That is, this interlocks ATC (APC) operation so that the sequence will not advance when operation confirmation devices such as a limit switch stays on. Note that input conditions not indicated as B-test data are not checked.

When there is a discrepancy in A- and B-tests, the alarm message indicated below is displayed on the CRT.

3705 ALARM-C ATC system condition [judgment code]

3714 ALARM-C APC system condition [judgment code]

For judgment codes, consult the ATC (APC) system condition judgment code table.

SECTION 5 MACHINE OPERATION CONDITIONS, DIAGNOSIS MESSAGES, AND LOGIC TABLES

(5) How the Operation Sequence Number Advances

At each operation sequence, input conditions are checked and when those indicated in the Input Logic Table are met, the sequence advances to the next if an ATC (APC) command is present. At the next sequence, outputs indicated in the Output Logic Table are given.

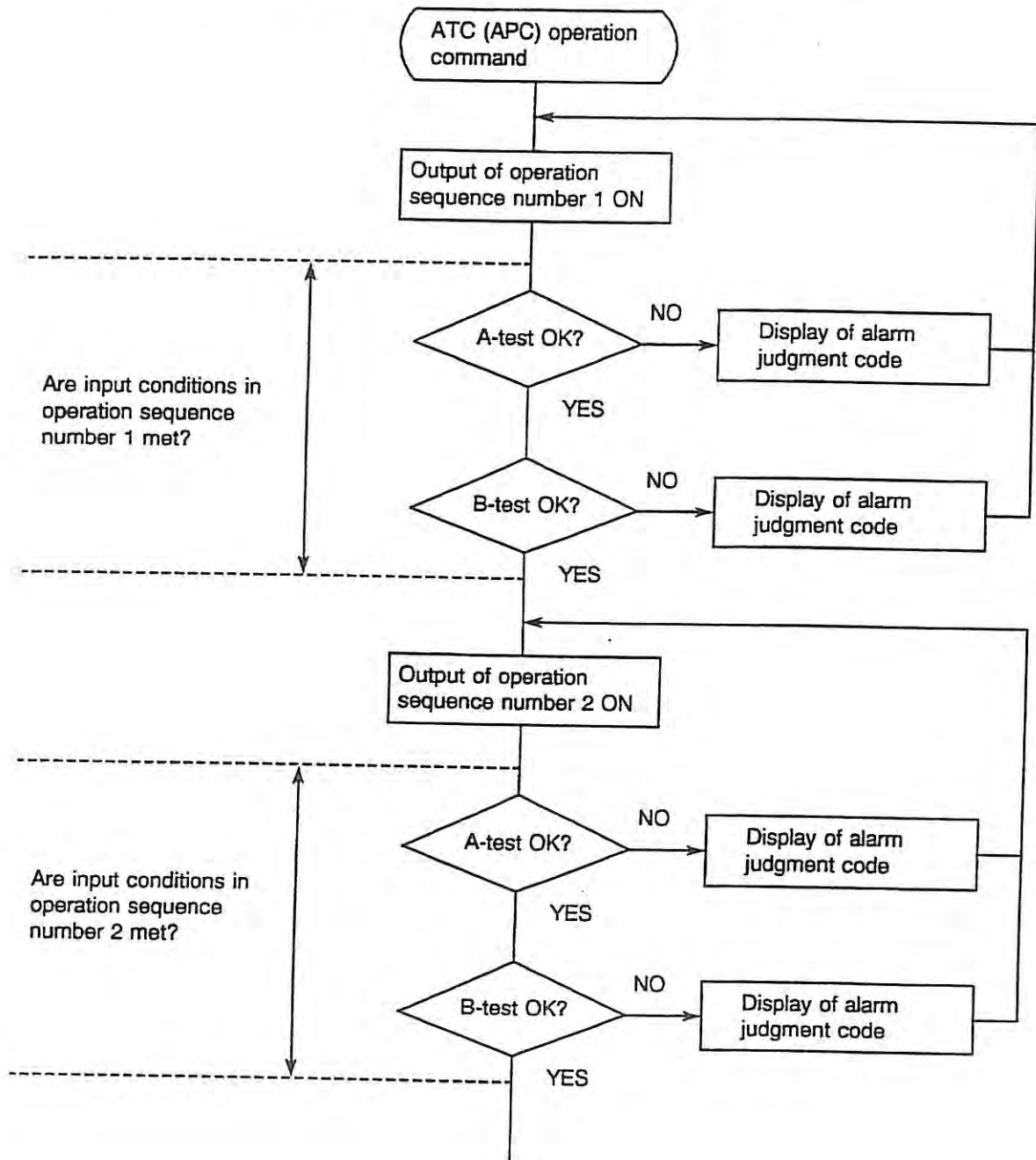

4-2. ATC Logic Table (MX-45VA/45VB/55VA/55VB)

(1) Code Table for ATC System Condition Judgment

A test

104	Magazine pot vertical position confirmation LS is not ON.
108	Magazine pot horizontal position confirmation LS is not ON.
201	Outer cylinder clamp confirmation LS is not ON.
202	Outer cylinder unclamp confirmation LS is not ON.
204	Inner cylinder clamp confirmation LS is not ON.
208	Inner cylinder unclamp confirmation LS is not ON.
210	Inner cylinder retract confirmation LS is not ON.
380	Magazine manual interruption is not OFF.
440	Spindle tool exist status does not agree.
501	Tool change arm is not at home position.
502	Tool change arm is not at the large diameter tool change cycle stop position.
540	Magazine axis switching has not completed.
580	Tool change arm axis has not completed.
701	Spindle index is not completed.
702	Spindle does not stop.
704	Not in large diameter tool change cycle (Operation step for branching 16 → 25 is not possible due to insufficient condition).
802	Magazine index is not completed.
808	Dummy tool is set at magazine pot
901	Positioning to the tool change position (HP1) is not completed.
A01	Tool change arm 180° rotation operation has not started.
C02	Tool change arm swivel to gripping position is not completed.
C04	Tool change arm unclamp confirmation position is not completed.
C08	Tool change arm positioning to extract position is not completed.
C10	Tool change arm rotation to 180° rotation completion position is not completed.
C20	Tool change arm rotation to insert position is not completed.
C40	Tool change arm rotation to clamp confirmation position is not completed.

MX-45VA/B-55VA/B ATC Logic table		Input Logic																																						
Operation sequence number	ATC Logic table																																							
	1				2				3				4				5				6																			
	80	40	20	10	08	04	02	01	80	40	20	10	08	04	02	01	80	40	20	10	08	04	02	01	80	40	20	10	08	04	02	01	80	40	20	10	08	04	02	01
1 Next tool write																																								
2 Axis change (TS⇒MA)																																								
3 Magazine index																																								
4 Axis change (MA⇒TS)																																								
5 Waiting for machine completion																																								
6 To the tool change stand-by position																																								
7 Spindle index																																								
8 Tool-pot vertical position																																								
9 Outer cylinder unclamp																																								
10 CONTINUE																																								
11 Tool change arm tool grip position																																								
12 Inner/outer cylinder unclamp																																								
13 CONTINUE																																								
14 Tool change arm extract position																																								
15 CONTINUE																																								
16 Tool change arm 180° rotation																																								
17 CONTINUE																																								
18 Tool-pot horizontal position																																								
19 Axis change (TS⇒MA)																																								
20 Active (return) tool magazine index																																								
21 Axis change (MA⇒TS)																																								
22 Tool-pot vertical position																																								
23 Inner cylinder unclamp																																								
24 CONTINUE																																								
25 Tool change arm insert position																																								
26 Inner/outer cylinder clamp																																								
27 CONTINUE																																								
28 Tool change arm retract position																																								
29 Tool-pot horizontal position																																								
B Test data																																								
Auto-Branch data																																								
5																																								
16																																								
29																																								

⇒29
⇒25
⇒1

4-3. APC Logic Table (MX-45VA/45VB/55VA/55VB)

(1) Code Table for APC System Condition Judgment

A test

101	Pallet clamp confirmation LS is not OFF.
102	Pallet unclamp confirmation LS is not OFF.
104	Pallet clamp confirmation LS is not ON.
108	Pallet unclamp confirmation LS is not ON.
110	Pallet seating confirmation pressure switch is not OFF.
120	Pallet seating confirmation pressure switch is not ON.
140	APC door open confirmation LS is not ON.
201	B pallet LOADING/UNLOADING position (pallet ADVANCE) confirmation LS is not ON.
202	A pallet LOADING/UNLOADING position (pallet RETRACT) confirmation LS is not ON.
204	Pallet UNLOADING confirmation LS is not ON.
208	Pallet LOADING confirmation LS is not ON.
301	Pallet EXIST confirmation LS is not OFF.
302	Pallet EXIST confirmation LS is not ON.
801	Work ready completion button is not pressed.
904	Positioning to pallet change position (HP3) is not completed.

B test

1201	B pallet LOADING/UNLOADING position (pallet ADVANCE) confirmation LS is not OFF.
1202	A pallet LOADING/UNLOADING position (pallet RETRACT) confirmation LS is not OFF.
204	Pallet UNLOADING confirmation LS is not OFF.
208	Pallet LOADING confirmation LS is not OFF.
1280	APC manual interruption is not OFF.

Operation Sequence Number	7			8			9			10			11			12								
	80	40	20	10	08	04	02	01	80	40	20	10	08	04	02	01	80	40	20	10	08	04	02	01
1	APC ready																							
2	Move to APC position(HP3)																							
3	APC door open																							
4	Pallet unclamp																							
5	Pallet unloading																							
6	B pallet loading/unloading position(pallet advance)																							
7	Pallet loading																							
8	Pallet clamp																							
9	APC door close																							
10	APC ready																							
11	Move to APC position(HP3)																							
12	APC door open																							
13	Pallet unclamp																							
14	Pallet unloading																							
15	A pallet loading/unloading position(pallet retract)																							
16	Pallet loading																							
17	Pallet clamp																							
18	APC door close																							
B TEST DATA																								
AUTO BRANCH DATA																								
18/APC door close ⇒ 1																								

Operation Sequence Number

Step return interlock

Step advance interlock

APC position (HP3)

Work ready completion

Operation Sequence Number	1				2				3				4				5				6				Operation Sequence Number												
	80	40	20		10	08	04	02	01	80	40	20	10	08	04	02	01	80	40	20	10	08	04	02		01	80	40	20	10	08	04	02	01			
1																																					
2																																					
3																																					
4																																					
5																																					
6																																					
7																																					
8																																					
9																																					
10																																					
11																																					
12																																					
13																																					
14																																					
15																																					
16																																					
17																																					
18																																					

MX-45VA/B-55VA/B
Pallet Type 2 - pallet.APC

Output Logic

Operation Sequence Number

1 APC ready
 2 Move to APC position(HP3)
 3 APC door open
 4 Pallet unclamp
 5 Pallet unloading
 6 B pallet loading/unloading position(pallet advance)
 7 Pallet loading
 8 Pallet clamp
 9 APC door close
 10 APC ready
 11 Move to APC position(HP3)
 12 APC door open
 13 Pallet unclamp
 14 Pallet unloading
 15 A pallet loading/unloading position(pallet retract)
 16 Pallet loading
 17 Pallet clamp
 18 APC door close

Pallet air blow SOL
 Pallet unclamp command
 Pallet clamp command
 Pallet loading command
 Pallet unloading command
 A pallet loading/unloading position command
 B pallet loading/unloading position command
 APC position <HP3>

Operation Sequence Number	7			8			9			10			11			12								
	80	40	20	10	08	04	02	01	80	40	20	10	08	04	02	01	80	40	20	10	08	04	02	01
1 APC ready																								
2 Move to APC position(HP3)																								
3 APC door open																								
4 Pallet unclamp																								
5 Pallet unloading																								
6 B pallet loading/unloading position(pallet advance)																								
7 Pallet loading																								
8 Pallet clamp																								
9 APC door close																								
10 APC ready																								
11 Move to APC position(HP3)																								
12 APC door open																								
13 Pallet unclamp																								
14 Pallet unloading																								
15 A pallet loading/unloading position(pallet retract)																								
16 Pallet loading																								
17 Pallet clamp																								
18 APC door close																								
MANUAL STEP BRANCH																								
9 APC door close																								
18 APC door close																								
MANUAL STEP BACK																								
2 Move to APC(HP3)																								
11 Move to APC(HP3)																								

Manual Interlock

Step return interlock
Step advance interlock

APC position <HP3>

Work ready completion

SECTION 6 PLC MONITOR FUNCTION

1. Outline of PLC Monitor Function

The PLC monitor function is provided to check the operation of the sequence program which controls machine operation and also to confirm the machine status at the occurrence of a trouble to locate and eliminate the cause of the trouble.

The PLC monitor functions consists of the following three functions.

- PLC data display function
- Ladder diagram monitor function
- Data trace function

2. Calling the PLC Monitor Function

The PLC monitor function is made valid by setting "1" for optional parameter (bit) No. 56, bit 6.

In an operation mode (automatic, MDI, manual), press function key [F8] ([EXTEND]) repeatedly until the "PLC monitor function menu" functions are displayed. When the "PLC monitor function menu" functions are displayed, press the function key corresponding to the required function.

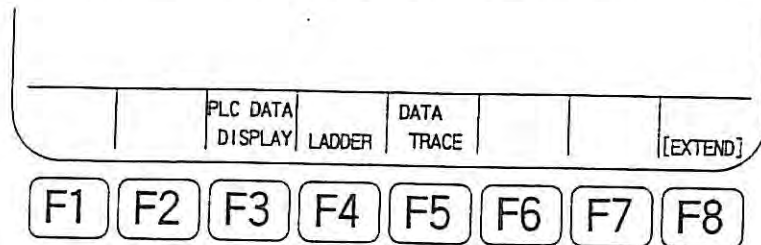

The outline of the functions is indicated below.

[F3] (PLC DATA DISPLAY)

Displays the information in the PLC data memory (input/output signals handled by the PLC and the internal memory information).

[F4] (LADDER)

Displays the ladder diagram.

[F5] (DATA TRACE)

Executes data trace.

< Function transition >

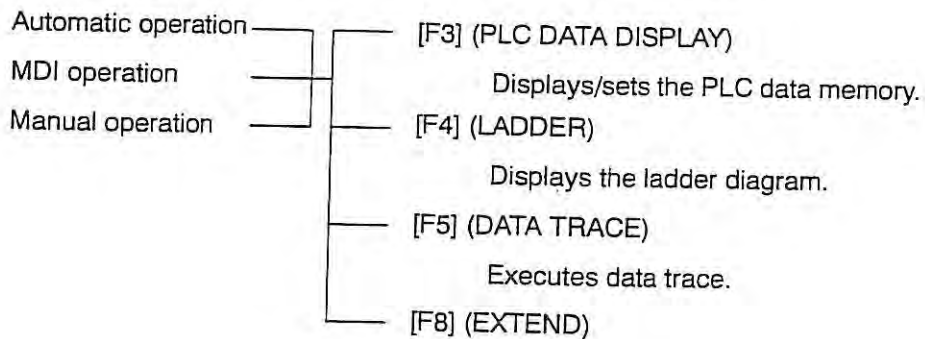







3. Function Details

The PLC monitor functions are described in details below.

3-1. PLC Data Display Function

The PLC data display function displays the contents of the data memory corresponding to the identifier.

In the comment column, the comment is displayed for the variable of the identifier address marked with an asterisk (*). Move the asterisk (*) using the cursor key ( ,  ,  , ) to the variable of the identifier address for which a comment should be displayed.

Page keys ( , ) are used to change display pages.

[Supplement] An identifier is used to distinguish an address and data type when reading/writing the PLC data memory.

(1) Outline of Identifier

The following table gives an outline of identifiers.

Type	Bit Identifier	Word Identifier	Long Word Identifier	Description
Input relay	I.	WI	LI	Reads the signals of external devices.
Output relay	O.	WO	LO	Outputs the signals to external devices.
Auxiliary relay	M.	WM	LM	Internal relay of PLC
Keep relay	K.	WK	LK	Internal relay of PLC; the state of relay is held after power OFF.
Step control relay	S.	WS		Internal relay of PLC; used for process progress sequence.
Timer	T.		TS TR	T.: Relay contact operating at time-up TS: Timer setting TR: Actual timer value T., TS, and TR operate as one set of a timer.
Counter	C.		CS CR	C.: Relay contact operating at counting-up CS: Counter setting CR: Actual counter value C., CS, and CR operate as one set of a counter.
Last differential value relay	DB			Stores the last differential value
One-word data memory		SI		Stores the internal data of PLC.
Two-word data memory			DI	Stores the internal data of PLC.
NC → PLC relay	G.	WG	LG	Reads the signal from the CNC to the PLC.
PLC → NC relay	U.	WU	LU	Outputs the signal from the PLC to the CNC.

Type	Bit Identifier	Word Identifier	Long Word Identifier	Description
NC data relay	J.	WJ	LJ	The window relay used to exchange the data between the NC and the PLC
M code configuration			MC	Stores the data for setting the M code step control relay.
Constant relay	BC	WC	LC	Internal PLC relay; read only

(2) Screen Configuration and Functions

The following explains the screen configuration and the function keys using "identifier I." as an example.

(a) PLC DATA screen example: I.

AUTO OPERATION SEIGYO.MIN OSHT1 N 0

97/07/15 14:10:00

PLC DATA DISPLAY ID=I. PAGE 1

NO.= 0 NO.= 1

DATA=0201 DATA=0110

BIT	LABEL	BIT	LABEL	BIT	LABEL	BIT	LABEL
*0	ipMNPZ	8	ipDRIL	0	<input type="checkbox"/>	8	ipPH50
1	ipMNPX	9		1	<input type="checkbox"/>	9	ipPH10
2	ipMNNZ	A	ipPNOP2	2	<input type="checkbox"/>	A	ipPH1
3	ipMNNX	B	<input checked="" type="checkbox"/> ipPNOP1	3	<input type="checkbox"/>	B	ipPHZ
4	ipSPIN	C	ipRET	4	<input type="checkbox"/>	C	ipPHX
5	ipSPCW	D	ipNCRT	5	<input type="checkbox"/>	D	
6	ipSPCC	E	ipNTS	6	<input type="checkbox"/>	E	ipDORC
7	ipSPSP	F	<input checked="" type="checkbox"/> ipNCST	7	<input type="checkbox"/>	F	ipDORO

CMNT:Jog feed Z+

=

SEARCH
QUIT [EXTEND]

F1
F2
F3
F4
F5
F6
F7
F8

(b) Function keys

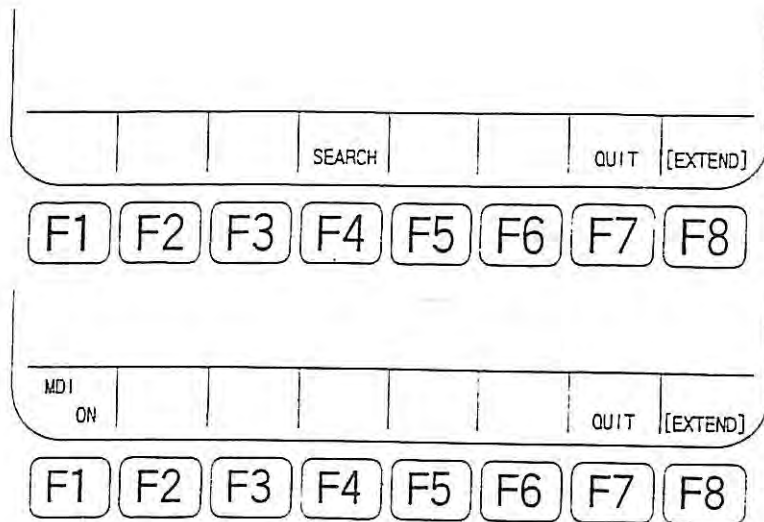

[SEARCH]

Executes search for identifiers or labels according to the input of an identifier or a label. If this function key is pressed without inputting an identifier or a label, the list of identifiers is displayed, where the input of a code number is accepted.

For details, refer to "Search function operation procedure" item below.

[MDI ON]

Allows the data input for MDI operation.

Pressing function key [MDI OFF] returns the mode to accept the input of a command.

[QUIT]



Returns the menu to the PLC monitor function menu.

(c) Search function operation procedure

- Search by inputting an identifier or a label

- 1) Press function key [F4] (SEARCH).
- 2) Key in an identifier or a label.
- 3) Press the WRITE key.

- Search using the identifier list

- 1) Press function key [F4] (SEARCH).
- 2) Press the WRITE key.
- 3) The list of identifiers is displayed (see Fig. 6-1.)
- 4) Press a page key ( : return to the previous page,  : advance to the next page).
- 5) Key in the code number of the identifier.
- 6) Press the WRITE key.

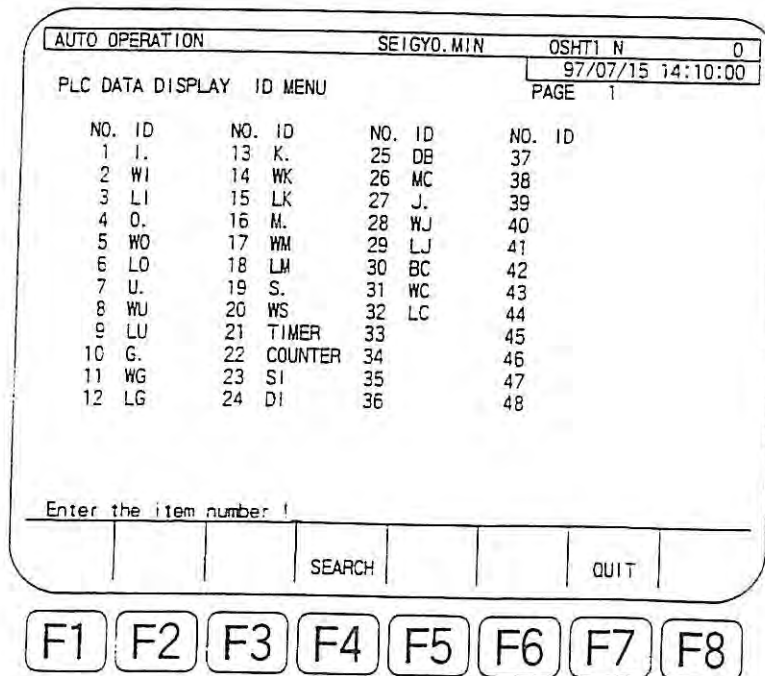

Fig. 6-1 Identifier List Screen

(3) Identifier Data Display Screen

The screens displayed by the selection of an identifier are shown below.

(a) Bit identifiers (irregular hexadecimal)

Corresponding identifiers: I., O., U., G., J., K., M., BC

AUTO OPERATION		SEIGYO.MIN		OSHT1 N		0	
PLC DATA DISPLAY ID=1.				97/07/15 14:10:00			
NO. = 0		NO. = 1		PAGE 1			
DATA=0201		DATA=0110					
BIT	LABEL	BIT	LABEL	BIT	LABEL	BIT	LABEL
*0		8		0		8	
1		9		1		9	
2		A		2		A	
3		B		3		B	
4		C		4		C	
5		D		5		D	
6		E		6		E	
7		F		7		F	
CMNT: #							
>							
		SEARCH				QUIT	



Labels are displayed corresponding to bits as the guide and the label is highlighted if the corresponding bit is "ON" or "1".

NO. =: Word address (3-digit decimal)

DATA =: Hexadecimal display (4 digits)

(b) Bit identifiers (decimal)

Corresponding identifiers: DB

AUTO OPERATION		SEIGYO.MIN	OSHT1 N	0
PLC DATA DISPLAY		ID=DB	97/07/15 14:10:00	
			PAGE	1

NO.	LABEL	NO.	LABEL
*0000	#####	0010	#####
0001	#####	0011	#####
0002	#####	0012	#####
0003	#####	0013	#####
0004	#####	0014	#####
0005	#####	0015	#####
0006	#####	0016	#####
0007	#####	0017	#####
0008	#####	0018	#####
0009	#####	0019	#####

CMNT: #####

>

		SEARCH		QUIT
--	--	--------	--	------

F1	F2	F3	F4	F5	F6	F7	F8
----	----	----	----	----	----	----	----

Labels are displayed corresponding to bits as the guide and the label is highlighted if the corresponding bit is "ON" or "1".

NO. =: Relay number (4-digit decimal)

(c) Step control relay (bit) identifiers

Corresponding identifiers: S.

AUTO OPERATION SEIGYO.MIN OSHT1 N 0

PLC DATA DISPLAY ID=S. 97/07/15 14:10:00
PAGE 1

GNO. = 0

SNO.	LABEL	LABEL	LABEL	LABEL	LABEL
00-04	#####	#####	#####	#####	#####
05-09	#####	#####	#####	#####	#####
10-14	#####	#####	#####	#####	#####
15-19	#####	#####	#####	#####	#####
20-24	#####	#####	#####	#####	#####
25-29	#####	#####	#####	#####	#####
30-34	#####	#####	#####	#####	#####
35-39	#####	#####	#####	#####	#####
40-44	#####	#####	#####	#####	#####
45-49	#####	#####	#####	#####	#####

CMNT: #####

>

SEARCH QUIT

F1 F2 F3 F4 F5 F6 F7 F8

GNO. =: Group number 00 to 99 (2-digit decimal)

SNO. =: Step number 00 to 99 (2-digit decimal)

In step control relay memory, data is stored in decimal word data, which is converted into bits ("1" if the data agrees with SNO., and "0" if it does not agree with SNO.) to be displayed.

(d) Word identifiers

Corresponding identifiers: WI, WO, WU, WG, WJ, WK, WM, SI, WS, WC

AUTO OPERATION		SEIGYO.MIN		OSHTI N		0	
PLC DATA DISPLAY		ID=W1		PAGE		1	
				97/07/15 14:10:00			
NO.	LABEL	DATA	NO.	LABEL	DATA		
*ddd	#####	-ddd=xxxxH	ddd	#####	-ddd=xxxxH		
ddd	#####	-ddd=xxxxH	ddd	#####	-ddd=xxxxH		
ddd	#####	-ddd=xxxxH	ddd	#####	-ddd=xxxxH		
ddd	#####	-ddd=xxxxH	ddd	#####	-ddd=xxxxH		
ddd	#####	-ddd=xxxxH	ddd	#####	-ddd=xxxxH		
ddd	#####	-ddd=xxxxH	ddd	#####	-ddd=xxxxH		
ddd	#####	-ddd=xxxxH	ddd	#####	-ddd=xxxxH		
ddd	#####	-ddd=xxxxH	ddd	#####	-ddd=xxxxH		
ddd	#####	-ddd=xxxxH	ddd	#####	-ddd=xxxxH		
ddd	#####	-ddd=xxxxH	ddd	#####	-ddd=xxxxH		
ddd	#####	-ddd=xxxxH	ddd	#####	-ddd=xxxxH		
ddd	#####	-ddd=xxxxH	ddd	#####	-ddd=xxxxH		
ddd	#####	-ddd=xxxxH	ddd	#####	-ddd=xxxxH		
CMNT: #####							
=							
				SEARCH		QUIT	

F1 F2 F3 F4 F5 F6 F7 F8

- NO. =: Word address (4-digit decimal)
Displayed in the ascending order
- DATA: Decimal (6 digits)
- =: Hexadecimal (4 digits)

(e) Long word identifiers

Corresponding identifiers: LI, LO, LU, LG, LJ, LK, LM, DI, MC, LC

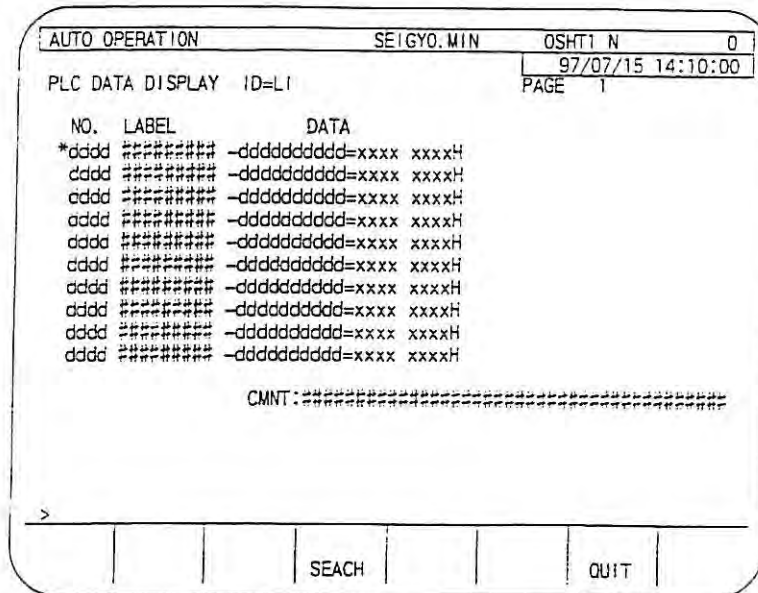

- NO. =: Word address (4-digit decimal)
Displayed in the ascending order
- DATA: Decimal (11 digits)
- = : Hexadecimal (8 digits)

(f) Timer identifiers

AUTO OPERATION		SEIGYO. MIN	OSHT1 N	0	
PLC DATA DISPLAY ID=TIMER		97/07/15 14:10:00			
		PAGE 1			
NO.	ID LABEL	ID LABEL	DATA		
dddd	*T. #####	TR #####	-ddddddddd=xxxx xxxxH		
		TS #####	-ddddddddd=xxxx xxxxH		
cccc	T. #####	TR #####	-ddddddddd=xxxx xxxxH		
		TS #####	-ddddddddd=xxxx xxxxH		
dddd	T. #####	TR #####	-ddddddddd=xxxx xxxxH		
		TS #####	-ddddddddd=xxxx xxxxH		
dddd	T. #####	TR #####	-ddddddddd=xxxx xxxxH		
		TS #####	-ddddddddd=xxxx xxxxH		
dddd	T. #####	TR #####	-ddddddddd=xxxx xxxxH		
		TS #####	-ddddddddd=xxxx xxxxH		
CMNT: #####					
>					
		SEARCH	QUIT		

F1 F2 F3 F4 F5 F6 F7 F8

- NO. =: Word address (4-digit decimal)
 Displayed in the ascending order
- TR, TS DATA: Decimal (11 digits)
 =: Hexadecimal (8 digits)

(g) Counter identifiers

AUTO OPERATION		SEIGYD.MIN	OSHT1 N	0
PLC DATA DISPLAY ID=COUNTER		97/07/15 14:10:00		
		PAGE 1		
NO.	ID LABEL	ID LABEL	DATA	
dddd	*C. #####	CR #####	-ddddddddd=xxxx xxxxH	
		CS #####	-ddddddddd=xxxx xxxxH	
dddd	C. #####	CR #####	-ddddddddd=xxxx xxxxH	
		CS #####	-ddddddddd=xxxx xxxxH	
dddd	C. #####	CR #####	-ddddddddd=xxxx xxxxH	
		CS #####	-ddddddddd=xxxx xxxxH	
dddd	C. #####	CR #####	-ddddddddd=xxxx xxxxH	
		CS #####	-ddddddddd=xxxx xxxxH	
dddd	C. #####	CR #####	-ddddddddd=xxxx xxxxH	
		CS #####	-ddddddddd=xxxx xxxxH	
CMNT: #####				
>				
		SEARCH		
		QUIT		

F1
F2
F3
F4
F5
F6
F7
F8

- NO. =: Word address (4-digit decimal)
 Displayed in the ascending order
- CR, CS DATA: Decimal (11 digits)
 =: Hexadecimal (8 digits)

3-2. Ladder Diagram Monitor Function

The ladder diagram monitor function displays a sequence program in the form of ladder.

(a) Ladder diagram monitor screen

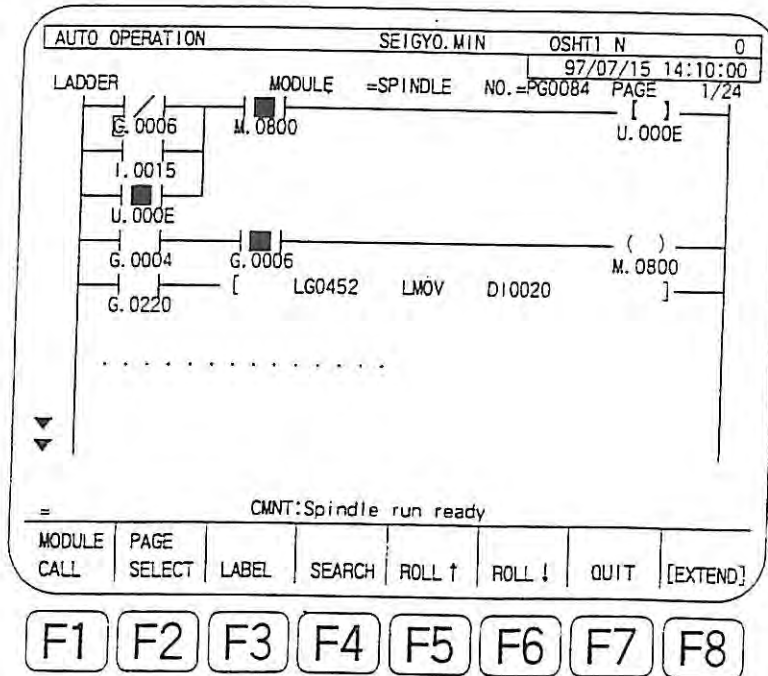

Display items

- Program name display

MODULE =: Displays a program name in maximum of 8 characters.

NO =: Displays the type of program and program number

The output format is "YY9999".

YY: Program type (2 characters)

PG Program module

FM Function module

9999: Program number (0000 to 9999)

- Page display

PAGE: Displays the relative page and the total number of pages in a module.

999/999

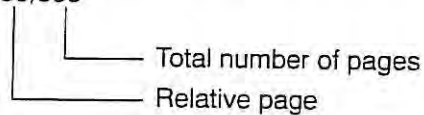

(b) Function 1

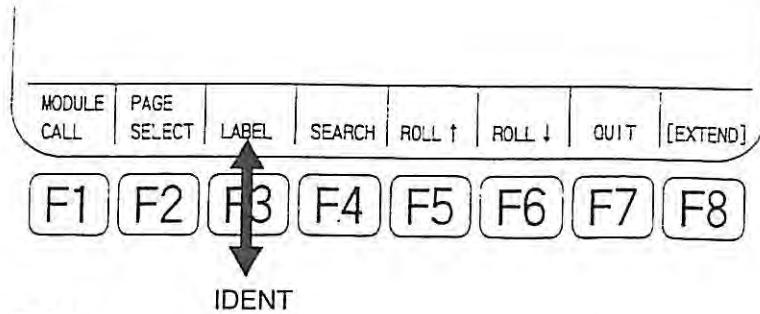

[MODULE CALL]

Selects a program by specifying a program number or a program name.

If this function key is pressed without keying in a program number or a program name, the list of stored programs is displayed, allowing the selection of a program by moving the cursor to the program to be called.

< Procedure >

Program selection by specifying a program number

- 1) Press function key [F1] (MODULE CALL).
- 2) Select either PGO or FMO.
PGO Input "PG".
FMO Input "FM".
- 3) Input the program number.
- 4) Press the WRITE key.

[Supplement] Input a 4-digit number as a program number. In this input, leading zeros may be omitted (PG0001 = PG1).

Input the program type ("PG" or "FM") and a program number continuously without placing a space between them.

The maximum number of characters used to specify a program type is two and that for specifying a program number is four. The total number of characters that can be input for specifying the program to be called is six.

Program selection by specifying a program name

- 1) Press function key [F1] (MODULE CALL).
- 2) Input a program name (max. 8 characters).
- 3) Press the WRITE key.

[Supplement] Wild cards cannot be used in a program name.

If the same name exists in the program module and the function module, selection is made in the program module and it is not possible to call a program in the function module. To call a program in the function module, therefore, this method cannot be used.

Program selection using the list of programs

- 1) Press function key [F1] (MODULE CALL).
- 2) Select either PGO or FMO.
PGO Input "PG".
FMO Input "FM".
- 3) Press the WRITE key.

If the WRITE key is pressed skipping step (2) above, the following message is displayed.

> Select PGO or FMO (P/F)!

Select either PGO or FMO.

PGO Input "PG".

FMO Input "FM".

- 4) Press the WRITE key.

The list of programs is displayed (Fig. 6-2).

Page keys are used to change the display pages.

 : Return to the previous page.

 : Advance to the next page.

- 5) Move the cursor to the program to be selected.
- 6) Press the WRITE key.

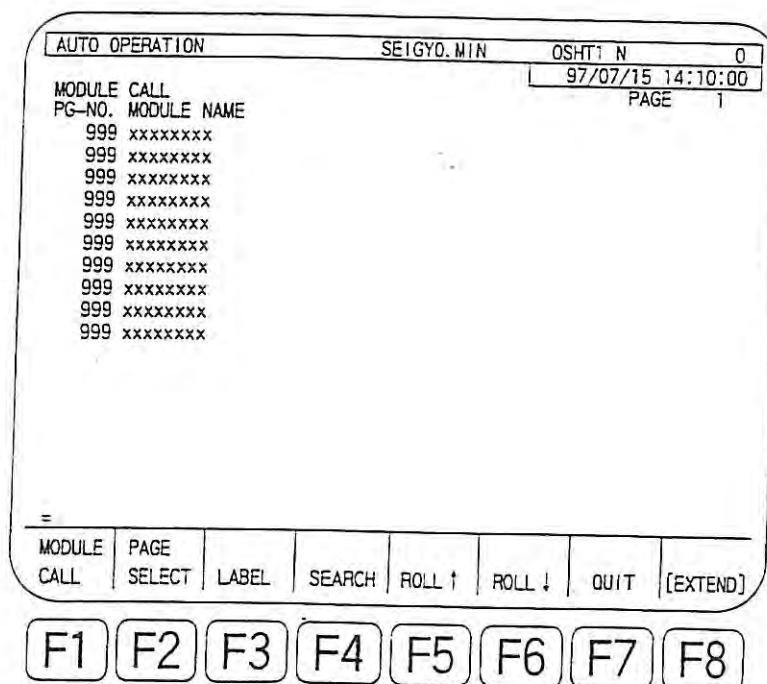

Fig. 6-2

[PAGE SELECT]



Searches and displays the specified page.

< Procedure >



- 1) Press function key [F2] (PAGE SELECT).
- 2) Input the required page number.
Only a positive integer is accepted and symbols such as a sign are not allowed.
- 3) Press the WRITE key.
The specified page is displayed (relative page number).

- [Supplement]
1. If the specified page number is larger than the total number of pages of the programs to be displayed, the last page is displayed.
 2. If the page number is omitted or "0" is input for a page number, the first page is displayed.

Page keys:

-  : Return to the previous page.
-  : Advance to the next page.

If a page key is pressed at the first or the last page, the page is changed in the manner shown below.

- Page advance () key pressed in the last page The first page is displayed.
- Page return () key pressed in the first page The last page is displayed.

[IDENT/LABEL]

Selects the objective of label display from identifier and label.

If a label is not stored although label display is selected, an identifier is displayed (Figs. 6-3, 6-4).

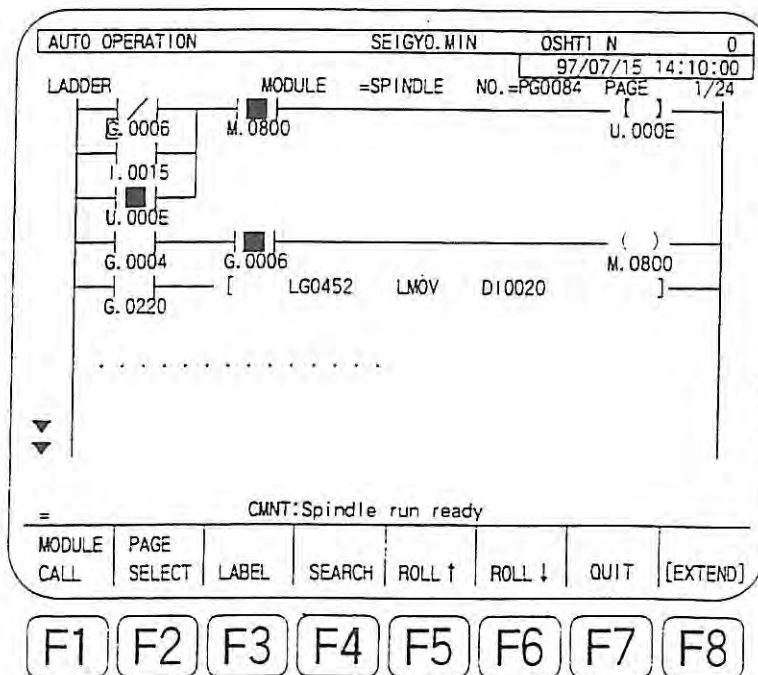

Fig. 6-3 Screen Displaying Identifiers

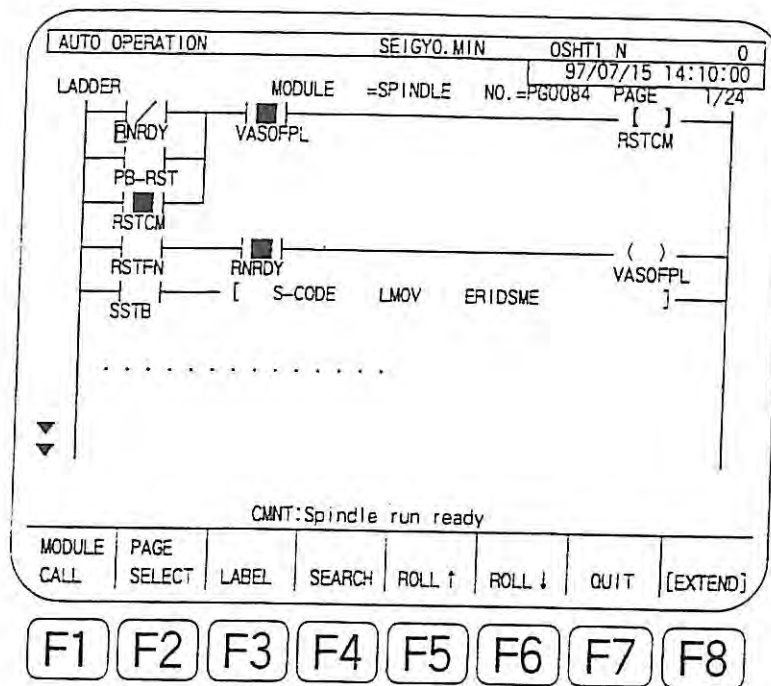

Fig. 6-4 Screen Displaying Labels

[SEARCH]

Searches for the specified identifier or label in the ladder diagram.

< Procedure >

- 1) Press function key [F4] (SEARCH).
- 2) Input an identifier or a label.
If necessary, input an option continuously.
- 3) Press the WRITE key.

The circuit block found first is displayed at the middle in the screen with the cursor on it.

[Supplement] When specifying an identifier, zeros in the higher-digit address can be omitted. I.000F = I.0F

When specifying a label, it is not allowed to use a wild card.

Following option designation is possible. Designation of more than options is allowed. The delimiter used between the data and the option is a semicolon “;” and a space must not be entered between the data and the delimiter. If more than one option should be specified, enter a space between options or specify them continuously.

Example: xxx;R A

xxxx;RA

- Option ;R

Search only for contacts.

(default: search for both contacts and coils)

- Option ;W
Search only for coils.
- Option ;A
Search in all programs
 - 1) In the ascending order of program numbers
 - 2) In the ascending order of page numbers
 - 3) In the ascending order of step numbers
- Option ;P
Search in the specified program (default)
- Option ;C
Search for cursor symbol
(If search option for a symbol is specified at the same time, option ;C is given priority.)

(c) Search menu

- 1) If you press the WRITE key without inputting anything after pressing the function key, the interactive input mode is set and a message is displayed in the console line. At the same time, search menu items for option designation are displayed at the function keys.
 - > Input the search symbol!

- 2) Pressing the WRITE key after inputting an identifier or a label, the search target symbol is established.

If the WRITE key is pressed without inputting anything, the following message is displayed.

> Search for the symbol's cursor position (Y/N)!

"Y" + [WRITE]: The identifier or label at the cursor position is established as the search target symbol.

"N" + [WRITE]: The screen returns to the input step for an identifier or a label.

If there is no symbol at the cursor position, the following message is displayed.

> Symbol not at cursor position. Press WRITE key!

If you press the WRITE key, search is stopped.

While the search target symbol is not established, only function key [F7] (QUIT) is accepted and other keys are not operative.

- 3) When the search target symbol is established, the following message is displayed.

> **** will be searched. Specify the options.

└── Identifier or label

To specify an option, press the function keys corresponding to the required options. The message changes according to the designated options.

If the function key of the designated option is pressed again, option designation is canceled.

> **** ;??? will be searched. Specify the options.

└── Option
└── Identifier or label

- Search menu function

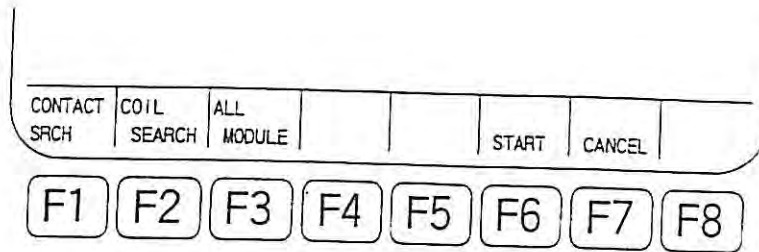

[F1] (CONTACT SRCH)

Search only for contacts.

[F2] (COIL SEARCH)

Search only for coils.

[F3] (ALL MODULE)

Search in all programs.

4) Press function key [F6] (START) to start search.

The circuit block found first is displayed at the middle in the screen with the cursor on it.

If more than one circuit blocks are found, the first one is displayed in the screen and then the following message is displayed.

> Continue searching (Y/N)!

"Y" + [WRITE]: The next circuit block is displayed.

"N" + [WRITE]: Search is canceled. Menu returns from the search menu to the function menu.

If you press function key [F7] (CANCEL), the following message is displayed.

> Cancel searching (Y/N)!

"Y" + [WRITE]: Search is canceled. Menu returns from the search menu to the function menu.

"N" + [WRITE]: Search is continued.

[ROLL ↑]: Returns the display position within the displayed page.

[ROLL ↓]: Advances the display position within the displayed page.

[Supplement] [ROLL ↑] and [ROLL ↓]

1) If "comment OFF", display position moves by 8 elements (16 lines) at a time.

2) If "comment ON", display position moves by 4 elements (16 lines) at a time.

If a circuit block is continuous in two or more lines, the symbols shown below are displayed at the left end of the circuit block.

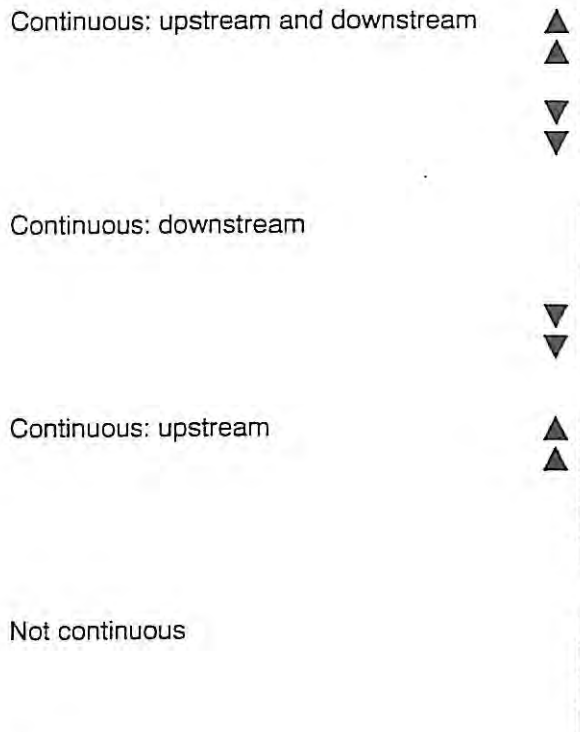

[QUIT]

Returns the menu to the PLC monitor function menu.

[EXTEND]

Calls function 2.

(d) Function 2

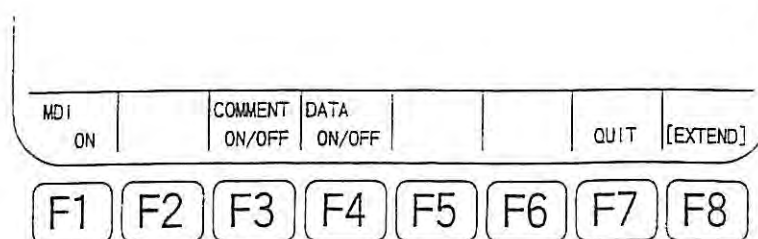

[MDI ON]

Allows the data input for MDI operation.

Pressing [MDI OFF] key returns the mode to accept the input of a command.

[COMMENT ON/OFF]

Selects whether or not a comment is displayed below symbols. For a comment, the first 16 characters are displayed.

(Figs. 6-5, 6-6)

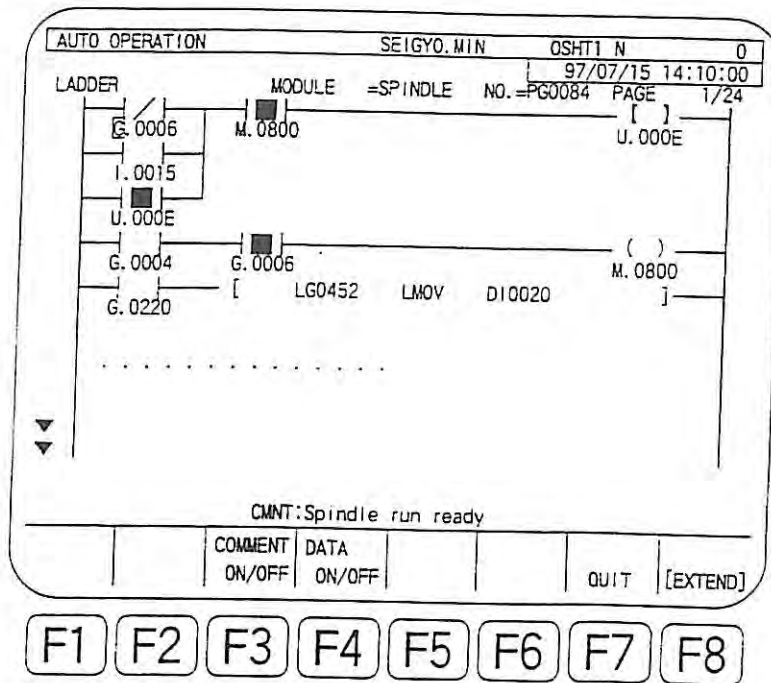

Fig. 6-5 Display with Comment OFF Setting

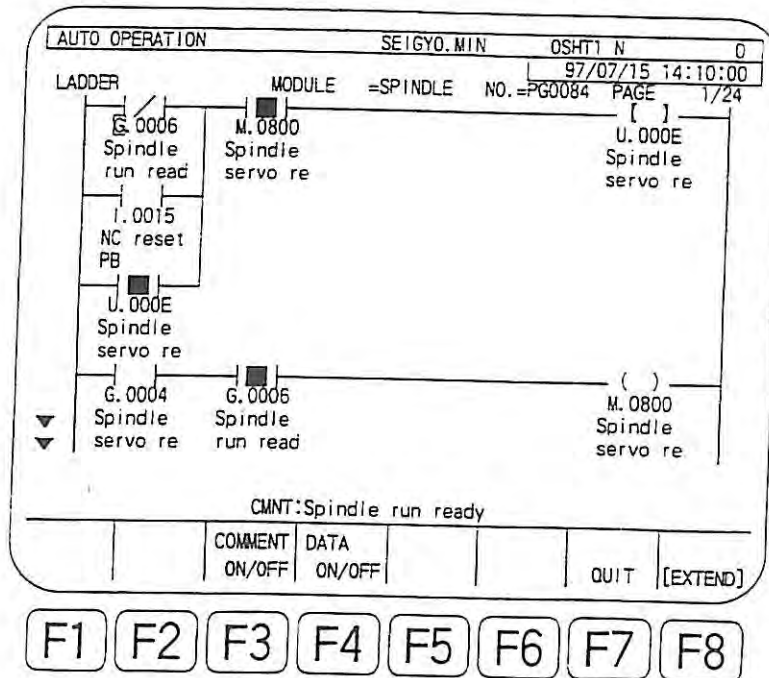

Fig. 6-6 Display with Comment ON Setting

[DATA ON/OFF]

Selects whether identifier/label should be displayed or contents of data memory of identifier should be displayed.

[QUIT]

Returns the menu to the PLC monitor function menu.

[EXTEND]

Calls function 1.

3-3. Data Trace Function

The data trace function collects the data specified by an identifier or a label in predetermined cycles to the buffer and displays it.

When the data trace function is started, the trace condition setting screen is displayed first.

Press function key [F5] (TRACE SCREEN) and the trace execution/8-kind data display screen is displayed.

In the second and later start-up of the data trace function, the function starts from last screen.

(a) Trace condition setting screen

AUTO OPERATION		SEIGYO.MIN	OSHT1 N	0
DATA TRACE		97/07/15 14:10:00		
SAMPLING CYCLE	###(a)###	msec	POWER ON TRACE	###(b)###
TRIGGER SIGNAL	###(c)###		TRIGGER COND(d)	###(e)###
BEFORE TRIGGER	###(f)###		AFTER TRIGGER	###(g)###
TRACE DATA CODE				
No. 1	#####	#####		
No. 2	#####	#####		
No. 3	#####	#####		
No. 4	###(h)###	(i)###		
No. 5	#####	#####		
No. 6	#####	#####		
No. 7	#####	#####		
No. 8	#####	#####		
MENU OF SETTING DATA				
=				
SET	LABEL	TRACE SCREEN	QUIT	

F1 F2 F3 F4 F5 F6 F7 F8

(b) Functions

[SET]

Sets the input data at the cursor position.

Data setting menu changes according to the item to be set.

[IDENT/LABEL]

Selects the objective of label display from identifier and label.

If a label is not stored although label display is selected, an identifier is displayed.





[TRACE SCREEN]

Changes the screen to the trace execution screen.

[QUIT]

Returns the menu to the PLC monitor function menu.

< Setting items >

Move the cursor to the data setting item using the cursor keys ( ,  ,  , ).

- SAMPLING CYCLE (a)

Set the sampling interval.

CYCLE	0 :	6.4 msec
	1 :	25.6 msec
	2 :	102.4 msec
	3 :	204.8 msec
	4 :	512.0 msec
	5 :	TS TASK 0
	6 :	TS TASK 1

Fig. 6-7 Sampling Interval Setting Data Menu

The list of data to be set is displayed.

After pressing function key [F1] (SET), input the number to be selected and press the WRITE key.

Selection is possible from the following seven items.

Values in [] are set.

- 0: 6.4 msec (Default)
- 1: 25.6 msec
- 2: 102.4 msec
- 3: 204.8 msec
- 4: 512.0 msec
- 5: TS TASK 0
- 6: TS TASK 1

- POWER ON TRACE (b)

Set whether or not data trace is executed at turning on the power.

POWER ON TRACE	0 :	NO DATA TRACE
	1 :	DATA TRACE

Fig. 6-8 Power ON Data Trace Setting Data Menu

The list of data which can be set is displayed.

After pressing function key [F1] (SET), input the number heading the data to be selected and press the WRITE key.

Selection is possible from the following two items.

Values in [] are set.

0: NO DATA TRACE

1: DATA TRACE

- TRIGGER SIGNAL (c)



Set the identifier used as the trigger for starting sampling.

Default is "blank" (not set) and trigger condition is invalid.

IDENTIFIER	WI	BIT INPUT
	I.	BIT INPUT
	LI	BIT INPUT
	WM	AUXILIARY RELAY
	M	AUXILIARY RELAY
	LM	AUXILIARY RELAY
	WK	KEEP RELAY
	K.	KEEP RELAY
	LK	KEEP RELAY
	T.	TIMER RELAY

Fig. 6-9 Trigger Signal Setting Data Menu

The list of identifiers which can be set is displayed.

Page keys ( , ) are used to change the display page of the list.

After pressing function key [F1] (SET), input an identifier and press the WRITE key. The input identifier is set.

- TRIGGER COND (d)

Set the sampling trigger condition.

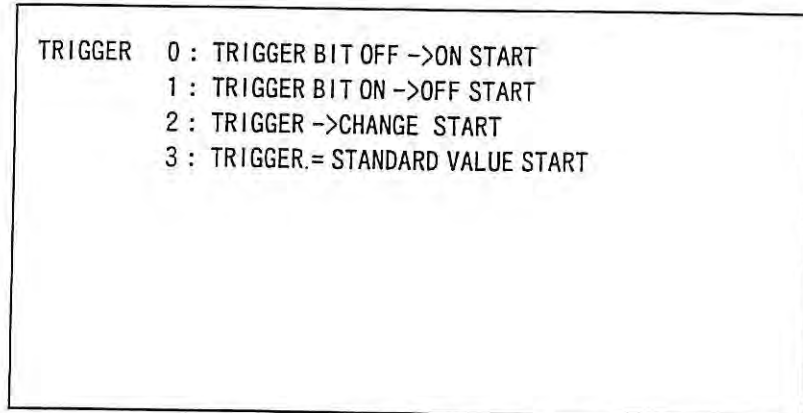

Fig. 6-10 Trigger Condition Setting Data Menu

The list of data to be set is displayed.

After pressing function key [F1] (SET), input the number to be selected and press the WRITE key.

If the trigger signal is a bit identifier, setting is possible from 0, 1, and 2, and if the trigger signal is a word/long word identifier, setting is possible from 2 and 3.

Values in [] are set.

0: TRIGGER BIT OFF -> ON START [-> ON] (DEFAULT)

1: TRIGGER BIT ON -> OFF START [-> OFF]

2: TRIGGER -> CHANGE START [-> CHG]

3: TRIGGER = STANDARD VALUE START [= EQU]

(the standard value set for the following item is displayed as the trigger condition.)

- STANDARD VALUE (e)

Set the standard value if "3: TRIGGER = STANDARD VALUE START" is set for the trigger condition. The set value is invalid for other trigger conditions.

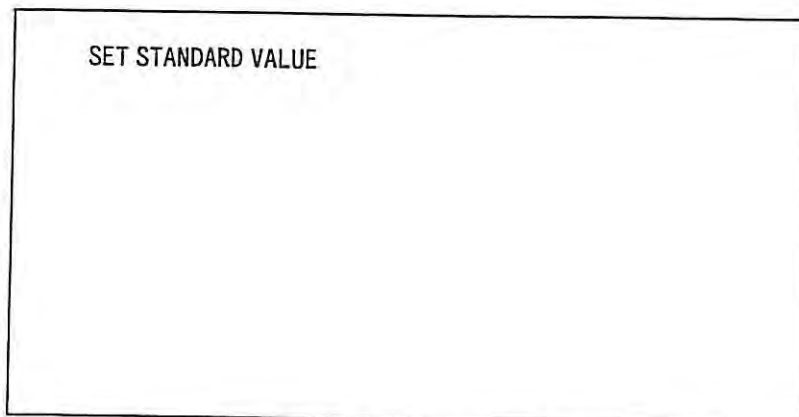

After pressing function key [F1] (SET), input the number heading the required trigger condition and press the WRITE key.

Setting range varies according to the selected trigger signal:

Word identifier: -32768 to 32767 (0000H to FFFFH)

Long word identifier: -2147483648 to 2147483647
(00000000H to FFFFFFFFH)

- BEFORE TRIGGER (f)

Set the number of data to be collected before the trigger condition is established.

After pressing function key [F1] (SET), input the number of data to be collected and press the WRITE key. The input number is set.

Setting range: 0 to 511

Default after setting trigger signal is "0".

- AFTER TRIGGER (g)

Set the number of data to be collected after the trigger condition is established.

After pressing function key [F1] (SET), input the number of data to be collected and press the WRITE key. The input number is set.

Setting range: 0 to 512

Default after setting the trigger signal is "512".

Default before setting the trigger signal is "0".

- TRACE DATA (h)

Set the trace target data.

Default is "blank" (not set).

IDENTIFIER	WI	BIT INPUT
	I.	BIT INPUT
	LI	BIT INPUT
	WM	AUXILIARY RELAY
	M	AUXILIARY RELAY
	LM	AUXILIARY RELAY
	WK	KEEP RELAY
	K.	KEEP RELAY
	LK	KEEP RELAY
	T.	TIMER RELAY

Fig. 6-11 Trace Signal Name Setting Data Menu

The list of data which can be set is displayed.

Use the page keys ( , ) to change the list of data.

After pressing function key [F1] (SET), input the identifier to be selected and press the WRITE key. The input identifier is set.

- CODE (I)

Set the data display format.

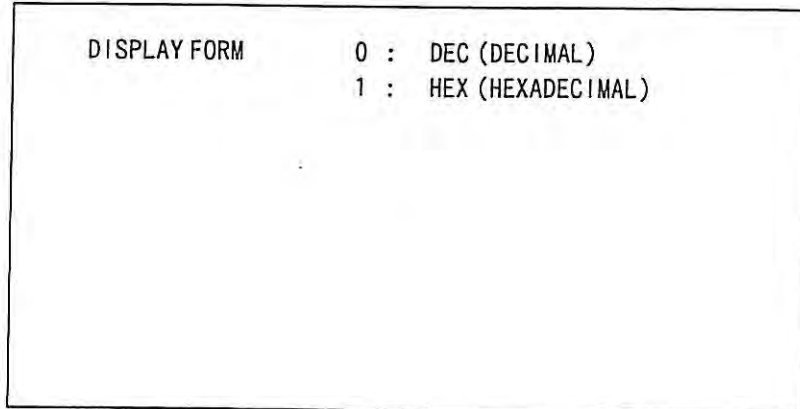

Fig. 6-12 Data Display Format Setting Data Menu

The list of data which can be set is displayed.

After pressing function key [F1] (SET), input the number heading the required format and press the WRITE key.

Selection is possible from the following two items.

Values in [] are set.

0: DEC (DECIMAL) [DEC] (DEFAULT)

1: HEX (HEXADECIMAL) [HEX]

(c) Trace/8-kind data display screen

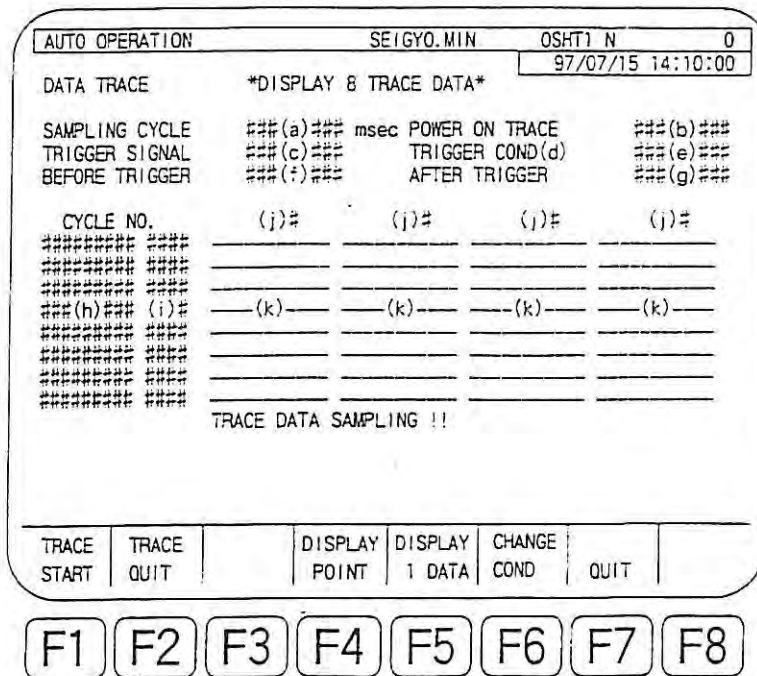

< Display items >

- SAMPLING CYCLE (a) Values set at the trace condition setting screen
- POWER ON TRACE (b) Values set at the trace condition setting screen
- TRIGGER SIGNAL (c) Values set at the trace condition setting screen
- TRIGGER COND (d) Values set at the trace condition setting screen
- STANDARD VALUE (e) Values set at the trace condition setting screen
- BEFORE TRIGGER (f) Values set at the trace condition setting screen
- AFTER TRIGGER (g) Values set at the trace condition setting screen
- TRACE DATA (h) Values set at the trace condition setting screen
- CODE (i) Values set at the trace condition setting screen

- Contents of the relays (k)

Contents of the relays, selected to be traced, are displayed in the format specified by CODE (i).

For hexadecimal display, "H" is suffixed to the data.

For bit identifiers, display is given in either "0" or "1" disregarding of the setting for the display format.

- CYCLE NO. (j)

Displays the time elapsed after the establishment of the trigger condition taking the trigger condition established timing as "0".

Time display is given in units of sampling interval (taken as "1"). A negative integer is displayed before the establishment of the trigger condition.

Trigger position

- 1 Sampling before the establishment of the trigger condition
(If sampling interval is 6.4 msec, the data sampled 6.4 msec before the establishment of the trigger condition)
- 0 Sampling data at the establishment of the trigger condition
- 1 Sampling after the establishment of the trigger condition
(If sampling interval is 6.4 msec, the data sampled 6.4 msec after the establishment of the trigger condition)

(d) Functions

[TRACE START]

Starts data tracing. During data tracing, the following message is displayed.

TRACE DATA SAMPLING!!

[TRACE QUIT]

Ends data tracing. This function is used if the processing cannot exit the tracing loop if the trigger condition is not established.

[DISPLAY POINT]

Specifies the position of the data to be displayed from 512 sampling data.

< Procedure >

- 1) Press function key [F4] (DISPLAY POINT).
- 2) Set the offset amount of the data to be referenced from the trigger position.
- 3) Press the WRITE key.

The data is displayed with the data of the specified position displayed at the second position from the left in the display area (k).

- [Supplement]
1. An offset amount is set in unit of sampling intervals. Designation of a negative value is allowed.
 2. If the specified offset position is outside the sampling range, the data at the position within the sampling range and closest to the specified offset position is displayed.

Page keys are used to change the offset position.



: Return to the previous offset position.



: Advance to the next offset position.

[DISPLAY 1 DATA]

Changes the screen to the trace/1-kind data display screen.

[CHANGE COND]

Changes the screen to the trace condition setting screen.

[QUIT]

Returns the menu to the PLC monitor function menu.

(e) Trace/1-kind data display screen

AUTO OPERATION		SEIGYO.MIN	OSHT1 N	0
DATA TRACE		*DISPLAY 1 TRACE DATA*		
		97/07/15 14:10:00		
SAMPLING CYCLE	###(a)### msec	POWER ON TRACE	###(b)###	
TRIGGER SIGNAL	###(c)###	TRIGGER COND (d)	###(e)###	
BEFORE TRIGGER	###(f)###	AFTER TRIGGER	###(g)###	
CYCLE NO.	(j)#	(j)#	(j)#	(j)#
TRACE DATA	###(h)###			
CODE	(i)#			
	—(k)—	—(k)—	—(k)—	—(k)—
TRACE DATA SAMPLING !!				

TRACE START	TRACE QUIT	DATA SWITCH	DISPLAY POINT	DISPLAY 8 DATA	CHANGE COND	QUIT	
-------------	------------	-------------	---------------	----------------	-------------	------	--

F1	F2	F3	F4	F5	F6	F7	F8
----	----	----	----	----	----	----	----

< Display items >

- SAMPLING CYCLE (a) Values set at the trace condition setting screen
- POWER ON TRACE (b) Values set at the trace condition setting screen
- TRIGGER SIGNAL (c) Values set at the trace condition setting screen
- TRIGGER COND (d) Values set at the trace condition setting screen
- STANDARD VALUE (e) Values set at the trace condition setting screen
- BEFORE TRIGGER (f) Values set at the trace condition setting screen
- AFTERRR TRIGGER (g) Values set at the trace condition setting screen
- TRACE DATA (h) Values set at the trace condition setting screen
- CODE (i) Values set at the trace condition setting screen

- Contents of the relays (k)

Contents of the relays, selected to be traced, are displayed in the format specified by CODE (i).

For hexadecimal display, "H" is suffixed to the data.

For bit identifiers, display is given in either "0" or "1" disregarding of the setting for the display format.

- CYCLE NO. (j)

Displays the time elapsed after the establishment of the trigger condition taking the trigger condition established timing as "0".

Time display is given in units of sampling interval (taken as "1"). A negative integer is displayed before the establishment of the trigger condition.

Since the data collecting in 8 sampling cycle intervals are displayed from the top line in each area, the trigger position value is taken in increment of "8".

Trigger position

- 1 Sampling before the establishment of the trigger condition
(If sampling interval is 6.4 msec, the data sampled 6.4 msec before the establishment of the trigger condition)
- 0 Sampling data at the establishment of the trigger condition
- 1 Sampling after the establishment of the trigger condition
(If sampling interval is 6.4 msec, the data sampled 6.4 msec after the establishment of the trigger condition)

(f) Functions

[TRACE START]

Starts data tracing. During data tracing, the following message is displayed.

TRACE DATA SAMPLING!!

[TRACE QUIT]

Ends data tracing. This function is used if the processing cannot exit the tracing loop if the trigger condition is not established.

[DATA SWITCH]

Selects the kind of data to be displayed from among 8 kinds of data.

[DISPLAY POINT]

Specifies the position of the data to be displayed from 512 sampling data.

< Procedure >

- 1) Press function key [F4] (DISPLAY POINT).
- 2) Set the offset amount of the data to be referenced from the trigger position.
- 3) Press the WRITE key.

The data is displayed with the data of the specified position displayed at the second position from the left in the display area (k).

- [Supplement]
1. An offset amount is set in unit of sampling intervals. Designation of a negative value is allowed.
 2. If the specified offset position is outside the sampling range, the data at the position within the sampling range and closest to the specified offset position is displayed.

Page keys are used to change the offset position.

 : Return to the previous offset position.

 : Advance to the next offset position.

[DISPLAY 8 DATA]

Changes the screen to the trace execution/8-kind data display screen.

[CHANGE COND]

Changes the screen to the trace condition setting screen.

[QUIT]

Returns the menu to the PLC monitor function menu.

SECTION 7 PLC PROGRAM INSTRUCTIONS

1. Outline of PLC Program Instructions

This section describes the instructions used in PLC programs which are displayed in the ladder monitor.

1-1. Basic Instructions

Name	Symbol	Remark
A contact (NO contact)		
B contact (NC contact)		
Coil		
Set		
Reset		
Inversion		
Return		(n = 0 to F)

1-2. Application Instructions

(1) Differential Instructions

Name	Symbol	Remark
Rising edge differential		- The previous differential value relay stores the input state of the previous scan and the instruction executes output processing based on the difference between the input state in the previous scan and that in the present scan.
Falling edge differential		
Flip-flop		

(2) Counter Instructions

Name	Symbol	Remark
Up counter		<ul style="list-style-type: none"> - The instruction detects the rising edge of an input and executes increment or decrement of the counter data. - The counter relay is turned ON if the counted value reaches or exceeds the preset value, or if the counted value reaches "0".
Down counter		
Up/down counter		
Ring counter		

(3) Timer Instructions

Name	Symbol	Remark
ON-delay timer		<ul style="list-style-type: none"> - The instruction detects the leading or trailing edge of a timer input to start counting of time. At the time-up, the timer relay is turned ON or OFF.
OFF-delay timer		
Mono-stable timer		
Integrating timer		
Retriggerable timer		

(4) Arithmetic Operation Instructions

Name	Symbol	Remark
Addition	$\begin{array}{c} \text{H} \text{ T} \\ \text{P3} \end{array} \left[\text{ P0 } + \text{ P1 } \rightarrow \text{ P2 } \right] \text{ T}$	- The instruction performs arithmetic operation.
Subtraction	$\begin{array}{c} \text{H} \text{ T} \\ \text{P3} \end{array} \left[\text{ P0 } - \text{ P1 } \rightarrow \text{ P2 } \right] \text{ T}$	
Multiplication	$\begin{array}{c} \text{H} \text{ T} \\ \text{P3} \end{array} \left[\text{ P0 } * \text{ P1 } \rightarrow \text{ P2 } \right] \text{ T}$	
Division	$\begin{array}{c} \text{H} \text{ T} \\ \text{P3} \end{array} \left[\text{ P0 } / \text{ P1 } \rightarrow \text{ P2 } \right] \text{ T}$	
Remainder	$\begin{array}{c} \text{H} \text{ T} \\ \text{P3} \end{array} \left[\text{ P0 MOD P1 } \rightarrow \text{ P2 } \right] \text{ T}$	
Absolute value	$\begin{array}{c} \text{H} \text{ T} \\ \text{P2} \end{array} \left[\text{ P0 ABS } \rightarrow \text{ P1 } \right] \text{ T}$	
Sign inversion	$\begin{array}{c} \text{H} \text{ T} \\ \text{P2} \end{array} \left[\text{ P0 } +/- \rightarrow \text{ P1 } \right] \text{ T}$	

(6) Comparison Instructions

Name	Symbol	Remark
>	$\begin{array}{c} \text{H} \\ \text{H} \\ \text{H} \end{array} \text{[P0 > P1] } \text{-()} \begin{array}{c} \text{P2} \\ \text{P2} \\ \text{P2} \end{array}$	- The instruction performs arithmetic operation.
\equiv	$\begin{array}{c} \text{H} \\ \text{H} \\ \text{H} \end{array} \text{[P0 } \equiv \text{ P1] } \text{-()} \begin{array}{c} \text{P2} \\ \text{P2} \\ \text{P2} \end{array}$	
<	$\begin{array}{c} \text{H} \\ \text{H} \\ \text{H} \end{array} \text{[P0 < P1] } \text{-()} \begin{array}{c} \text{P2} \\ \text{P2} \\ \text{P2} \end{array}$	
\cong	$\begin{array}{c} \text{H} \\ \text{H} \\ \text{H} \end{array} \text{[P0 } \cong \text{ P1] } \text{-()} \begin{array}{c} \text{P2} \\ \text{P2} \\ \text{P2} \end{array}$	
=	$\begin{array}{c} \text{H} \\ \text{H} \\ \text{H} \end{array} \text{[P0 = P1] } \text{-()} \begin{array}{c} \text{P2} \\ \text{P2} \\ \text{P2} \end{array}$	
\neq	$\begin{array}{c} \text{H} \\ \text{H} \\ \text{H} \end{array} \text{[P0 } \neq \text{ P1] } \text{-()} \begin{array}{c} \text{P2} \\ \text{P2} \\ \text{P2} \end{array}$	

(7) Transfer Instructions

Name	Symbol	Remark
Logical block transfer	$\begin{array}{c} \text{H} \\ \text{H} \\ \text{H} \end{array} \text{[P1 LBT P2 : P0] } \begin{array}{c} \text{P2} \\ \text{P2} \\ \text{P2} \end{array}$	- The instruction performs arithmetic operation.
Logical transfer	$\begin{array}{c} \text{H} \\ \text{H} \\ \text{H} \end{array} \text{[P0 LMOV P1] } \begin{array}{c} \text{P2} \\ \text{P2} \\ \text{P2} \end{array}$	
Pattern clear	$\begin{array}{c} \text{H} \\ \text{H} \\ \text{H} \end{array} \text{[P2 PC P1 : P0] } \begin{array}{c} \text{P2} \\ \text{P2} \\ \text{P2} \end{array}$	
Search	$\begin{array}{c} \text{H} \\ \text{H} \\ \text{H} \end{array} \text{[P1 SRCH P2 : P3 : P0] } \text{-()} \begin{array}{c} \text{P4} \\ \text{P4} \\ \text{P4} \end{array}$	
Switch	$\begin{array}{c} \text{H} \\ \text{H} \\ \text{H} \end{array} \text{[P0 : P1 : P2 SW P3] } \begin{array}{c} \text{P4} \\ \text{P4} \\ \text{P4} \end{array}$	
Word swap	$\begin{array}{c} \text{H} \\ \text{H} \\ \text{H} \end{array} \text{[P0 WSWP P1] } \begin{array}{c} \text{P2} \\ \text{P2} \\ \text{P2} \end{array}$	

(8) Conversion Instructions

Name	Symbol	Remark
Binary/BCD conversion	$\begin{array}{c} \text{H} \text{ T} [\\ \text{P2} \end{array} \quad \text{P0 BCD P1} \quad \text{]} \text{ T}$	
BCD/binary conversion	$\begin{array}{c} \text{H} \text{ T} [\\ \text{P2} \end{array} \quad \text{P0 BIN P1} \quad \text{]} \text{ T}$	
Single precision/double precision (arithmetic operation)	$\begin{array}{c} \text{H} \text{ T} [\\ \text{P2} \end{array} \quad \text{P0 DSC P1} \quad \text{]} \text{ T}$	
Double precision/single precision (logical operation)	$\begin{array}{c} \text{H} \text{ T} [\\ \text{P2} \end{array} \quad \text{P0 SDLC P1} \quad \text{]} \text{ T}$	
Double precision/single precision (arithmetic operation)	$\begin{array}{c} \text{H} \text{ T} [\\ \text{P2} \end{array} \quad \text{P0 SDAC P1} \quad \text{]} \text{ T}$	

(9) Selective Construction Instructions

Name	Symbol
IF	
	Function

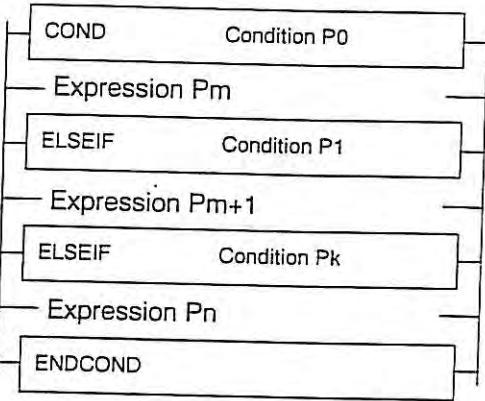
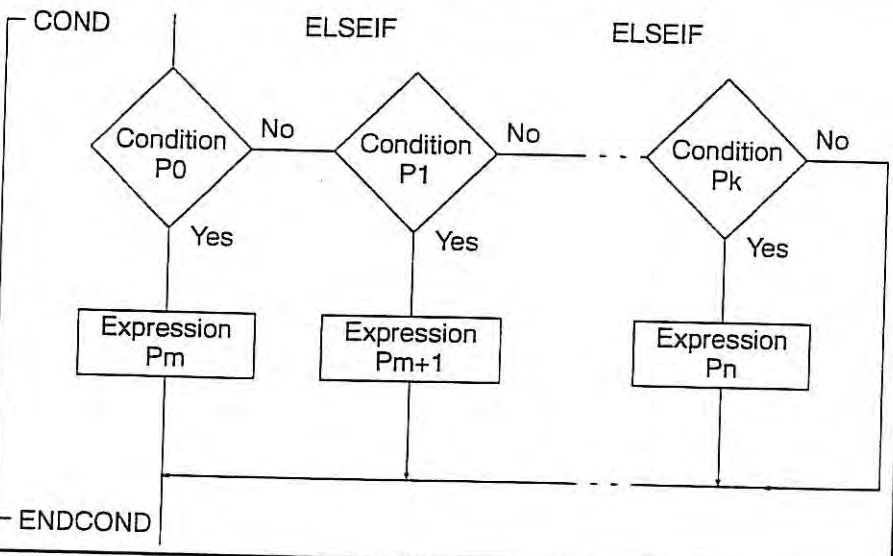
Name	Symbol
COND	
	<p data-bbox="924 725 1031 752" style="text-align: center;">Function</p> 

Name	Symbol
CASE	CASE Key 0
	CASEIF a (P1)
	CASEIF b (P2)
	CASEIF c (P3)
	Expression Pj
	CASEIF d (Pk-1)
	CASEIF e (Pk)
	Expression Pj+1
	OTHERW
	Expression Pt
ENDCASE	
Function	
<pre> graph TD CASE --> KeyP0[Key P0] KeyP0 --> J1(()) J1 --> A[a V b V c (P1 V P2 V P3)] A --> Ej[Expression Pj] J1 --> D[d V e (Pk-1 V Pk)] D --> Ej1[Expression Pj+1] J1 --> O[OTHERWISE] O --> Ej2[Expression Pt] Ej --> J2(()) Ej1 --> J2 Ej2 --> J2 J2 --> ENDCASE[ENDCASE] </pre>	

(10) Loop Construction Instructions

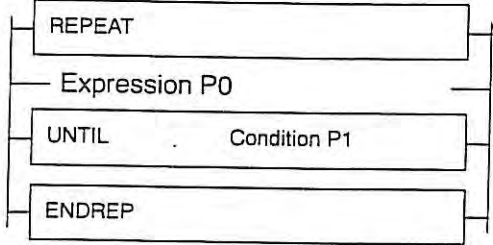
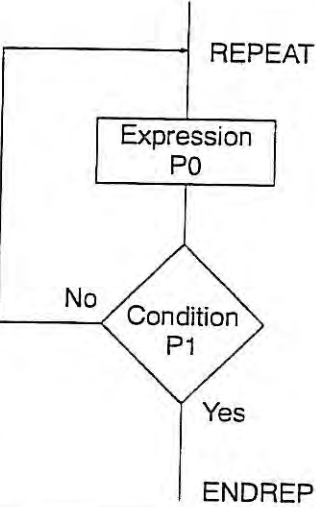
Name	Symbol
REPEAT	
	<p data-bbox="920 606 1021 637">Function</p> 

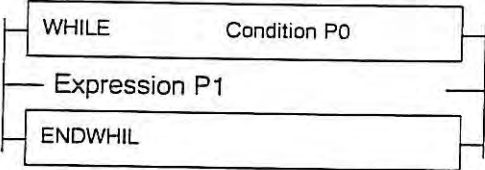
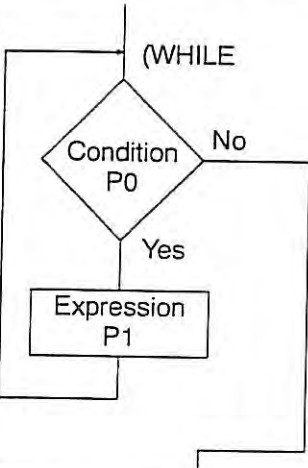
Name	Symbol
WHILE	
	<p data-bbox="897 1468 1005 1499">Function</p> 

(11) Program Control Instructions

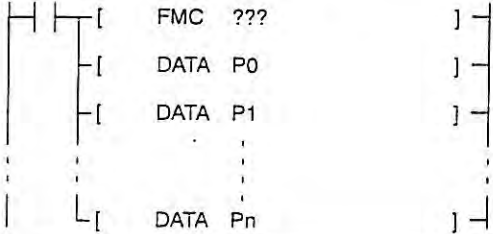
Name	Symbol	Function
Function module call		- The instruction calls a function module by passing arguments P0 - Pn.

(12) Index Register Instructions

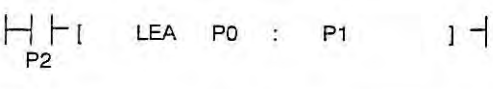
Name	Symbol	Function
Load effective address		- The instruction acquires the address of an identifier and stores it in the index register.

1-3. System Function Module

The system function module is a function module (functions like a subroutine) provided by Okuma, that executes the function which is difficult to program using a ladder or requires a complicated program. System function modules (system FM) are allocated to system areas having FM numbers 256 and on.

The following system function modules are provided:

SFM256	Inverse gray code → binary conversion
SFM257	Parity check
SFM258	Byte data transfer
SFM263	Gray code → binary conversion
SFM264	Alarm request
SFM270	Revolving body control
SFM272	Code → bit development
SFM275	M code development (8/16)
SFM276	Logic table initialization
SFM277	Logic table control
SFM278	Magazine data calculation
SFM279	Word table search

(1) [SFM256] Inverse gray code → binary conversion

[SFM263] Gray code → binary conversion

- The function module converts an inverse gray code into binary to output (SFM256).
- The function module converts gray code into binary to output (SFM263).

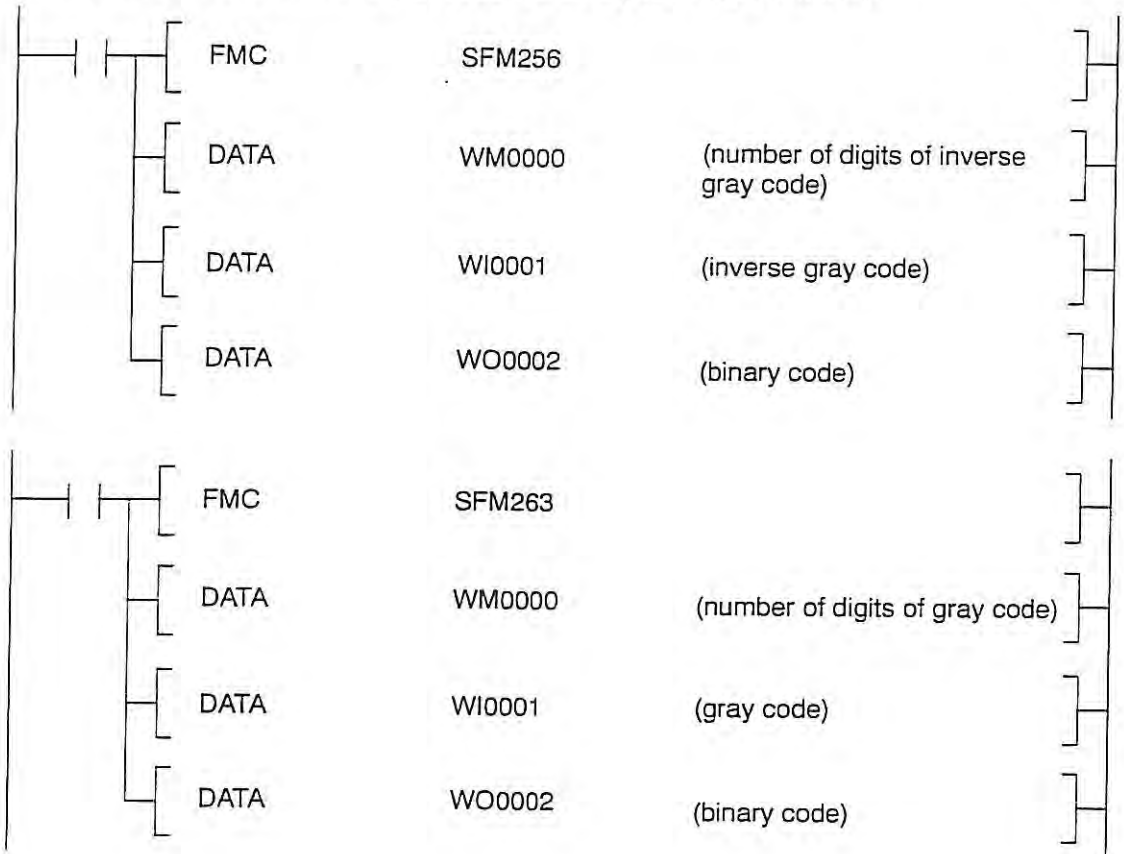

(2) [SFM257] Parity check

- The function module counts the number of ON bits in the input data and outputs whether the number of ON bits is even or odd.

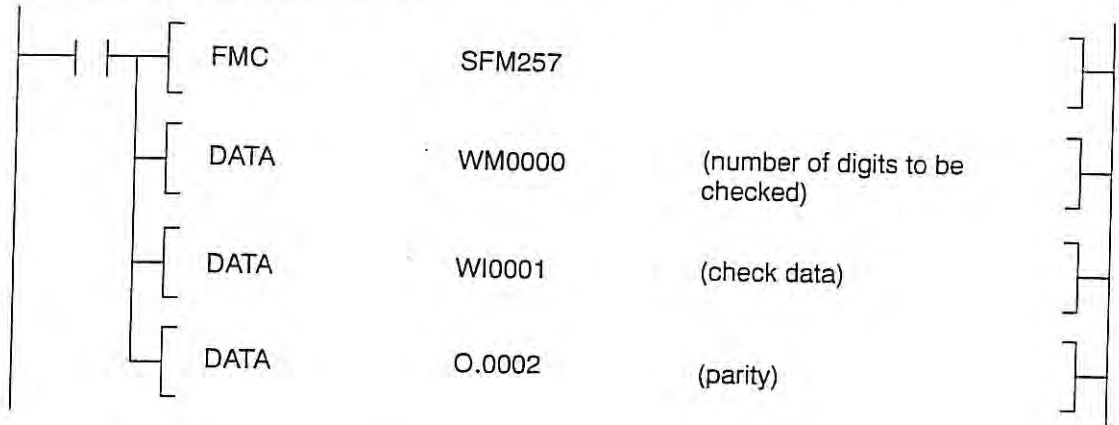

(3) [SFM258] Byte data transfer

- The function module transfers the higher/lower bytes of the transfer source word data to the higher/lower bytes of the transfer destination word data.

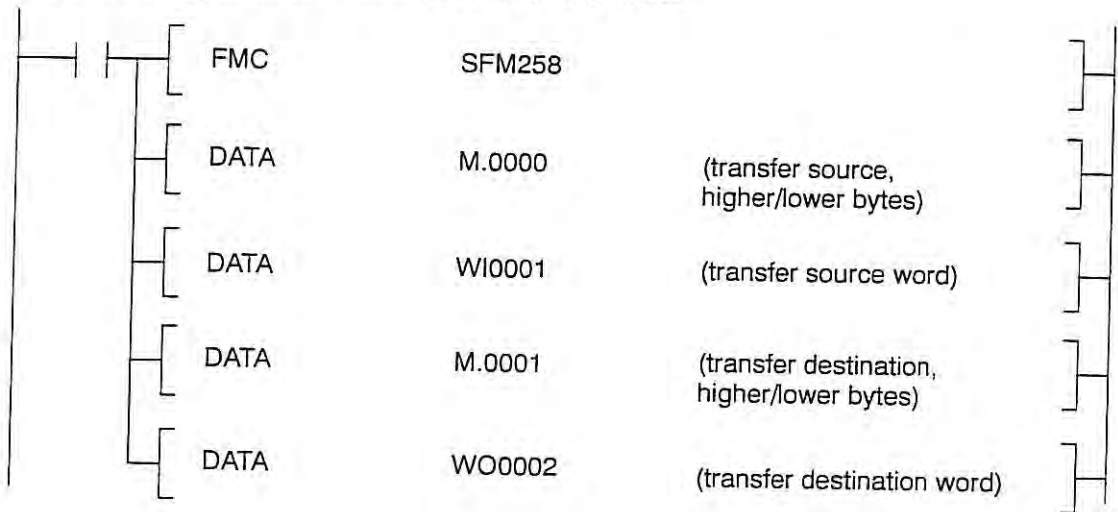

(4) [SFM264] Alarm request

- The function module requests an alarm according to the alarm information given in an alarm block. It writes the return value to the alarm block.

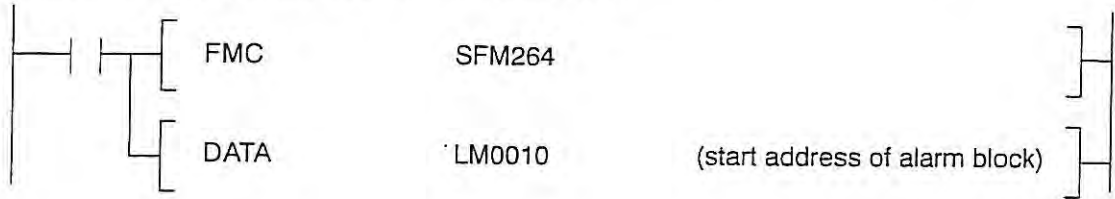

Data configuration of alarm block:

The size of an alarm block is 16 bytes.

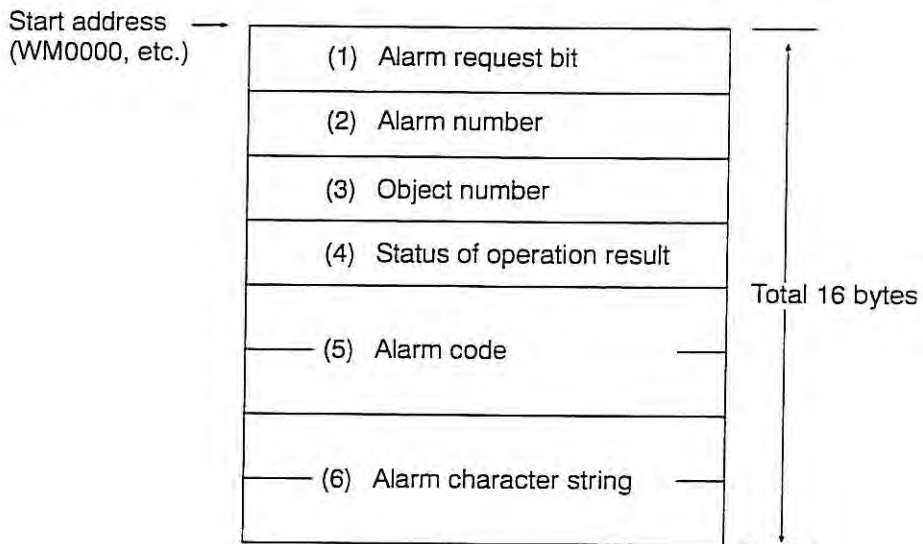

(5) [SFM270] Revolving body control

- The function module judges the direction of rotation for shorter path control (if reverse rotation is possible).
- The function module returns the element number of the element appearing immediately before it or returns the number of elements appearing before the target is reached.

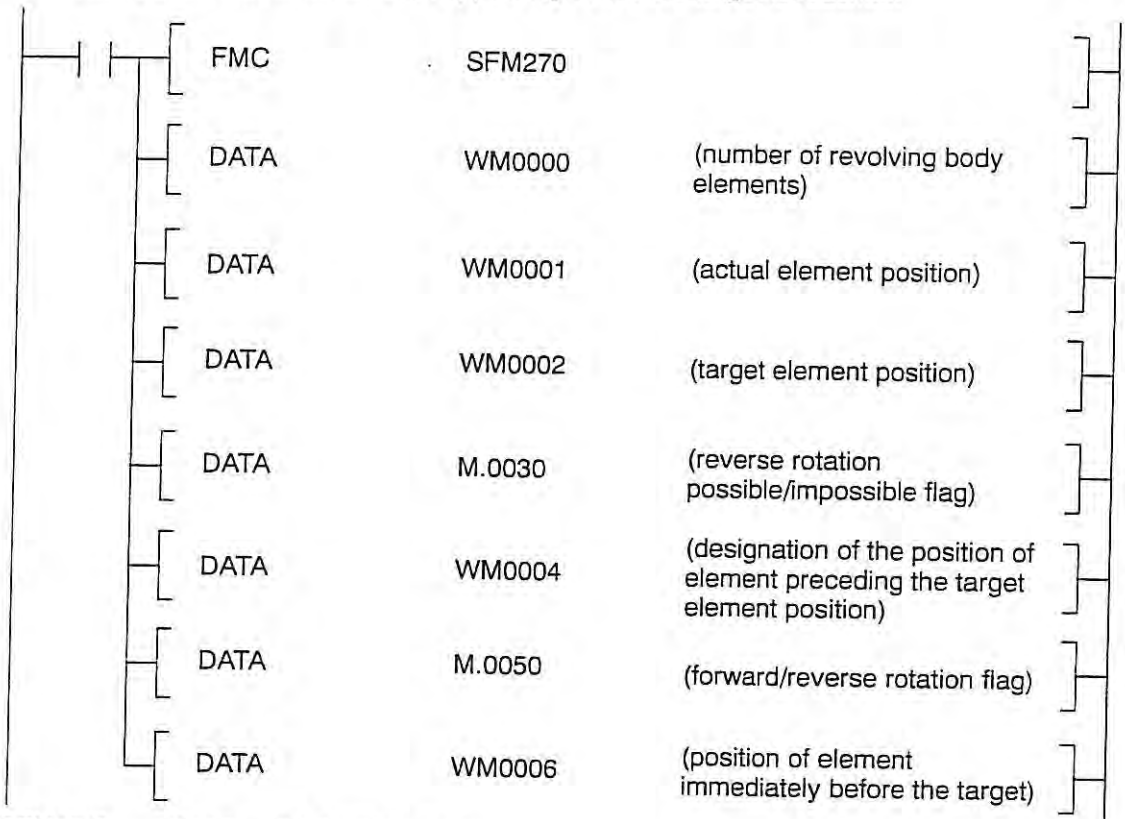

(6) [SFM272] Code → bit development

- The function module develops the M or T code received as a number into irregular hexadecimal (M., K., etc.).

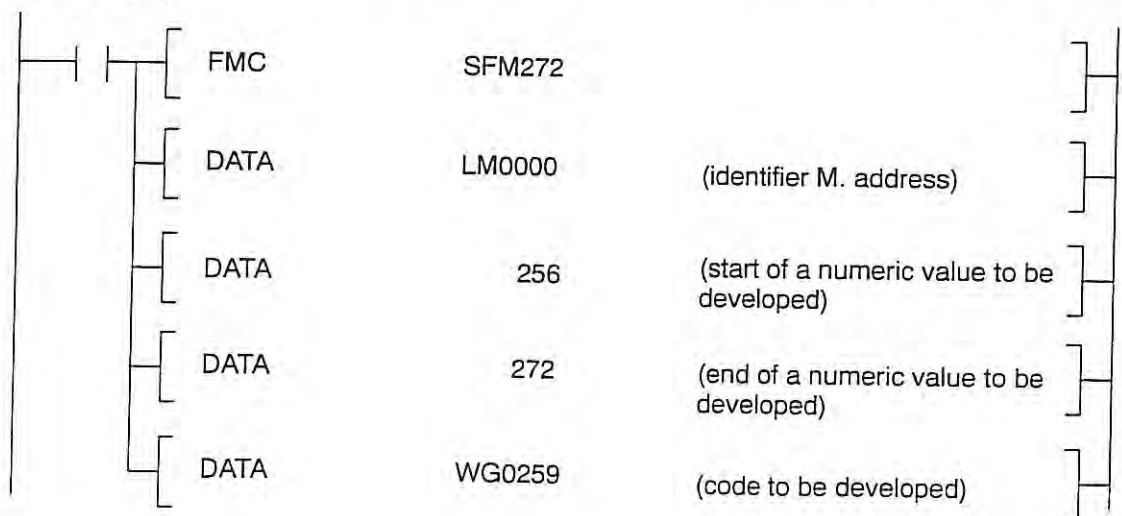

(7) [SFM275] M code development

- The function module develops the M code received as a number into internal memory of irregular hexadecimal (M.), referring to the M code configuration data (MC).

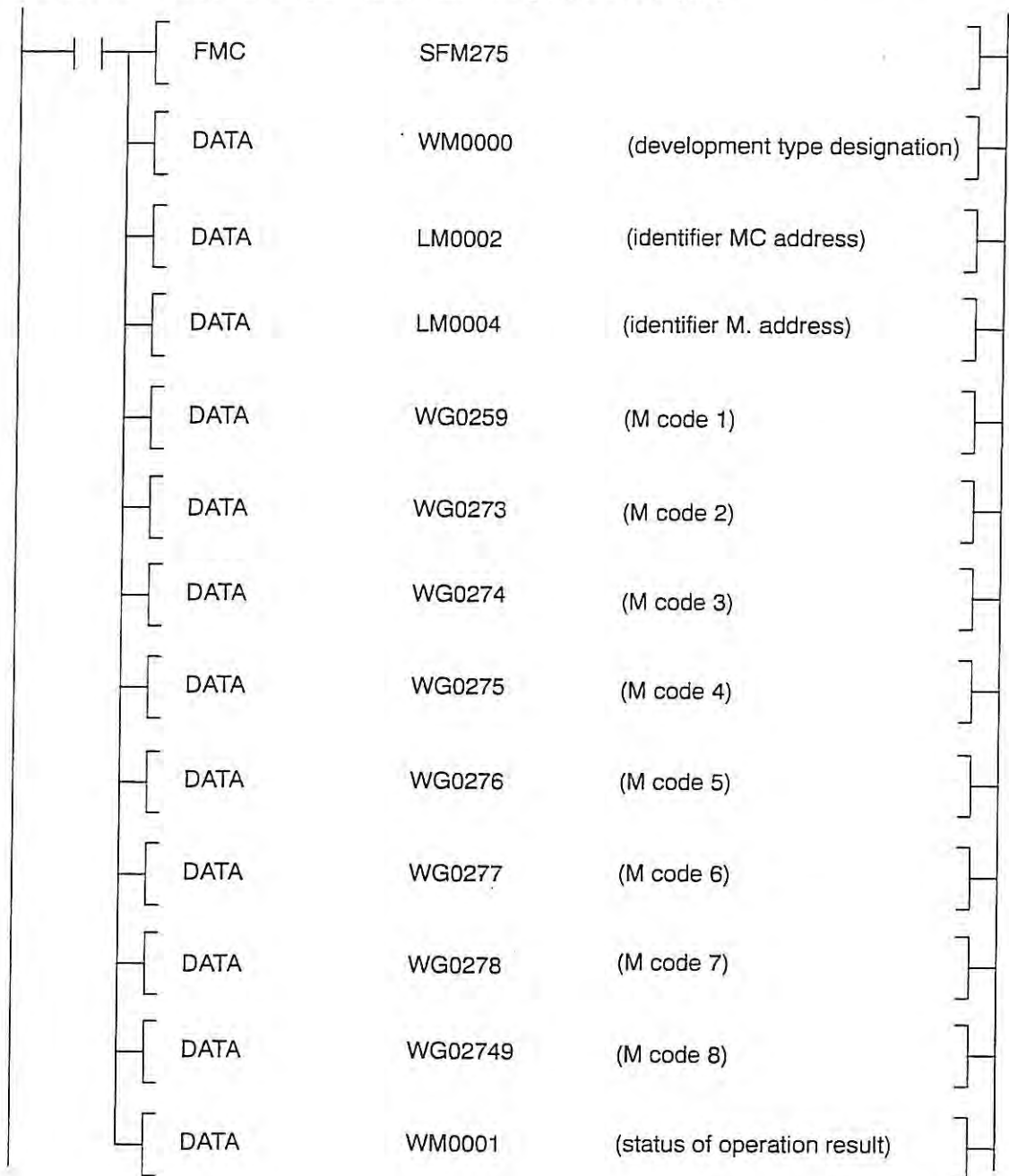

(8) [SFM276] Logic table initialization

- The function module initializes the logic table which is used for sequence control of ATC and APC.

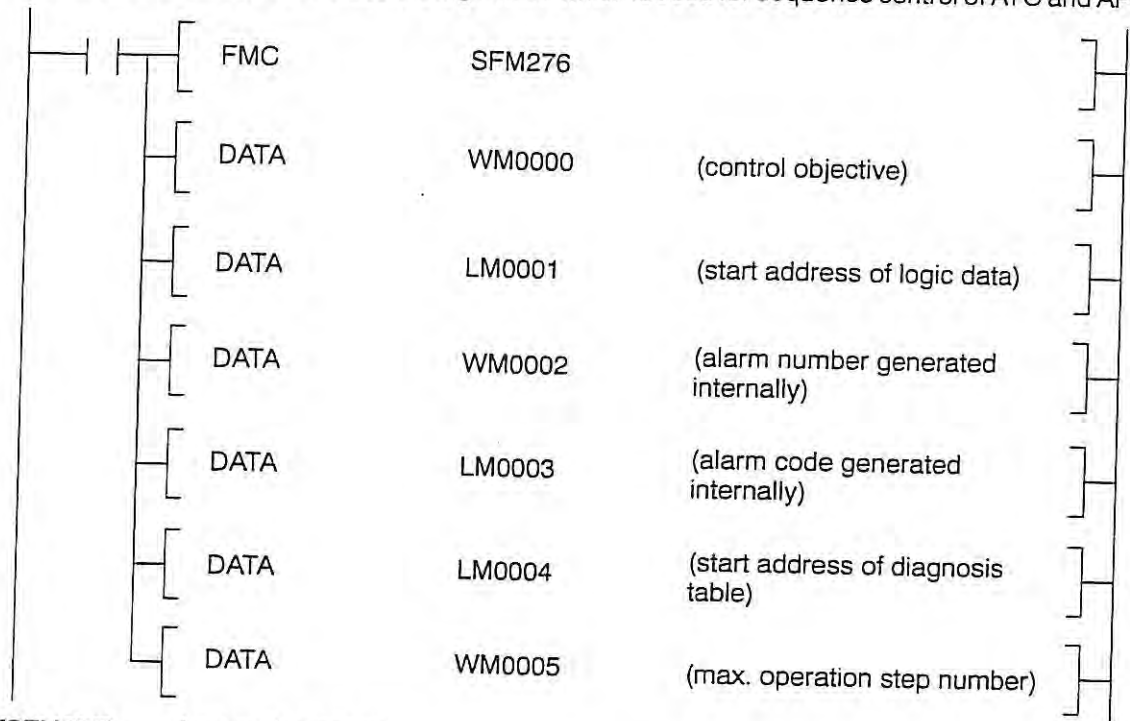

(9) [SFM277] Logic table control

- The function module executes sequence control of ATC, APC, etc.

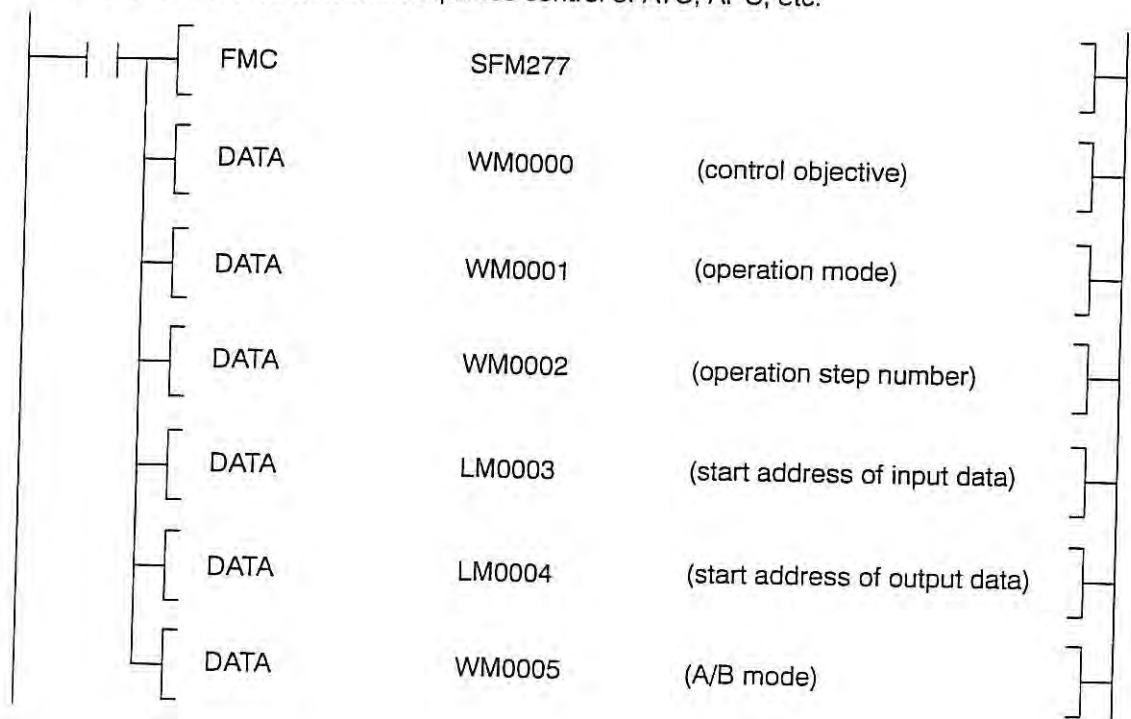

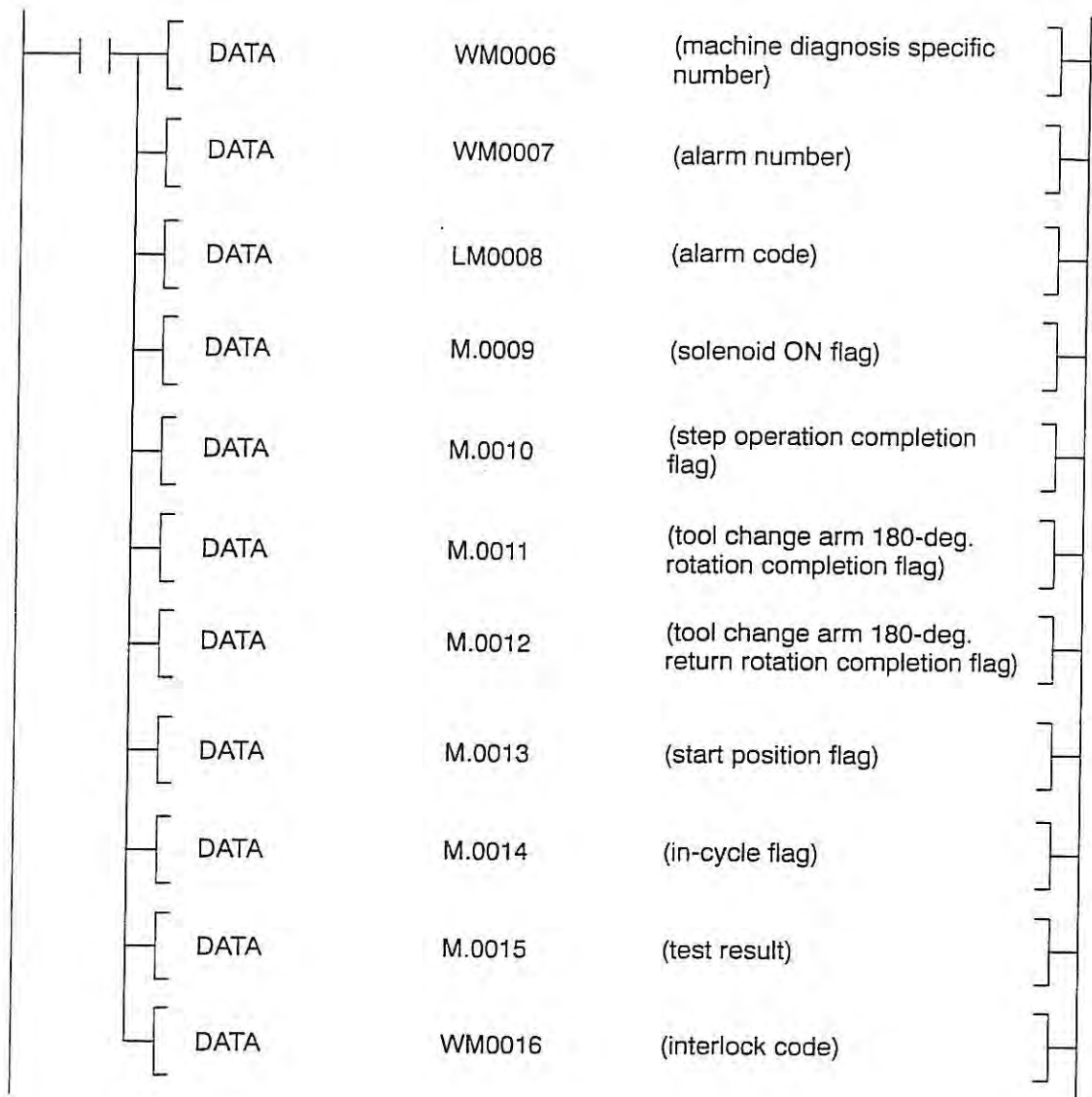

(10) [SFM278] Magazine data calculation

- The function module calculates the actual pot number from the actual position (APA) of the magazine and the position command value (COM) from the pot number.

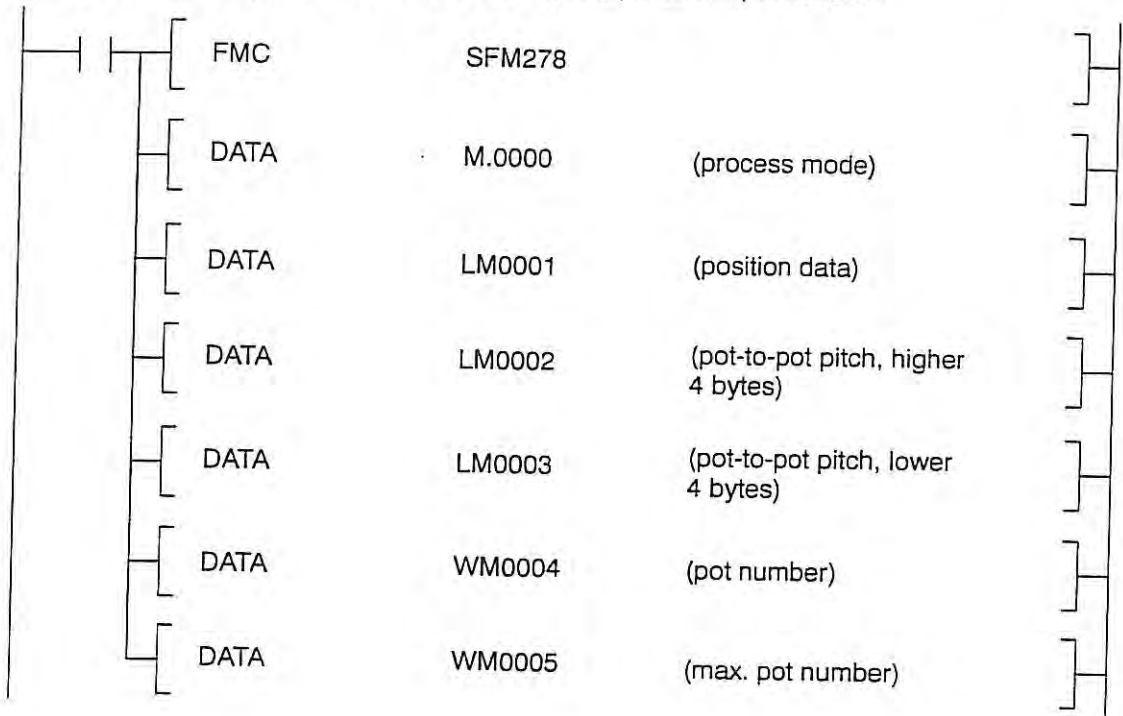

(11) [SFM279] Word table search

- The function module compares P1 to the upper one word in the table, where two words are arranged up and down in a pair, starting from address P0, and outputs the lower one word to P3 with "1" set to P4 if the upper one word agrees with P1. If the value of the upper word reaches value P2 in the state these words do not agree with each other, the function module sets "0" for P3 and P4.

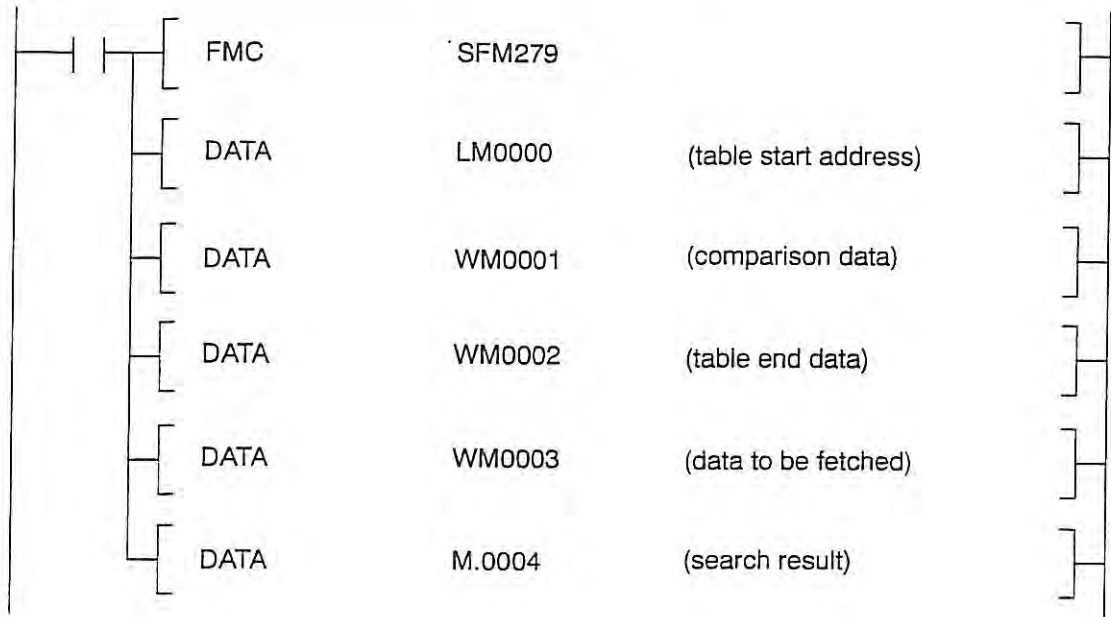

SECTION 8 INSTALLING SOFTWARE

1. Outline of Install

This section deals with the procedure for installing the software.

Points to be taken into consideration for this operation are shown below:

- (1) Flash memory and C-MOS memory are used for the main memory.
- (2) Software is provided in package floppy disks and custom floppy disks.

Package floppy disks Floppy disks storing the software common to different machines

- NC application software
- I-MAP, etc.

Custom floppy disks Floppy disks storing machine-specific software

- Specification code file
- Option software
- PBU file, etc.

2. Glossary of Technical Terms

2-1. Flash Memory (FR)

Flash memory stores the control program files such as *.SYS, *.POL, *.MSG, and *.LOB.

Flash memory is divided into the following partitions when the software is installed.

< Partition of flash memory >

Partition	Installed Software
FR0A:	NCOS, MCS firmware, FOS (PLC control software), utility
FR0B:	MacMan software
FR0C:	NC control software
FR0D:	IGF-M
FR0E:	I-MAP, MOP-TOOL
FR0F:	DNC-P, DNC-T, DNC-DT, TCP/IP firmware, SSCI firmware, CCP firmware
FR0G:	PLC monitor software
FR0H:	Super Hi-NC
FR1C:	NC specification code data, control card data, MSB NC specification message, user-specific software
FR1H:	NC help message
FR2G:	Sequence program
FR2H:	PLC screen data, PLC alarm message, PLC help message, system I/O data, logic table data

2-2. Memory Disk (MD)

C-MOS memory area is called memory disk.

It stores the user's part programs and backup data files (*.PBU).

The memory disk is divided into the following partitions when the software is installed.

< Partitions of memory disk >

Partition	Installed Software
MD0A: (MD0:)	NC data file, MacMan data, PLC monitor data
MD0C:	IGF-M, I-MAP data, DNC data, MOP-TOOL data
MD0E: MD0G:	PLC variable data, PLC constant data, MCS data, PLC axis data, M code data
MD0H: (MD1:)	User's part programs, etc.

2-3. Install

"Install" means the operation to store the control software in the FR or MD.

NOTICE

: By installing software, data files in MD0: are all reset to the initial values and the contents in MD1: are all initialized. Therefore, data files, program files, etc. must be backed up before installing the software again.

2-4. Package Floppy Disk

Package floppy disk stores the software common to different machines.

Floppy disk is prepared for the individual functions.

- System package
- NC application package
- IGF-M package
- Option package (I-MAP, MOP-TOOL)
- DNC package, etc.

2-5. Custom Floppy Disk

The custom floppy disk stores machine-dependent software, such as specification code file, control card file, user specification software file, and data file.

Two custom floppy disks are provided:

- NC custom floppy disk
- PLC custom floppy disk

2-6. System Backup Floppy Disk

The system backup floppy disk stores the backup data of the system data, which is specific to the individual machines. System data must be backed up in regular intervals.

When the machine is delivered, the system backup floppy disk stores the system data set before the shipping of the machine.

The system backup floppy disk is OSP format floppy disk.

2-7. Work Disk

Work disk is a floppy disk where user's part programs should be stored before changing battery.

The work disk is OSP format floppy disk and should be prepared by the user.

3. Media Necessary for Installing Software

3-1. Control Floppy Disks

3-1-1. Kinds of Control Floppy Disks

(1) NC Custom Floppy Disk

NC custom floppy disk stores the NC software specific to the individual machines.

```

                ** MNC CUSTOM FLOPPY **      < 1/ >
OSP              DATE:1997-07-03
TYPE:MX45VA     B601-3181-10
MNCU60100777-01

                OSP   SERIES

                OKUMA CORPORATION
    
```

(2) Package Floppy Disks

Package floppy disks are provided meeting the user's machine specifications.

These floppy disks can be identified by labels.

```

                ** MNC PACKAGE FLOPPY **      < 3/ >
OSP   SERIES
TYPE:          S/N:
MNCA601A000-001

                ** SYSTEM PACKAGE FLOPPY **  < 2/ >
OSP   SERIES
TYPE:          S/N:
SYSE00AJPN-001

##### # # #####
#     ## # #
##### # # # # ###   OSP   SERIES
#     # ## # ##
##### # #  ## #
                OKUMA CORPORATION
    
```

< Package floppy disks >

Label	Contents
SYSTEM PACKAGE FLOPPY	NCOS Utility MCS firmware FOS (PLC control software) PLC monitor software
MNC PACKAGE FLOPPY	Machining center NC control software
M MACMAN PACKAGE FLOPPY	MacMan function NC alarm help message
IGF-M PACKAGE FLOPPY	IGF-M software
M OPTION A/B PACKAGE FLOPPY	I-MAP MOP-TOOL
DNC PACKAGE FLOPPY	DNC-P DNC-T/DT DNC-B/C

IGF-M PACKAGE FLOPPY, M OPTION A/B PACKAGE FLOPPY, and DNC PACKAGE FLOPPY are provided only when the corresponding specification is selected.

(3) PLC Custom Floppy Disks

PLC custom floppy disks store the PLC software specific to the individual machines.

```
      ** MPLC CUSTOM FLOPPY **      < / >
OSP                                DATE:1997-07-03
TYPE:MX45VA      S/N:00777          B601-3181-10
MPCU60100777-01A

      OSP      SERIES

      OKUMA CORPORATION
```

```
      ** MPLC CUSTOM FLOPPY **      < / >
OSP                                DATE:1997-07-03
TYPE:MX45VA      S/N:00777          B601-3181-10
MPCU60100777-01B

      OSP      SERIES

      OKUMA CORPORATION
```

3-1-2. Configuration of Control Floppy Disks

(1) Control Floppy Disks for the Standard Specifications

For the standard specifications, the following six floppy disks are provided.

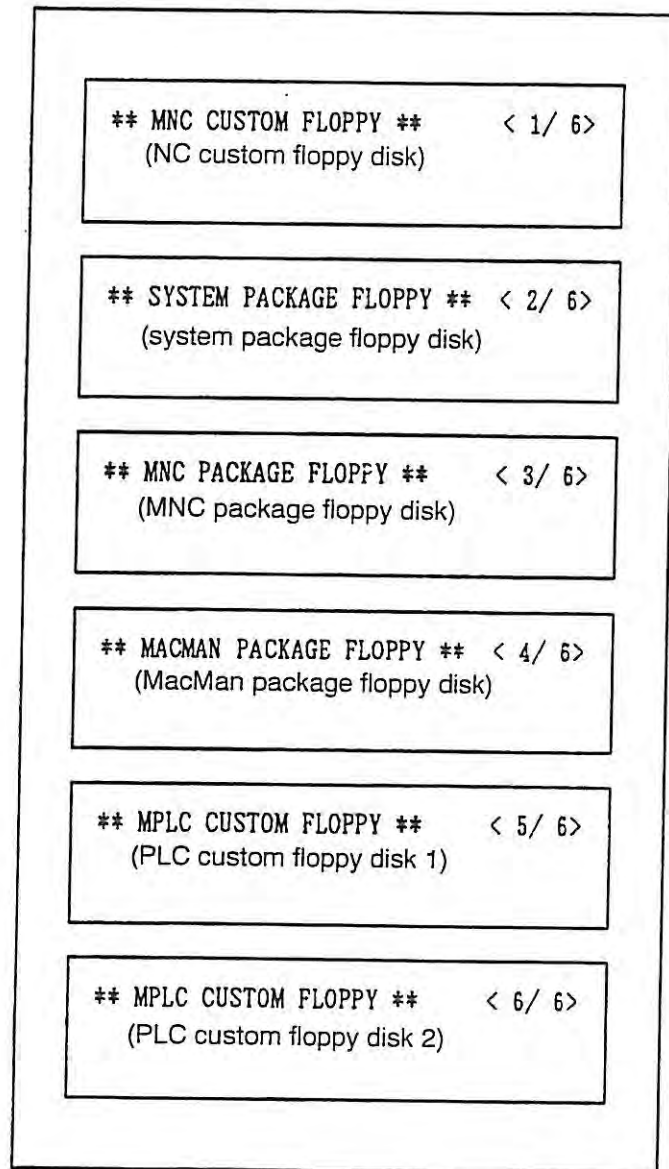

(2) Control Floppy Disks for Optional Specifications

Floppy Disk Label	Configuration of Floppy Disks (No./Total: Printed at the upper right part of a label) [n = 6 to 10]								
NC CUSTOM FLOPPY	1/6	1/8	1/7	1/9	1/7	1/9	1/8	1/10	1/n
SYSTEM PACKAGE FLOPPY	2/6	2/8	2/7	2/9	2/7	2/9	2/8	2/10	2/n
LNC PACKAGE FLOPPY	3/6	3/8	3/7	3/9	3/7	3/9	3/8	3/10	3/n
MACMAN PACKAGE FLOPPY	4/6	4/8	4/7	4/9	4/7	4/9	4/8	4/10	4/n
IGF-M PACKAGE FLOPPY		5/8 6/8		5/9 6/9		5/9 6/9		5/10 6/10	5/n to (n-2)/n
M OPTION PACKAGE FLOPPY			5/7	7/9			5/8	7/10	5/n to (n-2)/n
DNC PACKAGE FLOPPY					5/7	7/9	6/8	8/10	5/n to (n-2)/n
PLC CUSTOM FLOPPY 1	5/6	7/8	6/7	8/9	6/7	8/9	7/8	9/10	(n-1)/n
PLC CUSTOM FLOPPY 2	6/6	8/8	7/7	9/9	7/7	9/9	8/8	10/10	n/n

The order number is entered to the floppy disk label in the following rule.

- (1) The first floppy disk is the NC custom floppy disk.
- (2) The package floppy disks are from the second floppy disk to the third one from the last disk.
- (3) The last two floppy disks are PLC custom floppy disks.

If the total number of floppy disks supplied is "n", configuration of the floppy disks is as explained as below:

- (1) The "1/n"th floppy disk is the NC custom floppy disk.
- (2) Package floppy disks are from the "2/n"th to the "(n-2)/n"th floppy disk.
- (3) PLC custom floppy disks are the "(n-1)/n"th and "n/n"th floppy disks.

3-2. System Backup Floppy Disk

System backup floppy disk storing the system data set before the shipping of the machine is supplied with the control floppy disks.

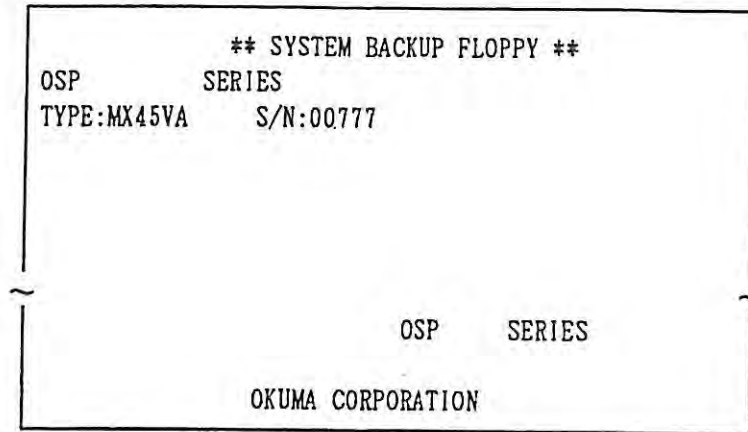

3-3. Work Disk

Work disks should be prepared by the user.

Specification: 3.5 inches, 1.44 MB

OSP format

< OSP formatting procedure >

- 1) Press the [EDIT AUX] key on the NC operation panel to select the program operation mode.
- 2) Press [F2] (INIT), then input the following:
= IN FD0:
- 3) Press the WRITE key. The following message will be displayed: input [Y] in response.
= IN FD0:
initialize OK (Y/N) ! Y
- 4) Now the formatting message shown below will be displayed. Input [Y] in response.
= IN FD0:
initialize OK (Y/N) ! Y
formatting (Y/N) ! Y
- 5) Now the format type message will be displayed. Input [1] in response.
= IN FD0:
initialize OK (Y/N) ! Y
formatting (Y/N) ! Y
format (2DD - 720K = 0, 2HD - 1.44 = 1) ! 1

By the steps indicated above, the floppy disk is initialized in the OSP format.

4. Steps for Installing Software

Installation of the software is divided into the following five steps.

- (1) Checking the hardware configuration
- (2) Initializing the MD
- (3) Back up of the data
- (4) Installing the software
- (5) Loading the backup data

5. Procedure for Installing Software

5-1. Checking the Hardware Configuration

Check the hardware configuration related to the installation of software.

5-1-1. Checking the UCMB

(1) Checking the Memory Size

Check the memory size of:

- Flash memory
- C-MOS memory

(2) Checking the Connection of Backup Battery on UCMB

The UCMB has the memory backup battery.

Visually check if the battery is connected to the terminal (orange) extending from the board.

When installing the software for the first time, the battery may not be connected. In this case, connect the battery and initialize the memory disk following the steps explained in 5-2. "MD Initialization Processing".

5-2. MD Initialization Processing

5-2-1. Cases Requiring MD Initialization Processing

The MD must be initialized in the following cases.

- (1) Installing the software in the memory for the first time
- (2) Battery was not connected to the UCMB.
- (3) Contents of the MD have been lost due to low backup battery voltage
- (4) Changing the MD card or configuration
- (5) MD card was removed from the UCMB.

Note: If the install mode cannot be established although the battery is connected to the UCMB, the software may have not been installed in the MD card and the MD card may have not been initialized. In this case, initialize the MD.

5-2-2. Procedure

- 1) Turn on the control power.
- 2) Place the CNC in the install mode.
 - Place the MODE toggle switch in the INSTALL frame at the UCMB in the "I" position.
 - Press the RESET switch.

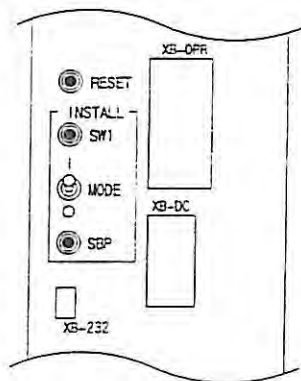

- The following main menu of the install mode is displayed.

```
[MAIN MENU] V4. 01 - A (ENG)

1.  INSTALL
2.  FR -INSTALL
3.  MD -INSTALL
4.  MAINTENANCE

INSTALL PROGRAM V4. 01 - A (ENG)
OKUMA 1997. 10. 31

Please select a number. (1/2/3/4) !_
```

3) Select "4. MAINTENANCE".

- The following maintenance tool menu is displayed.

```
[Maintenance tool]

1.  User file backup          6.  Battery exchange preparation
2.  System data backup       7.  Battery exchange restoration
3.  Replace                   8.  Initialize memory disk
4.  System data store
5.  User file store

MAINTENANCE TOOL V1. 00 - A (ENG)
OKUMA 1997. 10. 27

Please select a number. (1/2/3/4/5/6/7/8) !_
```

4) Select "8. Initialize memory disk".

```
[Maintenance tool]

1.  User file backup          6.  Battery exchange preparation
2.  System data backup       7.  Battery exchange restoration
3.  Replace                   8.  Initialize memory disk
4.  System data store
5.  User file store

Please select a number. (1/2/3/4/5/6/7/8) !8

Do you want to start memory disk initialize? (Y/N) !Y

Please input a present date.
date (Y. M. D) !97. 10. 10

Please input a present time.
time (H:M:S) !11:15:00

System initialize memory disk
Are you sure? (Y/N) !Y
```

5) The messages change as "doing" "completed"

With this, the MD initialization processing is complete.

Install the software in the MD again.

NOTICE

: If the MD is initialized, all contents in the MD such as system data and user files are lost. The necessary data must be backed up before initializing the MD.

5-3. Data Backup

5-3-1. Cases Requiring Data Backup Operation

When installing the software in the memory disk (C-MOS memory) for the machine where the control software has been installed and the NC has ever operated, it is necessary to back up the data. If the software is installed in the memory disk, the memory disk is cleared, parameters are reset to the default values, and all part programs are deleted. Therefore, the necessary data must be saved to the backup disk before installing the software in the memory disk; after the installation of the software, the backup data should be loaded to the memory disk to restore the previous status.

The data that requires backup are indicated below.

- (1) System data such as zero offset, tool offset, and parameters
- (2) Part program files such as part programs, subprograms, and schedule programs

[Supplement] When installing the software for the first time, this data backup operation is not necessary.

5-3-2. Backup of the System Data

Backup operation of the system data stores the files having the following extensions in the system backup floppy disk.

- *.PBU
- *.PAR
- *.UTY

All of the files indicated above are not existent in the system depending on the machine specifications.

5-3-3. Backup of the User Files

Save the user files in MD1: to the work floppy disk.

5-3-4. Backup Procedure

- 1) Turn on the control power.
- 2) Place the CNC in the install mode.
 - Place the MODE toggle switch in the INSTALL frame at the UCMB in the "I" position.
 - Press the RESET switch.
 - The following main menu of the install mode is displayed.

[MAIN MENU] V4. 01 - A (ENG)

1. INSTALL
2. FR - INSTALL
3. MD - INSTALL
4. MAINTENANCE

INSTALL PROGRAM V4. 01 - A
OKUMA 1997. 10. 31

Please select a number. (1/2/3/4) !_

3) Select "4. MAINTENANCE".

- The following maintenance tool menu is displayed.

```
[Maintenance tool]

1.  User file backup      6.  Battery exchange preparation
2.  System data backup   7.  Battery exchange restoration
3.  Replace               8.  Initialize memory disk
4.  System data store
5.  User file store

MAINTENANCE TOOL V1. 00 - A (ENG)
OKUMA 1997. 10. 27

Please select a number. (1/2/3/4/5/6/7/8) !_
```

4) Store the user files in the backup disk.

- Set a work disk used to back up the user files into the floppy disk drive.
- Select "1. User file backup" and follow the instructions displayed in the screen to store the user files in the backup floppy disk.

```
[Maintenance tool]

1.  User file backup      6.  Battery exchange preparation
2.  System data backup   7.  Battery exchange restoration
3.  Replace               8.  Initialize memory disk
4.  System data store
5.  User file store

Please select a number. (1/2/3/4/5/6/7/8) !1

Please press [Write] key after inserting a user
file backup floppy.
May user files be backed up on a floppy? (Y/N) !Y
(File name)
:
Backup of user files were completed.

Please select a number. (1/2/3/4/5/6/7/8) !_
```

5) Store the system data to the backup disk.

- Set a work disk used to back up the system data into the floppy disk drive.
- Select "2. System data backup" and follow the instructions displayed in the screen to store the system data in the backup floppy disk.

NOTICE : The system data backup operation deletes the existing files in the floppy disk unconditionally.

[Maintenance tool]

- | | |
|-----------------------|---------------------------------|
| 1. User file backup | 6. Battery exchange preparation |
| 2. System data backup | 7. Battery exchange restoration |
| 3. Replace | 8. Initialize memory disk |
| 4. System data store | |
| 5. User file store | |

Please press [WRITE] key after inserting
a system backup floppy

May system data of memory be backed up on a floppy? (Y/N) !Y
(File name)

:

Backup of system data were completed.

Please select a number. (1/2/3/4/5/6/7/8) !_

5-4. Installing the Control Software

5-4-1. Use Order of Floppy Disks

When installing the software, the order of setting floppy disks is important. Install the software by setting the floppy disks in the order shown in the floppy disk label.

Floppy disk setting order is indicated in < / > at the upper right part in the label.

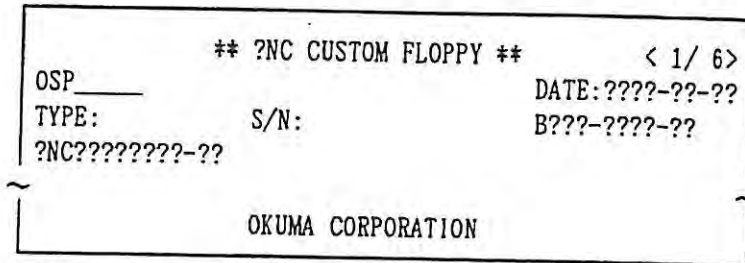

Floppy disks of the standard specifications are identified by the installation order numbers as shown below.

< 1/6 >	1st FD	NC custom floppy disk	(?NC CUSTOM FLOPPY)
< 2/6 >	2nd FD	System package floppy disk	(SYSTEM PACKAGE FLOPPY)
< 3/6 >	3rd FD	NC package floppy disk	(?NC PACKAGE FLOPPY)
< 4/6 >	4th FD	MacMan package floppy disk	(? MACMAN PACKAGE FLOPPY)
< 5/6 >	5th FD	PLC custom floppy disk 1	(?PLC CUSTOM FLOPPY 1)
< 6/6 >	6th FD	PLC custom floppy disk 2	(?PLC CUSTOM FLOPPY 2)

The number of package floppy disks varies according to the selected options. If total number of floppy disks is "n", the configuration of floppy disks is as indicated below

< 1/n >	1st FD	NC custom floppy disk	(?NC CUSTOM FLOPPY)
< 2/n > to < (n-2)/n >	2nd FD to 3rd FD from the last	Package floppy disks	(PACKAGE FLOPPY)
< (n-1)/n >	2nd FD from the last	PLC custom floppy disk	(?PLC CUSTOM FLOPPY 1)
< n/n >	Last FD	PLC custom floppy disk	(?PLC CUSTOM FLOPPY 2)

5-4-2. Operation Procedure

INSTALL Mode

- 1) Turn on the control power.
- 2) Place the CNC in the install mode.
 - Place the MODE toggle switch in the INSTALL frame at the UCMB in the "I" position.
 - Press the RESET switch.
 - The following main menu of the install mode is displayed.

```
[MAIN MENU] V4. 01 - A (ENG)

1.  INSTALL
2.  FR -INSTALL
3.  MD -INSTALL
4.  MAINTENANCE

INSTALL PROGRAM  V4. 01 - A (ENG)
OKUMA 1997. 10. 31

Please select a number. (1/2/3/4) !_
```

- 3) Select "1. INSTALL".
 - The following screen is displayed.

```
[INSTALL]

1:
2:
3:
Q:  MAIN MENU

Please select a number. (1/2/3) !1

Please insert a control - floppy.
Please press WRITE key after inserting a floppy.
Install procedure will be completed by [Q] key.
```

- 4) Install the floppy disks beginning with the first floppy disk. After completion of installation with the last PLC package floppy disk, key in "Q" to return the screen to the main menu.

```

[MAIN MENU] V4. 01 - A (ENG)

1.  INSTALL
2.  FR -INSTALL
3.  MD -INSTALL
4.  MAINTENANCE

-----
CLOSEDEV FR2H:
Erasing ... completed.
Writing ... completed.
Erasing ... completed.
Writing ... completed.

Please select a number. (1/2/3/4) !_

```

- 5) Return the MODE toggle switch in the INSTALL frame at the UCMB in the "O" position.
- 6) If the software cannot be installed by following the steps indicated above, the memory may have not been initialized. In this case, initialize the memory by following the steps explained in 5-2. "MD Initialization Processing".

This completes the installation of the software. Load the backup data if necessary by following the steps explained in 5-5. "Loading the Backup Data".

NOTICE

- : (1) Install the software in the order indicated in the floppy disk labels.
- (2) Do not turn the power off while installing the software. If the power has to be turned off, install the software from the beginning again.
- (3) After the completion of installation, always input "Q". The data is established by the input of "Q". If the power is turned off before inputting "Q", the CNC cannot start normally.

5-5. Loading the Backup Data

By loading the data and files backed up to the system backup floppy disk and the work disk to MD0: and MD1:, the previous state can be restored.

For the machine for which the software is installed for the first time, loading of the backup data is not necessary.

5-5-1. Backup Data Loading Procedure

- 1) Turn on the control power.
- 2) Place the CNC in the install mode.
 - Place the MODE toggle switch in the INSTALL frame at the UCMB in the "I" position.
 - Press the RESET switch.
 - The following main menu of the install mode is displayed.

```
[MAIN MENU] V4. 01 - A (ENG)

1.  INSTALL
2.  FR -INSTALL
3.  MD -INSTALL
4.  MAINTENANCE

INSTALL PROGRAM V4. 01 - A (ENG)
OKUMA 1997. 10. 31

Please select a number. (1/2/3/4) !_
```

- 3) Select "4. MAINTENANCE".
 - The following maintenance tool menu is displayed.

```
[Maintenance tool]

1.  User file backup           6.  Battery exchange preparation
2.  System data backup        7.  Battery exchange restoration
3.  Replace                    8.  Initialize memory disk
4.  System data store
5.  User file store

MAINTENANCE TOOL V1. 00 - A (ENG)
OKUMA 1997. 10. 27

Please select a number. (1/2/3/4/5/6/7/8) !_
```

4) Load the backed up system data.

- Insert the system data backup floppy disk to the floppy disk drive.
- Select "4. System data store" from the maintenance tools and load the system data by following the instructions displayed on the screen.

```
[Maintenance tool]

1.  User file backup           6.  Battery exchange preparation
2.  System data backup        7.  Battery exchange restoration
3.  Replace                   8.  Initialize memory disk
4.  System data store
5.  User file store

Please select a number. (1/2/3/4/5/6/7/8) !4

Please press [WRITE] key after inserting
a system backup floppy
May system data of a floppy be stored on memory? (Y/N) !Y
(File name) <-(File name)
:
Stores of system data were completed.

Please select a number. (1/2/3/4/5/6/7/8) !_
```

5) Load the user files.

- Insert the user file backup floppy disk to the floppy disk drive.
- Select "5. User file store" from the maintenance tools and load the user files by following the instructions displayed on the screen.

```
[Maintenance tool]

1.  User file backup           6.  Battery exchange preparation
2.  System data backup        7.  Battery exchange restoration
3.  Replace                   8.  Initialize memory disk
4.  System data store
5.  User file store

Store of system data were completed.

Please select a number. (1/2/3/4/5/6/7/8) !5

Please press [WRITE] key after inserting a user
file backup floppy.
May user files of a floppy be stored on memory? (Y/N) !Y
(File name) <-(File name)
:
Stores of user files were completed.

Please select a number. (1/2/3/4/5/6/7/8) !_
```

SECTION 9 CHANGING THE BATTERY

If the battery has been used to the life, it is necessary to change the battery to the new one.

A battery is used to hold the contents in the memory disk and if it discharges completely, user files, system data and other information in the memory disk are lost.

The UCMB has a large-capacity capacitor (super capacitor) which holds the contents of the memory disk while the battery is changed; the capacitor is re-charged by turning the control power on.

When changing the battery, back up the user files and system data before disconnecting the battery so that they can be restored even when battery change is not successful.

NOTICE

: The capacitor can retain the disk memory data for one hour.
Change the battery within this period.

1. Battery Life Warning

According to the status of battery voltage, three levels of warning messages are given.

(1) Requiring Battery Change

The following message is displayed.



: Alarm-D Memory board/battery change

When the battery use time reached the preset time, or if the battery voltage becomes lower than the specified voltage, this message is displayed.

If this message is displayed, change the battery as soon as possible according to the procedure explained in 2 "Changing the Battery".

(2) Requiring Immediate Battery Change

The following message is displayed.



: Alarm-A Memory board/battery hurry exchange

This message is displayed if the battery has been kept used for 10 days since the display of the warning message indicated in (1).

If this message is displayed, change the battery immediately according to the procedure explained in 2 "Changing the Battery".

(3) Battery Life and System Down

The following message is displayed.



: Alarm-P Memory board/battery life

This message is displayed if battery voltage is lowered below the battery life voltage.

In this state, contents of the system data and the user files stored in the memory disk are not guaranteed. Even if they are backed up in the install mode, the contents of the backed up data cannot be guaranteed.

To restore the operation, install the control software after changing the battery then set the system data again.

2. Changing the Battery

< Procedure >

- 1) Back up the system data and the user file by following the procedure described in 5-3. "Data Backup" in Section 8.
- 2) Prepare the tools necessary for changing the battery.

- Control enclosure key
- Philips head screwdriver (No. 2)
- New battery unit
- Nipper
- Cable ties

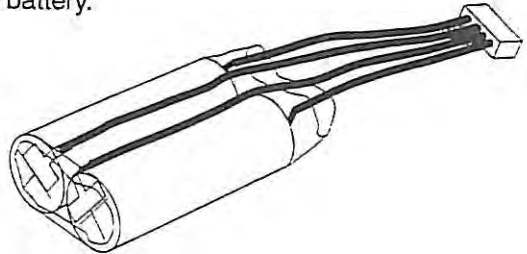

Fig. 9-1 Battery unit

- 3) Place the CNC in the install mode.
 - Place the MODE toggle switch in the INSTALL frame at the UCMB in the "I" position.
 - Press the RESET switch.
 - The following main menu of the install mode is displayed.

```
[MAIN MENU] V4. 01 - A (ENG)

1.  INSTALL
2.  FR -INSTALL
3.  MD -INSTALL
4.  MAINTENANCE

INSTALL PROGRAM V4. 01 - A (ENG)
OKUMA 1997. 10. 31

Please select a number. (1/2/3/4) !_
```

4) Select "4. MAINTENANCE".

- The following maintenance tool menu is displayed.

```
[Maintenance tool]

1. User file backup      6. Battery exchange preparation
2. System data backup   7. Battery exchange restoration
3. Replace               8. Initialize memory disk
4. System data store
5. User file store

MAINTENANCE TOOL V1. 00 - A (ENG)
OKUMA 1997. 10. 27

Please select a number. (1/2/3/4/5/6/7/8) !_
```

5) Select "6. Battery exchange preparation".

- Follow the instructions displayed on the screen to prepare for changing the battery.

```
[Maintenance tool]

1. User file backup      6. Battery exchange preparation
2. System data backup   7. Battery exchange restoration
3. Replace               8. Initialize memory disk
4. System data store
5. User file store

Please select a number. (1/2/3/4/5/6/7/8) !6

Do you exchange battery?
Were user files backed up? (Y/N) !Y
Were system data backed up? (Y/N) !Y
System is charging condenser.
Please wait for a while. .... completed

Turn off a power, and please rapidly exchange battery.
```

[Supplement] If you input "N", the screen returns to the maintenance tool menu screen.

- 6) Change the battery.
- Turn off the power and change the battery.

Remove the machine screw at (a) and change the battery unit.

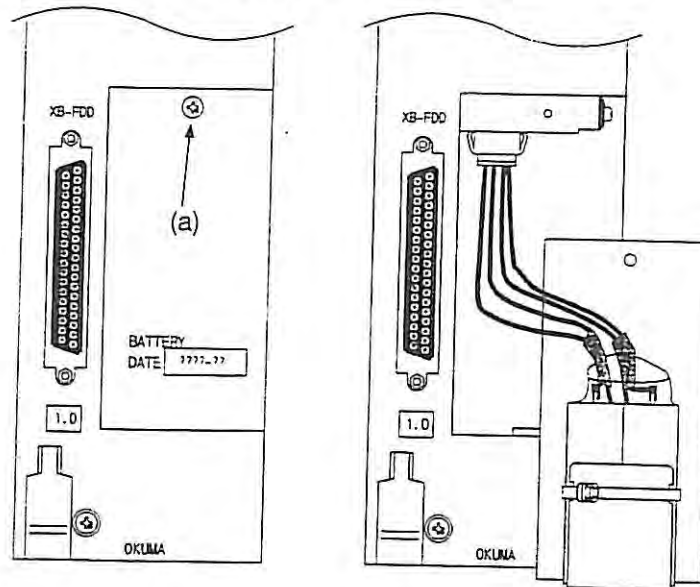

Fig. 9-2

- 7) Restore the CNC.
- Display the maintenance tool menu following steps 3) and 4) and select "7. Battery exchange restoration".
 - Follow the instructions displayed on the screen to restore the CNC.

[Maintenance tool]

1. User file backup	6. Battery exchange preparation
2. System data backup	7. Battery exchange restoration
3. Replace	8. Initialize memory disk
4. System data store	
5. User file store	

Please select a number. (1/2/3/4/5/6/7/8) !7

Was battery exchange?
Memory check OK
battery voltage OK
Battery life alarm cancellation.
Battery exchange was completed.

Please select a number. (1/2/3/4/5/6/7/8) !_

- If the battery change has completed normally as shown above, it is not necessary to load the backup system data and user files.

- If the result of memory check is abnormal, the following message is displayed.

Data of a memory disk have disappeared.

To restore the CNC in this state, it is necessary to initialize the memory disk and install the software. After installing the software, load the system data and user files from the backup disks.

- If the result of battery voltage check is abnormal, the following message is displayed.

Battery voltage insufficiency.

System is charging condenser.

Please wait for a while. completed

Turn off a power, please confirm battery is exchanged rightly.

If this message is displayed, check the connection of the battery lead connector and the battery itself. After making sure the cause of the problem, change the battery again.

- 8) Turn on the power.

- Place the MODE toggle switch in the INSTALL frame at the UCMB in the "O" position.
- Turn on the control power again.

SECTION 10 APPENDIX

1. Accessories

The following items are supplied with the control enclosure. Since these items are necessary for the service by Okuma, please keep them in places where they are stored when the machine is delivered.

- Check sheet (control system)
- OSP control card
- Floppy disks

1-1. Check Sheet (Control System)

The check sheet shows the results of inspection and the information on after-sale services of the CNC.

1-2. OSP Control Card

The file includes software control card, hardware control card, and data sheet.

The data sheet keeps the record of the system-related parameter data, set at the shipping of the machine.

1-3. Floppy Disks

One set of OSP control floppy disks is provided.

NOTICE

: Keep the following in mind when handling floppy disks.

- (1) Keep the floppy disks in the case when they are not used. The floppy disk case must be kept at the specified place inside the control enclosure; avoid exposure to high temperature, high humidity, and direct sunlight.
- (2) Do not attempt to open the floppy disk shutter.
- (3) Keep the write-protection tub in the "protected" position to protect the data from being deleted by mistake.
- (4) Set a floppy disk in the floppy disk drive correctly.
- (5) Keep away magnetism.

Less than 4000 A/M (50 Gauss)

- (6) Environmental requirements

Temperature: 10 to 50°C (50 to 122°F)

Humidity: 20 to 80%RH

2. NC Operation Panel

(1) NC Operation Panel with 14" CRT

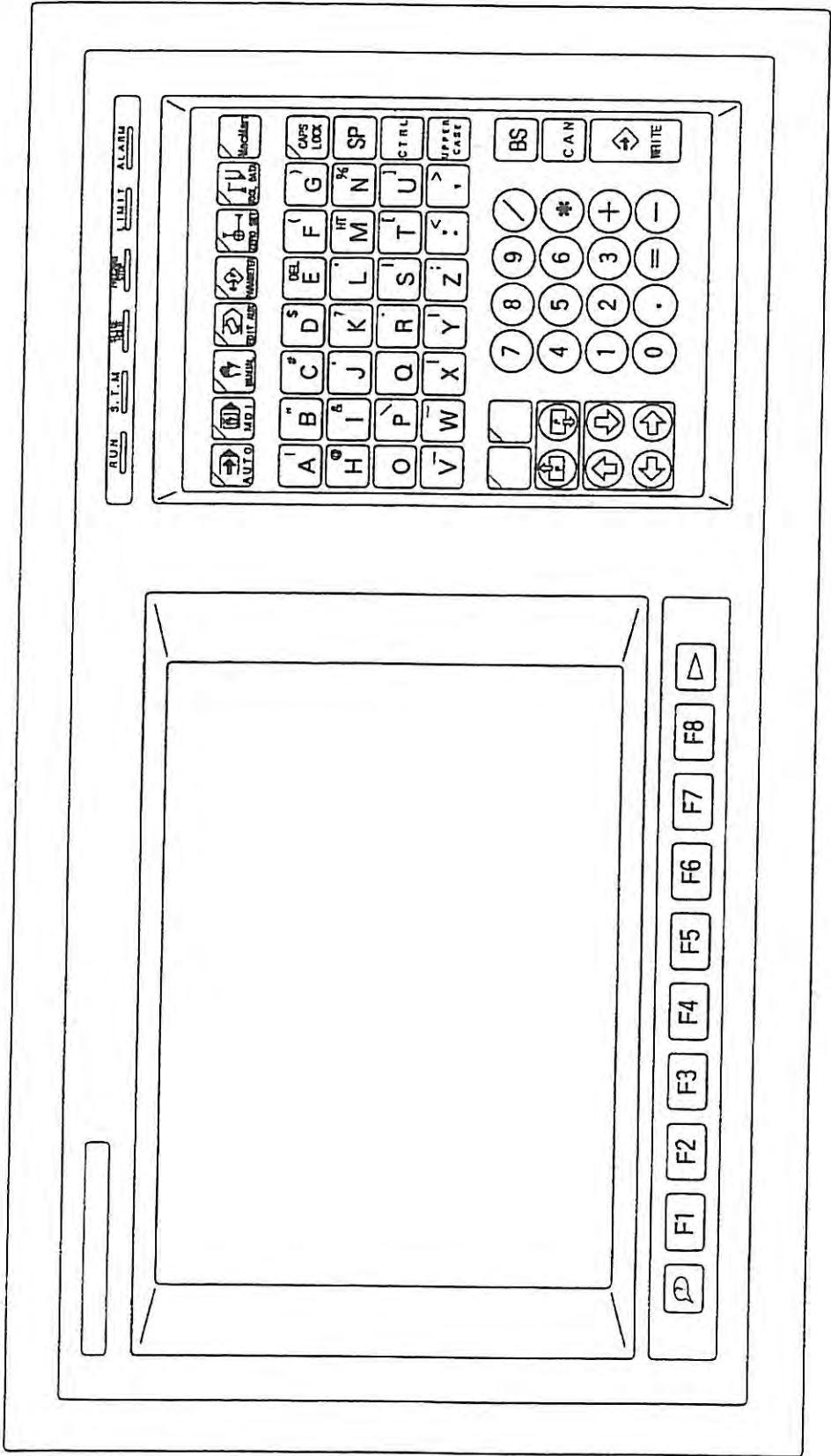

(2) NC Operation Panel with LCD (Horizontal Type)

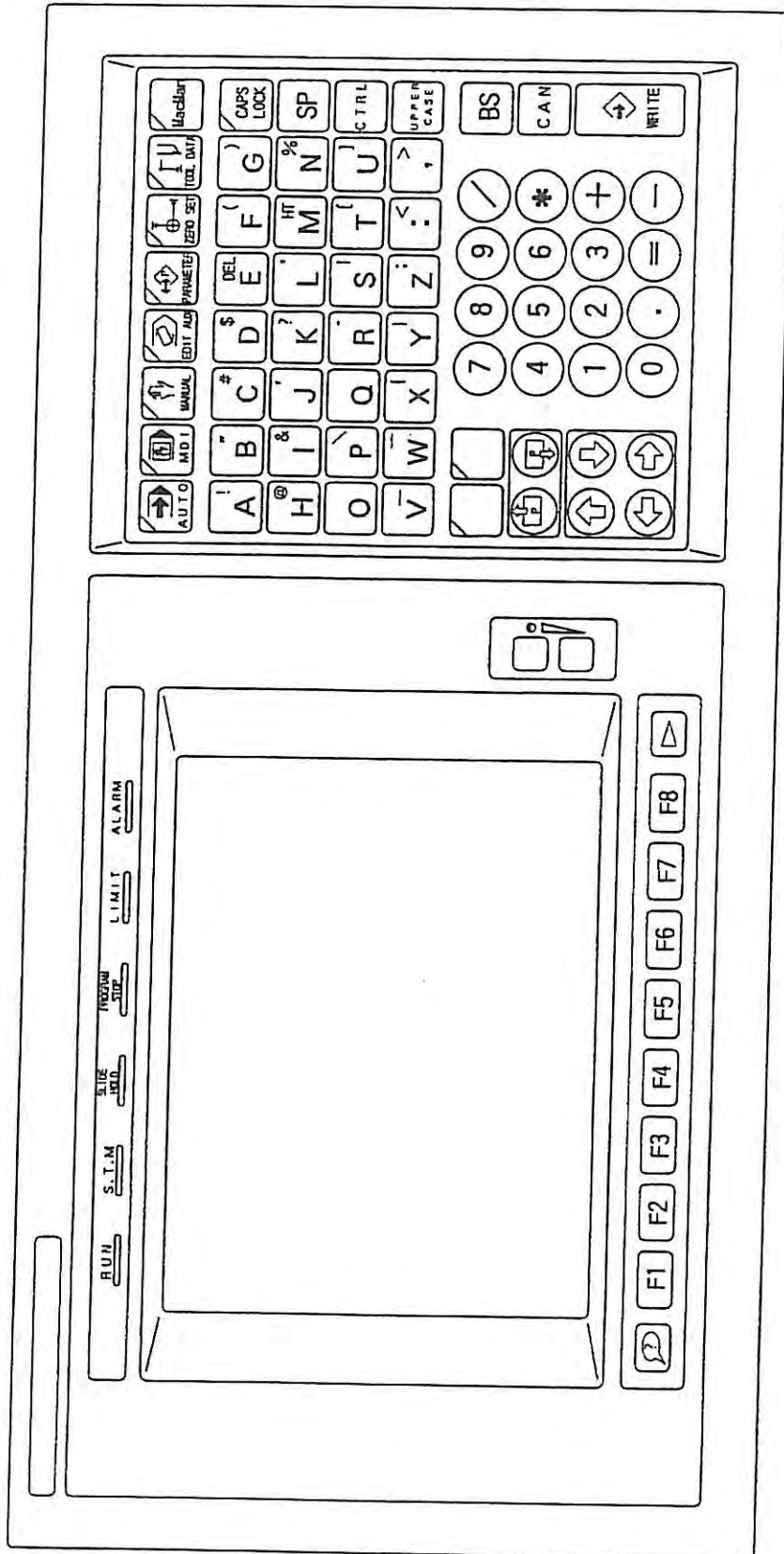

(3) NC Operation Panel with LCD (Vertical Type)

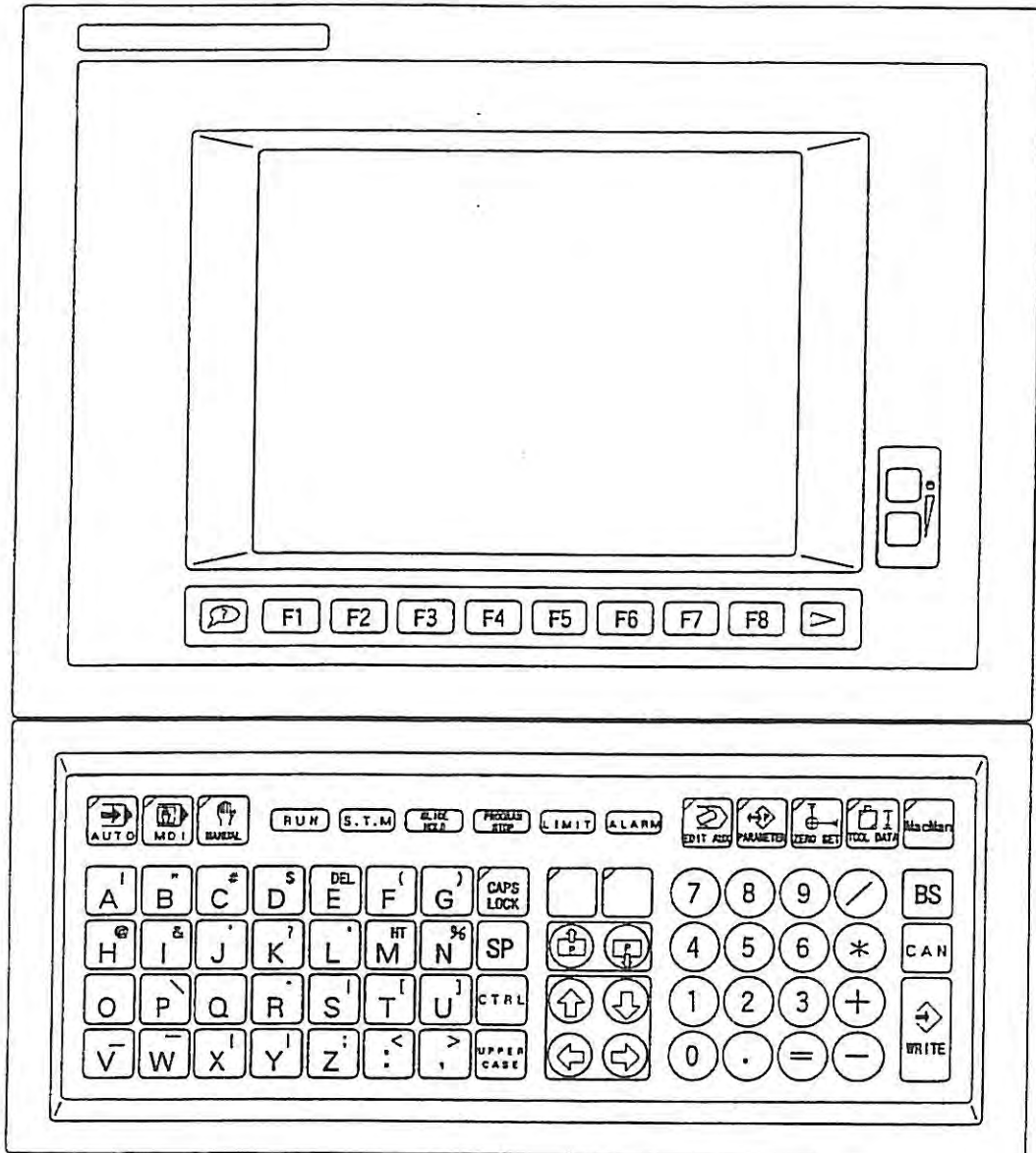

3. Machine Operation Panel

(1) Horizontal Type Machine Operation Panel

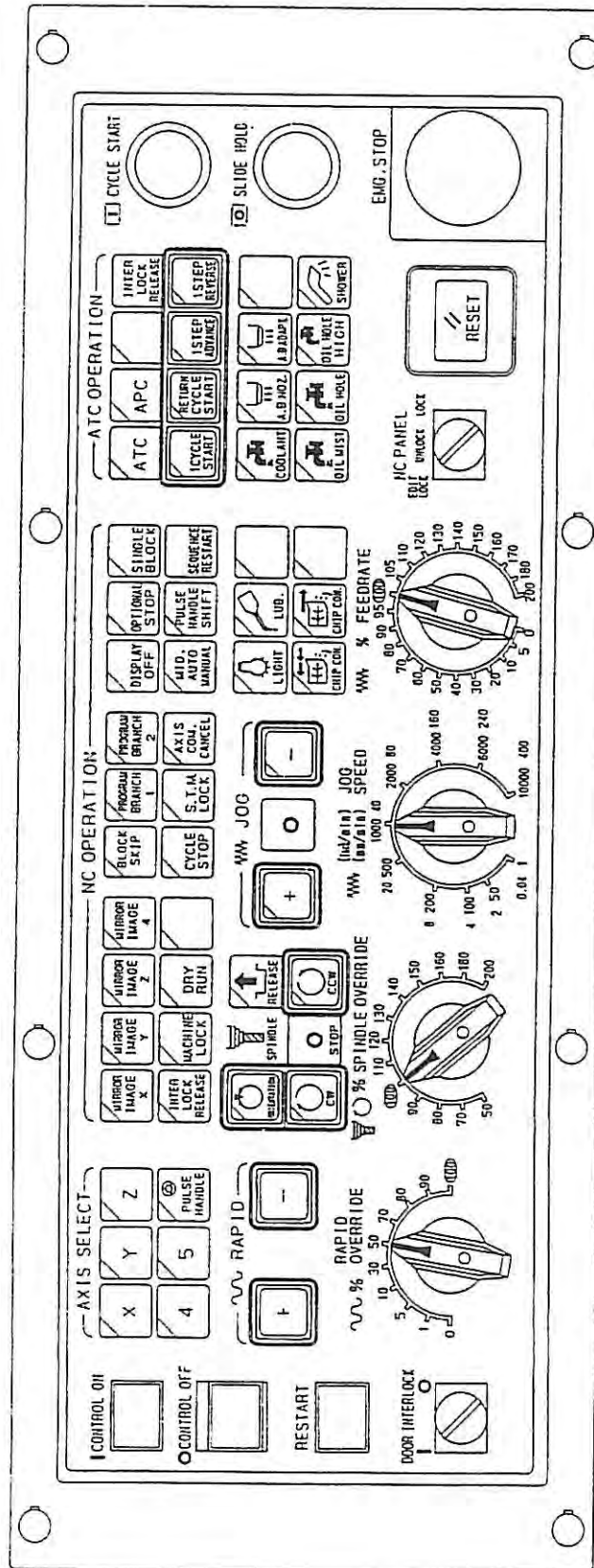

(2) Vertical Type Machine Operation Panel

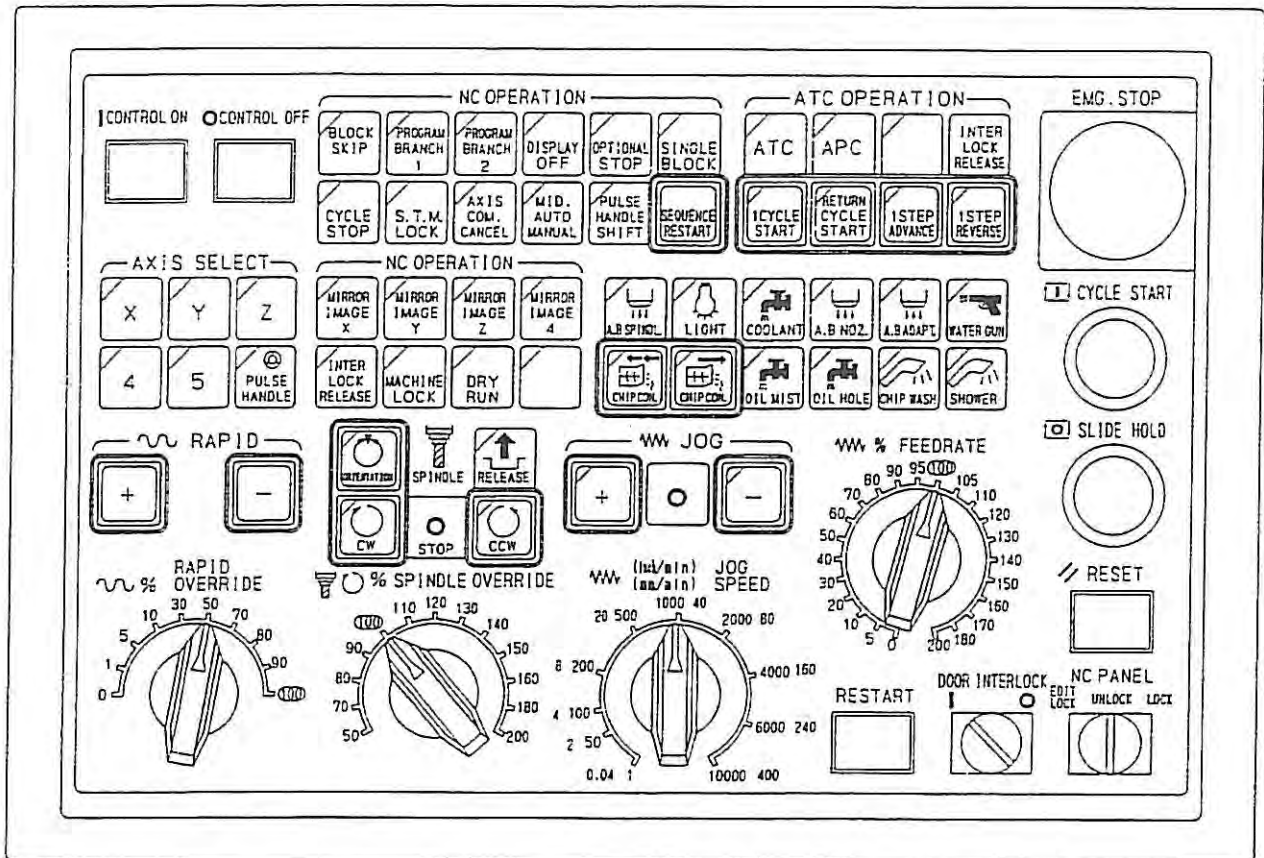

4. Other Operation Panels

(1) Pulse Handle

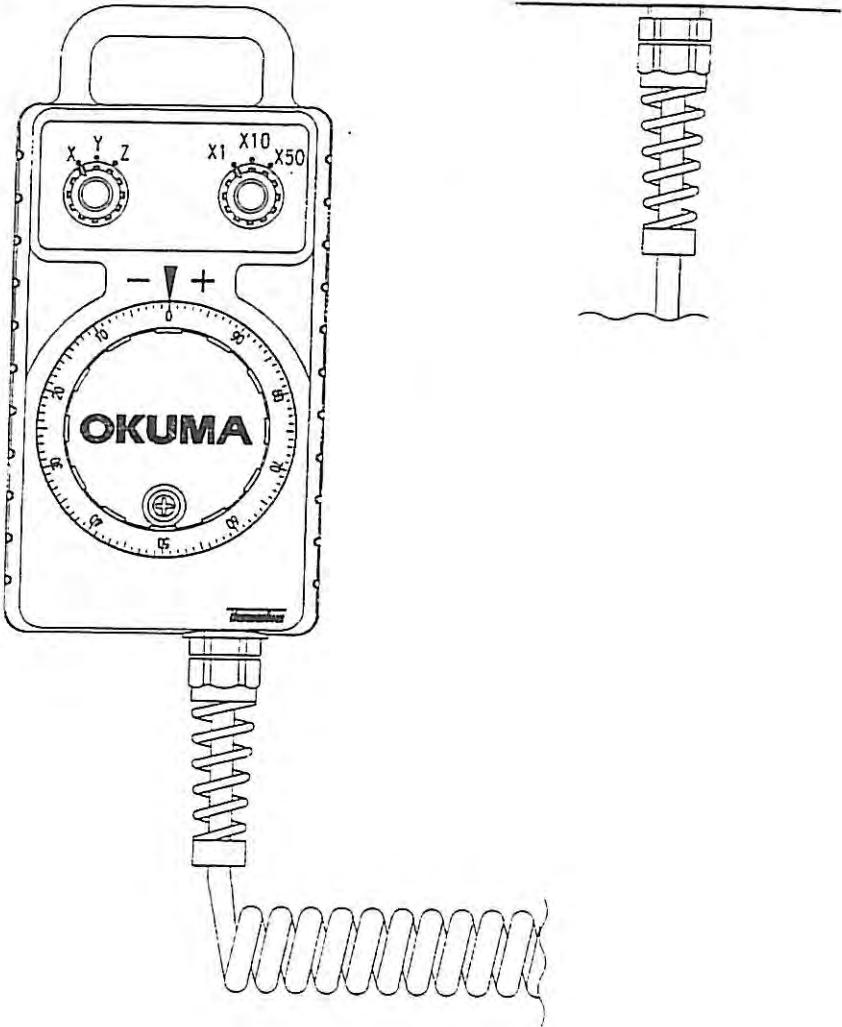

(2) Option Panel 1

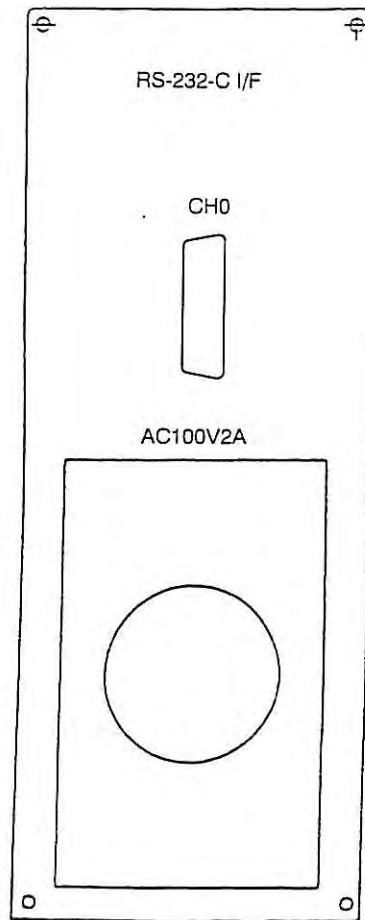

(3) Option Panel 2

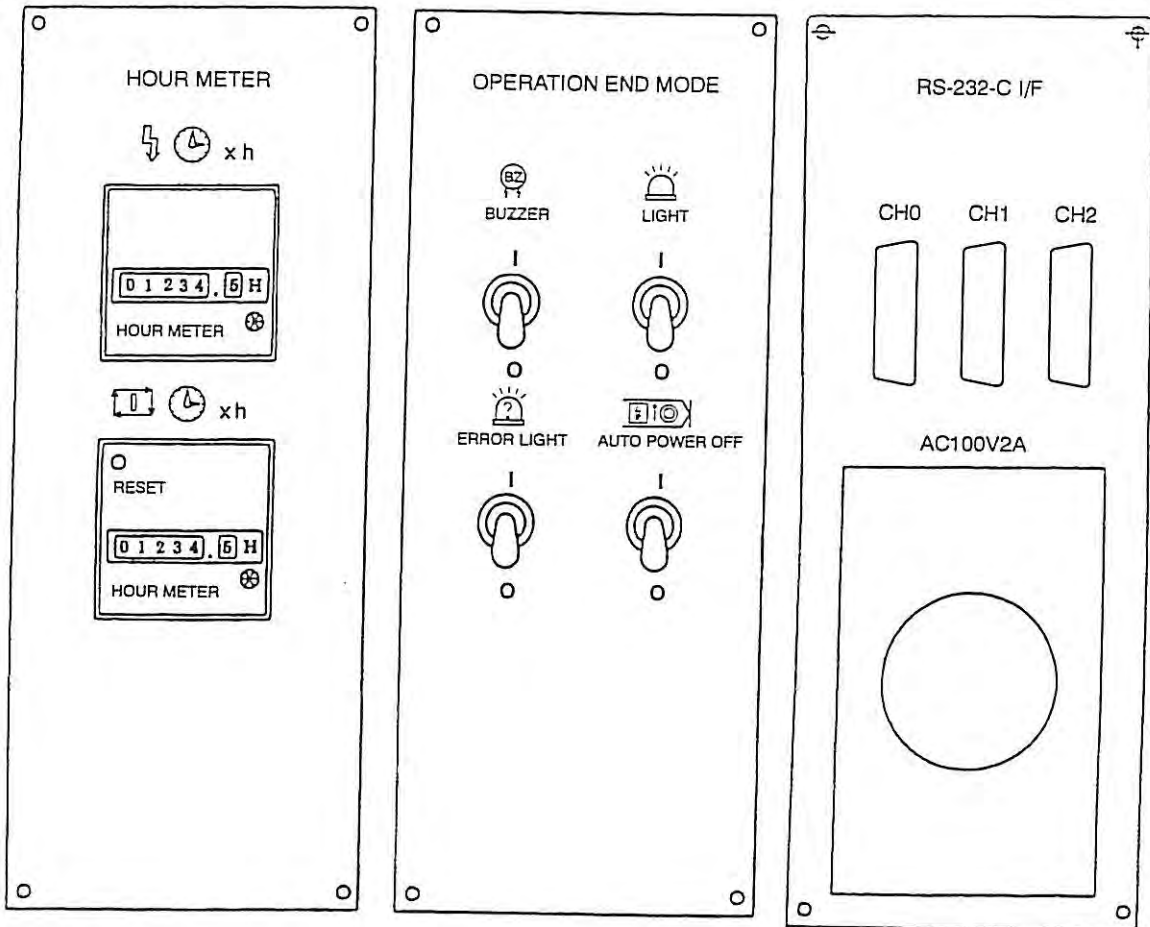

Hour Meter

Operation End Mode

Punch

(4) Manual Tool Change Operation Panel

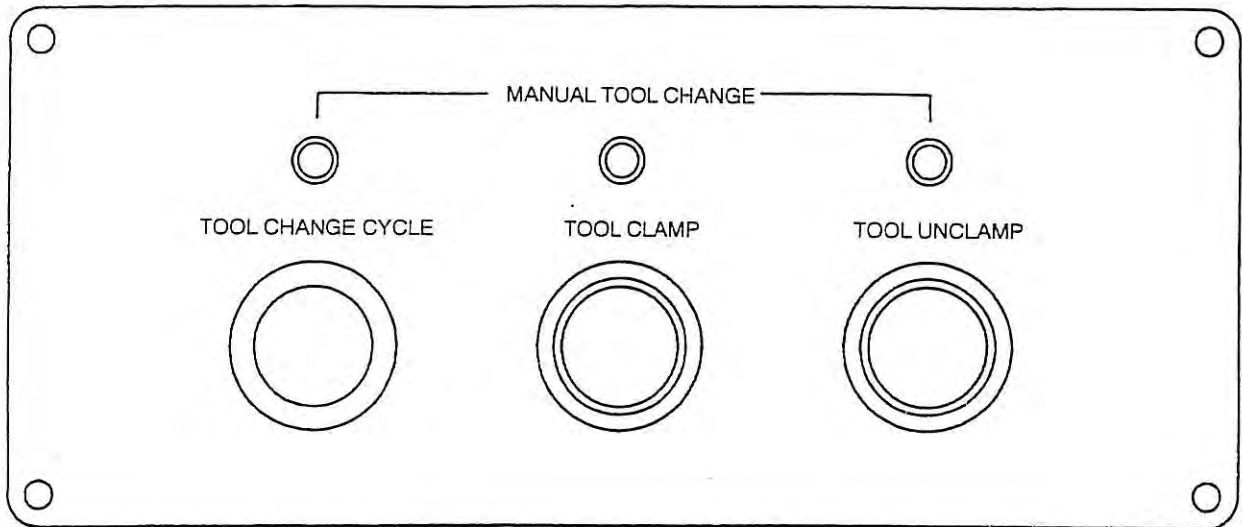

(5) Manual Magazine Operation Panel

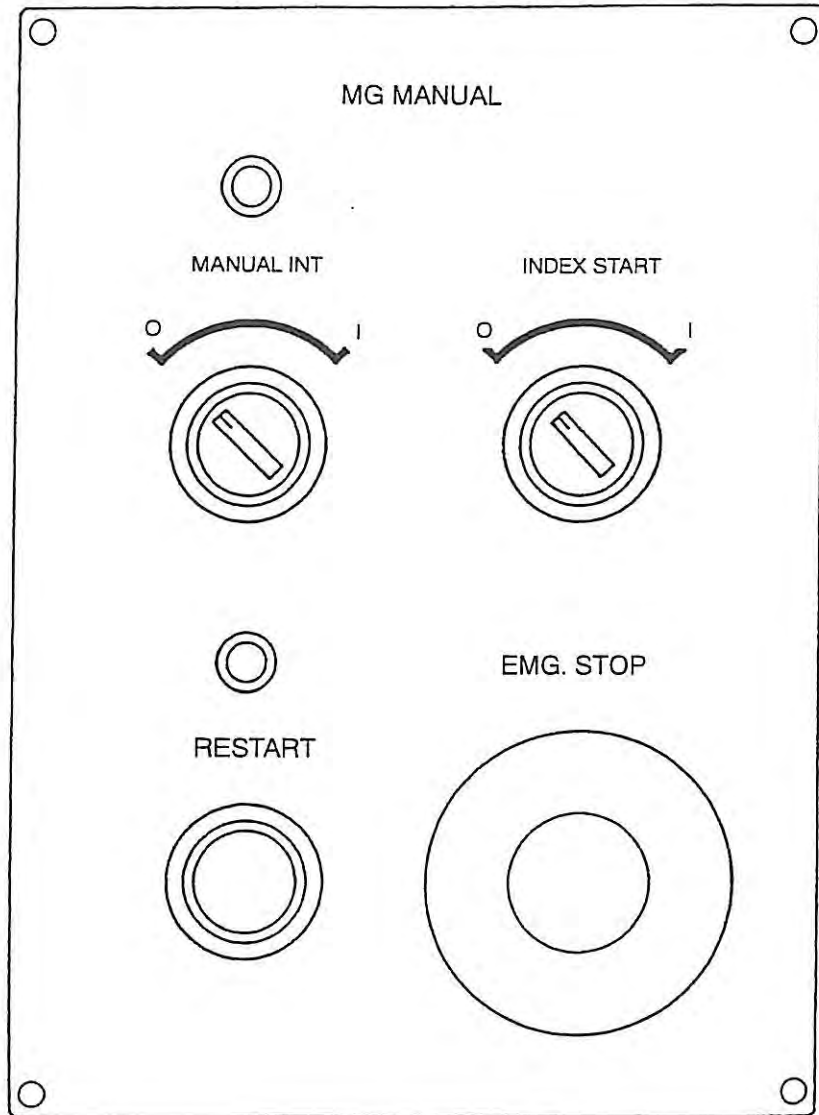

(6) APC Operation Panel for Parallel Type 2-pallet APC

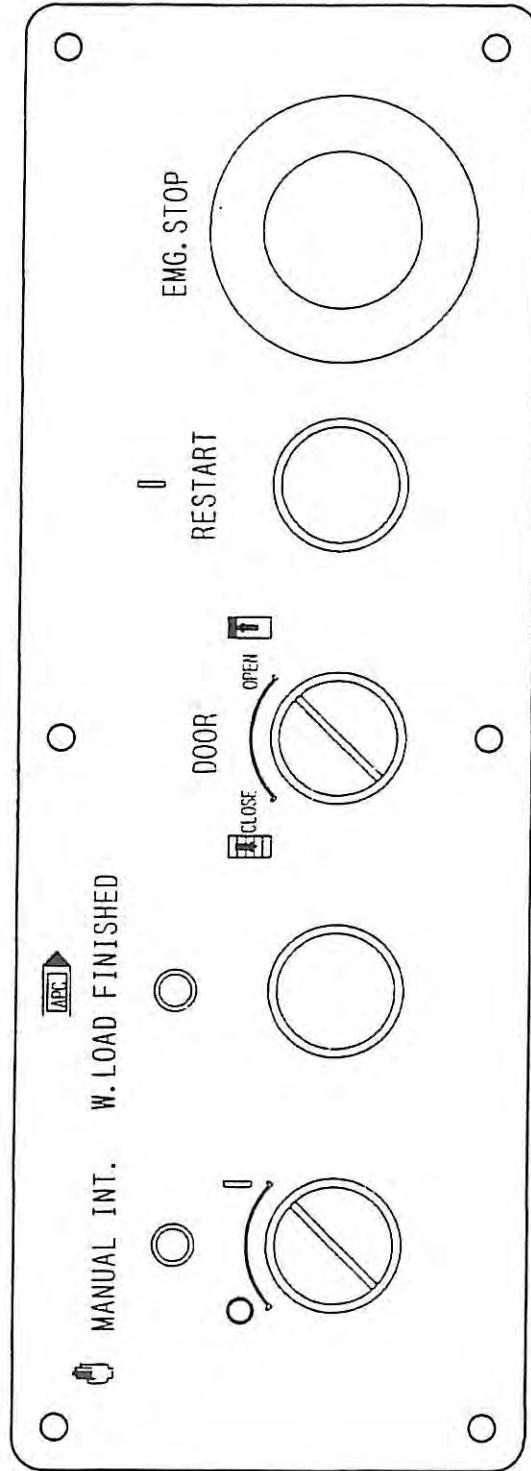

LIST OF PUBLICATIONS

Publication No.	Date	Edition
4194-E	May 1998	1st

This manual may be at variance with the actual product due to specification or design changes.

Please also note that specifications are subject to change without notice. If you require clarification or further explanation of any point in this manual, please contact your OKUMA representative.

OKUMA OFFICES

DOMESTIC OFFICES

REGISTERED OFFICES

1-32 Tsujimachi, Kita-ku
Nagoya 462-0032, Japan

WORLD HEADQUARTERS-OGUCHI PLANT

Okuma Corporation
Oguchi-cho, Niwa-gun Aichi, 480-0193, Japan
Phone (0587) 95-7825 Fax (0587) 95-6074 Telex 4573310 OKUMA J

KANI PLANT

Okuma Corporation
3-6 Himegaoka, Kani-shi, Gifu-ken, 509-0249, Japan
Phone (0574) 63-5611 Fax (0574) 63-5678

OVERSEAS OFFICES

Okuma Corporation ,Melbourne Liaison Office
c/o Atlas CNC Machines Ltd. 3 Tampe Road Rowvill, Victoria 3178 Australia
Phone (03) 9753-2848 Fax (03) 9753-2020

Okuma Corporation Singapore Branch
422 Tagore Avenue Singapore 2678
Phone 4590819 Fax 4598276

OVERSEAS AFFILIATE

Okuma America Corporation
12200 Steele Creek Road, Charlotte, NC 28273, U.S.A.
Phone (704) 588-7000 Fax (704) 588-6503

OVERSEAS SUBSIDIARIES

Okuma Europe GmbH
Europark, Fichtenhain A20
47807 Krefeld , F.R. of Germany
Phone (49) 2151-374-0 Fax (49) 2151-374100

Okuma Service Center TPE
Tatung Co., 22 Chungshan N. Rd.,3rd Sec.Taipei, Taiwan, 10451 R.O.C
Phone (02) 673-6901 Fax (02) 673-6900