

Operator's manual

BendMaster

TruBend Cell 5000

Operator's manual

BendMaster

TruBend Cell 5000

Original operator's manual

Edition **2015-06-01**

Order Information

Please specify when ordering this document:

Operator's manual

BendMaster

Edition 2015-06-01

Document number B579EN

Address for orders

TRUMPF Maschinen Austria GmbH + Co. KG

Technische Redaktion

Industriepark 24

A-4061 Pasching

Fon: +43 7221 603 - 0

Fax: +43 7221 603 - 50

Internet: <http://www.at.trumpf.com>

E-Mail: tat@at.trumpf.com

For "partly completed machinery" in accordance with the EC Machinery Directive, this document corresponds to the assembly instructions.

© TRUMPF Maschinen Austria GmbH + Co. KG

Before you proceed ...

This operator's manual documents the automation components BendMaster (60) and BendMaster (150) in the TruBend Cell 5000 bending cell for the automatic handling of sheets on the press brakes of the TruBend Series 5000.

The machine documentation includes:

- Spare parts catalog.
- Circuit diagrams.
- TruBend Series 5000 operator's manual.
- TruTops Bend software manual.
- Handling equipment operator's manual



Table of contents

Chapter 1 Safety

1	For your safety	1-3
2	Operational safety	1-5
2.1	Intended use	1-5
2.2	Authorized personnel	1-6
3	Hazards	1-7
3.1	Dangers due to the switch cabinet	1-7
3.2	Hazards due to laser radiation	1-7
3.3	Dangers from magnetic fields	1-8
	Mobile fanning magnet (option)	1-8
3.4	Hazards when dealing with workpieces	1-9
	Sharp-edged workpieces	1-9
	Dangers due to floating loads	1-9
3.5	Danger due to increased movement dynamics (optional productivity package)	1-11
3.6	Dangers due to unexpected movements	1-12
3.7	Dangers due to Teleservice	1-12
4	Measures to be taken by the manufacturer	1-13
4.1	Danger zones and safeguarding device	1-13
4.2	Danger signs on the machine	1-16
5	Organizational measures to be taken by the user	1-20
5.1	Observing warnings and danger signs	1-20
5.2	Training and instructing operators	1-20
	Measures applicable worldwide	1-20
5.3	Adhering to the duty of care when handling the machine	1-20
5.4	Pay attention to water protection	1-21
5.5	Using spare parts, accessories, software and operating materials	1-22

6	Overview of residual risks	1-24
7	Disassembly and disposal	1-26

Chapter 2 BendMaster installation conditions (60)/(150)

	Who does what?	2-3
1	Planning aid	2-4
2	Installation site	2-6
2.1	Space requirements	2-6
2.2	Floor requirements	2-6
	Surface	2-6
	Floor quality	2-8
2.3	Weight load	2-10
2.4	Stress due to vibration	2-11
2.5	Ambient conditions	2-11
3	Compressed air supply	2-13
4	Electrics	2-14
4.1	Electrical power supply	2-14
	Connected loads	2-14
	Connecting cables	2-15
4.2	Power supply	2-15
	Residual current device (RCD)	2-15
	Line structures	2-16
4.3	Network link	2-17
5	Transport	2-18
5.1	Preparing transport	2-18
	Transport dimensions	2-18
5.2	Permitted auxiliary tools	2-18
5.3	Checking, unloading and transporting the machine	2-20
	On delivery: check the machine	2-20

Chapter 3 Description

1	Machine concept	3-3
2	Technical data	3-4
2.1	BendMaster	3-4
2.2	BendMaster axes	3-5
3	The most important assemblies	3-6
3.1	Nameplate	3-6
3.2	Floor lane	3-7
3.3	Arm	3-7
3.4	BendMaster switch cabinet	3-7
3.5	Sheet sensor	3-8
3.6	Rotational transformer	3-9
3.7	Safety fencing	3-9
3.8	Control panel	3-9
3.9	Easy operation	3-10
3.10	Sensor gauge fingers at the TruBend Series 5000	3-11
	4-axis sensor gauge finger	3-12
	6-axis sensor gauge finger (optional)	3-13
	Backstop resistor	3-14
4	Options	3-15
4.1	Extendable floor lane	3-15
4.2	Gripper	3-15
	Vacuum gripper	3-15
	Multi-gripper	3-17
	Multiple-circuit suction cups	3-17
	Gripper construction kit	3-18
4.3	Special gripper	3-19
	Magnetic gripper	3-19
	Linear gripper	3-19
	Pivoted-jaw gripper and pivoted-jaw gripper with turning axis	3-20
4.4	Sheet removal station	3-21

4.5	Double sheet recognition and double sheet separation	3-22
	Double sheet recognition	3-23
	Double sheet separation	3-24
4.6	Regripping station	3-24
4.7	Gripper changing console	3-25
4.8	Backlighting table	3-25
4.9	Productivity package	3-26
4.10	Mobile fanning magnet	3-27
4.11	Handling equipment	3-27
4.12	Store connection	3-28
4.13	TruTops°Bend	3-29
5	Options at the TruBend	3-30

Chapter 4 Operation

1	Description of the operating elements	4-6
1.1	Portable manual control unit	4-6
	Operating elements	4-6
	Menus and submenus	4-7
1.2	Control panel	4-9
1.3	Stationary 19" screen	4-10
2	Operating the BendMaster	4-11
2.1	Safety information	4-11
2.2	Status display	4-11
2.3	Software versions view	4-13
2.4	User settings	4-13
	Changing settings	4-13
	Creating BIO (BendMaster Information Object)	4-15
	Creating and modifying users	4-15
2.5	Operating modes	4-16
	Selecting operating modes	4-17
	Enabling conditions for operation modes	4-17
2.6	Moving axes of the BendMaster manually	4-22
2.7	Displaying axis positions	4-26
2.8	Gripper service	4-27

2.9	Automatic gripper change (option)	4-28
	Picking up a gripper	4-28
	Lay down gripper	4-31
2.10	Regripping station (option)	4-32
	Moving the axes of the regripping station manually	4-32
	Setting up the regripping station	4-33
	Removing the regripping station	4-35
2.11	Setting the backstop resistor regardless of the program	4-36
3	Switching on and referencing the BendMaster	4-38
3.1	Switching on the BendMaster	4-38
3.2	Referencing the BendMaster	4-39
	Referencing the Z, A, B, C, Z1, Z2 axes	4-40
	Referencing the D axis	4-41
3.3	Referencing TruBend	4-42
4	Switching off the BendMaster	4-46
4.1	Stopping BendMaster and TruBend in any emergency or after a malfunction	4-46
4.2	BendMaster, switching off	4-46
5	Travel functions	4-48
5.1	Executing travel functions	4-48
6	Running in a TruTops program	4-50
6.1	From BendMaster control V7.0 and higher: Settings in TruTops Bend	4-50
6.2	Procedure for productivity package option	4-50
	Checking the productivity package	4-50
	Calculating suction cup capacities	4-51
	Determining the reduction of the robot speed	4-52
6.3	Overview, loading a program	4-52
6.4	Creating a new BendMaster job from the TruTops Bend program	4-53
6.5	Archiving, restoring or deleting jobs	4-55
	Filing away a job	4-56
	Restoring an order	4-56
	Deleting a job	4-57

	Changing the backup directory path on the user interface	4-58
6.6	Defining job details	4-59
	Defining exposure details	4-59
	Editing the gripper weight	4-61
6.7	Loading and unloading areas	4-62
	Load job	4-64
	Adjusting an area	4-64
	Copying an area	4-67
	Deleting an area	4-68
	Displaying the area position	4-68
	Displaying the area position	4-69
	Defining area details	4-69
6.8	Performing the rough recognition process (Search within area)	4-72
	Searching for an area	4-72
	Searching for further loading stacks	4-76
	Intermediate layer, searching for	4-77
	Procedure in the event of problems with the rough recognition	4-77
6.9	Defining stacks	4-78
6.10	Processing stacks	4-80
6.11	Creating a tooling plan	4-84
	Checking the TruTops tooling plan	4-84
	Selecting a separation method	4-85
	Selecting double sheet recognition	4-87
6.12	Setting bending parameters	4-88
	Opening bending parameters	4-89
	Selecting bending support	4-90
	Setting the backgauge sensor system	4-90
	Setting the approach strategy	4-91
	Setting the backstop resistor for single bending operations	4-92
6.13	Program, loading	4-92
	Opening the running in program	4-92
	Program steps for running in	4-93
	Selecting an execution method	4-94
	Running in procedure	4-94
	Teaching a point	4-96
	Points, editing	4-96
	Setting the main run indicator manually	4-98
	Deleting a point	4-99

	Displaying axis positions	4-100
6.14	Starting a run-in program	4-100
6.15	Production planning	4-102
	Creating or modifying a production plan	4-102
	Setting the speed and required number	4-103
	Executing the production plan	4-104
6.16	Connection to storage (option)	4-105
	Defining parts data	4-105
	Defining loading and unloading areas of the storage stations	4-105
	Moving a storage cart manually	4-106
	Moving the BendMaster semi-automatically	4-106
	Moving a storage cart in automatic mode	4-108
7	Working at the press brake without BendMaster	4-110
7.1	Working at the press brake without BendMaster	4-110
8	Errors and Messages	4-111
8.1	Displaying and acknowledging errors and messages	4-111
8.2	Troubleshoot an error	4-111
9	Error handling	4-113
9.1	Jumpering the sensor finger	4-113
9.2	Image processing diagnostics	4-113
	Opening the diagnostics tool	4-119
	Recording with Vision Diagnostics	4-121
	Saving the image recorded last	4-124
	Restarting the program	4-125
9.3	Teleservice	4-125
10	Solving problems and troubleshooting	4-126
10.1	Problem: no part recognized	4-126
	Solution: no part identified	4-127
10.2	Problem: Part underneath detected	4-128
	Solution: part underneath detected	4-129
10.3	Problem: part interference contour recognized	4-130
	Solution: interference contour recognized	4-131

Chapter 5 Maintenance (customer)

1	General guidelines	5-3
2	Maintenance Overview	5-5
3	Lubrication	5-6
3.1	Overview	5-6
3.2	Maintenance Instructions	5-7
	BendMaster: Z slide	5-7
	Regripping station (option)	5-8
4	Mechanical elements	5-10
4.1	Maintenance Instructions	5-10
	Safety fencing	5-10
	Lift gate	5-10
	Transport equipment (option): transport belt	5-11
	BendMaster: Z axis	5-11
	Regripping station	5-12
	Sheet removal station	5-13
	Press brake: sensor gauge finger	5-13
	Gripper changing console (option)	5-14
	BendMaster: pivoted-jaw gripper (option)	5-15
5	Electrical components	5-16
5.1	Overview	5-16
5.2	Maintenance Instructions	5-17
	BendMaster: control cabinet	5-17
	BendMaster: switch cabinet	5-18
	BendMaster: fan in the C arm	5-20
	BendMaster: fan, Z slide	5-21
6	Optical components	5-22
6.1	Overview	5-22
6.2	Maintenance Instructions	5-22
	BendMaster: sheet sensor	5-22

7	Pneumatic components	5-24
7.1	Maintenance Instructions	5-24
	Press brake: compressed air supply	5-24

Chapter 6 Maintenance (Technical Service)

1	Maintenance overview	6-2
----------	-----------------------------	------------

Chapter 7 Index



Chapter 1

Safety

1	For your safety	1-3
2	Operational safety	1-5
2.1	Intended use	1-5
2.2	Authorized personnel	1-6
3	Hazards	1-7
3.1	Dangers due to the switch cabinet	1-7
3.2	Hazards due to laser radiation	1-7
3.3	Dangers from magnetic fields	1-8
	Mobile fanning magnet (option)	1-8
3.4	Hazards when dealing with workpieces	1-9
	Sharp-edged workpieces	1-9
	Dangers due to floating loads	1-9
3.5	Danger due to increased movement dynamics (optional productivity package)	1-11
3.6	Dangers due to unexpected movements	1-12
3.7	Dangers due to Teleservice	1-12

4	Measures to be taken by the manufacturer	1-13
4.1	Danger zones and safeguarding device	1-13
4.2	Danger signs on the machine	1-16
5	Organizational measures to be taken by the user	1-20
5.1	Observing warnings and danger signs	1-20
5.2	Training and instructing operators	1-20
	Measures applicable worldwide	1-20
5.3	Adhering to the duty of care when handling the machine	1-20
5.4	Pay attention to water protection	1-21
5.5	Using spare parts, accessories, software and operating materials	1-22
6	Overview of residual risks	1-24
7	Disassembly and disposal	1-26

1. For your safety

Regulations and guidelines With the CE marking and the EC Declaration of Conformity, TRUMPF confirms that the machine meets the basic health and safety requirements of the EC Machinery Directive.

The CE marking is located on the nameplate of the machine. The EC Declaration of Conformity is delivered along with the machine.

The machine meets the requirements of safety standard ANSI B11.3.

Chapter Safety This chapter describes the safety concept. The chapter describes how potential dangers can be avoided. The overview of residual risks contains measures to be taken by the operator in order to reduce the residual risks.

Notes

- The operator must adhere to the valid safety and accident prevention regulations of the respective country and the safety laws of the state and of the region!
- USA and Canada: TRUMPF also recommends compliance with the ANSI safety regulations for press brakes.
- Observe the operator's manual for the press brake.

Warnings and danger signs Certain operations can be a source of danger during operation. The documentation contains warnings before the instructions for these activities. There are danger signs on the machine.

A warning contains signaling words that have been explained in the following table:

Signaling word	Description
DANGER	... refers to great dangers. If not avoided, it can result in death and serious injuries.
WARNING	... refers to a dangerous situation. It could lead to serious injuries, if it is not avoided.
CAUTION	... indicates a potentially dangerous situation. It could lead to injuries, if it is not avoided.
NOTICE	If such a situation is not observed, it can lead to damage to property.

Tab. 1-1

Example of a warning:

 **DANGER**

Suspended load!

Falling loads could lead to severe bodily injury or even death.

- Observe safety regulations for the handling of heavy loads.
 - Never walk under a suspended load.
 - Use tested and appropriately sized tackle and means of transportation.
 - Employ qualified technicians to transport the machine.
 - Carry out transport in accordance with the transport regulations.
-

2. Operational safety

The machine can become a source of danger if it is used inappropriately or for purposes other than those intended:

- Dangers to the safety of the operator.
- Damage to the machine and other material assets of the operator.
- Negative effect on the effective functioning of the machine.

2.1 Intended use

The user may use the machine only in the industrial sector.

The installation, operating and transport conditions prescribed by TRUMPF must be adhered to and the maintenance work must be performed. The installation and operation must comply with the relevant national regulations that are valid in the country of operation. The user must adhere to the national regulations.

The user may only manipulate cold sheets using the machine. The sheets are taken from the loading or unloading position, bent on the press brake according to the machining cycle and then, depending on the design version, either set down at the loading or unloading position or transported onwards from the unloading position.

The following is not allowed:

- Unauthorized alteration or conversion of the machine by the user or personnel.
- Any working procedure that impairs the safety.
- The machining of hot, splintering or brittle materials.
- Use of tools from other manufacturers without consultation with and release by TRUMPF.
- Misuse of press beams for storing unused tools.
- The machining of scarred or sandblasted sheets (does not apply to machining with the pivoted-jaw gripper).
- The machining of sheets with unsuitable gripper technology (e.g. perforated sheets with suction cups).
- Exceeding the maximum workpiece dimensions of:
 - 2000 x 1000 mm with BendMaster (60).
 - 3000 x 1500 mm with BendMaster (150).
 - Profiles: 2500 x 1000 mm with BendMaster (60).
 - Profiles: 4000 x 500 mm with BendMaster (150).
- Exceeding the maximum workpiece weight of:
 - 40 kg with BendMaster (60).
 - 110 kg with BendMaster (150).

- Exceeding the maximum load capacity (workpiece and gripper weight) of:
 - 60 kg with BendMaster (60).
 - 150 kg with BendMaster (150).
- Use outdoors.
- Utilization of the portable manual control unit in the vicinity of heat sources or direct sunlight.

Exemption from liability

Any other form of use is considered unauthorized use. TRUMPF is not liable for any damage, especially personnel injuries and production failures resulting from this. The risk is borne solely by the operator. The warranty will be voided.

TRUMPF assumes no liability for material damage or personal injury caused by gripper elements and peripheral equipment built by the user himself (e. g. conveyor systems for the workpieces, sheet thickness measurement devices). The user bears sole responsibility for using self-built gripper elements.

2.2 Authorized personnel

- Operation, setting and maintenance work may only be carried out by authorized, trained and instructed personnel.
- Qualified personnel may:
 - Transporting the machine to the installation site.
 - Carry out work at the hydraulic, pneumatic and electrical modules.
 - Disassembling the machine.

3. Hazards

3.1 Dangers due to the switch cabinet

The switch cabinet may be opened only by a specialist electrician.

 **DANGER**

Electrical voltage!

Electric shock!

- Keep switch cabinet closed.
- Before opening the switch cabinet: switch off the main switch and secure against switching back on. Wait for the discharging time (at least 5 minutes).

 **CAUTION**

Hot components!

Burns!

- Keep switch cabinet closed.
- Before opening the switch cabinet: switch off the main switch and secure against being switched back on. Wait for the correct cooling phase (at least 5 minutes).

3.2 Hazards due to laser radiation

Laser systems are classified into laser classes as per the European Standard EN 60825-1 (USA: ANSI Z136.1, ANSI B11.21). The laser class corresponds to the hazard level of the laser light emitted.

Assembly	Laser class	Description
Diode lasers on the sheet sensor for height measurement Wavelength 535 nm.	2M	The accessible laser radiation lies in the visible spectral range of 400 nm to 700 nm. It is not dangerous for eyes in the case of short exposure time (up to 0.25 s) as long as the beam is not observed through optical instruments (magnifying glass, lens, telescope). Additional radiation parts outside the wavelength spectrum of 400-700 nm fulfill the conditions of class 1M. Eyes are normally protected from the laser light by turning away and closing the eyelids.
Four diode flashes on the sheet sensor for fine exposure Wavelength 532 nm.	2M	The accessible laser radiation lies in the visible spectral range of 400 nm to 700 nm. It is not dangerous for eyes in the case of short exposure time (up to 0.25 s) as long as the beam is not observed through optical instruments (magnifying glass, lens, telescope). Additional radiation parts outside the wavelength spectrum of 400-700 nm fulfill the conditions of class 1M. Eyes are normally protected from the laser light by turning away and closing the eyelids.

Tab. 1-2

 **WARNING**
Eye injury due to laser radiation!

Laser radiation damages the eyes permanently.

- Do not look directly into the beam.

3.3 Dangers from magnetic fields

Mobile fanning magnet (option)

A mobile fanning magnet can be used to separate ferromagnetic sheets.

The fanning magnet is a permanent magnet which creates a strong magnetic field. The magnetic field and the high attractive ferromagnetic force are constant.

Magnetic flux density

The magnetic flux density is at its highest of about 180 mT (milli tesla) at the front surfaces of the fanning magnets. The value is about 0.7 mT at a distance of 60 cm.

⚠ WARNING**Health risk and damage to property due to strong magnetic fields of the expanding magnets!**

- Persons with pacemakers: maintain a distance of at least 1 m.
- Notify personnel, visitors, or visiting personnel of the dangers to persons with pacemakers.
- Do not reach between the fanning magnet and the sheet metal stack with parts of the body.
- Only place the fanning magnet on the sheet metal stack or remove it from the sheet metal stack in its retracted normal state.
- Do not hold any heavy ferromagnetic parts (sheets, tools) in your hands in the proximity of fanning magnets (<1 m).
- Keep watches and magnetic storage media (diskettes, credit cards) away.

3.4 Hazards when dealing with workpieces

Processing workpieces can be dangerous. These dangers and measures are different for every workpiece.

Sharp-edged workpieces

⚠ WARNING

Workpieces have sharp edges!

Risk of injury!

- Wear personal protective gear.

Dangers due to floating loads

The BendMaster moves with suspended loads during loading and unloading.

⚠ DANGER**Unexpected vacuum loss in case of a suctioned workpiece!****Risk of fatal injury due to workpiece crashing!**

- No permanent workplace is permitted outside the safety fencing within the swivel range of the BendMaster.
- Follow the safety regulations for handling heavy loads.
- Do not enter the danger zone when a workpiece is attached by suction.
- Do not fail to follow any of the following instructions.

In manual and automatic mode

- Never manually guide a load suspended from the BendMaster out of the danger zone or manually guide it into the danger zone.
- In the event of a power failure:
 - Wait until the power supply has been restored.
 - Securely deposit the workpiece on a pallet.
- If there is a defect directly at the BendMaster that requires repair work in the danger zone:
 - Secure the suspended load from above using a crane and remove it.
 - or**
 - Drop the suspended load with the safety doors closed before entering the danger zone.
- If there is a defect to the system outside the danger zone:
 - Eliminate the defect.
 - Deposit the suspended load on a pallet.
- Do not move the BendMaster with suspended loads into the home position in order to enter the danger zone afterwards. Set down the workpiece first.

Additionally, in manual mode

In manual mode (for example, teach mode), the operator may be within the safety fencing to move the axes of the robot and the press brake.

If the compressed air fails, an acoustic warning signal is emitted in manual mode and a cyclic error message is displayed at the HMI. The BendMaster stops and can no longer be moved in manual mode.

⚠ WARNING**Unexpected drop in pressure at the BendMaster gripper while a workpiece is clamped!****Risk of injury due to workpiece falling down.**

- If an acoustic warning signal is emitted, exit the automation cell immediately and close the safety doors.
- Acknowledge the message.
- Before entering the safety cabin: move the BendMaster manually and set down the clamped workpiece safely.

⚠ WARNING

Pressure drop at the BendMaster gripper while a workpiece is clamped caused by switching off the compressed air supply.

Risk of injury due to workpiece falling down.

- Only turn off the MAIN SWITCH and the compressed air supply if no workpiece is gripped by the BendMaster's vacuum gripper.

The safety doors are not monitored in manual mode.

⚠ WARNING

Risk of injury and damage to property due to suspended load in manual mode.

- Move the BendMaster only if no other persons are in the danger zone.
- Only perform overhead movements with suspended loads from a safe distance.
- Make sure that the suspended load does not collide with the safety fencing or other parts in the danger zone.

When programming of traverse points

- Do not modify automatically generated traverse points such that the risk of workpiece loss is increased.

3.5 Danger due to increased movement dynamics (optional productivity package)

When the productivity package option is activated, the movement dynamics of the BendMaster are doubled.

⚠ WARNING

Increased movement dynamics due to productivity package

The workpiece may fall out or be ejected! Risk of injury!

- Before starting an older project, check the holding force and stability of the corresponding gripper and confirm the respective dialog.
- Calculate the suction cup capacity (see ["Calculating suction cup capacities"](#), pg. 4-51).
- Adapt the number of suction cups to the gripper.
- If the number of suction cups cannot be increased: reduce the speed of the travel points (see ["Points, editing"](#), pg. 4-96).
- For magnet gripper: reduce the robot speed (override) to 50% (see ["Determining the reduction of the robot speed"](#), pg. 4-52).

3.6 Dangers due to unexpected movements

 **WARNING**

Unexpected movements of the robot!

Risk of crushing.

- When working inside the safety cabin: Maintain a sufficient distance from moving assemblies.
 - Do not stand under the BendMaster.
-

 **WARNING**

Unexpected movements of linear or pivoted-jaw gripper (option)

Risk of crushing.

- Before starting set up or maintenance work, close the shut-off valve on the pivoted-jaw gripper.
 - Take special care when you open the shut-off valve, because the suction cup slat will start to move immediately.
-

3.7 Dangers due to Teleservice

Teleservice is used to establish a connection between the machine and Technical Service.

The service engineer can access the user interface to analyze problems and in some cases to eliminate them directly.

 **WARNING**

Teleservice activated!

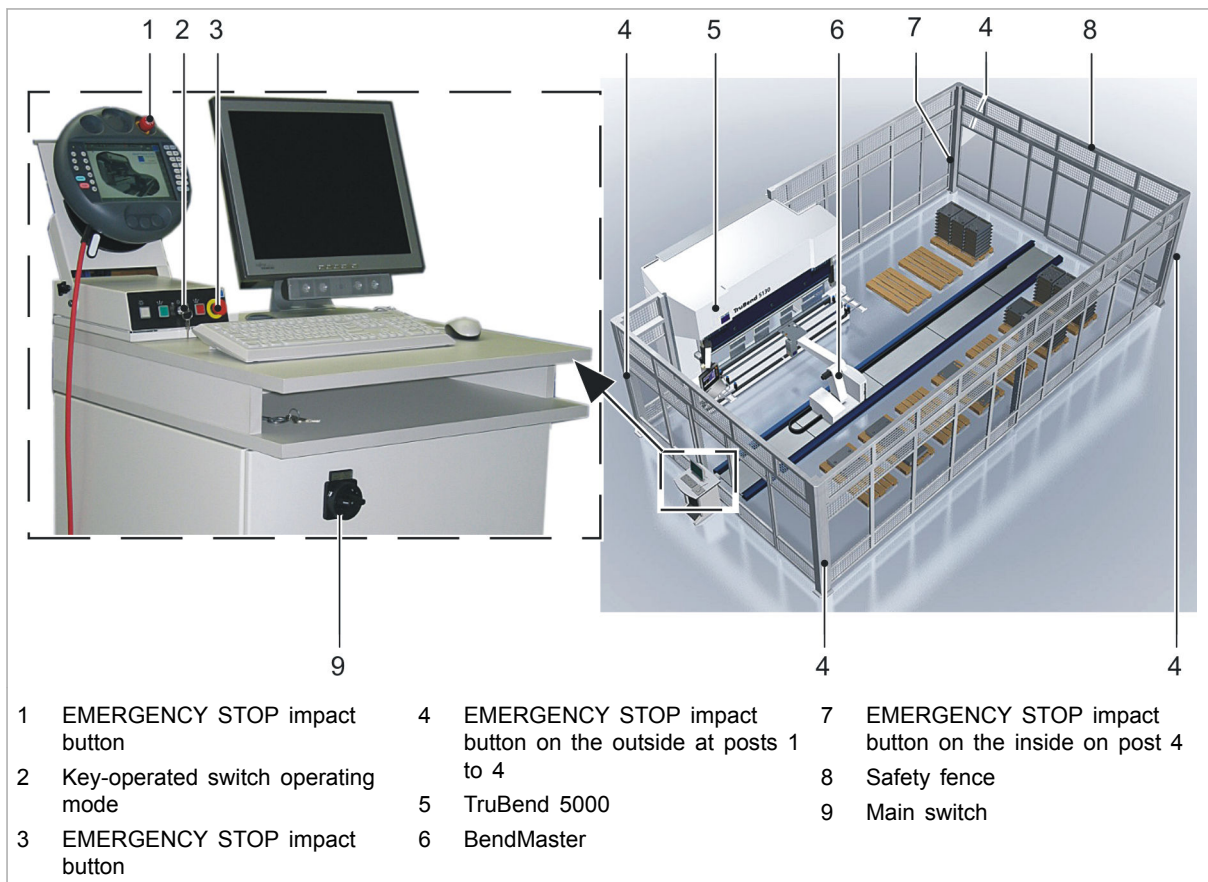
Injury and damage to property.

- Only persons trained by TRUMPF may take part in a Teleservice session.
 - If doubts arise regarding the qualifications of the persons involved or if comprehension issues arise, TRUMPF can refuse Teleservice or terminate the Teleservice session.
-

4. Measures to be taken by the manufacturer

The danger zone of the machine is safeguarded by safety equipment. The machine may only be operated with these safety devices.

4.1 Danger zones and safeguarding device

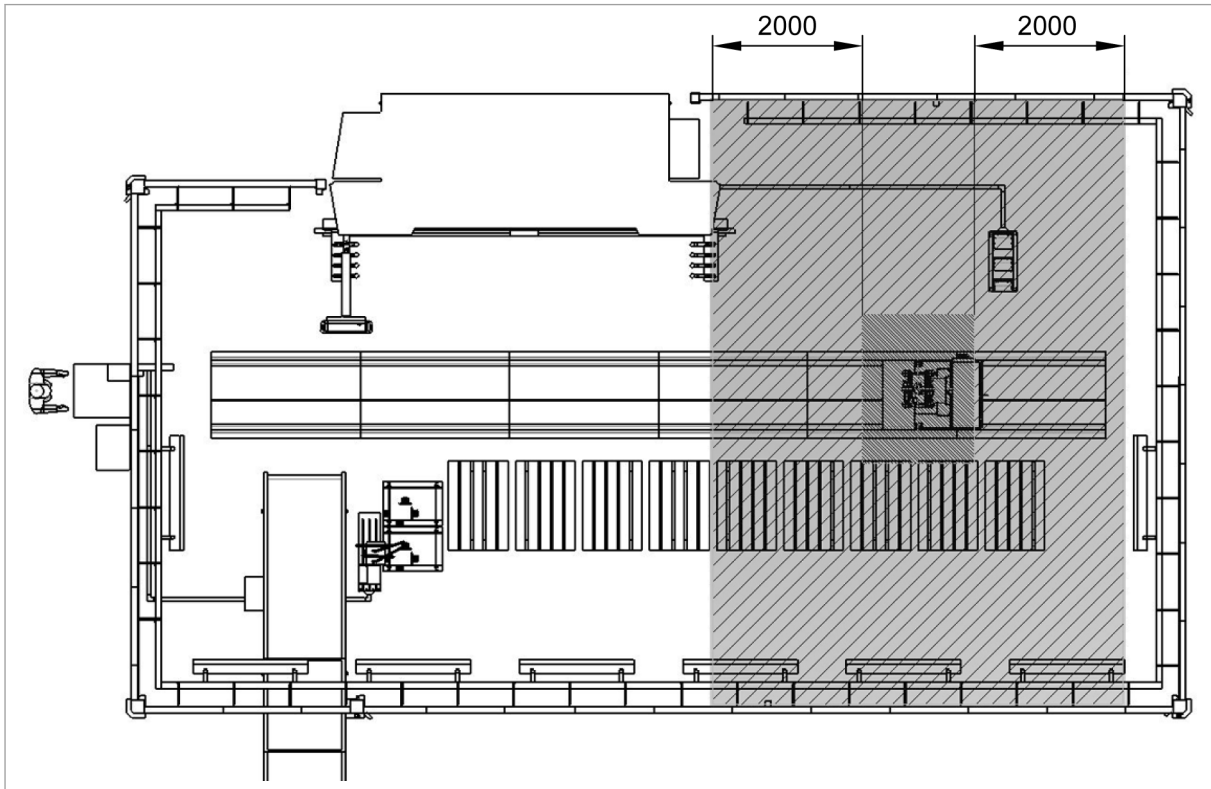


Danger zones and safeguarding device TruBend Cell 5000

Fig. 59198

In teach mode (setup mode) of the BendMaster, the BendMaster is moved with suctioned part while the operator can be within the protective fence. The danger zone in teach mode is in the

entire swiveling range of the BendMaster as well as 2000 mm to the left and to the right of the suctioned workpiece.



TruBend Cell 5000 danger zone (gray) in teach mode with suctioned workpiece

Fig. 71402

Safety fence The danger zone is completely or partially secured with a safety fence depending on the installation. It can be accessed through one or more safety doors.

The safety fence prevents persons from entering the system in automatic mode or manual press mode. It prevents workpieces from falling out of the system. The safety doors are monitored and enable controlled access to the system.

Restricted work area The work area of the robot is restricted at the individual motion axes of the robot using soft and hardware end stops. The robot can only be moved within the defined work area.

The work area is defined such that the robot cannot move against the safety cabin or other static collision contours (e.g. switch cabinet within the safety cabin).

Main switch The machine is switched on and off via the main switch. The main switch can be secured against being switched on again using a padlock.

The main switch has the following positions:

Position	Description
0	The machine is switched off and the voltage supply of the machine is interrupted .
I	The machine is switched on.

Tab. 1-3

EMERGENCY STOP impact button

Note

The Emergency stop function for the press brake is integrated in the BendMaster control.

EMERGENCY STOP impact buttons are located at the following points on the machine:

- On the portable manual control unit.
- On the support for the portable manual control unit.
- On each corner post of the safety fencing.
- Within the protective fence at Column 4.

An EMERGENCY STOP leads to the following:

- All axis motions stop.
- All drives are switched off electrically.
- The power supply of all safety doors is interrupted.
- The 24 V control voltage is maintained.
- Vacuum remains.

Pulse trigger switch

In manual mode, the enable key on the portable manual control unit is pressed into the neutral position in order that the axes can be moved.

In Manual mode, the user may be within the safety fencing. For that reason, the travel motions of the machine must be observed.

The pulse trigger switch has the following positions:

Position	Description
Not pressed	It is not possible to move the axes.
Pressed	The axes can be moved. All axis movement stops when the pulse trigger switch is released.
Pushed through	EMERGENCY STOP is triggered.





Tab. 1-4

OPERATING MODE key switch

The machine can be operated in various operating modes. The operating mode is selected using the OPERATING MODE key switch.

The key must be removed and kept safely.

The key switch is located on the mounting device for the portable manual control unit and has the following positions (see "Fig. 46231", pg. 4-17):

Switch setting	Description
 (zero position)	None of the axes can be moved.
 (TruBend manual)	Press brake can be operated without BendMaster. The BendMaster is in home position.
 (Manual mode)	Only the axes of the BendMaster can be moved at reduced speed. The ENABLE KEY on the portable manual control unit must be pressed the whole time.
 (Automatic mode)	All axes move at the programmed speed. The program is started using the START button on the portable manual control unit. The operator must be outside the safety cabin.

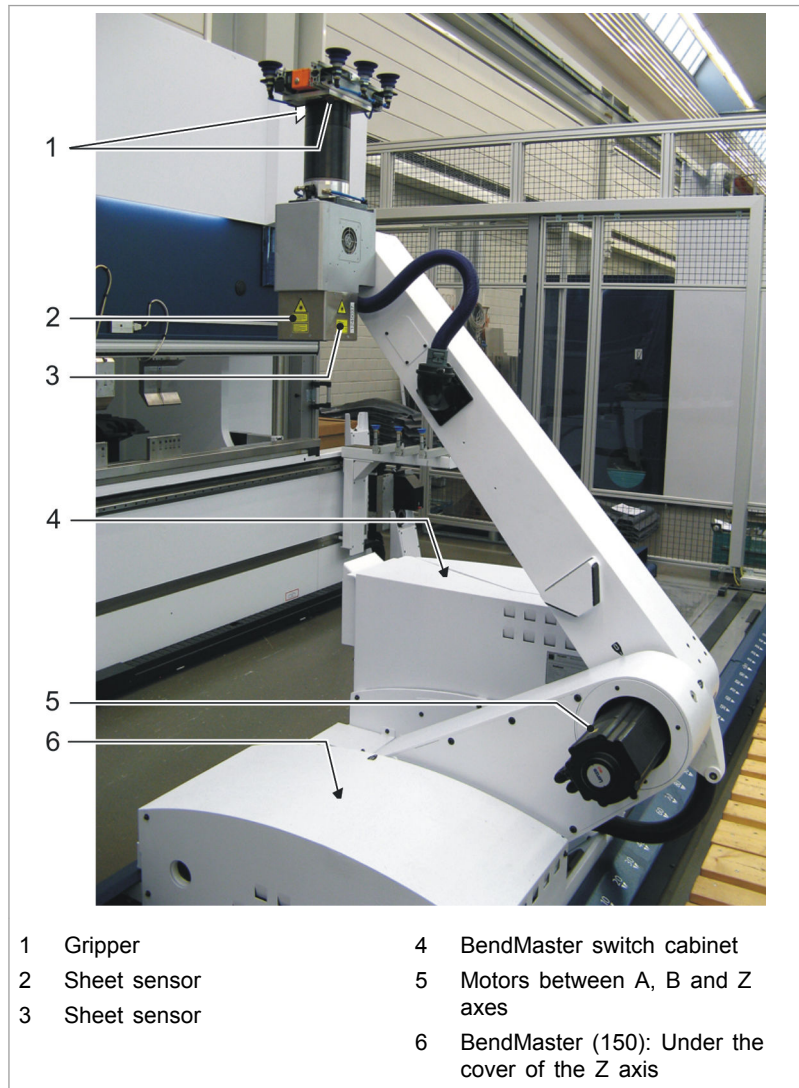
Tab. 1-5

Reduced speed in manual mode

The traveling speed of the axes is reduced automatically in manual mode. The maximum traveling speed at the center of the gripper is 250 mm/s.

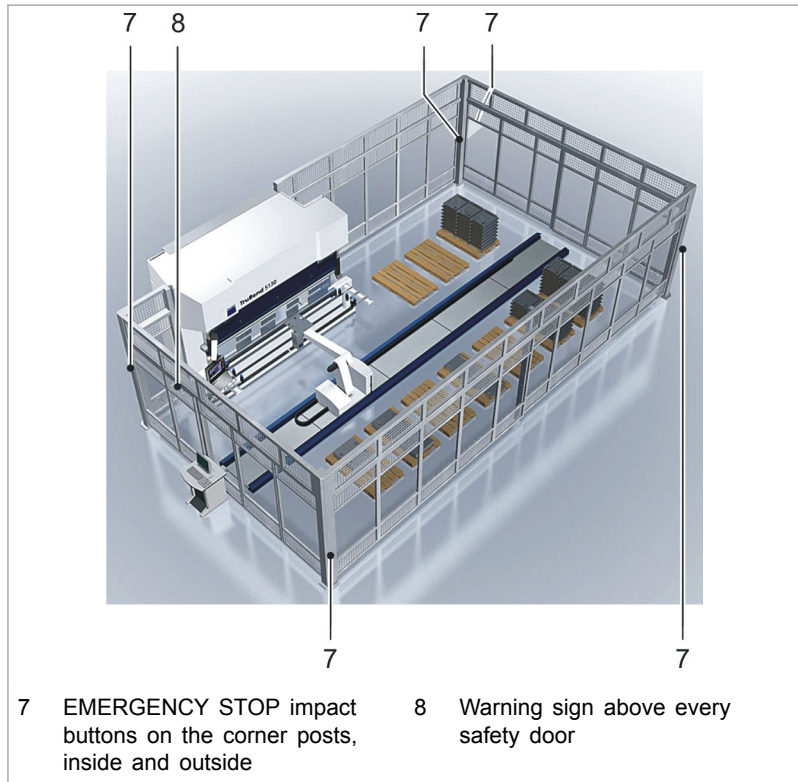
4.2 Danger signs on the machine

Danger signs indicate dangers when operating the machine.





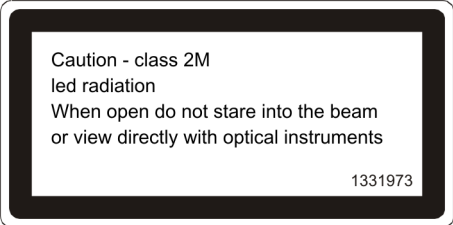

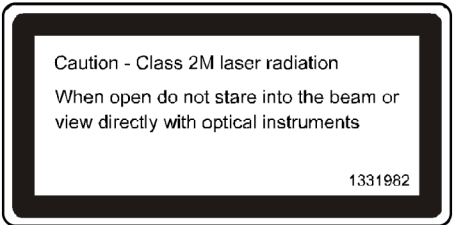
Danger signs BendMaster




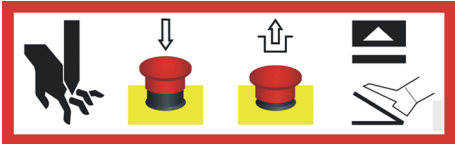

Fig. 59196



Danger signs TruBend Cell 5000

Fig. 59274

Pos.	Danger sign	Description
1		Risk of crushing.
2	 	Danger due to laser radiation.. Caution - radiation, light emitting diodes, class 2M. Do not look into the beam or view directly with optical instruments when the cover is opened.
2	 	Danger due to laser radiation.. Caution - laser radiation, class 2M. Do not look into the beam or view directly with optical instruments when the cover is opened.

Pos.	Danger sign	Description						
3	<div style="border: 1px solid black; padding: 5px;"> <p>Laser radiation do not stare into the beam or view directly with optical instruments Class 2M laser product</p> <table style="width: 100%; border-collapse: collapse;"> <tr> <td style="width: 50%;">Wavelength</td> <td style="width: 50%;">532 nm</td> </tr> <tr> <td>Max. power output</td> <td><1 mW</td> </tr> <tr> <td>EN 60825-A2:2001</td> <td>1331985</td> </tr> </table> </div>	Wavelength	532 nm	Max. power output	<1 mW	EN 60825-A2:2001	1331985	<p>Laser radiation: do not look into the beam or view directly with optical instruments Laser class 2M</p> <p>Wavelength 532 nm. Max. output power <1 nW</p>
Wavelength	532 nm							
Max. power output	<1 mW							
EN 60825-A2:2001	1331985							
4		<p>Danger due to electrical voltage. (BendMaster switch cabinet)</p>						
5		<p>Danger due to hot surfaces.</p>						
6		<p>Danger due to electrical voltage. (Under cover, Z axis BendMaster (150))</p>						
7		<p>Freeing of clamped persons.</p>						
8	<div style="border: 1px solid black; padding: 5px;">  <p>Only instructed personnel may enter the bending cell!</p> <p>Danger from swinging load!</p> <p>Do not reach through the safety fencing! Danger of being struck by steel parts!</p> </div>	<p>Only trained personnel are permitted to enter the bending cell.</p> <p>Danger from suspended load!</p> <p>Do not reach through the safety fencing! Danger from attached sheet metal parts!</p>						

Tab. 1-6

5. Organizational measures to be taken by the user

5.1 Observing warnings and danger signs

Certain activities can be a source of danger during the operation. The documentation contains warnings before the instructions for these activities and danger signs are provided on the machine.

5.2 Training and instructing operators

Measures applicable worldwide

The user must take the following measures before the personnel start working on the machine:

- Train personnel appropriately.
- Inform the personnel about the possible dangers and the safety measures.
- Keep personal protective gear ready.
- As far as possible, ensure personnel wear protective gear (e.g. gloves, safety shoes, hearing protection, safety glasses...).
- Define responsibilities for safety, operation, maintenance, setting work and service.
- Require that personnel read the technical documentation of the machine. Recommendation: obtain written confirmation from the personnel.
- For fault diagnosis and error correction, a connection will be made via Teleservice by TRUMPF between the machine and Technical Service. When the machine is commissioned the user will be informed about the sequence and possible risks of the Teleservice. The user must provide safety instruction to operators who are involved in the Teleservice.

5.3 Adhering to the duty of care when handling the machine

Checking the danger zone and safety devices

The operator must always make sure that nobody is within the danger zone before starting up the machine.

The operator may only operate the machine using safety devices. Safety devices may not be removed or put out of operation, except when performing maintenance and service work. The

operator must replace and put the safety devices into operation after completing work.

Once per shift, preferably before starting the production:

- Check the safety devices for proper function.

Ensuring the perfect working order

User:

- The user must ensure that the machine is installed as per the installation plan and installation conditions.
- The user must ensure that only authorized personnel works at the machine.
- The operator must ensure that damaged or missing danger signs on the machine are replaced.
- The user or the persons appointed by him/her must operate the machine when it is in perfect working order.
- The user must ensure that the work station is kept clean and tidy by issuing appropriate instructions and conducting inspections.
- The user must ensure that the working areas are supplied with sufficient fresh air.

Operator:

- The operator must immediately report changes (including the operating performance) occurring in the machine to the operator. The machine must be checked for externally visible defects and damage at least once per shift.
- The machine must be checked for externally visible defects and damage at least once per shift.
- The operator must check the tooling status prior to operation of the machine to avoid any risks due to an incorrect tooling status.
- Before starting the machine, the operator must always make sure that nobody is within the danger zone.

Observing the shutdown procedure

The prescribed shutdown procedures must be adhered to during all operations (e.g. setting and maintenance work).

5.4 Pay attention to water protection

Water-pollutant substances (e.g. oil) should not enter the ground or into water bodies.

The Federal Republic of Germany

The principle of precaution is applicable for machines in the Federal Republic of Germany: water should not become contaminated when using water-pollutant substances (Federal Water Act WHG).

The plant decree and the administrative regulations of the Federal states explain how this principle of precaution should be adhered to.

Water-pollutant materials	▪ Lubricants
Water Hazard Class	1 or 2
Volume of water-pollutant materials	≤ 5 l (≤ 1.32 gal)
Hazard level of the machine	A

Water protection specifications

Tab. 1-7

Outside the Federal Republic of Germany

Outside the Federal Republic of Germany, the respective national regulations as regards water protection must be adhered to.

5.5 Using spare parts, accessories, software and operating materials

Using spare parts, accessories and software

Spare parts and accessories that have not been released by TRUMPF (in the following: "External parts and accessories") are not checked. Installing and using external parts and accessories can change design-related properties of the machine and weaken the safety.

Only software that has been approved for installation by TRUMPF may be installed.

Liability disclaimer

- TRUMPF is not liable for damage if external parts and accessories are used or if spare parts and accessories approved by TRUMPF are not installed or replaced properly.
- TRUMPF cannot be held liable for damages resulting from the installation or operation of software which is not approved by TRUMPF.

Using permissible operating materials as per the regulations

The permissible operating materials (especially lubricating and cleaning agents) must be used as per the regulations. If a safety data sheet has been prescribed for the manufacturer of the operating material (European Directive 1907/2006 REACH), the instructions in it must be followed, such as:

- Chemical properties.
- Physical and safety-related specifications.
- transport.
- Regulations
- Safety measures, storage, and handling.
- Procedures in the event of accidents or fires.

-
- Specifications for toxicology and ecology.
 - Waste code with prescribed disposal method for the operating materials.

Note

Safety data sheets can be obtained from the manufacturers of the respective operating materials.

6. Overview of residual risks

The machine has residual risks in spite of its safety devices and construction type.

The following overview of residual risks is a summary of the main potential threats to life and limb posed by the machine.

Any additional precautions that can be taken by the machine owner to reduce residual risks are specified in the overview of residual risks.

For detailed descriptions of the measures: (see "Hazards", pg. 1-7).

Residual risk	Dangerous point	Type of danger	Measure to be taken by the operator
Mechanical elements			
Crushing, striking, shearing or cutting.	<ul style="list-style-type: none"> ▪ Sharp-edged workpieces. ▪ Movement of the arm with or without a workpiece. ▪ Moving the machine on the floor lane. ▪ Unexpected movement of linear or pivoted-jaw grippers (option). 	Risk of injury	Wear protective clothing Operation by trained and instructed personnel. When working inside the safety cabin: Maintain a sufficient distance from moving assemblies (BendMaster, press beam, backgauge). It is forbidden to go beneath the BendMaster or between the BendMaster and the bending machine.
Crushing, hitting, shearing	Falling loads: <ul style="list-style-type: none"> ▪ Releasing the workpiece after bending. ▪ Workpiece falling due to loss of vacuum. 	Risk of injury	Wear protective clothing Wear safety shoes. Operation by trained and instructed personnel. Before entering the safety cabin: manually move the BendMaster and safely place the workpiece down or drop it, for example, in the area on the right, next to the press brake.
Stumbling	Stumbling within the floor lane area.	Risk of injury	-
Gripping or retracting	Expected movement of the conveyor band (option).	Risk of injury	Maintain sufficient distance to the conveyor belt. Do not lean or support yourself on the conveyor belt.
Malfunction or incorrect function	The BendMaster collides with the safety fencing.	Risk of injury	There must be no permanent workplace outside of the safety cabin within the swiveling range of the BendMaster.
Electrics			

Residual risk	Dangerous point	Type of danger	Measure to be taken by the operator
Electrical contact and proximity to parts under high voltage, electric shock	<ul style="list-style-type: none"> ▪ Direct contact with normally live parts. ▪ Indirect contact with parts that are live due to an error. 	Risk of fatal injury	Maintenance/servicing/repairs by specially trained personnel.
Teleservice			
Crushing, cutting, separating, impacting	Movements of the machine	Risk of injury	Have Teleservice performed only by persons who have been trained by TRUMPF.

Residual risks

Tab. 1-8

7. Disassembly and disposal

TRUMPF recommends that TRUMPF machine tools be disassembled and disposed of by Technical Customer Support or a specialist disposal company. The following notes are to be passed on to the specialist disposal company performing the disposal work, to guarantee fast, environmentally sound and safe disposal.

Preparing disassembly

- Contamination, in particular types of dust which can be stirred up or which be hazardous during disassembly are to be removed.
- Close off the disassembly and storage area over a wide area.
- Move down movable parts and suspended loads as far as possible. Secure or support suspended loads in the event of a defective machine.
- Have the machine disconnected from the power supply by a trained electrician.
- If present: Close the compressed air supply and separate it from the machine.
- Depressurize components under pressure (e.g. compressed air line).
- Wait at least an hour to allow any residual voltage in the machine to dissipate and hot components to cool down. All assemblies/components can then be touched.

Dismantling

- Poisonous vapors can result when thermally cutting painted components or components made out of composite materials!
 - Select a suitable cutting process.

or

 - Wear a suitable protective mask and ensure there is a sufficient supply of fresh air.
- Secure top-heavy assemblies to prevent them from tipping over and carefully put them in a good transport position (center of gravity down).
- Moving assemblies may be unbraked after being disconnected from the power supply!
 - Fix movable assemblies prior to disassembly/transport, so that the center of gravity cannot move in an uncontrolled manner.
- Mechanical stresses can be released when undoing chains, ropes and steel constructions!
 - Wear suitable protective gear and close off the area over a wide area.

-
- Transporting assemblies**
- Close off transport routes and storage positions over a wide area.
 - Use suitable lifting gear. See installation conditions.
 - Fasten assemblies above the center of gravity as far as possible.



Chapter 2

BendMaster installation conditions (60)/(150)

	Who does what?	2-3
1	Planning aid	2-4
2	Installation site	2-6
2.1	Space requirements	2-6
2.2	Floor requirements	2-6
	Surface	2-6
	Floor quality	2-8
2.3	Weight load	2-10
2.4	Stress due to vibration	2-11
2.5	Ambient conditions	2-11
3	Compressed air supply	2-13
4	Electrics	2-14
4.1	Electrical power supply	2-14

	Connected loads	2-14
	Connecting cables	2-15
4.2	Power supply	2-15
	Residual current device (RCD)	2-15
	Line structures	2-16
4.3	Network link	2-17
5	Transport	2-18
5.1	Preparing transport	2-18
	Transport dimensions	2-18
5.2	Permitted auxiliary tools	2-18
5.3	Checking, unloading and transporting the machine	2-20
	On delivery: check the machine	2-20
	Unloading and transporting the machine	2-20

Who does what?

Customer All the conditions described in this chapter must be fulfilled before the machine is delivered.

If this is not the case, Technical Service will not be able to put the machine into service.

Note

During start-up, the main switch on the machine may only be switched on by Technical Service.

Technical Service The machine is put into service by Technical Service.

Start-up includes:

- Installing, aligning, leveling and securing the machine.
- Connecting the machine to the supplies (with the exception of the electrical power supply).
- Putting the machine into service.
- Performing a functional test.
- Instructing personnel.

1. Planning aid

The planning aid provides an overview of the measures to be taken and preparations to be made.

For details, refer to the corresponding sections of these installation conditions.

Time before the delivery of the machine	Planning criterion	Measures
10 weeks	Personnel and training	<ul style="list-style-type: none"> ▪ Appoint a member of staff to be responsible for preparations for the delivery of the machine. ▪ Appoint operating and service personnel and programmers. ▪ Arrange training schedules for specialist personnel.
10 weeks	Installation site	<ul style="list-style-type: none"> ▪ Determine the installation site of the machine, taking into account the space requirements according to the installation plan. ▪ Check floor requirements: <ul style="list-style-type: none"> - Floor quality. - Evenness. - Oil-resistant floor without expansion joints. ▪ Take the weight and dimensions of the machine into account. ▪ Check the requirements for ambient conditions: <ul style="list-style-type: none"> - Room temperature. - Exposure to sunlight. - Purity of the ambient air. ▪ Check transport route, e.g.: <ul style="list-style-type: none"> - Gateway openings. - Header heights. - Cable rack heights. - Shunting areas around corners.
At least 8 weeks	Installation plan	Confirm the final installation plan by signing it and send back to TRUMPF.
8 weeks	Electrical system	<ul style="list-style-type: none"> ▪ Install electrical connections at the installation site. ▪ Lay the conductor cross-section and fuse protection according to the legal requirements. ▪ Have the work required for Teleservice carried out: <ul style="list-style-type: none"> - Install a telephone connection at the installation site. ▪ For network connection: install the network connection at the installation site.
6 weeks	Compressed air supply	<ul style="list-style-type: none"> ▪ Arrange for the installation of the compressed air supply at the installation site. <ul style="list-style-type: none"> - Take into account connection, purity, compressed air requirements.
3 weeks	Transport	<p>Provide auxiliary transport equipment.</p> <p>Note: If the machine is conveyed to the customer's site by Technical Service, the required means of transportation and auxiliary transport equipment is provided by them.</p>



Time before the delivery of the machine	Planning criterion	Measures
2-3 weeks	Feedback	<ul style="list-style-type: none"> ▪ Provide TRUMPF with feedback to confirm that the requirements of the installation conditions have been implemented.
During installation and start-up	Electrical installation	<ul style="list-style-type: none"> ▪ At the start of the installation process: have the system connected by a professional electrician.

Planning aid

Tab. 2-1

2. Installation site

What does the customer need to do?

Please consult a structural analyst for professional support, particularly in the context of the topic of floor requirements. Hand over the "Installation site" section and the installation plan to the structural analyst.

2.1 Space requirements

The following is documented in the TRUMPF installation:

- Arrangement of components.
- Space requirements for installation.
- Space requirements of the system.
- Space requirements for opening all doors.
- Electric power supply.
- Compressed air supply.

Hall height

- TruBend Cell 5000 with BendMaster (60): at least 4000 mm (at least 157 in).
- TruBend Cell 5000 with BendMaster (150): at least 5000 mm (at least 197 in).

2.2 Floor requirements

The quality of the prepared parts can be guaranteed only when the floor conditions meet TRUMPF requirements.

Surface

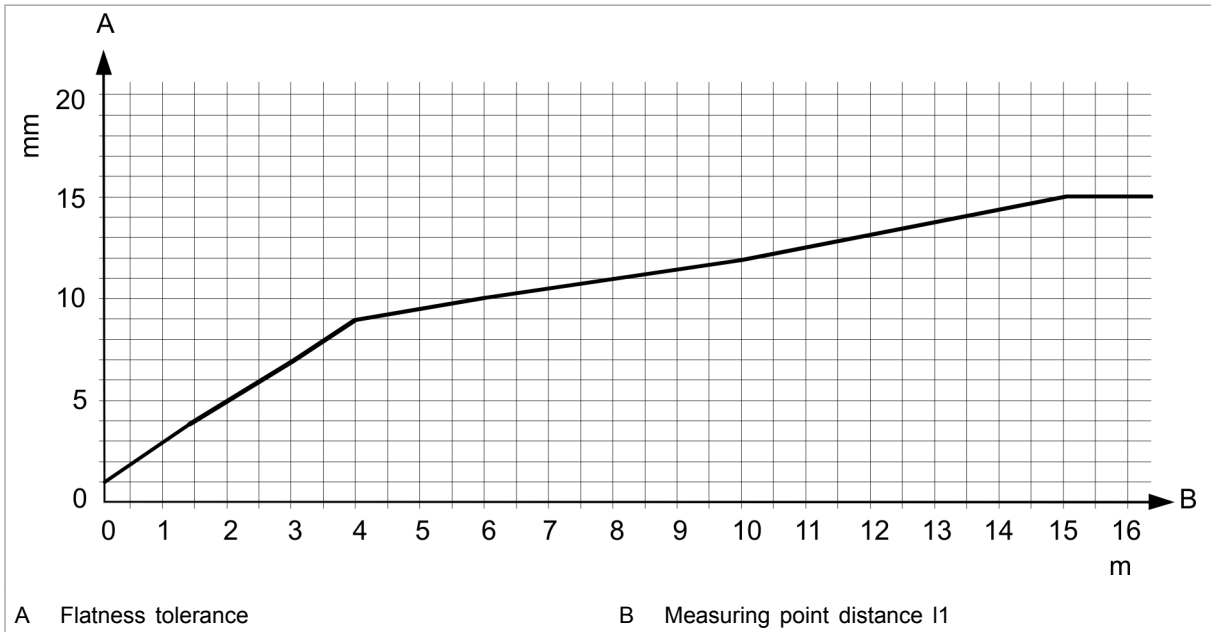
Flatness

The floor on which the machine stands must be even.

Permissible deviation from flatness (flatness tolerance):

- Footprint range: max. 12 mm ($\frac{1}{2}$ in) per 10 m (33 ft).
- Load-bearing points range: max. 2 mm (0.08 in) per 0.5 m (1.64 ft).

The flatness tolerance can be determined for different measuring point distances from the following diagram.



Tolerance for evenness depending on the measuring point distance

Fig. 65278

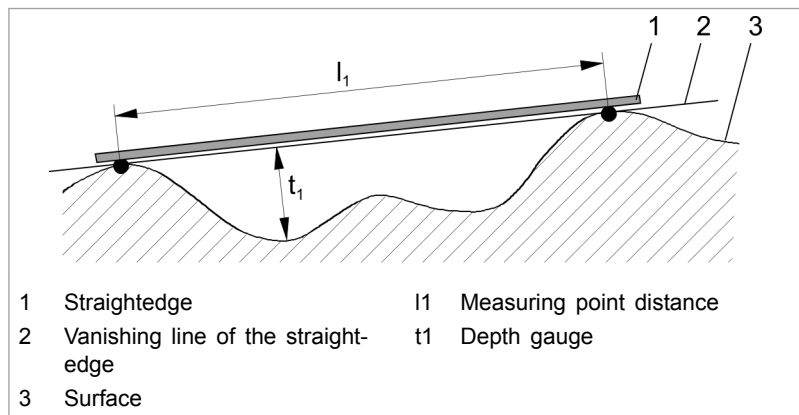
Measuring point distance	Flatness tolerance	Department
0.5 m (1.64 ft)	2 mm (0.08 in)	Load-bearing points.
10 m (33 ft)	12 mm (½ in)	Installation surface.

Reading examples

Tab. 2-2

Measuring procedure:

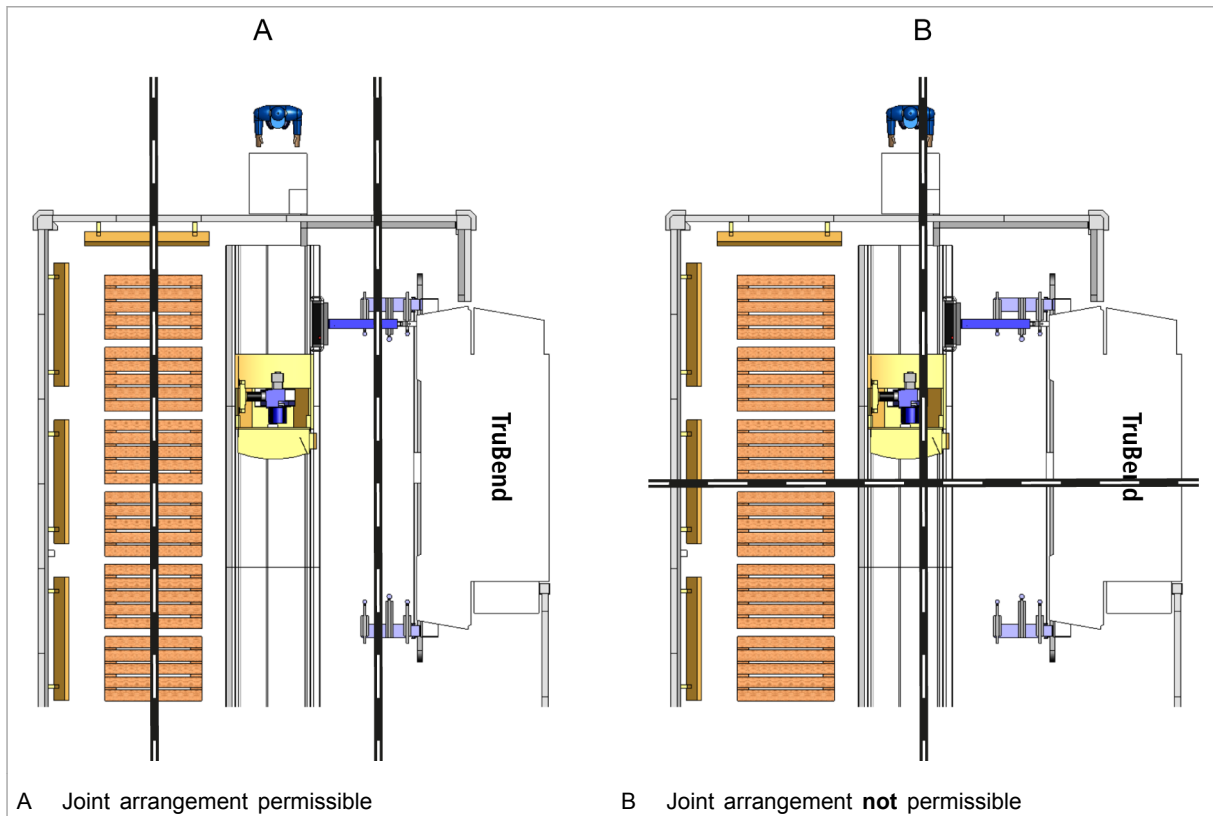
The straight edge is placed on the high points of the surface and determines the depth gauge at the lowest point. For the selected measuring point distance the depth gauge may not be greater than the tolerance for evenness.



Measuring procedure for determination of the depth gauge

Fig. 65581

- Expansion joints**
- The entire installation surface must consist of a continuous base plate with a smooth surface in the area of the load-bearing points.
 - The distance of the plug bore holes to the edge of the base plate must be at least 200 mm (8 in).
 - If foundations are present, the arrangement of the expansion joints must be paid attention to.



Expansion joints, top view

Fig. 58390

Floor quality

Note

The floor must be oil-proof.

Elastically cushioned base plate

Possible combinations in the bending cell:

- BendMaster (60) with TruBend 5085 to TruBend 5230 (S).
- BendMaster (150) with TruBend 5130 to TruBend 5320.

- Carrying capacity of the subsurface at least $k_s = 5000$ kN/m².
- Minimum thickness:
 - TruBend 5085 - 5230: 200 mm / 7.87 in.
 - TruBend 5230 (S): 230 mm / 9.05 in.
 - TruBend 5320: 250 mm / 9.84 in.
- Concrete quality (equivalent to tensile strength C 25/30).
- The reinforcement of the base plate should meet or exceed the following specifications. The specifications apply to the **reconstruction** of the base.

		5050	5085	5085 (S)	5130
Top lengthwise (xsi)	cm ² /m	3.20	3.20	3.20	3.24
Top transverse (eta)	cm ² /m	3.20	3.20	3.20	3.20
Below lengthwise (xsi)	cm ² /m	3.20	3.20	3.20	3.20
Below transverse (eta)	cm ² /m	3.20	3.20	3.20	3.72

Reinforcement in the base plate

Tab. 2-3

Version with greater installation height:

		5085 (X)	5085 (SX)	5130 (X)	5170 (X)	5170 (SX)	5230 (X)	5230 (SX)	5320 (X)
Top lengthwise (xsi)	cm ² /m	3.20	3.20	3.24	3.62	6.55	4.90	7.18	7.94
Top transverse (eta)	cm ² /m	3.20	3.20	3.20	3.20	3.20	3.20	3.80	4.20
Below lengthwise (xsi)	cm ² /m	3.20	3.20	3.20	3.53	4.83	4.92	5.04	5.33
Below transverse (eta)	cm ² /m	3.20	3.20	3.72	4.24	5.83	5.84	6.24	6.22

Reinforcement in the base plate with increased installation height

Tab. 2-4

US specification: rebar spaced 12 in on center, on both the top and bottom faces and oriented in both the longitudinal and transverse directions.

- < 4.30 cm²/m: 2 layers of #4 rebar
- 4.30 - 6.66 cm²/m: 2 layers of #5 rebar
- > 6.66 cm²/m: 2 layers of #6 rebar

Ceiling plate/free span base plate

- Effective load 15 kN/m² (2.2 psi).
- Minimum thickness:
 - TruBend 5085 - 5230: 200 mm / 7.87 in.
 - TruBend 5230 (S): 230 mm / 9.05 in.
 - TruBend 5320: 250 mm / 9.84 in.

- Concrete quality (corresponding to Class C 25/30 tensile strength): cylinder compressive strength ≥ 25 N/mm² (3700 psi).
- Multiple span girders.

When is a structural analyst generally required?

A structural analyst must be consulted under the following conditions:

- The previously named requirements for an elastically embedded base plate are not met.
- The system is to be set up on a ceiling plate/free-span base plate.
- The system is to be set up on fiber-reinforced concrete or roller-compacted concrete.
- The system is to be installed on a floor other than the one named above.

Vibration damping

The machine must be damped against oscillations if other sensitive machines are located directly next to the machine or if the machine is located on a free-span surface which cannot tolerate these oscillations.

Vibration damping can be implemented by the following measures:

- Use Sylomer mats to isolate the machine; thickness 12 mm (0.47 in), quality SR 1200, violet color, base plate to the sub-surface and on the side.
- Structure of the floor (from the bottom to the top):
 - A layer of construction mat.
 - At least 300 mm (11.8 in) gravel layer with compaction.
 - 120 mm (4.72 in) underbody C12/15 reinforced with 1 mild steel grid layer (steel cross-section lengthwise/crosswise 1.96 cm²/m, mesh width lengthwise/crosswise 100 mm, wire thickness lengthwise/crosswise 5 mm).

2.3 Weight load

Structural analysis

- Perform a structural stress analysis of the load-bearing capacity of the floor surface prior to installation.
- Take into account the weights of the relevant components and the load on the support points.

Note

If the concrete floor has the minimum thickness and quality, it will not have to be subject to a structural check.

Weights of the relevant machine parts:

	BendMaster (60)	BendMaster (150)
BendMaster weight	620 kg (1367 lb)	784 kg (1728 lb)
Floor lane of each 2000 mm element (79 in)	310 kg (683 lb)	310 kg (683 lb)
Complete weight with 4 m floor lane (158 in)	1240 kg (2734 lb)	-
Complete weight with 6 m floor lane (236 in)	1550 kg (3417 lb)	1714 kg (3779 lb)
Complete weight with 8 m floor lane (315 in)	1860 kg (4101 lb)	2024 kg (4462 lb)
Complete weight with 10 m floor lane (394 in)	2170 kg (4784 lb)	2334 kg (5146 lb)
Complete weight with 12 m floor lane (472 in)	2480 kg (5467 lb)	2644 kg (5829 lb)
Complete weight with 14 m floor lane (551 in)	2790 kg (6151 lb)	2954 kg (6512 lb)
Complete weight with 16 m floor lane (630 in)	-	3264 kg (7196 lb)

Tab. 2-5

2.4 Stress due to vibration

In the immediate area around the system, external influences can lead to vibration loads. Vibration loads can effect the quality of workpieces.

External influences are e.g.:

- Fork lifts, industrial trucks, etc.
- The installation or removal of other machines in the immediate vicinity of the system.
- Machines which excite vibrations during operation, such as punch presses etc.

2.5 Ambient conditions

Machine ambient conditions Notes

- One-sided exposure to direct sunlight and unidirectional drafts must be avoided (e.g. with Venetian blinds if installed near a window).
- The switch cabinet must be air-conditioned at temperatures of above +30 °C (+86°F).

Machine status	Temperature
Operation	+10°C ... +40°C (+50°F ... +104°F)

Machine ambient conditions

Tab. 2-6

Ambient conditions for the control system

Control status	Temperature	Humidity
Transport or switched-off machine	-20 °C ... +70 °C (-4°F ... +158°F)	20 to 75 % relative humidity 90 % temporarily, but non-condensing

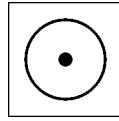
Ambient conditions for the control system

Tab. 2-7

Brightness Bright light impairs the sheet sensor of the BendMaster:

- The sheet sensor may not be exposed to direct sunshine.
- No halogen lamps may be installed over the machine.

3. Compressed air supply



Note

The connection point is indicated on the installation plan using this symbol.

Compressed air supply

The BendMaster needs a separate compressed air supply. The compressed air connection may be flexible or may consist of a fixed pipe to the BendMaster's optional switch cabinet.

Compressed air supply connected loads

Property	Requirement
Required pressure	6±1 bar (87±15 psi)
Air consumption (required volume rate of flow according to ISO 1217 or DIN 1945)	Average: 2 - 8 m ³ /h (1.18 - 4.71 cfm)

Compressed air supply connected loads

Tab. 2-8

Supply lines compressed air supply

Property	Requirement
Min. nominal diameter of the supply line	13 mm (1/2")
Min. nominal diameter of the main line	13 mm (1/2")
Length of the connecting line	No limit

Supply lines compressed air supply

Tab. 2-9

Compressed air properties at the tapping point

Property	Requirement	Quality class ¹	Recommendation
Dust-free	Maximum particle size: 15 µm	4	Air filter in front of the system
Condensate-free	Cooled down to +7°C (+44.6°F) pressure dew point	5	Cold dryer
Oil-free	Maximum oil content: 5 mg/m ³	4	Oil-free sealing screw-type compressor with active carbon filter

Compressed air properties at the tapping point

Tab. 2-10

¹ ISO°8573-1; 2010 edition

4. Electrics

Target group The requirements specified in the "Electrical" section must be met by a company which specializes in electrical installations.

IEC/NEC conditions The IEC conditions apply worldwide, the NEC conditions apply only for Canada and the USA.

4.1 Electrical power supply



Note

The central connection point is on the switch cabinet and is shown on the installation plan with the illustrated symbol.

Connected loads

Note

Impermissible voltage fluctuations endanger the faultless operation of the machines and reduce their performance. A voltage stabilizer is necessary. Otherwise a **regulated** isolating transformer can be used.

Before shipping, the system is set to the power supply voltage and frequency specified by the customer.

Property		Value
Line voltage at 50 Hz \pm 1%	V	400 \pm 5%
Line voltage at 60 Hz \pm 1%	V	460 \pm 5%
Frequency tolerance	-	\pm 2%
Control voltage	V	24
Connected load	kVA	7.5
Fuse protection at 400 V	A	16
Maximum interruption time	-	10 ms/10 s

Tab. 2-11

NEC conditions for fuses

The use of slow-blow fuses is preferred. If these fuses are also used for branch circuits, an ETI type fuse must be used to protect the machine from current peaks when switching the machine on.

Connecting cables

Establish the electric power supply in accordance with DIN EN 60204-1/4.3.1:

IEC	
Cable	Copper cable, four-core minimum (L1, L2, L3, PE)
Cable cross-section	Designed according to: VDE 0100, part 430 (IEC 364-4-47) <ul style="list-style-type: none"> ▪ TruBend 5050: at least 6 mm² (single-core: 10 mm²) ▪ TruBend 5085 / 5130 / 5170: at least 10 mm² (single-core: 16 mm²) ▪ TruBend 5230 / 5320: at least 35 mm²
Ground wires	Designed according to: VDE 0100, part 540 (IEC 364-5-54)
Cross-section of the entire ground wire	Designed according to: EN 60204-1, section 8.2.8.

Requirements for the connecting cable

Tab. 2-12

NEC	
Cable	<ul style="list-style-type: none"> ▪ Copper cable, four-core (L1, L2, L3, PE). ▪ THHN copper or equivalent is recommended (2000 V test voltage) designed for a maximum temperature of 90° C (194° F). ▪ No aluminum cables may be used to connect the machine.
Cable cross-section	<ul style="list-style-type: none"> ▪ The cable cross-section must comply with NEC 670-4 (a). The cable cross-section must be designed for at least 125 % of the nominal current. The nominal current is specified on the nameplate. ▪ To ensure voltage stability and rating, the line dimension should be larger than specified in the NEC table 310-16.

Requirements for the connecting cable

Tab. 2-13

4.2 Power supply

Residual current device (RCD)

Notes

- Whether a residual current circuit breaker has to be used depends upon the local electricity company.
- On the line side, only residual current circuit breakers of type B (sensitive to all types of fault current, EN 50178/5.2.11.2; VDE 0160) are approved.

A residual current circuit breaker provides protection from fault currents due to directly or indirectly touching live parts.



Residual current circuit breaker for direct contact

If a residual current circuit breaker is used to provide protection from direct contact, an **unregulated** isolating transformer must be used (EN 50178 section 5.2.11.1, VDE 0160). This is because the fault current resulting from the design is >30 mA.

Residual current circuit breaker for indirect contact

If a residual current circuit breaker is to be used to provide protection from indirect contact, this must be selected depending on the machine's fault current.

Note

In rare cases, customer-side voltage fluctuations on the machine's power input filter may lead to higher fault currents than the typical value specified. The main electricity supply and the machine must then be separated by an **unregulated** isolating transformer.

If a residual current circuit breaker is used, observe the following requirements:

BendMaster (60)	BendMaster (150)	BendMaster with handling equipment
Type S	Type S	Type S
Selective	Selective	Selective
Sensitive to all types of current + resistant to current surges 5 kA	Sensitive to all types of current + resistant to current surges 5 kA	Sensitive to all types of current + resistant to current surges 5 kA
Tripping current of 300 mA	Tripping current of 300 mA	Tripping current of 300 mA

Values for residual current circuit breaker

Tab. 2-14

Line structures

Power supply with grounded outer conductor (corner-grounded delta network)

When connecting the machine to a power supply with a grounded outer conductor, an **unregulated** isolating transformer must be used.

NEC conditions

Power supply configuration:

- A power supply in star connection and with a grounded star point (solidly grounded wye) is required.
- If the existing power supply is in delta connection (corner grounded delta), the customer must install a grounded unregulated isolating transformer in star connection (with grounded star point) (see NEC item 450-5).

Grounding:

- The machine and power distributor system must be equipped with a grounding line in accordance with NEC article 150, "Grounding".
- For details on grounding power distributor systems and industrial plants, refer to the NEC standards or consult an electrician or the power station.

IT network

A surge diverter is required if the machine is connected to an IT network.

TRUMPF recommends surge diverters from the following manufacturers:

- Phoenix Contact GmbH & Co. KG, Flachsmarktstraße 8, D-32825 Blomberg, E-mail: info@phoenixcontact.com.
- Dehn+Söhne, PO Box No. 1640, D-92306 Neumarkt, E-mail: info@dehn.de.

4.3 Network link

TRUMPF provides the following interfaces for the network (e.g. connection to a programming system) in the switch cabinet of the machine:

- RJ 45 plugs for customers with shielded-twisted pair network cabling.

5. Transport

The arrangements and transport of the system from the truck to its final installation site need to be prepared and carried out.

Machine conveyance to customer's site by TRUMPF

In some countries the customer can have TRUMPF transport the system from the truck to the final installation site, the so-called "Machine conveyance to customer's site". The transport route may not exceed the length contractually agreed to. The transport route must be flat, with no steps or ramps.

If the customer has assigned TRUMPF with conveying the machine to the customer's site, the customer must only ensure that the transport route satisfies the requirements mentioned below. TRUMPF will deal with all the other points mentioned in the following, including auxiliary tools and means of transportation.

5.1 Preparing transport

Before the machine is delivered, check the following:

- Is there sufficient space for transport to the installation site?
- Can the floor can be crossed with armored rollers, etc.?
- Are the gateway openings, header heights and cable rack heights sufficient?

Transport dimensions

	BendMaster (60)	BendMaster (150)
Max. part size	3000 mm (118 in)	3000 mm (118 in)
Max. weight incl. packaging	700 kg (1543 lb)	864 kg (1905 lb)
Floor lane dimensions of each 2000 mm element (79 in)	310 kg (683 lb)	310 kg (683 lb)

Dimensions and weight

Tab. 2-15

5.2 Permitted auxiliary tools

If the machine is conveyed to the customer's site by Technical Service, the required means of transportation and auxiliary transport equipment is provided by them.

Note

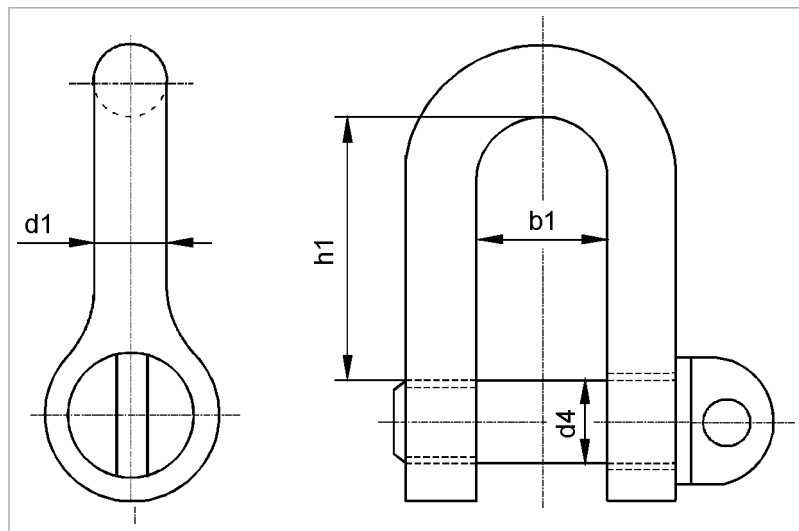
The carrying capacity of the authorized auxiliary equipment must be selected in such a way that the maximum load can be transported safely.

	BendMaster (60)	BendMaster (150)
Authorized additional equipment	Carrying capacity	Carrying capacity
Crane truck for unloading the truck	At least 1 t (2205 lb)	At least 1 t (2205 lb)
Indoor crane for transporting the machine	Recommendation: At least 1 t (2205 lb)	At least 1 t (2205 lb)
When transporting with a crane: two type A shackles (DIN 82101)	According to the machine weight	According to the machine weight
For transport with a crane: adjustable crane chain	According to the machine weight	According to the machine weight
Lifting belt	According to the machine weight	According to the machine weight

Permitted auxiliary tools

Tab. 2-16

Shackle When transporting the machine with a crane: use two type A shackles (DIN 82101):



Type A shackle

Fig. 52814

BendMaster (150): TruBend on a platform

In combination with the BendMaster (150), the press brake (TruBend 5000 series) must be put on a platform.

Notes

- The TruBend may only be lifted on to the platform using an indoor crane or mobile crane or a hydraulic hoisting jack. All other methods are **not permissible**.
- If a mobile crane is also not possible for space reasons, then the customer must organize this activity himself, e.g. by assigning a local installation company. Information on this can be requested from TRUMPF Maschinen Austria.

- The TruBend is normally lifted with hydraulic hoisting jacks and the pedestal bases installed under the press brake. If the customer is not able to put the TruBend on a pedestal, an external installation company can be called in to do this. Information about this can be requested from TRUMPF Maschinen Austria.

5.3 Checking, unloading and transporting the machine

On delivery: check the machine

1. Examine all components for any transport damage.
2. Record visible damage caused during transport on the cargo note and have the record countersigned by the truck driver.
3. Report any hidden transport damage to the insurance company and TRUMPF within six days.

Unloading and transporting the machine

 **DANGER**

Suspended load!

Falling loads could lead to severe bodily injury or even death.

- Observe safety regulations for the handling of heavy loads.
- Never walk under a suspended load.
- Use tested and appropriately sized tackle and means of transportation.
- Employ qualified technicians to transport the machine.
- Carry out transport in accordance with the transport regulations.

1. Remove the packaging.
2. Unload the BendMaster with a crane.
3. Remove securing devices for shipping.
4. Transport the accompanying accessories box and any accessory parts that may be separately packaged directly from the truck to the installation site with a forklift.
5. Transport the BendMaster to the installation site using an indoor crane with sufficient carrying capacity.

Chapter 3

Description

1	Machine concept	3-3
2	Technical data	3-4
2.1	BendMaster	3-4
2.2	BendMaster axes	3-5
3	The most important assemblies	3-6
3.1	Nameplate	3-6
3.2	Floor lane	3-7
3.3	Arm	3-7
3.4	BendMaster switch cabinet	3-7
3.5	Sheet sensor	3-8
3.6	Rotational transformer	3-9
3.7	Safety fencing	3-9
3.8	Control panel	3-9
3.9	Easy operation	3-10
3.10	Sensor gauge fingers at the TruBend Series 5000	3-11

	4-axis sensor gauge finger	3-12
	6-axis sensor gauge finger (optional)	3-13
	Backstop resistor	3-14
4	Options	3-15
4.1	Extendable floor lane	3-15
4.2	Gripper	3-15
	Vacuum gripper	3-15
	Multi-gripper	3-17
	Multiple-circuit suction cups	3-17
	Gripper construction kit	3-18
4.3	Special gripper	3-19
	Magnetic gripper	3-19
	Linear gripper	3-19
	Pivoted-jaw gripper and pivoted-jaw gripper with turning axis	3-20
4.4	Sheet removal station	3-21
4.5	Double sheet recognition and double sheet separation	3-22
	Double sheet recognition	3-23
	Double sheet separation	3-24
4.6	Regripping station	3-24
4.7	Gripper changing console	3-25
4.8	Backlighting table	3-25
4.9	Productivity package	3-26
4.10	Mobile fanning magnet	3-27
4.11	Handling equipment	3-27
4.12	Store connection	3-28
4.13	TruTops°Bend	3-29
5	Options at the TruBend	3-30

1. Machine concept

Within the TruBend Cell 5000 bending cell, the bending process at the press brake can be performed fully automatically using the BendMaster handling system. The BendMaster has the following features:

- Four rotational axes and a linear axis as floor lane
- Sheet sensor for workpiece recognition.
- Offline programming with TruTops Bend.
- Very high flexibility due to the option of configuring the loading and unloading positions, the length of the floor lane, gripper changes and the regripping unit as desired, as well as due to a sheet removal station for small parts automation and conveyor belts for transfer out of the cell.
- Suitable both for automatic, unmanned operation as well as for manual operation with BendMaster in home position and with the safety fencing closed.
- BendMaster (60) or BendMaster (150) for different load capacities.

2. Technical data

2.1 BendMaster

			BendMaster (60)	BendMaster (150)
services	Max. load capacity	[kg]	60	150
	Max. workpiece weight	[kg]	40	110
	Max. workpiece dimensions	[mm]	1000 x 2000	3000 x 1500
	Min. workpiece thickness	[mm]	0.7	0.7
	Max. workpiece thickness	[mm]	Specified by max. workpiece weight	Specified by max. workpiece weight
	Max. working range of the Z axis (standard version)	[mm]	2600	4600
Dimensions (space in front of the press brake)	Wide standard version	[mm]	4725	8160
	Depth from TruBend bending line	[mm]	5395	5395
	Distance between BendMaster and TruBend	[mm]	1270 (TruBend 5050 to 5130) 1230 (TruBend 5170 to 5320)	1650
	Weight	[kg]	620	784
	Floor lane	[m]	4 Extendable up to 14 m in steps of 2 m	6 Extendable up to 16 m in steps of 2 m
	Floor lane weight per 2000 mm element	[kg]	310	310
Control station dimensions (outside the safety fencing)	Height	[mm]	1020	1020
	Width	[mm]	870	870
	Depth	[mm]	650	650
Speeds	Floor lane (Z axis)	[mm/s]	2000	2000
	A axis	[rpm]	20	20
	B axis	[rpm]	25	25
	C axis	[rpm]	45	45
	Rotary table (D axis)	[rpm]	45	45
Positioning accuracy	Z direction	[mm]	± 0.5	± 0.5
	Coupling center absolute	[mm]	< 0.1	< 0.1
Connected loads	Electrics	[V]	3 x 400 at 50 Hz	3 x 460 at 60 Hz
		[A]	16	16
	Pneumatics	[bar]	6 (dynamic pressure) 24 m³/h temporarily	6 ±1 (dynamic pressure) 42 m³/h temporarily

		BendMaster (60)	BendMaster (150)
Control system	TRUMPF CNC		

Technical data

Tab. 3-1

2.2 BendMaster axes



Axes of the BendMaster

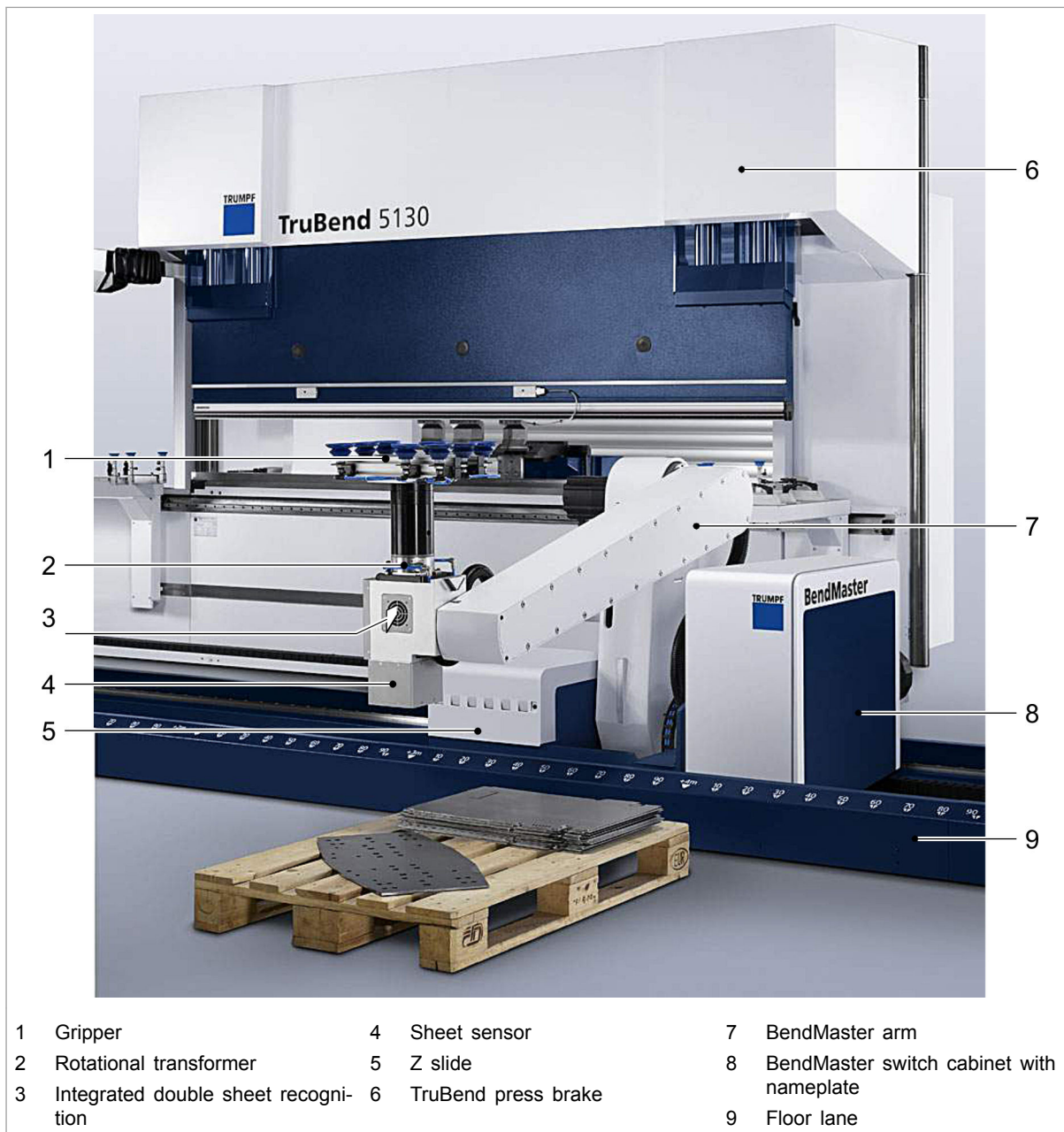
Fig. 58860

Axis	Description	Drive
Z axis	Floor lane	Belt drive via synchronous motor and omega drive
A axis	Rail interpolation for arm movement	Drive via synchronous motor, eccentric gear
B axis	Rail interpolation for arm movement	Drive via synchronous motor, eccentric gear
C axis	Rail interpolation for arm movement	Drive via synchronous motor, eccentric gear
D axis	Rotary table without end position	Drive via synchronous motor, eccentric gear

BendMaster axes

Tab. 3-2

3. The most important assemblies



The most important assemblies

Fig. 58810

3.1 Nameplate

The nameplate with the CE marking is located on the rear side of the switch cabinet and on the inside right of the switch cabinet.

3.2 Floor lane

The floor lane is a linear guide system with belt drive. The BendMaster is moved on it in lateral direction.

Modularly extendable

The floor lane is the connection to the factory floor. It can be modularly extended with 2000 mm elements. The maximum length is 14000 mm (BendMaster (60)) or 16000 mm (BendMaster (150)).

NOTICE

The covering of the floor lane is not designed for standing on or storing parts on it!

Damage to the floor lane.

- Do not step on the covering.
- Do not deposit any workpieces on the covering.

3.3 Arm

The arm consists of three individual parts, which are connected to each other with joints. The arm is moved by the rail interpolation of three drives.

Loading/unloading and bending

Turned away from the press brake, the arm is used to load and unload the BendMaster. The arm faces the press brake during the bending process.

The loading and unloading area may also be positioned next to the press brake. In this case, the arm also faces the brake press during loading and unloading.

A BendMaster with conveyor system enables loading and unloading from all sides.

Additional functions next to the press brake

Additional functions are possible in addition to the press brake, e.g. backlighting table, if the floor lane is of sufficient length.

3.4 BendMaster switch cabinet

Traveling version

The BendMaster switch cabinet travels along the machine body of the BendMaster. It is equipped with the controllers for the servo-drives, an industrial PC and the control and power electronics for the sheet sensor.

This industrial PC controls the drive axes and evaluates the data of the sheet sensor. The industrial PC is connected to the porta-

ble manual control unit and the press brake in real time and linked to the control cabinet of the BendMaster.

3.5 Sheet sensor

The BendMaster is operated with a sheet sensor used to identify the position of the workpieces.

Sensor head The sensor head consists of two CCD cameras (rough and fine recognition), four diodes that collectively generate a green flash and a green diode laser for height measurements.

Signal processor The performance data is recorded and evaluated by an industrial PC in the switch cabinet of the BendMaster.

Sheet sensor functions The sheet sensor performs the following three functions one after another:

- Rough recognition of the workpiece stack.
- Height measurement of the workpiece stack.
- Fine recognition of the workpiece.

Rough recognition of the workpiece stack The camera takes a picture of the pallet with workpiece stacks. It may be composed of several individual images. The working area lighting of the BendMaster is used for this purpose.

CAD data of the workpiece is saved in the computer. This data is used to create reference models. The respective pattern is searched for in the recorded image and the position of the workpiece is determined if the pattern is found.

This position data is used to bring the sensor head into the right position for height measurement and/or fine position recognition of the workpiece.

The rough recognition process only has to be performed once for each loading cycle, since the pallet with the workpiece stacks can no longer be moved after loading the bending cell.

Measurement of the workpiece stack height The precise distance between the workpiece and the gripper must be determined. A diode laser projects a laser cross into the camera vision range for this purpose. The distance is calculated by means of triangulation.

The height of each workpiece stack is measured once by default. The BendMaster automatically calculates the height of the remaining workpiece stack since it knows the sheet thickness of the workpiece.

The height of the workpiece stack can be measured after every xth workpiece. Potential errors due to inaccuracies of the sheet thickness are compensated for in this way.

Fine recognition of the workpiece

The precise position of the workpiece is determined (± 0.2 mm) in order to position the gripper properly. To avoid daylight influences, narrowband flash lighting (green LED flash) is used for the fine recognition process.

This process can be carried out twice at different points of long components to avoid angle errors.

The workpiece can be picked up after it has been positioned precisely. If *Backlighting table* "load mode" was selected, fine recognition is carried out on the separately installed backlighting table without a diode flash.

3.6 Rotational transformer

A continuous rotational transformer is integrated in the D axis, which allows the D axis to be rotated without an end position. The rotational transformer transfers compressed air, vacuum, AS-i bus signals and 24 V DC for the vacuum gripper.

It is driven by an attached servomotor.

3.7 Safety fencing

The safety fencing prevents access of persons in automatic and manual press mode and also prevents workpieces from falling out of the machine.

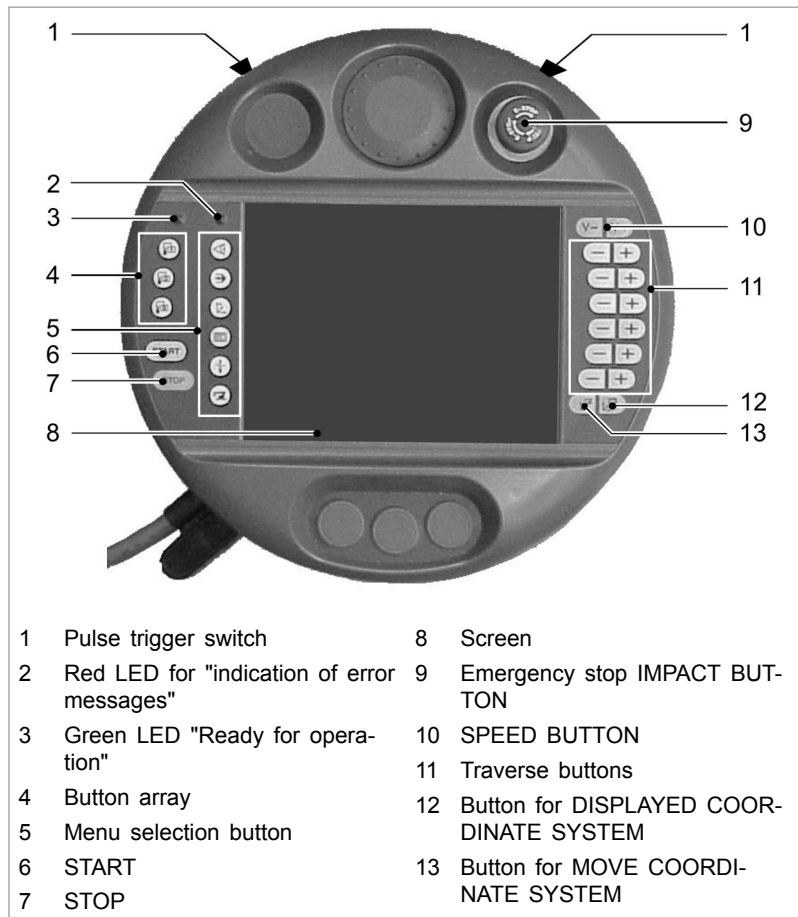
Monitored sliding doors allow controlled access in order to load, unload and refit the machine.

3.8 Control panel

There is a control panel outside the safety fencing. A portable manual control unit with 8.4" screen is also there. A stationary 19" screen can be optionally connected.

The control panel can be integrated in a corporate network which can be used for offline programming.

The control panel is connected to the traveling control unit in the switch cabinet of the BendMaster and to the control of the press brake via a local network.



Portable manual control unit

Fig. 39796

Tip

Reset the program at the manual control unit:

- Press the following keys simultaneously:
<Robot> menu, <Position> menu, <V+>.

The control panel also contains the visualization computer and the control cabinet of the BendMaster. The main switch is on the front side.

The visualization computer is connected via the local network to the industrial PC in the switch cabinet of the BendMaster.

3.9 Easy operation

A stationary 19" screen can be set up on the control panel in addition to the portable manual control unit with 8.4" screen. A keyboard and mouse are also provided with the screen.

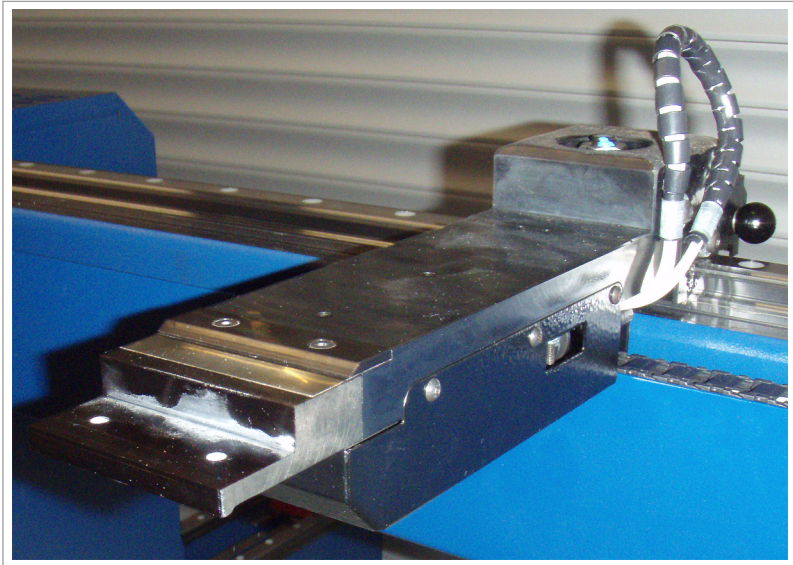


Fig. 68676

3.10 Sensor gauge fingers at the TruBend Series 5000

If the BendMaster is used, the standard equipment of the TruBend Series 5000 includes sensor gauge fingers. The sensors recognize automatically when the sheet is up against or on gauge fingers.

4-axis sensor gauge finger



Sensor gauge finger on 4-axis backgauge

Fig. 59277

The middle part of the gauge finger protrudes slightly on the face side and at the bottom support and can be pressed in.

The BendMaster presses the workpiece to be bent against the sensor gauge finger. The control releases the press beam for bending only once the workpiece rests properly against the sensor finger.

It cannot be positioned against the top support of the gauge finger in BendMaster mode.

6-axis sensor gauge finger (optional)



Fig. 41696

The linear movement in X direction and the stopping process in Z direction are identified by inductive path measurement sensors and transferred to the control system.

The control system releases the press beam for bending only once the workpiece rests properly against the sensor finger.

Stop block for small parts (optional)

The stop block for small parts is screwed on to the existing gauge fingers. Small parts on both the sensor fingers can thus be stopped.

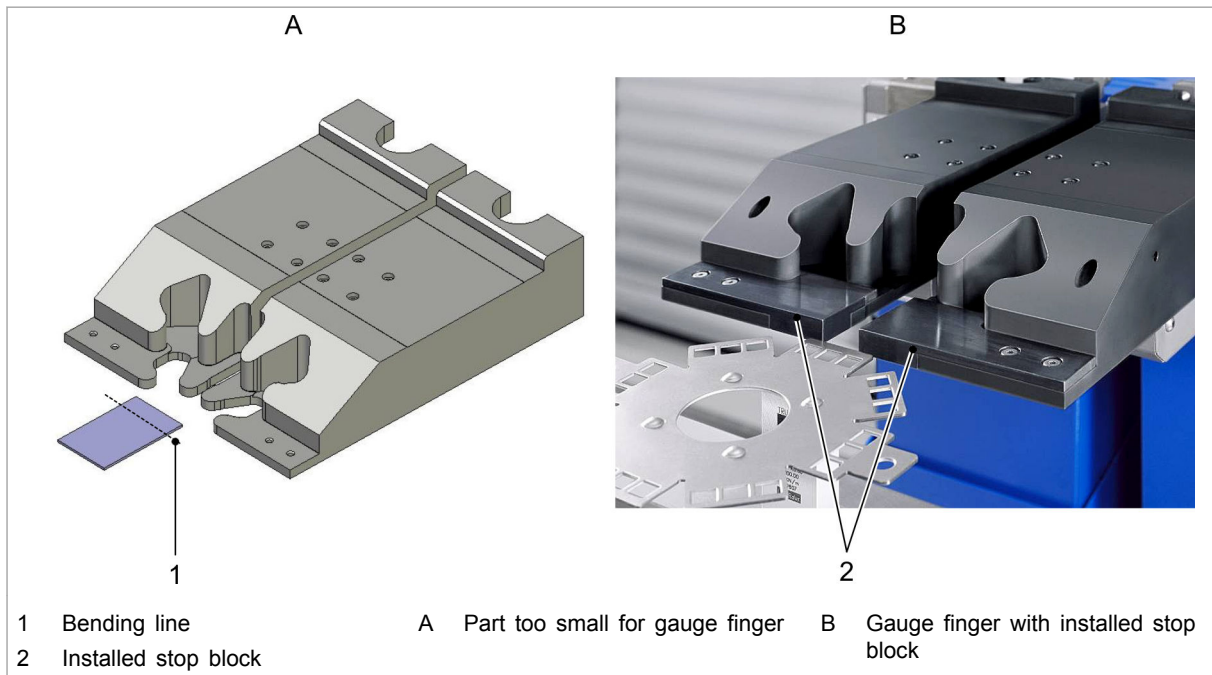


Fig. 54688

Backstop resistor

Magnets that can be cut in are located on the sensor gauge fingers which may form an additional backstop resistor:

- Backstop resistor is cut in:
Thick workpieces must overcome the spring force of the sensor gauge and the magnetic force of the backstop resistor when stopping. This ensures that the workpiece weight does not trigger a backstop travel motion prematurely.
- Backstop resistor is not switched:
Thin sheets need only overcome the spring force of the gauge sensor when stopping.

4. Options

4.1 Extendable floor lane

The floor lane can be modularly extended up to 14,000 mm (BendMaster (60)) or 16,000 mm (BendMaster (150)) using 2000 mm elements. They allow the BendMaster to be adapted individually to any production site.

4.2 Gripper

The "Robot in tool change position" travel function can be used to move the BendMaster to the manual tool change position in order that the gripper can be changed manually (see "Gripper service", pg. 4-27).

If a gripper changing console is present, then a change of gripper can be carried out automatically (see "Automatic gripper change (option)", pg. 4-28).

Vacuum gripper

Vacuum grippers are operated with vacuum. They are suitable for all materials in sheet machining and for smooth sheet surfaces. No holes are permitted in the workpiece within the suction cup area.

Setup Vacuum grippers consist of up to five parts:

- Gripper changing plate.
- Base plate.
- Suction cups.
- AS-i module for separating.
- Pneumatic cylinders for the separation process.

The coupling is used to connect the vacuum gripper (and any other grippers) to the gripper changer of the BendMaster.

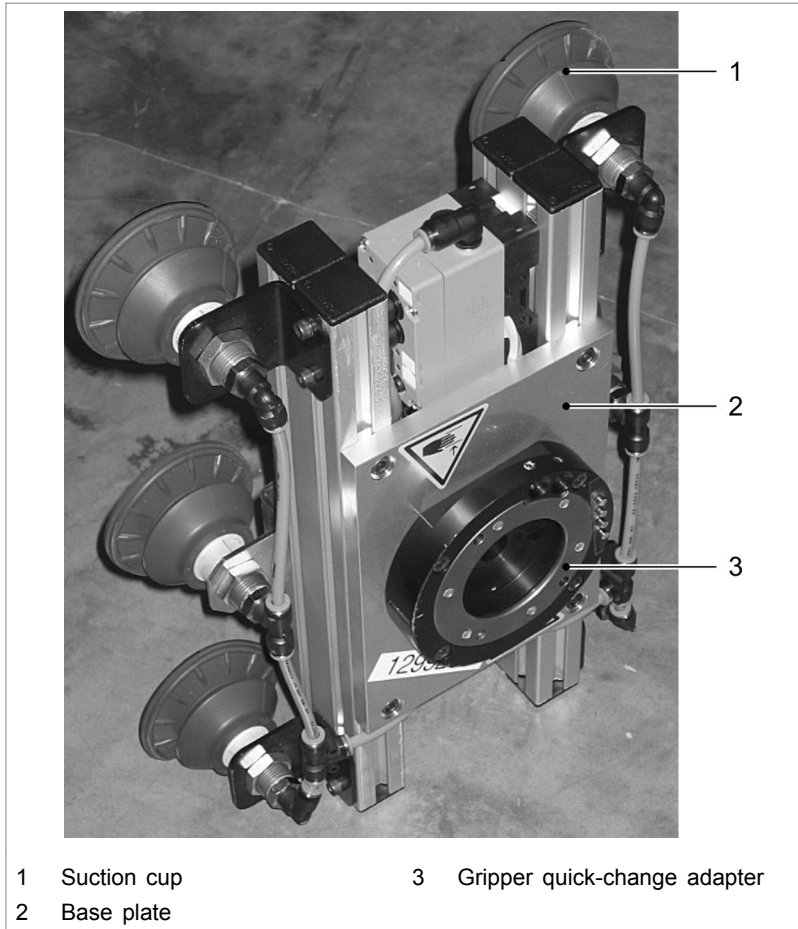


Fig. 41774

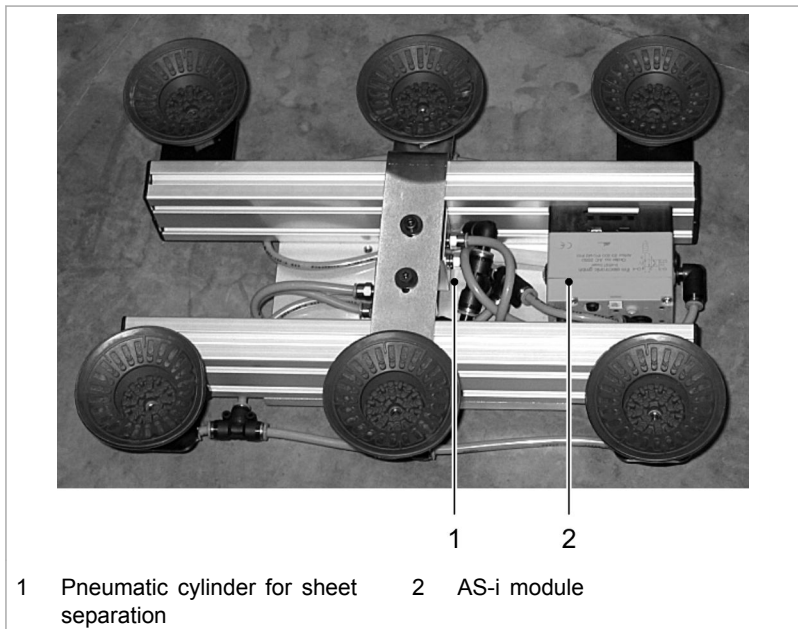
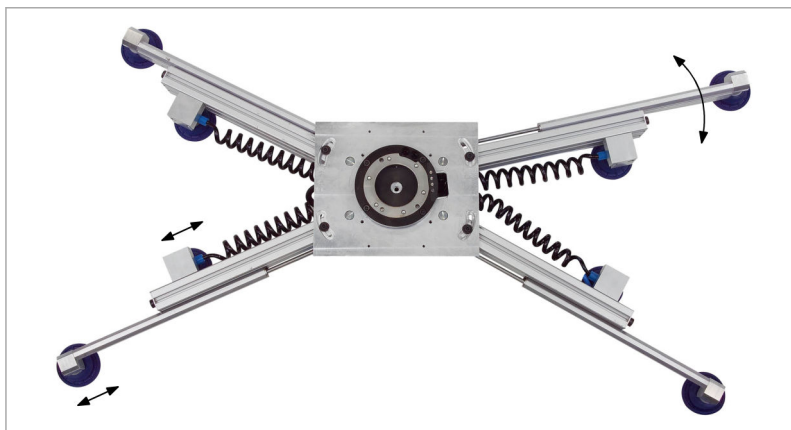


Fig. 41775

Multi-gripper

The multi-gripper is a multifunctional gripper tool which can be used to pick up sheets of various sizes, depending on the weight:



Multi-gripper

Fig. 43875

- Minimum size: from 900 x 200 mm to 700 x 700 mm.
- Maximum size: from 1350 x 200 mm to 1000 x 1000 mm.

Not only can each of the four inner and outer suction cups be adjusted on the multigripper, the arms with the suction cups can also be moved to the left and right.

Their individual activation allows individual vacuum circuits to be switched on or off separately (see multi-gripper operator's manual).

Multiple-circuit suction cups

Multiple-circuit suction cups are multifunctional gripper tools of which the shape can be adapted to the customer's part.

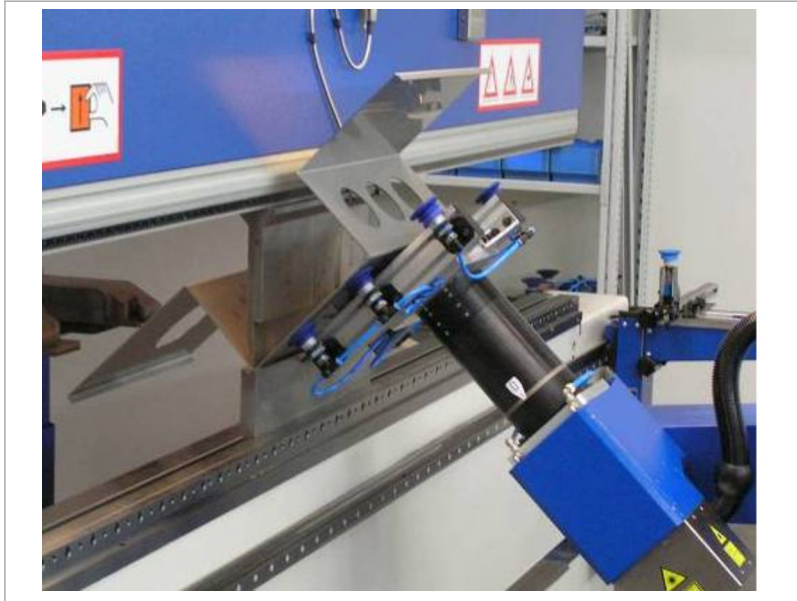


Fig. 51329

They are suitable in particular for components which become increasingly smaller, since the individual suction cup circuits can be switched on or off separately due to the individual suction cup activation.

Gripper construction kit

The gripper construction kit is a modular system which consists of various gripper components, such as coupling, valves and suction cups.



Fig. 43874

The construction kit contains components for three grippers; optionally with separation.

4.3 Special gripper

Magnetic gripper

The magnet gripper has two pneumatically adjustable magnets. This means that magnetic workpieces which have e.g. many recesses or which are made of perforated sheets can still be reliably gripped.

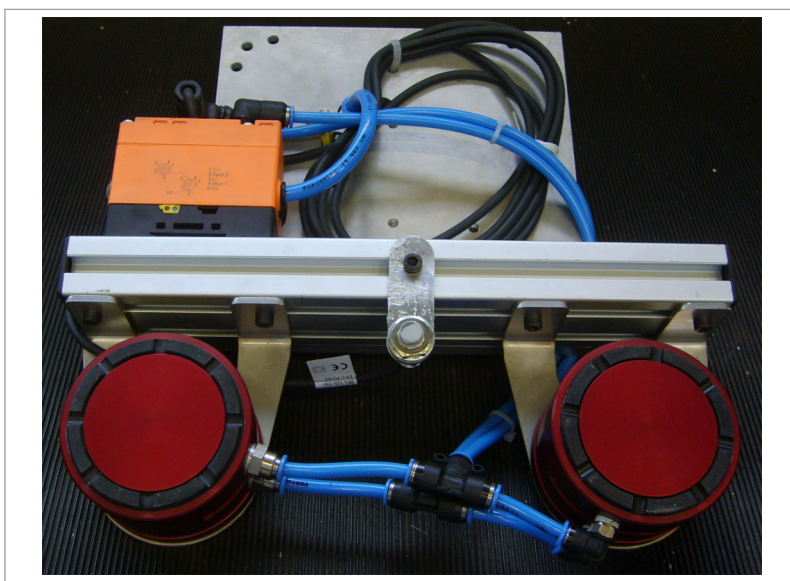
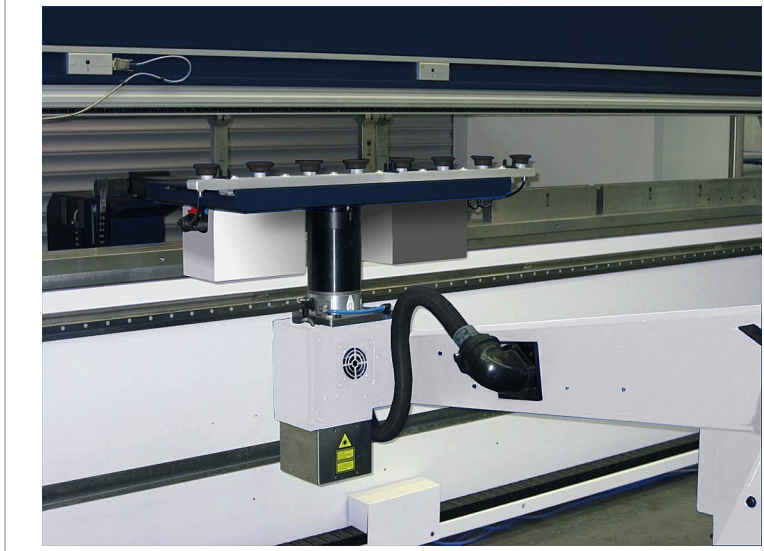


Fig. 58424

Linear gripper

The linear gripper is a vacuum gripper used preferably for profile parts. Excess regripping is prevented by the eccentricity of the suction bar.

The gripper consists of a travel path, onto which a pneumatically displaceable suction cup slat is placed. The suction cups can be manually displaced on the travel path.



Linear gripper at the BendMaster

Fig. 61839

The suction bar can approach two positions: left end position and right end position. Both positions are monitored by proximity switches.

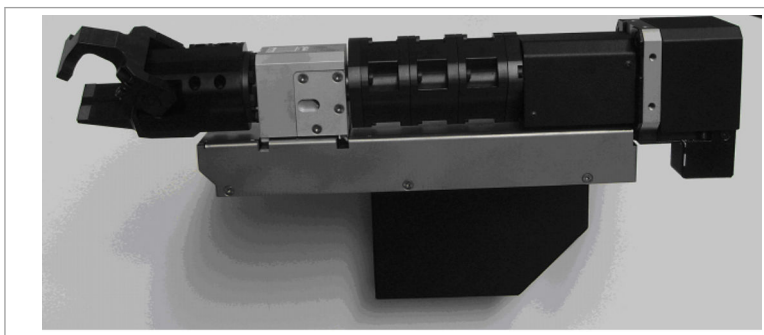
Traverse path between the end positions: 316 mm

Note

For operation, see the supplement to the BendMaster operator's manual "Linear Gripper Option".

Pivoted-jaw gripper and pivoted-jaw gripper with turning axis

In case of small sheets, the pivoted-jaw gripper is used together with a sheet removal station.



Pivoted-jaw gripper

Fig. 49441

Note

The software version TruTops Bend 5.0 or higher is required for programming the pivoted-jaw gripper.

Maximum weight	1.5 kg
Maximum size	210 x 297 mm (A4 format)
Sheet thickness	0.75 - 6 mm

Technical data of the workpiece

Tab. 3-3

The pivoted-jaw gripper is placed on a linear slide which can approach two positions from the middle of the coupling: either 160 mm to the left or 160 mm to the right.

The eccentricity of the pivoted-jaw gripper that is thus achieved prevents frequent re-gripping which would be required due to the collision contour of the BendMaster.

Many different parts geometries can be machined with different gripper jaws.

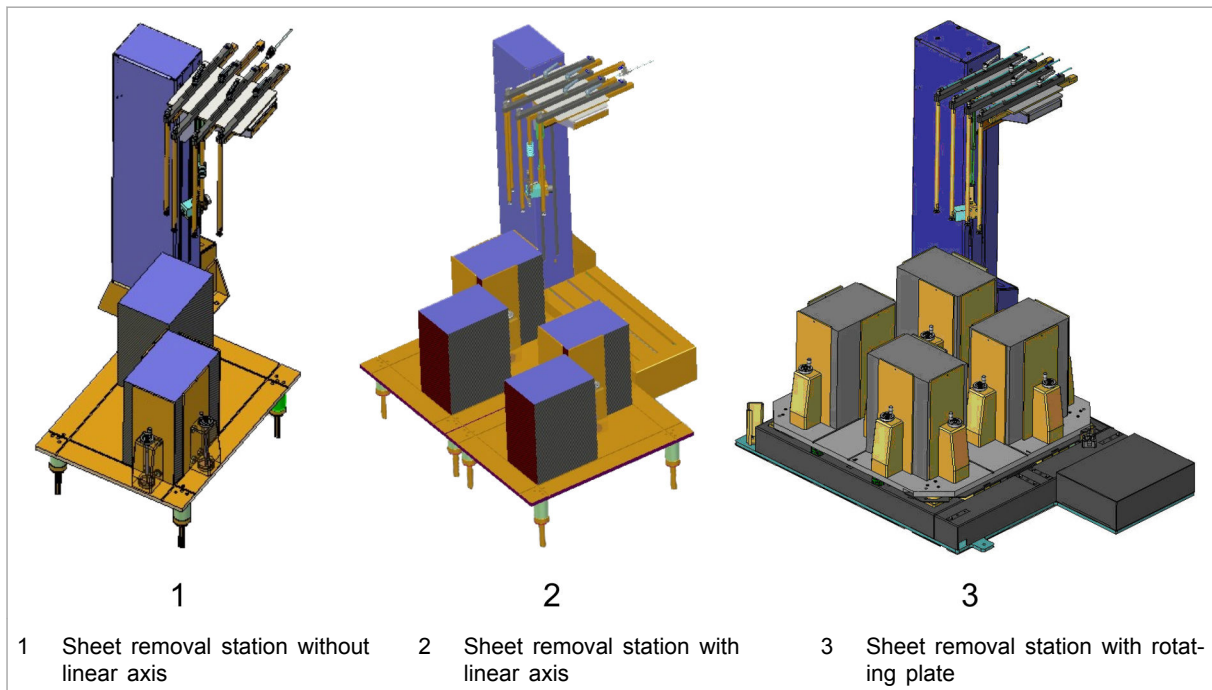
A pneumatically driven turning axis (option) can rotate the gripper through 180°. The number of regripping operations can thus be further reduced.

4.4 Sheet removal station

Small parts are separated from the sheet stack and transferred to the pivoted-jaw gripper at the sheet removal station.

There are two sheet removal station variants:

- Sheet removal station without a linear axis, where the sheets can be separated and removed from a pallet.
- Sheet removal station with a linear axis, where the blanks can be separated and removed from two pallets.
- Sheet removal station with rotary pallet with which sheets can be separated and removed from four pallets.



Sheet removal station

Fig. 54689

Maximum sheet weight	1.5 kg
Maximum sheet size	210 x 297 mm (A4 format)
Maximum sheet thickness	0.75 - 6 mm

Tab. 3-4

The suction cups of the sheet removal station pick up the sheet. At the same time, double sheet recognition and if required, double sheet separation can be carried out.

The sheet removal station prepares the next sheet during BendMaster operation.

Note

For operation, see Supplement to the BendMaster Operator's Manual, "Option for small parts (pivoted-jaw gripper)".

4.5 Double sheet recognition and double sheet separation

Slightly oiled sheets stick together easily. For this reason or other reasons, the BendMaster may pick up two or more workpieces at the same time. Two systems are available to prevent this:

- Double sheet recognition
- Double sheet separation

Double sheet recognition

Integrated double sheet recognition

The double sheet recognition process is performed by means of three sensors in the C arm of the BendMaster.

When a part is picked up, its weight is measured and compared with the reference value from TruTops Bend.

Each time a workpiece is picked up by the BendMaster, its weight is measured and compared to the reference value so that it does not go unnoticed if a double-sheet is picked up.

The minimum permissible weight of a sheet is 400 g.

With pallet scale **Note**

Double sheet recognition with a pallet scale is carried out on BendMaster systems which do not have the integrated double sheet recognition option.



Pallet scales for double sheet recognition

Fig. 38423

Double sheet recognition is carried out using pallet scales. When a part is picked up, its weight is measured and compared with the reference value from TruTops Bend.

You can tell whether one or more workpieces have been picked up by the BendMaster each time a workpiece is picked up by the reduction in weight on the pallet scales.

The measurement range of the pallet scales is 0 to 1500 kg. The maximum load must not exceed 3000 kg (e.g. when using a stacker for loading). The minimum permitted weight of a blank is 200 g.

Double sheet separation

If several workpieces are picked up by the BendMaster, they can be separated mechanically by the double sheet separation system.

Gripper The gripper is used to bend the workpieces. The workpieces bend easily, however the degree of bending is always within the elastic range. This bending process exerts a force on the two workpieces, resulting in a peeling effect.

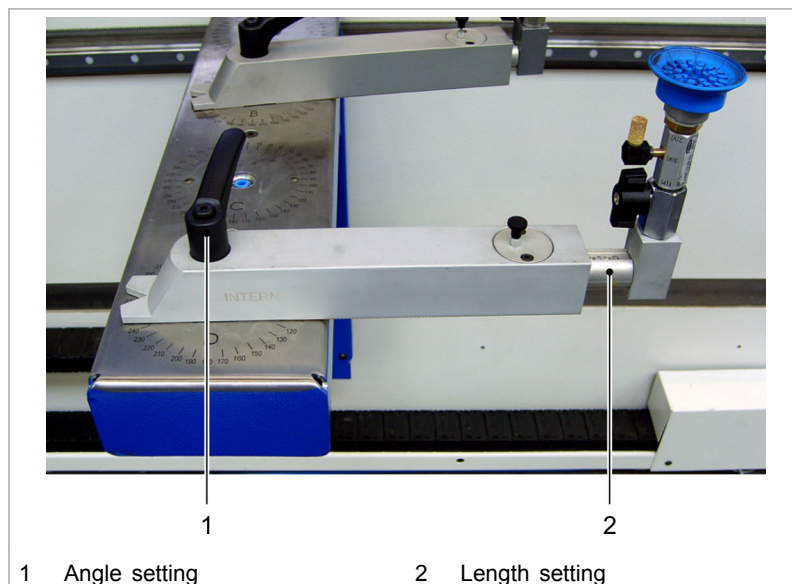
Travel movement The BendMaster performs a travel movement. The workpieces bend easily, however the degree of bending must always lie within the elastic range. This bending process exerts a force on the two workpieces resulting in a peeling movement.

4.6 Regripping station

The regripping station is used if it is not possible to re-grip the workpiece by clamping it between the upper and lower tool.

The regripping station is programmed in the TruTops Bend programming system. The designation of the gripper is Z3 for the left gripper side and Z4 for the right gripper side.

The gripper arm positions to be set are displayed in the tooling plan along with the angle and length of the suction cup extension.

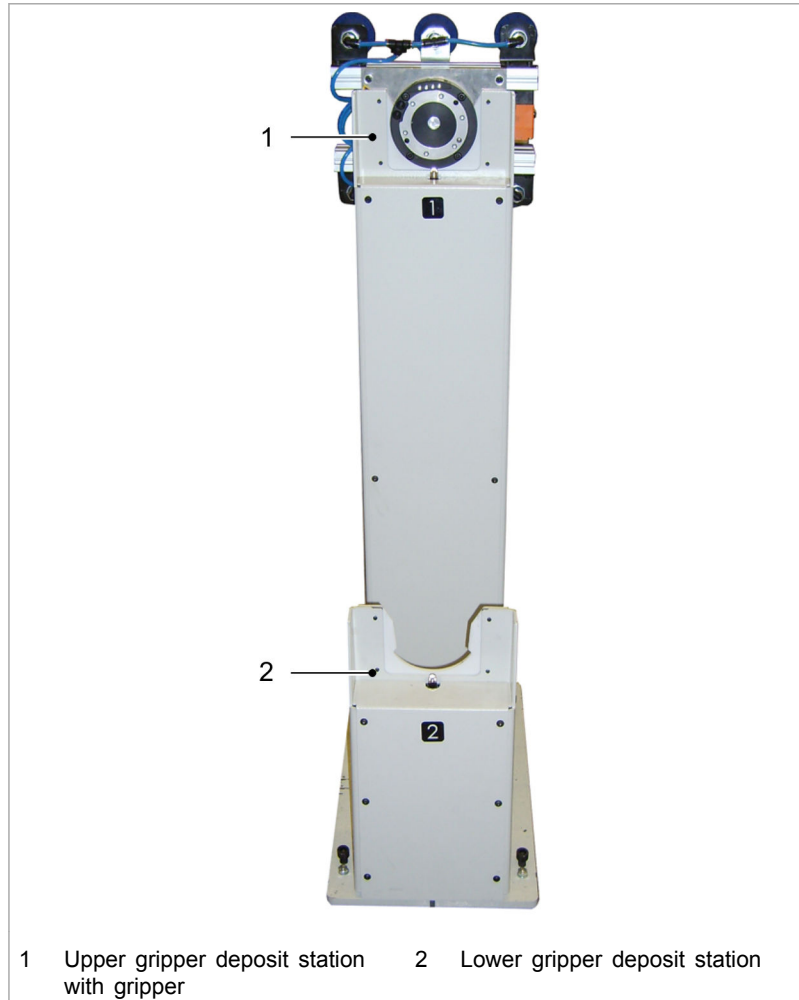


Regripping station

Fig. 41347

4.7 Gripper changing console

An automatic gripper change is possible with a gripper changing console. Two grippers (three with BendMaster (150) per gripper changing console) can be deposited inside. Modular extension of up to four gripper changing consoles is possible.

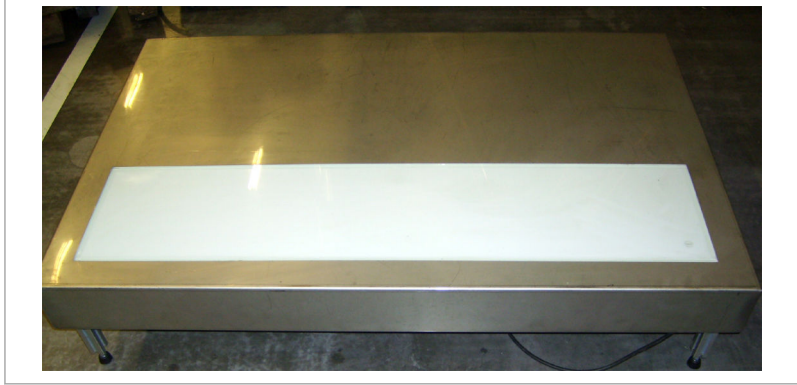


Gripper changing console

Fig. 53017

4.8 Backlighting table

A backlighting table must be used for the fine recognition of workpieces with critical surfaces (e.g. galvanized, glossy).



Backlighting table

Fig. 38422

The workpiece is picked up and set down on the backlighting table on the basis of the data acquired by the BendMaster from the rough recognition process and the measurement of the workpiece stack height.

The fine recognition process is performed on the backlighting table. The backlighting for image recording makes it easier to identify the contours of the workpiece.

4.9 Productivity package

The productivity package can, depending on the gripper and the part geometry, be used to increase productivity from 15 to 25 %.

The productivity increase is achieved via synchronized travel motions and optimized continuous path control of the robot:

- Axes control optimization:
 - Torque pre-control: exact pre-calculation of the necessary drive torque and drive force.
 - Torque limiting: makes it possible to follow robot paths quickly and precisely, since the maximum possible torque and drive torque is calculated while the process is being carried out and thus can be optimized.
- Gripper movements can be run in parallel.
- Optimization of regripping operations during bending.
- Optimized traverse paths of the backgauge:
 - X axis withdrawal takes place at the same time as bending operation.
 - The backgauges are equipped with magnets.
- Faster data exchange between press brake and BendMaster.

System requirements:

- TruTops Bend V2.9 or higher.
- TASC6000 V8.2 or higher.
- TruBend Cell 5000 V07.00.07 or higher.

4.10 Mobile fanning magnet

The mobile fanning magnet can be used to separate oiled, ferro-magnetic sheets that have become stuck together.

The fanning magnet is positioned at the sheet metal stack. There it creates several magnetic poles which repel each other. This effect causes to the separation of the sheets that have become stuck together.

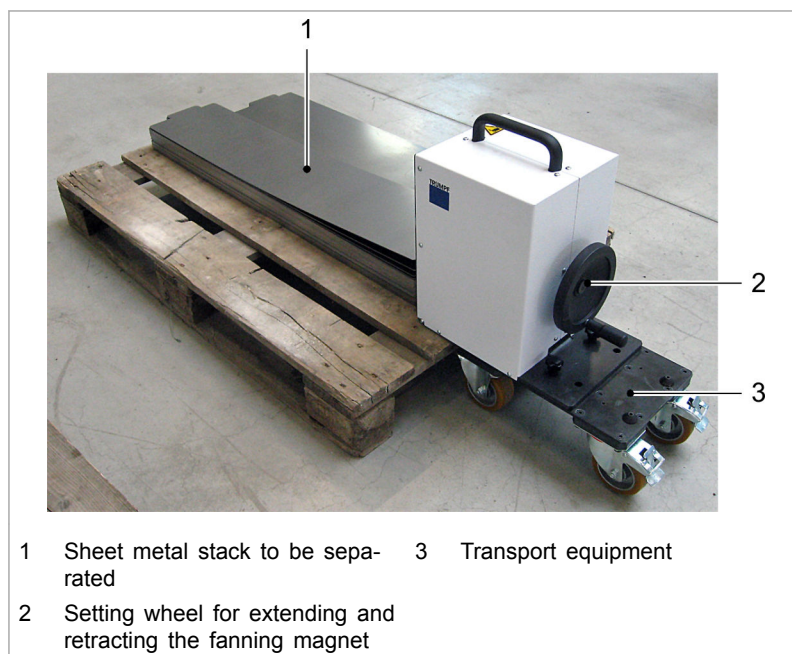


Fig. 67036

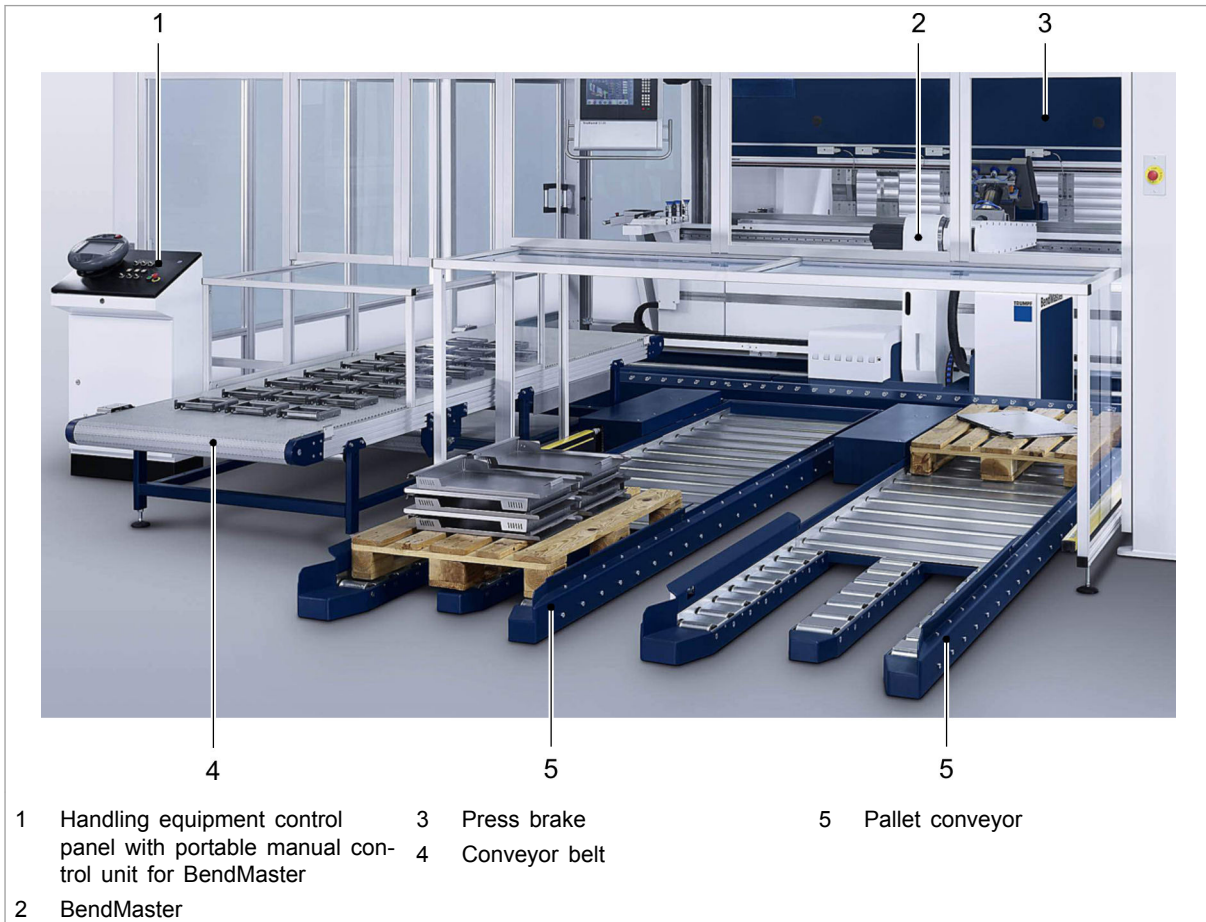
Note

For operation, see the "Fanning magnet" operator's manual.

4.11 Handling equipment

The material feed and part removal processes can be automated by means of a conveyor system.

Pallet conveyors with rollers transport pallets or boxes; conveyor belts transport finished single parts, that are hard to stack for example.



Handling equipment for the BendMaster

Fig. 61948

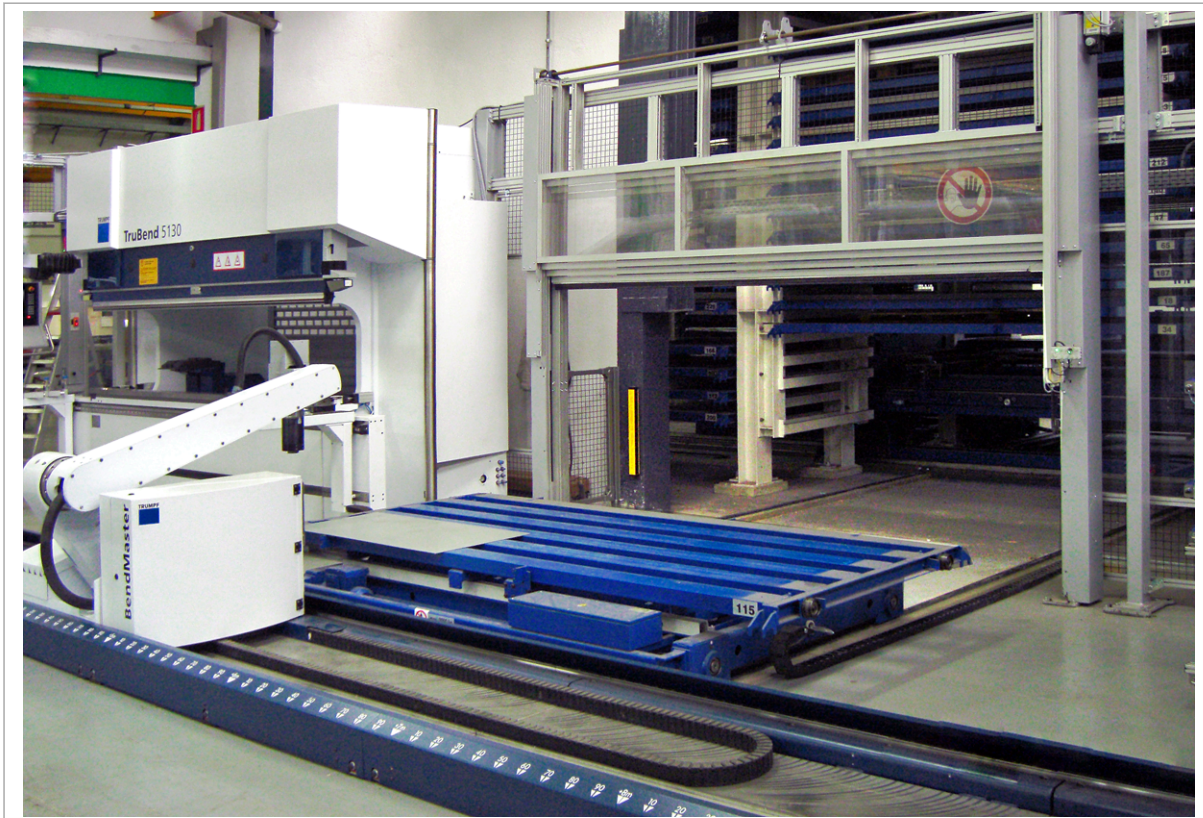
Note

For operation, see Operator's manual for transport equipment

4.12 Store connection

The TruBend Cell 5000 can be linked to a storage system. The interface with the storage system is established by means of a storage cart. The parts are booked using the TruTops Fab software, Storage module.

The BendMaster can not only request raw material from the storage system, it can also return finished parts to the storage system.



TruBend Cell 5130 with connection to storage

Fig. 59979

Note

For operation, see "Supplement to the BendMaster Operator's Manual, Connection to storage (option)".

4.13 TruTops°Bend

TruTops Bend is the programming system for the bending technology. There is an additional module for TruToPs Bend, which can be used to program the BendMaster. This allows two NC programs (TruBend and BendMaster) to be created with a single program.

Operation See "TruTops Bend Software Manual".

5. Options at the TruBend

The following TruBend options must be available if work on the TruBend is to be automated with a BendMaster:

- CNC-crowning.
- Hydraulic tool clamping.
- BendMaster interface.
- Sensor gauge finger.

TRUMPF BendGuard No optoelectronic protective devices are required for manual press brake bending if the BendMaster is used on the TruBend. It is sufficient to use operating station 1 in two-hand operating mode.

The BendMaster must be in home position when operating the bending cell manually. All doors must be closed. The operator is locked in within the safety fencing.

Unavailable options in combination with BendMaster Some of the options of the TruBend must not be available when using the BendMaster. These are:

- Bending aid.
- Additional backgauge finger.
- Upholding device.
- Light curtain.
- Second operating station.

The following modules must be removed from the TruBend before using the BendMaster:

- BendGuard.
- Support brackets.

Chapter 4

Operation

1	Description of the operating elements	4-6
1.1	Portable manual control unit	4-6
	Operating elements	4-6
	Menus and submenus	4-7
1.2	Control panel	4-9
1.3	Stationary 19" screen	4-10
2	Operating the BendMaster	4-11
2.1	Safety information	4-11
2.2	Status display	4-11
2.3	Software versions view	4-13
2.4	User settings	4-13
	Changing settings	4-13
	Creating BIO (BendMaster Information Object)	4-15
	Creating and modifying users	4-15
2.5	Operating modes	4-16
	Selecting operating modes	4-17

	Enabling conditions for operation modes	4-17
2.6	Moving axes of the BendMaster manually	4-22
2.7	Displaying axis positions	4-26
2.8	Gripper service	4-27
2.9	Automatic gripper change (option)	4-28
	Picking up a gripper	4-28
	Lay down gripper	4-31
2.10	Regripping station (option)	4-32
	Moving the axes of the regripping station manually	4-32
	Setting up the regripping station	4-33
	Removing the regripping station	4-35
2.11	Setting the backstop resistor regardless of the program	4-36
3	Switching on and referencing the BendMaster	4-38
3.1	Switching on the BendMaster	4-38
3.2	Referencing the BendMaster	4-39
	Referencing the Z, A, B, C, Z1, Z2 axes	4-40
	Referencing the D axis	4-41
3.3	Referencing TruBend	4-42
4	Switching off the BendMaster	4-46
4.1	Stopping BendMaster and TruBend in any emergency or after a malfunction	4-46
4.2	BendMaster, switching off	4-46
5	Travel functions	4-48
5.1	Executing travel functions	4-48
6	Running in a TruTops program	4-50
6.1	From BendMaster control V7.0 and higher: Settings in TruTops Bend	4-50
6.2	Procedure for productivity package option	4-50
	Checking the productivity package	4-50
	Calculating suction cup capacities	4-51
	Determining the reduction of the robot speed	4-52
6.3	Overview, loading a program	4-52
6.4	Creating a new BendMaster job from the TruTops Bend program	4-53
6.5	Archiving, restoring or deleting jobs	4-55

	Filing away a job	4-56
	Restoring an order	4-56
	Deleting a job	4-57
	Changing the backup directory path on the user interface	4-58
6.6	Defining job details	4-59
	Defining exposure details	4-59
	Editing the gripper weight	4-61
6.7	Loading and unloading areas	4-62
	Load job	4-64
	Adjusting an area	4-64
	Copying an area	4-67
	Deleting an area	4-68
	Displaying the area position	4-68
	Displaying the area position	4-69
	Defining area details	4-69
6.8	Performing the rough recognition process (Search within area)	4-72
	Searching for an area	4-72
	Searching for further loading stacks	4-76
	Intermediate layer, searching for	4-77
	Procedure in the event of problems with the rough recognition	4-77
6.9	Defining stacks	4-78
6.10	Processing stacks	4-80
6.11	Creating a tooling plan	4-84
	Checking the TruTops tooling plan	4-84
	Selecting a separation method	4-85
	Selecting double sheet recognition	4-87
6.12	Setting bending parameters	4-88
	Opening bending parameters	4-89
	Selecting bending support	4-90
	Setting the backgauge sensor system	4-90
	Setting the approach strategy	4-91
	Setting the backstop resistor for single bending operations	4-92
6.13	Program, loading	4-92
	Opening the running in program	4-92
	Program steps for running in	4-93
	Selecting an execution method	4-94
	Running in procedure	4-94
	Teaching a point	4-96

	Points, editing	4-96
	Setting the main run indicator manually	4-98
	Deleting a point	4-99
	Displaying axis positions	4-100
6.14	Starting a run-in program	4-100
6.15	Production planning	4-102
	Creating or modifying a production plan	4-102
	Setting the speed and required number	4-103
	Executing the production plan	4-104
6.16	Connection to storage (option)	4-105
	Defining parts data	4-105
	Defining loading and unloading areas of the storage stations	4-105
	Moving a storage cart manually	4-106
	Moving the BendMaster semi-automatically	4-106
	Moving a storage cart in automatic mode	4-108
7	Working at the press brake without BendMaster	4-110
7.1	Working at the press brake without BendMaster	4-110
8	Errors and Messages	4-111
8.1	Displaying and acknowledging errors and messages	4-111
8.2	Troubleshoot an error	4-111
9	Error handling	4-113
9.1	Jumpering the sensor finger	4-113
9.2	Image processing diagnostics	4-113
	Opening the diagnostics tool	4-119
	Recording with Vision Diagnostics	4-121
	Saving the image recorded last	4-124
	Restarting the program	4-125
9.3	Teleservice	4-125
10	Solving problems and troubleshooting	4-126
10.1	Problem: no part recognized	4-126
	Solution: no part identified	4-127
10.2	Problem: Part underneath detected	4-128
	Solution: part underneath detected	4-129

10.3	Problem: part interference contour recognized	4-130
	Solution: interference contour recognized	4-131

1. Description of the operating elements

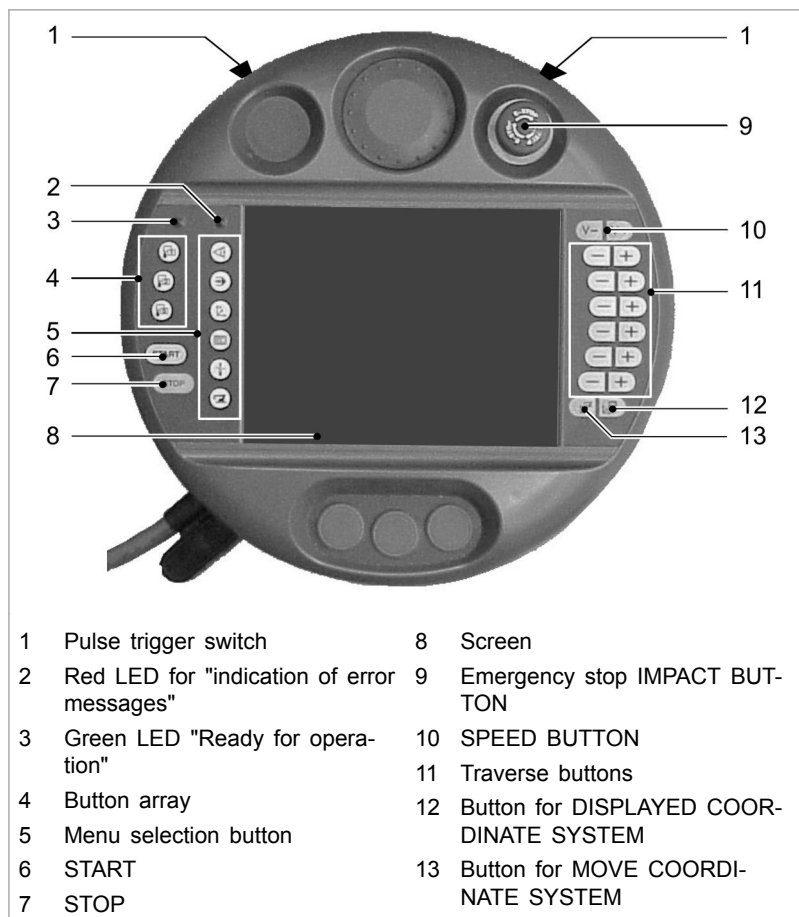
1.1 Portable manual control unit

The portable manual control unit is used to control the BendMaster.

In manual mode, the operator can operate the BendMaster at reduced speed from within the safety fencing with the enable key actuated (in neutral position).

Operating elements

- Button array for various functions.
- PULSE TRIGGER SWITCH.
- EMERGENCY STOP impact button.












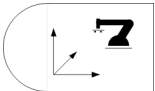
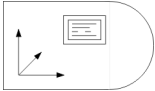
Portable manual control unit

Fig. 39796

Menus and submenus

Which menus are available depends on the enabled user levels. Menus which are not enabled are displayed in gray.

Operating element	Submenus / description
	<p><i>Diagnostics</i> menu:</p> <ul style="list-style-type: none"> ▪ <i>Existing messages</i>: Information, warnings and messages are displayed and can be acknowledged. ▪ <i>Info</i>: main screen. ▪ <i>Version</i>: Display installed software versions, user logon, language options, write BIO. ▪ <i>BV diagnostics</i>: Display image recorded last, restart image processing software, save recorded image.
	<p><i>Setup</i> menu:</p> <ul style="list-style-type: none"> ▪ <i>Job</i>: Create new job from TruTops program or select existing job for execution. Furthermore, select lot size and fine recognition (up to Software V5) as well as archive and delete jobs. ▪ <i>Job details</i>: (from software V6 and higher): Define fine recognition, height measurement and error strategies. ▪ <i>Areas</i>: Adapt (add or move) loading and unloading areas defined in TruTops, execute rough recognition process, display the area position using the image recognition laser. ▪ <i>Stack layout</i>: Process stack assignment (activate, disable, delete loading or unloading stack). ▪ <i>Tool setup plan</i>: Display bending machine, regripping station and gripper setup plans specified by TruTops Bend. The system must be appropriately loaded. ▪ <i>Separation method</i>: Select double sheet recognition and the separation method. ▪ <i>Bending parameters</i>: (from software version 5.0 and higher): Setting of parameters for the bending support, for the backgauge sensor system, for approaching backgauges and for actuating the backgauge resistance for each bending step. ▪ <i>Loading</i>: Start loading program, teach or process points, set main run indicator.
	<p><i>Position</i> menu:</p> <ul style="list-style-type: none"> ▪ <i>Position</i>: Reference or master BendMaster. Display the axis positions in the desired coordinate system: Reference or master the regripping station (generation 2 from software version 4.0 and higher). Control the regripping station manually. ▪ <i>Automatic</i>: Interrupt program execution. Then restart program or stop it completely. Start travel function; for example, home position. ▪ <i>Production package</i>: (from software version 4.0 and higher): Execute several jobs in one production cycle.
	<p><i>Service</i> menu:</p> <ul style="list-style-type: none"> ▪ <i>Calibrate</i>: Start calibration for camera and height measurement. ▪ <i>More</i>: Open, load and deselect projects manually. Process versions manually. ▪ <i>Service functions</i>: Execute sequence routines manually. ▪ <i>Configuration</i>: Modify configuration of connection to visual PC. ▪ <i>CAN Service</i>: Read out and modify parameters of LENZE drives. ▪ <i>ASI Service</i>: Read out the existing slaves at the respective AS-i circuit. Read-dress slaves. ▪ <i>User configuration</i>: Edit existing users, e.g. language for logon. Create new users.

Operating element	Submenus / description
	<p><i>Press menu:</i></p> <ul style="list-style-type: none"> ▪ <i>Press servicing:</i> Start bending machine (hydraulics, CNC, tool clamping). ▪ <i>Regripping station (generation 1):</i> Reference or master the regripping station. Control the regripping station manually. ▪ <i>Sensors for press:</i> Display position of sensor gauge finger. Teach the sensor gauge finger. Starting with Software version 5.0: Activation, setup as well as display of the backstop resistor.
	<p><i>Robot menu:</i></p> <ul style="list-style-type: none"> ▪ <i>Gripper servicing:</i> Clamp or loosen gripper, manual suction or blasting of sheet, manual separation at gripper. ▪ <i>Gripper deposit position:</i> Pick up or deposit the gripper at the gripper deposit station. Teach the gripper deposit. ▪ <i>Sheet sensor:</i> Record images with coarse and fine camera. ▪ <i>Variables:</i> Only for personnel of TRUMPF's Service Department: view or edit variables.
	<p>User key 1: Key for acknowledging all errors, warnings and information (for TRUMPF Service only).</p>
	<p>User key 2 (for TRUMPF Service only): Input key during start-up for the calibration of the sensor gauge fingers, the fine position camera and for mastering the regripping station.</p>
	<p>User key 3:</p> <ul style="list-style-type: none"> ▪ Press 1x: Display of the speed in mm/s. ▪ Press twice: the acceleration is indicated in mm/s² ▪ Press 3 x: the jerk is indicated in mm/s³ (the smaller it is, the smoother the acceleration is)
	<p>MOVE COORDINATE SYSTEM button:</p> <p>This button is used to select the coordinate system in which the axes of the BendMaster are moved.</p> <ul style="list-style-type: none"> ▪ For regripping station Generation 1: 5 coordinate systems are available. ▪ For regripping station Generation 2: 6 coordinate systems are available.
	<p>Displayed coordinate system button:</p> <p>This button is used to select the coordinate system to be displayed on the screen of the portable manual control unit or on the stationary 19" screen (option).</p> <ul style="list-style-type: none"> ▪ For regripping station Generation 1: 3 coordinate systems are available. ▪ For regripping station Generation 2: 4 coordinate systems are available.

Description of the menus with submenus

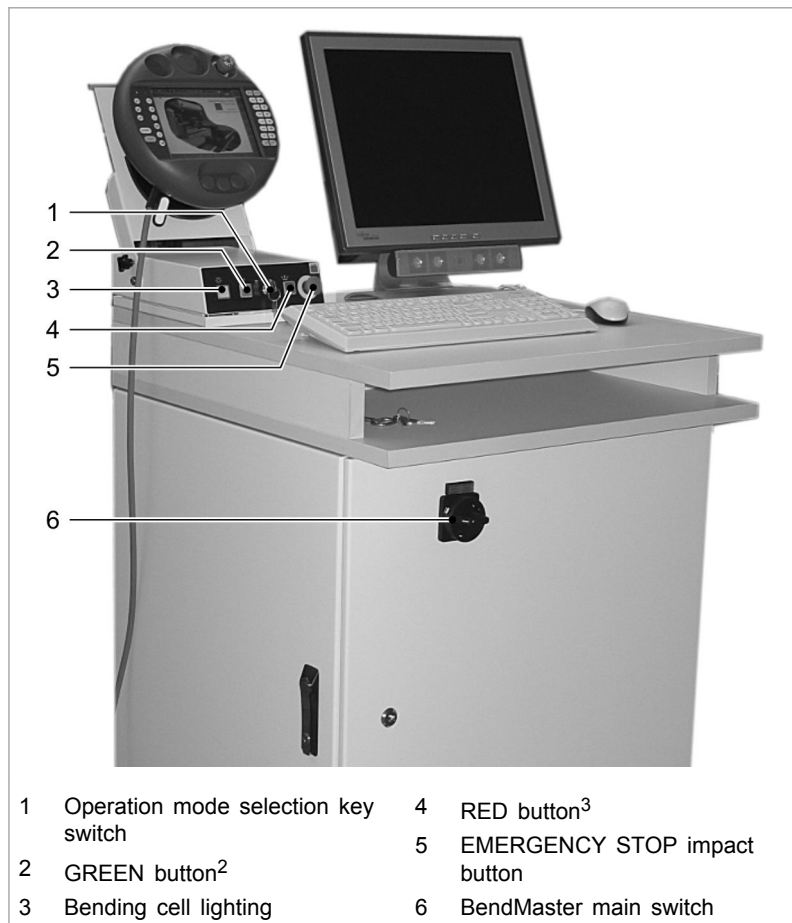
Tab. 4-1

- Enable key** The ENABLE KEY on the rear side of the portable manual control unit can be set to three positions in order to switch the BendMaster operational readiness in manual mode:
- Not pressed: BendMaster not ready for operation.
 - Pressed halfway: BendMaster ready for operation.
 - Fully pressed: BendMaster not ready for operation.

1.2 Control panel

The portable manual control unit is connected to the control panel. The mounting device for the portable manual control unit is mounted on the control panel. If a stationary 18" screen is used, it is also mounted on the control panel.

Operating elements



Control panel with 19" screen, mouse, and keyboard

Fig. 41798

On the control panel:

- Main switch

On the support of the portable manual control unit:

- Operating mode key switch.
- EMERGENCY STOP impact button.
- GREEN button: description of [\(see "Enabling conditions for operation modes", pg. 4-17\)](#).

2 Activate safety fencing catch or switch BendMaster to operational readiness.

3 Deactivate operational readiness or deactivate registration for access or deactivate catch.

-
- RED button: description of (see "Enabling conditions for operation modes", pg. 4-17).
 - WHITE button: illumination of bending cell

1.3 Stationary 19" screen

The same user interface is used on the stationary 19" screen (option) as for the portable manual control unit.

A keyboard and mouse are available for operation.

Only the user interface with write permission set may be the active interface.

2. Operating the BendMaster

2.1 Safety information

WARNING

Workpiece is suspended from the suction cup of the BendMaster!

The workpiece can fall down if the power supply is disconnected or if the vacuum is reduced.

- Only turn off the MAIN SWITCH and the compressed air supply if no workpiece is suspended from the vacuum gripper of the BendMaster.

If the compressed air fails, an acoustic warning signal is emitted in manual mode and a cyclic error message is displayed at the HMI. If a sheet is gripped, the operator must exit the automation cell immediately and close the safety doors, because the blank could be released from the gripper.

WARNING







Workpiece is suspended from the suction cup of the BendMaster!

The workpiece may fall down if the vacuum is reduced.

- If the warning signal is emitted, exit the bending cell immediately and close the safety doors.

2.2 Status display

The different statuses of the control are indicated by symbols at the top left of the HMI user interface.

Icons	Status
	<ul style="list-style-type: none"> ▪ Green padlock, open: write permission granted. ▪ Red padlock, closed: no write permission.
	Hand: manual operating mode is active.
	Arrow: automatic operating mode is active.
	Circle: zero position operating mode is active.
	TruBend manual operating mode (without BendMaster).
	BendMaster/regripping station ready for operation (green).

Icons	Status
	BendMaster/regripping station not ready for operation (red).
	No connection (TruBend communication).
	TruBend not ready for operation (red).
	TruBend CNC stop (blue).
	TruBend CNC start (green).
	Green: pallet scales connected to control system.
	Red: pallet scales not connected to control system.
	Gray: pallet scales switched off or not configured.
	Green with cross: pallet scales with error, e.g. COM port used.
	Green with check mark: pallet scales connected to control system and used in the current project.
 	<ul style="list-style-type: none"> Green triangle: job is currently being executed. Red square: job execution has been stopped. Yellow double line: execution of program is interrupted.
	Name of loaded job.
	Single job SO (Single Order mode): Default processing mode. Is activated as soon as a job is selected in the job page or carried out in the >Setup menu.
	Production plan mode: Execution mode if a job package or production list is started in the >Production plan menu

Tab. 4-2

Indicator light on safety fencingLamp

- Red: an error is present. Read out, eliminate and acknowledge the error in the menu >Diagnostics >Existing messages. The indicator light then turns orange.
- Orange: BendMaster is ready. It can be operated in the desired operating mode after meeting the respective enabling conditions.

- Green: job is processed.
- White: No function.

2.3 Software versions view

1. Menu: *>Diagnostics > >Version*

The control software and visualization software are both divided into system software and application software.

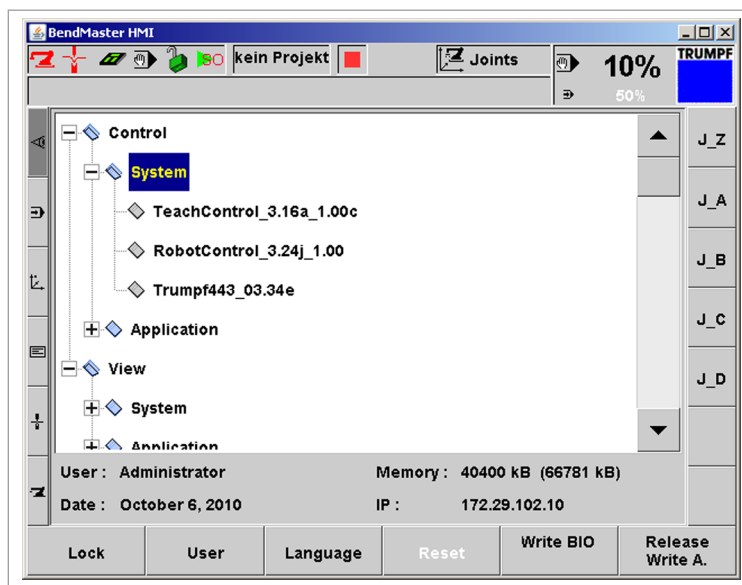


Fig. 39914

2. Double-click on the desired software area. The software versions are displayed.

2.4 User settings

Changing settings

Disabling the touchscreen in order to clean it

1. Press *>Diagnostics > >Version* menu.

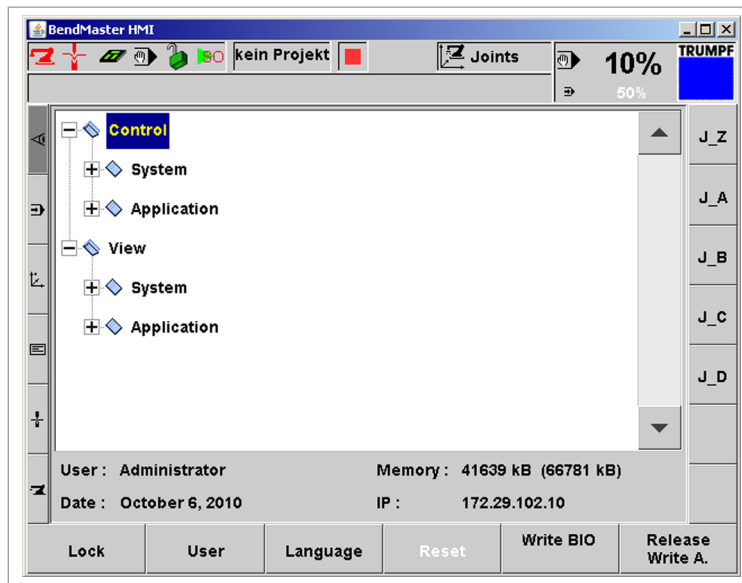


Fig. 59594

2. Press >Lock. The touchscreen is deactivated for 20 seconds. The screen can be cleaned within this period without triggering any functions.

Registering other users

Note

Various functions of the BendMaster can be used, depending on the user rights.

Changing the language

Restarting the portable manual control unit

Setting write permission

3. Press *User*. The logon window appears. The user can log on.
4. Press *Language*. The language can be changed on the "Choose Languages" mask.
5. Press *Restart*. Works only for a user with the corresponding authorization (see ["Creating and modifying users"](#), pg. 4-15).
6. Press *Release write permission*. The write permissions for the operating unit used are deactivated.

The operating units which can be used are the portable manual control unit and the optional monitor on the visualization computer.

The BendMaster can only be operated from one user interface, notably the one with write permission (you can tell by the green icon).

Write permission can be requested in order to change the user interface. Write permission can be forced if it has not been enabled.

Creating BIO (BendMaster Information Object)

After system crashes, collisions and fatal errors, a BIO file should be created, which can be used by the Development department to draw conclusions regarding the cause of an error. Not only the control data is saved to a BIO file, but all machine-relevant data for the purpose of fault analysis.

- Press *Write BIO*.

The BIO file is saved to the visual PC in the released directory: 'C:\xChange\BIO' as a ZIP file. The file name consists of the date and time of creation. BIO files no longer required should be deleted.

Creating and modifying users

- Creating a new user**
1. In the menu, select *>Service > >User configuration*. The following mask appears.

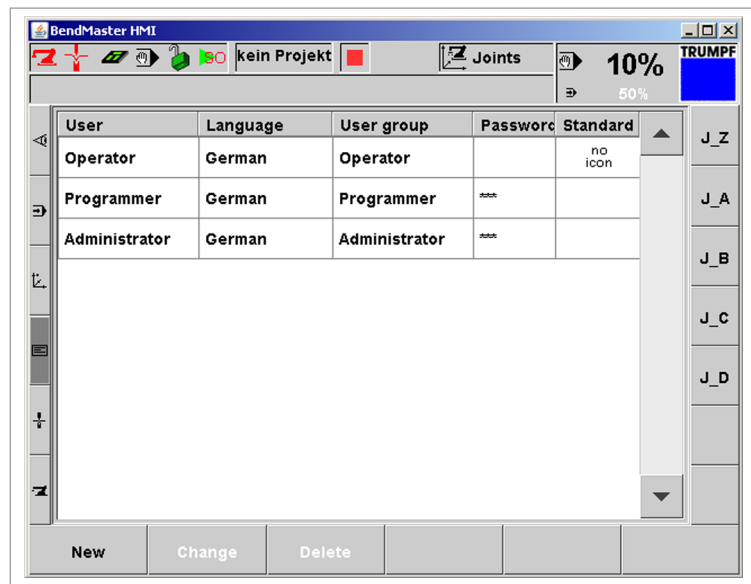


Fig. 51840

2. Press *New*. The "User configuration" mask appears.
3. Define the settings:
 - "User": enter the name of the new user.
 - "Default user" (only for the operator user group): The user is automatically logged on after a delay time of 10 s if the check mark is set.
 - "Password": enter twice to avoid input errors.

- "Language": select the language for the user interface.
- "User group": defines the user rights. The following user levels are possible (in ascending order according to priority): operator, programmer, administrator, service, developer.

Note

A logged on user can create new users up to his own user level. Users with the operator user level cannot create new users.

4. Press *OK*
- Edit user** 5. Mark the user to be edited.
6. *No*. The "User configuration" mask appears.
7. Make the changes.
- Delete user** 8. Mark the user to be edited.
9. Press *Delete*. The "User configuration" mask appears.
10. Confirm the query.

2.5 Operating modes

The BendMaster has four different operating modes:

- Automatic mode:
In automatic mode the BendMaster is controlled automatically by programs.
- Manual mode:
In manual mode, the BendMaster is moved manually at reduced speed. The enable key on the portable manual control unit must be pressed in neutral position.
- TruBend manual:
The TruBend can be moved manually, i.e. without the BendMaster, in TruBend manual operating mode. The BendMaster must first be moved into the home position.
- Zero position:
TruBend and BendMaster are not active in the zero position.

Selecting operating modes

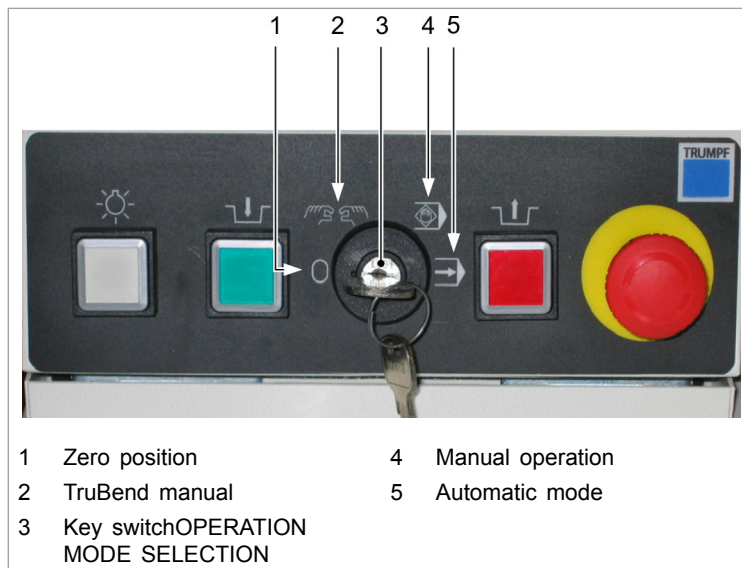


Fig. 46231

- Set the OPERATING MODE key switch for operating mode selection to the desired operating mode.

Enabling conditions for operation modes

Enabling conditions for manual mode

All EMERGENCY STOPs released:

- At TruBend (control system and control panel).
- On the portable manual control unit.
- On the support for the portable manual control unit.
- On all posts of the safety fencing.

TruBend:

- CONTROL key switch is set to ON.
- Press beam not in sloping position.
- Rear protective cover is closed.

BendMaster:

- Manual operating mode is active.
- The ENABLE KEY of the portable manual control unit is pressed in the neutral position.

Tip

To deactivate an activated catch, press the RED button on the mounting device for the portable manual control unit.

Note**(for optional store connection)**

The BendMaster will stop at once if it is not in parking position when the lift gate is opened.

Enabling conditions for automatic mode**All EMERGENCY STOPs released:**

- At TruBend (control system and control panel).
- On the portable manual control unit.
- On the support for the portable manual control unit.
- On all posts of the safety fencing.

At the TruBend:

- CONTROL key switch is set to ON.
- Press beam not in sloping position.
- Rear protective cover is closed.

BendMaster:

- Automatic operating mode is set.
- All doors of the safety fencing are closed.
- All lift gates are closed.
- The GREEN button on the mounting device of the portable manual control unit has been pressed once (BendMaster is ready for operation).

Notes

- Lift gates can be opened only when the safety doors are released.
- If the RED button flashes rapidly, this means that not all doors of the safety fencing are closed.
- **With store connection option:** The BendMaster stops immediately if it is not in the parking position when the lift gate is opened.
- **With handling equipment option:** No impermissible interruption of the palletizer's protected field.

Tip

Press the GREEN button twice if the BendMaster is in the parking position.

Function button on the portable manual control unit

Buttons	Operating mode	How often should it be pressed?	Consequences
GREEN	Automatic	1. Press once.	<ul style="list-style-type: none"> ▪ The catch is activated if it was previously deactivated. ▪ The RED button goes out.
		2. Press it a second time.	<ul style="list-style-type: none"> ▪ The BendMaster is switched to ready for operation. ▪ The GREEN button lights up.
RED	Automatic, BendMaster in home position	1. Press once.	<ul style="list-style-type: none"> ▪ Operational readiness of the BendMaster is deactivated. ▪ The GREEN button goes out.
		2. Press it a second time.	<ul style="list-style-type: none"> ▪ The catch is deactivated. ▪ The RED button lights up.
	Automatic, during the execution of a job	1. Press once.	<ul style="list-style-type: none"> ▪ Deactivation of the catch is reported. ▪ The RED button flashes slowly. The current workpiece is finished.
		2. Press the START button on the portable manual control unit once.	<ul style="list-style-type: none"> ▪ BendMaster is moved into home position. ▪ Operational readiness of the BendMaster is deactivated. ▪ The GREEN button goes out. ▪ The catch is deactivated. ▪ The RED button lights up.
		3. Press the GREEN button once.	<ul style="list-style-type: none"> ▪ The catch is reactivated. ▪ The RED button goes out.
		4. Press the GREEN button a second time.	<ul style="list-style-type: none"> ▪ The BendMaster is switched to ready for operation. ▪ The GREEN button lights up.
		5. Press the START button on the portable manual control unit once.	Execution of the job is resumed.

Function button on the portable manual control unit

Buttons	Operating mode	How often should it be pressed?	Consequences
	Manual mode or TruBend manual	1. Press once.	<ul style="list-style-type: none"> ▪ The active catch is deactivated. ▪ The RED button lights up.

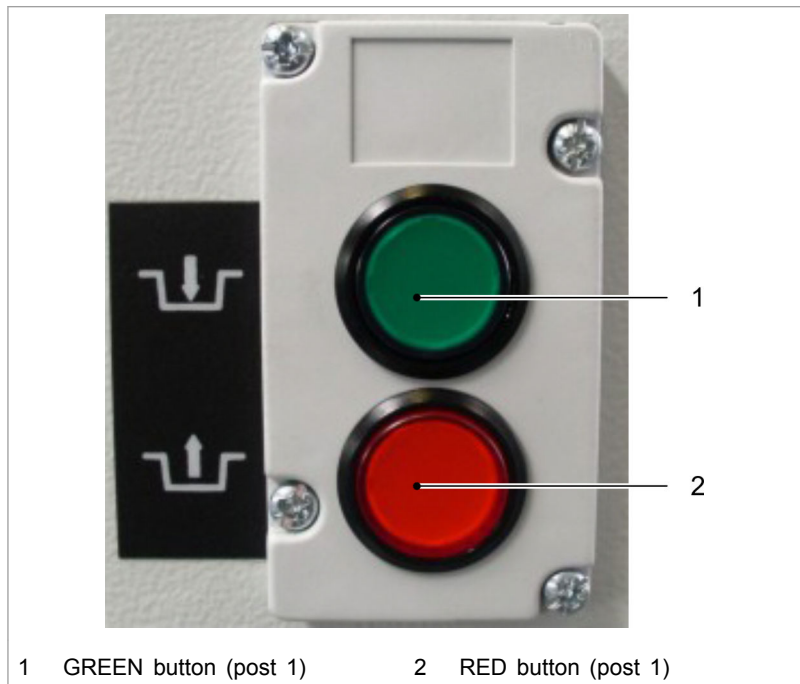
What happens if...

Tab. 4-3

Note

If a person is still in the bending cell after starting the automatic program:

- Press the RED button on post 1 twice.
 - Press once: the system stops.
 - Press a second time: The catch is deactivated for 30 s.
 - Exit the bending cell.
 - To reset the deactivation of the 30-second catch: Press the GREEN button in the mounting device of the portable manual control unit for at least 3 seconds.
- or**
- Press any EMERGENCY STOP button and press the RED button on post 1 twice to deactivate the catch for 30 seconds.



1 GREEN button (post 1) 2 RED button (post 1)

Post 1

Fig. 41776

Enabling conditions for manual press (TruBend without BendMaster)

All EMERGENCY STOPs released:

- At TruBend (control system and control panel).
- On the portable manual control unit.

- On the support for the portable manual control unit.
- On all posts at the safety fencing.

At the TruBend:

- CONTROL key switch is set to ON.
- Press beam not in sloping position.
- Rear protective cover is closed.
- For further conditions, refer to the TruBend operator's manual.

BendMaster:

- The BendMaster is in home position.
- TrumaBend manual operating mode.
- The operator is within the bending cell.
- All doors of the safety fencing are closed.
- All lift gates are closed.
- In case of the conveyor technology option: No impermissible interruption of the palletizing protected field.
- GREEN button on post 1 has been pressed. The catch is activated. The green key lights up.

Notes

- Lift gates can be opened only when the safety doors are released.
- Deactivate the catch to exit the bending cell.

Deactivate the catch:

- Press the RED button in post 1. The system stops and the catch is deactivated. The bending cell can be exited.
or
- Press the RED button on the mounting device of the portable manual control unit.
or
- Press any EMERGENCY STOP button (with the exception of the two Emergency Stop buttons on the TruBend control and control panel and the fully pressed foot switch at the control panel. In this case the system stops, however the catch remains active).

2.6 Moving axes of the BendMaster manually

Automatic mode In automatic mode, all axes of the BendMaster can be moved at reduced speed in the selected traverse coordinate system using the traverse buttons if no program is currently being executed.

- To move the axes of the BendMaster while executing a program, interrupt the program with the red STOP key on the portable manual control unit.

Note

When the program is restarted, make sure that the BendMaster continues at precisely the position at which the program was interrupted.

Manual mode In manual mode, all axes of the BendMaster can be moved at reduced speed within the selected move coordinate system using the traverse buttons.

The BendMaster can only be moved if the ENABLE KEY on the portable manual control unit is pressed in neutral position, since the operator may be within the safety fencing.

If the compressed air fails, an acoustic warning signal is emitted in manual mode and a cyclic error message is displayed at the HMI. The BendMaster stops and can no longer be moved in manual mode.

WARNING

Unexpected drop in pressure at the BendMaster gripper while a workpiece is clamped!

Risk of injury due to workpiece falling down.

- If an acoustic warning signal is emitted, exit the automation cell immediately and close the safety doors.
- Before entering the safety cabin: move the BendMaster manually and deposit the clamped workpiece safely.

Conditions

- Manual or automatic operating mode is active.
- No error messages, i.e. green LED on the portable manual control unit lights up (acknowledge error if red LED is on).
- Manual mode: The BendMaster is ready for operation (pulse trigger switch on the portable manual control unit has been pressed, "BendMaster" icon is green):.

or

- Automatic mode: BendMaster is ready for operation (the GREEN button was pressed, and the "BendMaster" icon is green).

Translating axes

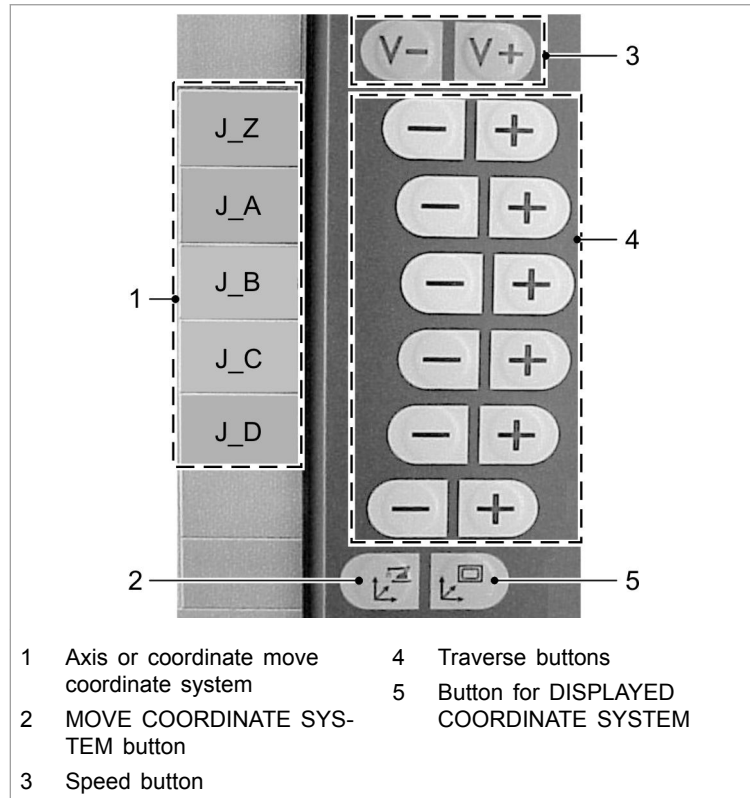


Fig. 33201

- Press the MOVE COORDINATE SYSTEM button repeatedly until the desired move coordinate system is set. The move coordinate system currently set is displayed in the header.

There are six different move coordinate systems which can be used to move the BendMaster axes (see "Tab. 4-4", pg. 4-26).

- Set coordinate system
 - Press repeatedly until the desired displayed coordinate system is set.

There are four different coordinate systems displayed which can be used to display the axis positions of the BendMaster in the *Position* menu.

or

- >Position Press >Position.
- Under "Coordinate system", press ▼.
- Select the desired coordinate system.



Fig. 39947

3. Select the speed using the speed buttons V- or V+.

The speed window is at the top right of the screen. The current speeds in manual and automatic mode are displayed there.

Switching between manual and automatic mode

Pressing the velocity button always changes the velocity which is displayed in large black letters in the velocity window.

Possible speeds in manual mode:

- Incremental between 0.1 l and 1.0 l (1 l corresponds to 0.1 mm/degrees or 1 mm/degree, depending on which move coordinate system is set).
- 2% to 5% in steps of 1%.
- 10% to 100% in steps of 5% (at continuous pressure in steps of 5%, and then 10%).

Speed in automatic mode:

- 0.1% and from 1% to 100% in steps of 1% (at continuous pressure in steps of 5%, and then in steps of 10%).
4. With write permission: press the speed window as required. Manual speed is switched to automatic speed or vice versa.
 5. Use the traverse buttons to move in the displayed direction.

The BendMaster is moved in the displayed direction as long as the traverse button is pressed.

Coordinate systems for displaying the axis positions

There are six traverse coordinate systems available to move the axes. Four of them can also be used to display the axis positions on the screen (= displayed coordinate system):

- Axis coordinate system (= JOINTS).
- Cartesian coordinate system (= CART).
- Mixed coordinate system (= MIXED).
- Auxiliary coordinate system (=AUX).



BendMaster axes

Fig. 58860

Coordinate system	Axis	Movement of the BendMaster
Axis coordinates (= JOINTS)	Z	To the right or left on the floor lane
	A	Movement of the A axis
	B	Movement of the B axis
	C	Movement of the C axis
Cartesian (= CART)	D	Movement of the D axis
	X	Towards or away from the press brake
	R	Upwards or downwards
	Z	To the right or left on the floor lane
	a	Reorientation around the tool center point: the center of the tool center point stands still; the orientation is changed. The tool center point depends on the tool, e. g. no gripper, gripper, off-center gripper, sheet sensor.

Coordinate system	Axis	Movement of the BendMaster
Mixed	X	Towards or away from the press brake
	R	Upwards or downwards
	Z	To the right or left on the floor lane
	C	Reorientation around the tool center point: the center of the tool center point stands still; the orientation is changed. The tool center point depends on the tool, e. g. no gripper, gripper, off-center gripper, sheet sensor.
	D	Movement of the D axis
Auxiliary coordinate system (= AUX)	Z3	Left regripping station to the right or to the left
	Z4	Right regripping station to the right or to the left.

Tab. 4-4

The two other coordinate systems are tool coordinate systems:

- Tool coordinate system (= TOOL):
Coordinate system for the respective tool position. Corresponds to the Cartesian coordinate system, CART.
- Mixed tool coordinate system (= TOOL MIXED):
Mixed coordinate system for the respective tool position. Corresponds to the mixed coordinate system, MIXED.

Note

The coordinate system in which the axes of the BendMaster are moved (= move coordinate system) can be selected in the *>Position* menu (= displayed coordinate system) regardless of the displayed coordinate system.

6. Selecting the coordinate system

2.7 Displaying axis positions

1. Press *>Position > >Position*. The following mask appears.

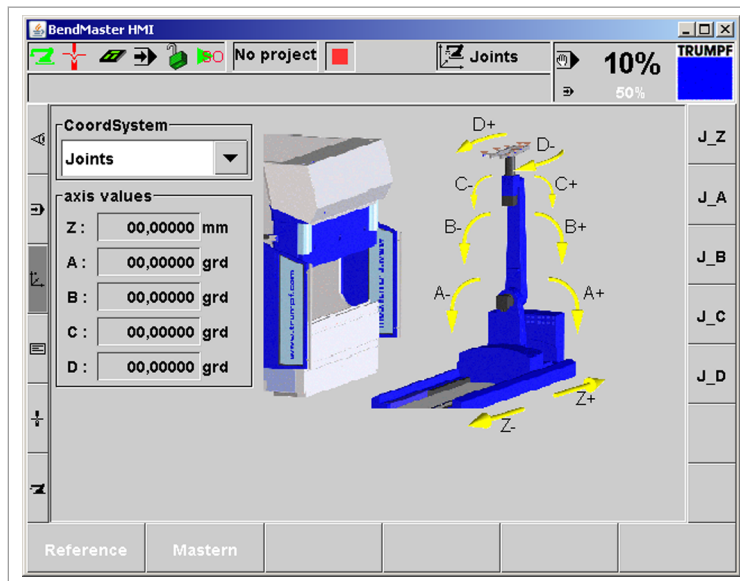


Fig. 39951

The current axis positions are shown in the selected, displayed coordinate system in the "Axis values" window.

The displayed coordinate system is displayed in the "Coordinate system" field from where it can be selected.

2. Selecting the displayed coordinate system
 - Press the DISPLAYED COORDINATE SYSTEM button on the portable manual control unit.
The coordinate system is changed each time the button is pressed.
 - or
 - Under "Coordinate system", press ▼.
 - Select the desired coordinate system. The selected coordinate system is displayed under "Coordinate system".

2.8 Gripper service

- Open gripper servicing**
1. Select >Robot >Gripper servicing menu. The following mask appears.

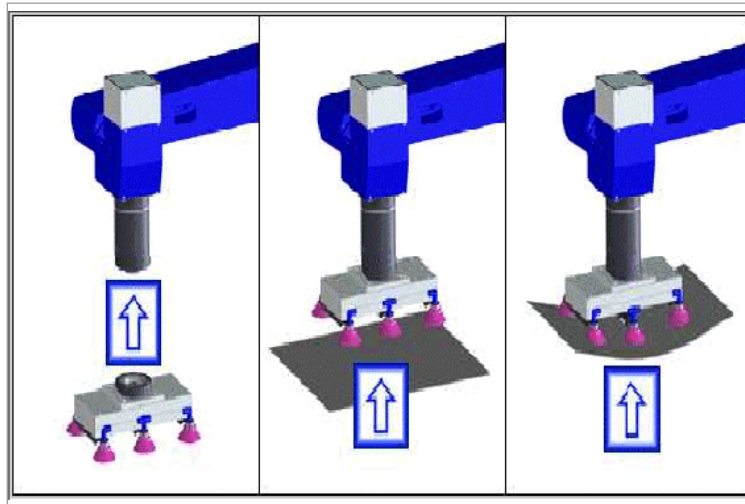


Fig. 39949

- Release gripper**
2. Move BendMaster into gripper change position using the "Move robot to tool change position" travel function.
 3. Press the left *Arrow*.
 4. Confirm question with *OK*.

The "Press the enable key to release gripper" operation message is shown.

5. Press the ENABLE KEY within 10 seconds. The gripper releases.
6. If the ENABLE KEY is not pressed within 10 seconds, then press the *Arrow* again.

Gripping or depositing the board

7. Picking up or depositing a gripper
 - In manual mode: press and hold manual mode.
 - Press the middle *Arrow*.

or

- In automatic mode: lock the safety fencing.
- Press the middle *Arrow*.

The board is gripped or deposited with the gripper.

Performing sheet separation (option)

8. Press the right *Arrow*. A suctioned double sheet will be separated.

2.9 Automatic gripper change (option)

Picking up a gripper

Conditions

- Manual or automatic operating mode is active.
- No error messages, i.e. green LED on the portable manual control unit lights up (acknowledge error if red LED is on).

- Manual mode: The BendMaster is ready for operation (pulse trigger switch on the portable manual control unit has been pressed, "BendMaster" icon is green).

or

- Automatic mode: BendMaster is ready for operation (the GREEN button was pressed, and the "BendMaster" icon is green).
- Gripper deposit station is occupied.
- The gripper has a name.

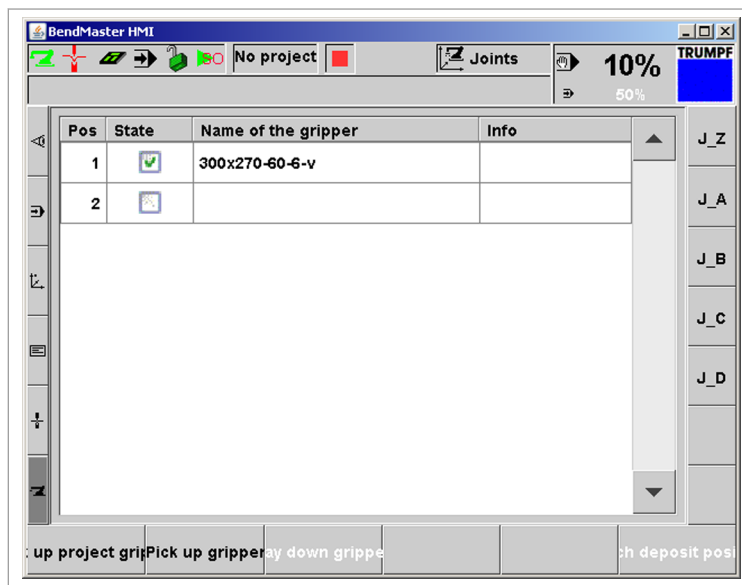


Fig. 52484

- Select >Robot >Gripper deposit station menu.

Note

A job must first be retracted with a gripper for this gripper to be displayed.

- Select a name in the drop-down menu. The last 25 used grippers are listed.

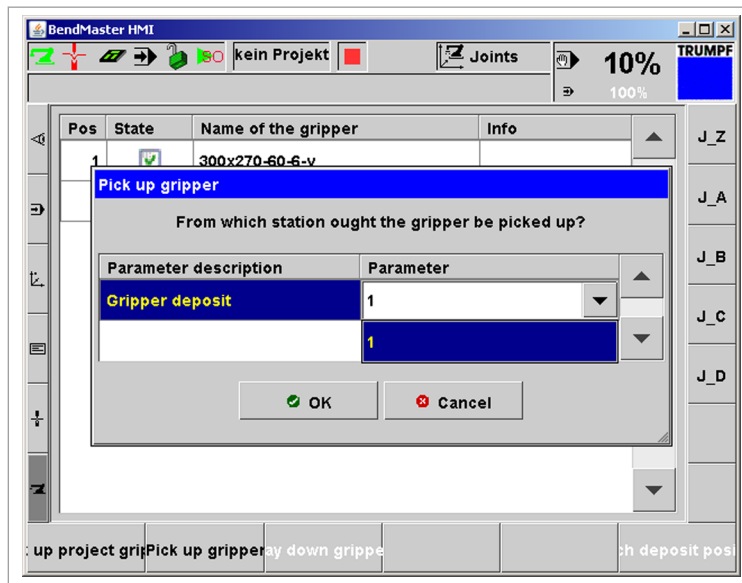






Fig. 52485

3. Select *Pick up gripper*.
4. Select the number of the gripper deposit station from where the gripper is to be picked up in "Parameter".

Symbol	Description
	Deposit station not taught.
	Deposit station occupied; gripper unknown.
	Deposit station occupied; gripper known.
	Deposit station free.

Status of gripper changing console deposit station

Tab. 4-5

5. Select *Ok*. The BendMaster picks up the selected gripper.
6. If the gripper is to be picked up automatically for the loaded job, select *Pick up job gripper*.

Lay down gripper

Conditions

- Manual or automatic operating mode is active.
 - No error messages, i.e. green LED on the portable manual control unit lights up (acknowledge error if red LED is on).
 - BendMaster is ready for operation:
 - In manual mode: The enable key on the portable manual control unit has been pressed, the "BendMaster" icon is green.
 - In automatic mode: the GREEN BUTTON has been pressed and the "BendMaster" icon is green.
 - A free deposit place is available at the gripper changing console.
 - The gripper is loaded at the BendMaster.
1. Select *>Robot >Gripper deposit station* menu.
 2. Select *Lay down gripper*.
 3. Select the number of the gripper deposit station where the gripper is to be deposited in "Parameter".

Note

Only those stations on which there is no gripper can be selected:

4. Select *Ok*. The gripper is set down.
5. Check whether the gripper name is correct. The gripper name is only entered correctly if the gripper type has also been loaded in the control.

2.10 Regripping station (option)

Moving the axes of the regripping station manually

Conditions

- The AUX move coordinate system is selected.
- The regripping station has been referenced.
- No error messages, i.e. green LED on the portable manual control unit lights up (acknowledge error if red LED is on).
- Manual or automatic operating mode is active.
- Manual mode: The BendMaster is ready for operation (pulse trigger switch on the portable manual control unit has been pressed, "BendMaster" icon is green).
- Automatic mode: BendMaster is ready for operation (the GREEN button was pressed, and the "BendMaster" icon is green).

1. Select *>Position >Position*.

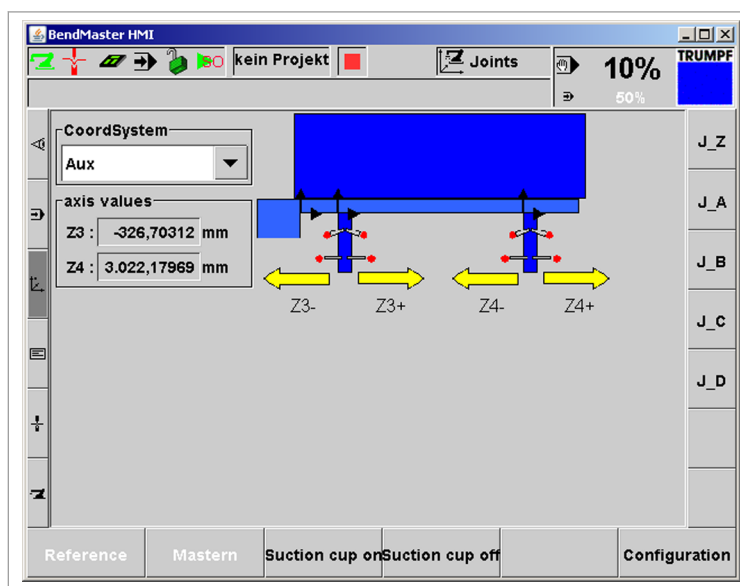


Fig. 52479

2. Select the *AUX* move coordinate system.
3. Use the *Z3* move button for the left gripper arm and the *Z4* move button for the right gripper arm to move the regripping station to the desired position.
4. Select *Suction cups On* to activate the suction cups.
5. Select *Suction cups Off* to deactivate the suction cups.

Tip

The "Re-gripping unit in park position" travel function can be used to move the gripper arms of the regripping station into the parking position.

Setting up the regripping station

1. Select *>Position >Position*.
2. Select the *AUX* move coordinate system.

Note

The regripping station is integrated in TruTops. If no regripping station is used, the regripping consoles must be dis-mounted.

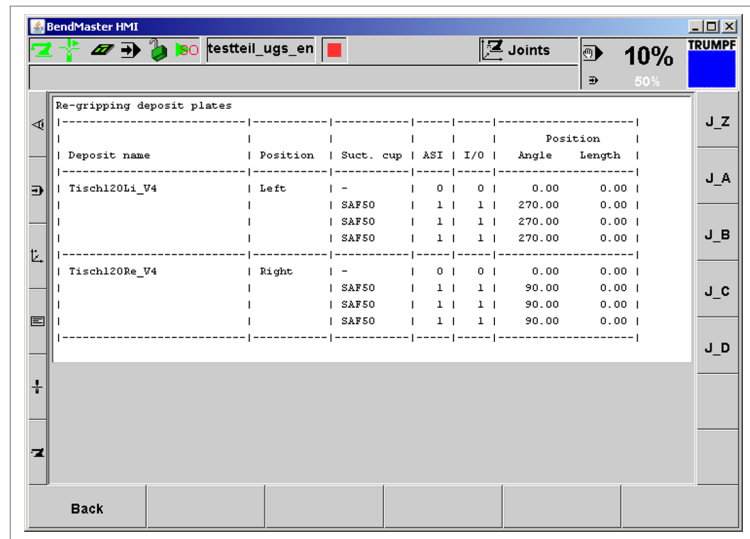


Fig. 51842

3. Press *Configuration*. If a job with programmed regripping station has been loaded, the tooling plan is displayed for the regripping station.

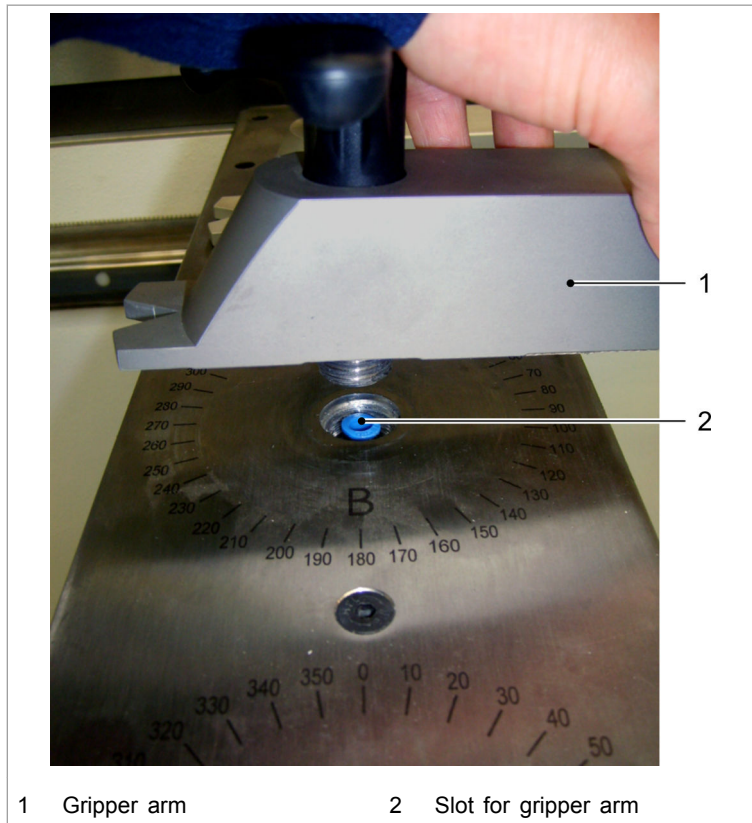
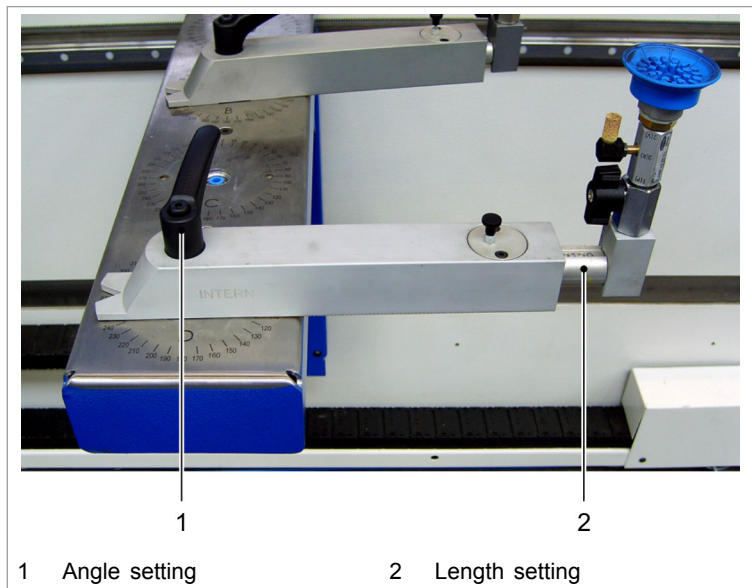


Fig. 54687

4. Screw the configured gripper arms onto the regripping consoles:



Regripping station

Fig. 41347

5. Set the position of the gripper arms according to the tooling plan with the help of the angle scale and the snap-in length adjustment:

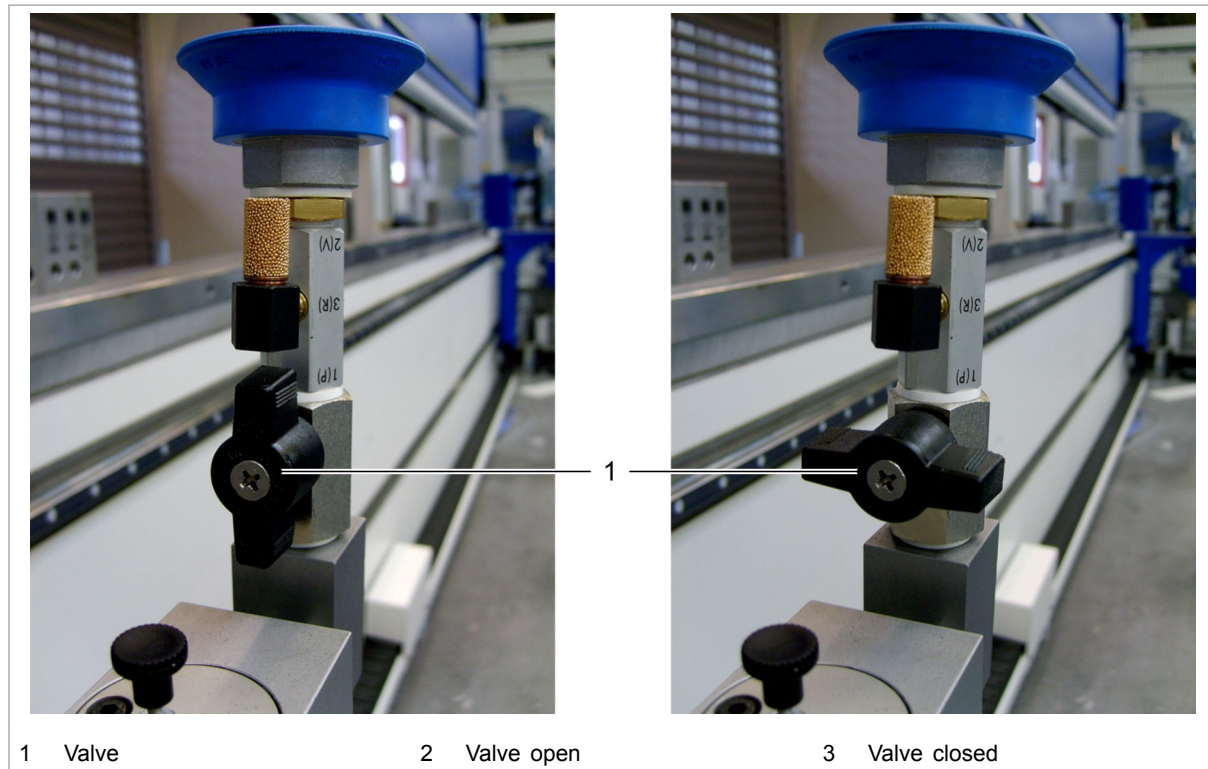


Fig. 54684

6. Open or close the valve at the suction cup of the gripper to activate or deactivate the vacuum.
 - I/O 1 = vacuum on.
 - I/O 0 = vacuum off.

Removing the regripping station

1. Move the regripping station into the parking position with the "Regripping unit in park position" travel function.
2. Undo the air hose at the bottom.



Fig. 54686

3. Undo the four fixing screws using the Allen key (5 mm).
4. Remove the regripping station.

2.11 Setting the backstop resistor regardless of the program

The backstop resistor can be set at the programmer user level (see "Fig. 51840", pg. 4-15) or higher, regardless of the programs and jobs.

Condition

- Backstop resistors have been activated by the TRUMPF Service Department.

1. Open *>Press >Sensors for press >Backstop resistor.*

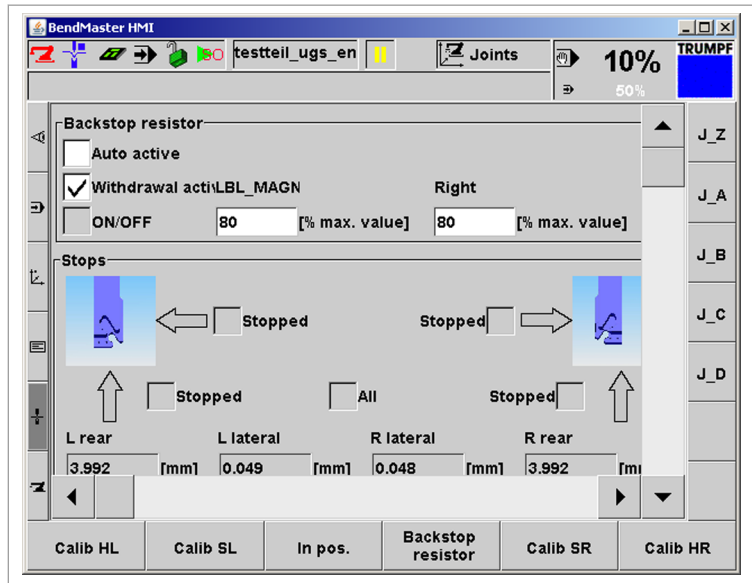


Fig. 43889

2. Mark "ON/OFF" with a checkmark to activate the backstop resistor.
3. Activate "Normal-active" with a checkmark.

The backstop resistor is active while the backgauge approaches its position.

The function corresponds to "When stopping" if the backstop resistor is set for a single program (see ["Setting the backstop resistor for single bending operations"](#), pg. 4-92).

or

- Activate "Withdrawal active" with a checkmark.

The backstop resistor is active while the backgauge withdraws from the workpiece.

The function corresponds to "When moving" if the backstop resistor is set for a single program (see ["Setting the backstop resistor for single bending operations"](#), pg. 4-92).

4. Enter the strength of the backstop resistor between 0 and 100 %:
 - "Left": actuation of the left backstop resistor.
 - "Right": actuation of the right backstop resistor.
5. Deselect "ON/OFF" and then reselect it in order to apply the change to the strength of the backstop resistor.

3. Switching on and referencing the BendMaster

3.1 Switching on the BendMaster

Condition

- The compressed air supply is switched on.
1. Turn on the BendMaster's main switch. The control starts up automatically.

The TruBend has its own main switch, see TruBend operator's manual.

2. Wait for the control to start up.
3. Log on the user and request write permission. The following preset users are available for selection:
 - Operator.
 - Programmer: operator (producing parts).
 - Administrator: operator (retracting parts).
 - Service. TRUMPF Service engineer.
 - Developer.

Notes

The operator does not require a password. All other users require the corresponding password.

Users can be created and existing users edited in the ">Service >User configuration menu (see ["Creating and modifying users"](#), pg. 4-15).

4. Set the CONTROL ON key switch at the TruBend to 1.
5. Turn the BendMaster key switch on the mounting device for the portable manual control unit to the desired operating mode.
6. Release all EMERGENCY STOP buttons:
 - EMERGENCY STOP on the control panel, on the portable manual control unit, on all posts of the safety fencing, on the inside of post 4 and on the control and control panel of the press brake.
 - In automatic mode: close all doors of the safety fencing.
 - In automatic operating mode: press the GREEN button on the mounting device for the portable manual control unit.
 - In manual operating mode: press the ENABLE KEY button.
7. Referencing the BendMaster (see ["Referencing the BendMaster"](#), pg. 4-39).

3.2 Referencing the BendMaster

If the BendMaster moves to the safe home position before switching off with the "Robot in home position" travel function, the axes do not have to be referenced again after being switching on again (see "Executing travel functions", pg. 4-48).

The regripping station always has to be referenced.

If the BendMaster is **not** in the safe home position after switching off, the "Robot in zero position" travel function must be used to manually move the "BendMaster to the reference position after switching on and then referenced.

Display in the event of unreferenced axes

- "NRef" in the header of the speed window.
- "!" status of the drive unknown, e.g. after restarting the control.
- "N" drive not referenced.

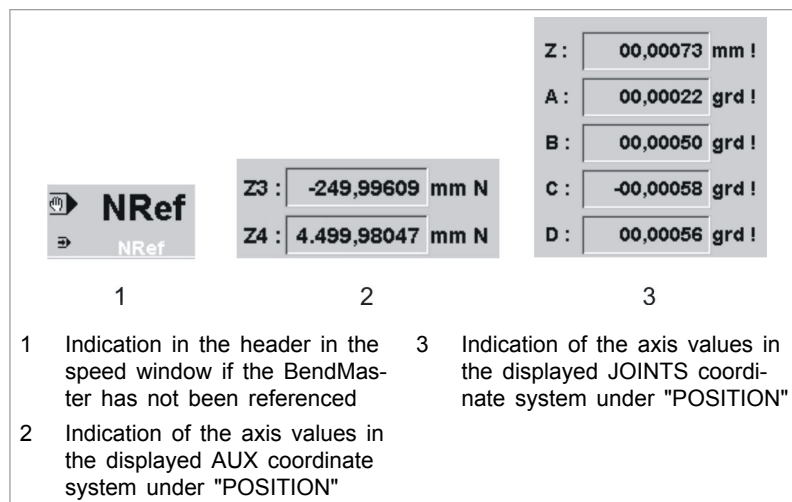


Fig. 54368

Note

Only the JOINTS movement type is possible if one of the axes has not been referenced. Travel functions and program execution are no longer possible.

Referencing the Z, A, B, C, Z1, Z2 axes

Conditions

- Manual operating mode is active.
- No error messages, i.e. green LED on the portable manual control unit lights up (acknowledge error if red LED is on). (see "Enabling conditions for operation modes", pg. 4-17).
- The BendMaster is ready for operation (pulse trigger switch on the portable manual control unit has been pressed, "BendMaster" icon is green).

1. Select the *>Position >Position* menu on the portable manual control unit.
2. Press *Reference*.

The axes to be referenced appear in the right-hand side of the monitor screen against a blue background.

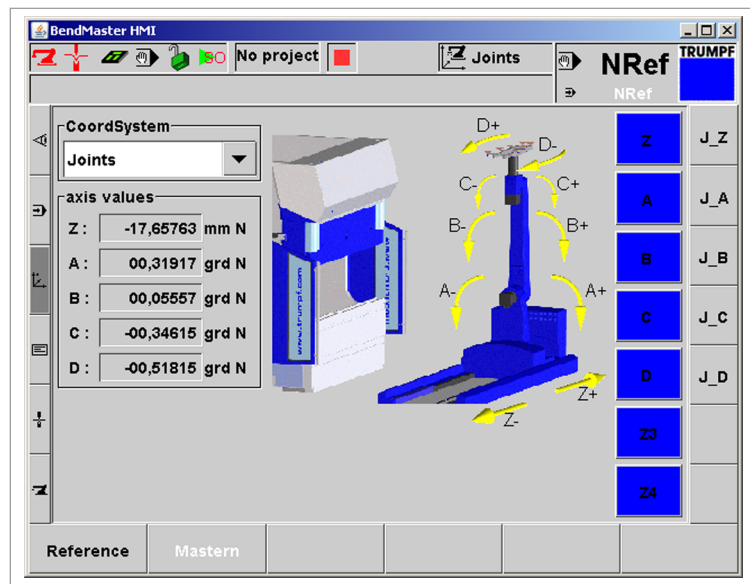


Fig. 40856

3. Move the axes until the reference marks are in alignment with each other.



Fig. 41441

Note

Reference the D axis (see ["Referencing the D axis"](#), pg. 4-41).

4. Press the blue button on the portable manual control unit for the axis to be referenced.
5. Press the blue Z3 button on the portable manual control unit.
An automatic reference trip of the regripping station to the left reference switch at the parking position is started.
6. Press the blue Z4 button on the portable manual control unit.
An automatic reference run of the regripping station to the right-hand reference switch at the parking position is started.

Referencing the D axis

Conditions

- Manual operating mode is active.
 - No error messages, i.e. green LED on the portable manual control unit lights up (acknowledge error if red LED is on). (see ["Enabling conditions for operation modes"](#), pg. 4-17).
 - The BendMaster is ready for operation (pulse trigger switch on the portable manual control unit has been pressed, "BendMaster" icon is green).
1. Select the *>Position >Position* menu on the portable manual control unit.
 2. Press *Reference*.

The axes to be referenced appear in the right-hand side of the monitor screen against a blue background.

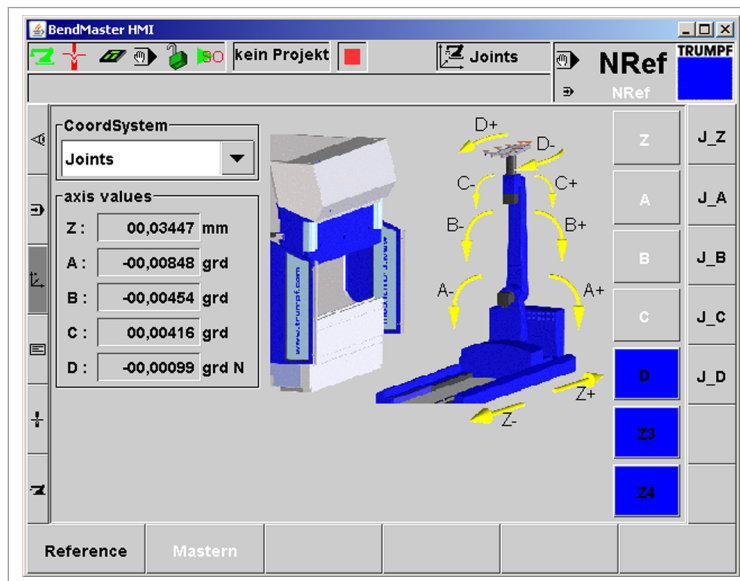


Fig. 49445

NOTICE

Rotational movement with loaded gripper can lead to collisions!

- Check for any risk of collision prior to the reference run of the D axis.

3. BendMaster (60):

Move the D axis until the reference marks are in alignment with each other.

or

➤ BendMaster (150):

Press the blue *D* button on the portable manual control unit.

A reference trip of the D axis is carried out until the integrated reference switch is actuated.

3.3 Referencing TruBend

If no manual reference trip is carried out with the TruBend, then the reference trip will take place automatically prior to a program start.

Conditions

- Manual or automatic operating mode is active.
- No error messages, i.e. green LED on the portable manual control unit lights up (acknowledge error if red LED is on). (see "Enabling conditions for operation modes", pg. 4-17).
- No error messages, i.e. green LED on the portable manual control unit lights up (acknowledge error if red LED is on).
- In manual mode: The BendMaster is ready for operation (pulse trigger switch on the portable manual control unit has been pressed, "BendMaster" icon is green).

or

- In automatic mode: BendMaster is ready for operation (the GREEN button was pressed, and the "BendMaster" icon is green).

- Referencing TruBend** 1. Press the *>Press >Press servicing* menu on the portable manual control unit.

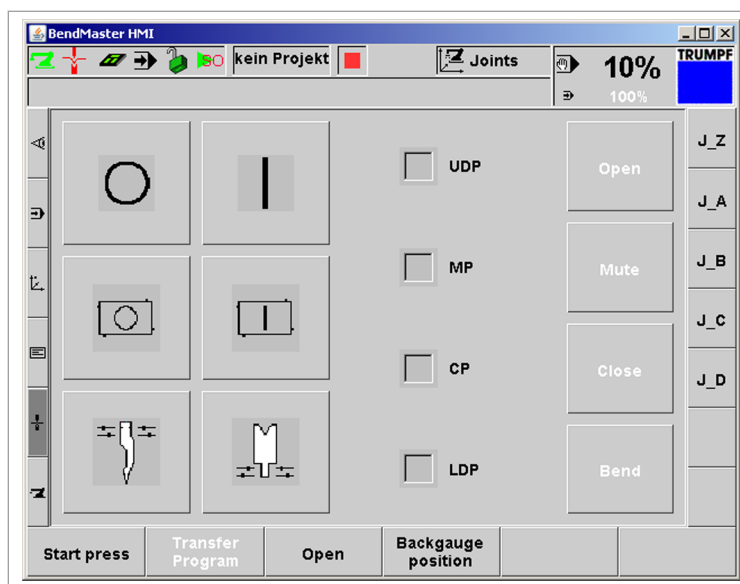


Fig. 46147

2. Starting referencing
- Manual mode: Press and hold the ENABLE KEY on the manual control unit.
 - Press *Start press*.

or

- Automatic mode: Press the GREEN button.
- Press *Start press*.

The hydraulic unit is started. The upper and lower tools are clamped. The press beam is referenced. The backgauge moves into position.

Note

The CNC can only be started if the program is loaded.

After successfully starting the TruBend, the second icon in the header switches to "TruBend CNC started":

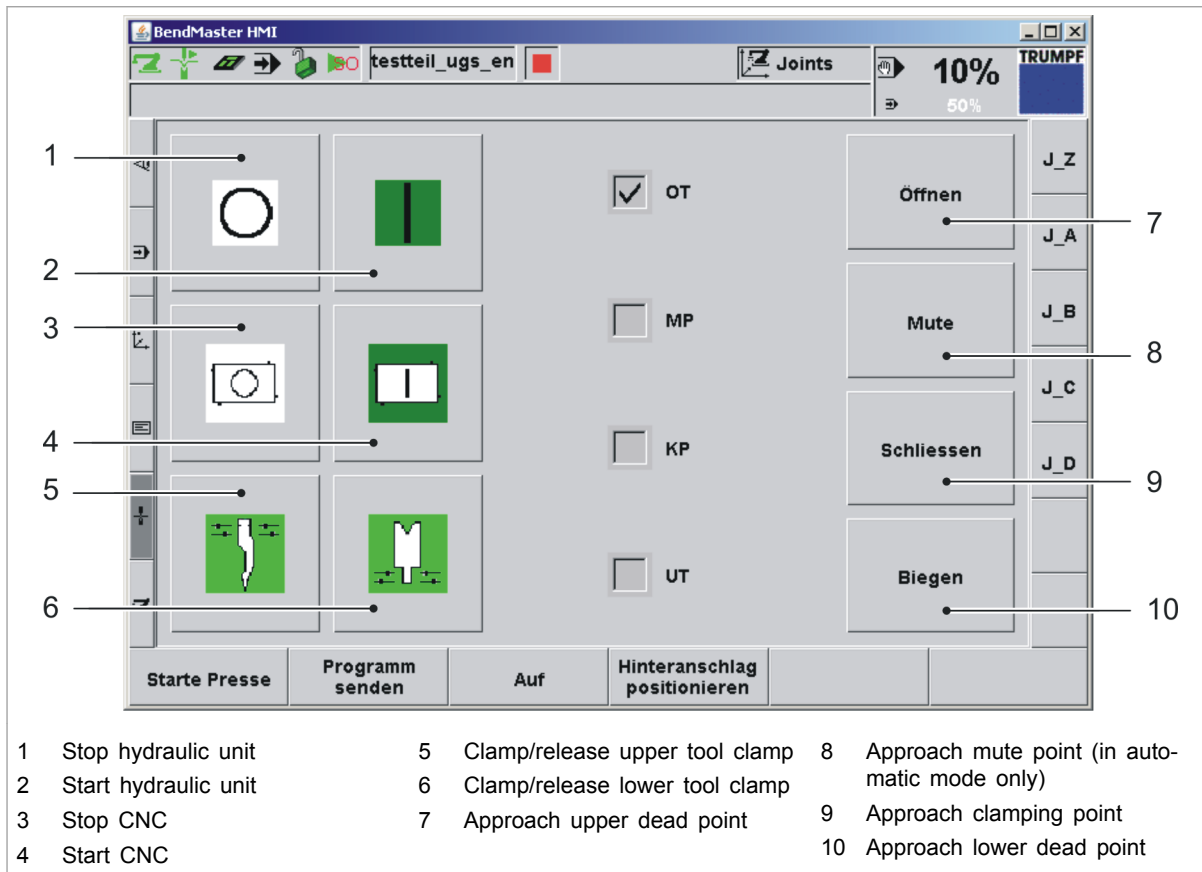


Fig. 46148

- | | |
|---|---|
| Opening the press beam | 3. <i>Press Up.</i> |
| Moving the backgauge to the current bending step | 4. <i>Press Backgauge position.</i> |
| Connecting to the TruBend control | 5. Change to the TOS user interface with <Alt>+<Tab>. |
| | 6. Press <i>MMI</i> : |

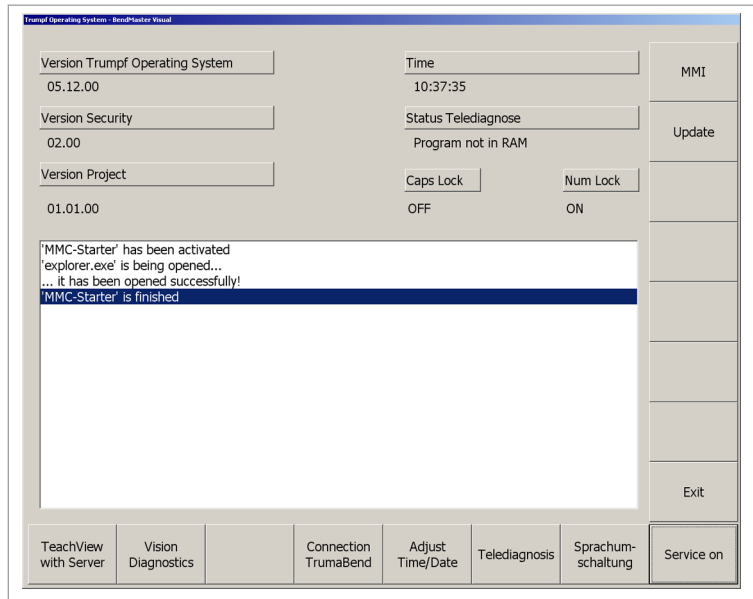


Fig. 46150

7. Press *TrumaBend* connection.

The TruBend user interface is shown on the visualization PC.

Tip

If a VNC connection already exists, you can press <Alt> +<Tab> to switch to the VPC connection.

4. Switching off the BendMaster

4.1 Stopping BendMaster and TruBend in any emergency or after a malfunction

- Press EMERGENCY STOP on the control panel.

or

- Press EMERGENCY STOP on the portable manual control unit.

or

- Press EMERGENCY STOP on the outside of one of the posts of the safety fencing.

or

- Press EMERGENCY STOP on the inside of post 4.

or

- In manual mode only:
 - Release the ENABLE KEY on the portable manual control unit.

or

- In manual mode only:
 - Fully press the ENABLE KEY on the portable manual control unit.

4.2 BendMaster, switching off

Condition

- The control is in the *>Position >Automatic* menu.

1. Press *Stop* to stop the program.
2. If there is a blank on the BendMaster, move into unloading position and set down the blank.
3. Release and deposit the gripper.
4. Select *Move, Robot in home position*.

The safe home position must be approached so that the BendMaster does not have to be referenced again after switching on.

5. Change to the TOS user interface with *<Alt>+<Tab>*.
6. Press *Exit, Exit control system*.
7. Press *Exit Windows XPe* once the control has been shut down.
8. Enter *Yes*. The visualization PC is shut down.

-
9. Turn off the main switch of the BendMaster.

Note

The TruBend has its own main switch. To switch off the TruBend, see the "Operator's manual for TruBend 5000 Series".

5. Travel functions

Travel functions are automatic programs used to approach positions or carry out processes which are frequently required, such as approaching the home position.

5.1 Executing travel functions

Conditions

- All axes have been referenced.
- Manual or automatic operating mode is active.
- No error messages, i.e. green LED on the portable manual control unit lights up (acknowledge error if red LED is on).
- In manual mode: The BendMaster is ready for operation (pulse trigger switch on the portable manual control unit has been pressed, "BendMaster" icon is green).

or

- In automatic mode: BendMaster is ready for operation (the GREEN button was pressed, and the "BendMaster" icon is green).

1. Press *>Position >Automatic*.

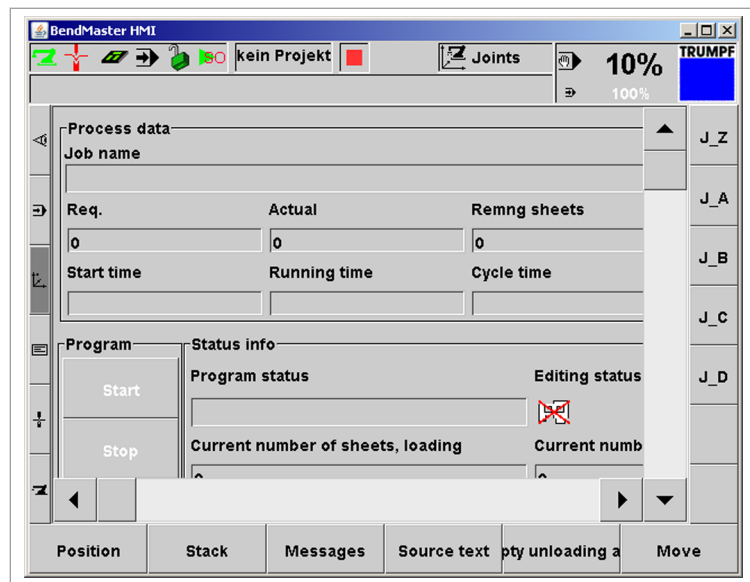


Fig. 42643

2. Press *Move*. The travel functions are displayed.
3. Select the desired travel function:

Travel function	Description
Robot in initial position	Moves the BendMaster into the initial position. By default, the starting position corresponds to the 0 axis position. The initial position can be customized by TRUMPF Service.
Robot in the tool change position	Moves BendMaster into the manual gripper change position.
Robot in home position	Moves the BendMaster in the safe home position. The BendMaster is collapsed. The home position can only be approached without gripper here. <ul style="list-style-type: none"> ▪ The safe home position is approached: <ul style="list-style-type: none"> - Before the manual press mode. - When the machine is switched off.
Robot in parking position	Moves the BendMaster into the parking position. The BendMaster is extended. <ul style="list-style-type: none"> ▪ The parking position is approached: <ul style="list-style-type: none"> - For pallet change in automatic mode. - For the store connection option for travel to storage (pallets or parts exchange).
Regripping console in parking position	Moves the regripping console into parking position.
Robot in zero position	Moves the BendMaster into the reference position (all axis positions = 0).

Travel functions

Tab. 4-6

4. Confirm query with Yes.
5. To interrupt the travel function:
 - Press STOP on the portable manual control unit.
6. To continue the travel function:
 - Press START on the portable manual control unit.
7. To prematurely end the travel function:
 - Press *Stop* at the HMI user interface.

6. Running in a TruTops program

6.1 From BendMaster control V7.0 and higher: Settings in TruTops Bend

- Entering the control version** The machine database of TruTops Bend has to be converted to control version 7.0.
See the "Configuring BendMaster", "Entering the control version" section in chapter 2 of the TruTops Bend software manual version 3 for instructions.
- Gripper weight** The correct gripper weight must be entered in TruTops Bend. This is the only way that the BendMaster can move with optimized cycle time.
For the procedure, refer to the "TruTops Bend software manual version 3", chapter 2, section: "Editing basic data", "Creating the vacuum gripper (BendMaster option)".
- Moving the transversing axis and BendMaster in parallel** The BendMaster and the transversing axis can be moved in parallel. A start and end point must be set for the transversing axis, which also serve as interpolation points for robot movement, so that this procedure is taken into consideration during the collision check.
For the procedure, refer to the "TruTops Bend software manual version 3", chapter 8, section "Moving the cantilever parallel with BendMaster".
- Moving regripping consoles synchronously** For the procedure, refer to the "TruTops Bend software manual version 3", chapter 7, section: "Regripping", "TruBend Cell 5000: Moving regripping consoles in synchronization with BendMaster".

6.2 Procedure for productivity package option

Checking the productivity package

- Checking if the productivity package exists** 1. Open *>Diagnostics >Version >Cell options*.
The productivity package is displayed.
- Adjusting old projects** For projects that were created before the installation of the productivity package, the gripper and the travel speed of the robot must be adjusted to the workpiece speed.

⚠ WARNING**Increased movement dynamics due to productivity package****The workpiece may fall out or be ejected! Risk of injury!**

- Before starting an older project, check the holding force and stability of the corresponding gripper and confirm the respective dialog.
- Calculate the suction cup capacity (see "Calculating suction cup capacities", pg. 4-51).
- Adapt the number of suction cups to the gripper.
- If the number of suction cups cannot be increased: reduce the speed of the travel points (see "Points, editing", pg. 4-96).
- For magnet gripper: reduce the robot speed (override) to 50% (see "Determining the reduction of the robot speed", pg. 4-52).

2. Adjust the parameters to the weight of the workpiece. When doing this, make sure that the center of gravity of the workpiece is in the center of the suction cup arrangement.

Calculating suction cup capacities**Condition**

- The geometry of the workpiece is known.
1. Determine the weight of the workpiece.
 2. Determine the number of required suction cups using the following table:

Nominal diameter in [mm]	Carrying capacity [kg]
30	0.25
40	0.5
50	0.75
60	1
80	1.75
125	4

Suction cup diameter-carrying capacity for productivity package

Tab. 4-7

Example:

A blank weighs 30 kg. Only suction cups with a diameter of 60 mm are available (load-bearing capacity 1 kg).

30 kg: 1 kg = 30.

Thirty suction cups are required.

3. Arrange the suction cups in such a way that the center of gravity of the workpiece is in the center of the suction cup arrangement.

Determining the reduction of the robot speed

When using the magnetic gripper in older programs with the productivity package, the robot speed (override) must be reduced to 50%.

- Calculate the override. Examples:
 - Programmed speed: 100 %, reduced speed:
 $100 \% \times 0.5 = 50 \%$
 - Programmed speed: 80%, reduced speed:
 $80\% \times 0.5 = 40\%$

6.3 Overview, loading a program

Creating a job The BendMaster is controlled automatically in automatic mode. To execute a program from TruTops Bend in automatic mode, a job must first be set up in the *>Setup* menu and run in step-by-step:

- Create a job from the TruTops program or select a job which has already been created.
- Set job details such as fine recognition, height measurement and error strategy.
- Select areas where the BendMaster picks up workpieces or sets them down.
- Starting the rough recognition
- Define the stack assignment.
- Set up tools on the BendMaster, press brake.
- Set up the regripping station.
- Select double sheet recognition and the separation method.
- Set the bending parameters for each bending operation, e.g. bending support, bending sensors and, if available, backstop resistor.
- Load the job.

Input aid A numeric or alphanumeric keyboard appears as an input aid after the respective field has been highlighted if values have to be entered during the Enter values procedure.

If the comfort option is used, the entry can also be made using the keyboard.

6.4 Creating a new BendMaster job from the TruTops Bend program

- Open order** 1. Press >Set up >Job.

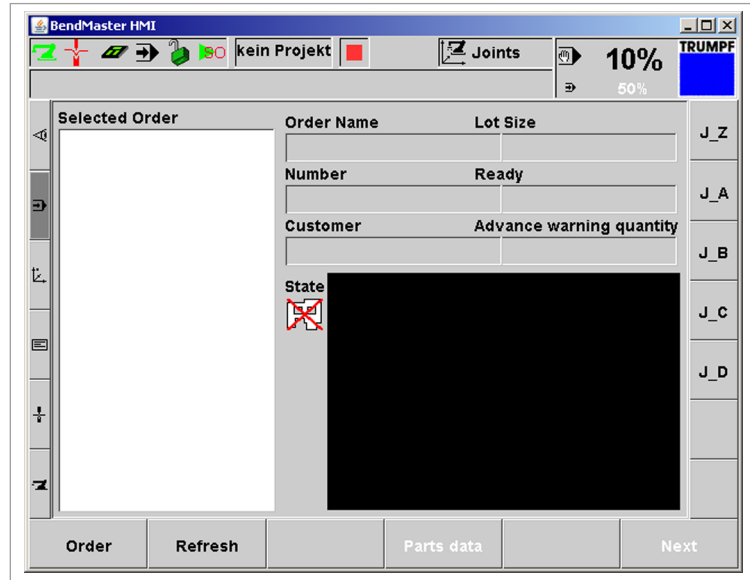


Fig. 59564

2. Press >Job >Build.
3. In the "Building project" window, select the TruTops Bend program (*.bnc') from the released directory 'C:\xChange \parts', from a diskette or from an exchangeable USB storage medium.
4. Press *Open*. The job is saved to the control.
The new job and the previously created jobs are displayed in the "Selected Order" window.
5. Mark the job to be executed in "Selected Order". The selected job is opened and graphically displayed.
The name of the selected job is displayed in the "Order Name" field.

Tip

If the job is clicked on again, it is closed.

Defining the lot size

6. Click on the "Lot Size" field.
7. Enter the production quantity.
8. Press *OK*.

Enter the number of completed, bent blanks

- The number of successfully bent sheets is displayed.
9. Click on the "Done" field.
 10. Enter the quantity.
 11. Press *OK*.

The "Ready" field is not reset to "0" after deselecting and reloading the job. Jobs can thus be interrupted and resumed at a later time with the last quantities.

Execution is finished when the finished items counter reaches the defined lot size.

Setting the advance warning for quantities







12. Enter the number of blanks in the "Advance warning quantity" field, above which the control displays the information for every change in quantity: "Job X in Y blanks finished".

Entering the customer and job number

The "Customer" and "Number" may be defined, but do not have to be.

13. Click on the "Customer" or "Number" field.
14. Enter the customer name or job number.
15. Press *OK*.

The current project status is displayed under "Status":

Symbol	Description
	No job selected or error.
	Job selected, without errors.
	Stacks have been defined.
	Job has been loaded.
	Job is ready.
	The job is available, but has not yet been selected for automatic execution (gray).

Tab. 4-8

Updating the view

16. Press *Update*.

The view is updated, e. g. after jobs have been deleted.

Having parts data displayed

17. *Parts data*
18. In the drop-down menu, press *Unprocessed material*, *Finished part* or, if available, *Intermediate layer part*.

The selected parts data is displayed:

Name	Description
Material ID (store)	ID number of the material with which it was booked in the storage system. Only when a storage system link is used.
Rotation to Geo	Only when a storage system link is used and up to TruTops Bend Software version 2.1: If the part is rotated in TruTops Bend in comparison with the geometry file, then this rotation must be entered accordingly. The rotation to the Geo drawing is possible only in 90° increments. The rotation is carried out automatically starting with TruTops Bend Software version 2.2.
Weight	The sheet weight calculated by TruTops is displayed.
Layer thickness	The layer thickness of the intermediate layer is displayed and can be modified. A modification of the sheet thickness has an effect only on the calculation of the stack height.
Material	The material programmed in TruTops Bend is displayed.

Unprocessed material or intermediate layer part

Tab. 4-9

Name	Description
Material ID (store)	ID number of the material with which it was booked in the storage system. Only when a storage system link is used.

Finished part

Tab. 4-10

19. Press *Back* to return to the *>Run in >Job* menu.

Deleting a job **Note**

- A job can be deleted only if it has not been opened or loaded.
- Deleted jobs can not longer be produced.
- Jobs can be archived prior to deletion.

20. Press *>Job >Delete*.

21. Select the desired job .

22. Press *OK*. The selected job is deleted.

Loading a job

23. Press *>Job >Load*. The selected job is loaded and displayed in the header.

Deselecting a job

24. Press *>Job >Unload*. The loaded job is deselected.

6.5 Archiving, restoring or deleting jobs

Notes

- A job can be archived only if no other job has been transferred or loaded.

- the path for the backup directory is preset; it can however be changed as necessary (see "Changing the backup directory path on the user interface", pg. 4-58).

Filing away a job

- Press **>Job >File away**.

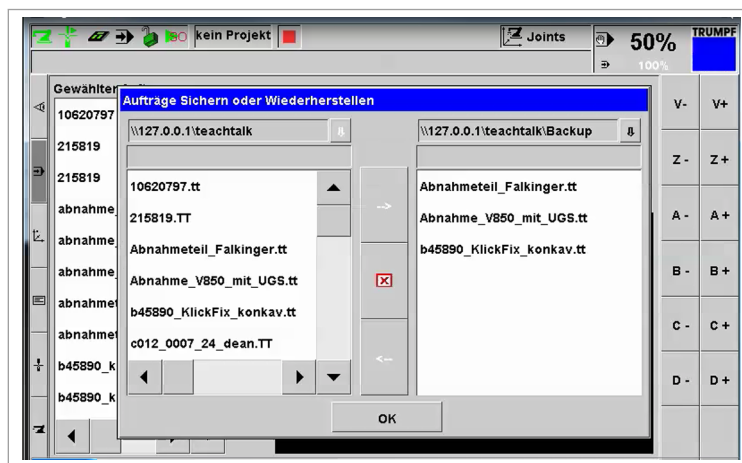


Fig. 76903

The orders saved on the BendMaster are displayed in the left-hand window. The orders in the backup directory are displayed in the right-hand window.

- Mark the orders to be archived in the left-hand window.
- Press **-->**. The marked orders are noted for archiving in the backup directory.
- If the order is already in the backup directory, confirm the corresponding query with **OK**.
- Press **OK**. The marked orders are archived in the backup directory.

Restoring an order

- Press **>Job >File away**.

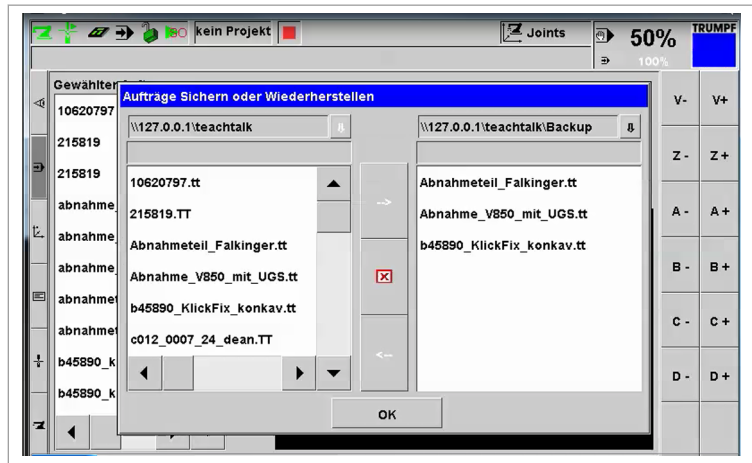


Fig. 76903

The orders saved on the BendMaster are displayed in the left-hand window. The orders in the backup directory are displayed in the right-hand window.

2. In the right-hand window, mark the orders that are to be restored.
3. Press <--. The marked orders to be restored are noted.
4. If the order is already in the control, confirm the corresponding query with **OK**.
5. Press **OK**. The marked orders are restored.

Deleting a job

1. Press >Job >File away.

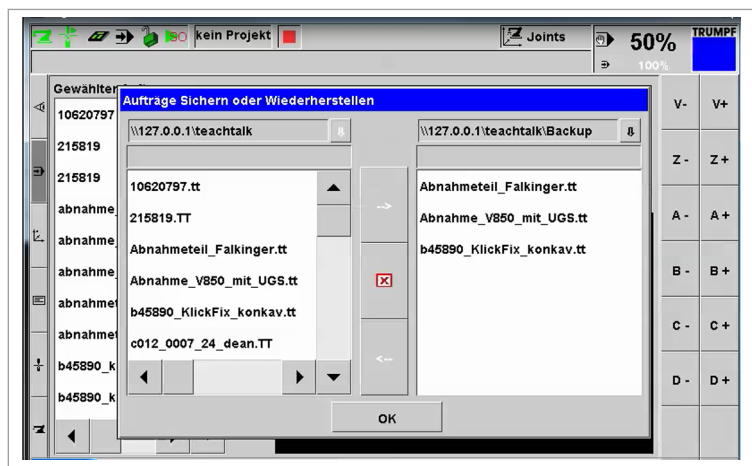



Fig. 76903

The orders saved on the BendMaster are displayed in the left-hand window. The orders in the backup directory are displayed in the right-hand window.

2. In one of the two windows, mark the order that is to be deleted.
3. Press .
4. Confirm the query with *OK*.
5. Press *OK*. The marked order is deleted.

Changing the backup directory path on the user interface

The backup path changed on the user interface is stored in the control and is displayed again when the system is next accessed.

1. Press *>Job >File away*.

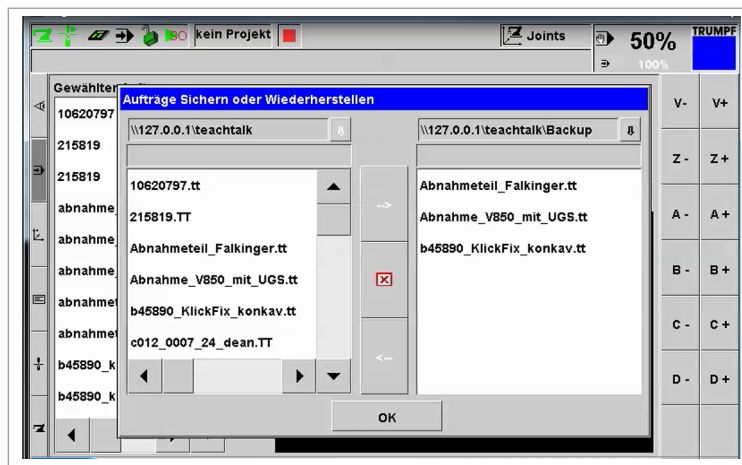





Fig. 76903

The orders saved on the BendMaster are displayed in the left-hand window. The orders in the backup directory are displayed in the right-hand window.

2. Press  next to the backup directory path.
3. Press .
4. Press .
5. Selecting the drive.
6. Select or create a folder.
7. Press *OK*. twice

6.6 Defining job details

Notes

- In order to be able to switch over directly into the job details, a job must be opened or loaded. If this is not the case, then the job is loaded directly.
- All settings which are defined in the job details are stored in the respective job and apply to all loading and unloading areas.
- The settings for individual areas can be modified in the "Area details" mask

Defining exposure details

1. In the "Job" mask, press *Continue*.
or
 ➤ Press *>Set up >Job details*.
2. Press *Details>Tool holder*.

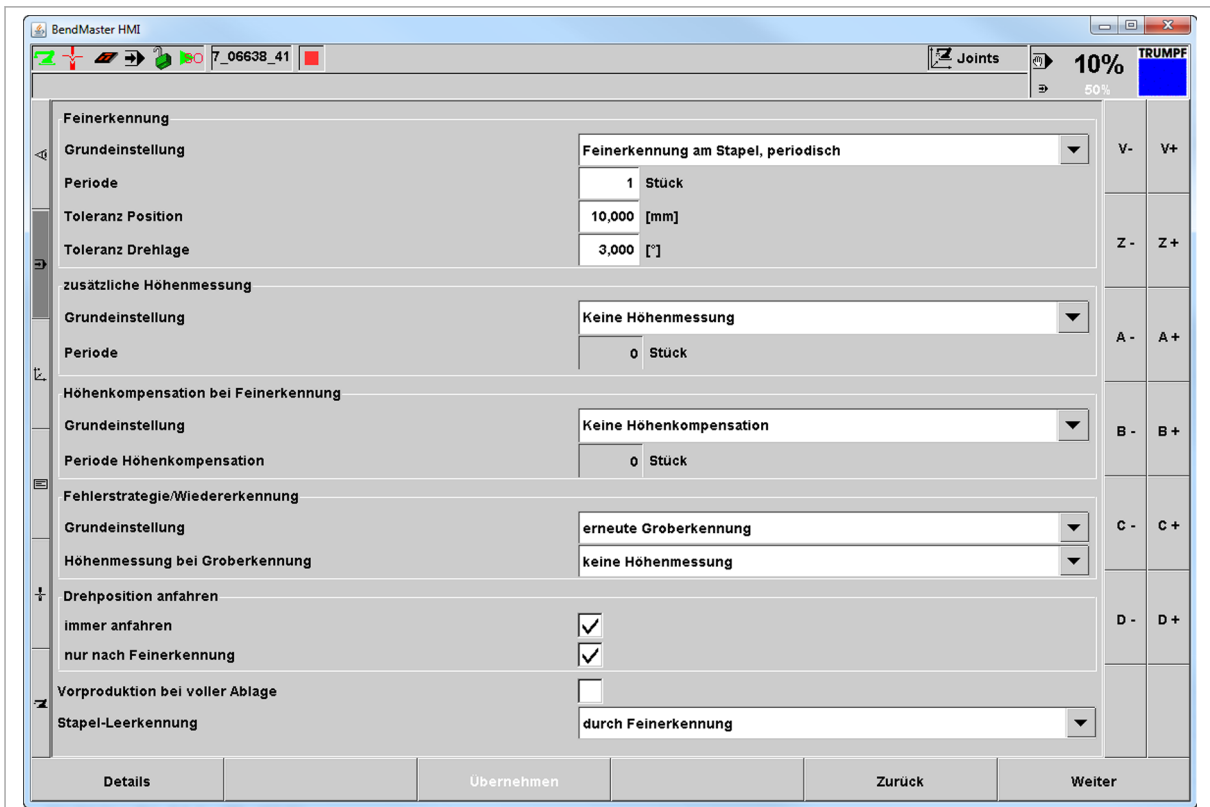


Fig. 76910

3. Define the parameters in the areas.

Name	Description
"Fine recognition"	<p>"Basic setting":</p> <ul style="list-style-type: none"> ▪ <i>No fine recognition.</i> ▪ <i>Fine recognition on the stack, once.</i> Fine recognition is carried out once for each stack. ▪ <i>Fine recognition at the stack, periodic.</i> Fine recognition is carried out at defined intervals in the stack: <ul style="list-style-type: none"> - "Period": number of blanks after which a fine recognition takes place. If, for example, 3 pieces are entered, a fine recognition is carried out after every third blank. - "Tolerance position": specification of the maximum position deviation between two fine recognition windows. If the deviation too great, the stack is marked as locked. Depending on the error strategy which has been set, a new rough or fine recognition process can be carried out on the backlighting table. - "Rotational position tolerance": maximum deviation of the rotational position between two fine recognition windows. If the deviation is too great, the stack is marked as locked. Depending on the error strategy which has been set, a new rough or fine recognition process can be carried out on the backlighting table. ▪ <i>Fine recognition on the backlighting table</i>: : fine recognition is carried out on the backlighting table (e.g. for strongly reflective parts). Can only be selected if a backlighting table is available.
"Additional height measurement"	<p>"Basic setting":</p> <ul style="list-style-type: none"> ▪ <i>No height measurement.</i> ▪ <i>Periodic height measurement.</i> Height measurement is carried out at defined intervals in the stack: ▪ <i>Fine recognition at the stack, periodic.</i> Fine recognition is carried out at defined intervals in the stack: <ul style="list-style-type: none"> - "Period": number of blanks after which a height measurement takes place. If, for example, 3 pieces are entered, a height measurement is carried out after every third blank. - "Height compensation": an exact height measurement is carried out prior to the fine recognition process in order to compensate for the programmed height during the fine recognition process. The determined difference (offset) between the first and second fine recognition windows is displayed as "Offset fine recognition 1" and "Offset fine recognition 2" in the Stack details window.
"Error strategy/recognition"	<p>"Basic setting":</p> <ul style="list-style-type: none"> ▪ <i>No error processing</i>: no action is performed after a faulty fine recognition. ▪ <i>New rough recognition</i>: after a faulty fine recognition, first a rough recognition and then a fine recognition are carried out. ▪ <i>Backlighting table</i>: can only be selected if a backlighting table is available. <ul style="list-style-type: none"> - For fine recognition with two fine recognition windows: if the two fine recognition windows lie outside the previously entered "position" or "rotational position", tolerances, a fine recognition is carried out on the backlighting table. - For fine recognition with one fine recognition window: No action is carried out after a faulty fine recognition, as sufficient position data is not available. ▪ <i>Rough recognition and backlighting table</i>: Combination of the two strategies. First a rough recognition is carried out. If the rough recognition fails, then a fine recognition is carried out on the backlighting table. Can only be selected if a backlighting table is available.

Name	Description
"Height measurement in case of error strategy"	<p>Active if an error strategy with rough recognition is defined. The height measurement is carried out on the material point used.</p> <ul style="list-style-type: none"> ▪ <i>No height measurement:</i> No height measurement is carried out during rough recognition. ▪ <i>Before approximate search:</i> a height measurement is carried out before the approximate search. ▪ <i>After approximate search:</i> a height measurement is carried out after the approximate search. ▪ <i>Before and after approximate search:</i> a height measurement is carried out before and after the approximate search.
"Pre production in case of full storage"	<ul style="list-style-type: none"> ▪ Checkmark set: The next part will still be produced, even if the shelf is full. The BendMaster stops after the bending process if no free shelf is available at this time. ▪ Checkmark not set: The BendMaster stops after depositing the last part.
"Stack empty code"	<p>Defination above which quantity a loading stack in the selected area is marked empty in the control.</p> <ul style="list-style-type: none"> ▪ <i>Default setting:</i> The control selects the mode. ▪ <i>through quantity:</i> The stack is marked empty once the the quantity of 0 is reached. If other blanks are still on this stack (e.g. due to incorrectly measured stack height), then these will no longer be picked up. ▪ <i>through fine recognition:</i> Once the quantity of 0 is reached, a fine recognition is carried out with each additional sheet. If the fine recognition does not find any more blanks, then the stack is marked as being empty. ▪ <i>through height measurement:</i> Once the quantity of 0 is reached, a height measurement is carried out with each additional sheet. If the result of the height measurement is less than the thickness of the blank, then the stack is marked as being empty.
"Position monitoring active"	<p>By default, the control monitors whether the surrounding rectangles of stacks positioned next to one another overlap when creating the loading stack.</p> <ul style="list-style-type: none"> ▪ Checkmark set: Position monitoring active. Overlapping stacks are not created. ▪ Checkmark not set: Stacks are created, even if they overlap. This may result in collisions when blanks are picked up.
"Approaching rotation position"	<p>Safe position for D axis rotary movement. In this position, it is possible to perform the rotary movement without collision, even if the rotational position of a part deviates from the program in TruTops.</p> <ul style="list-style-type: none"> ▪ <i>Always approach:</i> all rotary movements of the D axis are carried out at a safe position. ▪ <i>Only after fine recognition:</i> a rotary movement of the D axis to the safe position is carried out before and after fine recognition. all other D axis rotary movements take place while moving to the pick-up position.

Exposure details

Tab. 4-11

Editing the gripper weight

If the gripper weight was not entered into the database when TruTops Bend was programmed, then the control (starting from

software V7.0) will automatically set the gripper weight to the maximum value. The gripper weight can be manually changed in the program:

1. *Details* Press >*Gripper weight*.
2. Enter the correct gripper weight.
3. Press *Continue*.

6.7 Loading and unloading areas

When a job is set up, all loading and unloading areas need to be set up. Selection:

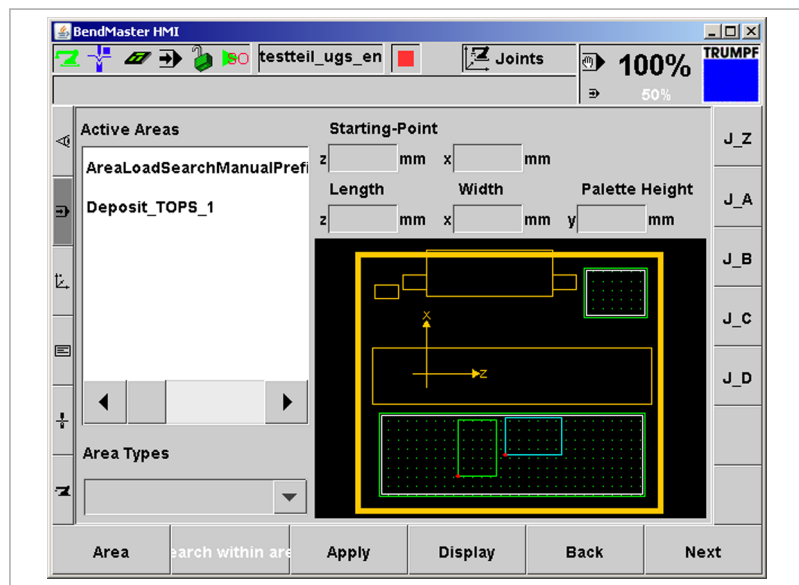


Fig. 48245

- Area types**
- Areas that cannot be changed.

Lines and areas	Description
Lines, orange	Fixed contours, e.g. bending cell or press brake.
Dotted area, white	Working areas (unloading areas).
Thin lines, green	Possible search area for the rough recognition (loading areas).
Lines, white	Sheet removal station or conveyor belts.
Plane, blue (not displayed by default)	Loading area specified by TruTops Bend (cannot be displaced).

Areas which cannot be changed

Tab. 4-12

- Loading areas(see "Tab. 4-16", pg. 4-66):

Areas	Description
Area, green	Loading areas for sheets with the area type <i>Load Search M</i> .
Area, red	Loading areas for sheets with the area type <i>Load Search Automatic</i> . Only in combination with the optional storage system link. Only possible on one storage station.
Area, blue	Loading areas for blanks in case of area type <i>Load Precise</i> .
Area, orange	Sheet removal station or conveyor belts.
Area, pink	Loading area for intermediate positions in case of <i>Z position exact</i> .

Loading areas

Tab. 4-13

- Unloading areas (see "Tab. 4-17", pg. 4-66):

Areas	Description
Area, cyan	Unloading areas for blanks in case of area type <i>Unload Precise</i> .
Area, white	Unloading area for blanks with <i>Deposit quality</i> area type. The periods for depositing for quality assurance are entered in the "Job details", "Storage location settings" mask.
Area, red	Unloading area for sheets with the area type <i>Deposit rejects</i> .

Unloading area

Tab. 4-14

Note

Loading and unloading areas are positioned in the same as they have been programmed and simulated in TruTops. However, they can be adapted to their actual position in the bending cell. As a result, areas moved in the X direction might not be able to be approached by the BendMaster.

Coordinate system and starting point (see "Load job", pg. 4-64)

or

- Press the desired area in the graphic (see "Loading and unloading areas", pg. 4-62).

Do not confuse the loading and unloading areas!

2. Moving an area

- Press the value to be changed. The numeric keyboard appears.
- Enter the value.
- Press *OK*.

or

- Move the area into the graphic using the drag & drop method (see "Fig. 46232", pg. 4-64).

Notes

- Moving unloading areas by means of drag & drop is only possible in Z direction.
- The coordinate system in Z direction is stuck onto the floor lane cover.
- The origin of the coordinate system in the X direction is at the center of the shaft of the A axis. The coordinates become positive in the direction of the TruBend and negative in the direction of the loading area.
- Moving unloading areas in X direction is only possible by changing the starting point. However, it may be the case that the BendMaster can no longer approach the unloading positions.
- If the sheets of the loading stack are larger than the pallet, a larger loading area must be defined accordingly.

Name	Description
Starting point	X and Z coordinates of the bottom, left corner of the area selected under active areas. This point is displayed in red in the diagram (see "Fig. 46232", pg. 4-64).
"Length"	Length of the area selected under "Active Areas" in the Z direction in [mm].
"Width"	Width of the area selected under "Active Areas" in the X direction in [mm]. The length and width range can also be moved using the drag & drop method: <ul style="list-style-type: none"> ▪ Select an area. ▪ Position the cursor at the corner diagonally opposite the starting point. ▪ Adapt the area.
"Pallet height"	Height of the transport medium holding the work-piece stack.

Name	Description
"Area Types"	The loading or unloading area function can be defined using the different area types (see "Tab. 4-16", pg. 4-66), (see "Tab. 4-17", pg. 4-66).

Tab. 4-15

Area type	Color	Description
<i>Load Search M</i>	Green	<ul style="list-style-type: none"> The approximate search must be started manually. <p>The number of recorded images which are joined to form an overall image varies, depending on the size of the area. The position of the stack in the overall image is determined by means of the rough recognition process.</p>
<i>Load Search A</i>	Red	<ul style="list-style-type: none"> The approximate search is started automatically when a storage system/pallet conveyor is used. <p>The number of recorded images which are joined to form an overall image varies, depending on the size of the area. The position of the stack in the overall image is determined by means of the rough recognition process.</p>
<i>Load Search exact</i>	Blue	The stack is positioned within this area as previously programmed in TruTops Bend.
<i>Z position search A</i>	Orange	The loading area is searched for a stack with intermediate layers. The number of recorded images which are joined to form an overall image varies, depending on the size of the area. The position of the intermediate layer in the overall image is determined by means of the rough recognition process.
<i>Intermediate layer search exact</i>	Pink	The intermediate layer stack is positioned within this area as previously programmed in TruTops Bend.

Area types, receiver

Tab. 4-16

Area type	Color	Description
<i>Unload Precise</i>	Cyan	The stack is positioned within this area as previously programmed in TruTops.
<i>Unload Precise</i>	White	Parts for a quality check can be set down within this area at periodic intervals.
<i>Deposit rejects</i>	Red	Parts for which the ACB angle detection sensor system has indicated an error are deposited within this area.

Area types, unloading areas

Tab. 4-17

- Moving unloading areas by means of drag & drop is only possible in Z direction.
- Moving unloading areas in X direction is only possible by changing the starting point. However, it may be the case that the BendMaster can no longer approach the unloading positions.
- If the sheets of the loading stack are larger than the pallet, a larger loading area must be defined accordingly.
- Do not confuse the loading and unloading areas.

Tip

The starting point for positioning a pallet can also be indicated with the laser cross.

Copying an area

1. Select the area to be copied:
 - Mark the area to be copied under "Active Areas".
 - or**
 - Press the desired area in the diagram.
2. Press *Area, Copy*.

The values of the selected area are adopted as proposal. The following mask appears:

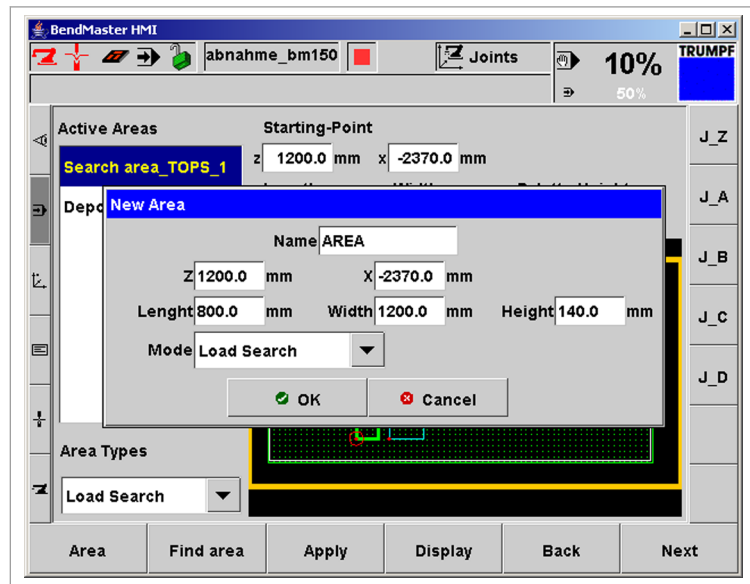


Fig. 35718

3. Enter "name".

Tip

Use descriptive names.

4. Enter the Z and X coordinates of the area's starting point (bottom left) (see "Fig. 46232", pg. 4-64).

Tip

If the sheets of the loading stack are larger than the pallet, a larger loading area must be defined accordingly.

5. At "Mode" select the desired *area type*(see "Tab. 4-16", pg. 4-66).
6. Press *OK*.

Deleting an area

Deleting individual areas

1. Mark the area to be deleted under "Active Areas".
2. Press *Area, Delete*.

All areas, deleting

3. Press *Area, Delete all areas*.
4. Press *OK*.

Displaying the area position

1. Press *>Set up >Areas*.
2. Press *Area, Approach laser position*.
3. Confirm the query with *OK*.

The area positions are approached.

4. Press user key 2 to switch on the laser.

The point opposite the starting point of the selected area is displayed (X) at the HMI user interface.

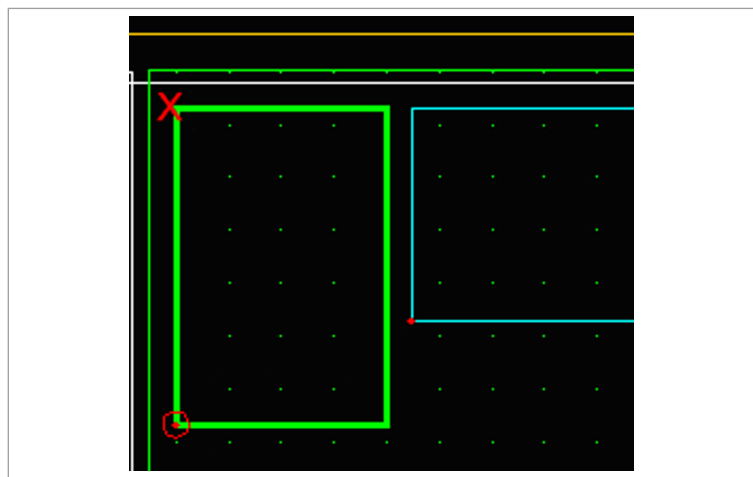


Fig. 49446

5. Position the pallet.
6. The opposite point of the starting point of the selected area is displayed (X).

Displaying the area position

1. Press *>Set up >Areas*.
2. Press *Area, Approach laser position*.
3. Confirm the query with *OK*.

The area positions are approached.

4. Press user key 2 to switch on the laser.

The point opposite the starting point of the selected area is displayed (X) at the HMI user interface.

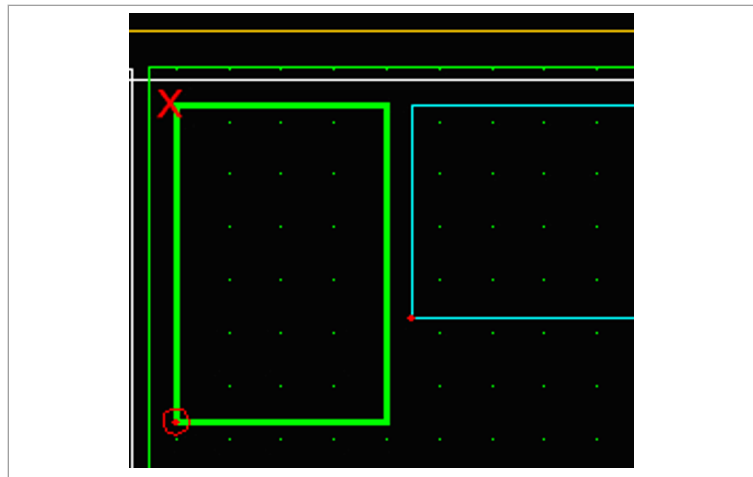


Fig. 49446

5. Position the pallet.
6. The opposite point of the starting point of the selected area is displayed (X).

Defining area details

Opening area details

1. Press *Display, Details* to display the graphic again.

The settings which were made when the job was created can be modified here for the selected area. The settings apply to all stacks located in the selected area:

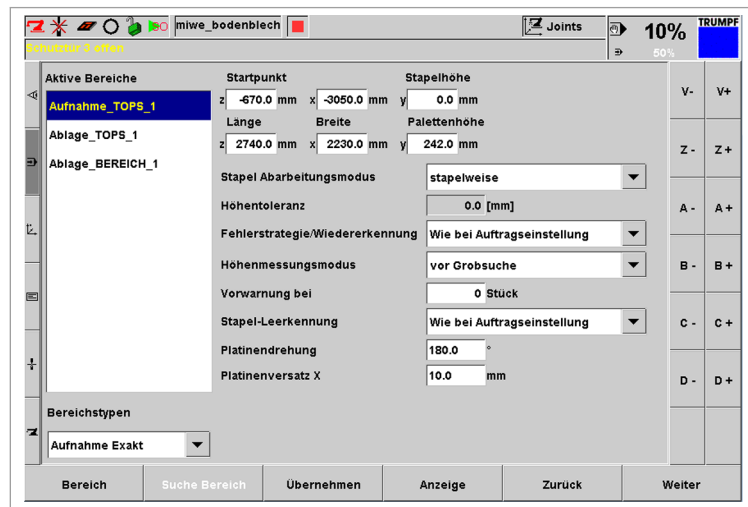


Fig. 68678

"Stack execution mode"

Mode with which the loading stack in the selected area can be processed. Can be defined only for the loading stack.

2. Select "Stack execution mode":

- *by stacks* (default value): a stack is processed completely before beginning with the next stack.
- *by layers*: the highest stack is processed until another stack has the same height. Once this occurs, processing proceeds alternately, layer by layer, on all loading stacks in the area.

"Height tolerance"

The field is only active if *by layers* has been selected in the "Stack execution mode" field. Can only be defined for loading areas.

3. Enter the "height tolerance". Maximum difference in height between the stacks which is still tolerated for the execution by layers.

"Error strategy/recognition"

Strategy as to how, after a failed fine recognition in the selected area, work is to proceed. Can be defined only for loading areas.

4. Select "Error strategy / Recognition":

- *As with job setting* (default value): the job is resumed with the programmed settings.
- *No error processing*: no action is performed after a faulty fine recognition.
- *New rough recognition*: after a faulty fine recognition, first a rough recognition and then a fine recognition are carried out.



- *Backlighting table*: can only be selected if a backlighting table is available.

For fine recognition with **two** fine recognition windows: if the two fine recognition windows lie outside the previously entered "position" or "rotational position", tolerances, a fine recognition is carried out on the backlighting table.

For fine recognition with **one** fine recognition window: No action is carried out after a faulty fine recognition, because there is not enough position data available.

- *Rough recognition and backlighting table*: Combination of the two strategies. First a rough recognition is carried out. If the rough recognition fails, then a fine recognition is carried out on the backlighting table. Can only be selected if a backlighting table is available.

"Height measurement mode"

Strategy by which, after a failed fine recognition in the selected area, work is to be continued with a rough recognition. Can be defined only for loading areas.

5. Select "Height measurement mode":

- *As with job setting* (default value): the job is resumed with the programmed settings.
- *No height measurement*: no additional rough recognition is carried out.

"Advance warning from"

Determination of the minimum quantity of sheets in a stack in the selected area at which an advance warning (message) is issued.

6. Enter the quantity in the "Advance warning from" field.

"Stack empty code"

Determination as to the number of pieces starting from which a loading stack in the selected area will be marked "empty" in the control. Can only be defined for loading areas.

7. Enter the stack height in the "Stack empty code" field.

or

- *As with job setting* (Default value): The job is resumed with the programmed settings.

"Sheet rotation" and "Offset in X"

Components with extrusions only on one side result in angled material stacks. With "Board rotation" and "Offset in X", every part can be deposited rotated and/or offset from the previous part.

8. Enter "Sheet rotation". Permitted values: 0° or 180°.

Rotation takes place around the center of the defining component rectangle.

9. Enter "Offset in X".

-
- "Deactivate vacuum intermediate layer"** When intermediate layers in the loading stack are used, vacuum monitoring can be deactivated for the selected area during the time period from the loading to the unloading of the intermediate layer.
10. Remove the checkmark from "Vacuum monitoring".
- Note**
The BendMaster is not stopped if no intermediate layer is picked up or if it is lost during transport.
- Redisplaying the diagram** 11. Press *Display, Overview* to display the graphic again.
- Viewing the approximate search for images** 12. Press *Images of approximate search*.
- The recorded images already available can be viewed in order that the rough recognition process does not have to be repeated when searching for two or more loading stacks.
- Adopt changes** 13. Press *Apply*. The graphic is displayed again.

6.8 Performing the rough recognition process (Search within area)

Searching for an area

Condition

- All axes have been referenced.(see ["Referencing the Bend-Master", pg. 4-39](#)).

Recording images

1. Press *Search within area*.

The loading area is searched. The number of recorded images varies, depending on the size of the area. The first image is displayed.

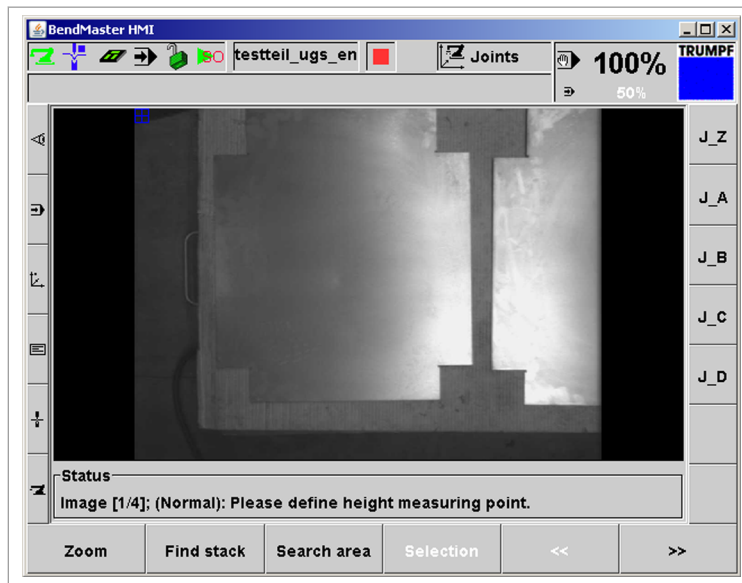


Fig. 39926

Note

"Image [1/4]" means the first of four recorded images is displayed.

2. Increase the size of the recorded image with *Zoom* if desired:
 - *Activate zoom*: A green window can be placed over the area that is to be zoomed in. The zoomed in section is displayed.
Activate zoom can be used to zoom in to the image recording any number of times.
 - *Zoom out*: image recording is reset from the currently zoomed in section to the previous image detail.
The function can be repeated until the original size is established.
 - *Zoom 100%*: image recording size is reset to 100%.
 - *Deactivate zoom*: Deactivates the activated zoom. The green window is hidden.
3. Switch between the individual images using << and >> if desired.
4. Position the blue cross-hairs from the top left corner of the screen at the point where the height is to be measured and the stack is to be searched for:

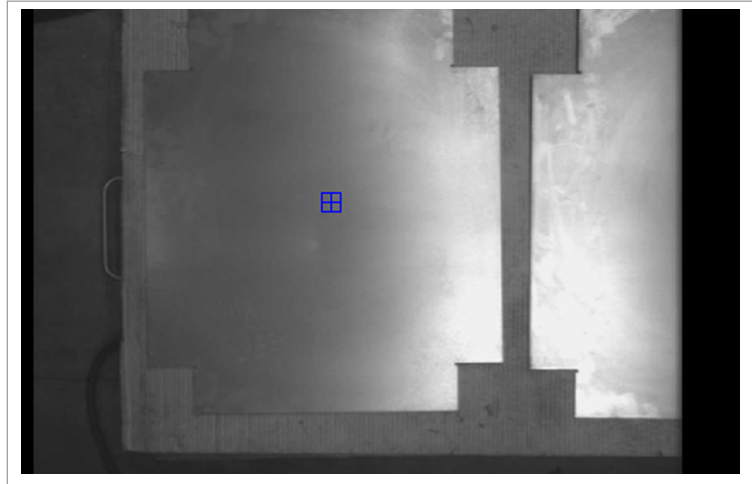


Fig. 59300

Note

Since the search results must include the height measuring point, it must be positioned on the stack to be searched for.

Rough recognition in the entire search area

Rough detection may be carried out both in a defined search area and in the complete search area.

For a rough recognition in the complete search area, the complete blank must be within the displayed search area.

5. Press *Find stack*.
6. Enter the approximate stack height ± 50 mm (stack height only, without transport medium).
7. Press *OK*.

The height is measured at the position previously defined. The rough recognition process is then performed on the stack. The search results found are displayed after the rough recognition:

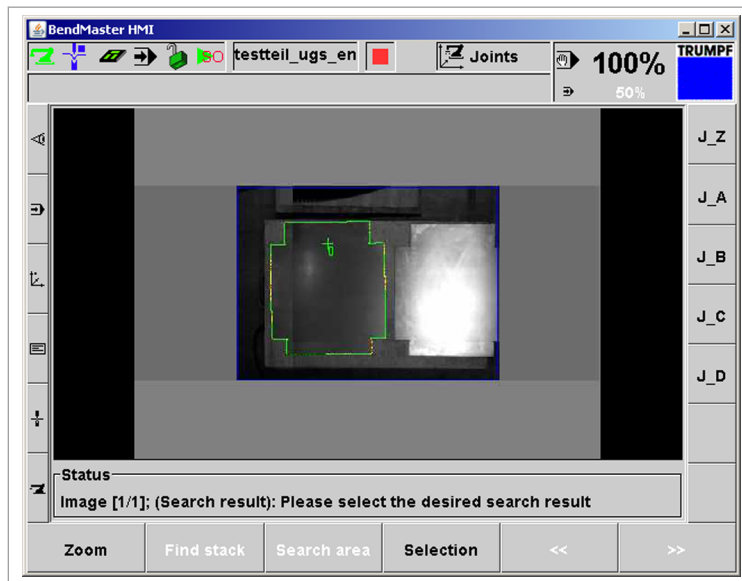


Fig. 54369

Note

There may be several search results. Image [1/2] means that the first of the two permissible search results is displayed.

8. Press << and >> to switch back and forth between the permissible results.
9. Press *Selection* in the correct search result. The selected search result is used as a loading stack. The "Stack layout" mask appears.

Rough recognition in the defined search area

Rough detection may be carried out both in a defined search area and in the complete search area.

For a rough recognition in a search area, the blank may protrude beyond the displayed search area in the X direction (see "Fig. 39926", pg. 4-73).

10. Press *Search area*.
11. Enter the approximate stack height ± 50 mm (stack height only, without transport medium).
12. Press *OK*.
13. Drag the blue rectangle over the desired search area.

The defined search area may exceed the area covered by the camera in the X direction:

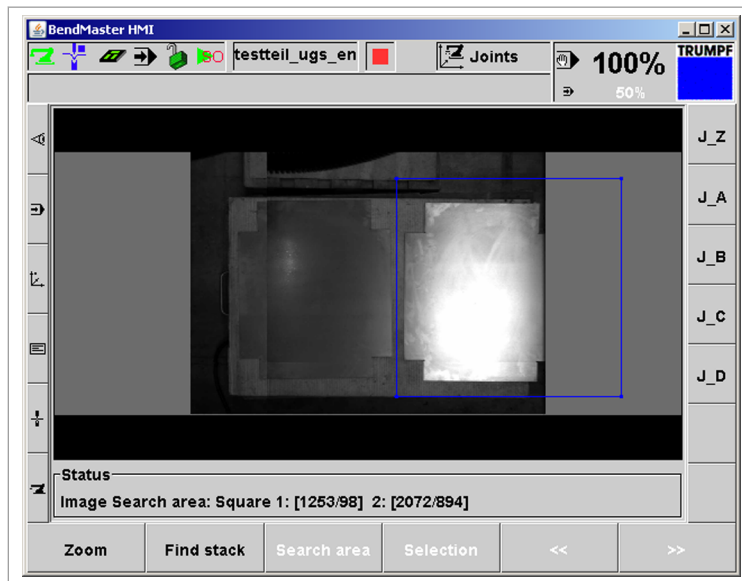


Fig. 42936

14. Press *Find stack*.

The stack is subjected to the rough recognition process. The found search results are displayed after rough recognition.

Note

There may be several search results. Image [1/2] means that the first of the two permissible search results is displayed.

15. Press << and >> to switch back and forth between the permissible results.
16. Press *Selection* in the correct search result. The selected search result is used as a loading stack. The "Stack layout" mask appears.

Searching for further loading stacks

Condition

- The rough recognition process is carried out.
 1. Switch to the >Run in >Area menu.
 2. Press *Display, Images of approximate search*.
 3. Position the blue cross-hairs from the top left corner of the screen at the point where the height is to be measured and the stack is to be searched for.

Note

Since the search results must include the height measuring point, it must be positioned on the stack to be searched for.

4. Search for further loading stacks using one of the two rough recognition options (see "Searching for an area", pg. 4-72).

Intermediate layer, searching for

Condition

- Intermediate store has been programmed in TruTops Bend (function available from TruTops Bend V4.15).

1. Switch to the *>Run in >Area* menu.
2. Mark the loading area for the intermediate layer (orange).
3. Press *Search within area*.

The intermediate layer area is searched. Depending on the size of the area, several images are recorded. The first image is displayed.

4. Position the blue cross-hairs from the top left corner of the screen at the point where the height is to be measured and the stack is to be searched for.
5. Press *Find stack* or *Search within area* to search for the stack.

Procedure in the event of problems with the rough recognition

Incorrect area is scanned Stack not found

1. In the *>Set up* menu, press *Apply areas*.
 - Height measuring point was not defined properly.
 - Stack is not entirely in the search area.
2. Use *Search within area*.
3. Search for several stacks with separate individual loading areas.

Part of the composite image is overexposed or underexposed

4. Reduce the size of the loading area, if possible.
5. Search for several stacks with separate individual loading areas.

Stack is not found properly

6. Use *Search within area*.
7. Change the height measuring point.

Height measurement not successful

- Height measuring point was not defined properly.
 - The pallet height is incorrect in the *>Set up >Areas* menu.
 - An incorrect stack height was entered during rough recognition.
8. In the *>Set up* menu, press *Apply areas*.

Incorrect stack height

The height measurement is a relative measurement between the BendMaster and the highest blank. For this reason, minimum deviations may occur between the actual and measured stack heights.

The distance between the highest sheet and the cover for the sensor system must be 333 mm during the fine recognition process:



Fig. 51848

- The pallet height is incorrect in the *>Set upAreas* menu.
9. In the *>Set up* menu, press *Apply areas*.

6.9 Defining stacks

Opening "Stack layout"

Switching over to "Stack layout" user interface is performed either automatically after the "find stack" process or as follows:

1. In the *>Set up* menu, press *Areas, Continue*.
- or**
- Press *>Set up, Stack layout*.

The loading stacks and unloading stacks found during the rough recognition process are displayed in color.

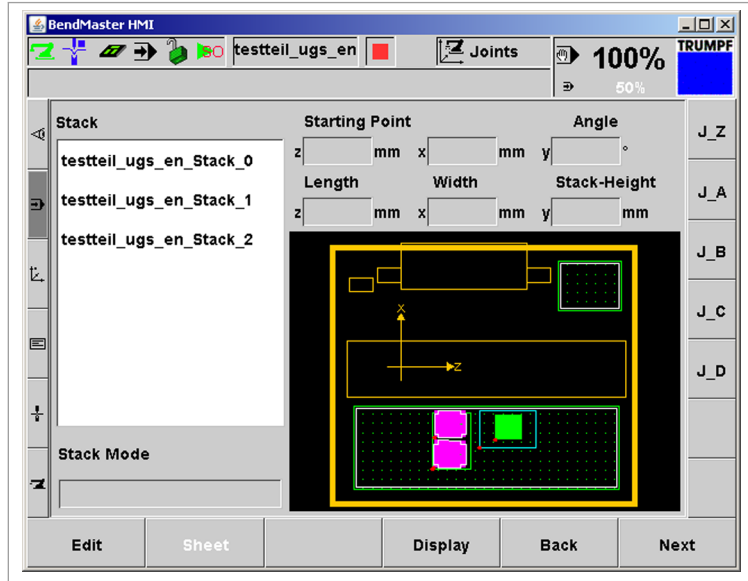


Fig. 39931

2. Mark the desired stack in the "Stack" list. "Stack mode" is displayed.

or

- Mark the desired stack in the graphic. "Stack mode" is displayed.

Note

The coordinates of the starting point of the marked stack are displayed at the coordinate arrows for the X and Z directions.

Loading stack:

Stack mode	Color
L stack active	Blue
L height OK	Gray
L coordinate OK	Gray
L stack empty	Red
L stack blocked	Orange
L stack blocked	Yellow

Tab. 4-18

Unloading stack:

Stack mode	Color
A stack active	Green
A stack ready	Cyan

Stack mode	Color
A stack full	Red
A stack blocked	Orange

Tab. 4-19

- Displaying stacks**
3. Press *Display, Filter, All stacks*. All stacks available in the control are displayed.
- or**
- Press *Display, Filter, Project stacks*. The stacks of the job opened on the Job page are displayed.
- or**
- Display *Display, Filter, Running project stacks*. The stacks of the currently loaded job are displayed.

6.10 Processing stacks

Condition

- A stack has been selected.

NOTICE

Risk of collision if the stacking mode is changed in an interrupted program!

- Before restarting the program, move the BendMaster manually to a collision-free position (e.g. zero position).

Delete stack Loading or unloading stacks no longer used can be deleted. Active stacks must first be deactivated before they can be deleted.

1. Press *Process, Delete stack*.

or

- Press *Process, Delete all stacks*.

Enabling a stack Empty loading stacks and full unloading stacks are no longer used by the control because no blanks can be picked up or set down there. These stack statuses can be changed manually in the control.

2. Press *Process, Lock/unlock stack*. The stack mode is changed:
 - At a stack height >0 mm: from *L stack empty* to *L coordinate OK*.
 - At a stack height >0 mm: from *L stack empty* to *L no coordinate*.
 - From *A stack full* to *A stack ready*.

-
- Disabling a stack** All stacks can be disabled apart from the stack modes *L stack empty*, *U stack (A stack) full* and *L no coordinate*. The disabled stacks are no longer used by the control system.
3. Press *Process, Lock/unlock stack*. The stack mode is changed:
- Changing the stack height** The height of a loading stack can be changed manually. Since the height measurement is a relative measurement between the BendMaster and the highest blank, there may be minimum deviations to the measured height.
4. Press *Process, Change Height*.
 5. Enter the stack height.
 6. Press *OK*. The height is changed.
- If the stack does not have the *L height OK* status, the stack mode is accordingly changed:
- From *L no coordinate* to *L height OK*.
- Note**
When the first blank is picked up from a stack in *L height OK* stack mode, the BendMaster automatically measures the height.
- Activating/deactivating a stack** Blanks can only be picked up from an active loading stack. Finished parts can only be deposited on an active unloading stack. Only one loading and unloading stack can be active at a time.
- If a loading stack is in *L coordinate OK* stack mode, sheets can be picked up, since the BendMaster automatically measures the height.
7. Press *Process, Activate/deactivate*. The stack mode changes:
 - From *L height OK* to *L stack active*.
 - From *A stack ready* to *A stack active*.
 - Or vice versa.
- In the standard sequence, the stacks are automatically activated according to their processing sequence. Manually activated stacks are processed first completely.
- Turning a loading stack 90°** This is practical for fine recognition to be able to rotate a symmetrical loading stack through 90° (e.g. if the first fine recognition area of the BendMaster cannot be reached).
8. Press *Process, Rotate stack 90°*.
- Turning a loading stack by x°** This is practical in order to be able to carry out fine recognition rotated at any angle between 0° and 180°.
9. Press *Process, Rotate stack by x*.
 10. In "Parameters," enter the angle by which the loading stack is to be rotated.

Emptying an unloading stack To reset the number of parts deposited on an unloading stack to 0 and switch the stack mode back to *A stack ready*:

11. Press *Process, Empty unloading area*. The stack is emptied.

or

➤ Press *Empty all unloading areas*. All stacks are emptied.

Changing the number of finished sheets The number of blanks in the loading stack or the number of finished parts in the unloading stack can be increased or reduced by pressing the button once. This is only possible with a loaded job.

12. Press *Sheet, Increment Sheet*.

or

➤ Press *Sheets, Decrement Sheet*.

Note

This change also has an effect on the blank loading or part depositing process. Note that there is a risk of collision!

Displaying stack details 13. Press *Display, Details*.

The details on the selected stack are displayed and can be edited. Grayed out fields cannot be edited.

Name	Description
Job	Name of the job in which the stack was created.
Range	Specifies whether the stack is a loading or unloading stack.
Stack use	<i>Stacked</i> = the blanks are picked up as programmed in TruTops.
Number of layers	Number of layers of the stack.
Current number of sheets	Number of sheets of sheets in the loading stack. Calculated on the basis of the stack height. Can be changed by the thickness of a sheet with <i>Sheet, Increment Sheet</i> or <i>Sheet, Decrement Sheet</i> .
Quantity intermediate layers	Number of intermediate layers in the unloading stack. Calculated on the basis of the stack height. Can be changed by the thickness of an intermediate layer with <i>Sheet, Increment Sheet</i> or <i>Sheet, Decrement Sheet</i> .
Offset fine recognition 1	Indication of the offset value when using height compensation during the initial fine recognition process.
Offset fine recognition 2	Indication of the offset value when using height compensation during the second fine recognition process. Note The height compensation is carried out during a third fine recognition process, even if the corresponding offset value is not displayed.

Details on the loading stack

Tab. 4-20

Name	Description
Job	Name of the job in which the stack was created.
Range	Specifies whether the stack is a loading or unloading stack.
Stack use	<ul style="list-style-type: none"> ▪ <i>Stacked</i> = the blanks are picked up as programmed in TruTops. ▪ <i>Box</i> = the finished parts are placed in a box.
Number of layers	Number of layers of the stack.
Current number of sheets	Number of finished parts in the unloading stack. Can be changed by a piece with <i>Sheet, Increment Sheet</i> or <i>Sheet, Decrement Sheet</i> .
Quantity intermediate layers	Number of intermediate layers in the unloading stack.
Max. sheets	Maximum number of finished parts which can be deposited on the unloading stack until <i>A stack full</i> is established. The maximum number of finished parts comes from TruTops and depends on the simulated unloading stack. It can only be reduced, not increased.

Details on the loading stack

Tab. 4-21

Redisplaying the diagram

14. Press *Display, Overview* to display the graphic again.

Defining the stack processing sequence

The stack processing sequence can be adjusted both for loading and unloading stacks, e.g. when using eccentric grippers. This is only possible with a loaded job:

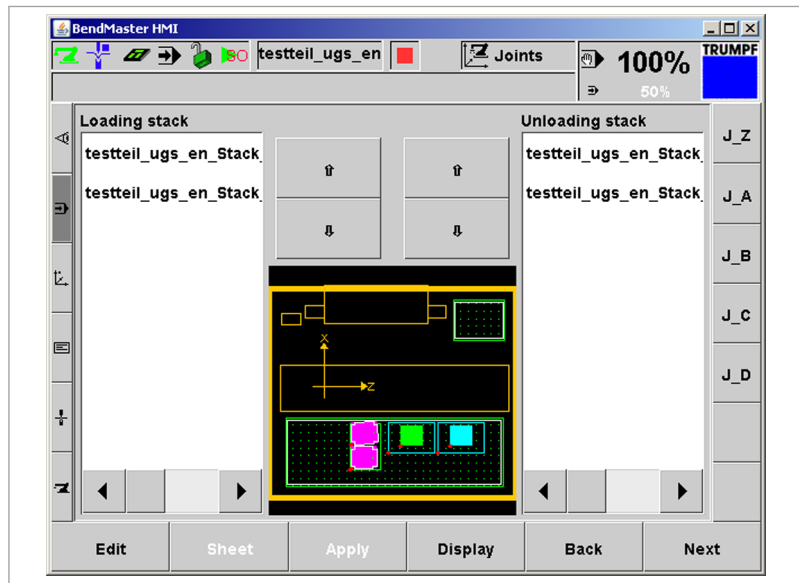


Fig. 51855

15. Mark the desired stack under "Loading stack" or "Unloading stack".

16. Move the marked stack up using ↑ or down using ↓.

The stack at the first position is executed first, the stack at the second position is executed second, and so on.

17. If the processing sequence has been set, press *Adopt*.

The stack mode of the stack executed first is changed to *L stack active* or *A stack active*.

Note

Manually activated stacks remain in *L stack active* or *A stack active* stack mode.

6.11 Creating a tooling plan

Checking the TruTops tooling plan

1. In the "Stack layout" mask Press *Continue*..

or

➤ press >Set up >Tooling plan.

2. Press *Setup plan*. The setup plan created in TruTops Bend is displayed:

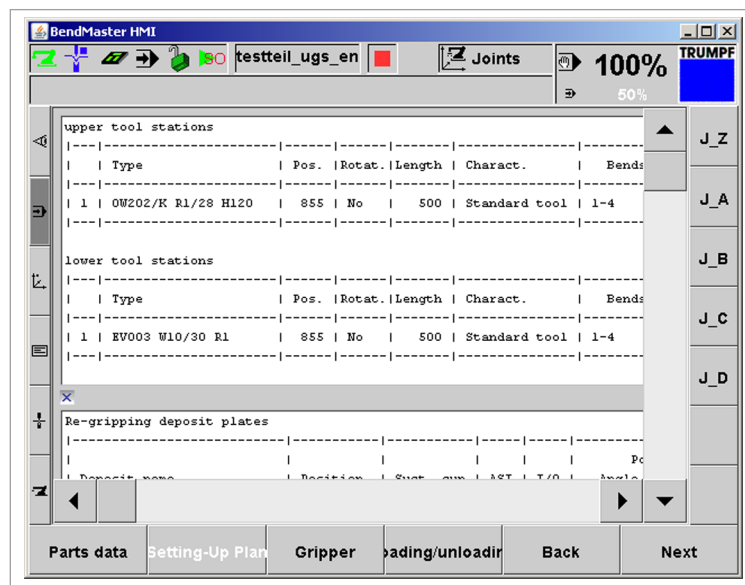


Fig. 39936

3. Load the bending machine according to the tooling plan.
4. To display the gripper information: press *Gripper*. The gripper plan is displayed:
5. To display the parts data: press *Parts data* drücken. The data is displayed.
6. To display the original loading positions programmed in TruTops: press *Load/unload*. The information is displayed.

Selecting a separation method

1. In the "Tooling plan" mask, Press *Continue*.

or

- press >Set up >Separation method.

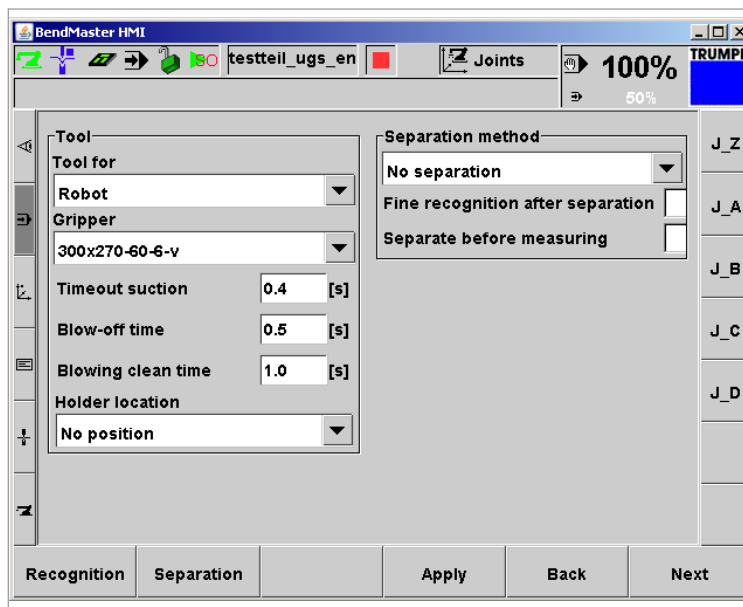


Fig. 51856

2. Under "Tool for", select *Robot* or *Regripping station* (if programmed in TruTops).
3. Select "Gripper" for the previously selected tool.

Note

At present, only the gripper used in TruTops can be selected.

4. Set the suction and blow-off times:
 - "Timeout suction":
Delay until the vacuum switch is actuated.
 - "Blow-off time": period during which the sheet is blasted when deposited.
 - "Blowing clean time":
Period after depositing the blank during which blasting is continued during the travel motion up to the next interpolation point. This prevents the blank from moving within the stack or sticking to the gripper. In addition, the vacuum system is cleaned.
5. Set "Holder location":

- "No position":
If no gripper is set up, the BendMaster remains in the current position for loading the gripper.
 - "Tool-change height":
If no gripper is set up, the BendMaster moves into the gripper changing position for loading the gripper.
 - "Gripper deposit station":
If the required gripper is at the gripper deposit station, the BendMaster picks this gripper up from there.
6. Set the "separation method" (sheet separation method used):
- *No separation*:
No separation is performed.
 - *Separation at the gripper*:
Double sheet separation by activating the AS-i slave at the gripper (peeling) (see "Tab. 4-22", pg. 4-86).
 - *Separation by travel motion*:
Double sheet separation by moving the C axis (see "Tab. 4-23", pg. 4-86).
 - *Combined separation*:
Combination of separation at the gripper and separation by travel movement (see "Tab. 4-24", pg. 4-87).

Name	Description
Separating time	Duration of the peeling movements
Delay time	Time between two peeling movements
Cycles	Number of peeling movements

Separation at gripper

Tab. 4-22

Name	Description
Peeling switched off	Peeling is switched off
Peeling at close range	The peeling movement is performed on the floor lane side (only in combination with the Offset 1 and Angle 1 settings (see "Fig. 42938", pg. 4-87)).
Peeling from a distance	The peeling movement is performed on the safety fence side (only in combination with the Offset 2 and Angle 2 settings (see "Fig. 42938", pg. 4-87)).
Peeling all points	One peeling movement is performed at close range and one at a distance.

Separation by moving

Tab. 4-23

Name	Description
Gripper, then travel motion	First, separation at the gripper, then separation by travel movement
Travel motion, then gripper	First, separation by travel movement, then separation at the gripper

Name	Description
Gripper and travel motion	Simultaneous separation at the gripper and by travel motion.

Combined separation

Tab. 4-24

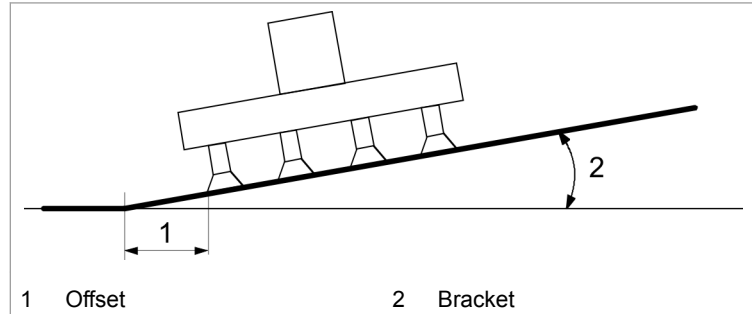


Fig. 42938

7. Set a checkmark at "Fine recognition after separation" if an additional fine recognition process is to be carried out after the separation, regardless of the fine recognition set.
8. Set a checkmark at "Separate before measuring" if a peeling cycle is to be carried out prior to the double sheet measurement.

Note

Only peeling is possible at the gripper. Separation is not possible at the gripper (see "Tab. 4-23", pg. 4-86).

Separation is recognized a cycle by the cycle counter.

Selecting double sheet recognition

1. In the "Tooling plan" Press *Continue*. mask,
or
 ➤ press >Set up >Separation method.
2. Press *Recognition*:

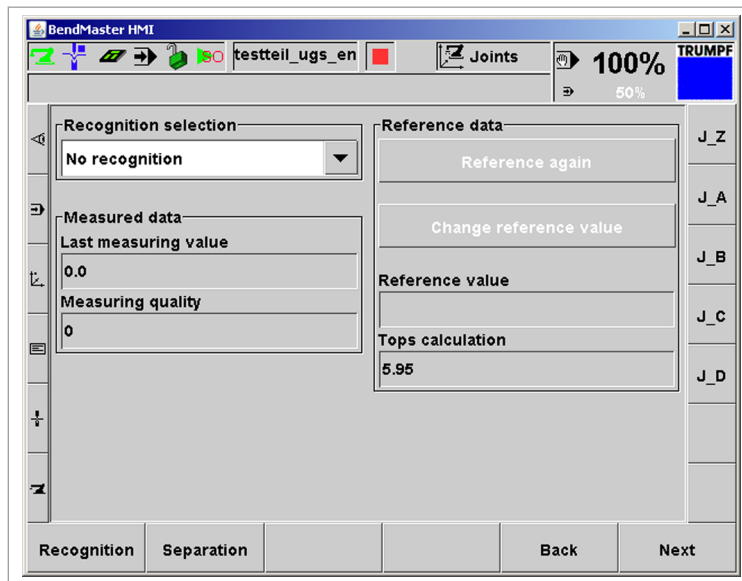


Fig. 52488

3. Define the *Recognition selection*:

- *No recognition*:
No double sheet recognition is performed. However, a separation method can be selected which is executed when picking up a blank, regardless of whether a double sheet was picked up or not. Likewise, the execution of the program is continued after the separation cycle.
- *Pallet scale*:
A double sheet recognition is performed using the pallet scale. The loading stack must be on the pallet scale. The separation process is performed according to the set separation cycle only after recognizing that a double sheet has been picked up. The execution of the program is resumed after successfully separating the double sheet.
- *Integrated system*:
A double sheet recognition is performed with the integrated measurement system. The separation process is performed according to the set separation cycle only after recognizing that a double sheet has been picked up. The execution of the program is resumed after successfully separating the double sheet.

6.12 Setting bending parameters

Parameters for bending support, backgauge sensor system, approaching the backgauges and the actuation of the backstop resistors can be set for every bending step in the bending parameters.

Note

When a program is run in, the parameters for bending support and for approaching the backgauges are not yet defined. After crossing the bend for the first time, the default parameters stored in the control are entered. Due to the fact that the averaging filter cannot be adjusted by personnel, this parameter has no default value even after crossing.

Opening bending parameters

1. On the "Separation method" screen Press *Continue*.

or

➤ press >Set up >Bending parameters.

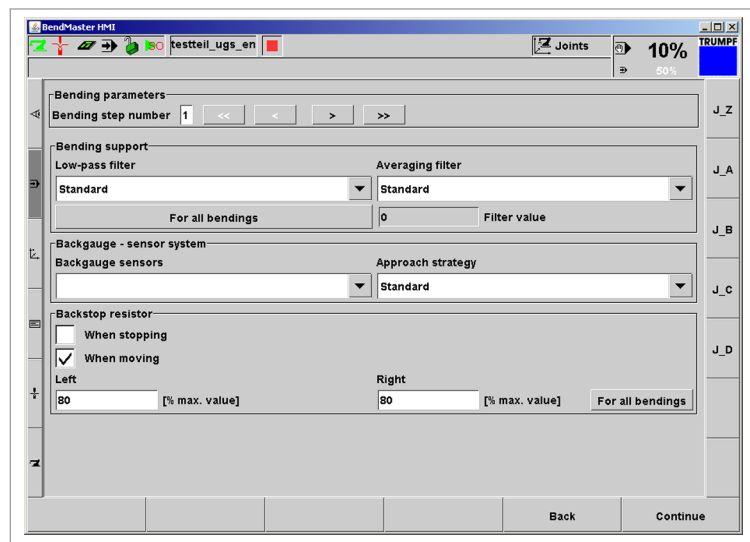


Fig. 49448

Note

The Backstop resistor field is displayed only for activated backstop resistors.

2. Use the following buttons to select the bending which is to be modified:

Name	Description
>	Go forward one bending step from current bending step.
>>	Go to last bending step.
<	Go back one bending step from current bending step.
<<	Go to first bending step.

Tab. 4-25

Selecting bending support

Bending support is the movement of the BendMaster during the bending process (tracking).

1. Select bending step.
2. Set the "low-pass filter":
 - *No filter:*

During bending, the BendMaster moves exactly according to the specified TruBend position. In some cases, this can lead to abrupt BendMaster movements due to the press beam regulation.
 - *Low:*

The TruBend position settings are filtered somewhat to ensure that the bending support proceeds less abruptly. The movement of the BendMaster for moving the bending part is however slightly delayed in time, which increases the possibility of a reverse bend on the bending part.
 - *Medium:*

The TruBend position settings are filtered more strongly. The bending support is smoothed to a greater extent and the movements proceed more gently. The delay time of the BendMaster compared to the bending part becomes even longer.
 - *High:*

The TruBend position settings are filtered to the maximum extent. The bending support is smoothed to the maximum extent. The time delay of the BendMaster compared to the bending part increases significantly. The possibility of a reverse bend or of the cups being torn off the sheet increases.
3. Press *For all bendings* if the settings are to apply to all bending operations..

Note

The averaging filter cannot be adjusted by personnel.

Setting the backgauge sensor system

The necessary backstop strategy can be set in the "Backgauge sensor system" field. The default values originate from TruTops Bend. The press beam is enabled for the bending motion once the set parameters have been reached.

1. Select bending step.
2. Setting "backgauge sensors":

- *Without backgauge:*
No sensor system is used.
- *Alignment left:*
The left backgauge sensor is active in the X direction.
- *Alignment right:*
The right sensor is active in the X direction.
- *Alignment left and right:*
Both sensors are active in the X direction.
- *Clamp left:*
The left sensor is active in the Z direction.
- *Clamp right:*
The right sensor is active in the Z direction.
- *Align and clamp left:*
The left and right sensors are active in the X direction.
The left sensor is active in the Z direction.
- *Align and clamp right:*
The left and right sensors are active in the X direction.
The right sensor is active in the Z direction.

Setting the approach strategy

The travel motion of the press beam during bending in combination with the search movement of the backgauge is set in the "Approach strategy" field.

1. Select bending step.
2. Set the "approach strategy":
 - *Backgauge and Y movement:*
Travel motion and search movement run parallel. That is the fastest method and therefore also the default value.
 - *Y movement before backgauge:*
The travel motion of the press beam is carried out before the search movement of the backgauge, e.g. when horn tools are used.
 - *Backgauge before Y movement:*
The search motion of the backgauge is carried out before the travel motion of the press beam, e.g. for short side lengths.

Setting the backstop resistor for single bending operations

Condition

- Backstop resistors have been activated by the TRUMPF Service Department.
1. Press *>Set up >Bending parameters*.
 2. Select "Bending number" if the backstop resistor is to be adjusted for a single bending operation.
 3. Select "When stopping" with a checkmark. The backstop resistor is active while the backgauge approaches its position.
- or**
- Select "When moving" with a checkmark. The backstop resistor is active while the backgauge withdraws from the workpiece.
4. Enter the strength of the backstop resistor between 0 and 100 %:
 - "Left": actuation of the left backstop resistor.
 - "Right": actuation of the right backstop resistor.
 5. Press *For all bendings* if the backstop resistor setting is to be applied for all bending operations in the program.

6.13 Program, loading

Opening the running in program

Conditions

- All axes have been referenced.(see ["Referencing the BendMaster", pg. 4-39](#)).
- The system is ready for operation in automatic mode.
- No error messages, i.e. green LED on the portable manual control unit lights up (acknowledge error if red LED is on).
- BendMaster is ready for operation (the GREEN button was pressed, and the "BendMaster" icon is green).
- No gripper set up.

or

- The used gripper is set up.
- **Note**
It is only checked whether a gripper has been set up at all and not whether the correct gripper has been set up.

➤ In the "Separation method" mask, press *Continue*.

or

➤ Press >Setup >Run in.

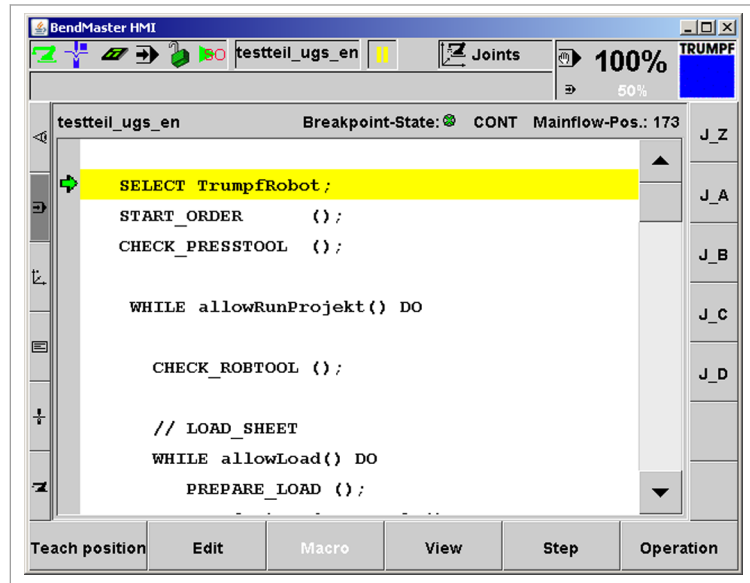


Fig. 39942

The individual program steps are displayed. The green arrow indicates the program step currently being executed.

Program steps for running in

Program step	Description
SELECT TrumpfRobot	Program reserves a robot. The robot can no longer be used by any other program.
START_ORDER	The robot gets ready for processing the selected job.
CHECK_PRESSTOOL	Starts the bending machine and the regripping station for job processing
CHECK_ROBTOOL	Checks whether the robot tool is fitted. The robot is moved into tool change position if necessary.
LOAD_SHEET	Sheet pick-up subroutine.
LOAD_LAYER	Intermediate store pick-up subroutine.
EXTERN_VISION_SHEET	External fine recognition subroutine, e.g. at the backlighting table.

Program step	Description
BEND_SHEET	Sheet bending subroutine.
UNLOAD_SHEET	Store part subroutine.

Tab. 4-26

Selecting an execution method

Jobs can be loaded either in continuous operation mode or step-by-step. Continuous operation is activated by default.

1. To run in the program step-by-step: press *Stepping*. The current program step is displayed on a yellow background:

or

➤ Press *Cont* to return to continuous operation.

2. Press the green START key on the portable manual control unit.

Note

When running in step-by-step, each program step must be started using the green START key on the portable manual control unit.

3. If a program is to be executed only up to a specific program point:
 - Interrupt the program at the portable manual control unit using the red STOP key.
 - Press *Stepping*.
 - Mark the program point at which the program is to be interrupted.
 - Press *Operation, Set Breakpoint*.
 - Press *Operation, Activate/deactivate Breakpoint*. The program is only interrupted at the breakpoints indicated by checkmarks.
 - If required, press *Set PC*.
 - Press *Operation, Go to breakpoint*. The program is executed up to the active breakpoint.
 - Press *Operation, Remove all breakpoints* to delete all active breakpoints.
4. To interrupt the running-in process, press the red STOP key on the portable manual control unit.

Running in procedure

- The press brake is started.
- The press program is loaded by the industrial PC.

- The tools and backgauge of the TruBend are clamped and positioned.
- The gripper used is fitted on the BendMaster if it has not been fitted yet.
- Either the blank is picked up and transferred to the backlighting table or a fine recognition is performed at the stack.
- If double sheet recognition was activated, double sheet recognition and double sheet separation are performed.
- The bending program is executed.
- Finished sheets are set down on the unloading stack.

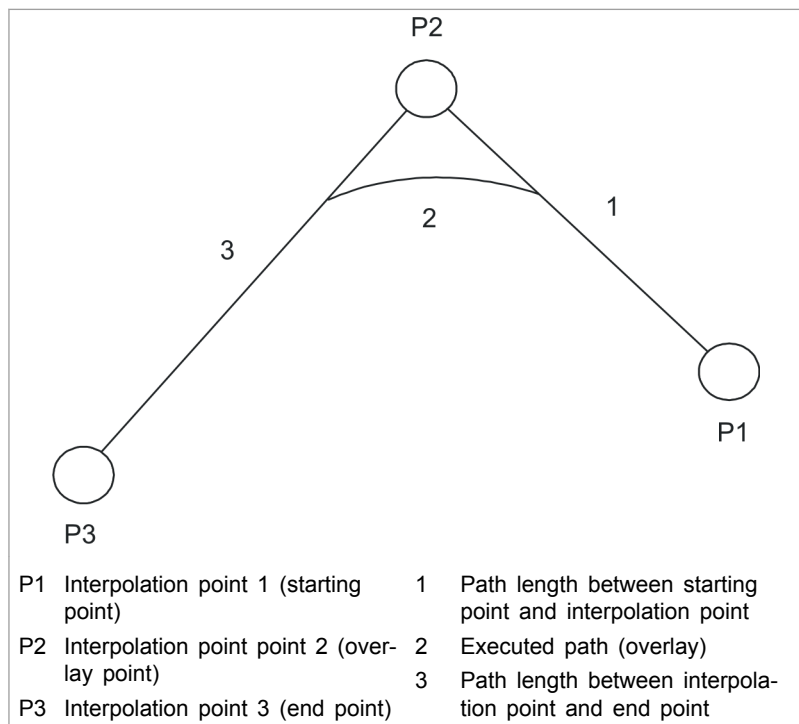
Interpolation points

The points within a path that the BendMaster moves along when approaching and traveling are referred to as calibration points and programmed in TruToPs. There are two ways of editing such calibration points:

- To teach a point: the desired position of the marked point is approached manually and saved as a new position.
- To edit a point: the position is changed by changing the coordinates manually in the respective coordinate system. In addition, the interpolation type, the speed and the overlay can also be changed if the respective user level is logged on.

Overlay

The path does not always need to be precisely complied with in some travel motion sections. The cycle time can be reduced by starting the next path early. This procedure is called overlaying:



Overlaying calibration point

Fig. 45198

The overlay can start at the earliest halfway up the shorter path.

Teaching a point

If the position of a point has to be corrected manually when running in a part, the point can be taught.

Notes

- Taught points can **not be reversed**.
 - The current position of the regripping station is also taught.
1. Interrupt the program at the portable manual control unit using the red STOP key.
 2. Approach the point to be taught step-by-step.
 3. Approach the new position manually (make sure the correct coordinate system is used).
 4. Mark the program point to be taught. This program point is displayed on a yellow background.
 5. In the "Run in" mask, press *Teach position*.
 6. Confirm the query with *OK*.

Points, editing

1. Interrupt the program at the portable manual control unit using the red STOP key.
2. Mark the program point to be edited. It is displayed on a yellow background.
3. *No*.

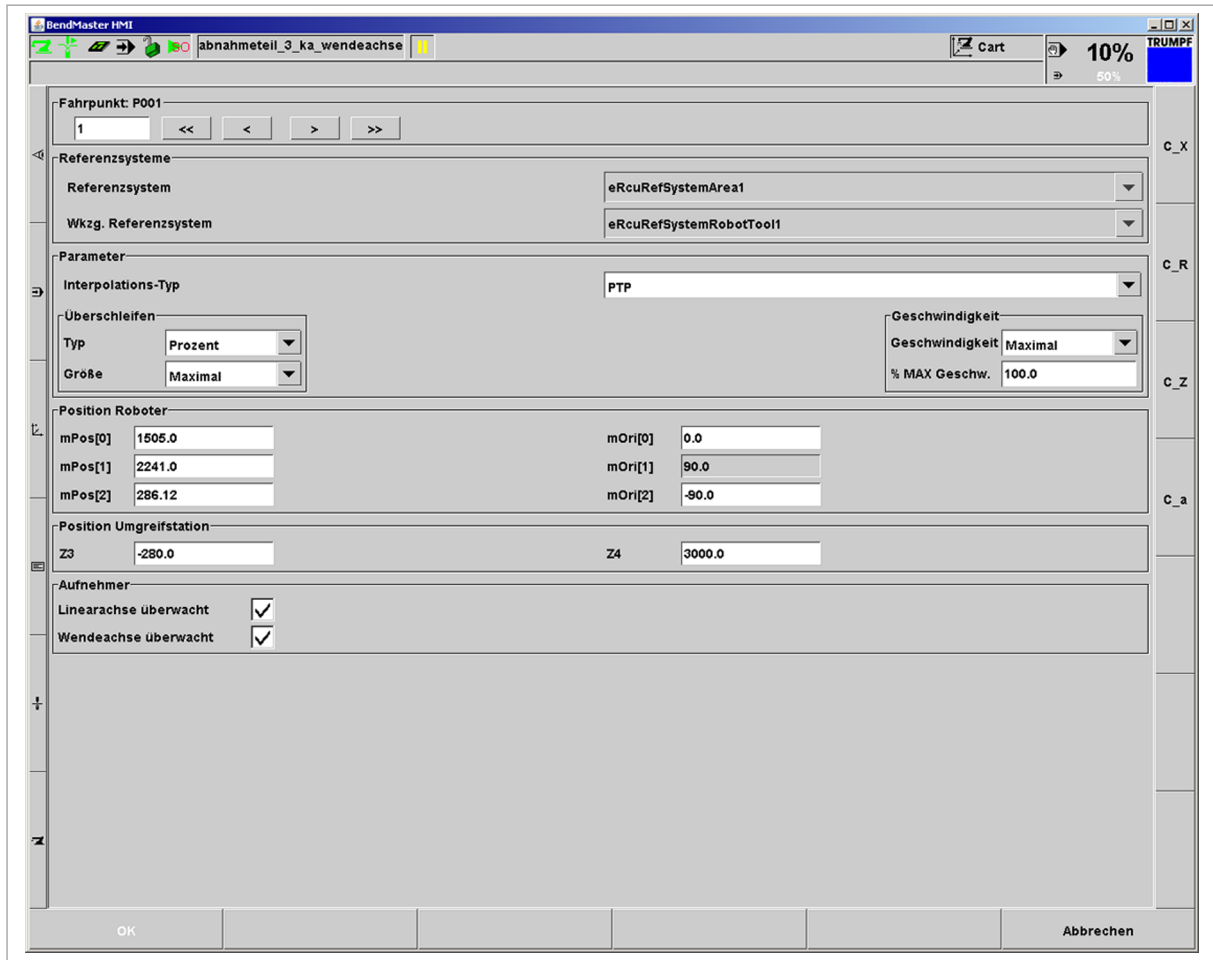


Fig. 65022

4. Change the desired parameters (only parameters on a white background can be changed).

Parameter	Selection	Description
Travel point	Number in the program	The travel point to be modified can be selected using the arrow buttons.
Interpolation type	LIN	<ul style="list-style-type: none"> Cartesian path. The position is moved along a path. The speed of the tool center point remains constant.
	PTP	<ul style="list-style-type: none"> Point-to-point path. The movement from the starting position to the end position is as quick as possible, regardless of the path. No linear movement of the tool center point.
Speed	Slow	20% of the max. speed
	Reduced	30% of the max. speed
	Medium	50% of the max. speed
	Fast	75% of the max. speed
	Maximum	Maximum speed
	User defined	Entry in % of the maximum value

Parameter	Selection	Description
Overlay type	Exact	Point is approached exactly on the calculated path.
	Length	The overlay starts at one of the shorter path lengths according to the stored radius of the programmed interpolation point (see "Fig. 45198", pg. 4-95).
	Percent	The overlay starts at a percentage of the shorter path length stored according to the size (see "Fig. 45198", pg. 4-95).
	Speed	For TRUMPF Service only.
Overlay size	Fine	For Percent: 10% At length of 3 mm
	Reduced	At percentage of 20% At length of 20 mm
	Medium	For Percent: 40% At length of 80 mm
	Large	At percentage of 70% At length of 200 mm
	Maximum	Maximum possible position At length of 600 mm
Position robot	mPos[0]	First coordinate axis in the right-hand (standard) coordinate system
	mPos[1]	Second coordinate axis in the right-hand (standard) coordinate system
	mPos[2]	Third coordinate axis in the right-hand (standard) coordinate system
Position regripping station	Z3	Position of the left regripping station
	Z4	Position of the right regripping station
Pickup	Gripper monitoring	Starting with software V7.0, the linear axis and the turning axis can be moved at the same time, both travel motions must therefore be monitored. Monitoring is programmed by TruTops Bend by default.

Tab. 4-27

5. Press *OK*.

The modifications are accepted.

Setting the main run indicator manually

The green arrow (main run indicator) indicates the current execution status of the automatic program. It can be set manually by the operator.

When the automatic program is restarted, it is resumed at the new position of the main run indicator. This point is approached directly by the BendMaster.

NOTICE**Risk of collision when approaching the desired position!**

- Watch out for possible collisions when approaching the respective position after setting the main run indicator.
- Reduce the speed, if necessary.

1. To interrupt the program, press the red STOP key on the portable manual control unit.
2. Mark the program line where the main run indicator is to be set.
3. Select *Operation, Set PC*:

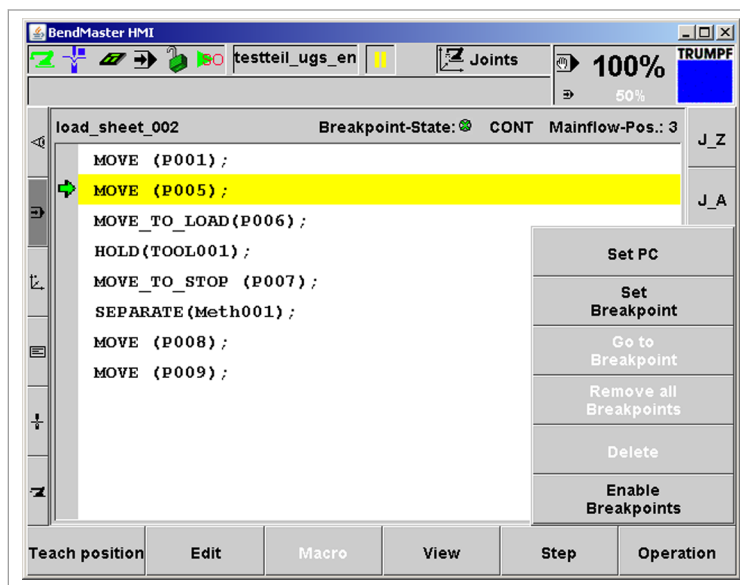


Fig. 39943

4. Press the green START key on the portable manual control unit.
The automatic program is resumed at the marked line.

Deleting a point**Note**

Program steps can be deleted only during step-by-step operation.

Program steps that have been deleted cannot be restored.

1. Press the red STOP key on the portable manual control unit.
2. Press *Operation, Delete*.

The marked point is deleted.

Displaying axis positions

1. Press *View, Positions*. The axis positions are displayed in the selected displayed coordinate system.
2. Press *View, Show none*. Displaying the axis positions is deactivated again.

6.14 Starting a run-in program

Conditions

- Loading and unloading stacks have not been changed since the Run in.
- The setup plan of the TruBend, including the regripping station, has not been changed since the run in.
- The correct gripper is loaded at the BendMaster.
- All axes have been referenced.(see "[Referencing the BendMaster](#)", pg. 4-39).
- The program has been run in.
- The system is ready for operation in automatic mode.
- No error messages, i.e. green LED on the portable manual control unit lights up (acknowledge error if red LED is on).
- BendMaster is ready for operation (the GREEN button was pressed, and the "BendMaster" icon is green).

Opening and starting the program

1. Press *>Set up >Job*:
2. Select the job to be executed in the "Selected Order" list. The selected job is opened and graphically displayed. Now it can be further processed.

Tip

If the job is clicked on again, it is closed.

3. Press *PositionAutomatic*:

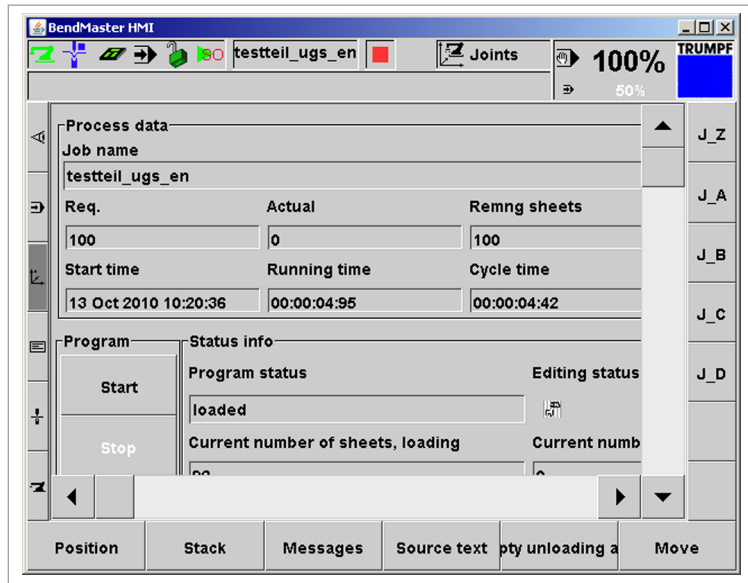


Fig. 40877

4. Press *Start* in the "Program" field. The job under the job name is started.
The active execution of a job is indicated by the green light of the signal lamp on the safety fencing.
5. Press *Stop* in the "Program" field if the execution of the job is to be interrupted immediately.
6. Press *Resume* in the "Program" field if the interrupted job is to be further executed.

Advance warning, number of blanks below minimum on loading stack

The number of blanks on the loading stack, below which a warning information is issued, can be programmed.

7. Enter the corresponding quantity in the "Advance Warning Sheets Load".

Starting with this number, the text "Advance warning Sheets Load" will be displayed in red. At the same time, the white signal lamp on the safety fencing is switched on.

Advance warning, free deposit places below minimum

The number of available free deposit places below which a warning information is issued, can be programmed.

8. Enter the corresponding quantity in the "Advance Warning Sheets Deposit" field.

Starting with this number, the text "Advance warning Sheets Deposit" will be displayed in red. At the same time, the white signal lamp on the safety fencing is switched on.

**Having the axis position displayed
Switching to "Stack assignment"
Switching to "Diagnostics"
Switching to "Run in"
Emptying an unloading stack**

9. Press *Position*.
10. Press *Stack*(see "Defining stacks", pg. 4-78).
11. Press *Messages*.
12. Press *Source text*(see "Program, loading", pg. 4-92).
13. Press *Empty unloading area*.

6.15 Production planning

There are three levels in the production planning of the Bend-Master:

- Production lists.
A production list may consist of production packages and jobs. It may contain a maximum of 10 elements.
If no loading or unloading stack is available, then the execution of the production plan is continued with the next job, production package or production list.
- Production packages.
A production package may consist of one or more jobs. A production package may contain a maximum of 10 jobs.
If no loading or unloading stack is available, then the execution of the job is completely stopped.
A number of repetitions can be programmed for the entire production package.
- Jobs.
A job contains one bending part and the quantity as to how often it is to be produced. In addition, the speed can also be set.

Creating or modifying a production plan

Conditions

- It must be possible to use the tool setup plan for TruBend and the regripping station for **all** jobs within the production package.
- The required grippers are in the gripper deposits.
- All jobs of the production package have been retracted.

Opening a production plan

1. Select *>Position >Production plan*:

Tip

Press >> or << to show or hide the tabs on the right-hand side.

2. Select "Production list" to create or open a production list.

or

- Select "Packages" to create or open a production package.

Create production package or production list

3. Press .
4. Enter the name of the production list or production package under "Parameter".

Open production package or production list

5. Mark the desired production package or production list.

6. Press .

The selected element is opened and displayed in the window on the left.

Adding elements to the production plan

7. In the window on the right, mark the desired production packages or jobs.

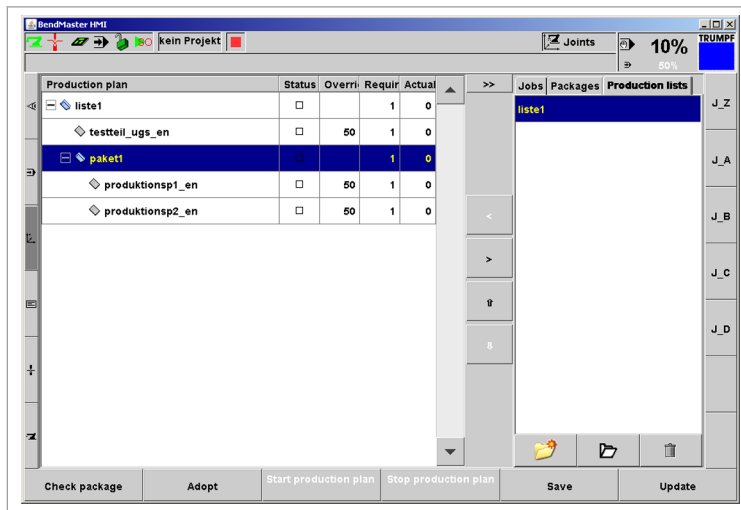


Fig. 59281

8. Press <. The marked element is added to the production plan on the left.

Tip

The *Update* button can be used to update the list of available jobs.

Remove elements from the production plan

9. Press Save to save the production plan.

10. Highlight the desired element in the window on the left.

11. Press >. The marked element is removed from the production plan on the left.

Modifying the sequence of the elements

12. Highlight the element to be modified in the production plan.

13. Press ⬆ to move the element up.

or

➤ Press ⬇ to move the element down.

Deleting an element completely

14. Highlight the desired element in the window on the right.


15. Press . The marked element is removed from the production plan on the left.

Setting the speed and required number

1. Open "Jobs", "Packages" or "Production lists" in the window on the right.

2. Click on the "Required" field of the desired element in the production plan on the left.
3. Enter how frequently the element is to be produced.
4. Click on the "Override" field of the desired job in the production plan on the left.
5. Enter the speed in [%] at which the job is to be produced.
6. Press *Apply*. The settings are transferred to the control.

The following statuses can be displayed in the "Status" field:

- : No data available in the control.
 - : The data was transferred to the control.
7. Press *Save*. The elements are saved to the production plan.

Executing the production plan







Both single production packages and complete production lists can be processed.

1. Mark the production list, production package or job in the window on the left.
2. *Press Save*.
3. *Press Apply*.
4. According to the selected element, press *Check job*, *Check package* or *Check job list*.

A check is made to determine whether all start requirements have been fulfilled.

- The loading and unloading stacks are available.
- The required grippers are available.
- The job has been run in.

If all requirements are fulfilled, the status changes to ready.
Possible status messages:

- : Job/package/list ready.
 - : Job/package/list cannot be run.
5. Press *Start production plan*. The production plan is executed.
Possible status messages:
 - : Execution of job/package/list in progress.
 - : Execution of job/package/list has ended.
 6. Press *Stop production plan*. Start production plan is stopped.
Possible status messages:
 - : Job is interrupted.
 - : No loading or unloading stack available.

6.16 Connection to storage (option)

The TruBend Cell 5000 can be linked to a storage system.

The stack positions must be booked correctly in the warehouse management software, (e. g. TruTops Fab). The image recognition alone is not sufficient.

Parts automatically requested from the storage system by the BendMaster may be set down on the storage pallet only as individual stacks. The stack must not include any parts of a different job.

The operator must observe the following:

- The BendMaster must not collide with neighboring stacks on the storage pallet when picking up a part.
- The stack height must not exceed the permissible maximum value when returning processed parts to storage.

Defining parts data

1. Press *>Set up >Job* menu.
2. Enter the "parameters", "lot size" etc.
3. Press *Parts data*.
4. In the drop-down menu, press *Unprocessed material*, *Finished part* or, if available, *Intermediate layer part*.

The selected parts data is displayed and can be entered (see "Tab. 4-9", pg. 4-55), (see "Tab. 4-10", pg. 4-55), (see "Tab. 4-9", pg. 4-55).

- The material designation must be known to the storage management.
- Observe that the entries are case sensitive.

Defining loading and unloading areas of the storage stations

1. Press *>Set up >Areas* menu.
2. Define the loading and unloading areas. The control sends the entries directly to the storage management program:



Area type	Description
<i>Load Search exact</i>	If programmed, the BendMaster directly performs the fine recognition process and picks up the parts. The BendMaster obtains the information about the position, orientation and height of the stacks from the storage management software.
<i>Load Search automatic</i>	At the beginning of each stack, a coarse and then a fine recognition process are automatically performed and then the stack is completely executed.
<i>Load Search Manual</i>	The operator performs the rough recognition process manually.
<i>Intermediate layer search exact</i>	If present, the BendMaster directly picks up an intermediate layer. The BendMaster obtains the information about the position, orientation and height of the stacks from the storage management software.
<i>Intermediate layer search automatic</i>	If present, a rough recognition process is performed at the beginning of each intermediate layer stack and the stack is then completely executed.
<i>Intermediate layer search manual</i>	The operator performs the rough recognition process manually.

Area types, receiver

Tab. 4-28

Moving a storage cart manually

1. Move the BendMaster into the parking position.
2. Open the lift gate at the lift gate control.
3. Move the storage cart manually using the control panel of the storage control system.

Moving the BendMaster semi-automatically

Conditions

- The >Set up >Areas menu is open.
- The system is ready for operation in automatic mode.
- BendMaster is ready for operation (the GREEN button was pressed, and the "BendMaster" icon is green).

Selecting the storage station

1. Press *Display, Details*.
2. Select a storage station from the drop-down menu.

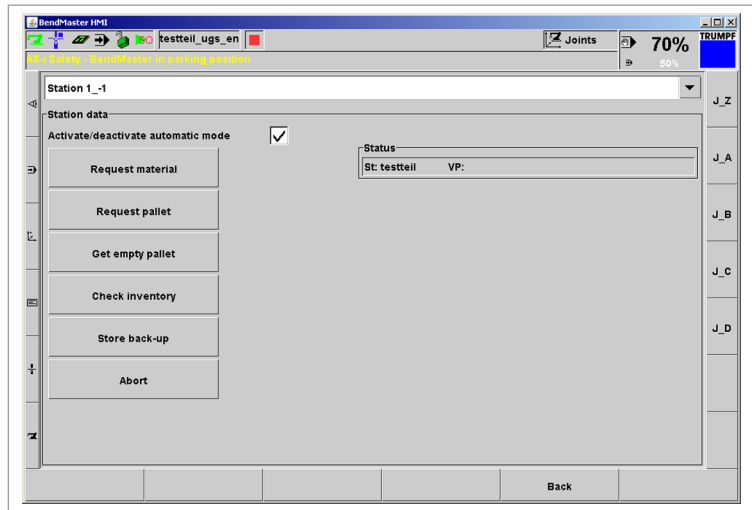


Fig. 61853

- Requesting material**
3. Remove the checkmark from "Activate/deactivate automatic mode".
 4. Press the desired sequence.
 5. Enter the desired *material ID*. This entry is case sensitive.
The material ID must be known to the storage management software.

Sequence

- Request material.
- BendMaster automatically moves into parking position.
- The lift gate opens.
- The storage cart enters with the requested material.
- The lift gate closes.

- Requesting a pallet**
6. Enter the desired *pallet ID*. This entry is case sensitive.
The pallet ID must be known to the storage management software.

Sequence

- Request a pallet.
- BendMaster automatically moves into parking position.
- The lift gate opens.
- The storage cart enters with the requested pallet.
- The lift gate closes.

- Requesting an empty pallet**
7. Enter the desired *pallet ID*. This entry is case sensitive.
- The pallet ID must be known to the storage management software.
- By default, the *SPml* pallet type is defined as an empty pallet in the storage management program.

Sequence

- Request an empty pallet.
- BendMaster automatically moves into parking position.

- The lift gate opens.
 - The storage cart enters with the requested pallet.
 - The lift gate closes.
- Checking the stock** 8. Press *Check inventory*. All available stocks are displayed.
- Returning to storage** 9. Press *Store back-up*. The pallet at the BendMaster storage station returns to the storage system.
- Sequence
- BendMaster automatically moves into parking position.
 - The lift gate opens.
 - The storage cart departs with the pallet.
 - The lift gate closes.
- Aborting the travel to storage** 10. Press *Abort*.
- All positions are deleted in the control.
11. Re-book all positions by means of a manual travel to storage.

Moving a storage cart in automatic mode

Optionally, single jobs (single order operation) or entire production plans with store connection can be executed automatically (see "Production planning", pg. 4-102).

If a job or production plan is started, the control checks whether the required raw material is in the production cell.

The control also checks whether the finished parts are to be booked to the storage system. An empty pallet is requested from the storage system if necessary.

- Sequence**
- The storage control is notified about the activated travel order.
 - The BendMaster moves into parking position.
 - The storage pallet is reserved by the storage system.
 - The BendMaster releases the pallet.
 - The storage system disables the pallet and sends the "Open gate" request.
 - The BendMaster control opens the lift gate. The pallet is moved into or out of the production cell.
 - The gate is closed.
 - The storage system releases the pallet again.

Conditions

- The >Set up >Areas menu is open.
- The system is ready for operation in automatic mode.
- BendMaster is ready for operation (the GREEN button was pressed, and the "BendMaster" icon is green).

Selecting the storage station

1. Press *Display, Details*.
 2. Select a storage station from the drop-down menu.
 3. Set the checkmark at "Activate/deactivate automatic mode".
- All storage trips are performed automatically as programmed in TruTops Bend.

7. Working at the press brake without BendMaster

7.1 Working at the press brake without BendMaster

Conditions

- BendMaster and TruBend have been switched on.
 - Working at the press brake without BendMaster
 - All EMERGENCY STOPS are released.
 - 6-axis-sensor fingers fixated.
1. Use the "Robot in parking position" travel function to move the BendMaster into the parking position in manual or automatic mode (see ["Executing travel functions"](#), pg. 4-48).
 2. Switch from BendMaster operating mode to TruBend operating mode manually.

NOTICE

The covering of the floor lane is not designed for standing on or storing parts on it!

Damage to the floor lane.

- Do not step on the covering.
- Do not deposit any workpieces on the covering.

3. Close all safety doors if the operator is inside the bending cell.
4. Activate the catch with the green button on post 1.
5. Operate the TruBend manually (refer to the "TruBend operator's manual").
6. Deactivate the catch with the red button on post 1 if necessary:
 - Press the red button on the control panel.

or

 - Press the EMERGENCY STOP impact button.

Exceptions: The two EMERGENCY STOP impact buttons on the TruBend control and control panel and the fully pressed foot switch at the control panel. (In this case the system stops, but the catch remains active.)

8. Errors and Messages

All errors and messages are stored in the control of the BendMaster. They can be called up in the *>Diagnostics* menu.

8.1 Displaying and acknowledging errors and messages

Show Both the red LED on the portable manual control unit and the red signal lamp on the safety fencing will go on if there is an error at the BendMaster.

1. Press *>Diagnostics >Existing messages*.

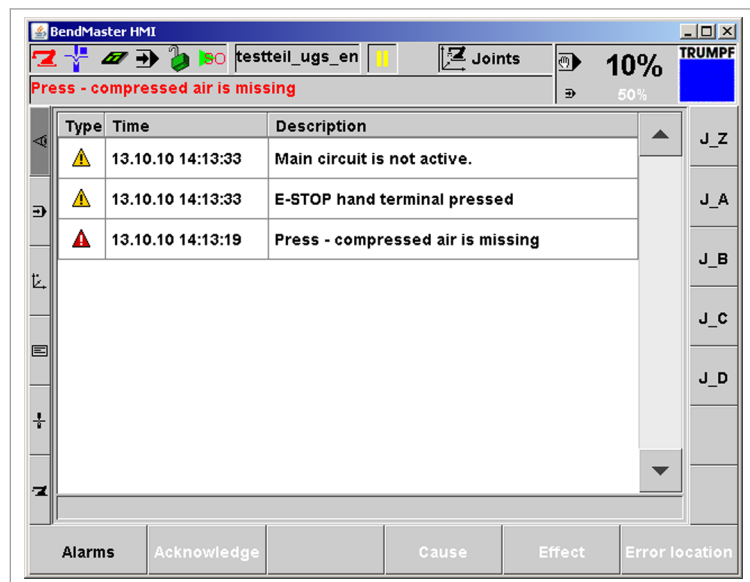


Fig. 39953

2. Press *Alarms, Errors/messages* to display each message type individually.
 3. Press *Alarms, All* to display all messages.
- Acknowledge**
4. Mark the message to be acknowledged.
 5. Press *Acknowledge*.

8.2 Troubleshoot an error

1. Mark the error message to be acknowledged by pressing it (it is displayed in the footer).
2. Press *Cause* to display the possible error cause.

-
3. Press *Effect* to display the possible effects of the error.
 4. Eliminate the cause of the error or the message.
 5. Acknowledging faults.

9. Error handling

9.1 Jumpering the sensor finger

The sensor finger can be jumpered if the error message "Maximum correction distance in X direction or Z direction achieved" appears.

1. Confirm the operation message "Align sheet manually or teach position" with *OK*.
2. Press *>Diagnostics >Existing messages*.
3. Press *>Press >Sensors for press*:

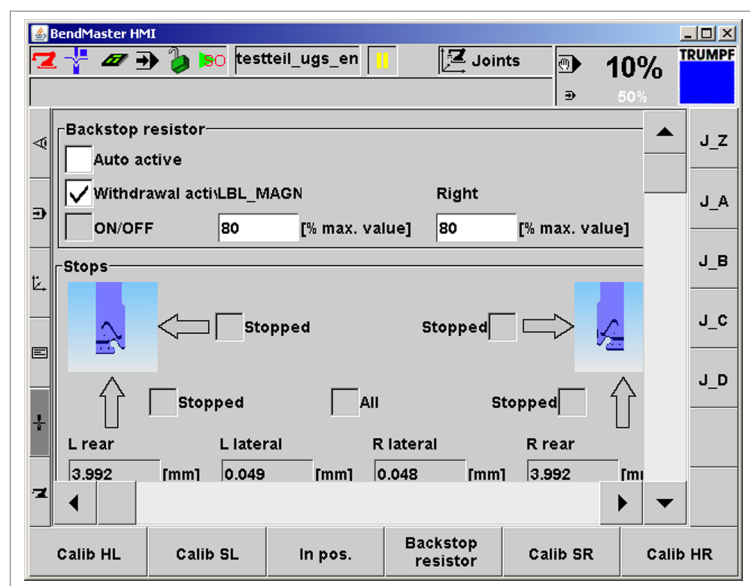


Fig. 43889

4. Press *In Pos.*. The sensor gauge fingers are bypassed. The error message is acknowledged automatically.
5. Press the green *START* button on the portable manual control unit. The execution of the program is resumed.

9.2 Image processing diagnostics

Basics Two CCD cameras (**C**harge **C**oupled **D**evice) are used for rough and fine recognition. This type of camera has a surface with elements that convert light energy into electrical energy.

The electrical energy is sent as an analog signal to the input of the image processing card via a cable. An analog-digital converter converts the signal into a machine-readable form. Thus the image of the part lying under the camera is created in the memory.

The gray value of an image point (image point = pixel) can assume values between 0 and 255:

- 0: black
- 255: white

Surfaces that are very bright under the camera have high gray values and surfaces that are dark have lower gray values:

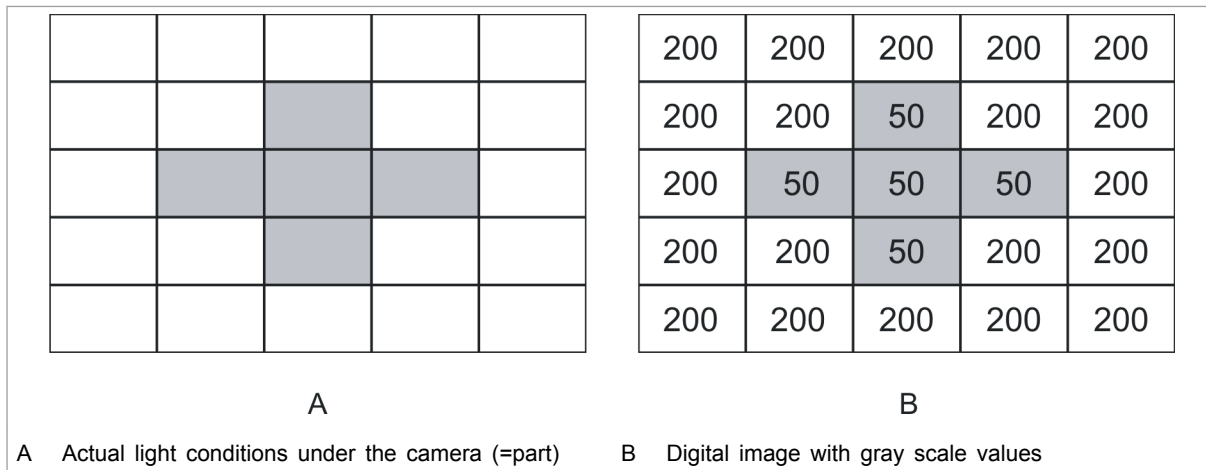


Fig. 51547

The cameras can be used within an light wavelength range of 400 - 1000 nm (visible range: 380 nm/blue – -760 nm/red).

Rough position

The aim of the approximate position is to define the position of the individual part stacks. This is done with the coarse position recognition process and the camera pictures used for this purpose.

The image section of the camera for the approximate position is about 0.9 m x 0.6 m. In order for the area defined by the operator to be covered nevertheless, this area is divided into n overlapping segments. Individual pictures are taken from all segments and subsequently joined to form an image of the approximate position in the PC.

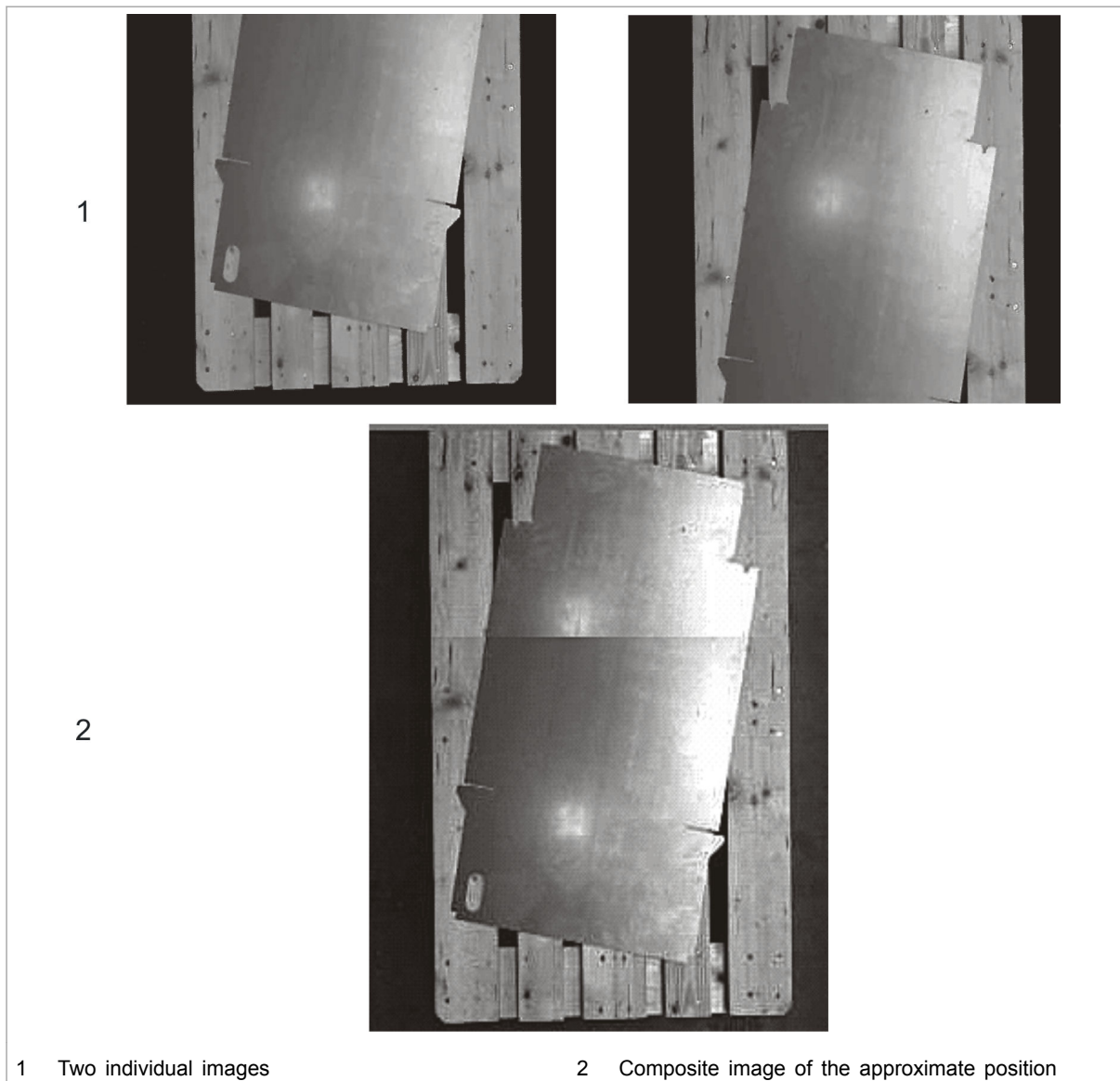


Fig. 52326

Fine position Four pictures are always taken to record the precise position. A new image is created by placing the four individual images on top of each other.

The images are always recorded at a distance of 333 mm (distance between the sheet surface and upper edge of covering hood) to ensure the precise position recognition takes effect.

Four flashes, which are activated separately, are used to record the fine position image. They are arranged at an angle of 90° to each other and, in this way, allow the parts to be illuminated from all sides in order to create the shadows required at the edges of the parts.

The individual images are placed on top of each other (precise to the pixel) in order to retain the dark shadows and reduce the light reflexes or eliminate them entirely:

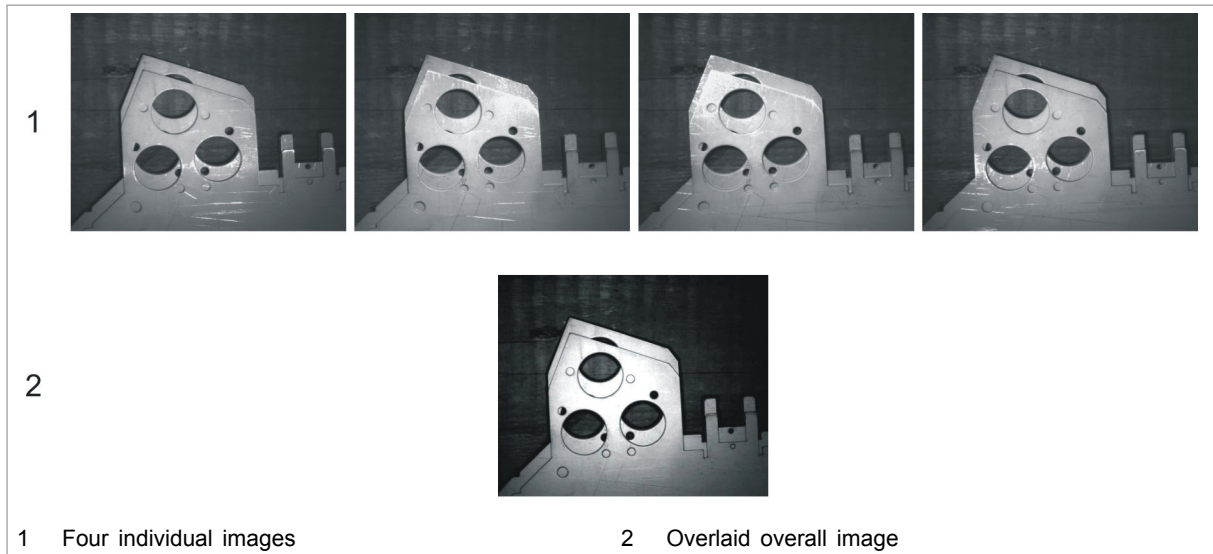
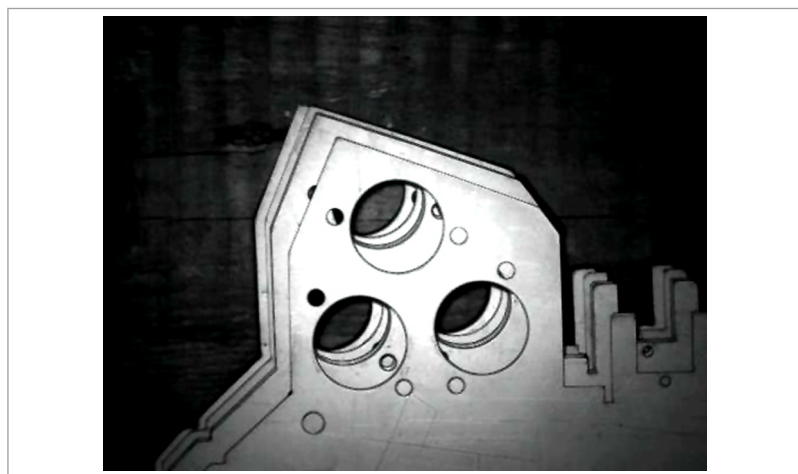


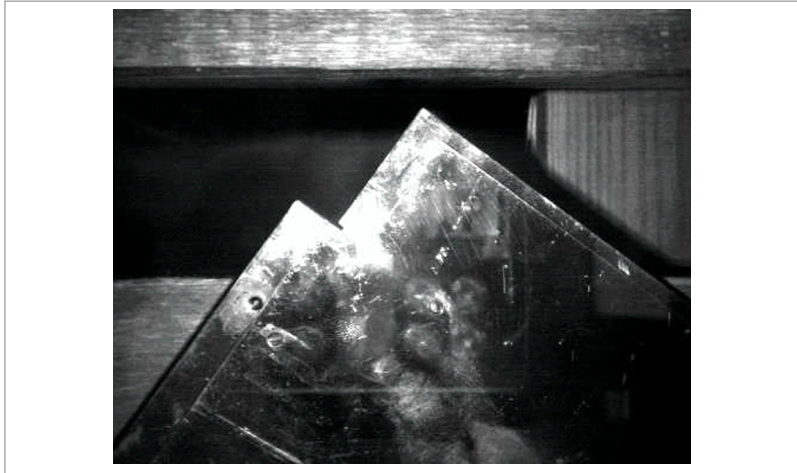
Fig. 52327

It is essential here that the created image is of good quality, as the following layer recognition process relies on this. A good image quality is indicated by the fact that the edges of the parts are clearly identifiable in the recorded image:



Precise position recording of good quality

Fig. 52328



Precise position recording of insufficient quality

Fig. 52329

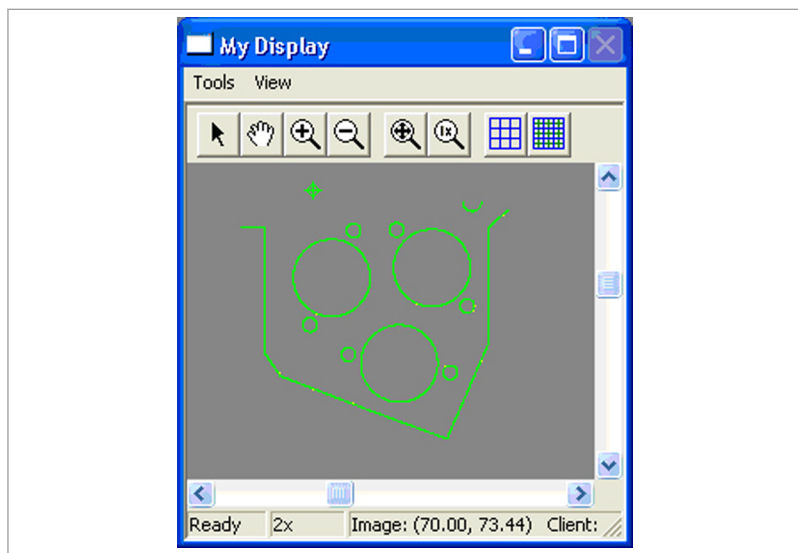
CAD data import

CAD data is used to generate the position recognition models. These CAD data contains both a reference point and the contour information to be searched for in the recorded image.

The reference point defines two things:

- The position resulting from the position recognition process.
- The current position of metal.

Since the model is used for position recognition in the recorded images, the contour of the CAD data must match the contour of the parts to be identified as precisely as possible.



Fine position model from CAD data

Fig. 51858

Position recognition

There is a position recognition program that can be used both for the rough and fine position processes. This program cannot only define the X/Y position, but also the rotation and change in size.

Depending on the recorded image, the program provides a number of valid results (0-99) which are sorted according to their quality. The better the contours found in the recorded image correspond to the fine position model from the CAD data, the higher the quality.

Tip

The quality of the results can be seen in the image of the fine position model:

- Green lines indicate that the program has found the contour of the fine position model at this point in the recorded image.
- Red lines indicate that the contour has not been found.
- Yellow lines indicate that the contour has been partially found.

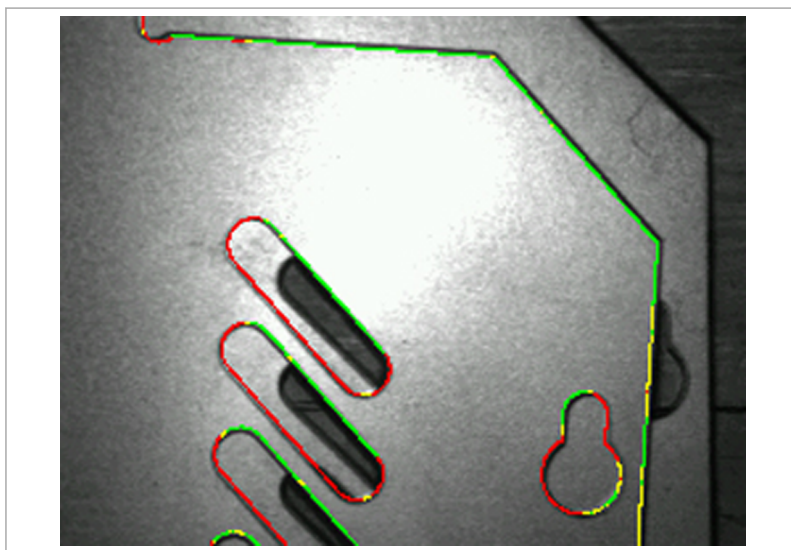
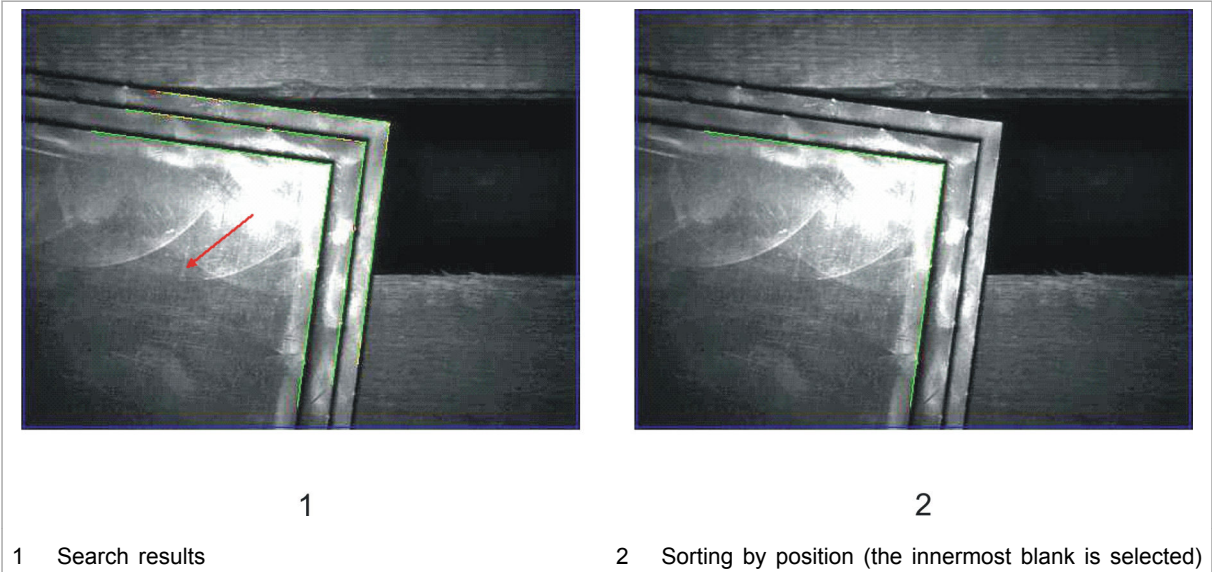


Fig. 52330

The result of best quality can always be referred to in the approximate position recognition process.

This does not necessarily have to be the case with fine recognition. If the fine recognition window is an outer contour, the highest part may not necessarily be the best result. That is why in this case the search results are still sorted according to their position.



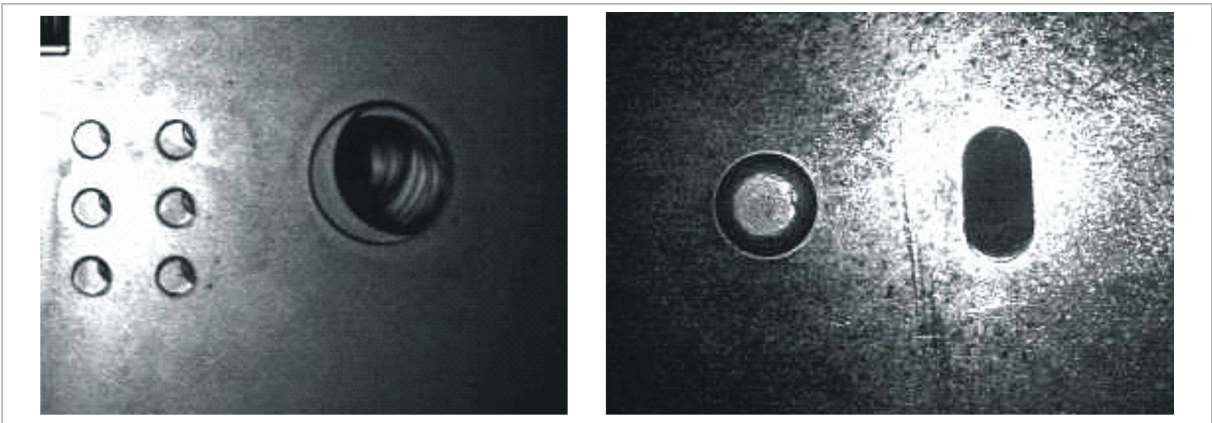
Fine position recognition with open outer contour

Fig. 52331

Note

Flaws on the surface, such as scratches or printed films, have a greater influence when sorting by position than when sorting by quality.

If the fine recognition window only contains closed inner contours, the best result can always be applied. If parts on the stack are then displaced, the parts further down are concealed.



Examples for sorting by quality with sheet stacks with inner contours

Fig. 52333


Opening the diagnostics tool

Vision Diagnostics can be used for both the rough and fine position recognition. The program runs on the visual PC and establishes an Ethernet connection to the control computer. The results

of the rough and fine position recognition processes are displayed and can be edited.

1. Change to the TOS user interface with <Alt>+<Tab>.
2. Press *TRUMPF Logo* at the TOS user interface.
3. Press *MMI*.
4. Press *BV diagnostics*. The "Vision Diagnostics" tool is started.

or

- If the diagnostics tool is already open, press <Alt>+<Tab> to switch to "Vision Diagnostics".
5. Press . The recording is made.

Recording with Vision Diagnostics

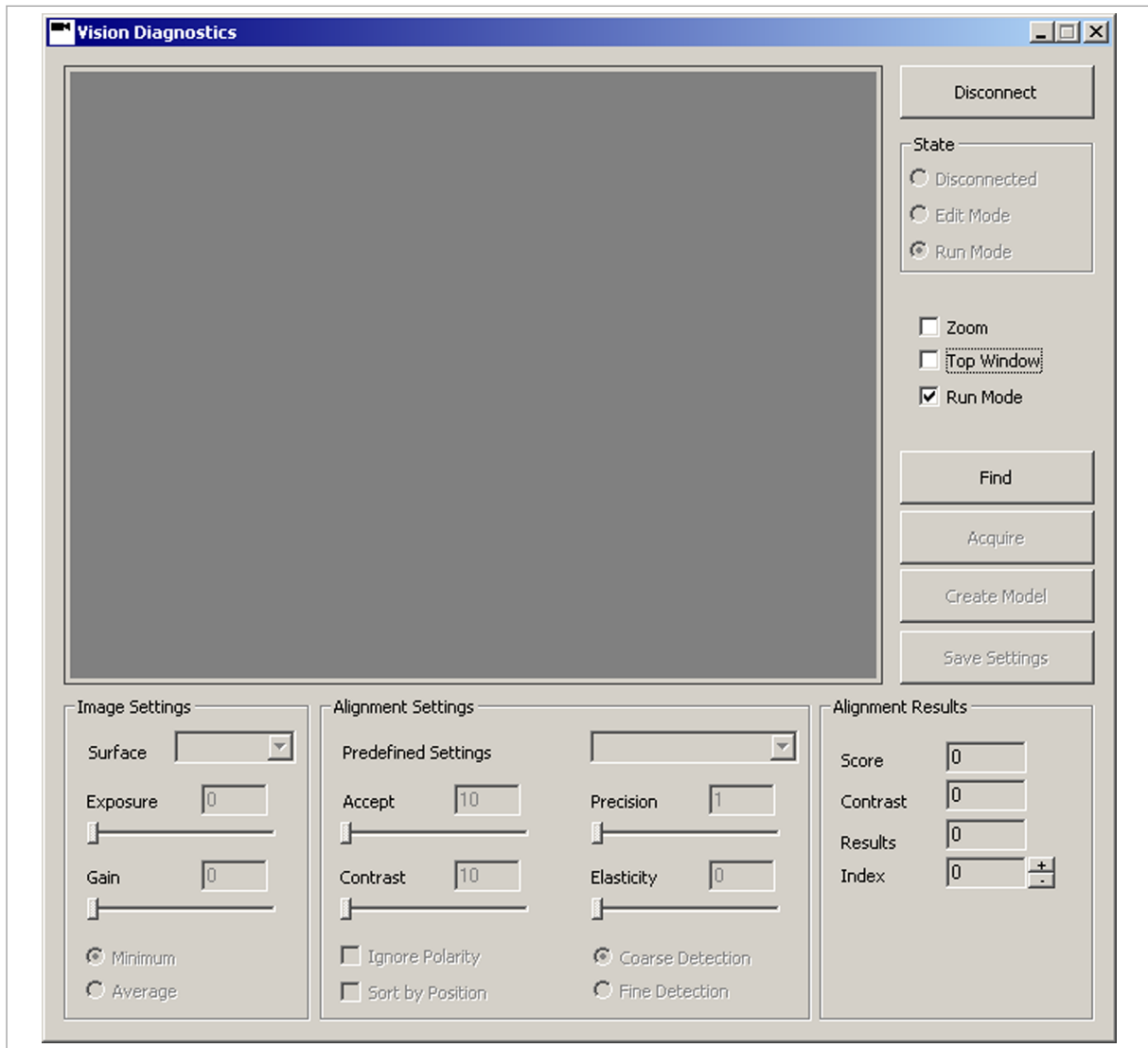


Fig. 54846

Name	Description
<i>Disconnect</i>	Terminates the connection to the image processing application or re-establishes the connection if it was previously interrupted.
"Status"	The Vision Diagnostics status is displayed: <ul style="list-style-type: none"> ▪ "Disconnected": no connection to the image processing software. The search results are not displayed in the diagnostic program. ▪ "Edit mode": "Run mode" is not active. Parameters can be changed. ▪ "Run mode": "Run mode" is active. The saved parameters are applied for the position recognition process.
"Zoom"	If selected, the <i>Zoom</i> function can be used to zoom into the recorded image.
"Foreground"	If checked, Vision Diagnostics always remains in the foreground.

Name	Description
"Run mode"	<p>Various parameters, which can influence the position recognition results, are saved for each position recognition model (e.g. "Contrast" or "Acceptance").</p> <ul style="list-style-type: none"> ▪ These parameters cannot be changed if "Run mode" is active. ▪ If "Run mode" is deactivated, position recognition is not possible. However, the parameters can be modified (e.g. "Acceptance" or "Contrast").
Search	<p>Starts a manual search with the set parameters on the current image recording.</p> <p>The results are graphically displayed and the quality and contrast are shown in the "Position recognition results" field.</p>
Image recording	<p>Starts manual image recording with the parameters entered in "Image recording settings".</p>
Create model	<p>The search contour programmed in TruTops Bend is displayed in the original state and in yellow. It can be modified if required:</p> <ul style="list-style-type: none"> ▪ Press Yes to use the contour (is then displayed in green). ▪ Press No if you do not want to use the contour (is then displayed in red). ▪ Press Cancel to cancel contour processing. <p>Tip The omission of CAD data may be a practical option if, for example, bore holes in the model are of a different size than in the actual part.</p> <p>Note No closed contour may be interrupted by omitting elements.</p>
Save settings	<p>Saves the user-defined settings for the currently loaded position recognition model.</p> <p>The saved settings are available again if this model is reloaded for the next position recognition process.</p> <p>If the "Use Pattern Settings" is selected, the saved settings are used.</p>
"Position recognition results"	<p>The search results are displayed.</p>
"Quality"	<p>Displays the quality of the results of the last position recognition process.</p> <p>Note To ensure sufficient process reliability, this result should be on average approx. 10% above the nominal value set in <i>Acceptance</i>.</p>
"Contrast"	<p>Specifies the contrast in percent at which the position recognition process is only just accepted in order to obtain valid results. 100% contrast: maximum contrast. Black pixels on white pixels.</p> <ul style="list-style-type: none"> ▪ Typical fine position values: 20 - 50. ▪ Typical approximate position values: 10 - 30.
"Results"	<ul style="list-style-type: none"> ▪ Shows the number of results found
"Index"	<p>If a position recognition process provides several results, all results can be displayed one after another with "Index". The result with index 0 is used.</p> <p>+ shows the next result.</p> <p>- shows the previous result.</p> <p>Note The fine recognition results are already sorted by the method set (quality or position).</p>
'c:\control\application\TeachTalk\...'	<p>Currently loaded search contour.</p>
"Position recognition settings"	<p>Parameters for position recognition can be set.</p>

Name	Description
"Predefined settings"	<p>The "Predefined settings" drop-down menu contains four preset parameter blocks which make it easier to edit parameters and contain the position recognition parameters for the corresponding contours.</p> <ul style="list-style-type: none"> ▪ <i>Simple contour</i>: Parameters for a simple contour. ▪ <i>Average contour</i>: Parameters for more complex contours. ▪ <i>Complex contour</i>: Parameters for highly complex contours. ▪ <i>Inner contour</i>: Parameters for closed inner contours.
"Acceptance"	<p>Specifies the quality in percent at which position recognition is only just accepted in order to obtain valid results. 100% quality: the entire model contour was found in the camera image.</p> <ul style="list-style-type: none"> ▪ Typical fine position values: 65 - 90. ▪ Typical approximate position values: 30 - 50.
"Accuracy"	<p>Specifies to what degree the image data are compressed during the position recognition process. Higher values speed up the position recognition process, lower values slow it down.</p> <p>If, for example, low sheet thicknesses with narrow edges are to be identified, a smaller value must be selected.</p> <ul style="list-style-type: none"> ▪ Typical fine position values: 2 - 4. ▪ Typical approximate position values: 3 - 4.
"Contrast"	<p>Displays the contrast in the last position recognition result.</p>
"Elasticity"	<p>Specifies by how many the pixels the actual contour may vary at the most from the required contour of the model to obtain a valid result.</p> <p>Deviations which affect the quality can be caused by influences, such as machining tolerances, burrs on edges, working distances etc.</p> <ul style="list-style-type: none"> ▪ Typical fine position values: 0 - 3. ▪ Typical approximate position values: 3 - 4.
"Ignore Polarity"	<p>During position recognition, it is always assumed that the part in the camera image is bright and the background is dark (shadows). If that is not the case "Ignore Polarity" must be selected.</p> <p>Tip If the polarity of the edges is partially not constant, e. g. in the event of complex contours or problematic surfaces, "Ignore Polarity" must be activated. This is not necessary in the case of very simple contours (e.g. angles between two lines).</p>
"Sort by position"	<p>If activated, the results are sorted according to their position, not their size, during the fine position recognition process.</p>
"Rough recognition"	<p>Display whether the loaded search contour has rough recognition.</p>
"Fine recognition"	<p>Display whether the loaded search contour has a fine recognition.</p>
"Image recording settings"	<p>Parameters for image recording can be set.</p>
"Surface"	<p>The "Surface" drop-down menu contains four preset parameter blocks that can be used for image recording in case of blanks with different surface properties.</p> <p>Note A change in the parameter block has an effect only if a new image recording has been made.</p> <ul style="list-style-type: none"> ▪ <i>Opaque</i>: Parameters for an opaque surface. ▪ <i>Average</i>: Parameters for a slightly glossy surface. ▪ <i>Reflecting</i>: Parameters for reflecting surfaces. ▪ <i>Mirroring</i>: Parameters for mirroring surfaces.
"Exposure time"	<p>Manual setting of the exposure time for snapshots.</p> <ul style="list-style-type: none"> ▪ 0: Low exposure time. ▪ 30: Maximum exposure time.

Name	Description
"Amplification"	Setting for the amplification of the contrast in the entire image. <ul style="list-style-type: none"> ▪ 0: No amplification. ▪ 5: Maximum amplification.
"Minimum"	The entire image is generated from the minimum value of the pixels of the four snapshots.
"Average"	The entire image is generated from the average of the pixels of the four snapshots.

Tab. 4-29

Summary of the position recognition parameters according to the type of contour:

- ↑: Increase value..
- ↓: Reduce value.
- -: Do not change value.
- 0: Do not activate.
- X: Activate.
- 0/X: Both options.

	Simple contour	Average contour	Complex contour	Inner contour
Acceptance	-	-	-	-
Elasticity	-	-	-	-
Polarity, ignoring	0	0/X	0/X	X
Sorting according to position	X	X	X	0

Tab. 4-30

In principle the following applies:

	Position recognition more tolerant	Position recognition less tolerant
Acceptance	-	-
Elasticity	-	-
Polarity, ignoring	X	0

Tab. 4-31

Saving the image recorded last

If an image could not be recorded successfully, the image recorded last for the selected job can be saved for the TRUMPF Service department or development department for teleservice.

Note

An image recording can only be saved when a job is loaded.

1. >*Diagnostics* menu, press "BV diagnostics".
2. Press *Save CDB* to save the image last recorded of the selected job.
3. Decide whether the fine or coarse exposure is to be saved.

Restarting the program

1. >*Diagnostics* menu, press *BV diagnostics*.
2. Press *BV restart*. The image processing software is restarted.

9.3 Teleservice

1. Change to the TOS user interface with <Alt>+<Tab>.
2. Press *MMI*.
3. Press *Teleservice*. The following window opens after a short while:

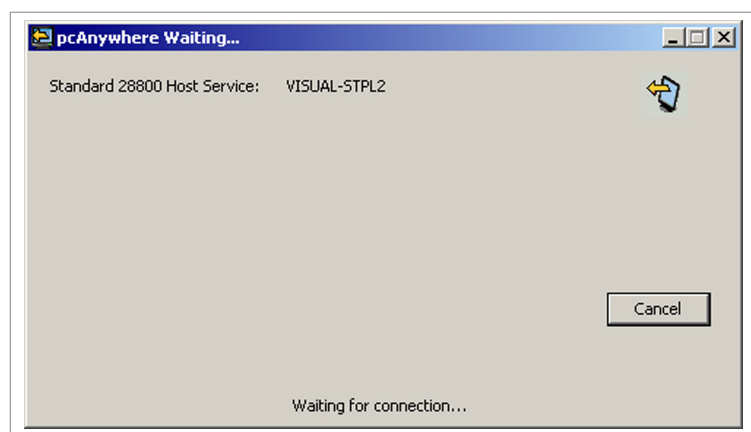


Fig. 40876

A TRUMPF service engineer can now dial into the BendMaster via teleservice.

10. Solving problems and troubleshooting

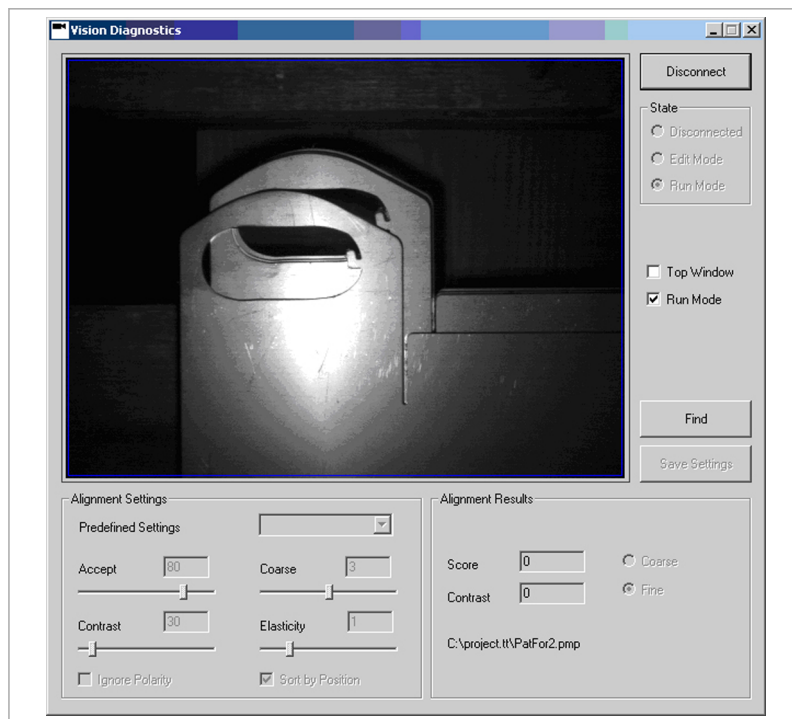
Problems which occur frequently during the fine position recognition process are described and possible solutions illustrated by means of examples in the following sections.

First check The following things must always be checked first if problems occur regarding the fine position recognition:

- Correct position of the BendMaster when recording the image.
- The entire selected search contour is on the recorded image.
- The distance between the sheet surface and the upper edge of the BendMaster's covering hood is exactly 333 mm when recording the image.
- Good quality of the recorded image; all edges of the part are easily identifiable.

10.1 Problem: no part recognized

Error description There are no results from the position recognition process:



No position recognition results

Fig. 52490

Reason The program could not find any results of sufficient quality, in other words, there are no results of quality higher than the threshold value of 80% set in "Accept".

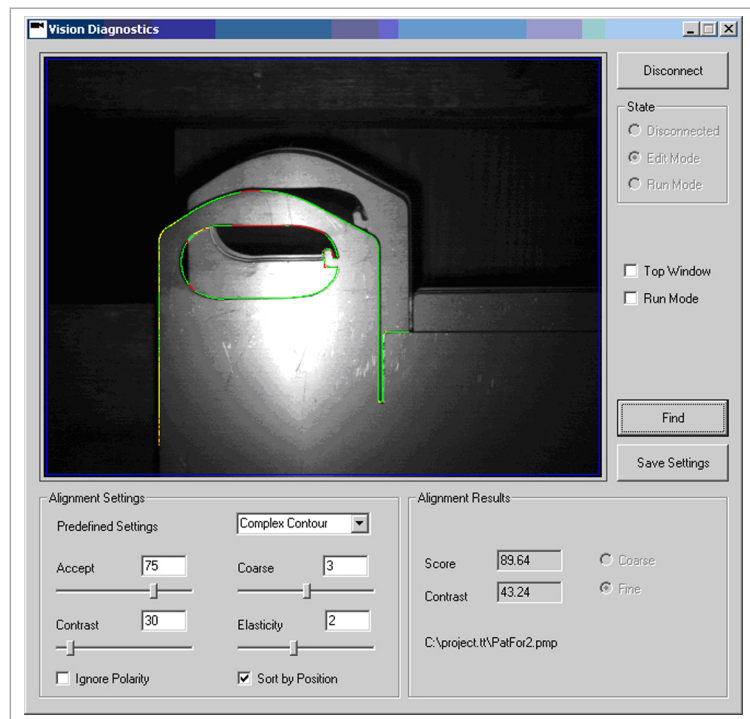
Solution: no part identified

Increase the position recognition tolerance (two options):

1. Set *Pre-defined settings* to *Complex contour*.

The "elasticity" is increased and the "acceptance" threshold is reduced.

The part position is recognized with a "quality" of 89 %:

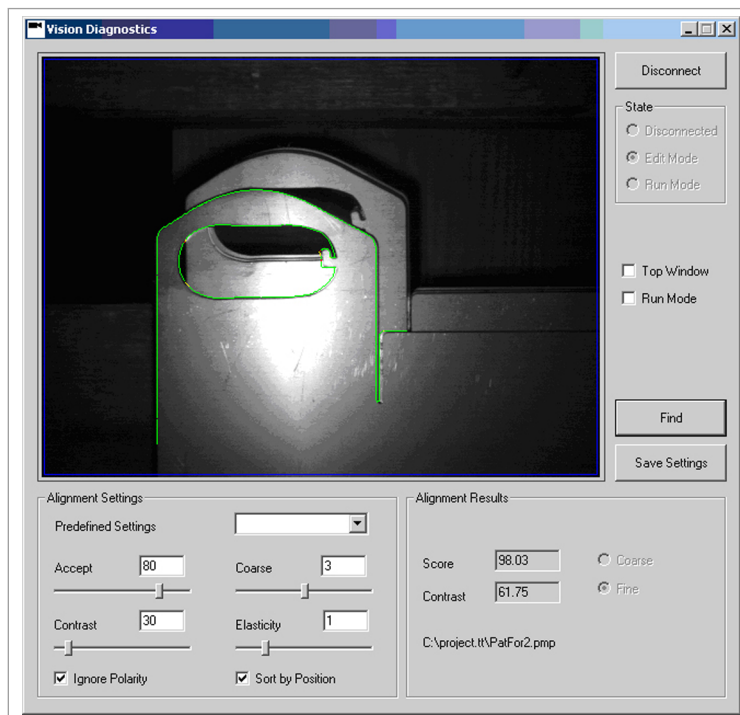


Position recognition by "complex contour"

Fig. 52491

2. Select "Ignore Polarity".

The part position is recognized with a "quality" of 98 %:

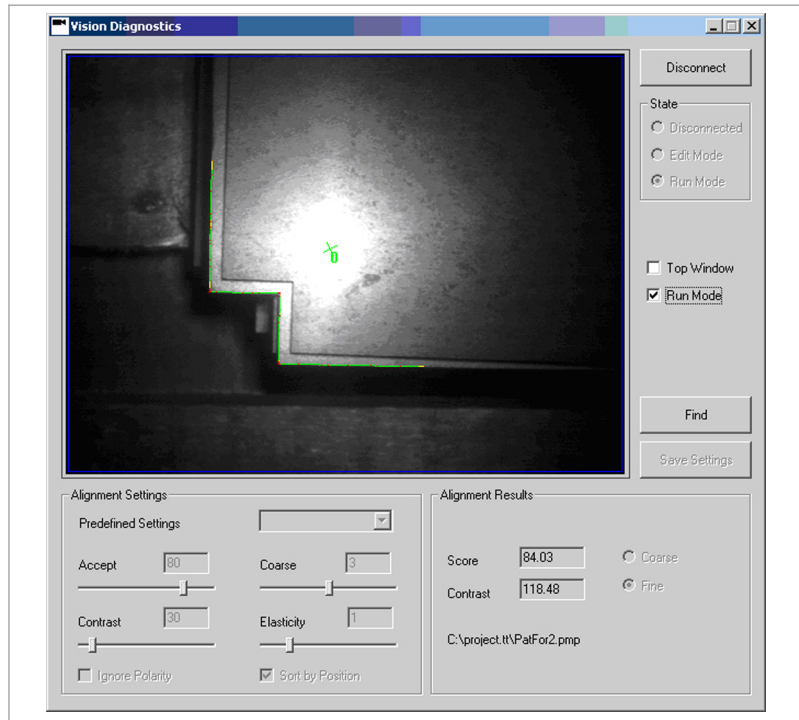


Position recognition by "Ignore Polarity"

Fig. 52492

10.2 Problem: Part underneath detected

Error description Not the highest part, but a part below it is identified:



The part below it was identified.

Fig. 52493

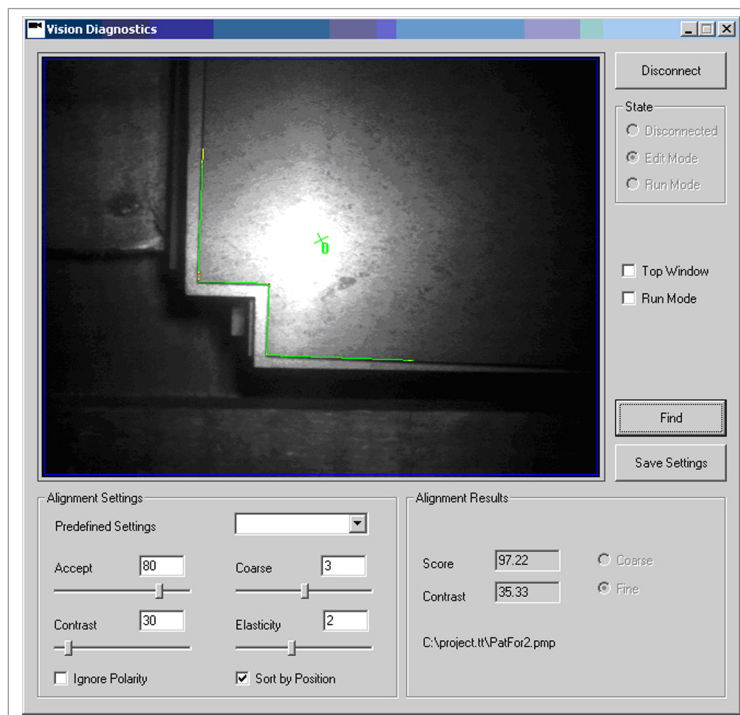
Reason The program could not find any results of sufficient quality for the highest part with an "acceptance" of >80 %. The part underneath it was found with sufficient quality.

Solution: part underneath detected

Increase the position recognition tolerance:

- Increase the "elasticity" to 2.0.

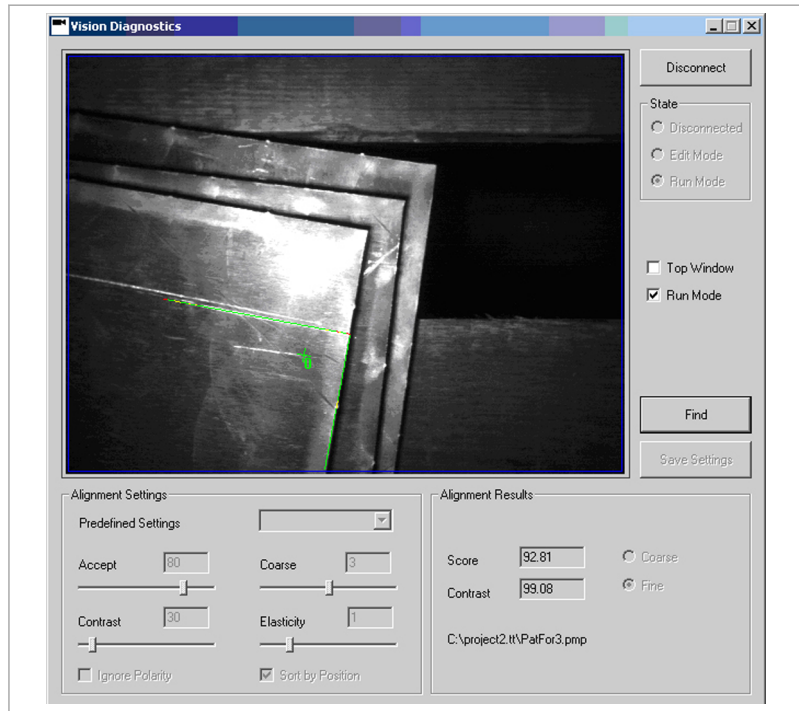
The part position is recognized with a "quality" of 97 %:



Position recognition by increasing the "Elasticity" to 2.0 Fig. 52494

10.3 Problem: part interference contour recognized

Error description An existing interference contour on the surface of the part, not the part itself, is recognized:



Interference contour (scratch) has been recognized

Fig. 52495

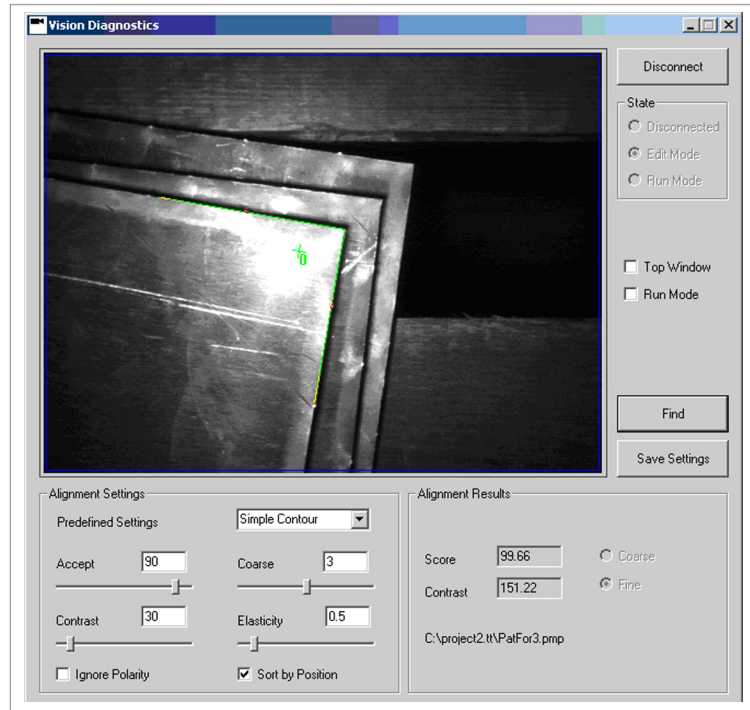
Reason The interference contour looks like the contour searched for and is identified with a quality of 92%. Since the results for outer contours have to be sorted by their position (see "Fig. 52331", pg. 4-119), the innermost result, in this case the scratch on the blank, is always selected.

Solution: interference contour recognized

Reduce the position recognition tolerance.

- Set "Predefined settings" to *Simple Contour* to reduce the "elasticity" and increase the "acceptance" threshold.

The position of the topmost part is recognized with a quality of 99%. The scratch is no longer recognized:



The highest part was identified

Fig. 52496

Chapter 5

Maintenance (customer)

1	General guidelines	5-3
2	Maintenance Overview	5-5
3	Lubrication	5-6
3.1	Overview	5-6
3.2	Maintenance Instructions	5-7
	BendMaster: Z slide	5-7
	Regripping station (option)	5-8
4	Mechanical elements	5-10
4.1	Maintenance Instructions	5-10
	Safety fencing	5-10
	Lift gate	5-10
	Transport equipment (option): transport belt	5-11
	BendMaster: Z axis	5-11
	Regripping station	5-12

	Sheet removal station	5-13
	Press brake: sensor gauge finger	5-13
	Gripper changing console (option)	5-14
	BendMaster: pivoted-jaw gripper (option)	5-15
5	Electrical components	5-16
5.1	Overview	5-16
5.2	Maintenance Instructions	5-17
	BendMaster: control cabinet	5-17
	BendMaster: switch cabinet	5-18
	BendMaster: fan in the C arm	5-20
	BendMaster: fan, Z slide	5-21
6	Optical components	5-22
6.1	Overview	5-22
6.2	Maintenance Instructions	5-22
	BendMaster: sheet sensor	5-22
7	Pneumatic components	5-24
7.1	Maintenance Instructions	5-24
	Press brake: compressed air supply	5-24

1. General guidelines

Correct maintenance is essential for maintaining the quality of the machine. It prevents operational malfunctions and their consequences.

DANGER

Risk of fatal injury during maintenance work with the machine switched on!

- Unless expressly stated otherwise: Shut down the machine properly, secure the MAIN SWITCH and secure with a padlock.
- Strictly observe the safety regulations.

Notes on cleaning

- Clean the entire machine at regular intervals.
- Brush off large elements of dirt and dust or remove them using an industrial vacuum cleaner.
- Clean polycarbonate panes only with an antistatic plastic cleaning agent (mat. no. 1672922).

Notes on lubrication

Refer to the lubrication chart and maintenance instructions for the lubrication of the machine. The following points should also be observed:

- Use only lint-free cleaning cloths and low-viscosity spindle oil ("scavenge oil") to clean lubricating points. Do not use cleaning wool, kerosene or benzene.
- Do not mix synthetic lubricating oils with mineral oils or synthetic oils from other manufacturers, even if the synthetic oil in question has equivalent properties.
- Dispose of waste oil appropriately.

NOTICE

Stiff safety fencing doors due to lubrication of the roller guides.

Lubricating grease attracts dirt.

- Do **not** lubricate the roller guides on the safety fencing doors.
- Readjust the safety fencing doors if the roller guides should be stiff.

Qualifications of maintenance personnel

All maintenance work may only be performed by persons who have been trained for the maintenance work described and who have acquired the relevant knowledge.

Certain types of maintenance work (e.g. in the switch cabinet) require, in addition to the above-mentioned qualifications, complete professional training or advanced training in electrical engineering. Furthermore these specialists require authorization to do electrical work on this system (Germany: electrician for defined

tasks in accordance with DGUV Vorschrift 3, previous number was: BGV A3).

Furthermore, the regulations of the relevant country are also applicable.

2. Maintenance Overview

Interval/ operating hours	Maintenance point	Maintenance work	Page
1000	BendMaster: Z slide	Lubricating the linear guides	5-7
1000	BendMaster: control cabinet	Cleaning or changing filter	5-17
1000	BendMaster: switch cabinet	Clean the Peltier cooler	5-18
1000	BendMaster: fan in the C arm	Cleaning the fan	5-20
Weekly	Sheet removal station	Checking and cleaning the sheet removal station	5-13
Weekly	BendMaster: pivoted-jaw gripper (option)	Performing a visual inspection	5-15
Weekly	BendMaster: pivoted-jaw gripper (option)	Check the opening and closing speed.	5-15
Every 6 months	Regripping station (option)	Lubricating the linear guides	5-8
Every 6 months	Regripping station (option)	Checking and lubricating the rack	5-9
Every 6 months	Safety fencing	Checking polycarbonate windows for damage	5-10
Every 6 months	Safety fencing	Cleaning the polycarbonate panes	5-10
Every 6 months	Lift gate	Checking the lift gate without store interface	5-10
Every 6 months	Lift gate	Checking the lift gate with store interface	5-10
Every 6 months	Transport equipment (option): transport belt	Checking the conveyor belt	5-11
Every 6 months	BendMaster: Z axis	Checking the toothed belt	5-11
Every 6 months	Press brake: sensor gauge finger	Performing a visual and functional test	5-13
Every 6 months	Gripper changing console (option)	Performing a visual inspection	5-14
Every 6 months	Gripper changing console (option)	Checking the limit switch	5-14
Annually	Press brake: compressed air supply	Checking the audible compressed air monitoring	5-24
As needed	Regripping station	Cleaning or replacing the muffler	5-12
As needed	BendMaster: fan, Z slide	Function test	5-21
As needed	BendMaster: sheet sensor	Clean the glass pane	5-22

3. Lubrication

3.1 Overview

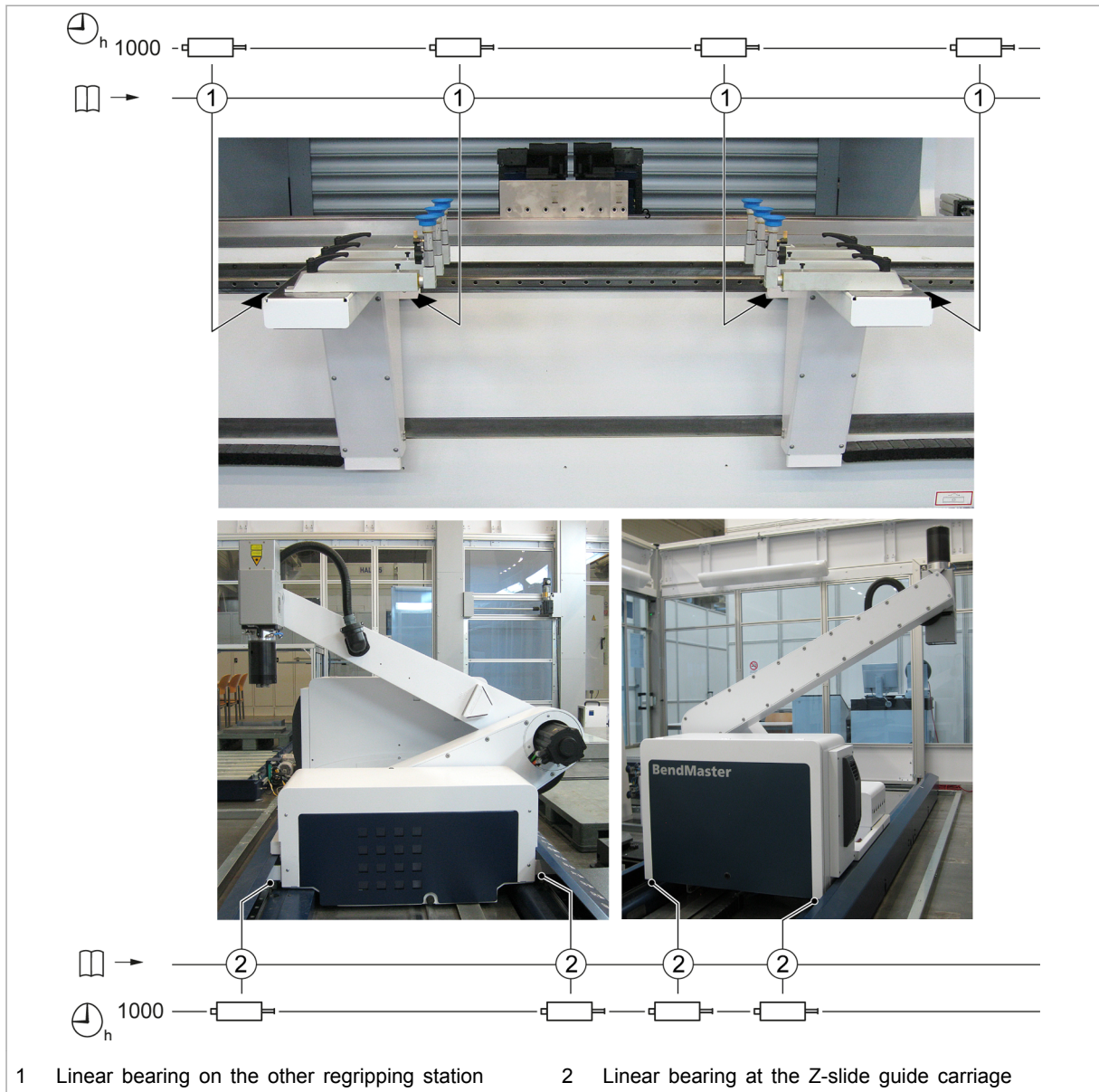


Fig. 71106

	Maintenance interval
	Read the maintenance instructions
	Lubricate with a grease gun

Tab. 5-1

Note

Approved lubrication agents of the same quality from other manufacturers can also be used. However, different types of oil may not be mixed.

Lubrication point	Quantity	Recommended lubricants	Identification	Viscosity, consistency
BendMaster: Z slide Regripping station: linear bearings at Z3 and Z4 Arm 1 counterweight Arm 2 counterweight	-	Castrol LMX (Material no. 0817798)	KP2N-30	NLGI 2
Regripping station: rack	-	INNOTEK Ceramic Grease Spray (Material no. 0816642)	KP2N-30	NLGI 2

Lubricants

Tab. 5-2

3.2 Maintenance Instructions

BendMaster: Z slide

(see "Overview", pg. 5-6)

106420:
Lubricating the linear guides

Maintenance interval: 1000 operating hours

1. Move the BendMaster into home position.

NOTICE

Collision with sheet stacks.

- When moving the BendMaster in Z direction, pay attention to the existing sheet stack.

2. Manually move the BendMaster in such a way that the grease nipples of the Z-slide linear guides can be accessed through the openings in the cover of the floor lane.

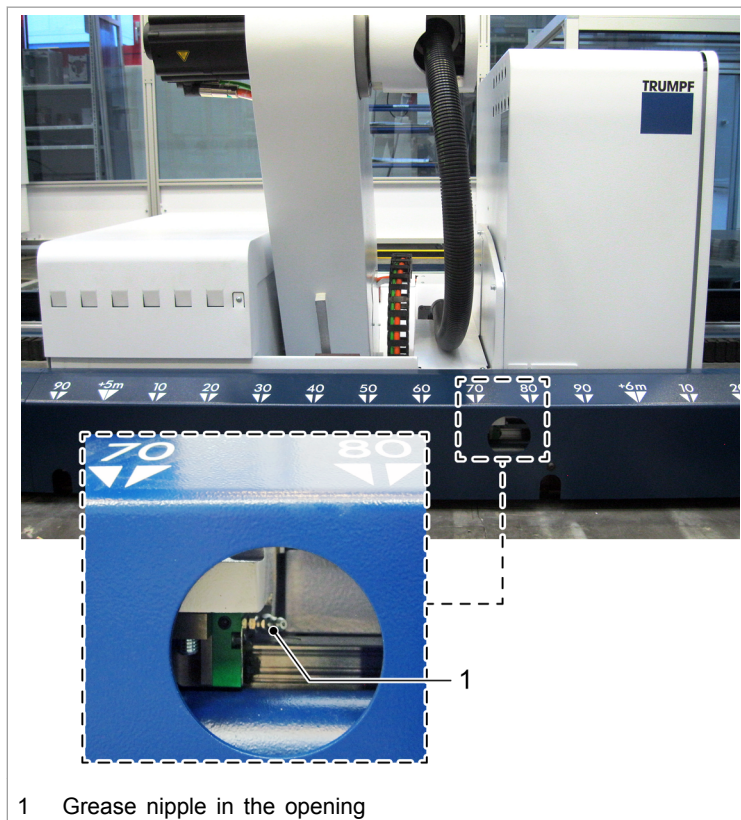


Fig. 71108

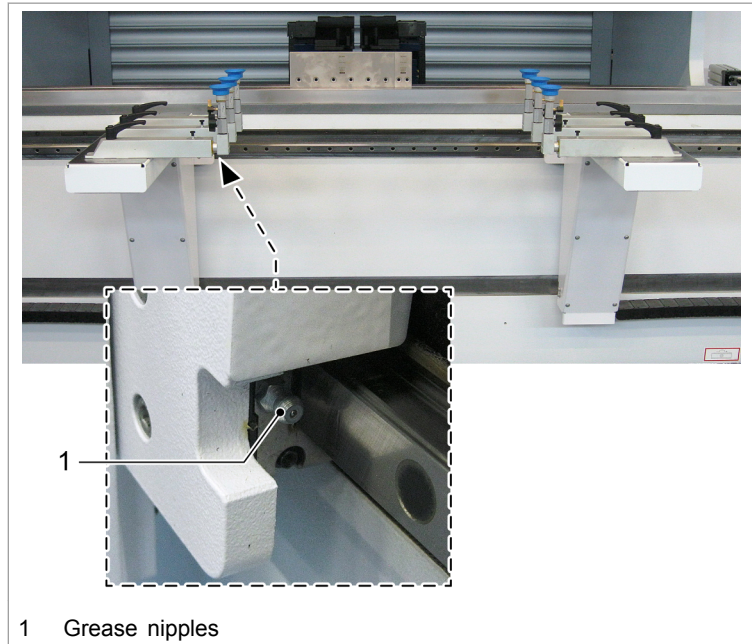
3. Shut down the machine properly, secure the MAIN SWITCH and secure with a padlock.
4. Lubricate the grease nipples of all four linear guides with the grease gun.

Regripping station (option)

(see "Overview", pg. 5-6)

106421: Maintenance interval: Every 6 months
Lubricating the linear guides

1. Release gripper.
2. Move the BendMaster into home position.
3. Shut down the machine properly, secure the MAIN SWITCH and secure with a padlock.
4. Lubricate the grease nipples of all four linear bearings with the grease gun.



1 Grease nipples
Grease nipple at the regripping station

Fig. 71107

106612:
Checking and lubricating the rack

Maintenance interval: Every 6 months

1. Shut down the machine properly, secure the MAIN SWITCH and secure with a padlock.
2. Check the rack for damage.
3. In case necessary, lubricate the rack.

4. Mechanical elements

4.1 Maintenance Instructions

Safety fencing

106274:
Checking polycarbonate
windows for damage

Maintenance interval: Every 6 months

- Check polycarbonate windows for damage. In case necessary: request Technical Service.

106613:
Cleaning the polycarbonate
panes

Maintenance interval: Every 6 months

Means, Tools, Materials

- Anti static plastic cleaner (mat. no. 1672922).
- Clean the polycarbonate panes with anti-static plastic cleaner.

Lift gate

106614:
Checking the lift gate
without store interface

Maintenance interval: Every 6 months

No maintenance work is required on any of the guide elements (guide carriage and guide rail; toothed wheel and rack)

1. Check the lift gate for damage.
2. Manually open the lift gate in manual mode.
3. Check the control unit of the lift gate of the upper end position. Correct display: $\bar{\cdot} \cdot Eo \bar{\cdot}$.
4. Manually close the lift gate in manual mode.
5. Check the safety bar for proper function. The lift gate has to open itself again.
6. Manually close the lift gate in manual mode.
7. Check the control unit of the lift gate of the lower end position. Correct display: $_ \cdot Eu _$.
8. Carry out steps 1 to 7 on all lift gates.

106618:
Checking the lift gate with
store interface

Maintenance interval: Every 6 months

No maintenance work is required on any of the guide elements (guide carriage and guide rail; toothed wheel and rack)

1. Check the lift gate for damage.
2. Manually open the lift gate in manual mode.
3. Check the control unit of the lift gate of the upper end position. Correct display: `-.Eo-`.
4. Manually close the lift gate in manual mode.
5. Check the safety bar for proper function. The lift gate has to open itself again.
6. Manually close the lift gate in manual mode.
7. Check the control unit of the lift gate of the lower end position. Correct display: `_.Eu_`.
8. Place the system on automatic mode and lock the protection doors.
The control unit must remain without any power; the system is deactivated.
9. Carry out steps 1 to 8 on all lift gates.

Transport equipment (option): transport belt

106619: Maintenance interval: Every 6 months
Checking the conveyor belt

Condition

- Manual operating mode is active.
1. Manually move the transport belt, checking the belt for damage while doing this.
 2. Carry out checks on all transport belts.

BendMaster: Z axis

106621: Maintenance interval: Every 6 months
Checking the toothed belt

1. Shut down the machine properly, secure the MAIN SWITCH and secure with a padlock.
2. Check the toothed belt for damage and wear.

NOTICE

Position change of the Z axis by altered pitch.

Existing programs are no longer correctly processed.

- Do not re-tension the toothed belt.

- In case necessary: request Technical Service.

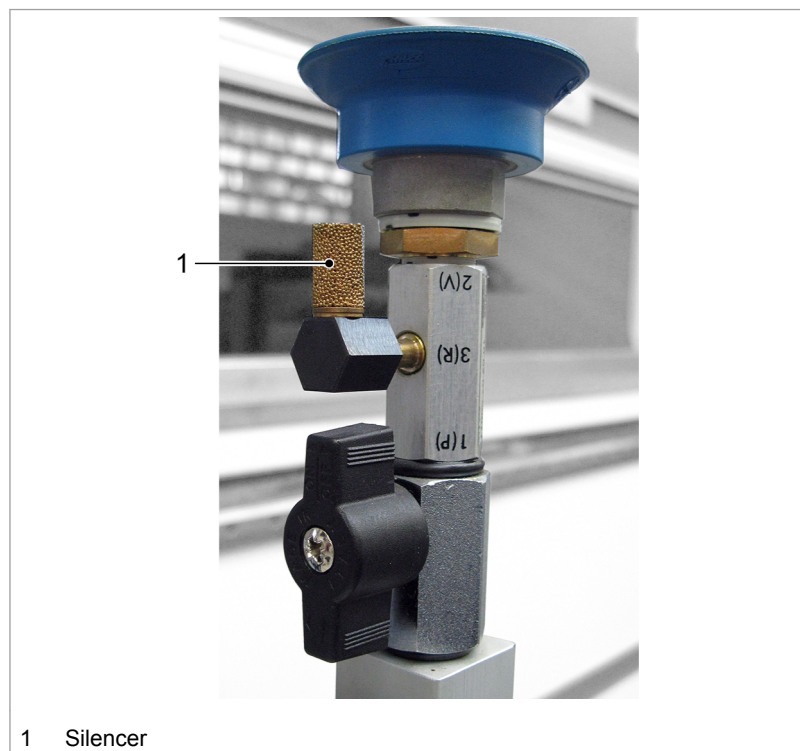
Regripping station

106622: Maintenance interval: As needed
Cleaning or replacing the muffler

Means, Tools, Materials

- If necessary: muffler (material no. 0137657)

The muffler must be cleaned when the suction power of the vacuum ejector is reduced. If the suction power is still not correct after cleaning, the muffler must be replaced.



Regripping station suction cup

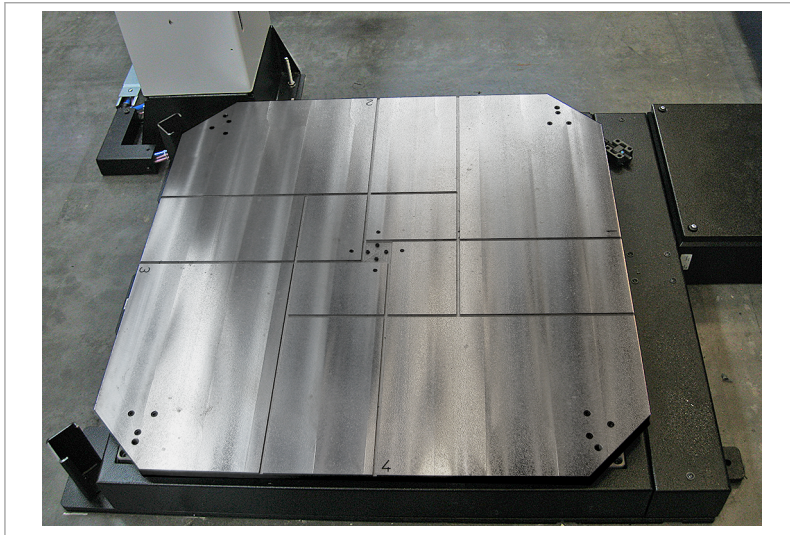
Fig. 71049

- Shut down the machine properly, secure the MAIN SWITCH and secure with a padlock.
 - Screw out the muffler.
 - Blow out the muffler with compressed air.
- or**
- Replace the muffler if it is severely soiled.
- Switch on the system again in manual mode.
 - Check vacuum function at the regripping station.

Sheet removal station

106623: Checking and cleaning the sheet removal station

Maintenance interval: Weekly



Sheet removal station pallet

Fig. 71050

1. Shut down the machine properly, secure the MAIN SWITCH and secure with a padlock.
2. Check the sheet removal station for damage.
3. Clean and conserve the pallet.

Press brake: sensor gauge finger

106624: Performing a visual and functional test

Maintenance interval: Every 6 months

Condition

- Manual operating mode is active.
1. Check the sensor gauge finger for damage.
 2. At the HMI user interface, open *>Press >Press sensor system*.
The "ON/OFF" checkbox must be activated.
 3. Enter 20% in both fields "Backstop resistor", "Left" and "Right".
 4. Check the sensor gauge finger for ease of movement.
 5. Enter 80% in both fields "Backstop resistor", "Left" and "Right".
 6. Check the sensor gauge finger for ease of movement compared to the previous setting.

- In case necessary: request Technical Service.

Gripper changing console (option)

106625:
Performing a visual inspection

Maintenance interval: Every 6 months

- Check all gripper changing consoles for damage.

106626:
Checking the limit switch





Maintenance interval: Every 6 months

Condition

- Manual operating mode is active.

- Open the *>Robot >Gripper deposit station* menu.

The following statuses are possible:

Symbol	Description
	Deposit station not taught.
	Deposit station occupied; gripper unknown.
	Deposit station occupied; gripper known.
	Deposit station free.

Status of gripper changing console deposit station

Tab. 5-3

- Manually remove all grippers from all gripper changing consoles.

All symbols must change to the "Deposit station free" status.

- Manually place the gripper in the deposit station 1 of gripper changing console 1.

The symbol from deposit station 1 must change to "deposit station occupied, gripper unknown".

- Carry out the procedure on all available deposit stations.
- Perform one automatic gripper pick-up and one automatic gripper deposit on each of the deposit stations.
- If the grippers are not properly held or deposited, the "deposit station not taught" symbol is displayed:

Request Technical Service.

BendMaster: pivoted-jaw gripper (option)

106627:
Performing a visual
inspection



Maintenance interval: Weekly

Unexpected movements of linear or pivoted-jaw gripper (option)

Risk of crushing.

- Before starting set up or maintenance work, close the shut-off valve on the pivoted-jaw gripper.
- Take special care when you open the shut-off valve, because the suction cup slat will start to move immediately.

-
- Check the pivoted-jaw gripper for damage.

106629:
Check the opening and
closing speed.



Maintenance interval: Weekly

Unexpected movements of linear or pivoted-jaw gripper (option)

Risk of crushing.

- Before starting set up or maintenance work, close the shut-off valve on the pivoted-jaw gripper.
- Take special care when you open the shut-off valve, because the suction cup slat will start to move immediately.

Operating mode	Manual control mode	Automatic
Gripper open	slow	fast
Gripper closed	fast	fast

Traveling speed, gripper

Tab. 5-4

1. Check all four speeds in the two operating modes.
The closing speed must be at least 4 mm/s in manual mode.
2. If this closing speed is not met, Request Technical Service..

5. Electrical components

5.1 Overview



Fig. 51884

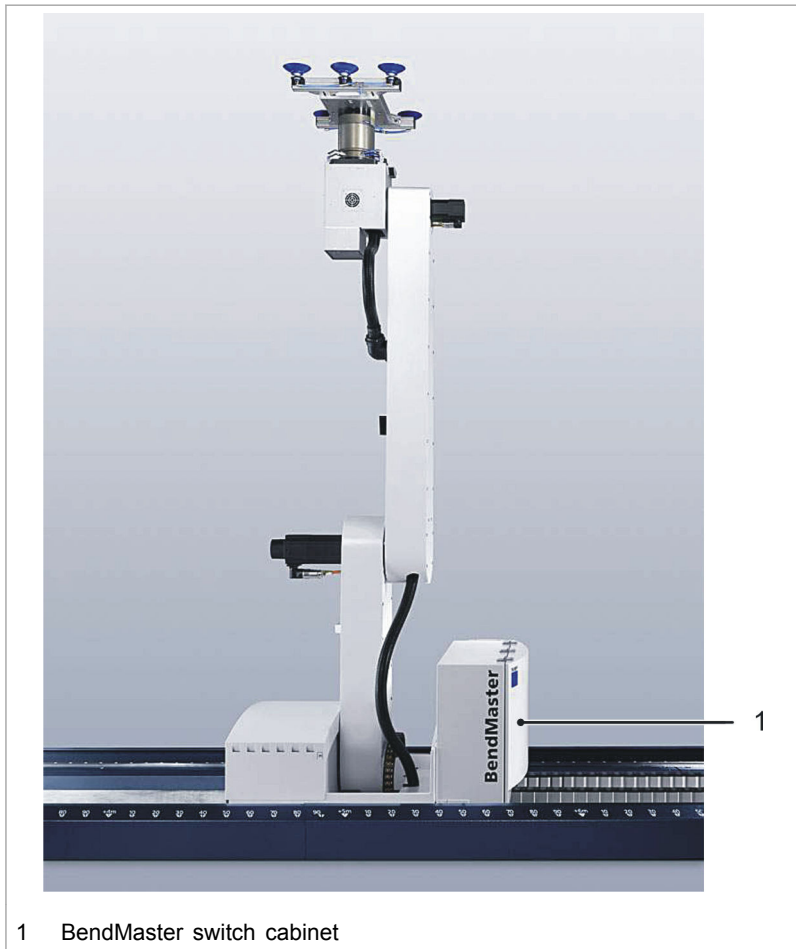


Fig. 71565

5.2 Maintenance Instructions

BendMaster: control cabinet

(see "Overview", pg. 5-16)

106424: Maintenance interval: 1000 operating hours
Cleaning or changing filter

Depending of the machine configuration, the fans are arranged differently.

Means, Tools, Materials

- 4x filter mat 120x120 (mat. no. 1779951).



Fig. 71110

1. Shut down the machine properly, secure the MAIN SWITCH and secure with a padlock.
2. Pull out the fan cover:
3. Clean and blow out the filters and fans with compressed air.
4. Replace all four filters if they are very dirty.
5. Reinstall the cover.
6. Switch on the system again in manual mode.
7. Check whether airflows can be felt.

BendMaster: switch cabinet

(see "Overview", pg. 5-16)

106425: Maintenance interval: 1000 operating hours
Clean the Peltier cooler

1. Shut down the machine properly, secure the MAIN SWITCH and secure with a padlock.



Fig. 71109

2. Pull off the lamella grid on the front side of the device.
3. Blow out the air inflow and air outflow openings with compressed air.
4. Switch on the system again in manual mode.
5. Check whether the inner and outer airflows can be felt.

BendMaster: fan in the C arm

(see "Overview", pg. 5-16)

106426: Maintenance interval: 1000 operating hours
Cleaning the fan



Fan in C arm

Fig.

1. Move the BendMaster into home position.
2. Shut down the machine properly, secure the MAIN SWITCH and secure with a padlock.
3. Remove the four screws from the fan mounting device.
4. Pull out the fan mounting device:
5. Blow out the fan with compressed air.
6. Refit the fan mounting device.
7. Switch on the system again in manual mode.
8. Check whether airflows can be felt.

BendMaster: fan, Z slide

(see "Overview", pg. 5-16)

106636: Maintenance interval: As needed
Function test

Depending on the series, there are three different Peltier cooling units:

- Peltier cooling unit 1: manufacturer, TRUMPF
- Peltier cooling unit 2: manufacturer, Rübsamen & Herr
- Peltier cooling unit 3: manufacturer, Rittal

In countries where there are higher ambient temperatures, an optional second Peltier cooling unit is available.



Fig. 71112

1. Check whether an airflow can be felt on the rear side of the switch cabinet on the Z slide.
2. Only for Peltier cooling units 1 and 2:
 - Clean the Peltier cooling unit with compressed air.
3. In case the message "cooling element ventilation: station X failure" is shown, Request Technical Service.

6. Optical components

6.1 Overview



Fig. 71114

6.2 Maintenance Instructions

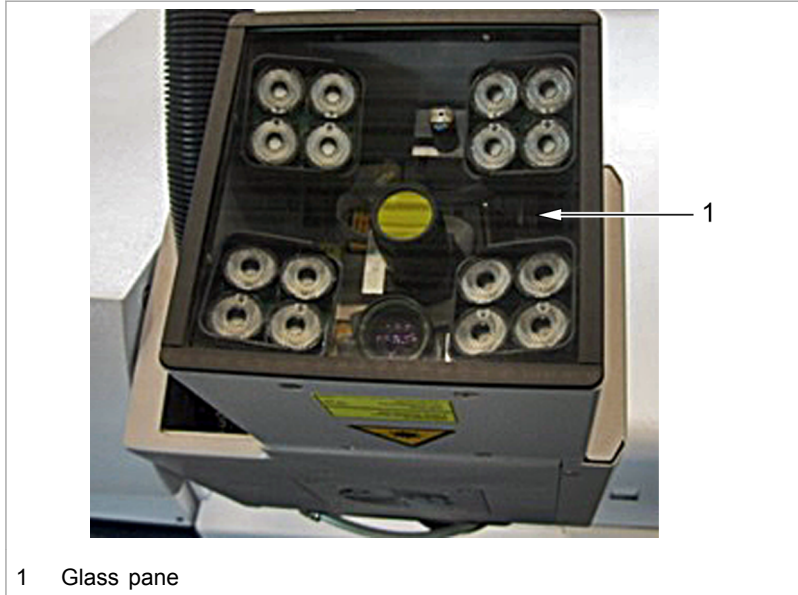
BendMaster: sheet sensor

(see "Overview", pg. 5-22)

106429: Maintenance interval: As needed
Clean the glass pane

Means, Tools, Materials

- Glass cleaner 1000 ml (mat. no. 1637606).
- Spray bottle, 1000 ml, with atomizer (mat. no. 1733721).
- Cloth for cleaning glass, (mat. no. 0351897).



1 Glass pane
Sheet sensor

Fig. 71113

1. Move the BendMaster into the manual gripper change position.
2. Rotate the C axis in such a way that the sheet sensor can be cleaned.
3. Shut down the machine properly, secure the MAIN SWITCH and secure with a padlock.
4. Clean the sheet sensor's glass pane.

7. Pneumatic components

7.1 Maintenance Instructions

Press brake: compressed air supply

106523: Checking the audible compressed air monitoring

Maintenance interval: Annually

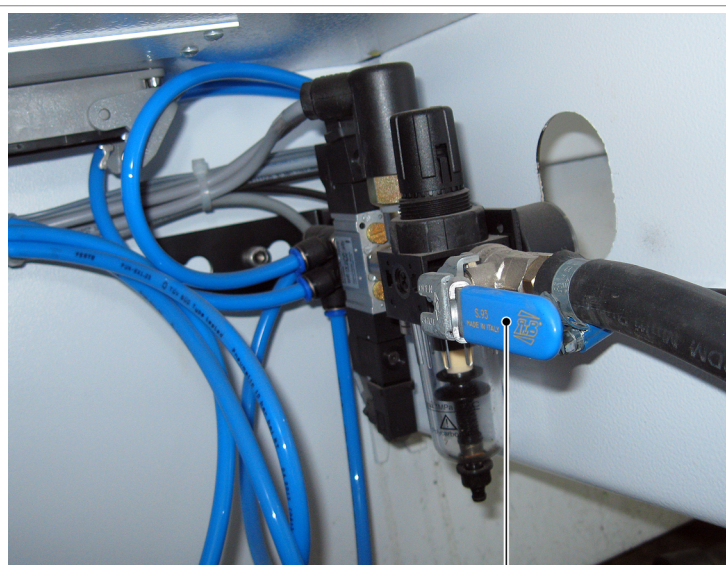
From version S08.00.

The horn for the audible air pressure monitoring is located in the switch cabinet for options. The test the horn is done by closing the air supply to the TruBend.

Note

Turning off the compressed air in the switch cabinet for options does **not** lead to a warning signal.

1. Close the compressed air shut-off valve under the press brake's switch cabinet. An audible warning signal must sound.



1 Stopcock

Compressed air unit under the press brake switch cabinet

Fig. 71115

2. If required: contact Technical Service.

Chapter 6

Maintenance (Technical Service)

1 Maintenance overview

6-2

1. Maintenance overview

The following maintenance work may only be done by TRUMPF Technical Service since special expert knowledge is required.

Customers without a valid service agreement must request technical service in good time.

Neglected maintenance work can result in serious damage to the system.

Operating hours interval	Maintenance point	Maintenance work	Category
Before entering the safety cabin	BendMaster: brakes	Check the brakes for proper function (visual inspection). The BendMaster must not drop	1, 2, 3
Every year	Air conditioning unit	Check the function of the air conditioning unit and clean it	1
Every year	BendMaster: Z axis	Check the hardware limit switch	1
Every year	BendMaster: Z axis	Check the pass overs of the path segments	1
Every year	BendMaster	Check the vacuum ejector	1
Every year	BendMaster: Z slide	Clean the fan	1
If required	Entire system	Perform safety equipment test	1

Tab. 6-1

Index

4-axis sensor gauge finger 3-12
 6-axis sensor gauge finger 3-13

A

A axis 3-5, 4-25
 A stack active 4-79, 4-81
 A stack blocked 4-80
 A stack full 4-80
 A stack ready 4-79, 4-81
 A stack ready 4-80
 Acceptance 4-123
 Accessories 1-22
 Accuracy 4-123
 Acknowledge 4-111
 Activate/deactivate 4-81
 Activate/deactivate Breakpoint 4-94
 Active Areas 4-64
 Additional height measurement 4-60
 Advance warning from 4-71
 Advance warning quantity 4-54
 Advance Warning Sheets Deposit 4-101
 Advance Warning Sheets Load 4-101
 After approximate search 4-61
 Alarms 4-111
 Align and clamp left 4-91
 Align and clamp right 4-91
 Alignment left 4-91
 Alignment left and right 4-91
 Alignment right 4-91
 All 4-111
 All stacks 4-80
 Always approach 4-61
 Ambient conditions 2-11
 Amplification 4-124
 Apply areas 4-77, 4-78
 Approach laser position 4-68, 4-69
 Approach strategy 4-91
 Arm 3-7
 As with job setting 4-70, 4-71
 Automatic gripper change 4-28
 Automatic mode 4-18
 AUX 4-26, 4-32, 4-33
 Auxiliary tools 2-18
 Average 4-123, 4-124
 Average contour 4-123
 Axes 3-5, 4-25

B

B axis 3-5, 4-25
 Backgauge and Y movement 4-91
 Backgauge before Y movement 4-91
 Backgauge sensor system 4-90
 Backgauge sensors 4-90
 Backlighting table 3-25, 4-60, 4-71
 Backstop resistor 4-36, 4-92
 Before and after approximate search 4-61
 Before approximate search 4-61
 BEND_SHEET 4-94
 Blow-off time 4-85
 Blowing clean time 4-85
 Box 4-83
 Button
 Bending cell illumination 4-10
 Move coordinate system 4-23
 Button, GREEN 4-20

C

C axis 3-5, 4-25
 CART 4-25
 Cause 4-111
 CE marking 1-3
 Ceiling plate 2-9
 Change Height 4-81
 Changing user settings 4-13
 Check inventory 4-108
 Check job 4-104
 Check job list 4-104
 Check package 4-104
 CHECK_PRESSTOOL 4-93
 CHECK_ROBTOOL 4-93
 Clamp left 4-91
 Clamp right 4-91
 Cleaning 5-3
 Combined separation 4-86
 Complex contour 4-123
 Compressed air
 Properties 2-13
 Supply lines 2-13
 Compressed air supply 2-13
 Connected loads 2-13
 Cont 4-94
 Contrast 4-122, 4-123

Control panel 3-9, 4-9
 Coordinate system
 Coordinate system displayed 4-24
 Move coordinate system 4-24
 Create model 4-122
 Creating a job 4-53
 Current number of sheets 4-82, 4-83
 Cycles 4-86

D

D axis 3-5, 3-9, 4-25
 Danger signs 1-16–1-18
 Danger zone
 Safeguarding device 1-13
 Danger zone, teach mode 1-14
 Deactivate vacuum intermediate layer ... 4-72
 Decrement Sheet 4-82
 Default setting 4-61
 Default user 4-15
 Defined search area 4-75
 Defining stacks 4-78
 Delay time 4-86
 Delete 4-68, 4-99
 Delete all areas 4-68
 Delete all stacks 4-80
 Delete area 4-68
 Delete stack 4-80
 Deleting a job 4-55, 4-57
 Deposit rejects 4-66
 Deselecting a job 4-55
 Details 4-69, 4-82
 Diagnostics 4-111
 Disable 4-13
 Disconnect 4-121
 Disconnected 4-121
 Display 4-11, 4-80
 Done 4-53
 Double sheet recognition
 Integrated double sheet recognition ... 3-23
 Pallet scale 3-23
 Double sheet separation 3-24

E

EC Declaration of Conformity 1-3
 Edit mode 4-121
 Effect 4-112
 Elastically cushioned base plate 2-8
 Elasticity 4-123
 Electrical power supply 2-14
 Electrics 2-14

Empty all unloading areas 4-82
 Empty unloading area 4-82, 4-101
 Enable key 4-8
 Enabling conditions
 Automatic mode 4-18
 Manual mode 4-17
 Manual press 4-20
 Entire search area 4-74
 Error strategy/recognition 4-60, 4-70
 Error: part interference contour recognized
 4-130
 Error: Part underneath detected 4-128
 Errors/messages 4-111
 Existing messages 4-111, 4-113
 Expansion joints 2-8
 Exposure time 4-123
 EXTERN_VISION_SHEET 4-93

F

File away 4-56–4-58
 Filing away a job 4-56
 Filter 4-80
 Find stack 4-74, 4-76, 4-77
 Fine recognition 4-60, 4-123
 Description 3-9
 Fine recognition after separation 4-87
 Fine recognition at the backlighting table ...
 4-60
 Fine recognition at the stack, periodic ... 4-60
 Fine recognition on the stack, once 4-60
 Finished part 4-54
 Floor lane 3-7, 3-15
 Floor quality 2-8
 Floor requirements 2-6
 For all bendings 4-90
 Foreground 4-121
 Free span base plate 2-9

G

Go to breakpoint 4-94
 Gripper 3-15, 4-84
 Gripper and travel motion 4-87
 Gripper change 4-28
 Gripper changing console 3-25, 5-5
 Gripper construction kit 3-18
 Gripper deposit station 4-29, 4-31, 4-86
 Gripper servicing 4-27
 Gripper weight 4-61
 Gripper, then travel motion 4-86

H

Handling equipment	3-27
Height compensation	4-60
Height measurement in case of error strategy	4-61
Height measurement mode	4-71
Height tolerance	4-70
High	4-90
Holder location	4-85

I

Ignore Polarity	4-123
Image recording	4-122
Image recording settings	4-123
Images of approximate search	4-72, 4-76
Increment Sheet	4-82
Index	4-122
Indicator light on safety fencing	4-12
Inner contour	4-123
Integrated system	4-88
Intended use	1-5
Intermediate layer part	4-54
Intermediate layer search automatic	4-106
Intermediate layer search exact	4-66, 4-106
Intermediate layer search manual	4-106
Interpolation points	4-95
Interpolation type	4-97
Isolating transformer	
Regulated	2-14
Unregulated	2-16
IT network	2-17

J

Job	4-102
Job details	4-59
JOINTS	4-25
Jumpering the sensor finger	4-113

K

Key switch for operation mode selection	4-17
---	------

L

L coordinate OK	4-79
L height OK	4-79, 4-81
L stack active	4-79, 4-81
L stack blocked	4-79
L stack empty	4-79
L coordinate OK	4-80
L no coordinate	4-80
Language	4-14
Lay down gripper	4-31
Liability disclaimer	1-22
Lift gate	5-5
Load Search A	4-66
Load Search automatic	4-106
Load Search exact	4-66, 4-106
Load Search M	4-66
Load Search Manual	4-106
LOAD_LAYER	4-93
LOAD_SHEET	4-93
Loading a job	4-55
Loading stack	4-83
Lock/unlock stack	4-80, 4-81
Lot size	4-53
Low	4-90
Low-pass filter	4-90
Lubrication	5-3, 5-6
Lubrication schematic	5-6

M

Maintenance	
Audible compressed air supply monitoring, check	5-5
C fan, BendMaster	5-5
Control cabinet, BendMaster	5-5
Fan, Z slide, BendMaster	5-5
Gripper changing console	5-5
Lift gate	5-5
Pivoted-jaw gripper	5-5
Regripping station	5-5
Sensor gauge finger	5-5
Sheet removal station	5-5
Sheet sensor	5-5
Switch cabinet, BendMaster	5-5
Z axis, BendMaster	5-5
Z slide	5-5
Manual mode	4-17
Manual press	4-20
Material ID	4-107
Material ID (store)	4-55

Max. sheets 4-83
 Medium 4-90
 Message 4-101
 Minimum 4-124
 Mirroring 4-123
 MIXED 4-26
 Mobile fanning magnet 3-27
 Moving manually
 in automatic mode 4-22
 in manual mode 4-22
 Moving the regripping station into the parking position 4-33
 Multi-gripper 3-17
 Multiple-circuit suction cups 3-17

N

Network
 IT 2-17
 Network link 2-17
 New rough recognition 4-60, 4-70
 No error processing 4-60, 4-70
 No filter 4-90
 No fine recognition 4-60
 No height measurement 4-60, 4-61, 4-71
 No position 4-86
 No recognition 4-88
 No separation 4-86
 Normal-active 4-37
 Number of layers 4-82, 4-83

O

Offset fine recognition 1 4-82
 Offset fine recognition 2 4-82
 Offset in X 4-71
 Only after fine recognition 4-61
 Opaque 4-123
 Operating elements
 Portable manual control unit 4-6
 Operating modes 4-16
 Operation 4-99
 Operating modes 4-16
 Operation: moving axes manually 4-22
 Options
 at the TruBend 3-30
 Backlighting table 3-25
 Double sheet separation 3-24
 Extendable floor lane 3-15
 Gripper 3-15
 Gripper changing console 3-25
 Gripper construction kit 3-18

Handling equipment 3-27
 Integrated double sheet recognition ... 3-23
 Mobile fanning magnet 3-27
 Multi-gripper 3-17
 Multiple-circuit suction cups 3-17
 Pivoted-jaw gripper 3-20
 Productivity package 3-26
 Regripping station 3-24
 Screen 3-10
 TruTops°Bend 3-29
 Vacuum gripper 3-15
 Order, restoring 4-56
 Overlay 4-95
 Overlay point 4-95
 Overlay size 4-98
 Overlay type 4-98
 Override 4-104
 Overview 4-72, 4-83

P

Packages 4-102
 Pallet height 4-65
 Pallet ID 4-107
 Pallet scale 4-88
 Parts data 4-54, 4-84, 4-105
 Peeling all points 4-86
 Peeling at close range 4-86
 Peeling from a distance 4-86
 Peeling switched off 4-86
 Period 4-60
 Periodic height measurement 4-60
 Pick up gripper 4-30
 Pick up job gripper 4-30
 Pickup 4-98
 Pivoted-jaw gripper 3-20, 5-5
 Planning aid 2-4
 Portable manual control unit 3-9
 Position 4-23, 4-26, 4-101
 Position monitoring active 4-61
 Position recognition results 4-122
 Position recognition settings 4-122, 4-123
 Position regripping station 4-98
 Position robot 4-98
 Positions 4-100
 Power supply 2-15
 Outer conductor grounded 2-16
 Pre production in case of full storage ... 4-61
 Problem
 No part recognized 4-126
 Production list 4-102
 Production package 4-102
 Production plan 4-102

Productivity package3-26, 4-50
 Project stacks 4-80

Q

Quantity intermediate layers4-82, 4-83

R

Recognition4-87
 Recognition selection 4-88
 RED button4-20
 Reference 4-39
 Referencing 4-42
 Referencing the BendMaster 4-39
 Referencing TruBend 4-42
 Reflecting4-123
 Regripping station 3-24, 4-32, 4-33
 Move manually 4-32
 Remove 4-35
 Set up 4-33
 Release write permission4-14
 Remove all breakpoints 4-94
 Required 4-104
 Requirements, space 2-6
 Residual risks 1-24
 Results4-122
 Resume 4-101
 Rotate stack 90° 4-81
 Rotate stack by x 4-81
 Rotation position, approaching 4-61
 Rotation to Geo 4-55
 Rotational position tolerance4-60
 Rotational transformer 3-9
 Rough position 4-114
 Rough recognition4-72, 4-123
 Description 3-8
 Rough recognition and backlighting table
 4-60, 4-71
 Run mode 4-121, 4-122
 Running project stacks4-80

S

Safety4-11
 Safety fence 1-14
 Safety fencing 3-9, 5-5
 Screen 3-10
 Search 4-122
 Search area4-75

Search within area4-72, 4-77
 SELECT TrumpfRobot 4-93
 Selected Order 4-53
 Selection 4-75
 Sensor gauge finger5-5
 Sensor gauge fingers 3-11
 Sensors for press 4-36
 Separate before measuring 4-87
 Separating time 4-86
 Separation at the gripper 4-86
 Separation by travel motion 4-86
 Separation method 4-85, 4-86
 Set Breakpoint 4-94
 Set PC 4-94, 4-99
 Set up 4-105
 Settings from V7.0 and higher 4-50
 Sheet removal station3-21, 5-5
 Sheet rotation 4-71
 Sheet sensor 3-8
 Show none 4-100
 Simple contour 4-123
 Small parts 3-13
 Software 1-22
 Software versions 4-13
 Sort by position 4-123
 Source text 4-101
 Spare parts 1-22
 Speed 4-97
 Automatic mode 4-24
 Manual mode 4-24
 Stack 4-79, 4-101
 Stack empty code4-61, 4-71
 Stack execution mode 4-70
 Stack layout 4-78
 Stack mode 4-79
 Stack use 4-82, 4-83
 Stacked 4-83
 Start 4-101
 Start press 4-43
 Start production plan 4-104
 START_ORDER 4-93
 Starting a program 4-100
 Status 4-54, 4-121
 Stepping 4-94
 Stop 4-101
 Stop production plan 4-104
 Storage station4-106, 4-109
 Stress due to vibration 2-11
 Suction cups Off 4-32
 Suction cups On 4-32
 Surface 4-123
 Switch cabinet 3-7
 Switching off 4-46
 Switching off the BendMaster 4-46
 Switching on 4-38

Switching on the BendMaster 4-38
 Symbols 4-11

T

Teaching 4-96
 Technical data 3-4
 Teleservice 4-125
 through fine recognition 4-61
 through height measurement 4-61
 through quantity 4-61
 Timeout suction 4-85
 Tolerance position 4-60
 TOOL 4-26
 Tool-change height 4-86
 Tool holder 4-59
 TOOL MIXED 4-26
 Tooling plan 4-84, 4-85
 Transport 2-18
 Auxiliary tools 2-18
 Transport dimensions 2-18
 Travel functions 4-48
 Travel motion, then gripper 4-86
 Travel point 4-97
 Troubleshooting 4-126
 TruTops°Bend 3-29

U

Unload Precise 4-66
 UNLOAD_SHEET 4-94
 Unloading stack 4-83
 Unprocessed material 4-54
 Update 4-54
 Use Pattern Settings 4-122
 User configuration 4-15
 User group 4-16
 Users 4-14

V

V- 4-24
 V+ 4-24
 V7.0 4-50
 Vacuum gripper 3-15
 Vacuum monitoring 4-72
 Vibration damping 2-10

W

Water protection 1-21
 Weight load 2-10
 When moving 4-92
 When stopping 4-92
 Withdrawal active 4-37
 Without backgauge 4-91
 Writing BIO 4-15

Y

Y movement before backgauge 4-91

Z

Z axis 3-5, 4-25
 Z position search A 4-66
 Z slide, lubricate 5-5
 Zoom 4-73, 4-121