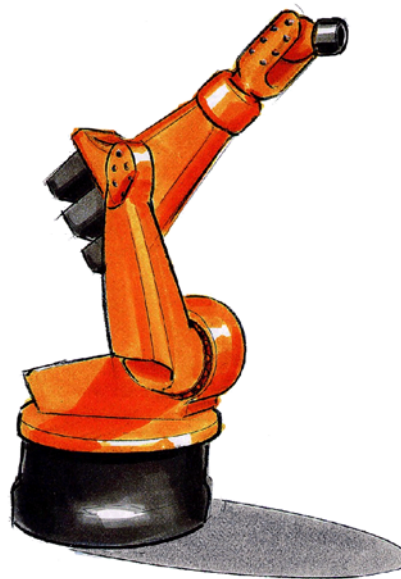

SOFTWARE

KR C2 / KR C3

Operating Handbook

New Features

KUKA System Software (KSS) Release 5.2



© Copyright **KUKA Roboter GmbH**

This documentation or excerpts therefrom may not be reproduced or disclosed to third parties without the express permission of the publishers. Other functions not described in this documentation may be operable in the controller. The user has no claim to these functions, however, in the case of a replacement or service work.

We have checked the content of this documentation for conformity with the hardware and software described. Nevertheless, discrepancies cannot be precluded, for which reason we are not able to guarantee total conformity. The information in this documentation is checked on a regular basis, however, and necessary corrections will be incorporated in subsequent editions.

Subject to technical alterations without an effect on the function.

PD Interleaf

Part 1: Operating Handbook

Introduction

Safety

Operator Control

Start-up

User Programming

Appendix

Part 2: Programming Handbook

Configuration

Expert Programming

Additional Functions

Applications

Appendix



SOFTWARE

KR C2 / KR C3

Operator Control

New Features

KUKA System Software (KSS) Release 5.2

Issued: 14 Jan 2004 Version: 00

© Copyright **KUKA Roboter GmbH**

This documentation or excerpts therefrom may not be reproduced or disclosed to third parties without the express permission of the publishers. Other functions not described in this documentation may be operable in the controller. The user has no claim to these functions, however, in the case of a replacement or service work.

We have checked the content of this documentation for conformity with the hardware and software described. Nevertheless, discrepancies cannot be precluded, for which reason we are not able to guarantee total conformity. The information in this documentation is checked on a regular basis, however, and necessary corrections will be incorporated in subsequent editions.

Subject to technical alterations without an effect on the function.

PD Interleaf

Contents

1	Running up / shutting down the controller	7
1.1	7
1.2	7
1.3	Running up the controller	7
1.4	8
1.5	Controller response when switched back on	8
1.5.1	8
1.5.2	Cold start	8
1.5.2.1	8
1.5.2.2	Power failure with the system running	8
1.5.3	Setting external power supply and user outputs	9
2	The KUKA Control Panel (KCP)	10
2.1	Operator control elements of the KCP	10
3	Coordinate systems	11
3.1	Joint coordinate system	12
3.2	WORLD coordinate system	13
3.3	BASE coordinate system	14
3.4	TOOL coordinate system	15
3.5	ROBROOT coordinate system	17
4	Jogging the robot	18
4.1	18
4.2	18
4.3	18
4.4	18
4.5	Jog override (jog velocity)	18
5	Navigator	19
5.1	Graphical user interface	19
5.1.1	19
5.1.2	Header	19
5.1.3	19
5.1.4	Directory and file list	19
5.1.4.1	Pop-up menu	19
5.2	“File” menu	20
5.2.1	20
5.2.2	20
5.2.3	20
5.2.4	Archive	21

5.2.5	Restore	22
5.2.5.1	All	22
5.3	“Edit” menu	23
5.3.1	23
5.3.2	23
5.3.3	23
5.3.4	23
5.3.5	23
5.3.6	23
5.3.7	23
5.3.8	Cancel program	23
5.3.9	Reset program	23
6	Executing, stopping and resetting a program	24
6.1	24
6.2	Program velocity (Programm override)	24
6.3	Stop reactions	24
6.3.1	24
6.3.2	24
6.3.3	Maximum braking	24
6.3.4	Short-circuit braking (dynamic braking)	24
6.4	Manual program execution (jog mode)	25
6.4.1	25
6.4.2	25
6.4.3	25
6.4.4	Executing individual program lines	25
6.5	Automatic program execution	27
6.5.1	BCO run	27
6.5.2	Complete program execution	27
6.5.3	Stopping program execution	27
6.5.4	Continuing a program	28
6.5.5	Resetting a program (Reset)	28
7	Monitor	29
7.1	Inputs/Outputs	29
7.1.1	29
7.1.2	Digital outputs	29
7.2	30
7.3	30
7.4	30
7.5	30
7.6	Hardware Info	31

1 Running up / shutting down the controller

1.1

1.2

1.3 Running up the controller

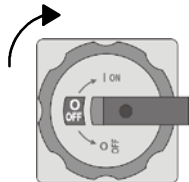

After the robot system has been switched on using the main switch on the control cabinet, the computer begins to run up (load) the operating system and the control software.



The display then shows the main menu for program creation, selection and execution.

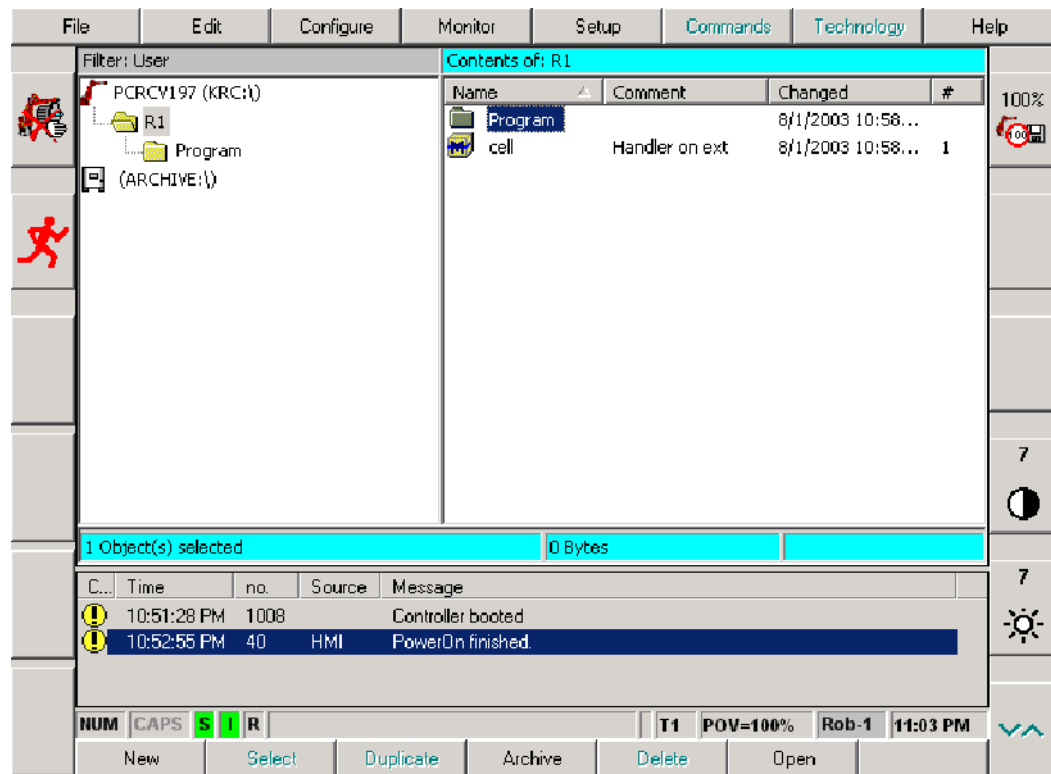

If the machine data loaded do not match the robot type, a corresponding error message is generated when the controller is booted. The robot must not be moved in this case.



If the robot controller logs onto the network, this has a significant effect on the time the controller takes to boot.

1.4

1.5 Controller response when switched back on

1.5.1

1.5.2 Cold start

1.5.2.1

1.5.2.2 Power failure with the system running

In the event of a power failure during normal operation, the robot is stopped by short-circuit braking (dynamic braking). A corresponding message is generated in the message window. It makes no difference whether the power failure was caused by failure of the mains supply or by pressing the main switch during program execution.

All kernel system files are backed up on the hard disk. Once the files are saved, the system waits until the PowerOff delay has elapsed. This is then followed by one of two eventualities:

- Power is restored before the PowerOff delay has elapsed
The robot system is not shut down, but an acknowledgment message is generated which must be acknowledged. Work can then be resumed.
- Power is still absent when the PowerOff delay has elapsed
The status of the kernel system is backed up on the hard disk and the controller is shut down, in a controlled manner, by the battery back-up. The control system is then switched off.



If the battery back-up is not sufficient, in exceptional circumstances files could be destroyed. In this case, a cold start is carried out.

Loss of mastering may occur if the battery voltage fails before the mastering data are saved.

When power is restored the controller is automatically run up and selects the program that was previously running. Program execution can be resumed at the point at which the program was interrupted. Once again, there are two ways of doing this:

- If the robot is located on its programmed path (e.g. ramp-down braking), the program can be started using the "start continue" function.
- If the robot has left its programmed path (e.g. short-circuit braking), a BCO run may, under certain circumstances, be necessary at the point where the path was left (RET position).

1.5.3 Setting external power supply and user outputs

External power supply

The computer unit in the robot controller can be supplied separately by an external power supply (option). A power source is required here, which works independently of the normal power supply. In the event of a mains power failure, the computer unit is not shut down.

Deactivating the user outputs

In the event of a power failure with a functioning external power supply, the user outputs are not deactivated as standard. If the system is configured accordingly, however, the user outputs are restored when power returns.

2 The KUKA Control Panel (KCP)

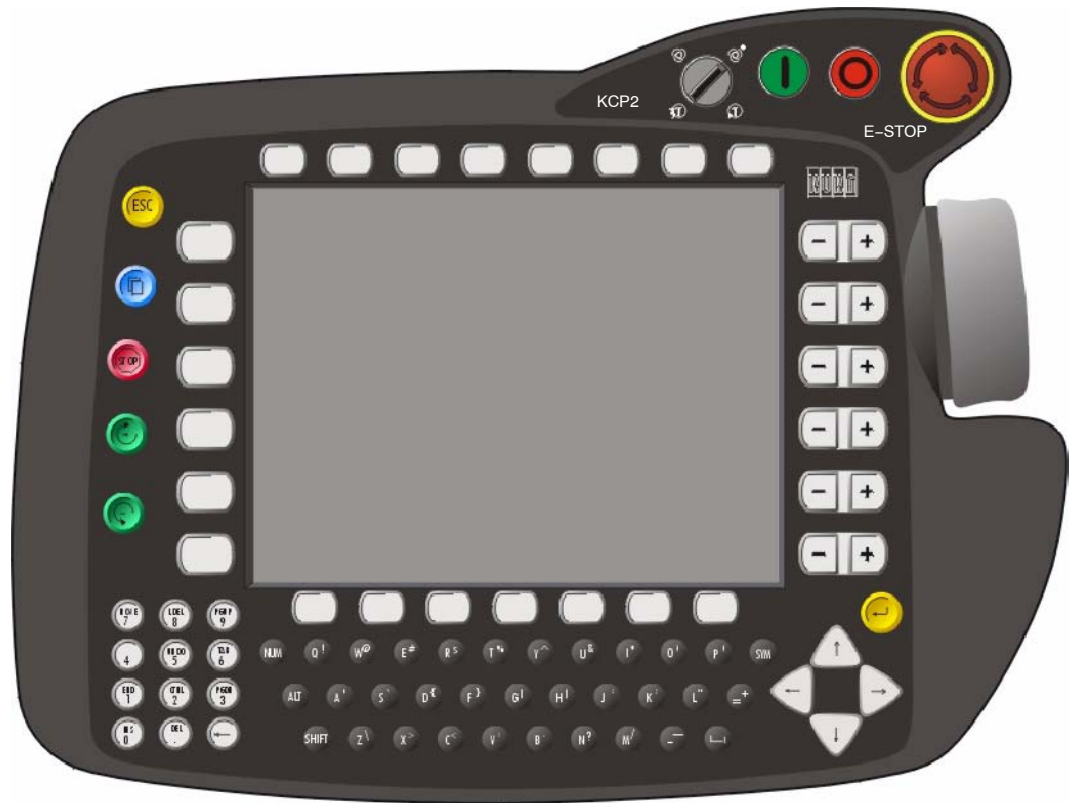

The “KUKA Control Panel”, referred to hereafter as “KCP”, forms the human-machine interface and is used for easy operation of the “KR C...” robot controller. All elements required for programming and operator control of the robot system, with the exception of the main switch, are located directly on the KCP. The LCD screen is used to visualize operator and programming actions.

2.1 Operator control elements of the KCP

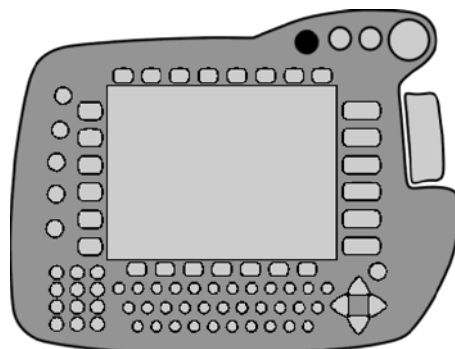
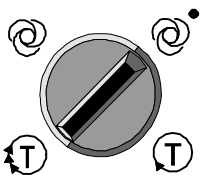

Mode selector switch



Using this keyswitch you can switch between the different operating modes.

The current setting of the mode selector switch is displayed in the status line.

Operating mode	Jogging	Program mode
 (Test 1)	Jog velocity Keep enabling switch held down Press jog key or Space Mouse	Jog velocity Keep enabling switch held down Keep Start key held down

 (Test 2)	T2 Jog velocity Keep enabling switch held down Press jog key or Space Mouse	Programmed velocity Keep enabling switch held down Keep Start key held down
 (Automatic)	Not possible	Programmed velocity Drives ON Press Start key briefly
 (Automatic External)	Not possible	Programmed velocity Drives ON External start

If the operating mode changes while the program is running, dynamic braking is activated.



Automatic operation is only possible with the safety circuit closed.

Enabling switches

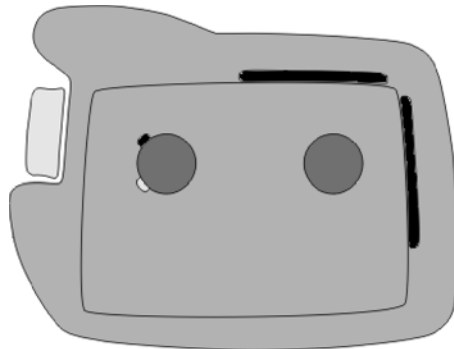

For certain actions, such as jogging the robot, one of the enabling switches must be held down.

The enabling switches are situated on the back of the KCP and on one of the holding domes.

They are all designed as two-position buttons. For program execution, a button must be held in the middle position. Releasing the button or pressing it hard triggers dynamic braking.

3 Coordinate systems

In jog mode, the robot is moved in accordance with the selected coordinate system.

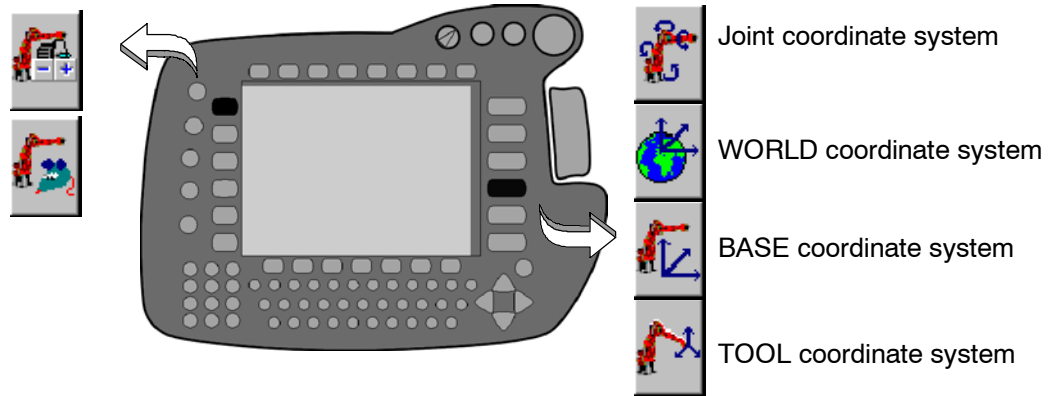

As jog mode, select "jog keys" or "Space Mouse". Then use the +/- status key to select the desired coordinate system.

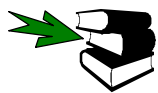

Further information on jogging with the Space Mouse and jog keys can be found in the chapter **[Jogging the robot]**.

3.1 Joint coordinate system



In the joint coordinate system, each robot axis can be individually moved in positive or negative axis direction. This can be done using the jog keys or the Space Mouse, the Space Mouse allowing 3 or 6 axes to be moved simultaneously.

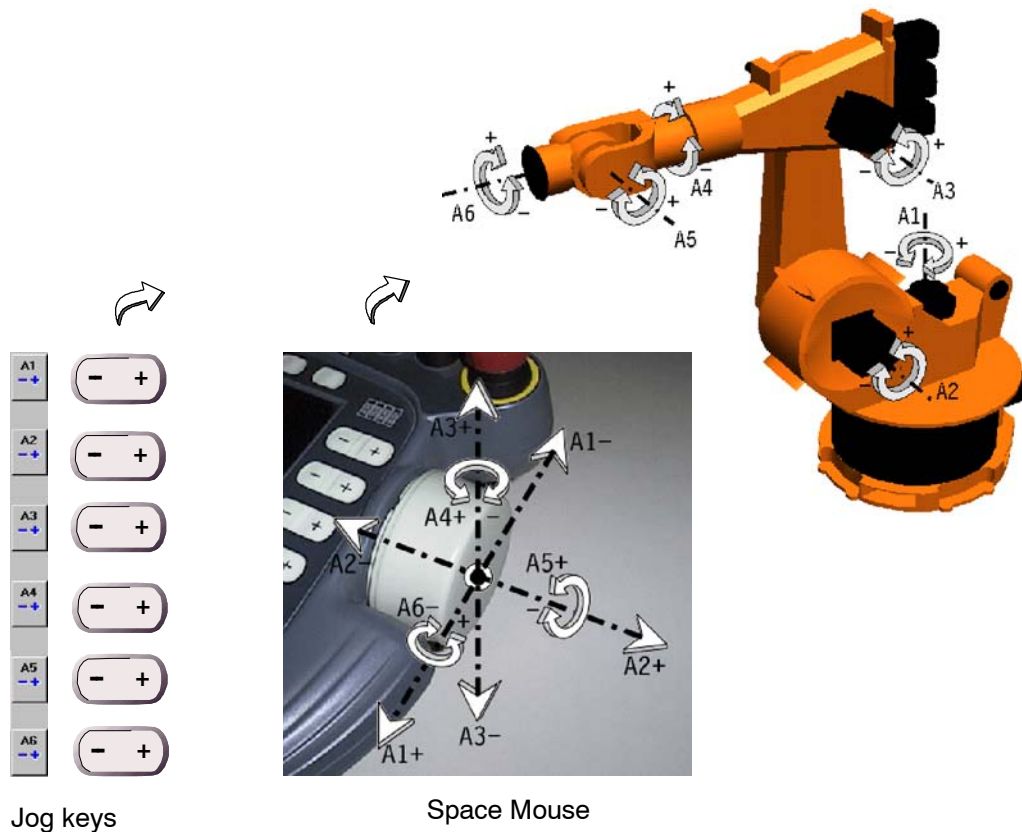

3.2 WORLD coordinate system



The WORLD coordinate system is a stationary, Cartesian coordinate system. It serves as the root coordinate system for the BASE and ROBROOT coordinate systems.

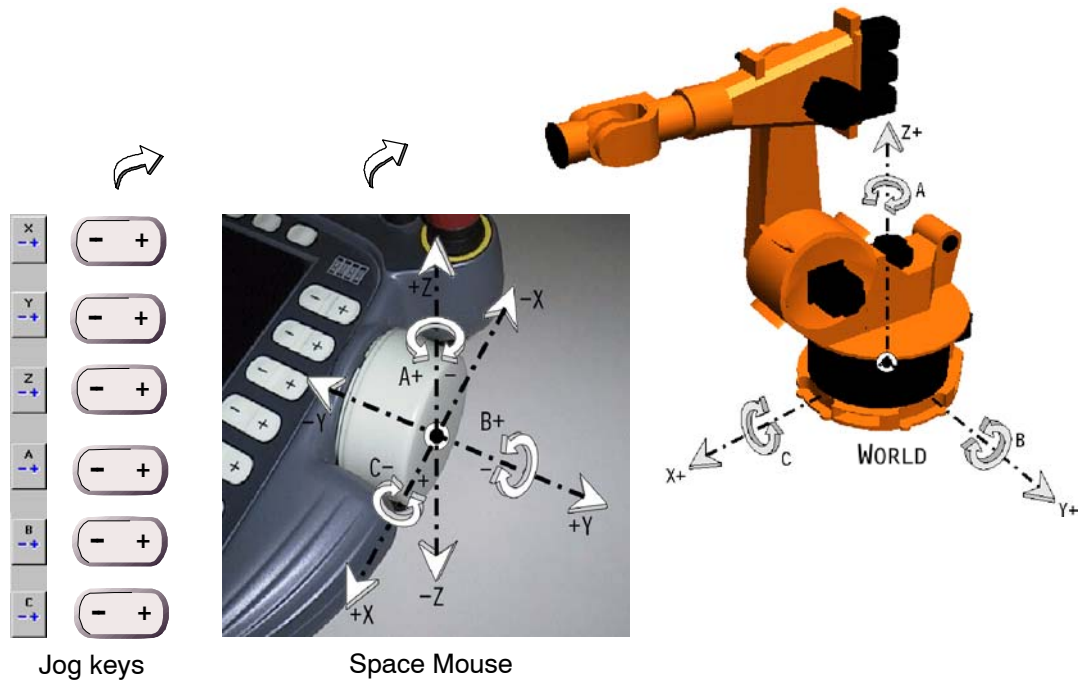

The World coordinate system only corresponds with that of the Space Mouse if the operator with the KCP is standing directly in front of the robot.

Position of operator ●



As standard, the origin of the WORLD coordinate system is located at the center of the robot base.

3.3 BASE coordinate system



The BASE coordinate system is a Cartesian coordinate system which is calibrated in such a way that the origin is located in or at a workpiece or fixture.

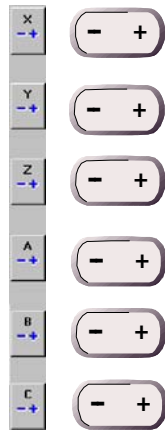

Jog keys

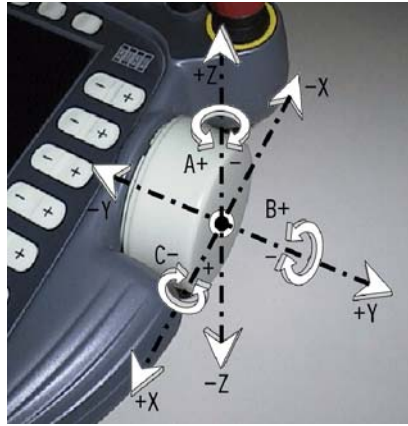

Space Mouse

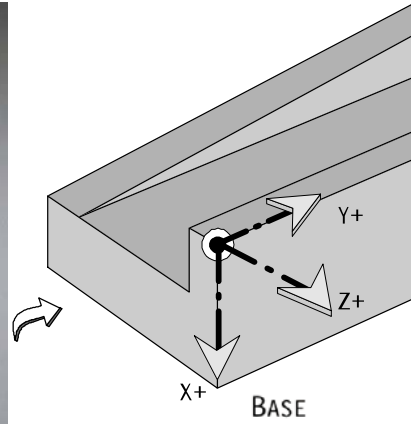

On delivery, the origin of the BASE coordinate system is located in the base of the robot.

The BASE coordinate system is relative to the WORLD coordinate system.

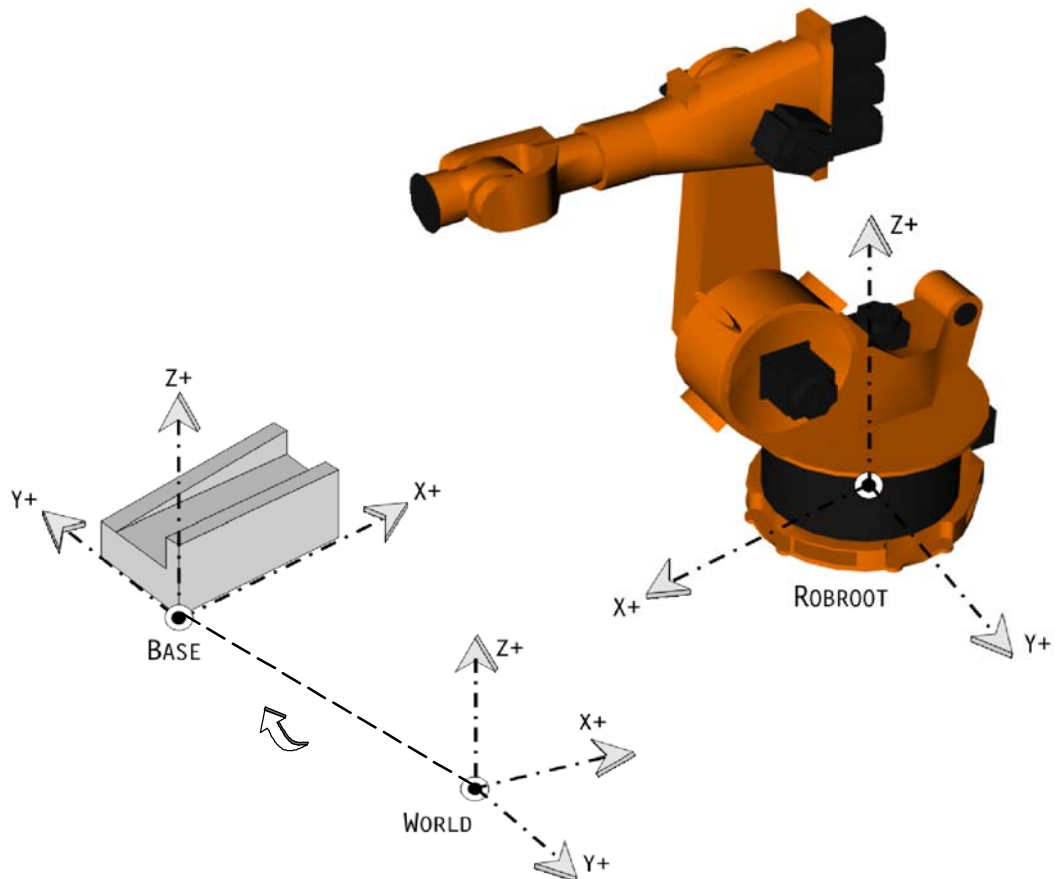

3.4 TOOL coordinate system



The TOOL coordinate system is a Cartesian coordinate system which is calibrated in such a way that the origin is located in the tool.

Example: servo gun

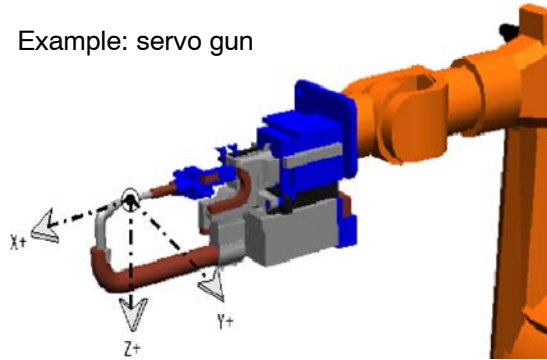

Example: torch

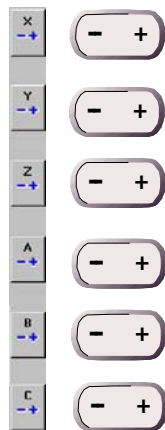
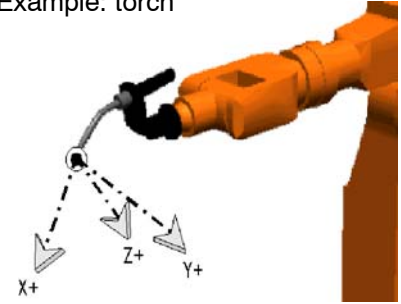

Jog keys

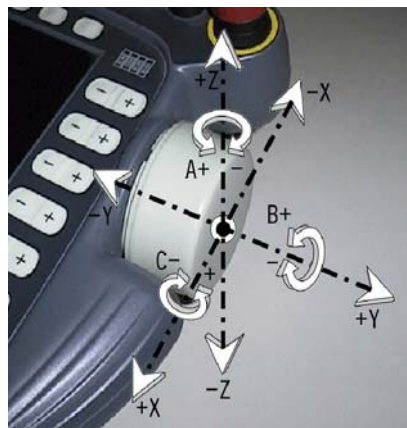

Space Mouse

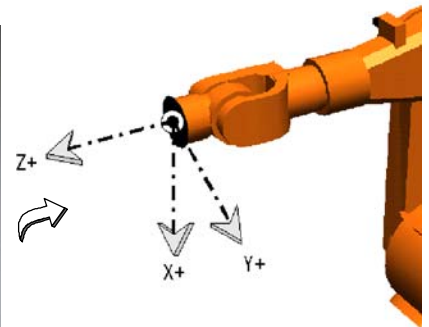

The TOOL coordinate system is generally orientated in such a way that its X axis is identical to the working direction of the tool (tool direction).



On delivery, the origin of the TOOL coordinate system is located at the flange centerpoint.

The TOOL coordinate system is relative to the BASE coordinate system.

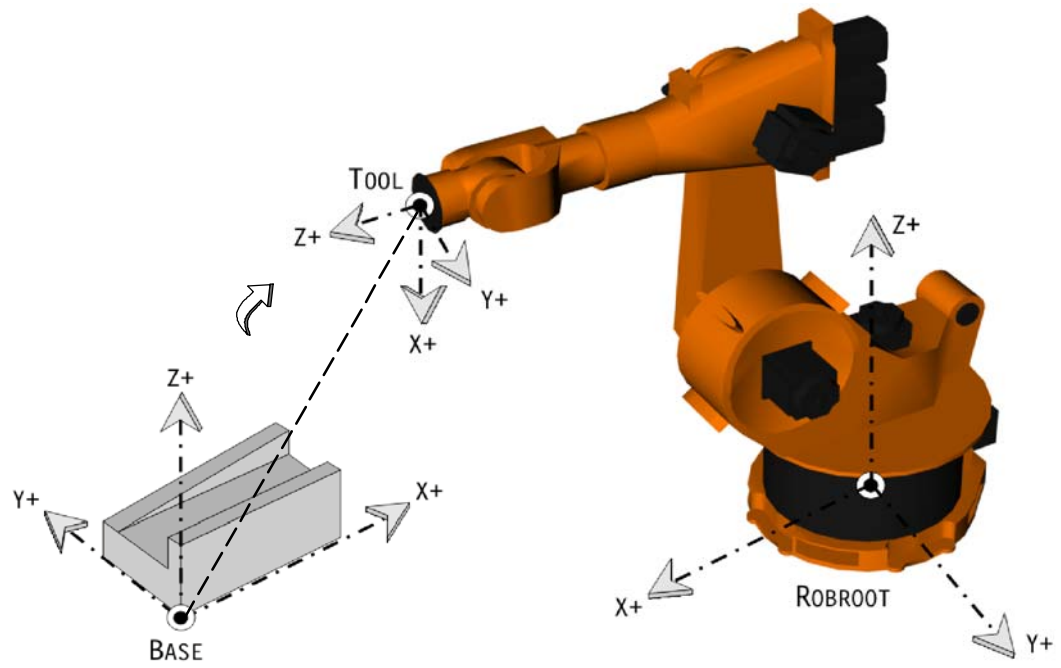

3.5 ROBROOT coordinate system

The origin of the ROBROOT coordinate system is always located in the base of the robot and is relative to the WORLD coordinate system. This allows the definition of an offset of the robot relative to the WORLD coordinate system.

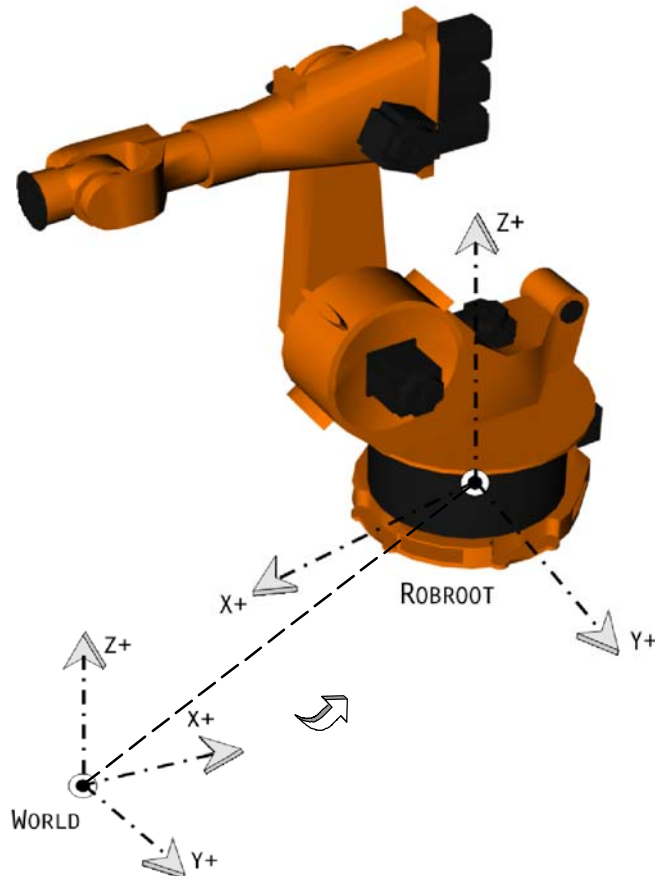

On delivery, the origin of the ROBROOT coordinate system is identical to that of the WORLD coordinate system and is located in the base of the robot.

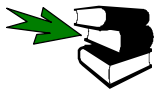

Detailed information on the subject "ROBROOT" may be found in the **Programming Handbook**, in the main chapter **[Expert Programming]**, chapter **[Motion programming]**.

4 Jogging the robot

4.1

4.2

4.3

4.4

4.5 Jog override (jog velocity)

In some cases, it is of vital importance to reduce the velocity of the robot. Only in this way is it possible to address points precisely and avoid collisions between the workpiece and the tool.

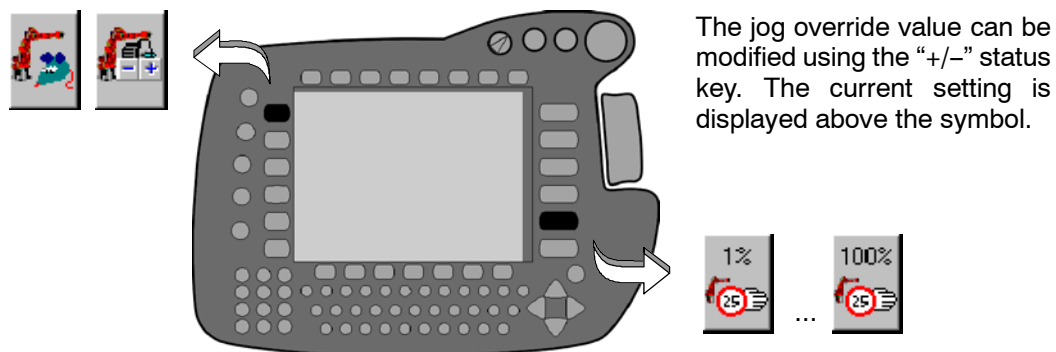

In modes “T1” and “T2”, the jog override can also be altered during program execution.



Depending on the configuration, the HOV value last used is restored when the system is switched to “T1” mode.

With the Space Mouse, the jog velocity can be further decreased by reducing the deflection of the mouse (velocity proportional to the deflection).



The jog override increment can be increased. To do this you must activate the option “Jog OV Steps on/off” in the “Configure” -> “Jogging” menu. The value is then no longer altered in increments of 1% but changes between 1, 3, 10, 30, 50, 75 and 100 per cent of the value defined in the machine data.

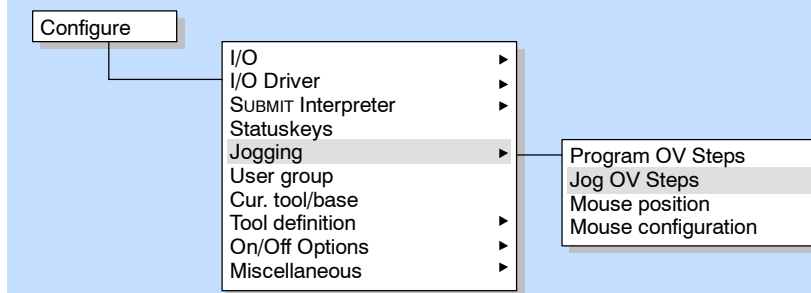

If you have selected the joint coordinate system as the reference coordinate system the jog override refers to the specific axis.

If a rectangular coordinate system is set (e.g. WORLD coordinate system) the jog override refers to the axis with the longest trajectory (leading axis). The motions of all other axes are synchronized with the leading axis.

5 Navigator

5.1 Graphical user interface

5.1.1

5.1.2 Header

The left side of the header shows the filter or the templates that are available for selection. The right side shows the folder and/or file path.



The filter setting and template selection are not available in the user group "User".

Filter

Filter: Module



The current filter setting is displayed above the directory structure.

The filter can be set to "Modules" or "Detail view".

Contents of: PCRCV197 (KRC:1)



The current drive or directory is displayed in the directory or file list.

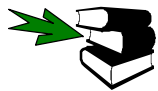

Information on the user group "Expert" can be found in the **Programming Handbook** in the main chapter **[Configuration]**, chapter **[Configuring the system]**.

Template

Filter: Module



The template selection is displayed above the directory structure.

Contents of: PCRCV197 (KRC:1)



The current drive or directory is displayed in the directory or file list.

5.1.3

5.1.4 Directory and file list

5.1.4.1 Pop-up menu

For each selected object (e.g. program list or data list, etc.) a pop-up menu can be opened as an alternative to the pull-down menus and softkeys. Only those commands are available for selection which can actually be executed at a given moment.

The menu can be opened in one of the following ways:



Pressing the “→” arrow key;



Pressing the right mouse button (if a computer mouse is connected);



Pressing the application key (if a corresponding keyboard is connected to the system).

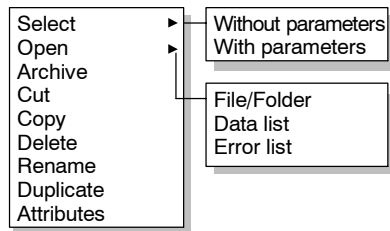

The pop-up menu opens. This menu only offers those functions that are actually available.

Move the focus to the previous/next menu item using the “↑” and “↓” arrow keys. You can open a submenu using “→” or the Enter key and close it again using “←” or the ESC key.

Alternatively, you can select a command by pressing the corresponding number on the numeric keypad. The “NUM” display must be activated in order to do this. The numbers preceding the individual commands are fixed, i.e. the commands are not dynamically renumbered. Thus the experienced user need only remember the numbers relevant to him.



In some circumstances, the pop-up menu cannot be opened. This is the case, for example, when the attributes display is open.



The pop-up menu can also be used in conjunction with multiple directories or files selected at the same time.

5.2 “File” menu

5.2.1

5.2.2

5.2.3

5.2.4 Archive

This function allows you to save important data to floppy disk. With Navigator, the user can see what is stored in these archives.

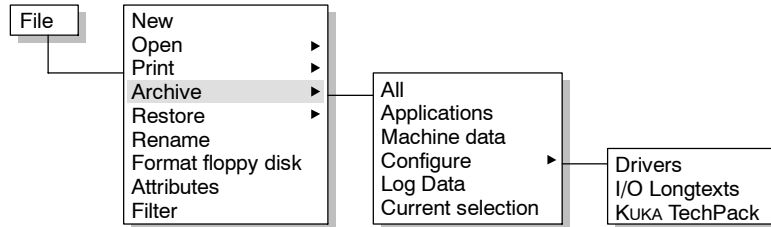

A request for confirmation is generated which must be answered before the saving process is carried out.

 Date Wednesday, 30 July 2003 15:35:36
 Source: FILEHANDLER No.: 35
 Do you really want to archive the selected file(s)?

The selected files are archived.

The selected files are not archived.



If you try to insert a file in an existing archive, the robot name is checked. The robot name in the archive is compared with the name that is set in the controller. If the two names are different, a request for confirmation is generated asking if you really wish to overwrite the existing archive.

 Date Monday, 4 August 2003 11:42:29
 Source: C3ARC No.: 0
 Wrong robot archive: Archive: RName System: Rob-1

The selected files are added to the archive.

The selected files are not added to the archive.

The status line of the Navigator indicates the current status:

 Date Wednesday, 30 July 2003 15:38:08
 Source: FILEHANDLER No.: 8
 Save files...

Time	no.	Source	Message
11:54:5		Navigator	Archiving completed

The archiving can be terminated at any time by pressing the "ESC" key or the softkey "Cancel".

5.2.5 Restore

This command allows you to restore archives.

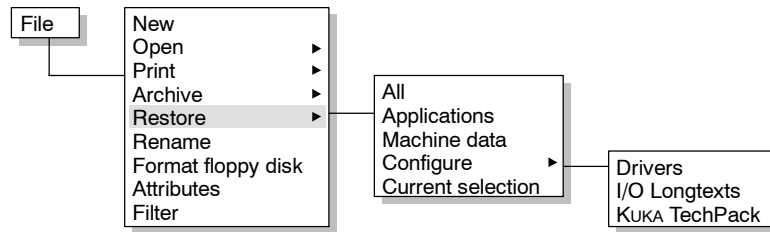

This function is particularly useful, for example, if programs on the hard disk have become damaged or if you wish to return a program to its original state after substantial changes have been made to it. The files on the hard disk are hereby overwritten. A request for confirmation is thus generated which must be answered before the files are restored.

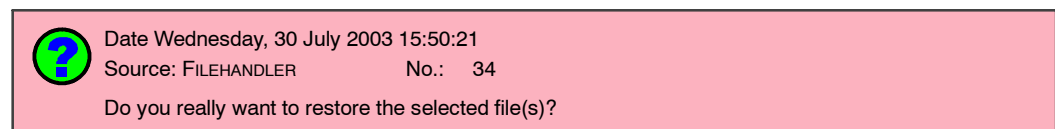

- The selected files are restored.
- None of the selected files is restored.

The action will then be displayed in the message window:

	Time	no.	Source	Message
	12:31	7	Navigator	Restore files...

After a short wait time the end of the operation is shown:

C...	Time	no.	Source	Message
	4:28:01 PM	31	FILE...	Restoring succeeded



In the event of a version conflict between the archive files and the system files, an error message is generated. Depending on the configuration, it may still be possible to copy the affected files.

5.2.5.1 All

All data, with the exception of log files, are loaded from the floppy disk back onto the hard disk.

```

“KRC:\”
“C:\KRC\Data\”
“C:\KRC\Roboter\Init\”
“C:\KRC\Roboter\IR_Spec\”
“C:\KRC\Roboter\Template\”

```

The I/O drivers are also reconfigured. The user interface is then reinitialized in order to update any changes, e.g. to the menu structure (MenueKeyUser.ini).

Depending on the configuration, the directory “R1”, including all files and subdirectories, can be deleted before the files are restored. The request for confirmation before the R1 directory is deleted also depends on the configuration. The directory structure and files are restored exactly as they were when they were originally archived.

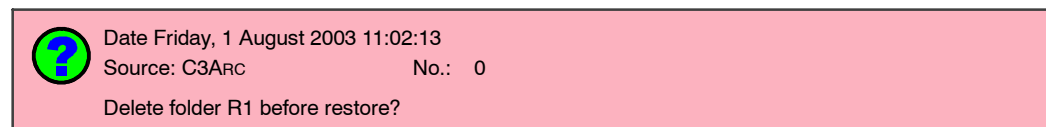

The directory “R1” is not deleted; the existing programs are overwritten individually during the restore function.

Before the files are restored, the directory “R1”, including all files and subdirectories, is deleted.



The menu command “Restr. All” in the softkey bar has the same function as the menu command “File” -> “Restore” -> “All”.

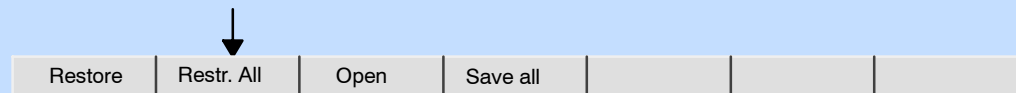

5.3 “Edit” menu

5.3.1

5.3.2

5.3.3

5.3.4

5.3.5

5.3.6

5.3.7

5.3.8 Cancel program

A program that has previously been selected, i.e. one that is ready for execution, can be canceled via the Navigator. A different program can then be loaded for editing.

5.3.9 Reset program

A program selected in the background can be reset via the Navigator. In this way the program can be brought back to the initial state it had immediately after it was loaded.

6 Executing, stopping and resetting a program

6.1

6.2 Program velocity (Programm override)



POV=100%

In some cases, e.g. when testing programs, it is of vital importance to reduce the velocity of the robot. The “Program override” function, for which a key can be found in the right-hand status key bar, can be used for this purpose. The value can be increased or decreased using the +/- key.



It is possible to alter the POV value not only in increments of 1%, but also directly between values of 1, 3, 10, 30, 50, 75 and 100 per cent.

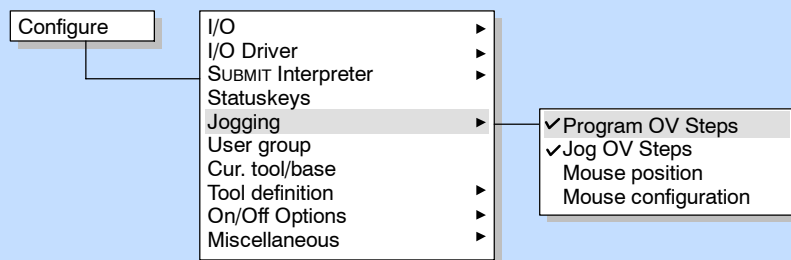

Depending on the configuration, the program override is automatically set to 10 percent when the mode selector switch is switched to “T2”. If the mode is changed back to “T1”, the last value used for “T1” is restored.

6.3 Stop reactions

6.3.1

6.3.2

6.3.3 Maximum braking

The robot is no longer on its path. This occurs if...

- an axis exceeds its command velocity or acceleration (the command velocity is lower in jog mode T1 than in T2 or automatic mode);
- a software limit switch has been reached or a command value has been exceeded.



In order to protect the brakes against overheating, the braking energy is calculated along with an associated cooling time. If the braking energy exceeds a certain value, the drives are locked and a status message is generated in the message window.

The message cannot be acknowledged until the motor brakes have cooled, and only then can the robot motion be resumed.

6.3.4 Short-circuit braking (dynamic braking)

The robot is no longer on its programmed path and may have left its positioning window. This occurs if...

- the Emergency Stop button has been pressed in jog mode (T1 or T2);
- there is an encoder error;
- the controller is switched off or there is a power failure;
- the line between DSE and RDC has been interrupted;



In the event of short-circuit braking or dynamic braking, the holding brakes of the individual axes are applied while the motion is still in progress. If this happens frequently while the robot is still moving it leads to significantly increased wear on the holding brakes.



In order to protect the brakes against overheating, the braking energy is calculated along with an associated cooling time. If the braking energy exceeds a certain value, the drives are locked and a status message is generated in the message window.

The message cannot be acknowledged until the motor brakes have cooled, and only then can the robot motion be resumed.

6.4 Manual program execution (jog mode)

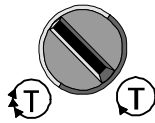

Select a program and set the mode selector switch to mode T1 or T2.



The robot can be moved manually and programs started only if there is no EMERGENCY STOP situation and – in the “Automatic” mode – the drives are switched on.

If the option “AutoAck” has been activated, all the acknowledgeable messages displayed are acknowledged the first time the Start key is pressed. These include all the actions which trigger the message “Active commands inhibited” (e.g. moving the robot with the jog keys or the Space Mouse).



Depending on the configuration, the program override is automatically set to 10 percent when the mode selector switch is switched to “T2”. If the mode is changed back to “T1”, the last value used for “T1” is restored.

6.4.1

6.4.2

6.4.3

6.4.4 Executing individual program lines

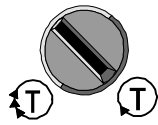

First of all, ensure that the mode selector switch is in the test mode position (T1 or T2).

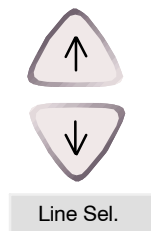

```

1  ;EXT EXAMPLE1 ( )
2  ;EXT EXAMPLE2 ( )
3  ;EXT EXAMPLE3 ( )
4
5  INIT
6  BASISTECH INI
7  CHECK HOME
8  PTP HOME Vel= 100 % DEFAULT
9  AUTOEXT INI
10 -----
11 Edit cursor
12
13 Block pointer (program pointer)
14
15 P00 (#EXT_PGNO,#PGNO_ACKN,DMY[,0] ) ; Reset Progr.No.-Request
16 ;EXAMPLE1 ( ) ; Call User-Program
17
18 CASE 2
19 P00 (#EXT_PGNO,#PGNO_ACKN,DMY[,0] ) ; Reset Progr.No.-Request
20 ;EXAMPLE2 ( ) ; Call User-Program
    
```

Ln 5, Col 0

Program execution starts at the line indicated by the block pointer on the left. For the purpose of selecting a particular block in the program, move the edit cursor to the desired program line with the aid of the arrow keys. Then press the softkey “Line Sel.”. The block pointer now jumps to the selected line.



Now start the program from the selected line. Press one of the enabling switches and the “Program start forwards” key. During program execution, the program pointer moves to the line that is currently being executed.



If the option “AutoAck” has been activated, all the acknowledgeable messages displayed are acknowledged the first time the Start key is pressed. These include all the actions which trigger the message “Active commands inhibited” (e.g. moving the robot with the jog keys or the Space Mouse).

The first program step usually consists of a “BCO run” and must be triggered by pressing an enabling switch and the Start key. When block coincidence is reached a corresponding message is generated. At the start of the actual program, release the Start key briefly and press it again.

	Ti...	Nr.	Src.	Message
!	12:56	1356	HPU	Start key required
!	12:56	1350		Programmed path reached (BCO)



The “Program start forwards” key must be held down while the robot is moving, otherwise the program will be interrupted.

6.5 Automatic program execution

In manufacturing processes, programs or program sections are often executed cyclically. For example, if the end of the program has been reached, the program can be executed again.



To start automatic program execution, select a program and then switch the robot drives on.



When a program is running, the menu commands “Configure” → “I/O Driver” → “I/O Driver Reset” and “I/O Reconfigure” cannot be executed.

6.5.1 BCO run

A BCO run is now necessary. Press the “Program start forwards” key.



If the option “AutoAck” has been activated, all the acknowledgeable messages displayed are acknowledged the first time the Start key is pressed. These include all the actions which trigger the message “Active commands inhibited” (e.g. moving the robot with the jog keys or the Space Mouse).

6.5.2 Complete program execution

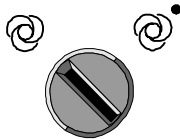

Set the mode selector switch to “Automatic” or “Automatic External” mode. The status line then changes for automatic mode as follows:

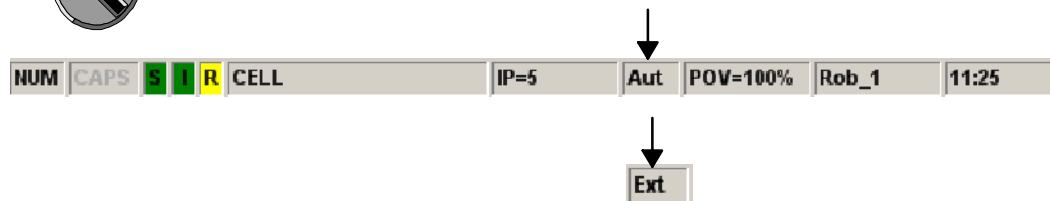

In “Automatic” mode, press the “Program start forwards” key.

In “Automatic External” mode, a PLC assumes control of the system.



6.5.3 Stopping program execution

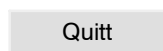

A program can be stopped by pressing the “Program stop” key. The program and the robot are then stopped.



In “Automatic External” mode, the acknowledgement message “Passive STOP” is displayed in the message window. This message must be acknowledged before the program can be resumed.

C...	Time	No.	Source	Message
	11:09:16	209		Passive STOP KCP
	11:09:16	1370	KCP	Passive STOP



If the drives of the robot have been switched off by means of the “Drives OFF” key, the robot stops and the brakes of the axes are engaged.

6.5.4 Continuing a program

 If the drives of the robot have been switched off by means of the “Drives OFF” key, the drives must first be switched on again before the program can be restarted. This is done by pressing the “Drives ON” key.

 In “Automatic” mode, press the “Program start forwards” key.

In “Automatic External” mode, a PLC assumes control of the system.



It may be necessary to carry out a BCO run at this point. This always takes place by the direct route from the current position to the end position. It is therefore important to make sure that there are no obstacles on this path in order to avoid damage to components, tools or the robot!

6.5.5 Resetting a program (Reset)

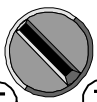
 If you wish to reset a program, ensure first of all that the mode selector switch is in the “T1”, “T2” or “Automatic” position

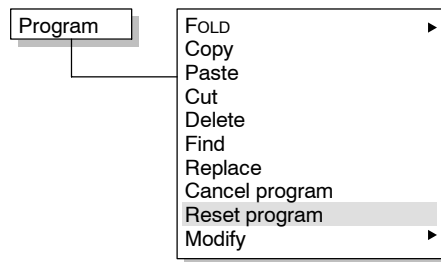

The yellow block pointer then jumps to the first instruction that can be executed in the indicated program. The selected program can subsequently be restarted.

```
1 → [NI]
2 PTP HOME Ve1= 100 % DEFAULT
3 PTP P1 Ve1= 100 % PDAT1
```

7 Monitor

7.1 Inputs/Outputs

7.1.1

7.1.2 Digital outputs

When this option has been selected, a status window is opened, displaying the signal states of the robot controller's inputs.

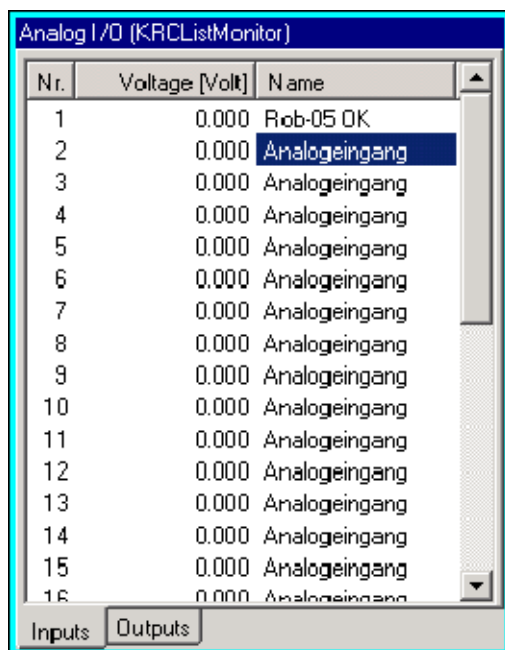

Nr.	Voltage [Volt]	Name
1	0.000	Rob-05 OK
2	0.000	Analogeingang
3	0.000	Analogeingang
4	0.000	Analogeingang
5	0.000	Analogeingang
6	0.000	Analogeingang
7	0.000	Analogeingang
8	0.000	Analogeingang
9	0.000	Analogeingang
10	0.000	Analogeingang
11	0.000	Analogeingang
12	0.000	Analogeingang
13	0.000	Analogeingang
14	0.000	Analogeingang
15	0.000	Analogeingang
16	0.000	Analogeingang

The input values (ranging from -10 V to +10 V) and their long texts are displayed in the boxes. The values of these inputs cannot be changed.

Tab + You can open the status window for displaying the 32 outputs using this softkey.

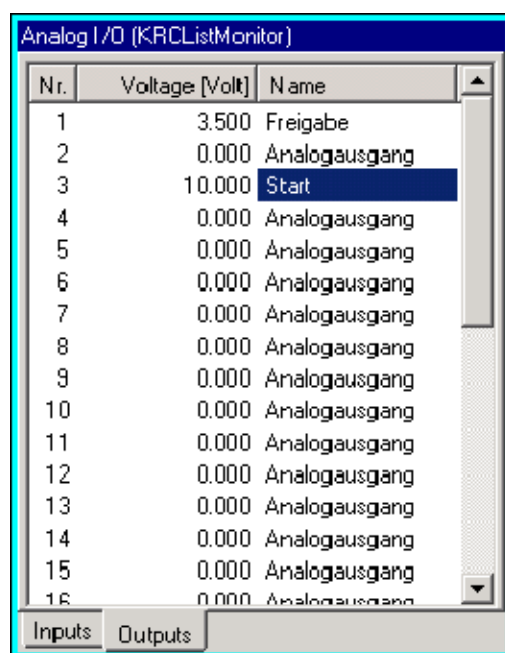

Nr.	Voltage [Volt]	Name
1	3.500	Freigabe
2	0.000	Analogausgang
3	10.000	Start
4	0.000	Analogausgang
5	0.000	Analogausgang
6	0.000	Analogausgang
7	0.000	Analogausgang
8	0.000	Analogausgang
9	0.000	Analogausgang
10	0.000	Analogausgang
11	0.000	Analogausgang
12	0.000	Analogausgang
13	0.000	Analogausgang
14	0.000	Analogausgang
15	0.000	Analogausgang
16	0.000	Analogausgang

The output values (ranging from -10 V to +10 V) and their long texts are displayed in the boxes.

Tab + You can return to the status window for displaying the 32 inputs by pressing the softkey "Tab+" again.



If the name of an input or output or the value of an output is selected using the arrow keys, it can be edited by pressing the Enter key.

Nr.	Voltage [Volt]	Name
1	3.500	Freigabe
2	0.000	Analogausgang
3	10.000	Start
4	0.000	Analogausgang
5	0.000	Analogausgang
6	0.000	Analogausgang
7	0.000	Analogausgang
8	0.000	Analogausgang
9	0.000	Analogausgang
10	0.000	Analogausgang
11	0.000	Analogausgang
12	0.000	Analogausgang
13	0.000	Analogausgang
14	0.000	Analogausgang
15	0.000	Analogausgang
16	0.000	Analogausgang

Inputs Outputs

Enter the new value by means of the keyboard or numeric keypad.



Accept the modified value by pressing the Enter key again.



Pressing "ESC" rejects the change and closes the status window.

7.2

7.3

7.4

7.5

7.6 Hardware Info

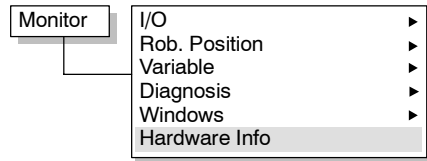

The operator can use the command Hardware Info to obtain further information about the individual components of the robot system.

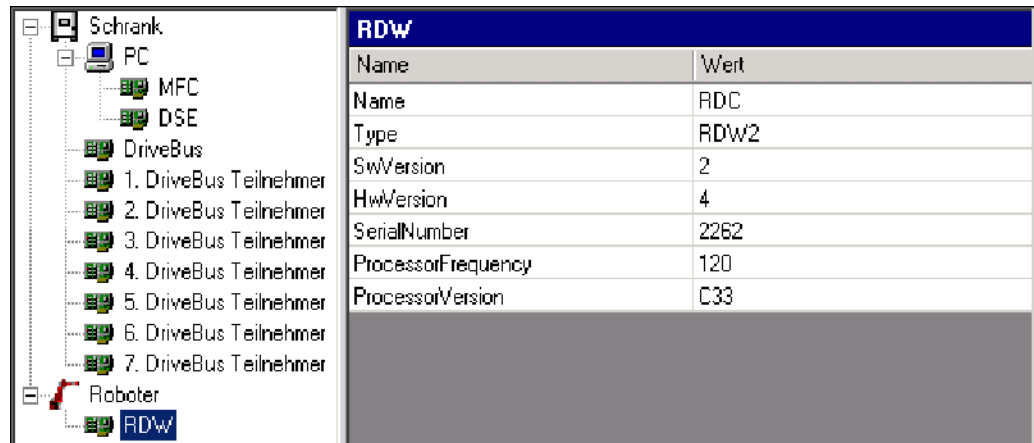

Refresh Refreshes the display.

Export Outputs the hardware information as an XML file.

Close Exits the "Hardware Info" display.

The following hardware components can be displayed:

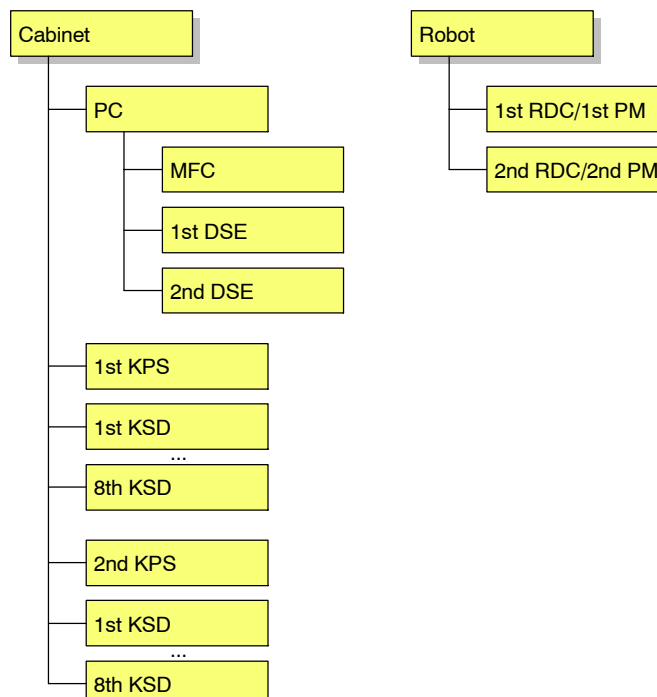

A

Archive, 19
Automatic program execution, 26

B

BASE coordinate system, 10
BCO run, 26

C

Continuing a program, 27
Coordinate systems, 10

D

Detail view, 17
Directory list, 17
Drives OFF, 26
Dynamic braking, 24

E

Edit, 21
“Edit” menu, 21
Enabling switches, 9
Executing program lines, 25
Executing, stopping and resetting a program, 23

F

File, 18
File list, 17
“File” menu, 18

G

Graphical user interface, 17

H

Header, 17

J

Jog mode, 24
Jog OV Steps, 16
Jog override, 16
Jogging the robot, 16
Joint coordinate system, 10

M

Manual program execution, 24
Maximum braking, 23
Mode selector switch, 8
Modules, 17
Monitor, 28

N

Navigator, 17

O

Operator control elements, 8

P

Program override, 23
Program velocity, 23

R

Reactivation, 6
Reset, 27
Reset program, 27
Restore, 20
Running up the controller, 5

S

Short-circuit braking, 24
Signal states, 28
Simultaneous motion, 10
Status line, 8
Stop reactions, 23
Stopping program execution, 26

T

TOOL coordinate system, 10

W

WORLD coordinate system, 10

X

X axis, 13

SOFTWARE

KR C2 / KR C3

Start-up

New Features

KUKA System Software (KSS) Release 5.2

Issued: 14 Jan 2004 Version: 00

© Copyright **KUKA Roboter GmbH**

This documentation or excerpts therefrom may not be reproduced or disclosed to third parties without the express permission of the publishers. Other functions not described in this documentation may be operable in the controller. The user has no claim to these functions, however, in the case of a replacement or service work.

We have checked the content of this documentation for conformity with the hardware and software described. Nevertheless, discrepancies cannot be precluded, for which reason we are not able to guarantee total conformity. The information in this documentation is checked on a regular basis, however, and necessary corrections will be incorporated in subsequent editions.

Subject to technical alterations without an effect on the function.

PD Interleaf

Contents

1	Robot mastering/unmastering	5
1.1	5
1.2	5
1.3	5
1.4	Save mastering data	5
1.5	Mastering the KR 3	6
1.5.1	Robot mastering	7
1.5.2	7
1.5.3	Alter factory mastering	7
1.6	Reference point mastering	8
2	9
3	9
4	Robot Data	10

1 Robot mastering/unmastering

1.1

1.2

1.3

1.4 Save mastering data

To prevent loss of mastering, it is possible to save the mastering data. Loss of mastering can occur, for example, in the event of a defective battery preventing the system from being shut down correctly (option "Battery monitoring").

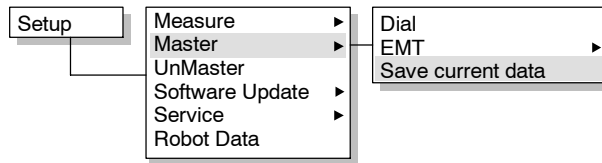

Once the mastering data have been saved a corresponding message is generated.

C...	Time	No.	Source	Message
!	11:12:25	1008		Controller booted
!	11:13:32	40	HMI	PowerOn finished.
!	11:20:19	2960		Current mastering data is saved.

1.5 Mastering the KR 3

On the robot type “KR 3”, mastering is carried out using the verniers only; these are installed on each axis.



The mastering procedure and mastering menu are completely different from those of the KR C1 and KR C2 versions. There is a total of three different commands available:

Command	Function
Robot mastering	Normal mastering
Commutation	Motor – encoder synchronization
SetupMasterSetRobotPos	First mastering



First of all, make sure that the operating mode “T1” and the option “Jog” are set.



This menu items “Commutation” and “Set robot position” are not available in the user group “User”.

1.5.1 Robot mastering

This command can be used to master the robot, provided that a first mastering (“Alter factory mastering”) has already been carried out.

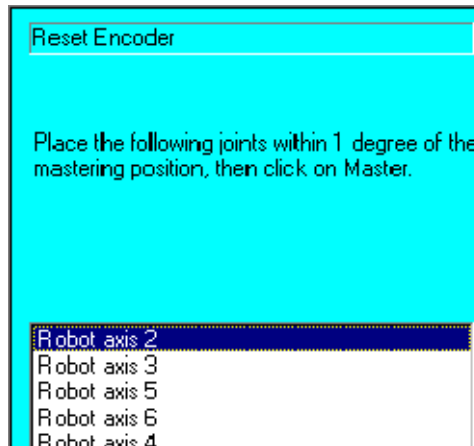
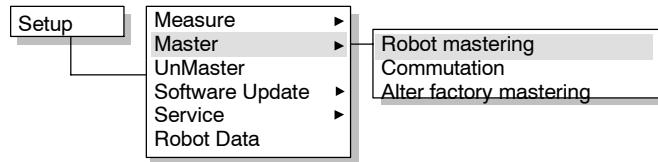

This causes the corresponding status window to be opened, in which the axes still to be mastered are displayed.



Axes that are already mastered are no longer listed and, if remastering is desired, must first be unmastered.

Then move the desired axis into the mastering position by bringing the respective vernier marks into alignment.

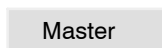

Then press the softkey “Master”. The entry for the corresponding axis is then removed from the status window.

1.5.2

1.5.3 Alter factory mastering

This command is used for first mastering of the KR 3. Since KUKA Roboter GmbH generally ships all robots with the first mastering already performed, this step is normally not necessary. It must be carried out, however, if an encoder or motor is exchanged.

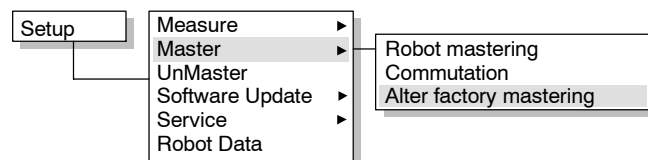

In order to carry out first mastering, the axis in question must first be unmastered; then execute the function “Commutation”.

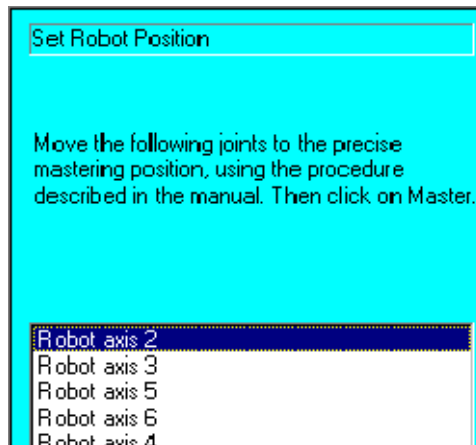

Move the axis to be mastered into the mastering position by bringing the vernier into alignment. Use a spirit level to check the exact position.

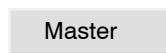

Then press the softkey "Master". The entry for the corresponding axis is then removed from the status window.

1.6 Reference point mastering

If a robot axis has an absolute encoder, reference point mastering is possible for this axis. The following mastering types are permissible here:

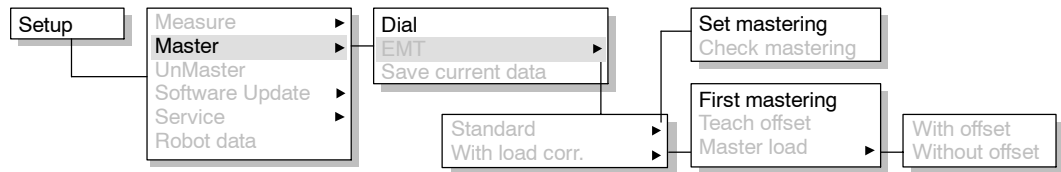

If at least one axis with an absolute encoder is unmastered, an additional status window for reference point mastering is displayed.

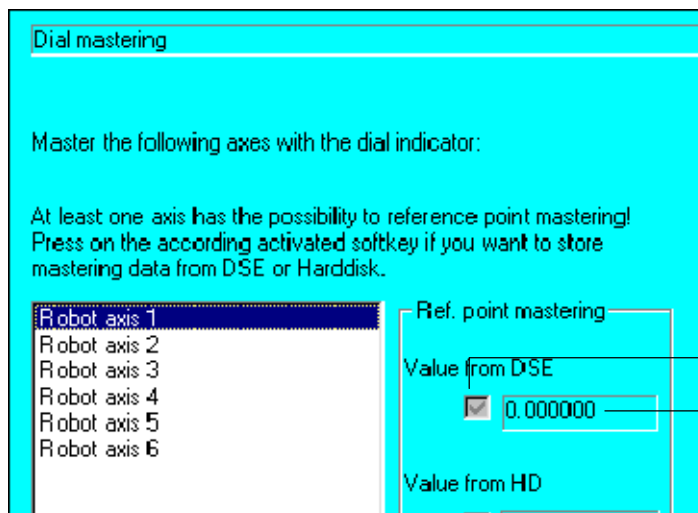

Availability

Displays the last value saved

The following options are offered in the softkey bar:

Start-up

Drive +	The two softkeys “Drive +” and “Drive -” are used to select the required master/slave drive.
Drive -	
DSE-Value	The data saved on the DSE are used for mastering.
HD-Value	The mastering file most recently saved to the hard drive is used.
Master	The robot is remastered using the dial gauge or EMT. The relevant procedures are described in the corresponding sections in this chapter.
Close	Reference point mastering is terminated using the softkey “Close”.

2

3

4 Robot Data

This option allows you to view the robot name, the serial number, the length of time the robot has been in operation and the machine data being used:

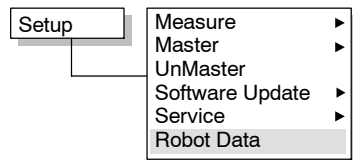

The following status window is opened:

 A screenshot of a 'Robot Data' status window. It contains four input fields: 'Robot Name' with the value 'Rob -1', 'Serial Number' with the value '12345', 'Runtime [Hours]' with the value '113.27', and 'Machine Data' with the value '#KR125_1 H C2 FLR ZH01'.

In the box "Robot name", a name can be entered for the connected robot that clearly identifies it.

For positionally accurate robots, the serial number is important. The program can thus establish whether the robot (RDC component) or the controller (DSE component) has been changed (e.g. use of the controller with another robot). The serial number can only be changed in the user group "Expert".

"Runtime" indicates the length of time the drives are switched on and the robot is under servo control. It is not possible to change the runtime value.

The machine data that are being used are indicated in the box "Machine data". It is similarly not possible to change the machine data.

PID Import Opens a file selection window for importing a PID file for a positionally accurate robot. This function is not available in the user group "User".

OK The changes are saved and the status window is closed. The current robot name is displayed in the status line.



Apply The changes are saved. If the robot name is changed, this is displayed in the status line.



Cancel Changes that have not been saved are rejected and the status window is closed.

If inconsistencies between the data on the RDC and those on the hard drive are discovered when the system is booted, a corresponding message is displayed. The robot cannot be moved as long as there is a data inconsistency.

Robot Data	
Robot Name	
Rob -1	
Serial Number	
RDC	Hard Disk
12345	45678
Runtime [Hours]	
RDC	Hard Disk
113.27	57.09
Machine Data	
#KR125_1 H C2 FLR ZH01	

The user must decide whether the RDC data are correct or those on the hard drive. This option is not available in the user group "User".



The RDC hardware is not designed for frequent write access.

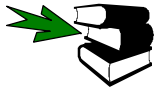

Information about saving the robot serial number in the RDC (Resolver-Digital Converter) and checking the serial number for the purposes of the correct assignment of robot and controller can be found in the **Electrical Servicing** handbook.



NOTES:

A

Absolute encoder, 7
Alter factory mastering, 6

D

DSE, 9

K

KR 3, 5

M

Mastering on the KR 3, 5

R

RDC, 9
Reference point mastering, 7
Robot data, 9
Robot mastering, 4, 6

S

Serial number, 9

SOFTWARE

KR C2 / KR C3

User Programming

New Features

KUKA System Software (KSS) Release 5.2

Issued: 14 Jan 2004 Version: 00

© Copyright **KUKA Roboter GmbH**

This documentation or excerpts therefrom may not be reproduced or disclosed to third parties without the express permission of the publishers. Other functions not described in this documentation may be operable in the controller. The user has no claim to these functions, however, in the case of a replacement or service work.

We have checked the content of this documentation for conformity with the hardware and software described. Nevertheless, discrepancies cannot be precluded, for which reason we are not able to guarantee total conformity. The information in this documentation is checked on a regular basis, however, and necessary corrections will be incorporated in subsequent editions.

Subject to technical alterations without an effect on the function.

PD Interleaf

Contents

1	4
2	Program commands	4
2.1	4
2.2	4
2.3	4
2.4	Logic	5
2.4.1	Wait functions	5
2.4.1.1	Time-dependent wait function (WAIT)	5
2.4.1.2	Signal-dependent wait function (WAIT FOR)	6

1

2 Program commands

This chapter is intended to provide an overview of the fundamentals of the program commands available, as well as their functions and the procedure for programming.



Further information on the Trigger command may be found in the **Programming Handbook**, in the main chapter **[Expert Programming]**, chapter **[Trigger]**.

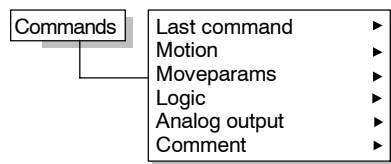

This chapter is intended to provide an overview of the fundamentals of the program commands available, as well as their functions and the procedure for programming.

Overview	
Last command	Instruction for entering the last command executed
Motion	Enables the programming of PTP, LIN and CIRC motions
Motion parameters	Programming of the torque monitoring
Logic	Programming of logic commands and wait times, path-dependent switching and pulse functions, setting or polling inputs and outputs
Analog output	Setting of analog outputs under program control
Comment	Used to insert comments in programs



The "Commands" menu is only available if a program has been selected or loaded in the editor.

Changes in a program are saved to the hard disk in the following situations:

- An inline form is closed by pressing the softkey "OK" or the Enter key;
- Point coordinates are saved by pressing the softkey "Touch Up";
- A line is inserted, deleted or modified in the program or editor;
- A line is exited in the editor by means of the arrow keys "↑" or "↓";
- A program is canceled or the editor is closed.

2.1

2.2

2.3

2.4 Logic

Inputs and outputs of the controller enable the robot system to communicate with its peripheral environment. Specific commands are provided for polling inputs and setting outputs.

It is also possible for wait times to be programmed in order to ensure that operations are completed before the robot starts moving again.

Programming

To program a so-called logic command, you must select a program or load it in the editor.



More detailed information on creating and altering programs can be found in the chapter [Program editing].



```

1  → INI
2  PTP HOME  Vel= 100 % DEFAULT
3  |
4  PTP HOME  Vel= 100 % DEFAULT
5  END

```

Pay attention to the position of the edit cursor.

The next program line created by you will be inserted as a new line after the cursor.

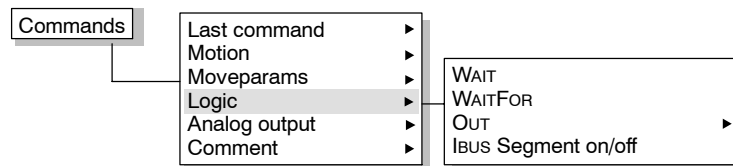

You can now make your selection from the logic instructions offered.

2.4.1 Wait functions

2.4.1.1 Time-dependent wait function (WAIT)

The WAIT function can be used to specify defined wait times.

The selection is made via

- the menu option "WAIT" or
- the softkey "Logic".

The following inline form is opened:

WAIT Time= sec

Enter the desired wait time using the numeric keypad.



You can alter the default wait time in increments of ± 0.05 seconds using this status key.

Cmd OK

Once this softkey has been pressed, the WAIT command is now fully programmed and saved.

Cancel command / functions

If other keys in the softkey bar are pressed, programming of the WAIT function is canceled and the following programming options are offered:

Cmd. Abort	Only cancellation of the programming (also possible using the “ESC” key). The command is not saved.
Motion	Motion commands
IBUS	Coupling/decoupling of an Interbus segment
Comment	Comment lines
WAIT FOR	Signal-dependent wait function

2.4.1.2 Signal-dependent wait function (WAIT FOR)

The WAIT FOR function allows the programming of a signal-dependent wait for a specified system variable (system list) or user-defined variable (user list).

These variables, called operands, can be linked together within a single command by means of logic operators and corresponding use of brackets.

The wait condition can be programmed, for example, in the following general form:

```
WAIT FOR (IN1 OR IN2 OR IN3) AND (NOT OUT1 OR OUT 2) OR NOT (FLAG1)
```

The following operators are available:

AND
OR
EXOR (exclusive OR)

They can be called by means of their corresponding softkeys.

The **NOT command** can also be entered by means of a separate softkey.

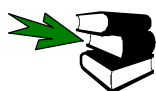

More detailed information on the use of operators can be found in the **Programming Handbook** in the documentation **Expert Programming**, chapter **[Variables and declarations]**.

The following lists are available for entering operands:

System list: The system variables \$IN, \$OUT, \$CYCFLAG, \$TIMER_FLAG and \$FLAG are available as standard in a window in the inline form. If long text names already exist, these are displayed together with the system variable, e.g.:

```
WAIT FOR (OUT 144 “adhesive_valve”).
```

User list: Further operands may be obtained from a list created beforehand by the user. In this case, it is possible, for example, to use more extensive expressions, such as:

```
WAIT FOR (USER_INT >=100) EXOR (USER_BOOL),
```

You can toggle between the two operand lists by pressing the corresponding softkeys.

System List

User List

This allows, for example, the programming of mixed expressions, such as:

```
WAIT FOR (USER_FIELD[COUNT-1]<>USER_INT) AND (NOT IN 17 “pressure_valve”)
```

Selection

When the WAIT FOR command is selected, via

- the menu option "WAIT FOR" or
- the softkeys "Logic" -> "WAIT FOR",

the following inline form is opened:



Entry

Corresponding parameters in the inline form are entered using the status key at the bottom right-hand side of the screen or by means of the softkey bar, the assignment of which adapts according to the position of the cursor.

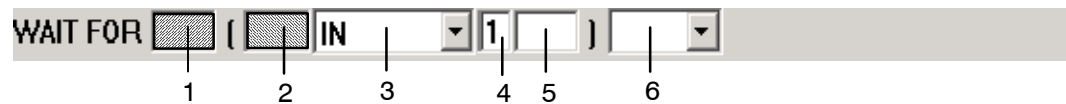

In particular, the double function of boxes 1 and 2 must be taken into consideration. Here it is possible not only to define the status of the operand, but also to set the brackets accordingly. This is dependent on the position of the cursor in the respective box.

Box	Function	Values	Remarks
1	Operand status	" " NOT	Softkey: AndTerm, OrTerm, ExOrTerm Insertion of an external logic operation. Softkey: Not Negation of the Boolean expression.
2	Operand status	" " NOT	Softkey: AndOp, OrOp, ExOrOp Insertion of an internal logic operation. Softkey: Not Negation of the Boolean expression.
3	Operand name	IN OUT CYCFLAG TIMER FLAG User variable	<u>System list:</u> \$IN[1] ... \$IN[1024] \$OUT[1] ... \$OUT[1024] \$CYCFLAG[1] ... \$CYCFLAG[32] \$TIMER_FLAG[1] ... \$TIMER_FLAG[16] \$FLAG[1] ... \$FLAG[1024] <u>User list:</u> It is possible to enter a user-defined name.
4	Operand no.	1 ... 1024	
5	Long text name	" " Existing name	By pressing the softkey "Long text", the long text name can be programmed in Expert mode with the system list activated.
6	Approximate positioning	" " CONT	Execution with advance run stop. Execution without advance run stop.

Cmd OK Once this softkey has been pressed, the command is now fully programmed and saved.

Positioning of brackets

In the inline form you can choose between two different types of bracketing:

- External logic operation: The operator is situated between the bracketed expressions.
Example: WAIT FOR (IN1) **AND** (IN2)
- Internal logic operation: The operator is situated inside a bracketed expression.
Example: WAIT FOR (IN1 **AND** IN2)

Mixed forms, such as WAIT FOR (IN1 **AND** IN2) **OR** (IN3) are possible.

A maximum of 12 operands can be linked in a form.



The logic operations cannot be nested. There is only **one** level of bracketing!

Insertion of an external logic operation: WAIT FOR (IN1) **AND** (IN2)

In the inline form illustrated, position the cursor in box 1.

WAIT FOR [] [] IN [] [] 2 [] [] [] []



The new expression is inserted at the cursor position.

AndTerm + Pressing the softkey expands the inline form as follows:

WAIT FOR [] [] ([] IN [] [] 1 []) AND [] [] ([] IN [] [] 2 []) [] []

If the cursor is moved to the positions indicated by the arrows, further external expressions can be inserted.

WAIT FOR [] [] ([] IN [] [] 1 []) AND [] [] ([] IN [] [] 2 []) [] []

Deletion of an external logic operation / change of operator:

If the cursor is situated in the operator box AND,

WAIT FOR [] [] ([] IN [] [] 1 []) AND [] [] ([] IN [] [] 2 []) [] []

the following options are displayed in the softkey bar:

Cmd. Abort		ToggleOp			Operator-	Cmd OK
------------	--	----------	--	--	-----------	--------

↑
Change of operator

↑
Deletion of logical operation

Insertion of an internal logic operation: WAIT FOR (IN1 AND IN2)

In the inline form, position the cursor in box 2.

WAIT FOR [] ([] IN [] 2 []) []



The new expression is inserted at the cursor position.

AndOp + Pressing the softkey expands the inline form as follows:

WAIT FOR [] ([] IN [] 1 [] AND [] IN [] 2 []) []

If the cursor is moved to the positions indicated by the arrows, further internal expressions can be inserted.

WAIT FOR [] ([] IN [] 1 [] AND [] IN [] 2 []) []

Deletion of an internal logic operation / change of operator:

If the cursor is situated in the operator box AND,

WAIT FOR [] ([] IN [] 1 [] AND [] IN [] 2 []) []

the following options are displayed in the softkey bar:

Cmd. Abort		ToggleOp		Operator-	Cmd OK
------------	--	----------	--	-----------	--------

↑
Change of operator

↑
Deletion of logical operation

User list

The user list allows you to use application-specific operands directly. These may include variables and other types of data object (functions, etc.) defined by the user in KRL.

The precondition is that these variables and/or functions have been defined and initialized in the control program.

Once the cursor is positioned in box 3 in the inline form,

WAIT FOR [] ([] IN [] 1 []) []

and the softkey is pressed,

User List you can select the desired variable.

The input situation changes, as illustrated in this example:

WAIT FOR [] ([] UserInt [] >=100 []) []

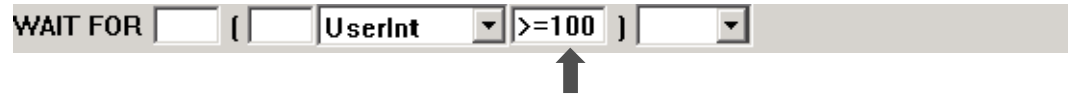

The numeric input box for the system list and the input box for the long text name are no longer present. Now, however, you can program complex relationships in the box indicated (see arrow) in which text can be entered freely.

The result of the user-specific variables together with the freely programmable box must always give a Boolean expression.

No user list available:

If it is not possible to access the user list, the following message appears:

Time	no.	Source	Message
19:40:38	C3FIL		No user entries defined

In this case, the corresponding user list must be created.

Create user list:

The user-specific list must be created in C:\KRC\ROBOTER\INIT\WAIT_USERLIST.INI.



Where possible, the syntax of the entries is checked as soon as the softkey "Cmd OK" is pressed. In the case of an incorrect entry, it is not possible to close the inline form. A corresponding message appears.

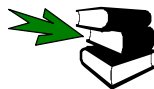

More detailed information can be found in the **Programming Handbook** in the documentation **Expert Programming**, chapter **[Variables and declarations]**.

Example of the entry of variables in the file WAIT_UserList.ini:

```

1 ;-----
2 ; KUKA Controls GmbH
3 ; APR 20, 2003
4 ; UserList Configuration - Extended WAIT FOR command
5 ;-----
6
7 [VERSION]
8 Version=1.0.0
9
10 [USERLIST]
11 Item1=UserInt
12 Item2=UserBoo1
13 Item3=Ghost_Ein()
14
15
16 [USERMONITOR]
17 MONITOR=TRUE
18
19 [END SECTION]

```

The entries Item1 ... Itemx must form an uninterrupted sequence. Entries after gaps will no longer be taken into consideration.

TRUE/FALSE can be used to activate/deactivate the syntax checking that is carried out when the inline form is closed.

E

Edit cursor, 5

L

Logic, 5

P

Programming, 5

W

WAIT, 5

WAIT FOR, 6

Wait functions, 5