

**Installation and Operating instructions for**

**CP29xx-0000**

**Multi-touch Control Panel with DVI/ USB Extended interface**

**CP29xx-0010**

**Multi-touch Control Panel with CP-Link 4 interface**

**Version: 1.9**

**Date: 2018-11-13**

**BECKHOFF**



# Table of contents

<b>1</b>	<b>Foreword</b>	<b>3</b>
1.1	Notes on the Documentation	3
1.1.1	Liability Conditions	3
1.1.2	Trademarks	3
1.1.3	Patent Pending	3
1.1.4	Copyright	3
1.1.5	State at Delivery	3
1.1.6	Delivery conditions	3
1.2	Description of safety symbols	4
1.3	Basic safety measures	5
1.4	Operator's obligation to exercise diligence	6
1.4.1	National regulations	6
1.4.2	Procedure in the event of a fault	6
1.4.3	Operator requirements	6
<b>2</b>	<b>Product Description</b>	<b>7</b>
2.1	Product overview	7
2.2	Appropriate Use	8
2.3	Access to the connectors	8
2.4	Interfaces CP29xx-0000	10
2.4.1	DVI-E Input (Digital Visual Interface-Extended) (X106)	10
2.4.2	USB-Extended Input (X 105)	10
2.4.3	USB in (X 104)	11
2.4.4	USB out (X 102, X 103)	11
2.4.5	Ground connection	11
2.4.6	Power Supply (X101)	11
2.5	Interfaces CP29xx-0010	12
2.5.1	CP-Link 4 Architecture Description	12
2.5.2	Interfaces	14
2.5.3	USB out (X 102, X 103)	14
2.5.4	CP-Link 4 Input (X104)	14
2.5.5	Power Supply (X101)	15
2.5.6	Ground connection	15
2.6	Connection Kits/ Connection Cables/Accessories	16
2.6.1	Connection Kits DVI-E/ USB-E connection for CP29xx-0000, optional	16
2.6.2	Accessories for CP29xx-0010, optional	16
2.6.3	Connecting cables for CP29xx-0010, optional	17
<b>3</b>	<b>Installation</b>	<b>18</b>

<b>3.1</b>	<b>Transport and Unpacking</b>	<b>18</b>
3.1.1	Transport	18
3.1.2	Unpacking	18
<b>4</b>	<b>Mounting</b>	<b>19</b>
4.1	Installation in the control cabinet	19
4.1.1	Preparation of the control cabinet	19
4.1.2	Installation in a control cabinet wall	19
4.1.3	Earthing measures	19
4.1.4	Mounting of the Control Panel	20
4.1.5	Fitting the power supply cable	21
4.2	Connecting the Control Panel	22
4.2.1	Connecting cables	22
4.2.2	Protective Earthing	22
<b>5</b>	<b>Operating Instructions</b>	<b>23</b>
5.1	Switching the Control Panel on and off	23
5.1.1	Switching on	23
5.1.2	Shutting down and switching off	23
5.2	Operation	23
5.3	Servicing and maintenance	24
5.3.1	Cleaning	24
5.3.2	Maintenance	24
5.4	Emergency procedures	24
5.5	Shutting down	24
5.5.1	Disposal	24
<b>6</b>	<b>Troubleshooting</b>	<b>25</b>
<b>7</b>	<b>Assembly dimensions</b>	<b>26</b>
<b>8</b>	<b>Technical Data</b>	<b>27</b>
<b>9</b>	<b>Appendix</b>	<b>28</b>
9.1	Beckhoff Support and Service	28
9.1.1	Beckhoff branches and partner companies	28
9.1.2	Beckhoff company headquarters	28
9.2	Approvals for USA and Canada	29
9.3	FCC Approvals for the United States of America	29
9.4	FCC Approval for Canada	29

# 1 Foreword

## 1.1 Notes on the Documentation

This description is only intended for the use of trained specialists in control and automation engineering who are familiar with the applicable national standards. It is essential that the following notes and explanations are followed when installing and commissioning these components.

The responsible staff must ensure that the application or use of the products described satisfy all the requirements for safety, including all the relevant laws, regulations, guidelines and standards.

### 1.1.1 Liability Conditions

The documentation has been prepared with care. The products described are, however, constantly under development. For that reason the documentation is not in every case checked for consistency with performance data, standards or other characteristics. In the event that it contains technical or editorial errors, we retain the right to make alterations at any time and without warning. No claims for the modification of products that have already been supplied may be made on the basis of the data, diagrams and descriptions in this documentation.

All pictures shown in the documentation are exemplary. Illustrated configurations can differ from standard.

### 1.1.2 Trademarks

Beckhoff<sup>®</sup>, TwinCAT<sup>®</sup>, EtherCAT<sup>®</sup>, EtherCAT P<sup>®</sup>, Safety over EtherCAT<sup>®</sup>, TwinSAFE<sup>®</sup>, XFC<sup>®</sup> and XTS<sup>®</sup> are registered trademarks of and licensed by Beckhoff Automation GmbH.

Other designations used in this publication may be trademarks whose use by third parties for their own purposes could violate the rights of the owners.

### 1.1.3 Patent Pending

The EtherCAT Technology is covered, including but not limited to the following patent applications and patents: EP1590927, EP1789857, DE102004044764, DE102007017835 with corresponding applications or registrations in various other countries.

The TwinCAT Technology is covered, including but not limited to the following patent applications and patents: EP0851348, US6167425 with corresponding applications or registrations in various other countries.

### 1.1.4 Copyright

© Beckhoff Automation GmbH & Co. KG.

The reproduction, distribution and utilization of this document as well as the communication of its contents to others without express authorization are prohibited. Offenders will be held liable for the payment of damages. All rights reserved in the event of the grant of a patent, utility model or design.

### 1.1.5 State at Delivery





All the components are supplied in particular hardware and software configurations appropriate for the application. Modifications to hardware or software configurations other than those described in the documentation are not permitted, and nullify the liability of Beckhoff Automation GmbH & Co. KG.

### 1.1.6 Delivery conditions

In addition, the general delivery conditions of the company Beckhoff Automation GmbH & Co. KG apply.

## 1.2 Description of safety symbols

The following safety symbols are used in this operating manual. They are intended to alert the reader to the associated safety instructions.

 <b>DANGER</b>	<b>Acute risk of injury!</b> If you <b>do not</b> adhere the safety advise adjoining this symbol, there is immediate danger to life and health of individuals!
 <b>WARNING</b>	<b>Risk of injury!</b> If you <b>do not</b> adhere the safety advise adjoining this symbol, there is danger to life and health of individuals!
 <b>CAUTION</b>	<b>Hazard to individuals!</b> If you <b>do not</b> adhere the safety advise adjoining this symbol, there is obvious hazard to individuals!
 <b>Attention</b>	<b>Hazard to devices and environment</b> If you <b>do not</b> adhere the notice adjoining this symbol, there is obvious hazard to materials and environment.
 <b>Note</b>	<b>Note or pointer</b> This symbol indicates information that contributes to better understanding.

## 1.3 Basic safety measures

Before the Industrial PC is switched off, software that is running must be properly closed. Otherwise it is possible that data on the storage medium is lost. Please read the section [Switching the Control Panel on and off](#).

 <b>Warning</b>	<b>Switch off all parts of the equipment, then uncouple the Control Panel</b>  Before opening the housing, and whenever the Control Panel is not being used for control purposes (such as during functional checks after a repair), all parts of the equipment must first be switched off, after which the Control Panel is to be disconnected from the equipment.
---	--

Disconnect the device by unplugging the connectors on the rear side of the Control Panel. Items of equipment that have been switched off must be secured against being switched on again.

 <b>Warning</b>	<b>Do not exchange any parts when under power</b>  When components are being fitted or removed, the supply voltage must be switched off.  Fitting work on the Control Panel can result in damage: <ul style="list-style-type: none"><li>• if metal objects such as screws or tools fall onto operating circuit boards</li><li>• if connecting cables internal to the Panel PC are removed or inserted during operation.</li></ul>
---	---

## 1.4 Operator's obligation to exercise diligence

The operator must ensure that

- the product is only used as intended (see chapter [Product Description](#))
- the product is in a sound condition and in working order during operation
- the product is operated, maintained and repaired only by suitably qualified and authorized personnel
- the personnel is instructed regularly about relevant occupational safety and environmental protection aspects, and is familiar with the operating manual and in particular the safety notes contained herein
- the operation manual is in good condition and complete, and always available for reference at the location of the product.

 <b>Note</b>	<b>Do not open the housing of the Control Panel!</b> For technical support contact <a href="#">Beckhoff Service</a> .
--	--

### 1.4.1 National regulations

Depending on the type of machine and plant in which the Control Panel is used, national regulations governing the controllers of such machines will apply, and must be observed by the operator. These regulations cover, amongst other things, the intervals between inspections of the controller. The operator must initiate such inspections in good time.

### 1.4.2 Procedure in the event of a fault

In the event of faults at the Control Panel, the list in the section [Troubleshooting](#) can be used to determine the measures to be taken.

### 1.4.3 Operator requirements

Anyone who uses the Control Panel must have read these operating instructions and must be familiar with all the functions of the software installed on the Industrial PC to which he has access.



## 2 Product Description

### 2.1 Product overview

Front view of CP29xx



The new Beckhoff panel generation with industry-standard multi-touch display offers a feature-laden solution for any application. The wide selection of models offers different display sizes and formats as well as custom designs. Even for single-touch users, this new panel generation offers an excellent price-to-performance ratio and represents an economical alternative to other systems.

The multi-touch built-in Control Panel offer the following benefits:

- display sizes from 7-inch to 24-inch (16:9, 5:4, 4:3), landscape and portrait orientation
- multi-touch (PCT): e.g. for 5-finger or 2-hand touch operation
- high touch-point density for safe operation
- aluminium housing with glass front, front side IP65, rear side IP20
- CP29xx-0000 with integrated DVI/USB extension technology:
  - DVI-E and USB-E 2.0 enable remote panel operation at a distance of up to 50 m from the PC
  - USB-E 2.0 transmits USB 2.0 with 480 Mbit/s
  - DVI-E input is compatible to the standard DVI output of a PC
- CP29xx-0010 with CP-Link 4 technology:
  - enables remote panel operation at a distance of up to 100 m from the PC via a CAT.6<sub>a</sub> cable
  - integrated or separate 24 V DC power supply
  - CP-Link 4 transmits USB 2.0 with 100 MBit/s
- 2-port USB socket inside the Control Panel backplane
- optional electromechanical push-button extension.

## 2.2 Appropriate Use

The multi-touch built-in Control Panel CP29xx is designed for industrial application in machine and plant engineering. A multi-touch display is accommodated in a stainless steel housing. The Control Panel is installed in the front of control cabinets.

The DVI/USB extension technology integrated in the CP29xx-0000 Control Panel enables remote Panel operation at a distance of up to 50 m from the PC via a standard cable.

The CP-Link 4 connection technology integrated in the CP29xx-0010 Control Panel enables remote panel operation at a distance of up to 100 m from the PC via a CAT.6<sub>A</sub> cable with integrated or separate 24 V DC power supply depending on the transmitter module.

 <b>Danger</b>	<b>Risk of explosion!</b> The Control Panel must not be used where there is a risk of explosion.
--	---

## 2.3 Access to the connectors

The connectors of the Control Panel are located at the rear side of the housing.

### Connection block CP29xx-0000



For the pin assignment see chapter [Interfaces CP29xx-0000](#).

## Connection block CP29xx-0010



For the pin assignment see chapter [Interfaces CP29xx-0010](#).

## 2.4 Interfaces CP29xx-0000

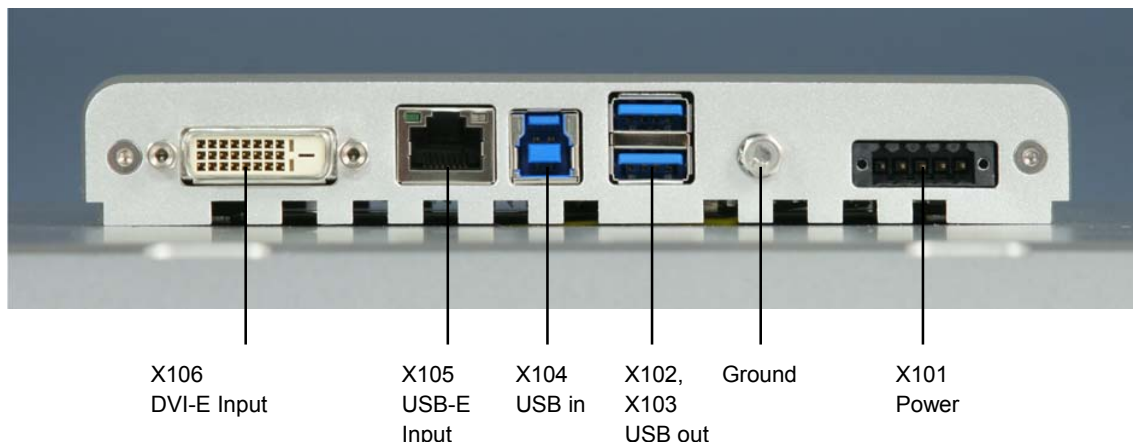

### 2.4.1 DVI-E Input (Digital Visual Interface-Extended) (X106)



#### X106

DVI-D 3 X 8-pole digital PCB installation (MOLEX 74320-9000 / 74320-9004)

The DVI-E connection (**X 106**) is used for transferring the video signal from the Industrial PC to the Control Panel.

The graphics signal is transferred directly via a DVI cable over a distance of 50 m max. Such a cable length leads to strong distortion of the graphics signal on arrival at the Control Panel. The CP29xx Control Panel features a signal processor that restores the DVI signal. The PC requires a conventional DVI output.

Pin	Signal	Pin	Signal
1	Rx2-	13	Rx3+
2	Rx2-	14	+ 5V DVI
3	GND	15	GND
4	Rx4-	16	HPD
5	Rx4+	17	Rx0-
6	DDC CLK	18	Rx0+
7	DDC DAT	19	GND
8	AV SYNC	20	Rx5-
9	Rx1-	21	Rx5+
10	Rx1+	22	GND
11	GND	23	RxC+
12	Rx3-	24	RxC-

### 2.4.2 USB-Extended Input (X 105)



#### X105

Connection via standard-RJ45-cabel, not crossed

The Control Panel is connected with the CU8801 USB to USB extended converter box via the USB-Extended input (**X 105**).

In order to realize a distance of 50 m without hubs, with USB extended the USB signal is converted so that it can be transferred via 50 m CAT5 cables commonly used for Ethernet wiring. In the Control Panel the signal is converted back to USB.

### 2.4.3 USB in (X 104)



#### X104

USB type B, PCB installation (FCI 61729-0010B USB Receptacle B-Type)

The Control Panel is connected with the Industrial PC via the USB port (**X 104**, connector type B). USB3.0 standard is supported.

Pin	Signal	Pin	Signal
1	5V	3	D+
2	D-	4	GND

### 2.4.4 USB out (X 102, X 103)



#### X102, X103

USB Type-A twin circuit board mounting (FCI 72309-0030B USB Double Receptacle A-Type)

The two USB interfaces (**X102, X103**, connector type A) are used for connecting peripheral devices with USB connection. USB3.0 standard is supported in a distance of up to 3 m from the PC, from a distance of 3 m up to 50 m or if using USB-Extended, USB2.0 standard is supported.

Pin	Signal	Pin	Signal
1	5V	3	D+
2	D-	4	GND

### 2.4.5 Ground connection

The Control Panel is grounded via the screw connection (**Ground**).

 <b>Note</b>	<p><b>Malfunction possible with missing ground connection</b></p> <p>A proper ground connection of the device is absolutely necessary for the correct function of the touchscreen.</p>
--	--

### 2.4.6 Power Supply (X101)



#### X101

Socket 5-pol RM3.50 Sw Screw Clamp BL3.5/180F (WEIDMÜLLER 1615810000)

The power supply for the Control Panel is established via the socket (**X101**). The power supply connector is included in delivery.

Pin	Signal	Pin	Signal
1	NC	4	GND
2	NC	5	+ 24 V <sub>DC</sub>
3			

Power Supply

## 2.5 Interfaces CP29xx-0010

### 2.5.1 CP-Link 4 Architecture Description

#### 2.5.1.1 CP-Link 4 – The Two Cable Display Link

The CP29xx-0010 multi-touch panels can be operated up to 100 m away from the PC. CP-Link 4 transfers DVI and USB together via a CAT.6<sub>A</sub> cable. The CU8802 CP-Link 4 transmitter box is connected to the PC via DVI and USB, or else the C9900-E276 PCIe module for CP-Link 4 is installed in the PC.

#### CP-Link 4 – The Two Cable Display Link via the CU8802 transmitter box

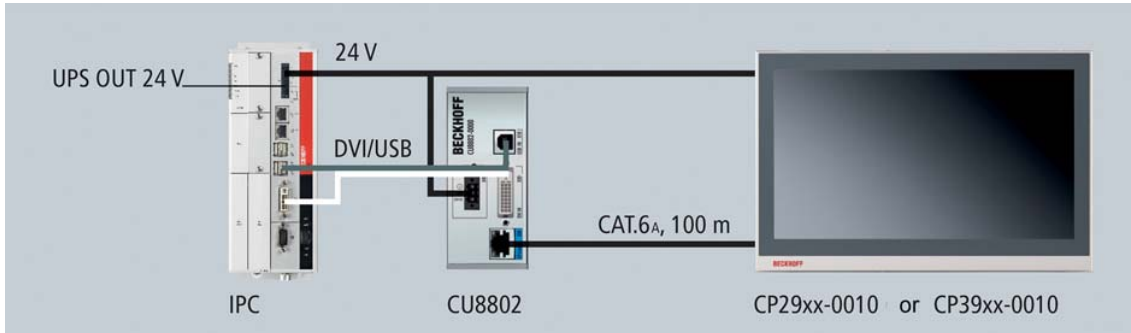

#### CP-Link 4 – The Two Cable Display Link via the C9900-E276 PCIe module

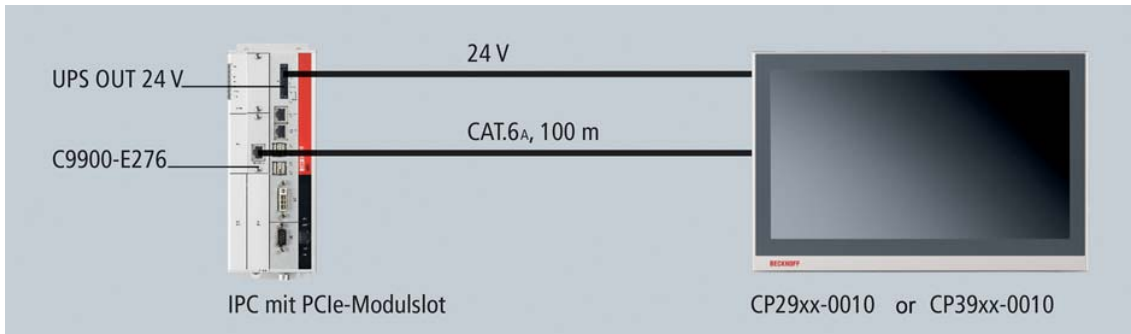

**2.5.1.2 CP-Link 4 – The One Cable Display Link**

The power supply for the Control Panel can also be provided via CP-Link 4. The CU8803 CP-Link 4 transmitter box is used instead of the CU8802 or the PCIe module. The Control Panel remains unchanged. The CU8803 sender box provides power to the Control Panel via the CAT.6<sub>A</sub> cable, which also transfers DVI and USB. The power supply socket of the panel is not used.

 <b>Attention</b>	<p><b>Don't connect power supply socket if using One Cable technology</b></p> <p>If using the CP-Link 4 - One Cable Display Link technology, do not connect anything to the power supply socket of the Panel.</p>
---	---

**CP-Link 4 – The One Cable Display Link via the CU8803 transmitter box**

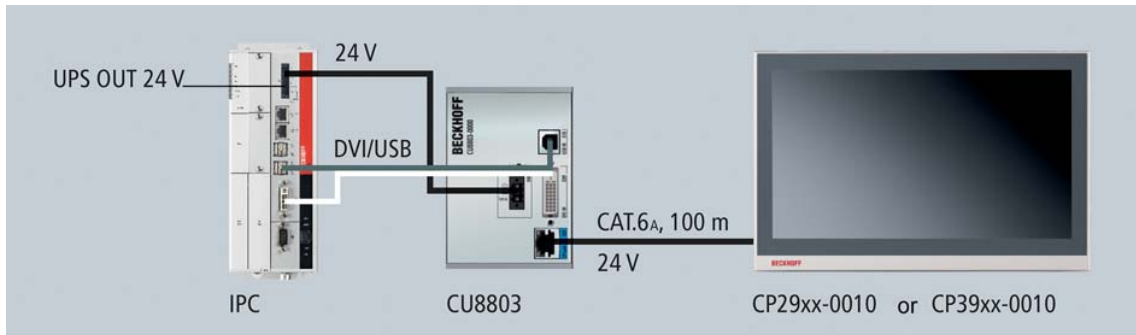

## 2.5.2 Interfaces

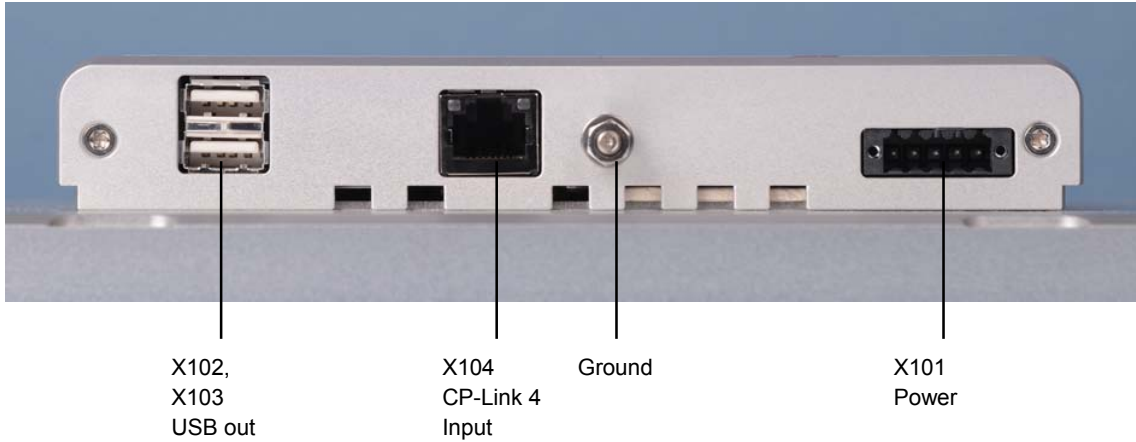

### 2.5.3 USB out (X 102, X 103)



#### X102, X103

USB Type-A twin circuit board mounting (FCI 72309-0030B USB Double Receptacle A-Type)

The two USB interfaces (**X102, X103**, connector type A) are used for connecting peripheral devices with USB connection. USB2.0 standard is supported.

Pin	Signal	Pin	Signal
1	5V	3	D+
2	D-	4	GND

### 2.5.4 CP-Link 4 Input (X104)



#### X104

BA 1x8pole RJ45 Invers shield 2XLWL Lp-mount. Molex Nr: 43860-0016 Modular Jack

The Control Panel is connected with the PCIe module slot of the Industrial PC or the transmitter box CU8802/ CU8803 via the CP-Link 4 Input (**X 104**).

Pin	Signal	Pin	Signal
1	CP-Link4_0P	5	CP-Link4_2N
2	CP-Link4_0N	6	CP-Link4_1N
3	CP-Link4_1P	7	CP-Link4_3P
4	CP-Link4_2P	8	CP-Link4_3N

 <b>Attention</b>	<p><b>CU8803-0000 disconnect power supply</b></p> <p>If using the CP-Link 4 - One Cable Display Link, the 24 V power supply of the CP-Link 4 transmitter box must be switched off before disconnecting the CP-Link 4 output connection.</p>
---	---



 <b>Note</b>	<p><b>CP-Link 4 cables with above 60 m cable-length with ferrite core</b></p> <p>CP-Link 4 cables with above 60 m cable-length are fitted with a ferrite core at one end. If connecting the cable make sure to plug in the cable as shown in the picture with the ferrite core Control Panel-sided.</p>
--	---

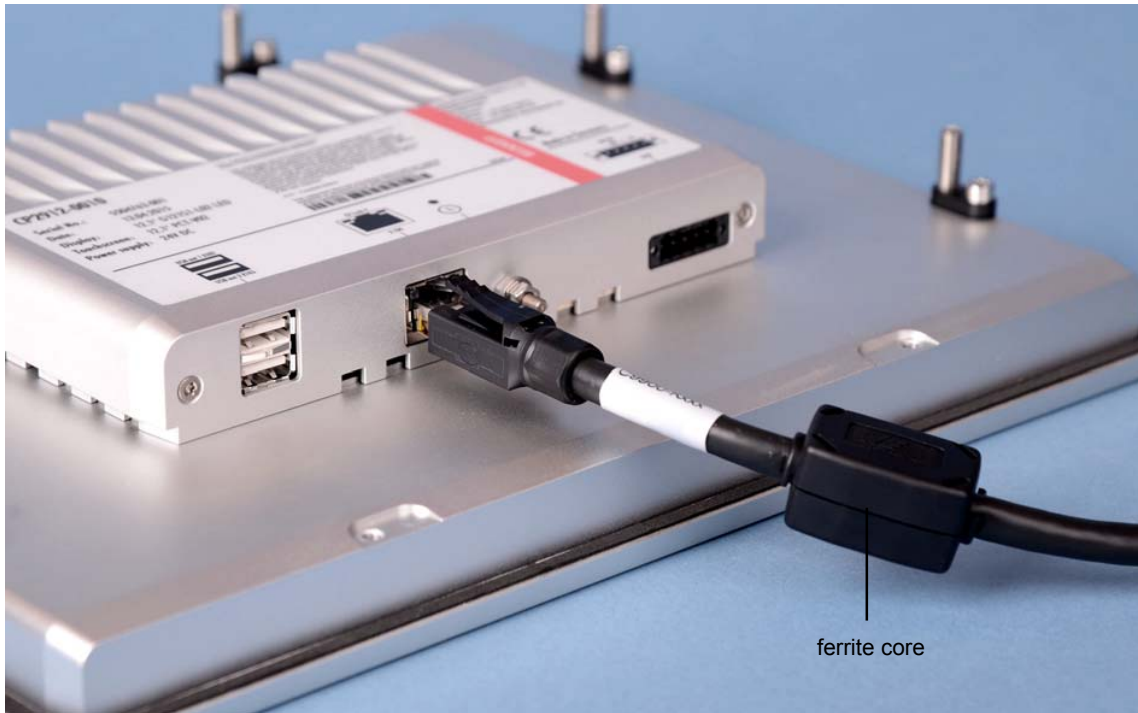

CP-Link 4 cable connection

### 2.5.5 Power Supply (X101)



**X101**

Socket 5-pol RM3.50 Sw Screw Clamp BL3.5/180F (WEIDMÜLLER 1615810000)

The optional power supply for the Control Panel is established via the socket (**X101**), see chapter [CP-Link 4 Architecture Description](#). The power supply connector is included in delivery.

Pin	Signal	Pin	Signal	
1	NC	4	GND	Power Supply
2	NC	5	+ 24 V <sub>DC</sub>	
3	⊕			

 <b>Attention</b>	<p><b>Don't connect power supply socket if using One Cable technology</b></p> <p>If using the CP-Link 4 - One Cable Display Link technology, do not connect anything to the power supply socket of the Panel.</p>
---	---

### 2.5.6 Ground connection

The Control Panel is grounded via the screw connection (**Ground**).

 <b>Note</b>	<p><b>Malfunction possible with missing ground connection</b></p> <p>A proper ground connection of the device is absolutely necessary for the correct function of the touchscreen.</p>
--	--

## 2.6 Connection Kits/ Connection Cables/Accessories

One 5-pole power supply connector is provided with the Control Panel.

Optionally prefabricated connection kits for the DVI-E/ USB-E connection are available.

### 2.6.1 Connection Kits DVI-E/ USB-E connection for CP29xx-0000, optional

The following connection kits are available:

Connecting kit	DVI-E/ USB-E Connection
C9900-K622	<b>Connecting kit 1 m for CP29xx, containing:</b> 1 m DVI cable, 1 m USB cable
C9900-K623	<b>Connecting kit 3 m for CP29xx, containing:</b> 3 m DVI cable, 3 m USB cable
C9900-K624	<b>Connecting kit 5 m for CP29xx, containing:</b> 5 m DVI cable, 5 m USB cable
C9900-K625	<b>Connecting kit 10 m for CP29xx, containing:</b> 10 m DVI cable, 10 m CAT 5 cable for USB-E-2.0, USB to USB-E-2.0 converter CU8801 for mounting rail installation close to the PC and 1 m USB cable to connect the USB to USB-E-2.0 converter to the PC
C9900-K626	<b>Connecting kit 20 m for CP29xx, containing:</b> 20 m DVI cable, 20 m CAT 5 cable for USB-E-2.0, USB to USB-E-2.0 converter CU8801 for mounting rail installation close to the PC and 1 m USB cable to connect the USB to USB-E-2.0 converter to the PC
C9900-K627	<b>Connecting kit 30 m for CP29xx, containing:</b> 30 m DVI cable, 30 m CAT 5 cable for USB-E-2.0, USB to USB-E-2.0 converter CU8801 for mounting rail installation close to the PC and 1 m USB cable to connect the USB to USB-E-2.0 converter to the PC
C9900-K628	<b>Connecting kit 40 m for CP29xx, containing:</b> 40 m DVI cable, 40 m CAT 5 cable for USB-E-2.0, USB to USB-E-2.0 converter CU8801 for mounting rail installation close to the PC and 1 m USB cable to connect the USB to USB-E-2.0 converter to the PC
C9900-K629	<b>Connecting kit 50 m for CP29xx, containing:</b> 50 m DVI cable, 50 m CAT 5 cable for USB-E-2.0, USB to USB-E-2.0 converter CU8801 for mounting rail installation close to the PC and 1 m USB cable to connect the USB to USB-E-2.0 converter to the PC

### 2.6.2 Accessories for CP29xx-0010, optional

The following accessories are available:

Accessories	for CP-Link 4
CU8802-0000	<b>Transmitter box for CP-Link 4 – The Two Cable Display Link</b> CP-Link 4 Extender Tx for connecting a Control Panel with CP-Link 4 interface CP29xx-0010 or CP39xx-0010
CU8803-0000	<b>Transmitter box for CP-Link 4 – The One Cable Display Link</b> CP-Link 4 Extender Tx for connecting a Control Panel with CP-Link 4 interface CP29xx-0010 or CP39xx-0010
C9900-E276	<b>PCIe module for CP-Link 4 – The Two Cable Display Link</b> CP-Link 4 Extender Tx PCIe module

### 2.6.3 Connecting cables for CP29xx-0010, optional

The following connection cables are available:

Accessories	Cable for CU880x
C9900-K671	Connecting cable RJ45 CAT.6 <sub>A</sub> , 3 m
C9900-K672	Connecting cable RJ45 CAT.6 <sub>A</sub> , 5 m
C9900-K673	Connecting cable RJ45 CAT.6 <sub>A</sub> , 10 m
C9900-K674	Connecting cable RJ45 CAT.6 <sub>A</sub> , 20 m
C9900-K675	Connecting cable RJ45 CAT.6 <sub>A</sub> , 30 m
C9900-K676	Connecting cable RJ45 CAT.6 <sub>A</sub> , 40 m
C9900-K677	Connecting cable RJ45 CAT.6 <sub>A</sub> , 50 m
C9900-K678	Connecting cable RJ45 CAT.6 <sub>A</sub> , 60 m
C9900-K679	Connecting cable RJ45 CAT.6 <sub>A</sub> , 70 m
C9900-K680	Connecting cable RJ45 CAT.6 <sub>A</sub> , 80 m
C9900-K681	Connecting cable RJ45 CAT.6 <sub>A</sub> , 90 m
C9900-K682	Connecting cable RJ45 CAT.6 <sub>A</sub> , 100 m
C9900-K725	Connecting cable RJ45 CAT.6 <sub>A</sub> , 3 m, suitable as trailing cable
C9900-K713	Connecting cable RJ45 CAT.6 <sub>A</sub> , 5 m, suitable as trailing cable
C9900-K714	Connecting cable RJ45 CAT.6 <sub>A</sub> , 10 m, suitable as trailing cable
C9900-K715	Connecting cable RJ45 CAT.6 <sub>A</sub> , 20 m, suitable as trailing cable
C9900-K716	Connecting cable RJ45 CAT.6 <sub>A</sub> , 30 m, suitable as trailing cable
C9900-K717	Connecting cable RJ45 CAT.6 <sub>A</sub> , 40 m, suitable as trailing cable
C9900-K718	Connecting cable RJ45 CAT.6 <sub>A</sub> , 50 m, suitable as trailing cable
C9900-K719	Connecting cable RJ45 CAT.6 <sub>A</sub> , 60 m, suitable as trailing cable
C9900-K720	Connecting cable RJ45 CAT.6 <sub>A</sub> , 70 m, suitable as trailing cable
C9900-K721	Connecting cable RJ45 CAT.6 <sub>A</sub> , 80 m, suitable as trailing cable

## 3 Installation

### 3.1 Transport and Unpacking

The specified storage conditions must be observed (see chapter [Technical Data](#)).

#### 3.1.1 Transport

Despite the robust design of the unit, the components are sensitive to strong vibrations and impacts. During transport, your Control Panel should therefore be protected from excessive mechanical stress. Therefore, please use the original packaging.

 <b>Attention</b>	<b>Danger of damage to the unit</b> If the device is transported in cold weather or is exposed to extreme variations in temperature, make sure that moisture (condensation) does not form on or inside the device.
---	---

Prior to operation, the unit must be allowed to slowly adjust to room temperature. Should condensation occur, a delay time of approximately 12 hours must be allowed before the unit is switched on.

#### 3.1.2 Unpacking

Proceed as follows to unpack the unit:

1. Remove packaging.
2. Do not discard the original packaging. Keep it for future relocation.
3. Check the delivery for completeness by comparing it with your order.
4. Please keep the associated paperwork. It contains important information for handling the unit.
5. Check the contents for visible shipping damage.

If you notice any shipping damage or inconsistencies between the contents and your order, you should notify Beckhoff Service.

## 4 Mounting

The Control Panel CP29xx is designed for mounting in control cabinets in machine and plant engineering applications. The ambient conditions specified for operation must be observed (see chapter [Technical Data](#)).

### 4.1 Installation in the control cabinet

#### 4.1.1 Preparation of the control cabinet

The control cabinet wall must be prepared with the required mounting opening according to the Control Panel's dimensions (see chapter [Assembly dimensions](#)).

 <b>Note</b>	<p><b>Circulation of air</b></p> <p>When the unit is installed in an enclosure, adequate space for ventilation must be provided.</p> <p>The clearance above and below the housing must be at least 5 cm in order to ensure adequate ventilation of the Control Panel.</p>
--	---

Please note the following points during installation of the Control Panel:

- Position the Control Panel in such a way that reflections on the screen are avoided as far as possible.
- Use the position of the screen as a guide for the correct installation height; it should be optimally visible for the user at all times.
- The Control Panel should not be exposed to direct sunlight.
- When the unit is in its mounting position, the ventilation openings must not be obstructed.

 <b>Attention</b>	<p><b>Avoid extreme environmental conditions</b></p> <p>Extreme environmental conditions should be avoided as far as possible. Protect the Control Panel from dust, moisture and heat.</p> <p>The ventilation slots of the Control Panel must not be covered.</p>
---	---

#### 4.1.2 Installation in a control cabinet wall

For installation of the Control Panel proceed as follows:

1. Insert the Control Panel at the intended control cabinet wall position and protect it from falling out, prior to final mounting.
2. Release the clamping levers, turn the clamping levers to the side and retighten the screws (see chapter [Mounting of the Control Panel](#)).

#### 4.1.3 Earthing measures

Earthing connections dissipate interference from external power supply cables, signal cables or cables to peripheral equipment. Establish a low-impedance connection from the earthing point on the Control Panel housing (see chapter [Ground connection](#)) to the central earthing point on the control cabinet wall, in which the Panel is being installed.

 <b>Note</b>	<p><b>Malfunction possible with missing ground connection</b></p> <p>A proper ground connection of the device is absolutely necessary for the correct function of the touchscreen.</p>
--	--

#### 4.1.4 Mounting of the Control Panel

The Control Panel is installed in the cabinet wall with clamping levers. For the cutout dimension of the Control Panel see chapter [Assembly dimensions](#), the wall thickness is between 1 mm and 5 mm.



1. Insert the Control Panel into the cutout.
2. Release the clamping levers with a 3.0 mm Allen key.
3. Turn the clamping levers to the side through 90°.
4. Retighten the screws.

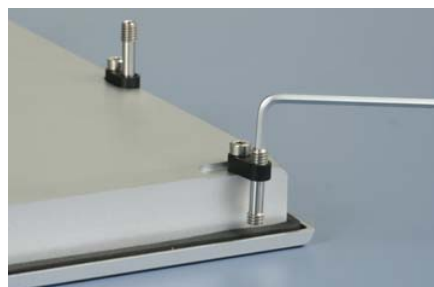
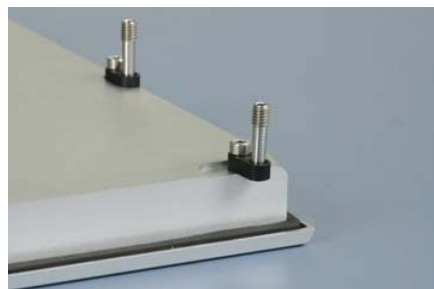
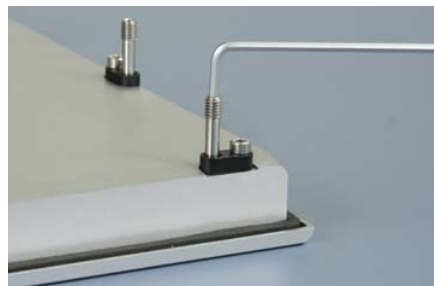

### 4.1.5 Fitting the power supply cable

Fit the cables for the power supply of the Control Panel, using the included material for assembling the connectors:

#### Material for assembling the connector

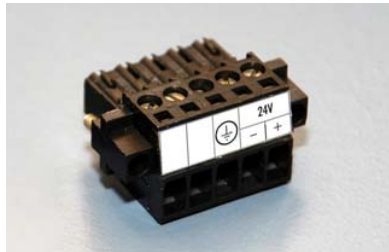

Plug connector 5-pole

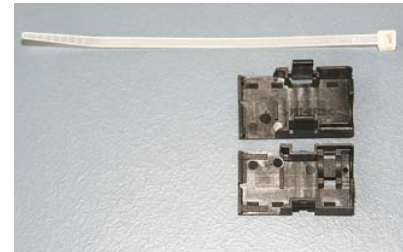

Stain relief housing with lacing cord

 <b>Note</b>	<p><b>Conductive cross-section</b></p> <p>The connector is specified for 16 A and can lift conductive cross-sections until 1.5 mm<sup>2</sup>.</p>
--	--

#### So the connector is fitted to the cable

1. Strip insulation from the cable ends (Length of stripped conductor is 8 - 9 mm).
2. Screw together the cable ends in the 5-pole plug connector in accordance with wiring diagram.

#### Applying the strain relief

Thread the lacing cord into that lower part of the stain relief housing.

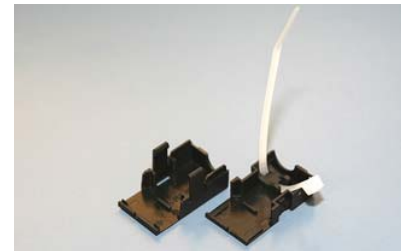

#### Putting in the plug connector

Put the plug connector into that lower part of the stain relief housing.

Tighten the lacing cord and pinch off the plastic strap.





#### Fixing the upper part of the strain relief housing

Fix the upper part of the stain relief housing by snapping it onto the lower part.



## 4.2 Connecting the Control Panel

 <b>Attention</b>	<p><b>The mains plug must be disconnected</b></p> <p>Please read the documentation for the external devices prior to connecting them!</p> <p>During thunderstorms, plug connector must neither be inserted nor removed!</p> <p>When disconnecting a plug connector, always handle it at the plug. Do not pull the cable!</p>
---	--

 <b>Attention</b>	<p><b>CU8803-0000 disconnect power supply</b></p> <p>If using the CP-Link 4 - One Cable Display Link, the 24 V power supply of the CP-Link 4 transmitter box must be switched off before disconnecting the CP-Link 4 output connection.</p>
---	---

### 4.2.1 Connecting cables

The connections are located at the rear of the Control Panel and are documented in the chapter [Interfaces](#).

When connecting cables to the Control Panel, please adhere to the following order:

- Disconnect the Control Panel from the power supply.
- Connect all cables at the Control Panel and at the devices to be connected.
- Ensure that all screw connections between connectors and sockets are tight!
- Reconnect all devices to the power supply.

### 4.2.2 Protective Earthing



The low resistance protective earthing connection of the Control Panel is established via the screw connection, which is located in the connection area.

 <b>Note</b>	<p><b>Malfunction possible with missing ground connection</b></p> <p>A proper ground connection of the device is absolutely necessary for the correct function of the touchscreen.</p>
--	--



## 5 Operating Instructions

### 5.1 Switching the Control Panel on and off

#### 5.1.1 Switching on

The Control Panel does not have its own mains power switch. As soon as the power supply is switched on the Control Panel is activated.

#### 5.1.2 Shutting down and switching off

Control software such as is typically used on Industrial PCs permits various users to be given different rights. A user who may not close software may also not switch the Industrial PC off, since data can be lost from the storage medium by switching off while software is running.

 <b>Warning</b>	<p><b>First shut down, then switch off!</b></p> <p>If the Industrial PC is switched off as the software is writing a file to the storage medium, the file will be destroyed. Control software typically writes something to the storage medium every few seconds, so that the probability of causing damage by switching off while the software is running is very high.</p>
---	--

 <b>Warning</b>	<p><b>Switch off power supply</b></p> <p>When you have shut down the Industrial PC, you have to switch off power supply for at least 10 seconds before rebooting the system. After resetting power supply the Industrial PC will start booting automatically.</p>
---	---

### 5.2 Operation

The operation of the Control Panel occurs via the Touch Screen.

 <b>Warning</b>	<p><b>Risk of damaging the Touch Screen</b></p> <p>The touch screen may only be actuated by finger tips or with the touch screen pen. The operator may wear gloves but there must be no hard particles such as metal shavings, glass splinters embedded in the glove.</p>
---	---

 <b>Warning</b>	<p><b>Properly installation of the system and the multi-touch device</b></p> <p>Capacitive Touch Screens use the functional principle of capacitive alternation of the electrical field. Strong electrical fields can influence the functionality of the multi-touch devices.</p> <p>To ensure the correct function of the Touch Screen take care of a standardized installation of all parts of the system and an EMC-environment conforming to standards.</p>
---	---

## 5.3 Servicing and maintenance

### 5.3.1 Cleaning

 <b>DANGER</b>	<b>Disconnect power supply</b> Switch off the device and all connected devices, and disconnect the device from the power supply.
--	---

The device can be cleaned with a soft, damp cleaning cloth. Do not use any aggressive cleaning materials, thinners, scouring material or hard objects that could cause scratches.

### 5.3.2 Maintenance

The Control Panel is maintenance-free.

## 5.4 Emergency procedures

In case of fire, the Control Panel should be extinguished with powder or nitrogen.

## 5.5 Shutting down

### 5.5.1 Disposal

 <b>Note</b>	<b>Observe national electronics scrap regulations</b> Observe the national electronics scrap regulations when disposing of the device.
---	---

In order to dispose of the device, it must be removed and fully dismantled:

- Housing components (polycarbonate, polyamide (PA6.6)) are suitable for plastic recycling.
- Metal parts can be sent for metal recycling.
- Electronic parts such as disk drives and circuit boards must be disposed of in accordance with national electronics scrap regulations.

## 6 Troubleshooting

 <b>Note</b>	<p><b>Pixel errors</b></p> <p>Pixel errors in the TFT display are production-caused and represent no complaint-reason!</p>
--	--

 <b>Note</b>	<p><b>Anomalies of the Touchscreen</b></p> <p>Anomalies of the touchscreen sensor are production-caused and represent no complaint-reason!</p>
--	--

Fault	Cause	Measures
The Control Panel shows no function	No power supply to the Control Panel/ Industrial PC Cable not connected	Check power supply cable 1. Correctly connect cable 2. Call Beckhoff Service
Computer boots, software starts, but control does not operate correctly	Cause of the fault is either in the software or in parts of the plant outside the Industrial PC	Call the manufacturer of the machine or the software
Malfuction of the touchscreen	Bad or missing ground connection of the device	Establish ground connection
	Bad or missing ground connection of the user	User must stand on the floor with ordinary shoes
USB error while TwinCAT access via USB	Cycle time in TwinCAT is set on 10 ms (standard)	Increase the cycle time up to 50 ms till 80 ms
The Control Panel functions only partially or only part of the time, e.g. no or dark picture	Faulty backlight in the display Defective components in the Control Panel	Call Beckhoff Service Call Beckhoff Service

## 7 Assembly dimensions

For the assembly dimensions of the Control Panels please visit our homepage. Here you will find the actual drawings using the link:

[http://download.beckhoff.com/download/Technical\\_Drawings/Industrial\\_PC/Control\\_Panel/CP29xx](http://download.beckhoff.com/download/Technical_Drawings/Industrial_PC/Control_Panel/CP29xx)





**Warning**

### **Notice mounting orientation**

The assembly of the unit must take place with the orientation diagrammed here.

## 8 Technical Data

 <b>Danger</b>	<p><b>Risk of explosion!</b></p> <p>Do not use the Control Panel in areas of explosive hazard!</p>
--	--

 <b>Note</b>	<p><b>Pixel errors</b></p> <p>Pixel errors in the TFT display are production-caused and represent no complaint-reason!</p>
--	--

 <b>Note</b>	<p><b>Anomalies of the Touchscreen</b></p> <p>Anomalies of the touchscreen sensor are production-caused and represent no complaint-reason!</p>
--	--

Product name	CP29xx-0000/ -0010																
Dimensions (B x H x T)	See chapter <a href="#">Assembly dimensions</a>																
Weight	<table border="0"> <tr> <td>CP2907:</td> <td>1.5 kg</td> <td>CP2918:</td> <td>5.1 kg</td> </tr> <tr> <td>CP2912:</td> <td>3.0 kg</td> <td>CP2919:</td> <td>5.4 kg</td> </tr> <tr> <td>CP2915:</td> <td>3.7 kg</td> <td>CP2921:</td> <td>5.9 kg</td> </tr> <tr> <td>CP2916:</td> <td>4.2 kg</td> <td>CP2924:</td> <td>7.2 kg</td> </tr> </table>	CP2907:	1.5 kg	CP2918:	5.1 kg	CP2912:	3.0 kg	CP2919:	5.4 kg	CP2915:	3.7 kg	CP2921:	5.9 kg	CP2916:	4.2 kg	CP2924:	7.2 kg
CP2907:	1.5 kg	CP2918:	5.1 kg														
CP2912:	3.0 kg	CP2919:	5.4 kg														
CP2915:	3.7 kg	CP2921:	5.9 kg														
CP2916:	4.2 kg	CP2924:	7.2 kg														
Supply voltage	24 V <sub>DC</sub> (20.4 – 28.8 V <sub>DC</sub> )																
Power consumption	<table border="0"> <tr> <td>CP2907:</td> <td>max. 12 W</td> <td>CP2918:</td> <td>max. 25 W</td> </tr> <tr> <td>CP2912:</td> <td>max. 16 W</td> <td>CP2919:</td> <td>max. 25 W</td> </tr> <tr> <td>CP2915:</td> <td>max. 20 W</td> <td>CP2921:</td> <td>max. 35 W</td> </tr> <tr> <td>CP2916:</td> <td>max. 22 W</td> <td>CP2924:</td> <td>max. 45 W</td> </tr> </table>	CP2907:	max. 12 W	CP2918:	max. 25 W	CP2912:	max. 16 W	CP2919:	max. 25 W	CP2915:	max. 20 W	CP2921:	max. 35 W	CP2916:	max. 22 W	CP2924:	max. 45 W
CP2907:	max. 12 W	CP2918:	max. 25 W														
CP2912:	max. 16 W	CP2919:	max. 25 W														
CP2915:	max. 20 W	CP2921:	max. 35 W														
CP2916:	max. 22 W	CP2924:	max. 45 W														
UL-compliance (in progress)	<ul style="list-style-type: none"> <li>Using a power supply class 2 or</li> <li>Fuse protection with 4 A, according to UL 60950.2 chapter 2.5, table 2C</li> </ul>																
CP29xx-0000: Integrated DVI/USB extension technology	<ul style="list-style-type: none"> <li>DVI-E and USB-E 2.0 enable remote panel operation at a distance of up to 50 m from the PC</li> <li>USB-E 2.0 transmits USB 2.0 with 480 Mbit/s</li> <li>DVI-E input is compatible to the standard DVI output of a PC</li> </ul>																
CP29xx-0010: Integrated CP-Link 4 technology	<ul style="list-style-type: none"> <li>enables remote panel operation at a distance of up to 100 m from the PC via a CAT.6<sub>A</sub> cable</li> <li>integrated or separate 24 V DC power supply</li> <li>CP-Link 4 transmits USB 2.0 with 100 MBit/s</li> </ul>																
Interfaces CP29xx-0000	2-Port-USB-3.0/ USB 2.0, see chapter <a href="#">Interfaces CP29xx-0000</a>																
Interfaces CP29xx-0010	2-Port-USB-2.0 interface																
Protection class	Front side IP65, rear side IP20																
Shock resistance (Sinusoidal vibration)	EN 60068-2-6: 10 to 58 Hz: 0.035 mm 58 to 500 Hz: 0.5 G (~ 5 m/ s <sup>2</sup> )																
Shock resistance (Shock)	EN 60068-2-27: 5 G (~ 50 m/ s <sup>2</sup> ), duration: 30 ms																
EMC compatibility	Resistance to interference conforms to EN 61000-6-2																
EMC compatibility	Emission of interference conforms to EN 61000-6-4																
Permissible ambient temperature	Operation: 0°C to +55°C (CP29xx-0000) 0°C to +50°C (CP29xx-0000) Transport/ storage: -20°C to +70°C																
Permissible relative humidity	to 95%, no condensation																
Transport and storage	The same values for atmospheric humidity and shock resistance are to be observed during transport and storage as in operation. Suitable packaging of the Panel PC can improve the resistance to impact during transport.																
Certifications	CE; UL in progress																

## 9 Appendix

### 9.1 Beckhoff Support and Service

Beckhoff and their partners around the world offer comprehensive support and service, making available fast and competent assistance with all questions related to Beckhoff products and system solutions.

#### 9.1.1 Beckhoff branches and partner companies

Please contact your Beckhoff branch office or partner company for [local support and service](#) on Beckhoff products!

The contact addresses for your country can be found in the list of Beckhoff branches and partner companies: [www.beckhoff.com](http://www.beckhoff.com). You will also find further [documentation](#) for Beckhoff components there.

#### 9.1.2 Beckhoff company headquarters

Beckhoff Automation GmbH & Co. KG  
Huelshorstweg 20  
33415 Verl  
Germany

Phone: + 49 (0) 5246/963-0  
Fax: + 49 (0) 5246/963-198  
E-mail: [info@beckhoff.de](mailto:info@beckhoff.de)  
Web: <http://www.beckhoff.de/>

#### Beckhoff Support

Support offers you comprehensive technical assistance, helping you not only with the application of individual Beckhoff products, but also with other, wide-ranging services:

- world-wide support
- design, programming and commissioning of complex automation systems
- and extensive training program for Beckhoff system components

Hotline: + 49 (0) 5246/963-157  
Fax: + 49 (0) 5246/963-9157  
E-mail: [support@beckhoff.com](mailto:support@beckhoff.com)

#### Beckhoff Service

The Beckhoff Service Center supports you in all matters of after-sales service:

- on-site service
- repair service
- spare parts service
- hotline service

Hotline: + 49 (0) 5246/963-460  
Fax: + 49 (0) 5246/963-479  
E-mail: [service@beckhoff.com](mailto:service@beckhoff.com)

If servicing is required, please quote the **project number** of your product.

## 9.2 Approvals for USA and Canada

### 9.3 FCC Approvals for the United States of America

#### **FCC: Federal Communications Commission Radio Frequency Interference Statement**

This equipment has been tested and found to comply with the limits for a Class A digital device, pursuant to Part 15 of the FCC Rules. These limits are designed to provide reasonable protection against harmful interference when the equipment is operated in a commercial environment. This equipment generates, uses, and can radiate radio frequency energy and, if not installed and used in accordance with the instruction manual, may cause harmful interference to radio communications. Operation of this equipment in a residential area is likely to cause harmful interference in which case the user will be required to correct the interference at his own expense.



**Note**

#### **Technical modifications**

Technological changes to the device may cause the loss of the FCC approval.

### 9.4 FCC Approval for Canada

#### **FCC: Canadian Notice**

This equipment does not exceed the Class A limits for radiated emissions as described in the Radio Interference Regulations of the Canadian Department of Communications.