

User Manual

S Line Operating Terminals With Keyboard

Part Number: 80860.724

Version: 2

Date: 2012-07-19

Valid for:
BT03AM
BT05AM
BT07AM
BT21AM
BT21AS
BT21AT
BT70AT

Version	Date	Modifications
1	2009-03-05	First Edition
2	2012-03-30	Interfaces: RS422/RS485 modified Technical data: Application area modified Connecting the device: Torque specifications added

This manual, including all illustrations contained herein, is copyright protected. Use of this manual by any third party in departure from the copyright provision is forbidden. No part of this manual may be reproduced, translated or electronically or photographically archived or altered without the express written consent from Süttron electronic GmbH. Violations shall be cause for damage liability.

Süttron electronic reserves the right to make any changes that contribute to technical improvement.

Overall Table of Contents

1	Important Notes	1-1
	1.1 Symbols	1-1
	1.2 Safety Notes	1-1
	1.3 Intended Use.....	1-2
	1.4 Target Group.....	1-2
2	Installation and Commissioning	2-1
	2.1 Unpacking the Device	2-1
	2.2 Mounting the Device	2-1
	2.2.1 Front Panel Dimensions	2-2
	2.2.2 Mounting Cutout	2-4
	2.2.3 Side View, Mounting Depth	2-8
	2.3 Connecting the Device.....	2-13
	2.3.1 Supply Voltage.....	2-14
	2.4 Switching On.....	2-17
	2.4.1 Loading Procedure on Windows CE Operating System	2-17
	2.4.1.1 Launch Structure	2-18
	2.4.1.2 Normal Mode	2-19
	2.4.1.3 Setup Main Mode.....	2-19
	2.4.1.4 Administration Operating Mode	2-29
	2.4.2 Function of the AppStarter.exe Program	2-30
	2.4.3 Function of the TSvisLD.exe Program.....	2-31
	2.4.4 Memory Media Used.....	2-31
	2.4.5 Important Files and Update	2-32
	2.5 Identification.....	2-33
	2.5.1 Version Key	2-33
3	Control and Display Elements	3-1
	3.1 Keyboard.....	3-1
	3.1.1 Editing Keys.....	3-1
	3.1.2 Control Keys	3-2
	3.1.3 Special Keys	3-2
	3.1.4 Function Keys	3-3
	3.1.4.1 Slide-in Identification Strips for the Function Keys	3-4
	3.2 Display	3-9
	3.2.1 Setting the Brightness.....	3-9
	3.2.2 Setting the Contrast.....	3-10
	3.2.3 Character Attributes.....	3-10
	3.2.4 Fonts.....	3-10
4	Interfaces of the Device	4-1

- 4.1 Standard Interfaces 4-2
 - 4.1.1 Ethernet (X5)..... 4-2
 - 4.1.1.1 Pin Assignment..... 4-2
 - 4.1.1.2 Cable 4-2
 - 4.1.1.3 Diagnostics 4-3
 - 4.1.2 USB (X9, X10) 4-3
 - 4.1.2.1 Cable 4-3
- 4.2 Serial Interfaces 4-4
 - 4.2.1 RS422 / RS485 (X6) 4-5
 - 4.2.1.1 Pin Assignment..... 4-5
 - 4.2.1.2 Termination..... 4-6
 - 4.2.2 RS232 (X6) 4-7
 - 4.2.2.1 Pin Assignment..... 4-7
 - 4.2.2.2 Termination..... 4-7
- 4.3 Field Bus Interfaces 4-8
 - 4.3.1 CAN Slave (X6)..... 4-8
 - 4.3.1.1 Pin Assignment..... 4-9
 - 4.3.1.2 Cable 4-10
 - 4.3.1.3 Termination..... 4-10
 - 4.3.1.4 Diagnostics 4-10
 - 4.3.1.5 Slope Control..... 4-11
 - 4.3.2 DeviceNet Slave (X6)..... 4-12
 - 4.3.2.1 Pin Assignment..... 4-12
 - 4.3.2.2 Cable 4-13
 - 4.3.2.3 Termination..... 4-13
 - 4.3.2.4 Diagnostics 4-13
 - 4.3.3 INTERBUS Slave (X6, X7)..... 4-14
 - 4.3.3.1 Pin Assignment..... 4-14
 - 4.3.3.2 Cable 4-15
 - 4.3.3.3 Diagnostics 4-15
 - 4.3.4 MPI Slave (X6)..... 4-16
 - 4.3.4.1 Pin Assignment..... 4-16
 - 4.3.4.2 Cable 4-17
 - 4.3.4.3 Termination..... 4-17
 - 4.3.4.4 Diagnostics 4-17
 - 4.3.5 PROFIBUS-DP Slave (X6)..... 4-18
 - 4.3.5.1 Pin Assignment..... 4-18
 - 4.3.5.2 Cable 4-19
 - 4.3.5.3 Termination..... 4-19
 - 4.3.5.4 Diagnostics 4-19
 - 4.3.6 KNX (X6)..... 4-20
 - 4.3.6.1 Pin Assignment..... 4-20
- 4.4 Shielding D-SUB Connectors 4-21

- 5 Maintenance and Servicing 5-1
 - 5.1 Front Panel..... 5-1
 - 5.2 Fuse 5-1
 - 5.3 Battery 5-1
 - 5.3.1 Changing the Battery 5-2

5.3.2 Battery Disposal..... 5-2

6 Technical Data..... 6-1

7 Ordering Data 7-1

A Index.....A-1

1 Important Notes

1.1 Symbols

The symbols in this manual are used to draw your attention on notes and dangers.



This is the safety alert symbol. It is used to alert you to potential personal injury hazards. Obey all safety messages that follow this symbol to avoid possible injury or death.



DANGER

This indicates a hazardous situation which, if not avoided, will result in death or serious injury.



WARNING

This indicates a hazardous situation which, if not avoided, could result in death or serious injury.



CAUTION

This indicates a hazardous situation which, if not avoided, could result in minor or moderate injury.



NOTICE

This symbol together with the signal word NOTE and the accompanying text alert the reader to a situation which may cause damage or malfunction to the device, hardware/software, or surrounding property.



This symbol and the accompanying text provide the reader with additional information or refer to detailed sources of information.

1.2 Safety Notes

- Read this manual carefully before using the operating device. Keep this manual in a place where it is always accessible to all users.
- Proper transportation, handling and storage, placement and installation of this product are prerequisites for its subsequent flawless and safe operation.
- This user manual contains the most important information for the safe operation of the device.
- The user manual, in particular the safety notes, must be observed by all personnel working with the device.
- Observe the accident prevention rules and regulations that apply to the operating site.
- Installation and operation must only be carried out by qualified and trained personnel.

1.3 Intended Use

- The device is designed for use in the industry.
- The device is state-of-the art and has been built to the latest standard safety requirements. However, dangerous situations or damage to the machine itself or other property can arise from the use of this device.
- The device fulfills the requirements of the EMC directives and harmonized European standards. Any modifications to the system can influence the EMC behavior.



NOTICE: Radio Interference

This is a class A device. This device may cause radio interference in residential areas. In this case, the user may be required to introduce appropriate countermeasures, and to bear the cost of same.

1.4 Target Group

The use of products described in this manual is oriented exclusively to:

- Qualified electricians or persons instructed by them, who are familiar with applicable standards and other regulations regarding electrical engineering and, in particular, the relevant safety concepts.
- Qualified application programmers and software engineers, who are familiar with the safety concepts of automation technology and applicable standards.

2 Installation and Commissioning

2.1 Unpacking the Device

Unpack all parts carefully and check the contents for any visible damage in transit. Also check whether the shipment matches the specifications on your delivery note.

If you notice damages in transit or discrepancies, please contact our sales department immediately.

2.2 Mounting the Device



NOTICE: Damage

When installing the device, leave a gap of at least 30 mm (1.181") around the device to ensure sufficient air circulation.



NOTICE: Damage

When the operating device is installed horizontally, please note that additional sources of heat beneath the operating device may result in heat accumulation. Make sure to allow sufficient heat dissipation!

Comply with the allowable temperature range listed in the technical data for the use of the operating device!



NOTICE: Damage

To ensure the specified degree of protection, make sure that the seal rests flat on the mounting surface and the threaded pins of the mounting brackets are uniformly tightened.

Ensure that the maximum torque of 1 Nm is not exceeded.

The device can be easily and quickly mounted from the rear of the device. Ideally, the device should be installed in switch panels with a plate thickness of approx. 1 mm to 6 mm (0.039" to 0.236").

1. Insert the device in the mounting cutout from the front.

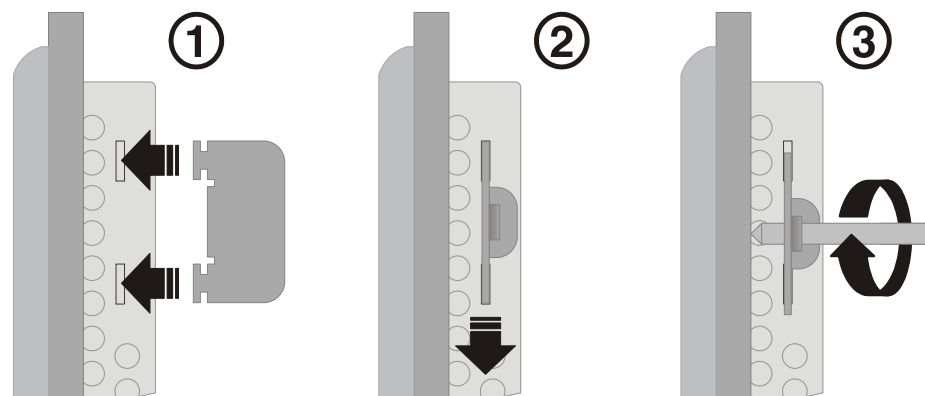

Figure 2-1 Mounting the device using a mounting bracket

2. Insert the mounting brackets into the appropriate openings (figure 1) and pull the brackets downwards until they lock in place (figure 2).
3. Fasten the device into position using the threaded pins (figure 3).

2.2.1 Front Panel Dimensions

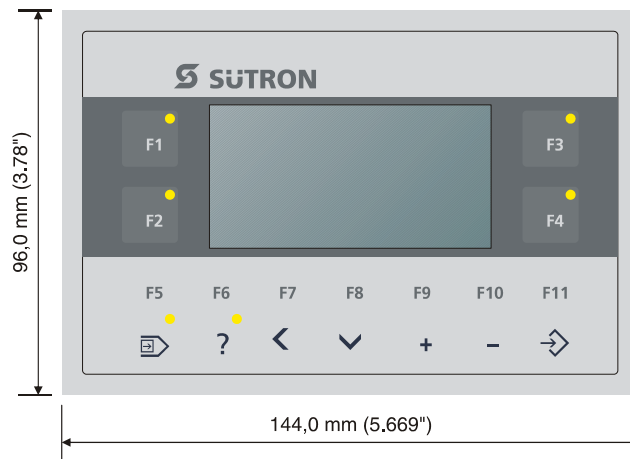

Figure 2-2 BT03AM

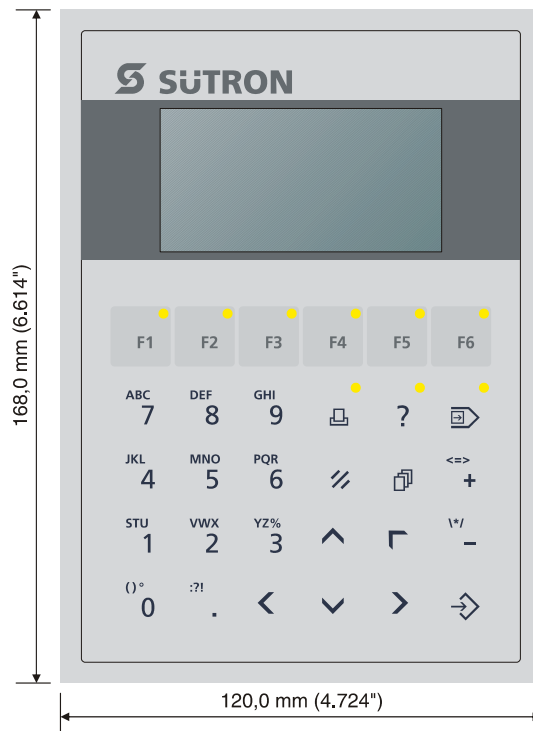

Figure 2-3 BT05AM



Figure 2-4 BT07AM

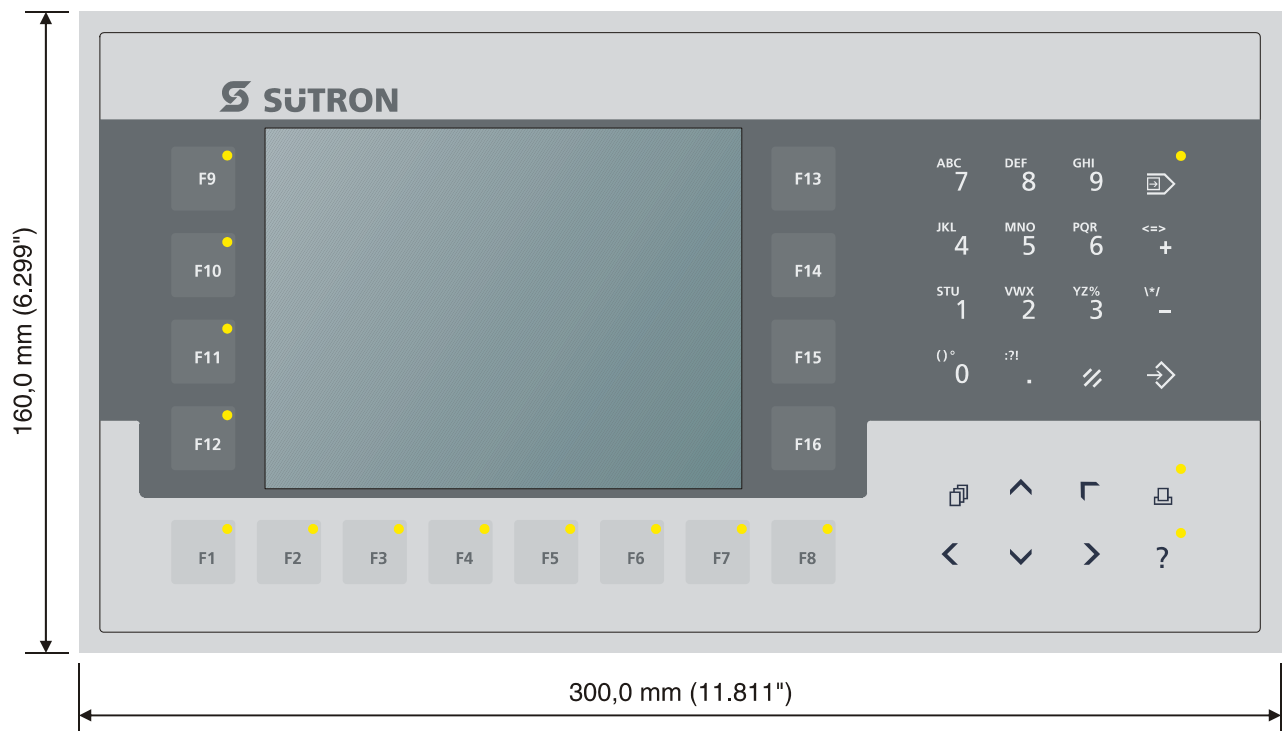

Figure 2-5 BT21AM, BT21AS

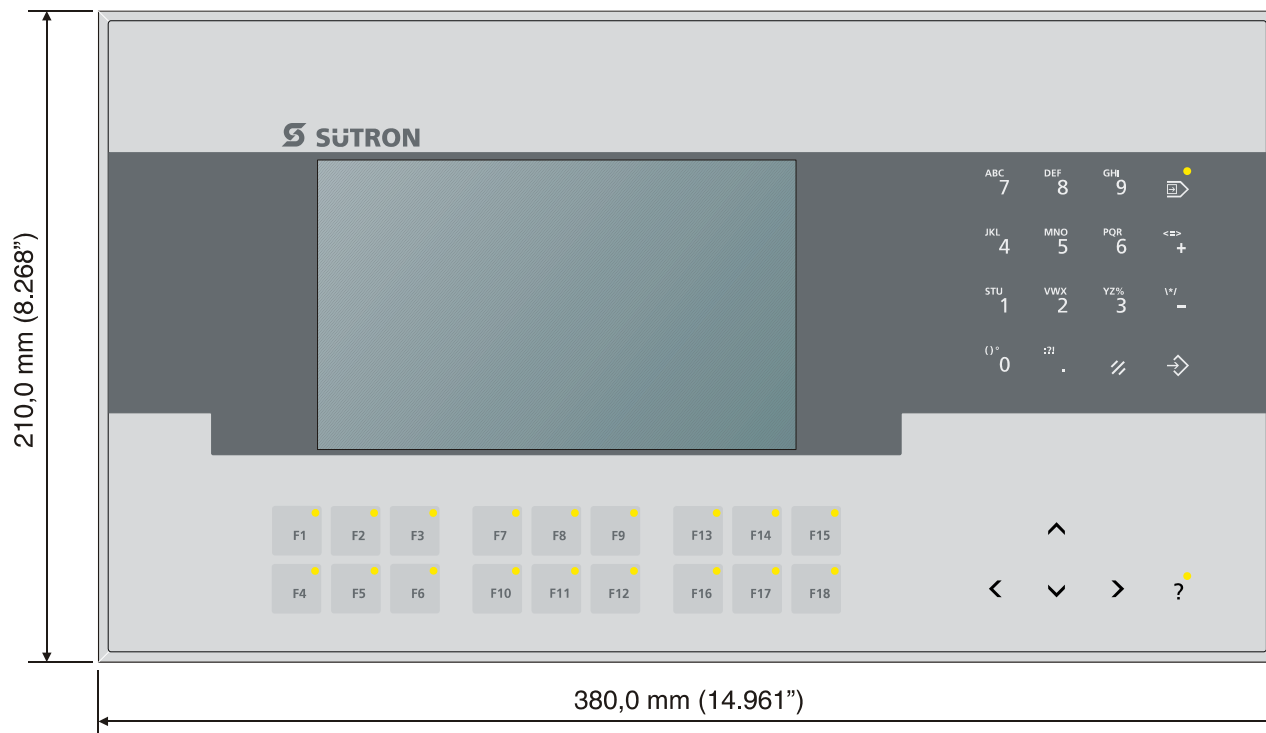

Figure 2-6 BT70AT

2.2.2 Mounting Cutout

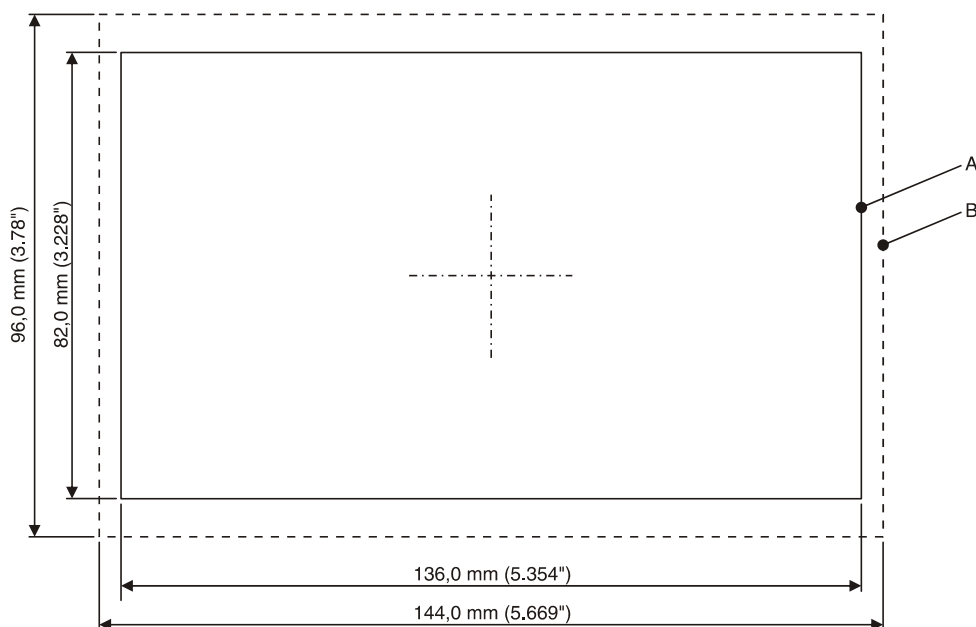

Figure 2-7 BT03AM

- A Mounting Cutout
- B Front Panel

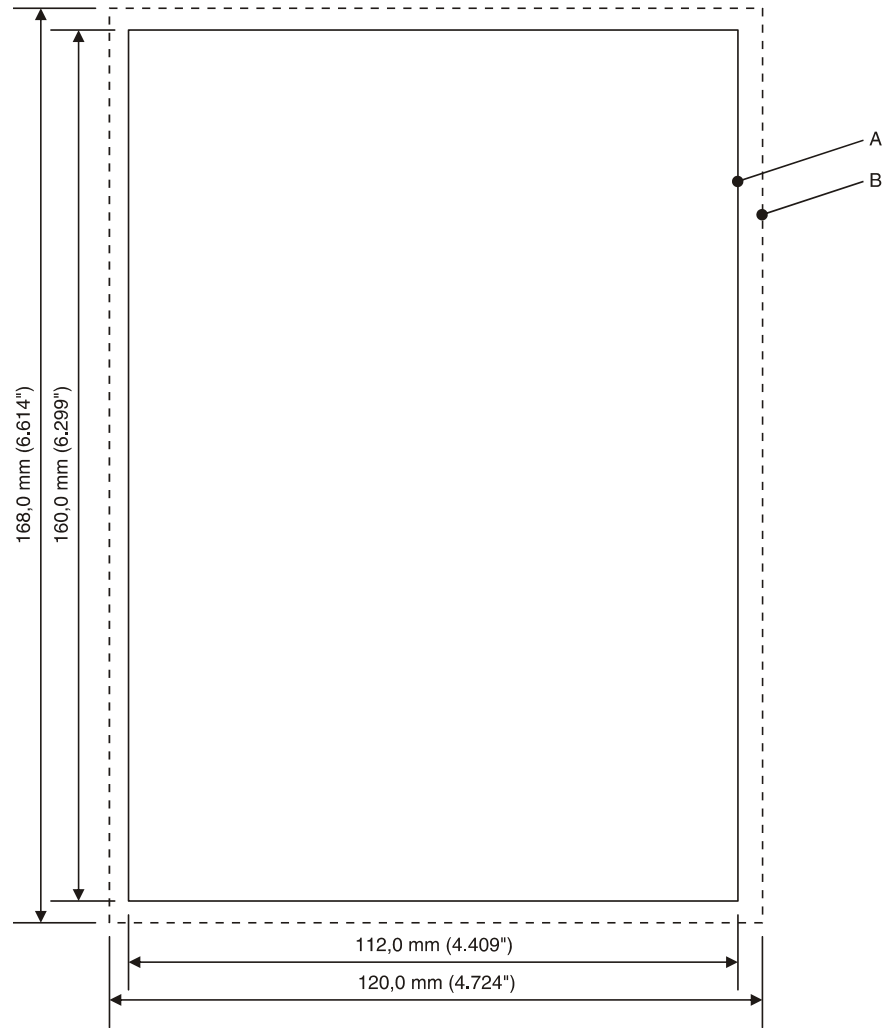

Figure 2-8 BT05AM

- A** Mounting Cutout
- B** Front Panel

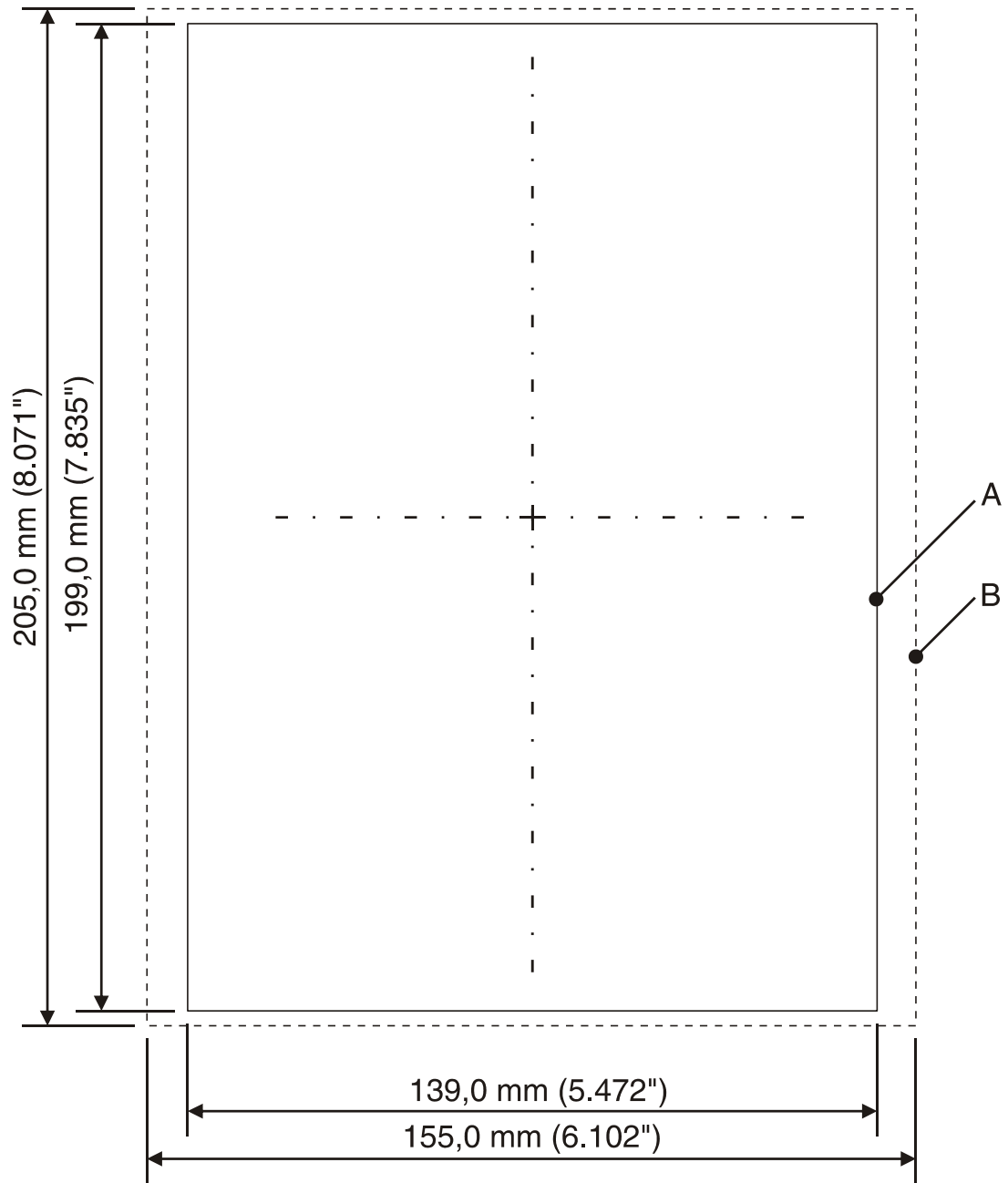

Figure 2-9 BT07AM

- A Mounting Cutout
- B Front Panel

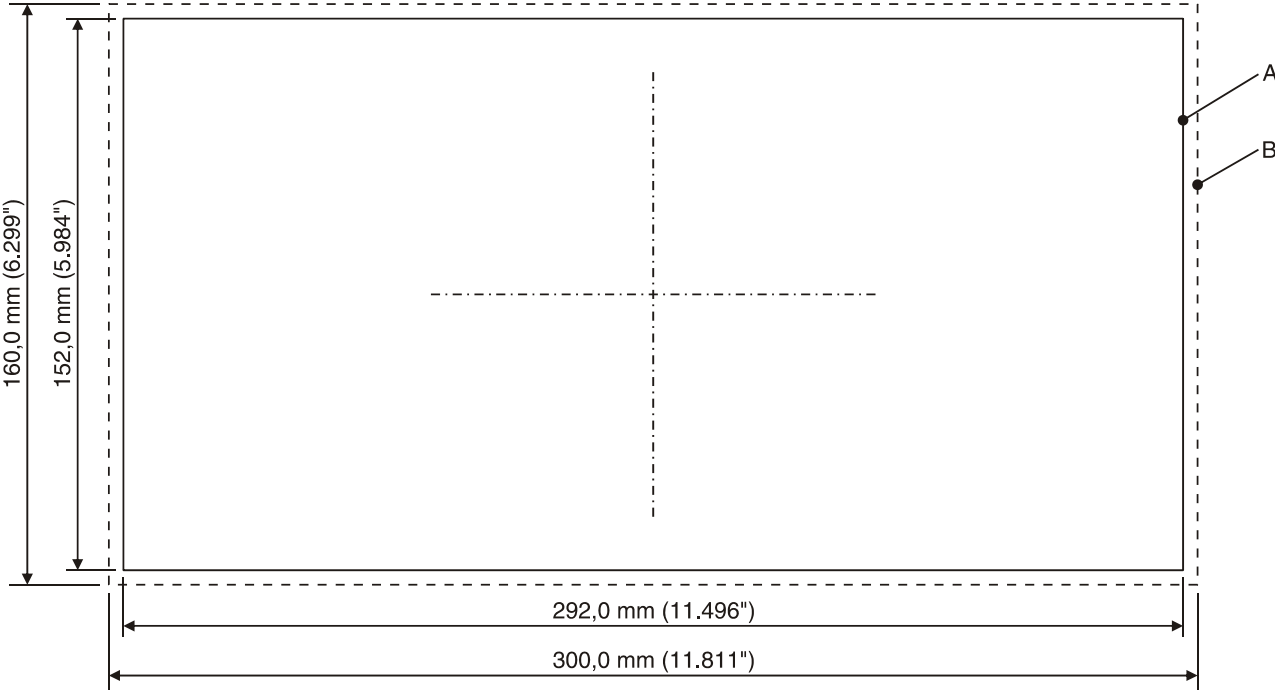

Figure 2-10 BT21AM, BT21AS

- A Mounting Cutout
- B Front Panel

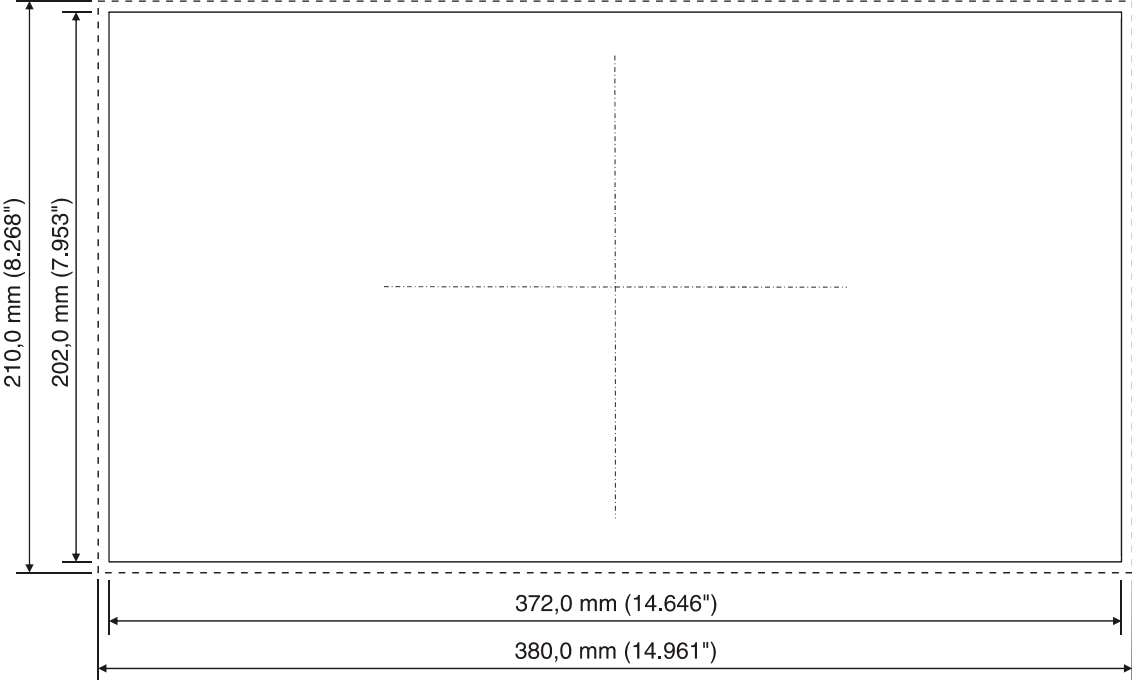

Figure 2-11 BT70AT

- A Mounting Cutout
- B Front Panel

2.2.3 Side View, Mounting Depth

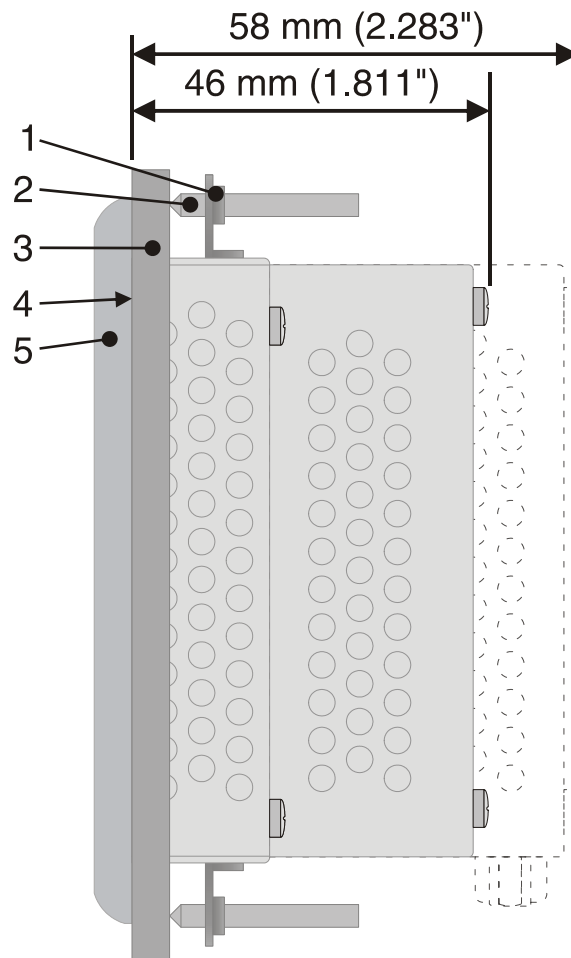

Figure 2-12 BT03AM

- 1 Mounting Bracket
- 2 Threaded Pin
- 3 Mounting Surface Thickness 1 mm to 6 mm
- 4 Circumferential Seal
- 5 Front Panel

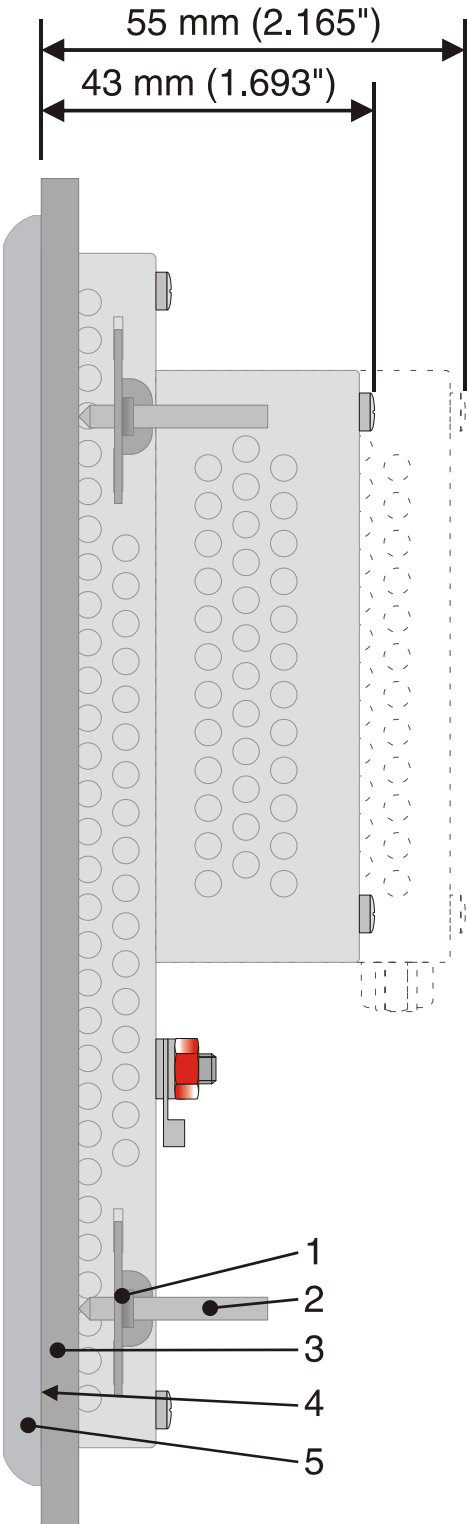

Figure 2-13 BT05AM

- 1 Mounting Bracket
- 2 Threaded Pin
- 3 Mounting Surface Thickness 1 mm to 6 mm
- 4 Circumferential Seal
- 5 Front Panel

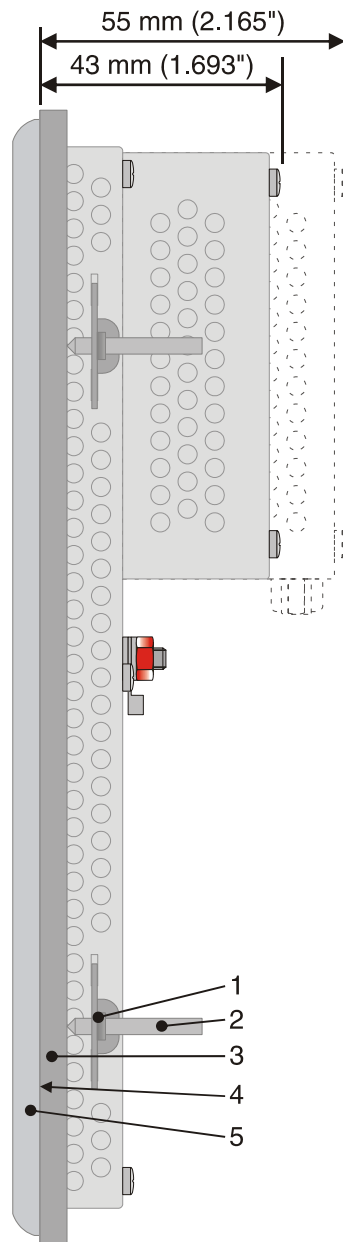

Figure 2-14 BT07AM

- 1 Mounting Bracket
- 2 Threaded Pin
- 3 Mounting Surface Thickness 1 mm to 6 mm
- 4 Circumferential Seal
- 5 Front Panel

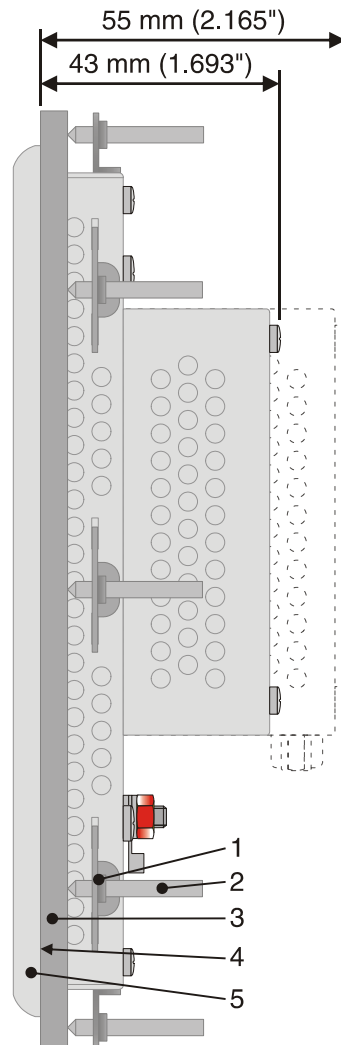

Figure 2-15 BT21AM, BT21AS

- 1 Mounting Bracket
- 2 Threaded Pin
- 3 Mounting Surface Thickness 1 mm to 6 mm
- 4 Circumferential Seal
- 5 Front Panel

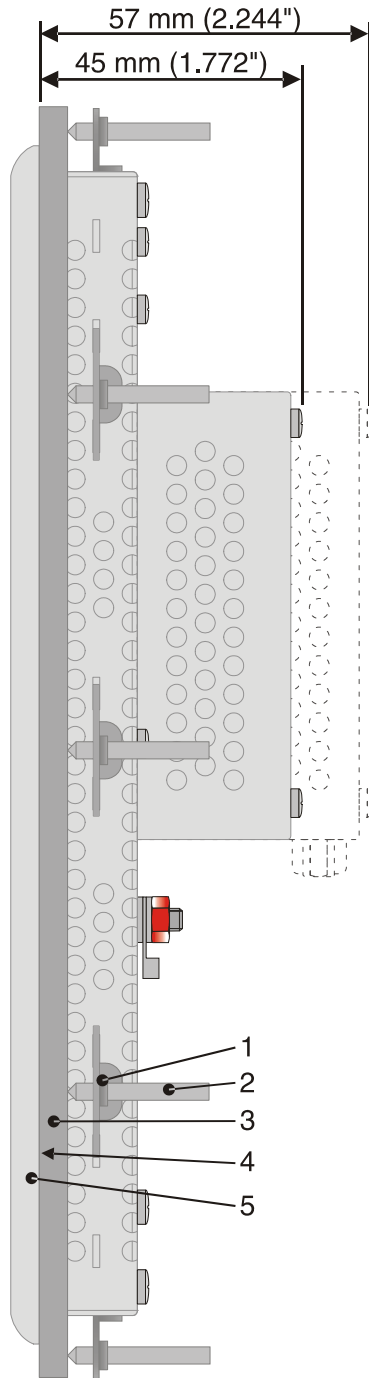

Figure 2-16 BT70AT

- 1 Mounting Bracket
- 2 Threaded Pin
- 3 Mounting Surface Thickness 1 mm to 6 mm
- 4 Circumferential Seal
- 5 Front Panel

2.3 Connecting the Device

2.3.1 Supply Voltage

The supply voltage is supplied via connector X1.

Refer to the technical data for the permissible supply voltage of the operating device.

The device has reverse polarity protection. In case of wrong polarity, the device will not operate.

This is a protection class I device. For safe operation, safety extra-low voltage (SELV) in accordance with DIN EN 61131 must be used for the supply voltage.

Connector in the operating device: 3 pin connector

A suitable female connector strip is supplied.

Table 2-1 Pin assignment supply voltage

Pin	Designation	Function
1		Low-Noise Ground
2	0 V	Supply Voltage 0 V
3	24 VDC	Supply Voltage 24 VDC



NOTICE: Damage

Cables with finely stranded conductors with a minimum cross-section of 0.75 mm² (18 AWG) and a maximum cross-section of 2.5 mm² (14 AWG) must be used for the supply voltage.

You must adhere to the following torques at the connector:

Screw connection of terminal blocks: 0.22 Nm (minimal) to 0.25 Nm (maximum).

Screw flange: 0.3 Nm (maximum)



NOTICE: Damage

A separate conductor must always be provided for the protective grounding. The conductor must have a minimum cross-section of 1.5 mm² (16 AWG) and must be kept as short as possible.

You must adhere to a maximum torque of 1 Nm at an protective grounding on the threaded bolt.



DANGER: Hazardous voltages

Hazardous voltages can exist inside electrical installations that can pose a danger to humans. Coming in contact with live parts may result in electric shock!

Use the following procedure to connect the device to the supply voltage:

1. Strip approx. 30 mm (1.181") off the outer cable sheath and approx. 5 mm (0.197") off the wires.

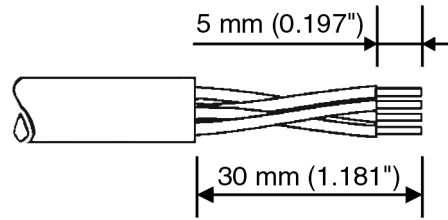

Figure 2-17 Preparing the cable

2. Fit the wires with wire end ferrules and connect the wires to the connector.

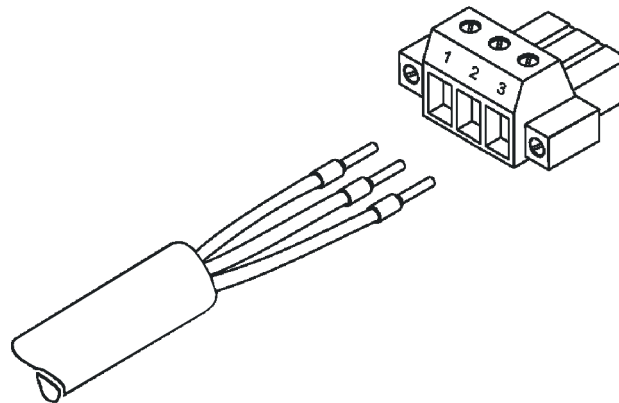

Figure 2-18 Connecting the female connector strip

3. Plug the female connector strip onto connector X1.

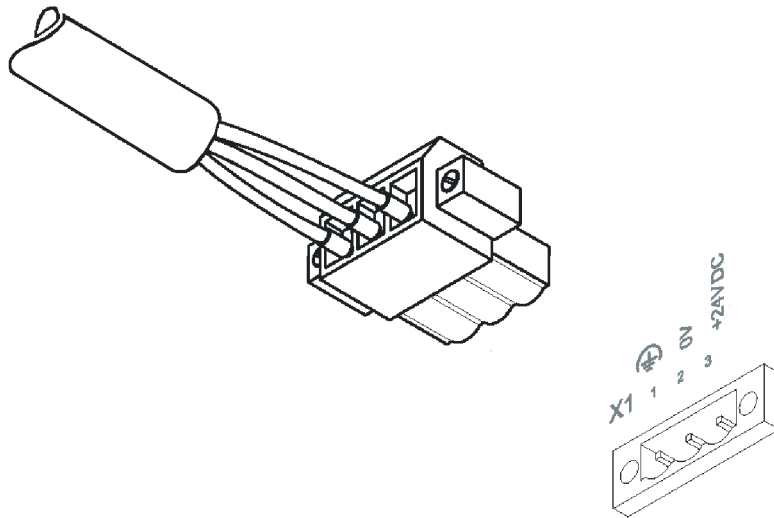

Figure 2-19 Female connector strip is plugged on

4. Secure the female connector strip in place with a screw-type locking to prevent it from slipping out.

The protective grounding is performed - depending on the type of device - with a slip-on sleeve or a ring cable lug.

5. Plug the slip-on sleeve on the flat tab or mount the ring cable lug with the nut to the threaded bolt.

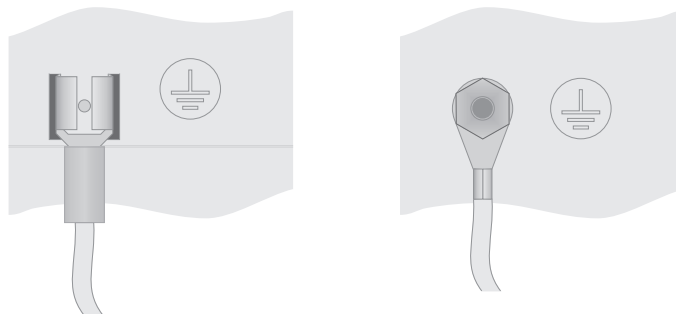

Figure 2-20 Protective grounding at flat tab / threaded bolt

2.4 Switching On

The Windows CE operating system is installed on the operating device. Running on the operating system is the visualization runtime.

2.4.1 Loading Procedure on Windows CE Operating System

During the startup phase the operating device makes it possible to modify the configuration with the **cursor** keys and the **enter** key.

The operating device has 3 operating modes:

- Normal (no key is pressed)
- Setup Main (Key **Enter** was pressed)
- Administration (Cursor key followed by **Enter** key was pressed)

2.4.1.1 Launch Structure

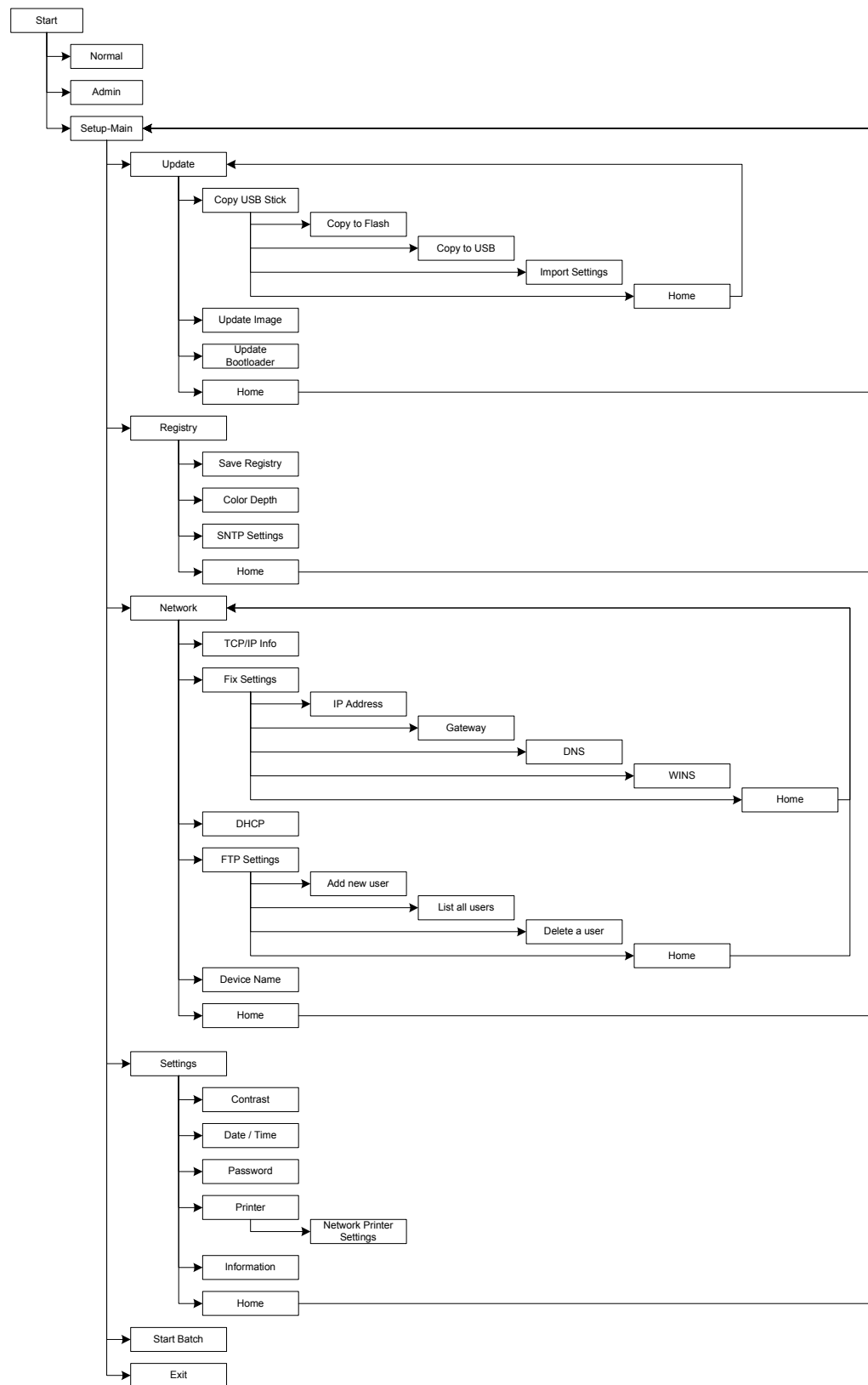

Figure 2-21 Launch structure

2.4.1.2 Normal Mode

The AppStarter.exe program is started from the internal Flash memory.

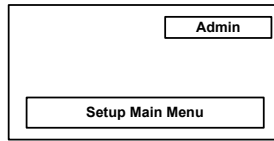

Figure 2-22 Display after startup

The following message is issued if the AppStarter.exe file does not exist.

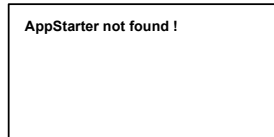

Figure 2-23 Error message after startup

2.4.1.3 Setup Main Mode

If the **Enter** key is pressed during the startup phase, Setup Main mode starts.

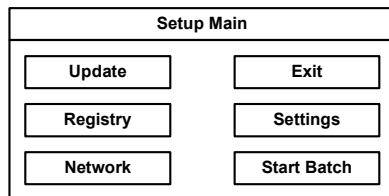

Figure 2-24 Setup Main



Some settings are password-protected. The default password is "+-+-.".

Update:

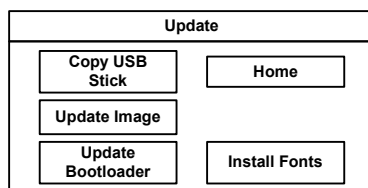

Figure 2-25 Update

Update, Copy USB-Stick:

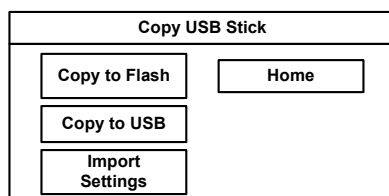

Figure 2-26 Copy USB Stick

Update, Copy USB-Stick, Copy to Flash:

This function copies the data from the USB stick to the internal flash file system.

Several projects can be managed in subdirectories below the directory TSvisRT. If more than one project is in different subdirectories, a choice dialog is displayed. Only directories which contain a project file (*.cb) are listed.

The entire TSvisRT directory or the corresponding subdirectory and the AppStarter.exe are copied into the target directory of the flash file system.

Update, Update Image:

If the „image“ subdirectory on the USB stick contains a „*.nb0“ file, this file is used to perform the image update. There must only be one „*.nb0“ file in this directory. In this case, the flash registry is always deactivated so that the image is processed with a new default registry.

Update, Update Bootloader:

If the „bootloader“ subdirectory on the USB stick contains a „*.nb0“ file, this file is used to perform the bootloader update. There must only be one „*.nb0“ file in this directory.

The user is informed that the update has been successfully completed.

Registry:

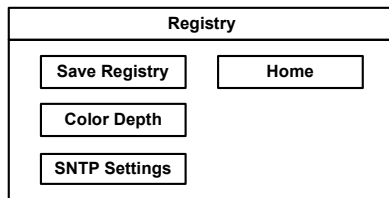

Figure 2-27 Registry

Touch Screen & Registry, Save Registry Settings:

The entire registry is saved.

Registry, Color Depth:

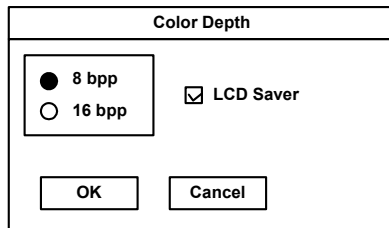

Figure 2-28 Registry, Color Depth

Selection of color depth for TFT displays.

LCD Saver switches the brightness to the lowest value, if no user operation occurs for at least one hour.

This entry is able to be password-protected.

Change Display Mode, Color:

Selection of color depth for TFT displays.

LCD Saver switches the brightness to the lowest value, if no user operation occurs for at least one hour.

Touch Screen & Registry, SNTP Settings:

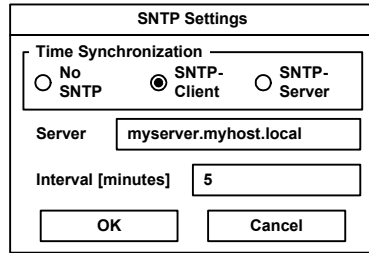

Figure 2-29 SNTP Settings

If you activate the "SNTP-Client" option, you can enter the address of a time server located in the intranet or Internet. The synchronization interval is specified in minutes.

With the option "No SNTP" the synchronization is deactivated.

The operating device may be used as a time server for other devices if the "SNTP-Server" option is active.

This entry is able to be password-protected.

Network Settings:

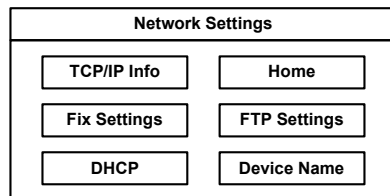

Figure 2-30 Network Settings



All addresses of the Network Settings have to be entered in the format "xxx.xxx.xxx.xxx".

Numbers smaller than 100 have to be filled up with leading zeros. (e.g.: 192.168.42.1 -> 192.168.042.001)

Network Settings, TCP/IP Info:

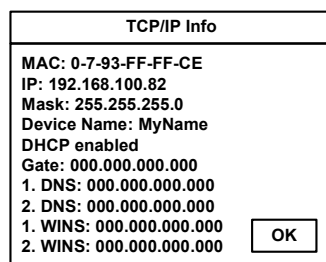

Figure 2-31 TCP/IP Info

The following informations are displayed:

- MAC address
- IP address,
- Subnet mask address,
- Device name,
- DHCP status,
- Gateway address,
- 1. DNS address,

- 2. DNS address,
- 1. WINS address,
- 2. WINS address.

Fix Settings:

Fix Settings	
IP Address	Home
Gateway	
DNS	WINS

Figure 2-32 Fix Settings

Network Settings, Fix Settings, IP Address:

IP Address	
IP Address	000.000.000.000
Subnet Mask	000.000.000.000
OK	Cancel

Figure 2-33 IP Address

The system automatically deselects DHCP and optionally enters the settings from the IPSetting.ini file of the USB stick. This file must exist in the root directory of the USB stick.

If no USB stick is connected the information is read from the registry.

This entry is able to be password-protected.

Contents of the IPSetting.ini file:

```
[IPCONFIG]
IPAddress=172.016.042.150
SubnetMask=255.255.255.000
```



All addresses of the Network Settings have to be entered in the format "xxx.xxx.xxx.xxx".

Numbers smaller than 100 have to be filled up with leading zeros.
(e.g.: 192.168.42.1 -> 192.168.042.001)

Network Settings, Fix Settings, Gateway:

Figure 2-34 Gateway

The system automatically deselects DHCP and optionally enters the settings from the IPSetting.ini file of the USB stick. This file must exist in the root directory of the USB stick.

If no USB stick is connected the information is read from the registry.

This entry is able to be password-protected.

Contents of the IPSetting.ini file:

```
[IPCONFIG]
Gateway=172.016.042.150
```



All addresses of the Network Settings have to be entered in the format "xxx.xxx.xxx.xxx".

Numbers smaller than 100 have to be filled up with leading zeros.
(e.g.: 192.168.42.1 -> 192.168.042.001)

Network Settings, Fix Settings, DNS:

Figure 2-35 DNS

The system deselects DHCP and enters the settings from the IPSetting.ini file of the USB stick. This file must exist in the root directory of the USB stick.

If no USB stick is connected the information is read from the registry.

This entry is able to be password-protected.

Contents of the IPSetting.ini file:

```
[IPCONFIG]
PrimaryDNS=172.016.042.150
SecondaryDNS=172.016.042.151
```



All addresses of the Network Settings have to be entered in the format "xxx.xxx.xxx.xxx".

Numbers smaller than 100 have to be filled up with leading zeros.
(e.g.: 192.168.42.1 -> 192.168.042.001)

Network Settings, Fix Settings, WINS:

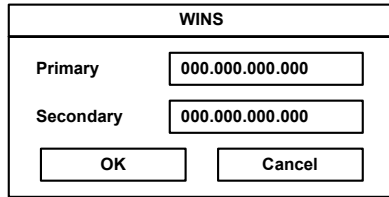

Figure 2-36 WINS

The system automatically deselects DHCP and optionally enters the settings from the IPSetting.ini file of the USB stick. This file must exist in the root directory of the USB stick.

If no USB stick is connected the information is read from the registry.

This entry is able to be password-protected.

Contents of the IPSetting.ini file:

```
[IPCONFIG]
PrimaryWINS=172.016.042.150
SecondaryWINS=172.016.042.151
```



All addresses of the Network Settings have to be entered in the format "xxx.xxx.xxx.xxx". Numbers smaller than 100 have to be filled up with leading zeros. (e.g.: 192.168.42.1 -> 192.168.042.001)

Network Settings, DHCP:

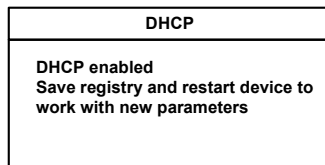

Figure 2-37 DHCP

You may enable DHCP service. You must save this setting when exiting of by using „Save Registry Settings“.

This entry is able to be password-protected.

Network Settings, FTP Settings, Add new user:

You may enter a new user name. You have to assign a password to the user name and to confirm it.

If at least one user name is added you cannot login to the FTP server as anonymous anymore.

Network Settings, FTP Settings, List all users:

All users are listed within a DOS box.

Network Settings, FTP Settings, Delete a user:

You may enter the user name you like to delete.

This entry is able to be password-protected.

Network Settings, Device Name:

Figure 2-38 Device Name

You can define a device name with up to 14 characters. Via a FTP connection you can access the device with the device name instead of the IP address.

This entry is able to be password-protected.

Settings:

Figure 2-39 Settings

Settings, Contrast:

Figure 2-40 Contrast

The operating mode setup main is displayed with default values for contrast and brightness to ensure reading also at faulty values. If you change a value, you have to confirm this in a dialog.

This entry is able to be password-protected.

Settings, Date / Time:

Figure 2-41 Date / Time

Set the date and the time. Push „Refresh“ to update the values.

Settings, Password:

The password can be activated, deactivated or redefined. When the password is activated, all password-protected dialog boxes can only be accessed if the password has been entered successfully.

This entry is able to be password-protected.

Settings, Printer:

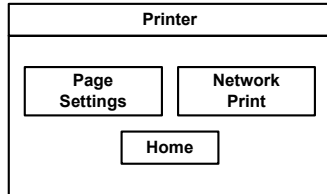

Figure 2-42 Printer

The print function depends on the application program on the operating device. Connection of a printer is possible via the network and the USB interface. The operating system supports PCL3-compatible printers.

Table 2-2 Already used printer models

Model
HP OfficeJet 6000
HP OfficeJet Pro 8000
HP DeskJet 6940
HP DeskJet 5150
HP Laserjet 1505N

This entry is able to be password-protected.

Settings, Printer, Page Settings:

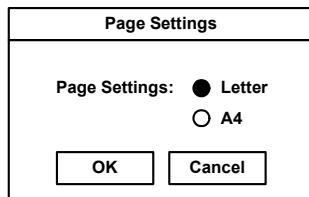

Figure 2-43 Page Settings

Select the paper format, "Letter" or "A4", "Letter" is default.

This entry is automatically stored in the registry.

Settings, Printer, Network Print:

Figure 2-44 Network Print

Enter the network printer path.

This entry is automatically stored in the registry.

Settings, Printer, Network Print, Network Server Login:

Figure 2-45 Network Server Login, User Name and Password

You may perform a network login.

Enter user name and password. After the confirmation with "OK" the dialog for the input of the domain appears.

Figure 2-46 Network Server Login, Domain

This entry is automatically stored in the registry.

Settings, Information:

Figure 2-47 Information

The following informations are displayed:

- Serial number,
- Product ID,
- Image version,
- Built version,
- Built date,

- Size of flash,
- Size of SRAM,
- Size of PLC / Visu RAM,
- Bus clock speed.

Start Batchfile:

The **project.bat** file in the **FlashDrv** directory starts, if available.

2.4.1.4 Administration Operating Mode

If you press the **Cursor Down** key followed by the **Enter** key / **Admin** button during the startup phase, the Administration mode of operation starts.

You can use the Admin.ini file to manage the device. This file must exist in the root directory of the USB stick.

This file is used as a dongle to prevent users from changing the device during normal operation.

Possible contents for the Admin.ini file:



Observe upper and lower case for all entries!

Explorer=Off	Deactivates the Explorer in the registry. The change becomes effective on the next device reboot.
Explorer=On	Activates the Explorer in the registry. The change becomes effective on the next device reboot.
Start=explorer.exe	Starts the explorer
Start=MyProgram.exe	Starts the application MyProgram.exe Initial directory is windows. Use the following syntax to start an application on the usb stick: Start=\\\\HardDisk\\MyProgram.exe Use multiple entries to start several applications.
Registry=Default	Destroys the current registry and activates the default registry of the image. The change becomes effective on the next device reboot.
StartRepllog=On	Enables automatic startup of the Repllog.exe program in the registry. The change becomes effective on the next device reboot.
StartRepllog=Off	Disables automatic startup of the Repllog.exe program in the registry. The change becomes effective on the next device reboot.
LaunchTouch=On	The touch variant of the launch will start at devices with keyboard. The change becomes effective on the next device reboot.
LaunchTouch=Off	The standard variant for the device will start. The change becomes effective on the next device reboot.
Lock=On	The buttons Press for Setup Main Menu and Admin are disabled. If the file „Admin.ini“ is found on the usb stick the button Admin is enabled. Therefore the deactivation of the lock is possible. The change becomes effective on the next device reboot.
Lock=Off	All buttons enabled. The change becomes effective on the next device reboot.
Mode=Development	The shell has full functionality. The change becomes effective on the next device reboot.

Mode=Standard	The Shell is restricted: No task bar and task switch available. Desktop contains the launch icon only. The change becomes effective on the next device reboot.
DeviceName=MyName	Defines the device name of the operating device
;DeviceName=MyName	Comment, no impact

2.4.2 Function of the AppStarter.exe Program

The AppStarter.exe program creates all the necessary registry settings and can also store the registry, if desired.

If the Explorer is activated, the system shuts it down. Automatic startup of ActiveSync is also deactivated.

The AppStarter.exe file then starts the TSvisLD_CE.exe file from the Flash File System (FFS).

2.4.3 Function of the TSvisLD.exe Program

The TSvisLD.exe loads the following components into the memory of the operating system in accordance with the instructions in the TSvisRT_CE.ini file:







- User application
- Protocol driver
- TSvisRT firmware

The program then unpacks the compressed application file (*.CB) and starts the TSvisRT Runtime component.



2.4.4 Memory Media Used

The following memory media are used:

Table 2-3 Memory media used

Operating system memory TSvisRT Runtime Protocol driver Application		Flash file system (FlashDrv) AppStarter.exe Subdirectory TSvisRT\Project name (with TSvisRT Runtime, protocol driver and application)		USB stick (Hard disk)
		Registry settings		Admin.ini IPSetting.ini
		Image storage in Flash		Subdirectory Image
		Bootloader storage in Flash		Subdirectory Bootloader

Legend:

-  Copying carried out by operating system
-  Copying carried out by the bootloader
-  Copying carried out by the Launch.exe

2.4.5 Important Files and Update

Table 2-4 Important files and update

File	Storage location	Update	Function
TSvisRT_CE.INI	Subdirectory TSvisRT or TSvisRT\Projekt on USB stick	Transfer via programming software on USB stick or FTP server	Initialization file for TSvisLD_CE.exe
SPSTxxxxxxx.yyy.DLL	Subdirectory TSvisRT or TSvisRT\Projekt on USB stick	Transfer via programming software on USB stick or FTP server	Protocol driver
*.CB	Subdirectory TSvisRT or TSvisRT\Projekt on USB stick	Transfer via programming software on USB stick or FTP server	Compressed application file
TSvisRT_CE.EXE	Subdirectory TSvisRT or TSvisRT\Projekt on USB stick	Transfer via programming software on USB stick or FTP server	TSvisRT Runtime
*.nb0	Subdirectory Bootloader	Menu item "Update Bootloader" in operating mode setup main via USB stick	Windows CE Bootloader
*.nb0	Subdirectory Image	Menu item "Update Image" in operating mode setup main via USB stick	Operating system Windows CE
AppStarter.EXE	Root directory on USB stick	Menu item "Copy USB Stick" in operating mode setup main via USB stick	Starts TSvisLD_CE.exe
TSvisLD_CE.EXE	Subdirectory TSvisRT or TSvisRT\Projekt on USB stick	Menu item "Copy USB Stick" in operating mode setup main via USB stick	TSvisRT loader
Admin.INI	Root directory on USB stick	-	File with administration settings
IPSetting.INI	Root directory on USB stick	-	File with settings for IP assignment
starter.bat	Root directory on FlashDrv	-	Starts a user-defined application on startup
project.bat	Root directory on FlashDrv	-	Starts a user-defined application from within the launcher

2.5 Identification

The operating device can be identified using the nameplate on the rear of the device.

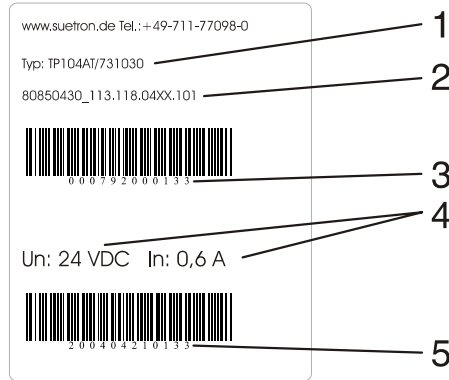
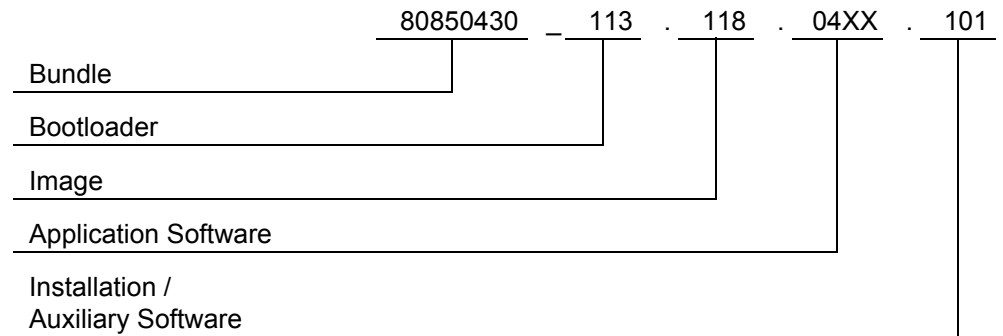

Figure 2-48 Nameplate (example)

- 1 Order number
- 2 Version key (at time of delivery)
- 3 MAC address
- 4 Voltage and power specification
- 5 Serial number

2.5.1 Version Key

The version key provides information on the version level of various components at time of delivery.



3 Control and Display Elements

3.1 Keyboard

The keys are positioned under an environmental-proof polyester foil. You project the operating principle of the keys in the programming software.

3.1.1 Editing Keys

- ()°**
0 The key **0 and ()°** is used for changing data in the editor. The (,) and ° characters can be entered when configuring the **Shift** or **ShiftCase** system variables.
- STU**
1 The key **1 and STU** is used for changing data in the editor. The S, T and U characters can be entered when configuring the **Shift** or **ShiftCase** system variables.
- VWX**
2 The key **2 and VWX** is used for changing data in the editor. The V, W and Y characters can be entered when configuring the **Shift** or **ShiftCase** system variables.
- YZ%**
3 The key **3 and YZ%** is used for changing data in the editor. The Y, Z and % characters can be entered when configuring the **Shift** or **ShiftCase** system variables.
- JKL**
4 The key **4 and JKL** is used for changing data in the editor. The J, K and L characters can be entered when configuring the **Shift** or **ShiftCase** system variables.
- MNO**
5 The key **5 and MNO** is used for changing data in the editor. The M, N and O characters can be entered when configuring the **Shift** or **ShiftCase** system variables.
- PQR**
6 The key **6 and PQR** is used for changing data in the editor. The P, Q and R characters can be entered when configuring the **Shift** or **ShiftCase** system variables.
- ABC**
7 The key **7 and ABC** is used for changing data in the editor. The A, B and C characters can be entered when configuring the **Shift** or **ShiftCase** system variables.
- DEF**
8 The key **8 and DEF** is used for changing data in the editor. The D, E and F characters can be entered when configuring the **Shift** or **ShiftCase** system variables.
- GHI**
9 The key **9 and GHI** is used for changing data in the editor. The G, H and I characters can be entered when configuring the **Shift** or **ShiftCase** system variables.
- :?!
▪** The key **Decimal point and :?!
▪** is used for changing data in the editor. The characters ;, ? and ! can be entered when configuring the **Shift** or **ShiftCase** system variables.

 The key **Plus and <=>** is used for changing data in the editor. The characters <, = and > can be entered when configuring the **Shift** or **ShiftCase** system variables.



 The key **Minus and */** is used for changing data in the editor. The characters \, * and / can be entered when configuring the **Shift** or **ShiftCase** system variables.





Only valid for BT03AM:

 The key **Minus** is used to enter negative values within the editor. In the increment editor, the variable value is decreased by 1. When the key is held down, the function is repeated at an automatically increasing rate of repetition.

 The key **Plus** is used to enter positive values within the editor. In the increment editor, the variable value is increased by 1. When the key is held down, the function is repeated at an automatically increasing rate of repetition.

3.1.2 Control Keys

 The key **Cursor left** can be configured to directly call up any screen. In the editor, it moves the cursor one character to the left (character selection). This function corresponds to the system variable **KeyCursLeft**.

 The key **Cursor right** can be configured to directly call up any screen. In the editor, it moves the cursor one character to the right (character selection). This function corresponds to the system variable **KeyCursRight**.



 The key **Cursor down** can be configured to directly call up any screen. In the editor, it moves the cursor down one variable (variable selection). This function corresponds to the system variable **KeyCursDown**.



 The key **Cursor up** can be configured to directly call up any screen. In the editor, it moves the cursor up one variable (variable selection). This function corresponds to the system variable **KeyCursUp**.

 The key **Cursor home** can be configured to directly call up any screen. In the editor it returns the cursor to the first input variable position. This function corresponds to the system variable **KeyHome**.

 The key **Page down** can be configured to page through tables, recipes and messages. This function corresponds to the system variable **TabPgDn**.

3.1.3 Special Keys

  The key **Help** always shows the current help text (online help). A flashing LED indicates that there are system messages. The system message is output in plain text.

  The key **Data Release** changes from the menu into the editor. The integrated LED is lit during edit mode. Pressing this key in edit mode exits the editor.



The key **Enter** is used to complete data entry. Pressing this key while the startup screen is displayed opens the setup screen.



The key **Delete** deletes the character beneath the cursor in the editor and removes the selected messages from the data memory.



The key **Print** can be configured as a soft key to activate various print jobs. The LED flashes when a print process is active.

3.1.4 Function Keys



The function of function keys can be assigned as required (soft key functionality). The function keys can optionally be used as direct selection keys for menu control or to trigger a function in the controller.

3.1.4.1 Slide-in Identification Strips for the Function Keys

The identification strips can be replaced when the operating device is removed. Inserting the strip from the rear side of the front plate does not influence the specified seal of the operator terminal. A set of identification strips is supplied with the operator terminal.

For the labeling use:

Single pieces, prototypes	Label with a water-resistant pen
Small series	Copying foil (thickness $\leq 70 \mu\text{m}$) with laser print
Large series	Customer-specific labeled identification strips

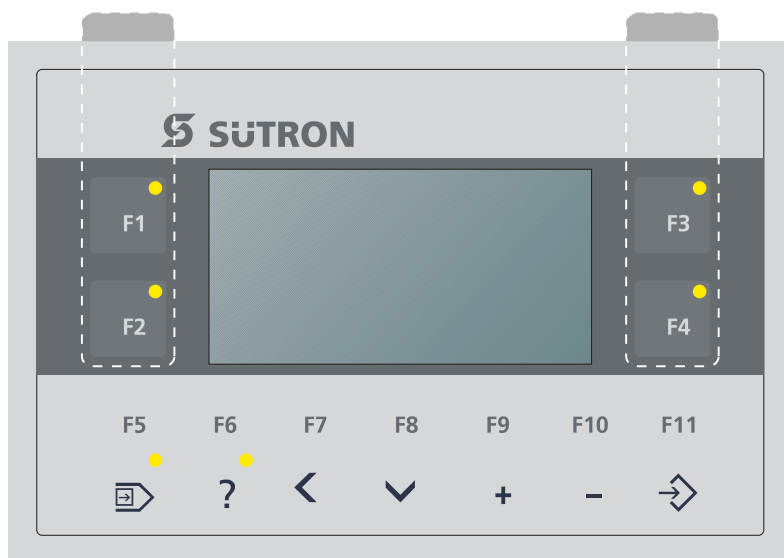

Figure 3-1 Lage der Einschubstreifen im BT03AM

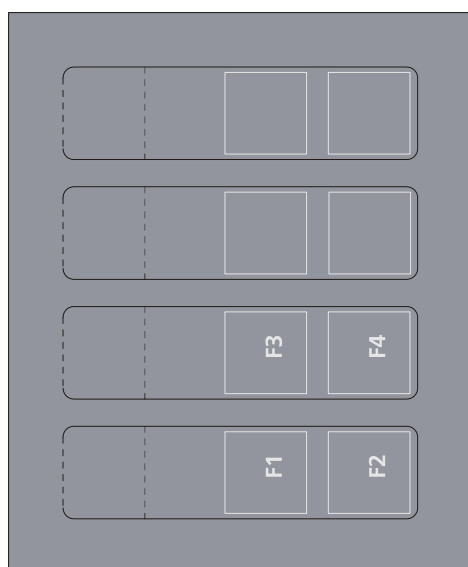

Figure 3-2 Einschubstreifenatz für BT03AM

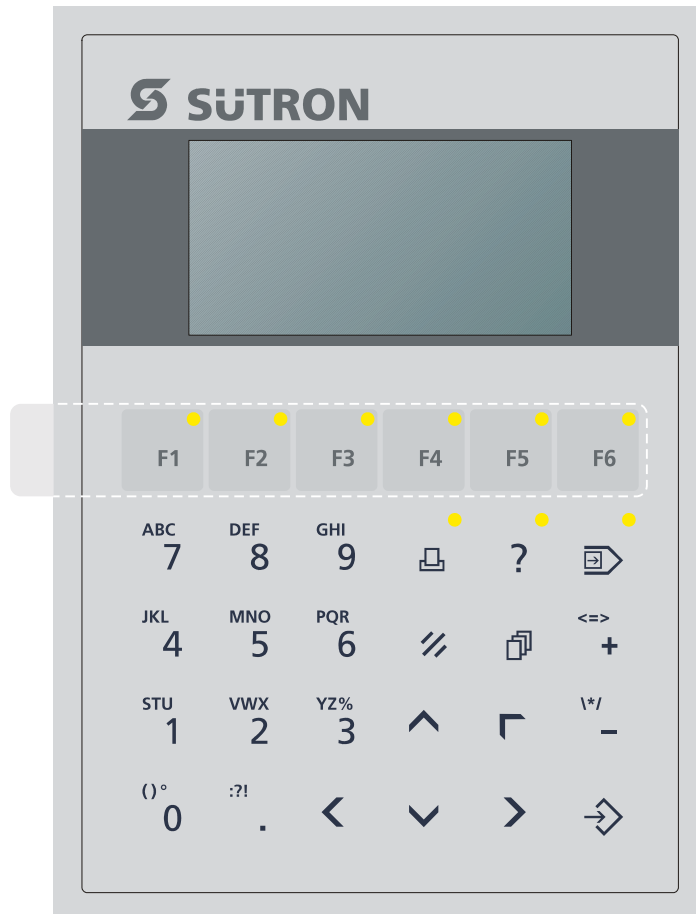

Figure 3-3 Lage der Einschubstreifen im BT05AM

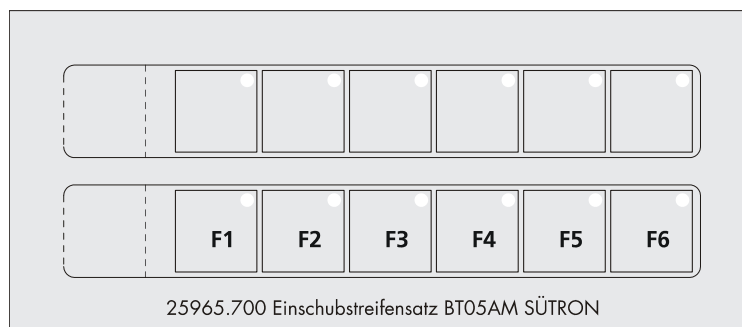

Figure 3-4 Einschubstreifensatz für BT05AM



Figure 3-5 Lage der Einschubstreifen im BT07AM

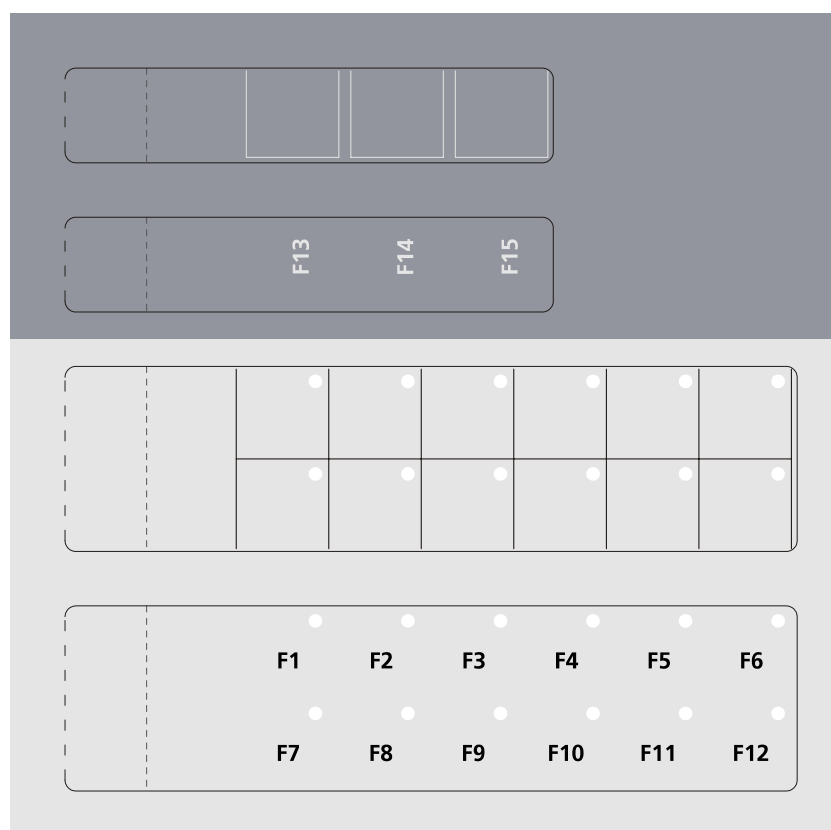

Figure 3-6 Einschubstreifensatz für BT07AM

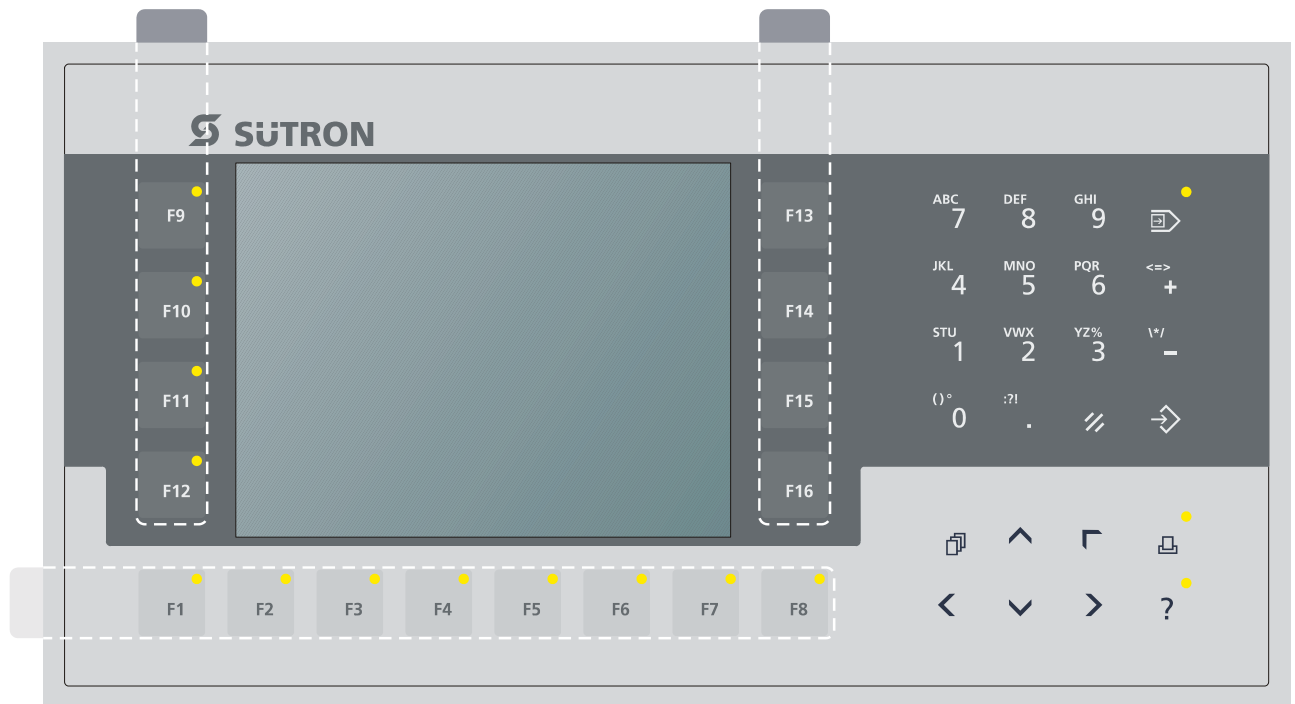

Figure 3-7 Lage der Einschubstreifen im BT21AM, BT21AS

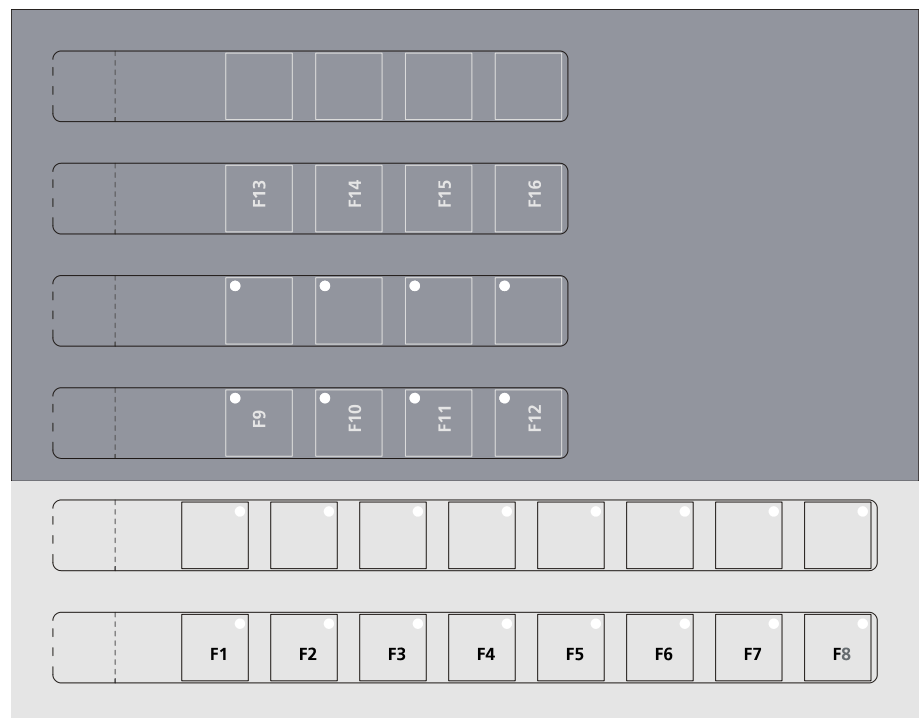

Figure 3-8 Einschubstreifenatz für BT21AM, BT21AS

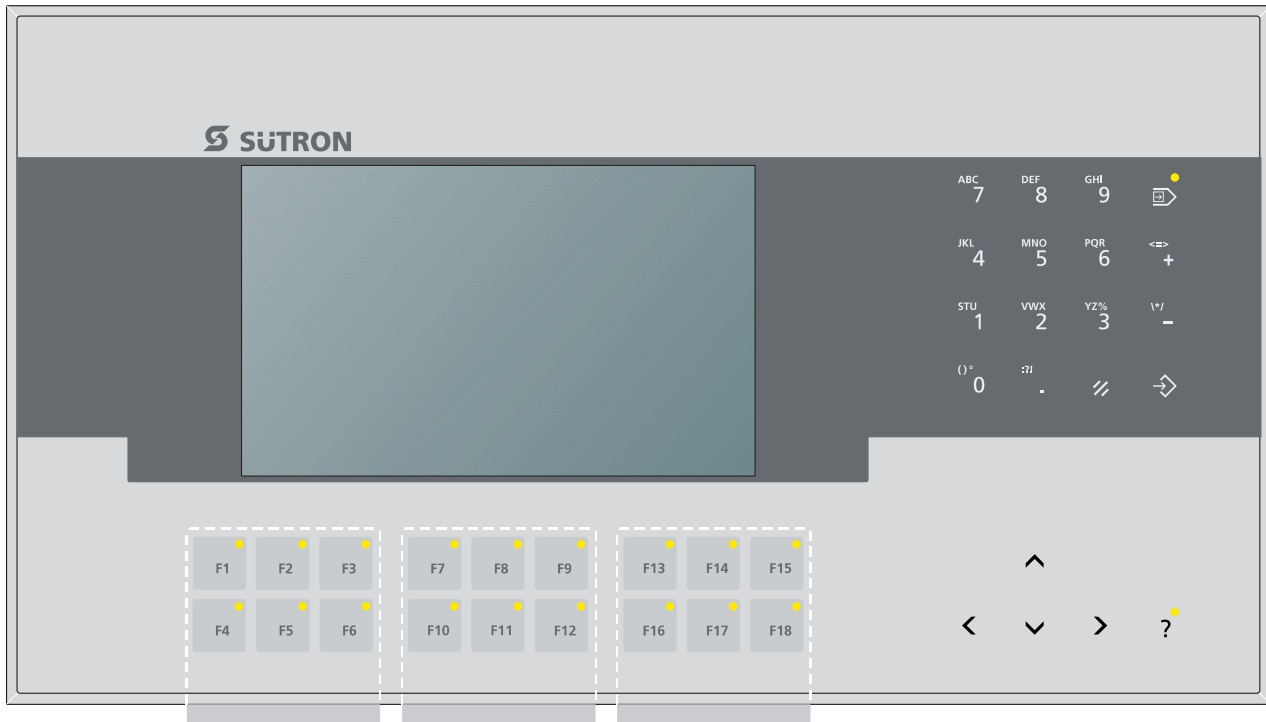

Figure 3-9 Lage der Einschubstreifen im BT70AT

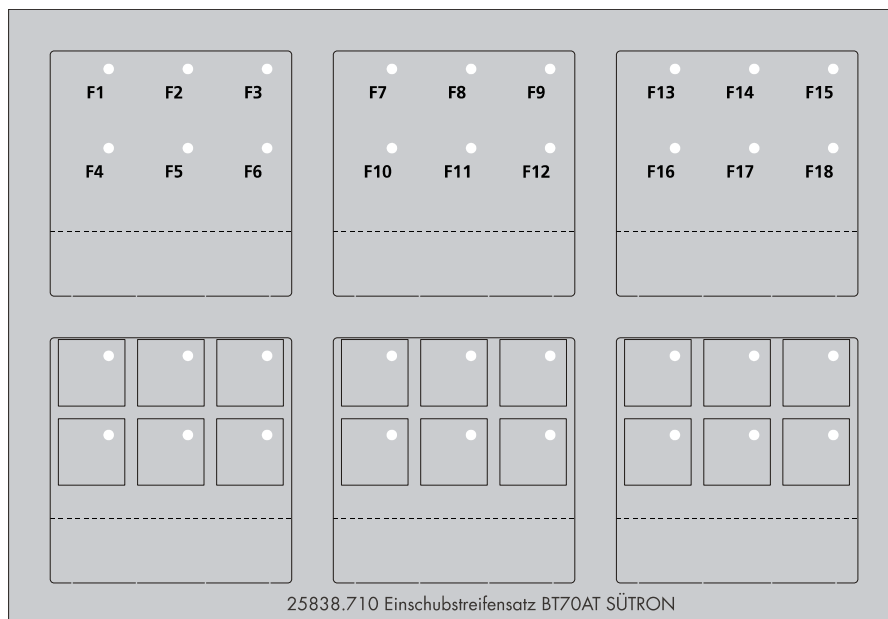

Figure 3-10 Einschubstreifensatz für BT70AT

3.2 Display



DANGER: Toxic

If the display is damaged, avoid touching, swallowing or breathing in the liquids or gases which may leak out!



DANGER: Corrosive

If the display is damaged, avoid touching, swallowing or breathing in the liquids or gases which may leak out!

The operating device is equipped with different displays depending on variant.

3.2.1 Setting the Brightness

To be able to set the brightness, you need to use the programming software to setup the system variable **LcdBackLight** in a screen of your choice.



To do so, follow the instructions listed in the programming software's help topic "How do I specify the contrast / brightness setting for the operating device".

In the programming software, enter the following values as lower and upper limits for the representation type.

Table 3-1 Values for the representation type

System Variable	Lower Limit	Upper Limit	Default Setting
LcdBackLight	+ 1	+ 31	+ 15



If you do not configure the system variable **LcdBackLight**, the default setting is used when the device is initialized.



Adjust the brightness to the surrounding conditions at reached operating temperature to be able to read the display optimally.

If you did set up the system variable, you can set the brightness as follows. Open the screen where you set up the system variable and:

1. Press the Data Release key if the data release is not automatically active.
2. Enter a new value for the brightness. To do so, use the keys Plus and Minus.
3. Press the Enter key.
4. Finally press the Data Release key.

The new brightness setting becomes effective immediately after the Enter key is pressed. If necessary, repeat steps 2 and 3 until you are satisfied with the brightness.

3.2.2 Setting the Contrast

To be able to set the contrast, you need to use the programming software to setup the system variable **LcdContrast** in a screen of your choice.



To do so, follow the instructions listed in the programming software's help topic "How do I specify the contrast / brightness setting for the operating device".

In the programming software, enter the following values as lower and upper limits for the representation type.

Table 3-2 Values for the representation type

System Variable	Lower Limit	Upper Limit	Default Setting
LcdContrast	+ 1	+ 31	+ 15



If you do not configure the system variable **LcdContrast**, the default setting is used when the device is initialized.



Adjust the contrast to the surrounding conditions at reached operating temperature to be able to read the display optimally.

If you did set up the system variable, you can set the contrast as follows. Open the screen where you set up the system variable and:

1. Press the Data Release key if the data release is not automatically active.
2. Enter a new value for the contrast. To do so, use the keys Plus and Minus.
3. Press the Enter key.
4. Finally press the Data Release key.

The new contrast setting becomes effective immediately after the Enter key is pressed. If necessary, repeat steps 2 and 3 until you are satisfied with the contrast.

3.2.3 Character Attributes

The following character attributes can be displayed on the operating device:

- Flashing
- Underline
- Foreground/background color

3.2.4 Fonts

You can use Windows fonts. Windows and unicode character sets are possible.

4 Interfaces of the Device

Depending on the device variant, several interfaces are available to you:

Table 4-1 Device Variants

Order Number	Available Interfaces								
	Ethernet (X5)	RS485, RS232 (X6)	CAN (X6)	DeviceNet (X6)	INTERBUS (X6, X7)	MPI (X6)	PROFIBUS-DP (X6)	KNX (X6)	USB (X9, X10)
BTxxAx/70xxxx	X	-	-	-	-	-	-	-	X
BTxxAx/78xxxx	X	X	-	-	-	-	-	-	X
BTxxAx/74xxxx	X	-	X	-	-	-	-	-	X
BTxxAx/75xxxx	X	-	-	X	-	-	-	-	X
BTxxAx/76xxxx	X	-	-	-	X	-	-	-	X
BTxxAx/73xxxx	X	-	-	-	-	X	-	-	X
BTxxAx/72xxxx	X	-	-	-	-	-	X	-	X
BTxxAx/80xxxx	X	-	-	-	-	-	-	X	X

4.1 Standard Interfaces

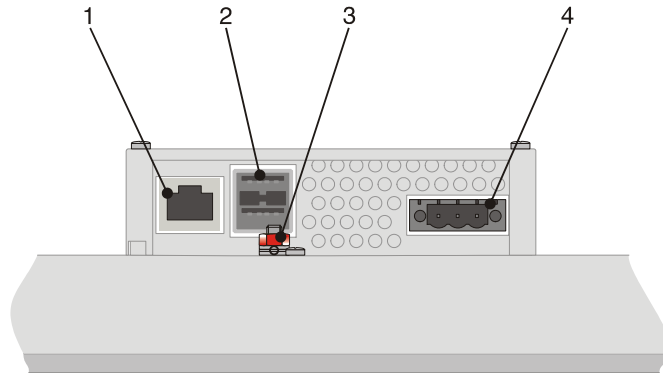

Figure 4-1 Rear view Ethernet

- 1 Female Connector X5 (Ethernet)
- 2 Female Connector X9, X10 (USB Host - Type A)
- 3 Threaded Bolt for Protective Grounding
- 4 Connector X1 (Supply Voltage)

4.1.1 Ethernet (X5)

A 10/100 Base-T Ethernet interface is located at the operating device.

4.1.1.1 Pin Assignment

Connector in the operating device: RJ45 female connector.

Table 4-2 Assignment of the Ethernet interface

Pin	Designation	Function
1	Tx+	Transmitted Data, Positive Polarity
2	Tx-	Transmitted Data, Negative Polarity
3	Rx+	Received Data, Positive Polarity
4	n.c.	Not Connected
5	n.c.	Not Connected
6	Rx-	Received Data, Negative Polarity
7	n.c.	Not Connected
8	n.c.	Not Connected

4.1.1.2 Cable



NOTICE

Use a twisted pair cable of category 5 or 6 (CAT 5 or 6). The maximum cable length is 100 m (328.084 feet).



See the IEEE 802.3 standard for further information.

4.1.1.3 Diagnostics

Ethernet diagnostics LEDs are located at the operating device.

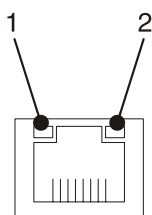

Figure 4-2 Position of the ethernet diagnostics LEDs

Table 4-3 Function of the ethernet diagnostics LEDs

No.	Color	State	Designation	Function
1	Green	ON	XMT	Sending ethernet data telegram
2	Yellow	ON	RCV	Receiving ethernet data telegram

4.1.2 USB (X9, X10)

Two host interfaces are available on the operating device.



NOTICE

Using input devices not suitable for industrial use (e.g. keyboard, mouse) may decrease safety of operation. This includes input devices intended for home and office use.

4.1.2.1 Cable



For the specification of a suitable cable, please refer to the „Universal Serial Bus Specification Rev. 2.0“.



NOTICE

The maximum cable length for the cable used is 2.5 m (8.202 feet).

4.2 Serial Interfaces

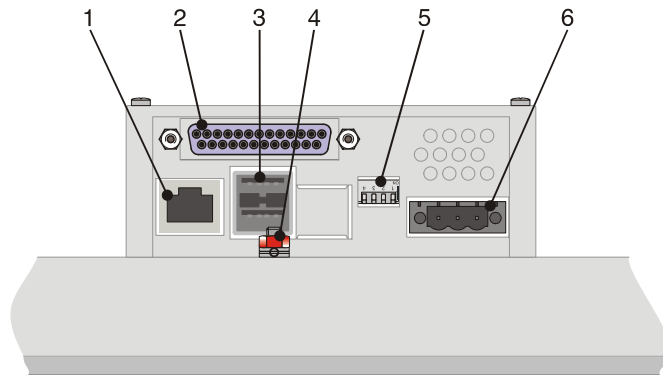

Figure 4-3 Rear view RS422 / RS485 / RS232

- 1 Female Connector X5 (Ethernet)
- 2 Female Connector X6 (Serial Interface)
- 3 Female Connectors X9, X10 (USB Host - Type A)
- 4 Threaded Bolt for Protective Grounding
- 5 Termination Switch (RS422/RS485)
- 6 Connector X1 (Supply Voltage)

4.2.1 RS422 / RS485 (X6)

The interface standard RS422 / RS485 is suitable for point-to-point and multi-point connections.

The wires belonging together are marked with „A“ and „B“. Some descriptions refer to the pins with „-“ and „+“ , where A = - and B = +.

Signal Logic 1 $U_A - U_B \leq -0.3 \text{ V}$ i.e. ($U_A < U_B$)

Signal Logic 0 $U_A - U_B \geq +0.3 \text{ V}$ i.e. ($U_A > U_B$)

4.2.1.1 Pin Assignment

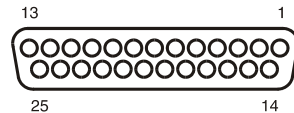

Figure 4-4 25 pin D-SUB female connector strip

Connector in the operating terminal: 25-pin D-SUB female connector

Table 4-4 Pin assignment RS422/RS485

Pin	Designation	Function		
8	T(A)	Transmitted Data	-	N
9	T(B)	Transmitted Data	+	P
11	SGND	Signal Ground		
22	R(A)	Received Data	-	N
23	R(B)	Received Data	+	P



NOTICE

For the operation of the interface as RS422 / RS485 the pins of the RS232 must not be connected.



NOTICE

The D-SUB connector strips must be shielded sufficiently. See chapter “Shielding D-SUB Connectors“ on page 4-21.

4.2.1.2 Termination

Always turn on the termination in a 4-wire point-to-point connection (RS422 / RS485). A sender termination for the quiescent level of the receiver must exist on the remote station.

Turn on the termination only at the two ends of the lines in a 2 or 4-wire multi-point connection (RS422 / RS485).

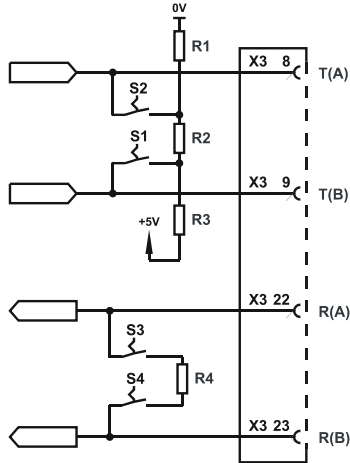

Figure 4-5 Termination possibilities RS422 / RS485 (internal)

Table 4-5 Resistor values - termination RS422 / RS485

Designation	Value
R1, R3	510 Ohm
R2	150 Ohm
R4	120 Ohm



The switch positions for ON or OFF are printed onto the termination switch. Only the specified switch positions are allowed.

Table 4-6 Termination switch

Bus	S1	S2	S3	S4	Function
	Transmitter		Receiver		
2-wire 4-wire –	OFF	OFF	OFF	OFF	Termination is OFF – Line termination is assured by other participants – The quiescent level is ensured by external wiring – RS422 / RS485 unused
2-wire	ON	ON	OFF	OFF	Transmitter Termination is ON (Guarantees quiescent level) Receiver Termination is OFF
4-wire	ON	ON	ON	ON	Transmitter Termination is ON Receiver Termination ON (Point-to-point or multi-point connection at the end of the line)

4.2.2 RS232 (X6)

The serial RS232 interface is suitable to establish a point-to-point connection.

4.2.2.1 Pin Assignment

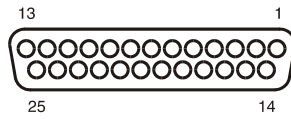

Figure 4-6 25 pin D-SUB female connector strip

Connector in the operating terminal: 25-pin D-SUB female connector

Table 4-7 Pin assignment RS232

Pin	Designation	Function
6	TD	Transmitted Data
15	CTS	Clear to Send
17	RTS	Request to Send
18	RD	Received Data
25	SGND	Signal Ground



NOTICE

For the operation of the interface as RS232 the pins of the RS422 / RS485 must not be connected.



NOTICE

The D-SUB connector strips must be shielded sufficiently. See chapter "Shielding D-SUB Connectors" on page 4-21.

4.2.2.2 Termination



NOTICE

When the interface is operated as a RS232, the termination for the RS485 must be switched OFF.

4.3 Field Bus Interfaces

4.3.1 CAN Slave (X6)

The CAN bus is a high speed bus in accordance with ISO-DIS 11898.

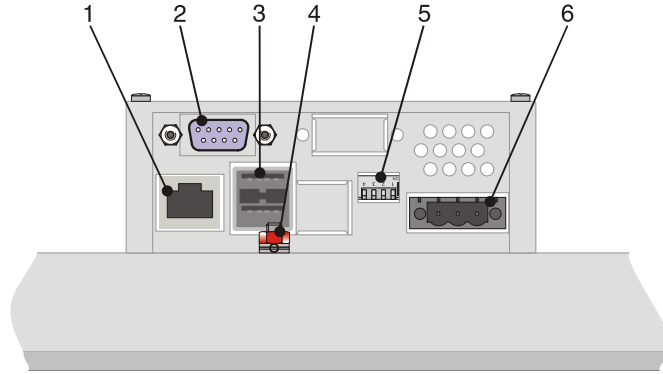

Figure 4-7 Rear view CAN Slave

- 1 Female Connector X5 (Ethernet)
- 2 Connector X6 (CAN)
- 3 Female Connectors X9, X10 (USB Host - Type A)
- 4 Threaded Bolt for Protective Grounding
- 5 Slope Control Switch (CAN)
- 6 Connector X1 (Supply Voltage)

4.3.1.1 Pin Assignment

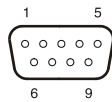

Figure 4-8 9 pin D-SUB male connector strip

Connector in the terminal: 9 pin D-SUB male connector

Table 4-8 Pin assignment CAN

Pin	Designation	Function
1	nc	Not Connected
2	CAN_L	CAN_L Bus Line
3	CAN_GND	CAN Ground
4	nc	Not Connected
5	nc	Not Connected
6	CAN_GND	CAN Ground
7	CAN_H	CAN_H Bus Line
8	nc	Not Connected
9	nc	Not Connected



NOTICE

The D-SUB connector strips must be shielded sufficiently. See chapter “Shielding D-SUB Connectors” on page 4-21.

4.3.1.2 Cable



NOTICE

A shielded twisted-pair cable (cable type LiYCY-TP) complying with ISO 11898 must be used.

The cable must have the following characteristics:

Table 4-9 Cable characteristics CAN

Parameters	Value
Impedance	Min.: 108 Ohm Nom.: 120 Ohm Max.: 132 Ohm
Specific Resistance	70 mOhm/m
Specific Line Delay	5 ns/m

The maximum cable length depends on the baud rate used.

Table 4-10 Baud rate CAN

Baud rate	Cable length
20 kBit/s	1000 m
125 kBit/s	500 m
250 kBit/s	250 m
500 kBit/s	100 m
1000 kBit/s	25 m

4.3.1.3 Termination

Terminate the CAN bus at both ends by terminating resistors (120 Ohm).

Table 4-11 Termination switch

S1	S2	S3	S4	Function
X	X	I	X	Termination (120 Ohm)
X	X	–	X	No Termination

Legend for table:

- I = Switch ON
- = Switch OFF
- X = Any position

4.3.1.4 Diagnostics

A diagnostics LED is located on the rear of the operating device. The LED shows the states of the bus system.

The diagnostics LED on the operating device has the following functions:

Table 4-12 Functions of the CAN diagnostics LED

Color	State	Function
Green	Off	Terminal Disconnected from Bus
Green	On	Communication Active
Green	Flashing	Sporadic Bus Error

4.3.1.5 Slope Control

The slope control switch is located on the rear of the operating device.

You can use the slope control switch to set the edge steepness of the CAN signals. By default, the operating devices are used with the switch set to "High".

Table 4-13 Slope control switch

S1	S2	S3	S4	Function
X	X	X	I	High speed
X	X	X	–	Low speed

Legend for table:

I = Switch ON

– = Switch OFF

X = Any position

4.3.2 DeviceNet Slave (X6)

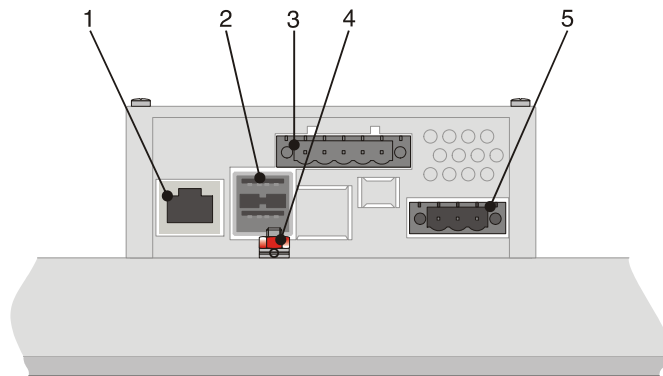

Figure 4-9 Rear view DeviceNet slave

- 1 Female Connector X5 (Ethernet)
- 2 Female Connectors X9, X10 (USB Host - Type A)
- 3 Connector X6 (DeviceNet)
- 4 Threaded Bolt for Protective Grounding
- 5 Connector X1 (Supply Voltage)

4.3.2.1 Pin Assignment

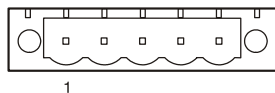

Figure 4-10 5 pin connector

Connector in the operating terminal: 5 pin male connector strip.

Table 4-14 Pin assignment DeviceNet

Pin	Designation	Function
1	nc	Not Connected
2	CAN_L	CAN_L Bus Line
3	Drain	Shield
4	CAN_H	CAN_H Bus Line
5	nc	Not Connected



For the connection, use a 5 pin connector with gold-plated contacts and cover cap. A suitable connector with cover cap can be obtained directly from Süttron electronic.

4.3.2.2 Cable



NOTICE

A DeviceNet-certified cable must be used.

Table 4-15 Data line DeviceNet

Cable Type	Loop Resistance	Surge Impedance	Capacitance per Unit Length
2 x 1.1 mm	< 22.6 Ohm/km	120 Ohm	< 39.4 pf/m
2 x 0.6 mm	< 91.8 Ohm/km	120 Ohm	< 39.4 pf/m

The maximum length allowed for spur lines connected to the bus cable is 6 meters. The overall length of the bus cable including all spur lines is not to exceed the maximum length listed in the table below.

The maximum cable length depends on the baud rate and the cable type used.

Table 4-16 Baud rate DeviceNet

Baud Rate	Cable Type	Cable Length
125 kBit/s	2 x 1.1 mm	500 m
	2 x 0.6 mm	100 m
250 kBit/s	2 x 1.1 mm	250 m
	2 x 0.6 mm	100 m
500 kBit/s	2 x 1.1 mm	100 m
	2 x 0.6 mm	100 m

4.3.2.3 Termination

Terminate the DeviceNet bus at both ends directly at the connector by terminating resistors (120 Ohm).

4.3.2.4 Diagnostics

A diagnostics LED is located on the rear of the operating device. The LED shows the states of the bus system.

The diagnostics LED on the operating device has the following functions:

Table 4-17 Functions of the DeviceNet diagnostics LED

Color	State	Function
Green	Off	Terminal is Disconnected from Bus
Green	On	Communication Active
Green	Flashing	Sporadic Bus Error

4.3.3 INTERBUS Slave (X6, X7)

The device can be integrated into the INTERBUS using the interfaces available for INTERBUS connections.

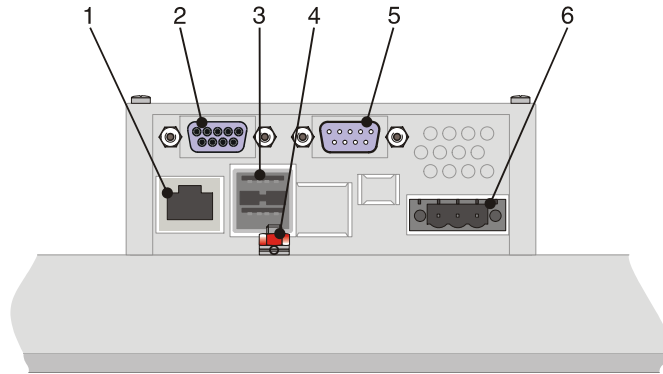

Figure 4-11 Rear view INTERBUS

- 1 Female Connector X5 (Ethernet)
- 2 Female Connector X6 (INTERBUS - Remotebus Out)
- 3 Female Connector X9, X10 (USB Host - Type A)
- 4 Threaded Bolt for Protective Grounding
- 5 Male Connector X7 (INTERBUS - Remotebus In)
- 6 Connector X1 (Supply Voltage)

4.3.3.1 Pin Assignment

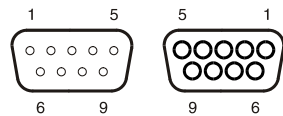

Figure 4-12 9 pin D-SUB male connector strip and female connector strip

Connector in the terminal: 9 pin D-SUB male connector strip for remote bus in.

Table 4-18 Pin assignment remote bus in (INTERBUS)

Pin	Designation	Function
1	DO	Data Input
2	DI	Data Output
3	GND	Ground
4	nc	Not Connected
5	nc	Not Connected
6	/DO	Data Input, Inverted
7	/DI	Data Output, Inverted
8	nc	Not Connected
9	nc	Not Connected

Connector in the terminal: 9 pin D-SUB female connector strip for remote bus out.

Table 4-19 Pin assignment remote bus out (INTERBUS)

Pin	Designation	Function
1	DO	Data Output
2	DI	Data Input
3	GND	Ground
4	nc	Not Connected
5	+5 V	Power Supply +5 VDC
6	/DO	Data Output, Inverted
7	/DI	Data Input, Inverted
8	nc	Not Connected
9	RBST	Remote Bus Status



NOTICE

The D-SUB connector strips must be shielded sufficiently. See chapter “Shielding D-SUB Connectors“ on page 4-21.

4.3.3.2 Cable



NOTICE

A shielded twisted-pair cable (cable type LiYCY-TP) must be used. The maximum cable length depends on its use within the INTERBUS topology.

4.3.3.3 Diagnostics

The diagnostics LEDs are located at the rear of the operating device. The LEDs show the states of the bus system.

The diagnostics LEDs at the operating device has the following functions:

Table 4-20 Functions of the INTERBUS diagnostics LEDs

Designation	Color	State	Function
RC	Green	On	Remote Bus Check
+5 V	Green	On	Supply Voltage OK
		Off	No Supply Voltage
BA	Green	On	Bus Active
		Off	Bus Not Active
RD	Red	On	Remote Bus Inactive
TR	Green	On	PCP Active (Module Receives / Transmits Data)
		Off	PCP not Active

4.3.4 MPI Slave (X6)

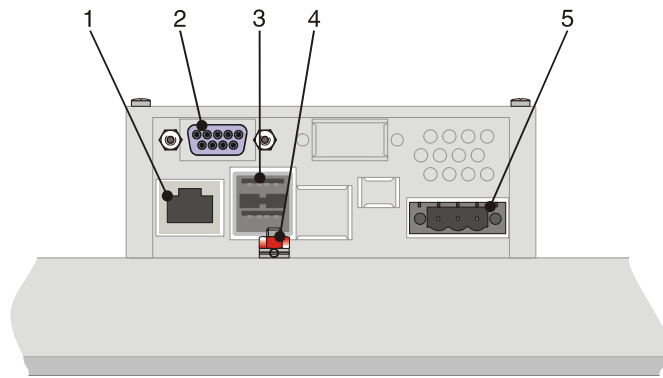

Figure 4-13 Rear view MPI slave

- 1 Female Connector X5 (Ethernet)
- 2 Female Connector X6 (MPI)
- 3 Female Connectors X9, X10 (USB Host - Type A)
- 4 Threaded Bolt for Protective Grounding
- 5 Connector X1 (Supply Voltage)

4.3.4.1 Pin Assignment

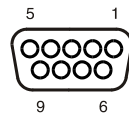

Figure 4-14 9 pin D-SUB female connector strip

Connector in the terminal: 9 pin D-SUB female connector

Table 4-21 Pin assignment MPI

Pin	Designation	Function
1	nc	Not Connected
2	nc	Not Connected
3	RxD/TxD-P	Received Data / Transmitted Data Plus
4	CNTR-P	Repeater Control Signal Plus
5	DGND	Data Transmission Potential
6	VP	Supply Voltage of Terminators Plus
7	nc	Not Connected
8	RxD/TxD-N	Received Data / Transmitted Data Minus
9	CNTR-N	Repeater Control Signal Minus



NOTICE

The D-SUB connector strips must be shielded sufficiently. See chapter “Shielding D-SUB Connectors” on page 4-21.

4.3.4.2 Cable



NOTICE

Any cable that conforms with the following parameters can be used:

Table 4-22 Cable characteristics MPI

Parameters	Value
Loop Resistance	110 Ohm/km
Capacitance	30 nF/km
Surge Impedance	150 Ohm

The maximum length of one segment is 50 m which cannot be exceeded. This 50 m applies from the first node to the last node in the segment.



For further information on the installation, please refer to the Siemens manual "SIMATIC S7-400 and M7-400 Programmable Controllers Hardware and Installation, 6ES7498-8AA03-8BA0".

4.3.4.3 Termination

The bus line is terminated at the connector.

For point-to-point connections, always activate the termination. For multi-point connections, only activate the termination at the cable end. For spur lines, always deactivate the termination.

4.3.4.4 Diagnostics

A diagnostics LED is located on the rear of the operating device. The LED shows the states of the bus system.

The diagnostics LED on the operating device has the following functions:

Table 4-23 Function of the MPI diagnostics LED

Color	State	Function
Green	Flashing	Operating Device has the Token

4.3.5 PROFIBUS-DP Slave (X6)

The interface for PROFIBUS-DP connections is available to integrate the device into a PROFIBUS-DP structure.

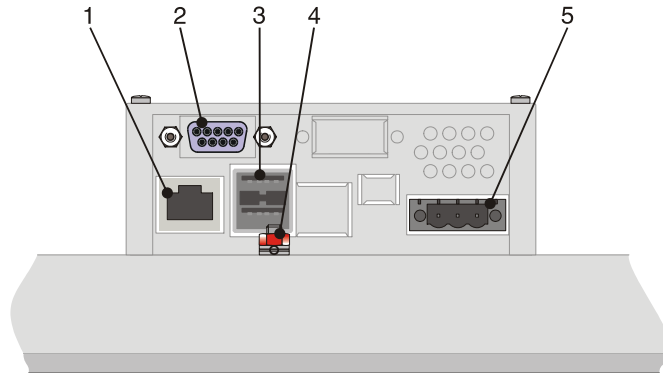

Figure 4-15 Rear view PROFIBUS-DP

- 1 Female Connector X5 (Ethernet)
- 2 Female Connector X6 (PROFIBUS)
- 3 Female Connectors X9, X10 (USB Host - Type A)
- 4 Threaded Bolt for Protective Grounding
- 5 Connector X1 (Supply Voltage)

4.3.5.1 Pin Assignment

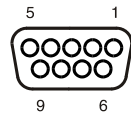

Figure 4-16 9 pin D-SUB female connector strip

Connector in the operating device: 9 pin D-SUB female connector.

Table 4-24 Pin assignment PROFIBUS-DP

Pin	Designation	Function
1	nc	Not Connected
2	nc	Not Connected
3	RxD/TxD-P	Received Data / Transmitted Data Plus (+) (red)
4	CNTR-P	Repeater Control Signal Plus (+)
5	DGND	Ground for data signals and VP
6	VP	Supply Voltage (+5 V) of Terminators Plus
7	nc	Not Connected
8	RxD/TxD-N	Received Data / Transmitted Data Minus (-) (green)
9	CNTR-N	Repeater Control Signal Minus (-)



NOTICE

The D-SUB connector strips must be shielded sufficiently. See chapter “Shielding D-SUB Connectors” on page 4-21.

4.3.5.2 Cable



NOTICE

Any PROFIBUS-DP-approved cables specified in the EN 50170 as cable type A can be used.

Table 4-25 Cable characteristics PROFIBUS

Parameters	Value
Impedance	136 to 165 Ohm
Capacitance	< 30 pf/m
Loop Resistance	110 Ohm/km
Wire Gauge	0.64 mm

The maximum cable length depends on the baud rate (DIN EN 19245 Part 3).

Table 4-26 Baud rate PROFIBUS-DP

Baud Rate	Cable Length
187.5 kBit/s	1000 m
500 kBit/s	400 m
1500 kBit/s	200 m
3000 to 12000 kBit/s	100 m

4.3.5.3 Termination

Terminate the PROFIBUS at both ends by terminating resistors. If you are using special PROFIBUS connectors, these resistors are usually integrated into the connector and can be connected.

4.3.5.4 Diagnostics

A diagnostics LED is located on the rear of the operating device. The LED shows the states of the bus system.

The diagnostics LED on the operating device has the following functions:

Table 4-27 Function of the PROFIBUS-DP diagnostics LED

Color	State	Function
Green	ON	Communication Active

4.3.6 KNX (X6)

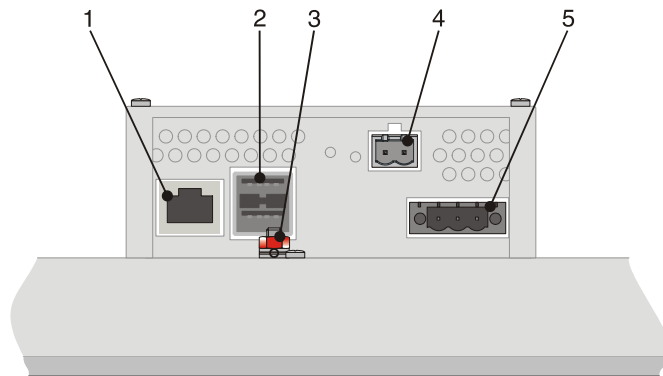

Figure 4-17 Rear view KNX

- 1 Female Connector X5 (Ethernet)
- 2 Female Connectors X9, X10 (USB Host - Type A)
- 3 Threaded Bolt for Protective Grounding
- 4 Male Connector X6 (KNX)
- 5 Connector X1 (Supply Voltage)

4.3.6.1 Pin Assignment



1
Figure 4-18 2 pin male connector strip

Connector in the operating device: 2 pin male connector strip.

Table 4-28 Pin assignment KNX

Pin	Designation	Function
1	-	Ground
2	+	Supply Voltage/ Communication

4.4 Shielding D-SUB Connectors

You must shield D-SUB connectors as follows:

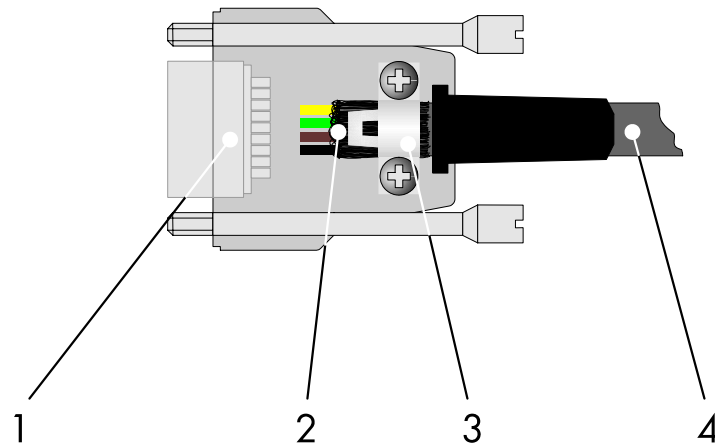

Figure 4-19 Shielding D-SUB connectors

- 1 D-SUB connector
- 2 Shield
- 3 Cable clip
- 4 Cable

The shield must be folded back into a flat position over the cable sheath.

When fastening the cable with the cable clip, as much of the shielding as possible must be in contact with the housing and sufficient strain relieve must be ensured.

5 Maintenance and Servicing

5.1 Front Panel

Only use a damp cloth to remove any dirt from the front panel.

5.2 Fuse

**NOTICE: Damage**

The semiconductor fuse cannot be replaced!

A semiconductor fuse is used to protect the device. Once the fuse has been tripped, the device must be disconnected from the supply voltage to allow the semiconductor fuse to regenerate. At an ambient temperature of 20 °C (68 °F), the regeneration takes approximately 20 seconds. The higher the ambient temperature, the longer the regeneration takes.

5.3 Battery

The built-in battery preserves the data in the SRAM and supplies the real-time clock with power. The minimum battery life is 5 years, even under unfavorable operating conditions. When the battery runs down, the message "Change battery" is generated automatically.

We recommend you change the battery approximately every 4 years as part of the regular maintenance work. A prepared battery including connector can be obtained directly from Süttron electronic.

If the "Change battery" message is detected too late, data in the SRAM may have already been lost. For this reason, after changing a battery, always check data such as editable passwords, parameters in the system variables, data sets of the recipes and entries in the message system.

5.3.1 Changing the Battery



CAUTION: Explosive

Do not throw lithium batteries into fire, do not heat to 100 °C or higher and do not recharge.



CAUTION: Toxic

Do not open lithium batteries.



NOTICE: Damage

Batteries must only be changed by authorized and trained experts!



NOTICE: Damage

For changing the battery you may only use replacement batteries of Süttron electronic.



NOTICE: Damage

Electrostatic discharge can damage electronic components. Observe the ESD protective measures!

To ensure that the data in the SRAM and the time are preserved, it is possible to change the battery under operating voltage. Observe the corresponding safety notices!

1. Remove the screws on the rear of the device and lift off the enclosure cover.
2. Remove the glue strip securing the battery.
3. Disconnect the connector from the battery and remove the dead battery.
4. Plug in the cable for the new battery.
5. Use a glue strip to attach the new battery to the enclosure.
6. Place the enclosure cover back onto the device.
7. Carefully tighten the screws of the enclosure cover.

5.3.2 Battery Disposal

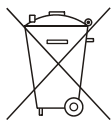

The manufacturer is obliged to mark batteries with this symbol before first placing into market. The symbol is extended by the chemical symbols if the following limiting values are exceeded:

More than 0.0005 mass percent mercury	Hg
More than 0.002 mass percent cadmium	Cd
More than 0.004 mass percent lead	Pb

Batteries can be given back free of charge after use at the place of purchase.

According to the §11 of the battery law, final consumers are obliged to give old batteries back to gathering points which attached to the common take back system or manufacturer-specific take back systems.



NOTICE: Damage

To prevent short circuitry in the collection boxes, insulate the poles of each battery with insulation tape or put each single battery into a plastic bag.

6 Technical Data

Keyboard	BT03AM	BT05AM	BT07AM	BT21AM, BT21AS	BT70AT
Type	Membrane keyboard				
Number of keys	18	30	39	40	40
Key area (raised)	11 mm (0.433") (H x W)				
Actuator travel	0.3 mm (0.012")				
Actuating force	3 N				
Switch cycles	Approx. 3 million under the following conditions: Pressing element: test plunger (DIN 42115) Pressing force: 10 N Pressing frequency: 1 Hz				
Lifetime (min.)	2 million switch cycles				
Display elements (status LEDs)	6	9	15	11	20

Display	BT03AM, BT05AM	BT07AM	BT21AM	BT21AS	BT70AT
Type	FSTN (mono)	FSTN (mono)	FSTN (mono)	C-STN (color)	TFT (color)
Resolution (pixels)	160 x 80	320 x 240	320 x 240	320 x 240	800 x 480
Colors	5 Shades of gray	5 Shades of gray	5 Shades of gray	256	65536
Reading angle	80°	80°	90°	60°	100°
Contrast setting	Tempera- ture compen- sated	Tempera- ture compen- sated	Tempera- ture compen- sated	Tempera- ture compen- sated	-
Half-life backlighting	50,000 h	30,000 h	30,000 h	40,000 h	50,000 h
Brightness in cd/m ²	45	100	140	180	400
Display area (H x W) in mm (Inch)	33,6 x 67,2 (1.323 x 2.646)	57.6 x 76.8 (2.268 x 3.024)	86.4 x 115.2 (3.402 x 4.535)	91.4 x 152.4 (3.598 x 6.0)	91.4 x 152.4 (3.598 x 6.0)

Technical Data

Electrical Data	BT03AM, BT05AM, BT07AM	BT21AM	BT21AS	BT70AT
Supply voltage	24 V DC (SELV / PELV in accordance with DIN EN 61131)			
Residual ripple	10 % maximum			
Minimum voltage	18 V			
Maximum voltage	30 V			
Power consumption (typical at 24 V)	0.25 A	0.25 A	0.4 A	0.5 A
Power consumption (maximum)	0.35 A	0.35 A	0.5 A	0.7 A
Connected load	6 W	6 W	9.6 W	12 W
Fuse	Semiconductor fuse, self-resetting			
Protection against polarity reversal	Integrated			

Ethernet	
X5 Ethernet	10/100 Base-T

Serial Interfaces	
Variable baud rates and data formats	
X6 RS422 / RS485	In accordance with DIN 66259-4 Transmission length: 0 - 1200 m, twisted pair wire, shielded, galvanically isolated
X6 RS232	In accordance with DIN 66259 T1, CCITT V.28 Transmission length: 0 - 15 m, conductors layered in strands, shielded, galvanically isolated

Field Bus Interfaces	
Variable baud rates and data formats	
X6 CAN	In accordance with ISO 11898 Galvanically Isolated
X6 DeviceNet	In accordance with ISO 11898 Galvanically isolated
X6 MPI	Galvanically isolated
X6 PROFIBUS-DP	Galvanically isolated
X6 / X7 INTERBUS	Galvanically not isolated / galvanically isolated

USB	
Corresponds to the „Universal serial bus specification Rev. 2.0“	
X9, X10 Host	Min.: 1.5 Mbit/s Max.: 12 Mbit/s Max. output current 100 mA per output

Central Processing Unit	
Central processing unit	RISC ARM9
Clock frequency	200 MHz
Other features	Watchdog timer, real-time clock, battery monitoring

Memory	
Application memory (option)	3 MByte (14 MByte)
Flash (option)	16 MByte (32 MByte)
SDRAM (option)	32 MByte (64 MByte)
SRAM (option)	512 KByte (512 KByte)

Connection System	
D-SUB female and male connector strips, 9 pin and 25 pin	
Female and male connector strips, Phoenix COMBICON / MINI COMBICON, 3 pin	
Male connector strip, Phoenix COMBICON, 5 pin	
RJ45 female connector	
USB female connector A	

Environmental Conditions	
Temperature during operation	0 °C to 50 °C (32 °F to 122 °F)
Temperature during storage, transport	- 25 °C to + 70 °C (-13°F to + 158°F)
Relative air humidity for operation and storage	20 % to 85 %, no condensation
Application area	Degree of pollution 2, overvoltage category III

Standards and Guidelines	
Interference immunity	DIN EN 61000-4-2 DIN EN 61000-4-3 DIN EN 61000-4-4 DIN EN 61000-4-5 DIN EN 61000-4-6 DIN EN 61000-6-2
Emitted interference	DIN EN 55011 limit value class A DIN EN 55022 limit value class A DIN EN 61000-6-4
Equipment requirements	DIN EN 61131-2
Storage and transportation	DIN EN 61131-2
Power supply	DIN EN 61131-2
Electromagnetic compatibility	2004/108/EG
Degrees of protection	DIN EN 60529
Impact load, shocks	DIN EN 60068-2-27
Sinusoidal vibrations	DIN EN 60068-2-6

**NOTICE: Radio Interference**

This is a class A device. This device may cause radio interference in residential areas. In this case, the user may be required to introduce appropriate countermeasures, and to bear the cost of same.

Approvals

CE, UL, cUL

Front Panel and Enclosure	BT03AM	BT05AM	BT07AM	BT21AM, BT21AS	BT70AT
Enclosure	Steel sheet, galvanized				
Front panel material	Aluminium, brushed, anodized natural finish				
Front panel (H x W x D) in mm (Inch)	96 x 144 x 5 (3.78 x 5.669 x 0.197)	168 x 120 x 5 (6.614 x 8.333 x 0.197)	205 x 155 x 5 (8.071 x 6.102 x 0.197)	160 x 300 x 5 (6.299 x 11.811 x 0.197)	210 x 380 x 5 (8.268 x 14.961 x 0.197)
Front panel cover	Polyester foil				
Seal	Circumferential rubber seal on the rear				
Mounting cutout (H x W) in mm (Inch)	82 x 136 (3.228 x 5.354)	160 x 112 (6.299 x 4.409)	199 x 139 (7.835 x 5.472)	152 x 292 (5.984 x 11.496)	202 x 372 (7.953 x 14.646)
Mounting depth	About 43 mm (1.693") Standard / field bus device: about 55 mm (2.165")				
Degree of protection	Front: IP65 Rear: IP20				
Total weight	About 500 g	About 500 g	About 800 g	About 1300 g	About 1800 g

7 Ordering Data

Table 7-1 Accessories

Description	Part No.
USB 2.0 stick 1 GB	81152.100
Battery, assembled with cable and connector (Type: CR2450)	66779.000
DeviceNet connector with cover cap	57353.005 57357.005
PROFIBUS-DP connector for bus end, straight cable outlet	57330.000
PROFIBUS-DP connector, angular cable outlet with screw connection	57234.000
PROFIBUS-DP connector, angular cable outlet with spring force connection	57234.100

A Index

A

Accessories.....	7-1
Administration operating mode	2-29

B

Battery.....	5-1
Battery disposal	5-2

C

Cable	
CAN	4-10
DeviceNet	4-13
Ethernet	4-2
INTERBUS.....	4-15
MPI	4-17
PROFIBUS	4-19
USB	4-3
Changing the battery.....	5-2
Character attributes	3-10
Connecting.....	2-13
Control keys	3-2

D

Device variants	4-1
Diagnostics	
CAN	4-10
DeviceNet	4-13
Ethernet	4-3
INTERBUS.....	4-15
MPI	4-17
PROFIBUS-DP	4-19
Dimensions	
Cutout	2-4
Front panel.....	2-2
Display	3-9

E

Editing keys.....	3-1
-------------------	-----

F

Font	
Windows	3-10
Function keys.....	3-3
Function of the AppStarter.exe program.....	2-30
Function of the TSvisLD.exe program	2-31
Fuse	5-1

I

Identification.....	2-33
Important files and update	2-32
Intended use	1-2
Interface	
CAN Slave	4-8
DeviceNet slave.....	4-12
Ethernet	4-2
INTERBUS Slave.....	4-14

KNX.....	4-20
MPI Slave.....	4-16
PROFIBUS slave	4-18
RS232	4-7
RS422	4-5
RS485.....	4-5
USB.....	4-3

K

Key	
Cursor down.....	3-2
Cursor home	3-2
Cursor left	3-2
Cursor right	3-2
Cursor up	3-2
Data release.....	3-2
Enter	3-3
Help.....	3-2
Minus	3-2
Page down	3-2
Plus	3-2
Print.....	3-3
Keyboard.....	3-1

L

Launch structure	2-18
LcdBackLight.....	3-9
LcdContrast.....	3-10
Loading procedure on windows CE operating system	2-17

M

Maintenance.....	5-1
Memory media used.....	2-31
Mounting	2-1

N

Nameplate.....	2-33
Normal mode.....	2-19

O

Ordering data	7-1
---------------------	-----

P

Pin assignment	
CAN	4-9
DeviceNet	4-12
Ethernet	4-2
INTERBUS	4-14
KNX.....	4-20
MPI.....	4-16
PROFIBUS.....	4-18
RS232	4-7
RS422	4-5
RS485.....	4-5

R

Rear view

CAN Slave	4-8
DeviceNet slave	4-12
Ethernet	4-2
INTERBUS	4-14
KNX	4-20
MPI slave	4-16
PROFIBUS-DP Slave	4-18
RS422 / RS485 / RS232	4-4

S

Safety notes	1-1
Servicing	5-1
Setting the brightness	3-9
Setting the contrast	3-10
Setup Main operating mode	2-19
Slide-in identifications strips	3-4
Special keys	3-2
Standards	6-4
Supply Voltage	2-14
Switching on	2-17

T

Target group	1-2
Technical data	6-1
Termination	
CAN	4-10
DeviceNet	4-13
MPI	4-17
PROFIBUS	4-19
RS232	4-7
RS485	4-6

U

Unpacking	2-1
-----------------	-----

V

Version key	2-33
-------------------	------



SÜTRON electronic GmbH
Kurze Straße 29
D-70794 Filderstadt
Phone: 0049 711 / 77098-0
Fax: 0049 711 / 77098-305
E-Mail: doku@suetron.de
Internet: www.suetron.com