

Power Panel 500

User's Manual

Version: **1.40 (August 2015)**
Model no.: **MAPP500-ENG**

All information contained in this manual is current as of its creation/publication. B&R reserves the right to change the contents of this manual without notice. The information contained herein is believed to be accurate as of the date of publication; however, Bernecker + Rainer Industrie-Elektronik Ges.m.b.H. makes no warranty, expressed or implied, with regard to the products or documentation contained within this manual. In addition, Bernecker + Rainer Industrie-Elektronik Ges.m.b.H. shall not be liable for any incidental or consequential damages in connection with or arising from the furnishing, performance or use of the product(s) in this documentation. Software names, hardware names and trademarks are registered by their respective companies.

Chapter 1: General information

Chapter 2: Technical data

Chapter 3: Installation

Chapter 4: Software

Chapter 5: Standards and certifications

Chapter 6: Accessories

Chapter 7: Maintenance and service

Appendix A

Chapter 1 General information.....	10
1 Manual history.....	10
2 Safety guidelines.....	12
2.1 Intended use.....	12
2.2 Protection against electrostatic discharge.....	12
2.2.1 Packaging.....	12
2.2.2 Guidelines for proper ESD handling.....	12
2.3 Policies and procedures.....	12
2.4 Transport and storage.....	13
2.5 Installation.....	13
2.6 Operation.....	13
2.6.1 Protection against touching electrical parts.....	13
2.6.2 Environmental conditions - Dust, moisture, corrosive gases.....	13
2.6.3 Viruses and dangerous programs.....	13
2.7 Environmentally friendly disposal.....	14
2.7.1 Separation of materials.....	14
3 Organization of safety notices.....	15
4 Guidelines.....	15
5 Overview.....	16
Chapter 2 Technical data.....	18
1 Introduction.....	18
1.1 The perfect system for any automation task.....	18
1.2 Panels with the power of an industrial PC.....	18
1.3 A complete solution with maximum flexibility.....	19
1.4 Open system platform.....	19
1.5 Features.....	19
1.6 System components / Configuration.....	20
1.6.1 Configuration - Base system.....	20
1.6.2 Configuration - Software and accessories.....	21
1.7 Differences between Power Panel 500 and Power Panel 300/400.....	22
1.7.1 General.....	22
1.7.2 Mechanics.....	22
2 Complete system.....	23
2.1 Temperature specifications.....	23
2.1.1 Temperature monitoring.....	23
2.1.2 Temperature sensor locations.....	24
2.2 Humidity specifications.....	25
2.3 Power management.....	26
2.3.1 Supply voltage block diagram.....	26
2.4 Serial number sticker.....	27
2.5 Device interfaces and slots.....	28
2.5.1 Overview of device interfaces.....	28
2.5.2 +24 VDC power supply.....	29
2.5.3 Serial interface COM.....	30
2.5.4 Ethernet (ETH).....	30
2.5.5 USB interfaces.....	31
2.5.6 Battery.....	32
2.5.7 CompactFlash slot.....	33
2.5.8 SD memory card slot.....	33
2.5.9 Power button.....	34
2.5.10 Reset button.....	34
2.5.11 Mode/Node switches.....	34
2.5.12 LED status indicators.....	35
2.5.13 Interface board slot.....	36
2.5.14 I/O board slot.....	36
3 Individual components.....	37

3.1 System units.....	37
3.1.1 5.7" system units.....	37
3.1.2 7" system unit.....	57
3.1.3 10.4" system units.....	62
3.1.4 12.1" system unit.....	82
3.1.5 15" system units.....	87
3.2 US15W CPU boards.....	102
3.2.1 General information.....	102
3.2.2 Order data.....	102
3.2.3 Technical data.....	102
3.3 Main memory.....	104
3.3.1 Order data.....	104
3.3.2 Technical data.....	104
3.4 Interface boards.....	105
3.4.1 5PP5IF.CETH-00.....	105
3.4.2 5PP5IF.CHDA-00.....	107
3.4.3 5PP5IF.FETH-00.....	109
3.4.4 5PP5IF.FPLM-00.....	111
3.4.5 5PP5IF.FCAN-00.....	115
3.4.6 5PP5IF.FX2X-00.....	117
3.4.7 5PP5IF.FXCM-00.....	119
3.5 I/O boards.....	121
3.5.1 5PP5IO.GNAC-00.....	121
Chapter 3 Installation.....	128
1 Installation.....	128
1.1 Important installation information.....	128
1.2 Installation with clamping blocks.....	128
1.2.1 Procedure.....	130
1.3 Installation with retaining clips.....	131
1.3.1 Procedure.....	131
1.4 Mounting orientations.....	133
1.4.1 Mounting orientation 0°.....	133
1.4.2 Mounting orientation 45°.....	134
1.4.3 Mounting orientation 90°.....	135
1.4.4 Mounting orientation 90° vertical.....	136
1.4.5 Mounting orientation 180°.....	137
1.5 Spacing for air circulation.....	138
2 General instructions for performing temperature testing.....	139
2.1 Procedure.....	139
2.2 Evaluating temperatures in Windows operating systems.....	139
2.2.1 Evaluating with the B&R Control Center.....	139
2.2.2 Evaluating with the BurnInTest tool from Passmark.....	140
2.3 Evaluating temperatures in operating systems other than Windows.....	142
2.4 Evaluating the measurement results.....	142
3 Cable connections.....	143
4 Grounding concept.....	144
5 Connecting peripheral USB devices.....	145
5.1 Locally on the PP500.....	145
5.2 Remote connection to Automation Panel 900 via DVI.....	146
5.3 Remote connection to Automation Panel 800 / 900 via SDL.....	147
6 Key and LED configuration.....	148
6.1 5PP551.0573-00.....	149
6.2 5PP552.0573-00.....	149
6.3 5PP580.1043-00.....	150
6.4 5PP581.1043-00.....	150
6.5 5PP582.1043-00.....	151

6.6 5PP580.1505-00.....	151
6.7 5PP581.1505-00.....	152
7 Touch screen calibration.....	153
7.1 Windows CE.....	153
7.2 Windows XP Professional.....	153
7.3 Windows Embedded Standard 2009.....	153
7.4 Windows 7 Professional / Ultimate.....	153
7.5 Windows Embedded Standard 7 Embedded / Premium.....	153
7.6 Automation Runtime / Visual Components.....	153
8 Tips for extending the service life of the display.....	154
8.1 Backlight.....	154
8.1.1 How can the service life of the backlight be extended?.....	154
8.2 Screen burn-in.....	154
8.2.1 What causes screen burn-in?.....	154
8.2.2 How can screen burn-in be avoided?.....	154
9 Pixel errors.....	154
10 Known problems/issues.....	154
Chapter 4 Software.....	155
1 BIOS options.....	155
1.1 General information.....	155
1.2 BIOS Setup and boot procedure.....	155
1.2.1 BIOS Setup keys.....	157
1.3 Main.....	158
1.4 OEM features.....	159
1.4.1 CPU board features.....	160
1.4.2 System unit features.....	165
1.4.3 I/O board features.....	169
1.4.4 IF board features.....	174
1.4.5 Memory module features.....	176
1.5 Advanced.....	177
1.5.1 RAM configuration.....	178
1.5.2 Boot configuration.....	179
1.5.3 Peripheral configuration.....	180
1.5.4 IDE configuration.....	181
1.5.5 Video configuration.....	184
1.5.6 USB configuration.....	185
1.5.7 SDIO configuration.....	186
1.5.8 ACPI table/features control.....	187
1.5.9 PCI Express root port 1.....	187
1.5.10 PCI Express root port 2.....	190
1.5.11 Console redirection.....	191
1.6 Security.....	194
1.6.1 Set supervisor password.....	195
1.6.2 Set user password.....	196
1.7 Power.....	197
1.7.1 Advanced CPU control.....	198
1.7.2 Platform power management.....	201
1.8 Boot.....	202
1.8.1 Legacy.....	203
1.9 Exit.....	207
1.10 BIOS default settings.....	208
1.10.1 Main.....	208
1.10.2 OEM features.....	208
1.10.3 Advanced.....	210
1.10.4 Power.....	212
1.10.5 Boot.....	213

1.11 Allocation of resources.....	214
1.11.1 RAM address assignment.....	214
1.11.2 I/O address assignment.....	214
1.11.3 Interrupt assignments in PIC mode.....	214
1.11.4 Interrupt assignments in APIC mode.....	215
2 Upgrade information.....	216
2.1 BIOS upgrade.....	216
2.1.1 Important information.....	216
2.1.2 Using the Control Center.....	217
2.2 Firmware upgrade.....	218
2.2.1 Procedure.....	218
2.3 Upgrade problems.....	218
3 Windows XP Professional.....	219
3.1 General information.....	219
3.2 Order data.....	219
3.3 Overview.....	219
3.4 Installation.....	219
3.5 Drivers.....	219
3.6 Supported display resolutions.....	220
4 Windows 7.....	221
4.1 General information.....	221
4.2 Order data.....	221
4.3 Overview.....	221
4.4 Installation.....	222
4.5 Drivers.....	222
4.6 Special considerations, limitations.....	222
4.7 Supported display resolutions.....	222
5 Windows Embedded Standard 2009.....	223
5.1 General information.....	223
5.2 Order data.....	223
5.3 Overview.....	223
5.4 Features with WES2009 (Windows Embedded Standard 2009).....	223
5.5 Installation.....	224
5.6 Drivers.....	224
5.6.1 Touch screen driver.....	224
5.7 Supported display resolutions.....	224
6 Windows Embedded Standard 7.....	225
6.1 General information.....	225
6.2 Order data.....	225
6.3 Overview.....	225
6.4 Features with WES7 (Windows Embedded Standard 7).....	226
6.5 Installation.....	226
6.6 Drivers.....	226
6.6.1 Touch screen driver.....	226
6.7 Supported display resolutions.....	227
7 Windows CE.....	228
7.1 General information.....	228
7.2 Order data.....	228
7.3 Overview.....	228
7.4 Windows CE 6.0 features.....	228
7.5 Requirements.....	229
7.6 Installation.....	229
7.7 B&R Embedded OS Installer.....	229
8 Automation Runtime.....	230
8.1 General information.....	230
8.2 Order data.....	230
8.3 Automation Runtime Windows (ARwin).....	230

8.4 Automation Runtime Embedded (ARemb).....	230
8.5 Technology Guarding.....	231
9 Debian (GNU/Linux).....	232
9.1 General information.....	232
9.2 Order data.....	232
9.3 Overview.....	232
9.4 Features.....	232
9.5 Installation.....	233
9.6 Drivers.....	233
10 B&R Automation Device Interface (ADI) - Control Center.....	234
10.1 Functions.....	234
10.2 Installation.....	235
11 B&R Automation Device Interface (ADI) Development Kit.....	236
12 B&R Automation Device Interface (ADI) .NET SDK.....	238
13 B&R Key Editor.....	240
14 B&R KCF Editor.....	242
15 HMI Service Center.....	243
15.1 5SWUTI.0001-000.....	243
15.1.1 General information.....	243
15.1.2 Order data.....	243
Chapter 5 Standards and certifications.....	244
1 Standards and guidelines.....	244
1.1 CE mark.....	244
1.2 EMC directive.....	244
1.3 Low voltage directive.....	244
2 Certifications.....	245
2.1 UL certification.....	245
2.2 GOST-R.....	245
2.3 GL certification (Germanischer Lloyd).....	245
Chapter 6 Accessories.....	248
1 Replacement CMOS batteries.....	248
1.1 0AC201.91 / 4A0006.00-000.....	248
1.1.1 General information.....	248
1.1.2 Order data.....	248
1.1.3 Technical data.....	248
2 Power connectors.....	250
2.1 0TB103.9x.....	250
2.1.1 General information.....	250
2.1.2 Order data.....	250
2.1.3 Technical data.....	250
3 Interface board connector.....	251
3.1 0TB1208.3100.....	251
3.1.1 General information.....	251
3.1.2 Order data.....	251
3.1.3 Technical data.....	251
4 CompactFlash cards.....	252
4.1 General information.....	252
4.2 General information.....	252
4.2.1 Flash technology.....	252
4.2.2 Wear leveling.....	252
4.2.3 ECC error correction.....	252
4.2.4 S.M.A.R.T. support.....	252
4.2.5 Maximum reliability.....	253
4.3 5CFCRD.xxxx-06.....	254
4.3.1 General information.....	254

4.3.2 Order data.....	254
4.3.3 Technical data.....	255
4.3.4 Temperature/Humidity diagram.....	258
4.3.5 Dimensions.....	259
4.3.6 Benchmark.....	260
4.4 5CFCRD.xxxx-04.....	261
4.4.1 General information.....	261
4.4.2 Order data.....	261
4.4.3 Technical data.....	261
4.4.4 Temperature/Humidity diagram.....	263
4.4.5 Dimensions.....	263
4.4.6 Benchmark.....	264
4.5 5CFCRD.xxxx-03.....	265
4.5.1 General information.....	265
4.5.2 Order data.....	265
4.5.3 Technical data.....	265
4.5.4 Temperature/Humidity diagram.....	267
4.5.5 Dimensions.....	267
4.6 Known problems/issues.....	268
5 USB media drive.....	269
5.1 5MD900.USB2-02.....	269
5.1.1 General information.....	269
5.1.2 Order data.....	269
5.1.3 Interfaces.....	269
5.1.4 Technical data.....	269
5.1.5 Dimensions.....	271
5.1.6 Dimensions with front cover.....	271
5.1.7 Cutout installation.....	272
5.1.8 Content of delivery.....	272
5.1.9 Installation.....	272
5.2 5A5003.03.....	273
5.2.1 General information.....	273
5.2.2 Order data.....	273
5.2.3 Technical data.....	273
5.2.4 Dimensions.....	273
5.2.5 Content of delivery.....	273
5.2.6 Installation.....	274
6 USB flash drives.....	275
6.1 5MMUSB.xxxx-01.....	275
6.1.1 General information.....	275
6.1.2 Order data.....	275
6.1.3 Technical data.....	275
6.1.4 Temperature/Humidity diagram.....	276
7 USB interface cover.....	277
7.1 5AC900.1201-00.....	277
7.1.1 General information.....	277
7.1.2 Order data.....	277
7.2 5AC900.1201-01.....	277
7.2.1 General information.....	277
7.2.2 Order data.....	277
8 Clamping blocks.....	278
8.1 5AC900.BLOC-00.....	278
8.1.1 General information.....	278
8.1.2 Order data.....	278
8.2 5AC900.BLOC-01.....	278
8.2.1 General information.....	278
8.2.2 Order data.....	278

9 Retaining clips.....	279
9.1 5AC900.CLIP-01.....	279
9.1.1 General information.....	279
9.1.2 Order data.....	279
10 Line filter.....	280
10.1 5AC804.MFLT-00.....	280
10.1.1 General information.....	280
10.1.2 Order data.....	280
10.1.3 Technical data.....	280
10.1.4 Dimensions.....	281
10.1.5 Drilling template.....	281
10.1.6 Connecting to the end device.....	281
Chapter 7 Maintenance and service.....	282
1 Cleaning.....	282
2 Replacing the battery.....	283
2.1 Evaluating the battery status.....	283
2.2 Procedure.....	283
3 Replacing a CompactFlash card.....	284
Appendix A	286
1 Maintenance Controller Extended (MTCX).....	286
2 5-wire AMT touch screen.....	287
2.1 Technical data.....	287
2.2 Temperature/Humidity diagram.....	287
2.3 Cleaning.....	287
3 Panel overlay.....	289
4 Viewing angles.....	290
5 Mounting compatibility.....	291
5.1 Compatibility overview.....	291
5.2 Compatibility details.....	293
5.2.1 Example.....	293
5.2.2 5.7" devices.....	293
5.2.3 10.4" devices.....	295
5.2.4 12.1" devices.....	297
5.2.5 15" devices.....	298
5.2.6 17" devices.....	299
5.2.7 19" devices.....	299
5.2.8 21.3" devices.....	300
6 Abbreviations.....	301
7 Glossary.....	302

Chapter 1 • General information

1 Manual history

Version	Date	Change
0.10 Preliminary	19-Nov-10	<ul style="list-style-type: none"> • First version
0.20 Preliminary	15-Dec-10	<ul style="list-style-type: none"> • Corrected technical data of display for 5.7" and 7" system units. • Corrected technical data for the 5PP5IO.GNAC-00 I/O board. • Corrected "5PP520.0573-01 - Dimensions" diagram.
0.21 Preliminary	21-Dec-10	<ul style="list-style-type: none"> • Corrected specifications for the graphics memory on the CPU board.
0.50 Preliminary	23-Dec-10	<ul style="list-style-type: none"> • Updated section 1 "BIOS options" on page 155.
0.51 Preliminary	24-Jan-11	<ul style="list-style-type: none"> • Updated description of menu items "PCI Express root port 1" on page 187 and "PCI Express root port 2" on page 190 in section 1 "BIOS options". • Updated section 2.4 "Serial number sticker" on page 27. • Revised section 1 "Maintenance Controller Extended (MTCX)" on page 286.
1.00	29-Mar-11	<ul style="list-style-type: none"> • Updated sections 6 "Windows Embedded Standard 7" on page 225 and 5 "Windows Embedded Standard 2009" on page 223 in 4 "Software". • Updated ambient temperatures of PP500 system units without keys. • Updated vibration/shock specifications and starting current of PP500 system units. • Updated dimension diagrams for system units 5PP520.1214-00, 5PP552.0573-00, 5PP580.1043-00, 5PP580.1505-00, 5PP581.1043-00, 5PP581.1505-00 and 5PP582.1043-00. • Updated technical data for system units to include the attribute "Altitude" in the category "Environmental conditions" and "EN 60529 protection" in the category "Operational conditions". • Modified the description of the mode/node switch in the "FF" position, see "Mode/Node switches" on page 34. • Removed sections "I/O boards" and "I/O board slot" from system unit 5PP520.0573-01. • Updated BIOS to version N0.15. • Updated section 1.4 "Mounting orientations" on page 133 in 3 "Installation". • Removed informational text in section 2.5.9 "Power button" on page 34. Backup BIOS will now be loaded automatically if a BIOS update error occurs. • Updated section 8 "Automation Runtime" on page 230 in 4 "Software". • Updated maximum specified temperatures of temperature sensors in section 2.1.2 "Temperature sensor locations" on page 24. • Modified section 2.5.11 "Mode/Node switches" on page 34.
1.10	19-May-11	<ul style="list-style-type: none"> • Updated section 6 "Key and LED configuration" on page 148 in 3 "Installation". • Updated 5 "Standards and certifications" on page 244. • Updated BIOS to version N0.16. • Updated sections 13 "B&R Key Editor" on page 240 and 10 "B&R Automation Device Interface (ADI) - Control Center" on page 234 in 4 "Software". • Updated section 7 "Windows CE" on page 228 in 4 "Software". • Updated temperature humidity diagram for 5.7", 7", 15" system units. • Updated ambient temperatures and power consumption for system units and interface boards. • Updated interface boards "5PP5IF.FCAN-00" on page 115, "5PP5IF.FX2X-00" on page 117 and "5PP5IF.FXCM-00" on page 119. • Updated service life of the battery in the PP500. • Updated humidity specifications for CPU boards and interface boards, see "Humidity specifications" on page 25. • Updated sections 4 "Grounding concept" on page 144 and 1.5 "Spacing for air circulation" on page 138 in 3 "Installation".
1.11	27-May-11	<ul style="list-style-type: none"> • Corrected temperature humidity diagrams. • Added missing temperature humidity diagrams.
1.20	21-Dec-11	<ul style="list-style-type: none"> • Updated system unit 5PP520.0571-01 and I/O board 5PP5IO.GNAC-00. • Limited front USB port (USB 3) to a maximum current load of 0.5 A. • Updated BIOS to version N0.18. • Updated section 3 "Replacing a CompactFlash card" on page 284. • Added new CompactFlash cards 5CFCRD.xxxx-06 in 6 "Accessories". Discontinued CompactFlash cards 5CFCRD.xxxx-04. • Updated section "Connecting peripheral USB devices" in 3 "Installation". • Revised section "LED status indicators" on page 35. • Revised section "Temperature sensor locations" on page 24. • Revised section "SD memory card slot" on page 33.
1.21	12-Mar-12	<ul style="list-style-type: none"> • Updated interface board 5PP5IF.FETH-00 in Interface boards. • Updated section "Power management" on page 26.
1.22	03-Apr-12	<ul style="list-style-type: none"> • Updated BIOS to version 1.00.

Table 1: Manual history

Version	Date	Change
1.25	06-Dec-12	<ul style="list-style-type: none"> Added description of BIOS setting "Console redirection", see page Console redirection. Modified "Organization of safety notices" on page 15, updated descriptions for cautions and warnings. Updated section "Cable lengths and resolutions for SDL transmission" on page 123. Updated section "General instructions for performing temperature testing" on page 139. Updated Windows 7 Service Pack 1 (see "Windows 7" on page 221). Updated Windows Embedded Standard 7 Service Pack 1 (see "Windows Embedded Standard 7" on page 225). Updated "B&R Automation Device Interface (ADI) - Control Center" on page 234. Updated "B&R Automation Device Interface (ADI) Development Kit" on page 236 to version 3.40. Updated "B&R Automation Device Interface (ADI) .NET SDK" on page 238 to version 1.80. Updated "B&R Key Editor" on page 240 to version 3.30. Updated technical data for CPU boards, see "US15W CPU boards" on page 102. CompactFlash card 5CFCRD.032G-06 updated, see "5CFCRD.xxxx-06" on page 254. Figure 36 "5PP582.1043-00 - Cutout installation" on page 80 revised.
1.26	16-Apr-13	<ul style="list-style-type: none"> Changed technical data for system units "5PP520.1043-00" on page 62, "5PP580.1043-00" on page 67, "5PP581.1043-00" on page 72, "5PP582.1043-00" on page 77, "5PP520.1214-00" on page 82, "5PP520.1505-00" on page 87, "5PP580.1505-00" on page 92, "5PP581.1505-00" on page 97, "5PP520.0573-00" on page 37, "5PP520.0573-01" on page 42, "5PP551.0573-00" on page 47, "5PP552.0573-00" on page 52 and "5PP520.0702-00" on page 57. Revised technical data for IF modules "5PP5IF.FETH-00" on page 109, "5PP5IF.FPLM-00" on page 111, "5PP5IF.FCAN-00" on page 115, "5PP5IF.FX2X-00" on page 117 and "5PP5IF.FXCM-00" on page 119. Revised section "Windows Embedded Standard 7" on page 225. Added new CompactFlash cards (8 GB) in "Accessories" on page 248. Added "USB media drive" on page 269. Revised chapter "Standards and certifications" on page 244. Updated all technical data. Updated section "Serial number sticker" on page 27.
1.30	30-Jul-13	<ul style="list-style-type: none"> Updated B&R USB flash drive 5MMUSB.4096-01, see "USB flash drives" on page 275. Updated sections "B&R Automation Device Interface (ADI) Development Kit" on page 236 and "B&R Automation Device Interface (ADI) .NET SDK" on page 238. Updated tightening torque of locating screws in section "Cable connections" on page 143.
1.35	24-Feb-14	<ul style="list-style-type: none"> Updated GOST-R certification information in the technical data. Updated section "GOST-R" on page 245. Updated sections "B&R Automation Device Interface (ADI) - Control Center" on page 234, "B&R Automation Device Interface (ADI) Development Kit" on page 236 and "B&R Automation Device Interface (ADI) .NET SDK" on page 238. Updated "B&R Key Editor" on page 240 to version 3.40. Added information about the discontinuation of support for the "Windows XP Professional" on page 219 operating system. Added "Debian (GNU/Linux)" on page 232 operating system. Added section "Known problems/issues" on page 154.
1.36	2014-09-01	<ul style="list-style-type: none"> Updated technical data for system units "5PP520.1505-00" on page 87, "5PP580.1505-00" on page 92 and "5PP581.1505-00" on page 97. Updated sections "B&R Automation Device Interface (ADI) Development Kit" on page 236, "B&R Automation Device Interface (ADI) .NET SDK" on page 238 and "B&R Key Editor" on page 240.
1.37	2015-02-26	<ul style="list-style-type: none"> Updated section "Automation Runtime" on page 230.
1.40	2015-08-24	<ul style="list-style-type: none"> Updated "B&R KCF Editor" on page 242. Updated section "B&R Key Editor" on page 240. Updated "HMI Service Center" on page 243 (5SWUTI.0001-000). Updated sections "B&R Automation Device Interface (ADI) - Control Center" on page 234, "B&R Automation Device Interface (ADI) Development Kit" on page 236 and "B&R Automation Device Interface (ADI) .NET SDK" on page 238. Removed section "HMI Driver & Utilities DVD". Updated technical data for "System units" on page 37.

Table 1: Manual history

2 Safety guidelines

2.1 Intended use

Programmable logic controllers (PLCs), operating/monitoring devices (industrial PCs, Power Panels, Mobile Panels, etc.) and B&R uninterruptible power supplies have been designed, developed and manufactured for conventional use in industrial environments. They were not designed, developed and manufactured for any use involving serious risks or hazards that could lead to death, injury, serious physical damage or loss of any kind without the implementation of exceptionally stringent safety precautions. In particular, such risks and hazards include the use of these devices to monitor nuclear reactions in nuclear power plants, their use in flight control or flight safety systems as well as in the control of mass transportation systems, medical life support systems or weapons systems.

2.2 Protection against electrostatic discharge

Electrical components that can be damaged by electrostatic discharge (ESD) must be handled accordingly.

2.2.1 Packaging

- **Electrical components with a housing**
...do not require special ESD packaging but must be handled properly (see "Electrical components with a housing").
- **Electrical components without a housing**
...are protected by ESD-suitable packaging.

2.2.2 Guidelines for proper ESD handling

Electrical components with a housing

- Do not touch the connector contacts on connected cables.
- Do not touch the contact tips on circuit boards.

Electrical components without a housing

The following applies in addition to the points listed under "Electrical components with a housing":

- Any persons handling electrical components or devices with installed electrical components must be grounded.
- Components are only permitted to be touched on their narrow sides or front plate.
- Components should always be stored in a suitable medium (ESD packaging, conductive foam, etc.). Metallic surfaces are not suitable storage surfaces!
- Components should not be subjected to electrostatic discharge (e.g. through the use of charged plastics).
- Ensure a minimum distance of 10 cm from monitors and TV sets.
- Measuring instruments and equipment must be grounded.
- Probes on potential-free measuring instruments must be discharged on sufficiently grounded surfaces before taking measurements.

Individual components

- ESD protective measures for individual components are thoroughly integrated at B&R (conductive floors, footwear, arm bands, etc.).
- These increased ESD protective measures for individual components are not necessary for customers handling B&R products.

2.3 Policies and procedures

Electronic devices are never completely failsafe. If the programmable control system, operating/monitoring device or uninterruptible power supply fails, the user is responsible for ensuring that other connected devices, e.g. motors, are brought to a secure state.

When using programmable logic controllers or operating/monitoring devices as control systems together with a soft PLC (e.g. B&R Automation Runtime or comparable product) or slot PLC (e.g. B&R LS251 or comparable product), safety precautions relevant to industrial control systems (e.g. the provision of safety devices such as emergency stop circuits, etc.) must be observed in accordance with applicable national and international regulations. The same applies for all other devices connected to the system, such as drives.

All tasks such as the installation, commissioning and servicing of devices are only permitted to be carried out by qualified personnel. Qualified personnel are those familiar with the transport, mounting, installation, commissioning and operation of devices who also have the appropriate qualifications (e.g. IEC 60364). National accident prevention regulations must be observed.

The safety notices, connection descriptions (type plate and documentation) and limit values listed in the technical data are to be read carefully before installation and commissioning and must be observed.

2.4 Transport and storage

During transport and storage, devices must be protected against undue stress (mechanical loads, temperature, moisture, corrosive atmospheres, etc.).

2.5 Installation

- These devices are not ready for use upon delivery and must be installed and wired according to the specifications in this documentation in order for the EMC limit values to apply.
- Installation must be performed according to this documentation using suitable equipment and tools.
- Devices are only permitted to be installed by qualified personnel without voltage applied. Before installation, voltage to the control cabinet must be switched off and prevented from being switched on again.
- General safety guidelines and national accident prevention regulations must be observed.
- Electrical installation must be carried out in accordance with applicable guidelines (e.g. line cross sections, fuses, protective ground connections).

2.6 Operation

2.6.1 Protection against touching electrical parts

To operate programmable logic controllers, operating and monitoring devices, and uninterruptible power supplies, certain components must carry dangerous voltage levels. Touching one of these parts can result in a life-threatening electric shock. This could lead to death, severe injury or damage to equipment.

Before turning on the programmable logic controller, operating/monitoring devices or uninterruptible power supply, the housing must be properly grounded (PE rail). Ground connections must be established even when testing or operating operating/monitoring devices or the uninterruptible power supply for a short time!

Before turning the device on, all parts that carry voltage must be securely covered. During operation, all covers must remain closed.

2.6.2 Environmental conditions - Dust, moisture, corrosive gases

The use of operating/monitoring devices (e.g. industrial PCs, Power Panels, Mobile Panels, etc.) and uninterruptible power supplies in very dusty environments should be avoided. Dust collection on the devices can affect functionality and may prevent sufficient cooling, especially in systems with active cooling systems (fans).

The presence of corrosive gases can also lead to malfunctions. When combined with high temperature and humidity, corrosive gases – e.g. with sulfur, nitrogen and chlorine components – can induce chemical reactions that can damage electronic components very quickly. Signs of the presence of corrosive gases are blackened copper surfaces and cable ends on existing equipment.

For operation in dusty or moist conditions, correctly installed (e.g. cutout installations) operating/monitoring devices like the Automation Panel or Power Panel are protected on the front. The back of all devices must be protected from dust and moisture and cleaned at suitable intervals.

2.6.3 Viruses and dangerous programs

This system is subject to potential risk each time data is exchanged or software is installed from a data medium (e.g. diskette, CD-ROM, USB flash drive, etc.), a network connection or the Internet. The user is responsible for assessing these dangers, implementing preventive measures such as virus protection programs, firewalls, etc. and making sure that software is only obtained from trusted sources.

2.7 Environmentally friendly disposal

All B&R programmable controllers, operating/monitoring devices and uninterruptible power supplies are designed to inflict as little harm as possible on the environment.

2.7.1 Separation of materials

It is necessary to separate different materials so the device can undergo an environmentally friendly recycling process.

Component	Disposal
Programmable logic controllers Operating/Monitoring devices Uninterruptible power supply Batteries and rechargeable batteries Cables	Electronics recycling
Cardboard box / Paper packaging	Cardboard box / Paper recycling
Plastic packaging	Plastic recycling

Table 2: Environmentally friendly separation of materials

Disposal must comply with applicable legal regulations.

3 Organization of safety notices

Safety notices in this manual are organized as follows:

Safety notice	Description
Danger!	Disregarding these safety guidelines and notices can be life-threatening.
Warning!	Disregarding these safety guidelines and notices can result in severe injury or substantial damage to equipment.
Caution!	Disregarding these safety guidelines and notices can result in injury or damage to equipment.
Information:	This information is important for preventing errors.

Table 3: Description of the safety notices used in this documentation

4 Guidelines

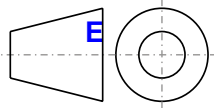

European dimension standards apply to all dimension diagrams in this document.

All dimensions are specified in mm.

Range of nominal sizes	General tolerance according to DIN ISO 2768 (medium)
Up to 6 mm	±0.1 mm
For 6 to 30 mm	±0.2 mm
For 30 to 120 mm	±0.3 mm
For 120 to 400 mm	±0.5 mm
For 400 to 1000 mm	±0.8 mm

Table 4: Range of nominal sizes

5 Overview

Product ID	Short description	on page
Accessories		
5AC804.MFLT-00	Line filter	280
5AC900.1201-00	USB interface cover M20 IP65 flat	277
5AC900.1201-01	USB interface cover M20 IP65 curved	277
5AC900.BLOC-00	Terminal block with brackets, 10 pcs.; replacement part	278
5AC900.BLOC-01	Clamping block without brackets, 10 pcs.; replacement part	278
5AC900.CLIP-01	Plastic retaining clips, 12 pcs.; replacement part	279
5SWUTI.0001-000	HMI Service Center USB flash drive	243
Batteries		
0AC201.91	Lithium batteries 4 pcs., 3 V / 950 mAh button cell We hereby state that the lithium cells contained in this shipment qualify as "partly regulated". Handle with care. If the package is damaged, inspect the cells, repack intact cells and protect cells against short circuits. For emergency information, call RENATA SA at + 41 61 319 28 27	248
4A0006.00-000	Lithium battery, 3 V / 950 mAh, button cell	248
CPU Boards		
5PP5CP.US15-00	Intel Atom Z510 CPU board, 1100 MHz, single core, 400 MHz FSB, 512 kB L2 cache; US15W chipset; 1 slot for SO-DIMM DDR2 module	245
5PP5CP.US15-01	Intel Atom Z520 CPU board, 1330 MHz, single core, 533 MHz FSB, 512 kB L2 cache; US15W chipset; 1 slot for SO-DIMM DDR2 module	245
5PP5CP.US15-02	Intel Atom Z530 CPU board, 1600 MHz, single core, 533 MHz FSB, 512 kB L2 cache; US15W chipset; 1 slot for SO-DIMM DDR2 module	245
CompactFlash		
5CFCRD.016G-06	CompactFlash 16 GB B&R (SLC) ≤ Rev. D0	254
5CFCRD.032G-06	CompactFlash 32 GB B&R (SLC) ≤ Rev. C0	254
5CFCRD.0512-06	CompactFlash 512 MB B&R (SLC) ≤ Rev. E0	254
5CFCRD.1024-06	CompactFlash 1 GB B&R (SLC) ≤ Rev. E0	254
5CFCRD.2048-06	CompactFlash 2 GB B&R (SLC) ≤ Rev. E0	254
5CFCRD.4096-06	CompactFlash 4 GB B&R (SLC) ≤ Rev. E0	254
5CFCRD.8192-06	CompactFlash 8 GB B&R (SLC) ≤ Rev. E0	254
CompactFlash cards		
5CFCRD.0064-03	CompactFlash 64 MB Western Digital (SLC)	265
5CFCRD.0128-03	CompactFlash 128 MB Western Digital (SLC)	265
5CFCRD.016G-04	CompactFlash 16 GB B&R (SLC)	261
5CFCRD.0256-03	CompactFlash 256 MB Western Digital (SLC)	265
5CFCRD.0512-03	CompactFlash 512 MB Western Digital (SLC)	265
5CFCRD.0512-04	CompactFlash 512 MB B&R (SLC)	261
5CFCRD.1024-03	CompactFlash 1 GB Western Digital (SLC)	265
5CFCRD.1024-04	CompactFlash 1 GB B&R (SLC)	261
5CFCRD.2048-03	CompactFlash 2 GB Western Digital (SLC)	265
5CFCRD.2048-04	CompactFlash 2 GB B&R (SLC)	261
5CFCRD.4096-03	CompactFlash 4 GB Western Digital (SLC)	265
5CFCRD.4096-04	CompactFlash 4 GB B&R (SLC)	261
5CFCRD.8192-03	CompactFlash 8 GB Western Digital (SLC)	265
5CFCRD.8192-04	CompactFlash 8 GB B&R (SLC)	261
Debian 6.0		
5SWLIN.0136-MUL	Debian 6.0 - 32-bit - Multilingual - For PP500	232
Hauptspeicher		
5MMDDR.0512-01	SO-DIMM DDR2 RAM 512 MB PC2-5300	245
5MMDDR.1024-01	SO-DIMM DDR2 RAM 1024 MB PC2-5300	245
5MMDDR.2048-01	SO-DIMM DDR2 RAM 2048 MB PC2-5300	245
I/O board		
5PP5IO.GNAC-00	Interface board - 1 USB 2.0 - 1 RS232/422/485 - 1 HDA sound - 1 SDL/DVI-D	121
Interface Boards		
5PP5IF.CETH-00	PP500 interface board; connection for 1x Ethernet 10/100/1000	245
5PP5IF.FCAN-00	PP500 interface board; connection for 1x CAN master, 512 kB SRAM; order connector separately (cage clamp 0TB1208.3100)	245
5PP5IF.FETH-00	PP500 interface board; connection for 1x Ethernet 10/100/1000, 512 kB SRAM	245
5PP5IF.FPLM-00	PP500 interface board; connections for 2x POWERLINK (with integrated hub); 512 kB SRAM	245
5PP5IF.FX2X-00	PP500 interface board; connection for 1x X2X master, 512 kB SRAM; order connector separately (cage clamp 0TB1208.3100)	245
5PP5IF.FXCM-00	PP500 interface board; connection for 1x CAN master, 1x X2X master, 512 kB SRAM; order connector separately (cage clamp 0TB1208.3100)	245
Interface boards		
5PP5IF.CHDA-00	Audio interface card - 1 HDA	107
System units		
5PP520.0573-00	Power Panel 520 5.7" VGA TFT display with touch screen (resistive); connections for 1x RS232, 2x USB 2.0, 1x Ethernet 10/100/1000; can be expanded with interface board; IP65 protection (front); order male 24 VDC connector for voltage supply separately (screw clamp: 0TB103.9; cage clamp: 0TB103.91)	37
5PP520.0573-01	Power Panel 520 5.7" VGA TFT display with touch screen (resistive); connections for 1x RS232, 2x USB 2.0, 1x Ethernet 10/100/1000; can be expanded with interface board and I/O board; IP65 protection (front); order male 24 VDC connector for voltage supply separately (screw clamp: 0TB103.9; cage clamp: 0TB103.91)	42
5PP520.1043-00	Power Panel 520 10.4" VGA TFT display with touch screen (resistive); connections for 1x RS232, 3x USB 2.0, 1x Ethernet 10/100/1000; can be expanded with interface board; IP65 protection (front); order male 24 VDC connector for voltage supply separately (screw clamp: 0TB103.9; cage clamp: 0TB103.91)	62

Product ID	Short description	on page
5PP520.1214-00	Power Panel 520 12" SVGA TFT display with touch screen (resistive); connections for 1x RS232, 3x USB 2.0, 1x Ethernet 10/100/1000; can be expanded with interface board; IP65 protection (front); order male 24 VDC connector for voltage supply separately (screw clamp: 0TB103.9; cage clamp: 0TB103.91)	82
5PP551.0573-00	Power Panel 551 5.7" VGA TFT display; 22 function keys and 20 system keys; connections for 1x RS232, 2x USB 2.0, 1x Ethernet 10/100/1000; can be expanded with interface board; IP65 protection (front); order male 24 VDC connector for voltage supply separately (screw clamp: 0TB103.9; cage clamp: 0TB103.91)	47
5PP552.0573-00	Power Panel 552 5.7" VGA TFT display; 20 function keys and 20 system keys; connections for 1x RS232, 2x USB 2.0, 1x Ethernet 10/100/1000; can be expanded with interface board; IP65 protection (front); order male 24 VDC connector for voltage supply separately (screw clamp: 0TB103.9; cage clamp: 0TB103.91)	52
5PP580.1043-00	Power Panel 580 10.4" VGA TFT display with touch screen (resistive); 22 function keys; connections for 1x RS232, 3x USB 2.0, 1x Ethernet 10/100/1000; can be expanded with interface board; IP65 protection (front); order male 24 VDC connector for voltage supply separately (screw clamp: 0TB103.9; cage clamp: 0TB103.91)	67
5PP580.1505-00	Power Panel 580 15" XGA TFT display with touch screen (resistive); 32 function keys; connections for 1x RS232, 3x USB 2.0, 1x Ethernet 10/100/1000; can be expanded with interface board; IP65 protection (front); order male 24 VDC connector for supply voltage separately (screw clamp: 0TB103.9; cage clamp: 0TB103.91)	92
5PP581.1043-00	Power Panel 581 10.4" VGA TFT display with touch screen (resistive); 38 function keys and 20 system keys; connections for 1x RS232, 3x USB 2.0, 1x Ethernet 10/100/1000; can be expanded with interface board; IP65 protection (front); order male 24 VDC connector for voltage supply separately (screw clamp: 0TB103.9; cage clamp: 0TB103.91)	72
5PP581.1505-00	Power Panel 581 15" XGA TFT display with touch screen (resistive); 32 function keys and 92 system keys; connections for 1x RS232, 3x USB 2.0, 1x Ethernet 10/100/1000; can be expanded with interface board; IP65 protection (front); order male 24 VDC connector for supply voltage separately (screw clamp: 0TB103.9; cage clamp: 0TB103.91)	97
5PP582.1043-00	Power Panel 582 10.4" VGA TFT display with touch screen (resistive); 44 function keys and 20 system keys; connections for 1x RS232, 3x USB 2.0, 1x Ethernet 10/100/1000; can be expanded with interface board; IP65 protection (front); order male 24 VDC connector for voltage supply separately (screw clamp: 0TB103.9; cage clamp: 0TB103.91)	77
Systemeinheiten		
5PP520.0702-00	Power Panel 520 7" WVGA TFT display with touch screen (resistive); connections for 1x RS232, 2x USB 2.0, 1x Ethernet 10/100/1000; can be expanded with interface board; IP65 protection (front); order male 24 VDC connector for supply voltage separately (screw clamp: 0TB103.9; cage clamp: 0TB103.91)	245
5PP520.1505-00	Power Panel 520 15" XGA TFT display with touch screen (resistive); connections for 1x RS232, 3x USB 2.0, 1x Ethernet 10/100/1000; can be expanded with interface board; IP65 protection (front); order male 24 VDC connector for supply voltage separately (screw clamp: 0TB103.9; cage clamp: 0TB103.91)	245
Technology Guard		
0TG1000.01	Technology Guard	230
1TG4600.10-5	Automation Runtime Windows, TG license	230
1TG4601.06-5	Automation Runtime Embedded, TG license	230
1TG4601.06-T	Automation Runtime Embedded Terminal TG license	230
Terminal blocks		
0TB103.9	Connector 24 VDC - 3-pin female - Screw clamps 3.31 mm ²	250
0TB103.91	Connector 24 VDC - 3-pin female - Cage clamps 3.31 mm ²	250
0TB1208.3100	Connector, 8-pin cage clamp, 1 mm ² , protected against vibration by the screw flange	251
USB accessories		
5A5003.03	Front cover for drives - 5A5003.02 - 5MD900.USB2	273
5MD900.USB2-02	USB 2.0 drive combination - DVD-R/RW, DVD+R/RW - CompactFlash slot	269
5MMUSB.2048-01	USB 2.0 flash drive, 2048 MB, B&R	275
5MMUSB.4096-01	USB 2.0 flash drive, 4096 MB, B&R	275
Windows 7 Professional/Ultimate		
5SWWI7.0100-ENG	Windows 7 Professional - 32-bit - English - DVD	221
5SWWI7.0100-GER	Windows 7 Professional - 32-bit - German - DVD	221
5SWWI7.0300-MUL	Windows 7 Professional - 32-bit - Multilingual - DVD	221
5SWWI7.1100-ENG	Windows 7 Professional SP1 - 32-bit - English - DVD	221
5SWWI7.1100-GER	Windows 7 Professional SP1 - 32-bit - German - DVD	221
5SWWI7.1300-MUL	Windows 7 Ultimate SP1 - 32-bit - Multilingual - DVD	221
Windows CE 6.0		
5SWWCE.0836-ENG	Microsoft OEM Windows CE 6.0 Professional, English; for PP500; order CompactFlash separately (at least 128 MB).	228
Windows Embedded Standard 2009		
5SWWXP.0736-ENG	Microsoft OEM Windows Embedded Standard 2009, English; for PP500; order CompactFlash separately (at least 1 GB).	223
Windows Embedded Standard 7		
5SWWI7.0536-ENG	Microsoft OEM Windows Embedded Standard 7 32-bit, English; for PP500; please order CompactFlash separately (minimum 8 GB).	225
5SWWI7.0736-MUL	Microsoft OEM Windows Embedded Standard 7 Premium 32-bit, multilanguage; for PP500; please order CompactFlash separately (minimum 8 GB).	225
5SWWI7.1536-ENG	Microsoft OEM Windows Embedded Standard 7 32-bit, Service Pack 1, English; for PP500; order CompactFlash separately (at least 16 GB).	225
5SWWI7.1736-MUL	Microsoft OEM Windows Embedded Standard 7 Premium 32-bit, Service Pack 1, multilingual; for PP500; order CompactFlash separately (at least 16 GB).	225
Windows XP Professional		
5SWWXP.0600-ENG	Windows XP Professional SP3 - English - CD	219
5SWWXP.0600-GER	Windows XP Professional SP3 - German - CD	219
5SWWXP.0600-MUL	Windows XP Professional SP3 - Multilingual - CD	219

Chapter 2 • Technical data

1 Introduction

1.1 The perfect system for any automation task

Now more than ever, competitive control and HMI solutions must be complete, scalable and tailored to the application at hand. A wide range of product types and various options for flexible system expansion are extremely important in machine manufacturing. For this reason, intelligent all-in-one solutions that offer users the highest level of freedom with regard to control topology are important components for automation. Cost-effective solutions can be implemented by adapting the system precisely to the respective application, as is proven by the vast number of Power Panels operating in the field.

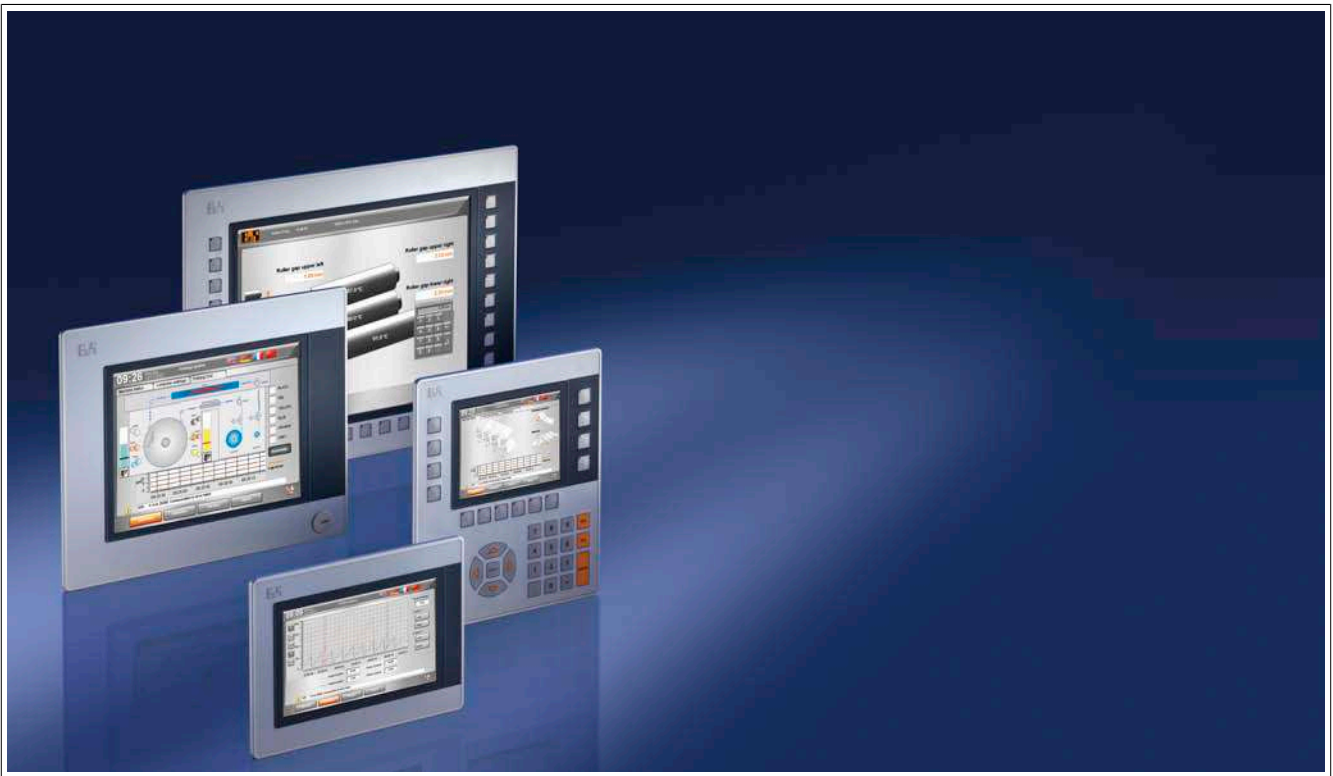

Combining control, HMI and drive technology into one system makes it possible to offer intelligent complete solutions with a high level of integration that can be easily connected to various automation infrastructures. Compact Power Panel devices are designed for use in the harshest industrial environments and ensure the highest level of operating comfort. Uniform project development and integrated language-switching options make B&R control panels a worldwide industry standard.

1.2 Panels with the power of an industrial PC

Powered by Intel® Atom™ architecture, the new Power Panel 500 series delivers performance previously only possible with industrial PCs. The Intel® Atom™ Z5xx processors equipped in the Power Panel 500 have enough power to handle even the most challenging applications. There is also plenty of room for RAM – up to 2 GB. This extensive product range includes panels ranging from 5.7" VGA to 15" XGA displays with intuitive touch screen and function keys. Gigabit Ethernet ensures high-speed communication over the plant network. Additional fieldbus interfaces or another gigabit Ethernet interface can also be added if needed. When designing the Power Panel 500, developers focused specifically on minimizing installation depth so that these systems can be used in extremely tight spaces.

1.3 A complete solution with maximum flexibility

As a central operating and control system, B&R Power Panels combine control, HMI and drive technology into a single package. From embedded processors to full PC power, this product range always delivers the ideal system architecture for machine builders to implement cost-effective solutions.

With these systems, expansion is as easy as connecting remote I/O modules and drives via modular fieldbus interfaces. Depending on requirements, Power Panels can be expanded with POWERLINK, CAN bus, PROFIBUS DP or other fieldbus interfaces. This allows additional topologies to be implemented at a later date without problems.

Several distributed operating stations are often used in order to guarantee that complex machines are operated reliably. This provides easy access for operating personnel and ensures that process information is available on the machine where it is needed.

1.4 Open system platform

In addition to enabling the implementation of complete automation solutions, Power Panel systems are also an optimal platform for open operating systems. This provides users with the highest degree of flexibility because it allows different software architectures to be implemented on the same system platform.

Regardless of whether they are used to automate complete systems, as intelligent visualization terminals or together with open PC operating systems, the Power Panel series offers the right tool for any situation. The result is a complete solution with maximum flexibility.

1.5 Features

- Intel® Atom™ Z510, Z520 or Z530 processor
- Up to 2 GB SDRAM
- 5.7" VGA up to 15" XGA displays
- 2x USB 2.0 (5.7" and 7" devices), 3x USB 2.0 (10.4", 12.1" and 15" devices)
- 1x RS232
- 1x Ethernet 10/100/1000 Mbit/s
- Optional interface and I/O boards
- 1 CompactFlash slot (type I)
- 24 VDC supply voltage
- Operation without a fan or heat sink
- BIOS (Insyde)
- Real-time clock (RTC, battery-backed)

1.6 System components / Configuration

The PP500 system can be assembled to meet individual requirements and operating conditions.

The following components are absolutely essential for operation:

- System unit
- CPU board
- Main memory
- Drive (mass storage device such as CompactFlash card) for the operating system
- Power connector (terminal block)

1.6.1 Configuration - Base system















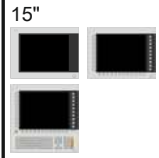













Configuration - Base system					
System unit	Select 1				
A system unit consists of a housing and a display. Variants: PP500 with slot for Interface board: 5PP5xx.xxxx-00 PP500 with slot for Interface & I/O board: 5PP5xx.xxxx-01	5.7"	7"	10.4"	12.1"	15"
					
	5PP520.0573-00	5PP520.0702-00	5PP520.1043-00	5PP520.1214-00	5PP520.1505-00
	5PP520.0573-01		5PP580.1043-00		5PP580.1505-00
	5PP551.0573-00		5PP581.1043-00		5PP581.1505-00
	5PP552.0573-00		5PP582.1043-00		5PP581.1505-00
CPU board - Main memory					
CPU board	Select 1				
	5PP5CP.US15-00 - 1100 MHz 5PP5CP.US15-01 - 1330 MHz 5PP5CP.US15-02 - 1600 MHz				
Main memory	Select 1				
	5MMDDR.0512-01 5MMDDR.1024-01 5MMDDR.2048-01				

Figure 1: Configuration - Base system

1.6.2 Configuration - Software and accessories

Configuration - Software and accessories																										
System unit	Select 1																									
A system unit consists of a housing and a display. Variants: PP500 with slot for Interface board: 5PP5xx.xxxx-00 PP500 with slot for Interface & I/O board: 5PP5xx.xxxx-01	<table border="1"> <tr> <td>5.7" </td> <td>7" </td> <td>10.4" </td> <td>12.1" </td> <td>15" </td> </tr> <tr> <td>5PP520.0573-00</td> <td>5PP520.0702-00</td> <td>5PP520.1043-00</td> <td>5PP520.1214-00</td> <td>5PP520.1505-00</td> </tr> <tr> <td>5PP520.0573-01</td> <td></td> <td>5PP580.1043-00</td> <td></td> <td>5PP580.1505-00</td> </tr> <tr> <td>5PP551.0573-00</td> <td></td> <td>5PP581.1043-00</td> <td></td> <td>5PP581.1505-00</td> </tr> <tr> <td>5PP552.0573-00</td> <td></td> <td>5PP582.1043-00</td> <td></td> <td></td> </tr> </table>	5.7" 	7" 	10.4" 	12.1" 	15" 	5PP520.0573-00	5PP520.0702-00	5PP520.1043-00	5PP520.1214-00	5PP520.1505-00	5PP520.0573-01		5PP580.1043-00		5PP580.1505-00	5PP551.0573-00		5PP581.1043-00		5PP581.1505-00	5PP552.0573-00		5PP582.1043-00		
5.7" 	7" 	10.4" 	12.1" 	15" 																						
5PP520.0573-00	5PP520.0702-00	5PP520.1043-00	5PP520.1214-00	5PP520.1505-00																						
5PP520.0573-01		5PP580.1043-00		5PP580.1505-00																						
5PP551.0573-00		5PP581.1043-00		5PP581.1505-00																						
5PP552.0573-00		5PP582.1043-00																								
Interface board	Select 1																									
	5PP5IF.CETH-00 - 1x ETH 10/100/100 5PP5IF.CHDA-00 - 1x HDA sound 5PP5IF.FETH-00 - 1x ETH 10/100/100, SRAM 5PP5IF.FPLM-00 - 2x POWERLINK, SRAM 5PP5IF.FCAN-00 - 1x CAN, SRAM 5PP5IF.FX2X-00 - 1x X2X, SRAM 5PP5IF.FXCM-00 - 1x CAN, 1x X2X, SRAM																									
I/O board	Select 1 ¹⁾																									
	5PP5IO.GNAC-00																									
CompactFlash	Select 1																									
	<table border="1"> <tr> <td>5CFCRD.0512-06</td> <td>5CFCRD.8192-06</td> </tr> <tr> <td>5CFCRD.1024-06</td> <td>5CFCRD.016G-06</td> </tr> <tr> <td>5CFCRD.2048-06</td> <td>5CFCRD.032G-06</td> </tr> <tr> <td>5CFCRD.4096-06</td> <td></td> </tr> </table>	5CFCRD.0512-06	5CFCRD.8192-06	5CFCRD.1024-06	5CFCRD.016G-06	5CFCRD.2048-06	5CFCRD.032G-06	5CFCRD.4096-06																		
5CFCRD.0512-06	5CFCRD.8192-06																									
5CFCRD.1024-06	5CFCRD.016G-06																									
5CFCRD.2048-06	5CFCRD.032G-06																									
5CFCRD.4096-06																										
USB accessories	Select 1																									
	5MMUSB.2048-01 5MMUSB.4096-01																									
Software	Select 1																									
	<table border="1"> <tr> <td>Windows XP 5SWWXP.0600-ENG 5SWWXP.0600-GER 5SWWXP.0600-MUL</td> <td>Windows Embedded Standard 2009 5SWWXP.0736-ENG</td> <td>Windows CE 5SWWCE.0836-ENG</td> </tr> <tr> <td>Windows 7 5SWWI7.1100-ENG 5SWWI7.1100-GER 5SWWI7.1300-MUL</td> <td>Windows Embedded Standard 7 5SWWI7.0537-ENG 5SWWI7.1736-MUL</td> <td>Automation Runtime 1A4600.10-5 1A4601.06-5 1A4601.06-T</td> </tr> <tr> <td></td> <td>Debian 6.0 (GNU/Linux) 5SWLIN.0136-MUL</td> <td>0TG1000.01</td> </tr> </table>	Windows XP 5SWWXP.0600-ENG 5SWWXP.0600-GER 5SWWXP.0600-MUL	Windows Embedded Standard 2009 5SWWXP.0736-ENG	Windows CE 5SWWCE.0836-ENG	Windows 7 5SWWI7.1100-ENG 5SWWI7.1100-GER 5SWWI7.1300-MUL	Windows Embedded Standard 7 5SWWI7.0537-ENG 5SWWI7.1736-MUL	Automation Runtime 1A4600.10-5 1A4601.06-5 1A4601.06-T		Debian 6.0 (GNU/Linux) 5SWLIN.0136-MUL	0TG1000.01																
Windows XP 5SWWXP.0600-ENG 5SWWXP.0600-GER 5SWWXP.0600-MUL	Windows Embedded Standard 2009 5SWWXP.0736-ENG	Windows CE 5SWWCE.0836-ENG																								
Windows 7 5SWWI7.1100-ENG 5SWWI7.1100-GER 5SWWI7.1300-MUL	Windows Embedded Standard 7 5SWWI7.0537-ENG 5SWWI7.1736-MUL	Automation Runtime 1A4600.10-5 1A4601.06-5 1A4601.06-T																								
	Debian 6.0 (GNU/Linux) 5SWLIN.0136-MUL	0TG1000.01																								
Terminal blocks	Select 1 each																									
	<table border="1"> <tr> <td>Power connectors 0TB103.9 0TB103.91</td> <td>Interface board connector 0TB1208.3100</td> </tr> </table>	Power connectors 0TB103.9 0TB103.91	Interface board connector 0TB1208.3100																							
Power connectors 0TB103.9 0TB103.91	Interface board connector 0TB1208.3100																									

1) I/O boards can only be operated in the system unit 5PP520.0573-01.

Figure 2: Configuration - Software and accessories

1.7 Differences between Power Panel 500 and Power Panel 300/400

1.7.1 General

Like B&R Automation PCs and B&R Panel PCs, the new Power Panel device family PP500 can also have a custom configuration. Customers can choose from three different CPU boards as well as the amount of main memory. It is also possible to insert interface boards and, in some devices (devices whose model number ends in -01, e.g. 5PP5xx.xxx-01), I/O boards. For additional information about configuration, see section 1.6 "System components / Configuration" on page 20.

1.7.2 Mechanics

Mechanically, the Power Panel 500 can be mounted just like the Power Panel 300/400, but the interface, connector and key positions are different. Section 5 "Mounting compatibility" on page 291 provides an overview of installation compatibility.

2 Complete system

2.1 Temperature specifications

It is possible to combine CPU boards with various other components, such as main memory, I/O boards, interface boards, etc. depending on the system unit. The various configurations result in varying maximum possible ambient temperatures, which can be seen in the following table.

Information:

The maximum specified ambient temperatures for operation were determined under worst-case conditions. Experience has shown that higher ambient temperatures can be reached in typical applications, e.g. those in Microsoft Windows. Testing and evaluation must be performed on-site by the user (temperatures can be read in BIOS or with the B&R Control Center).

Information regarding worst-case conditions

- Thermal Analysis Tool (TAT V2.02) from Intel for simulating a 100% processor load
- BurnInTest tool (BurnInTest V4.0 Pro from Passmark Software) for simulating a 100% load on the interface via loop back adapters (serial interfaces, USB ports)
- Maximum system expansion and power consumption

2.1.1 Temperature monitoring

Sensors monitor temperature values at various places inside the PP500 (CPU, interfaces, display, interface board, I/O board). The location of these temperature sensors is illustrated in "Temperature sensor locations" on page 24. The values listed in the table represent the defined maximum temperature¹⁾ for the respective measurement point. An alarm is not triggered if this temperature is exceeded. These temperatures can be read in BIOS or in approved Microsoft Windows operating systems together with Automation Runtime and the B&R Control Center.

¹⁾ The temperature measured approximates the immediate ambient temperature but may also be influenced by neighboring components.

2.1.2 Temperature sensor locations

Sensors monitor temperature values at various locations (USB ports, main memory) inside the PP500. These temperatures²⁾ can be read in Microsoft Windows operating systems using the B&R Control Center³⁾ or in Automation Runtime using data points in Automation Studio.

For applications that don't use Windows, temperatures can be evaluated using the B&R implementation guide. In addition to the implementation guide, there are also programs available in MS-DOS.

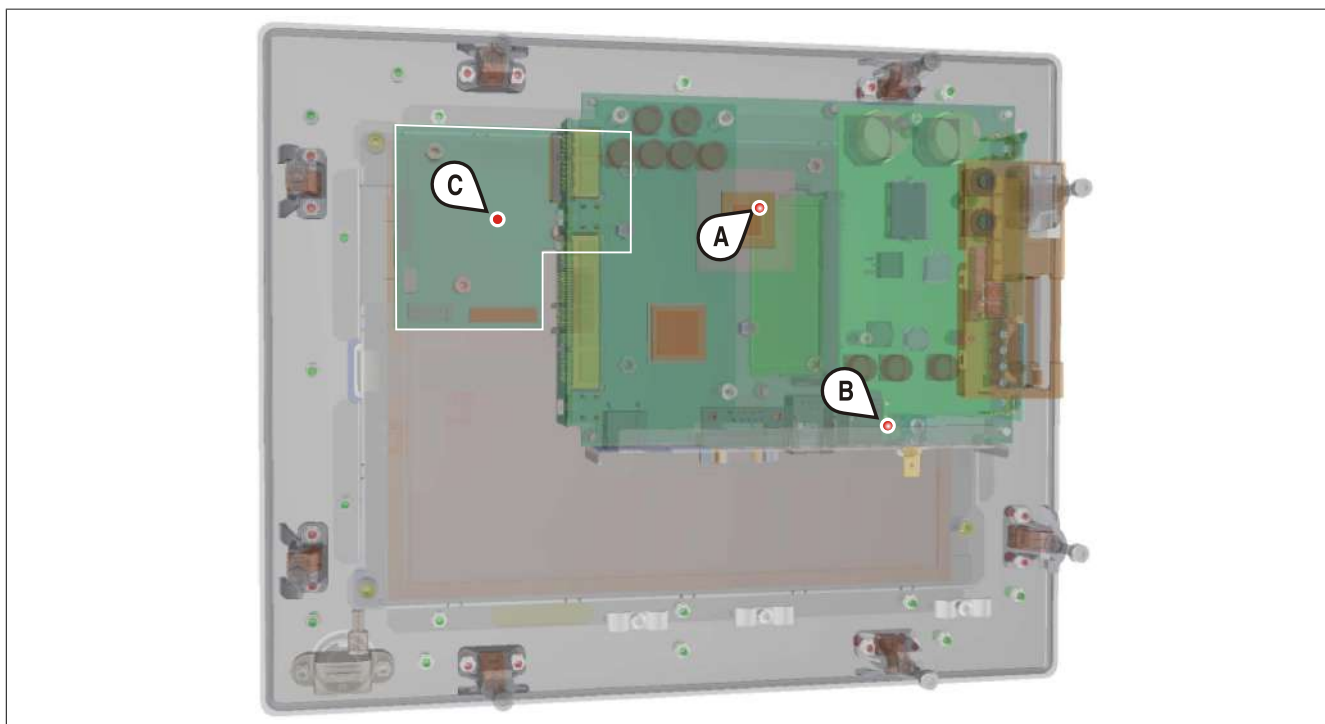

Figure 3: Temperature sensor locations

Position	Measurement point for	Measurement	Max. specified
A	CPU	Ambient temperature of the processor (sensor integrated in the processor)	100°C: 5PP5CP.US15-00, 5PP5CP.US15-01 90°C: 5PP5CP.US15-02
A	Main memory	Ambient temperature of the main memory (sensor integrated in the processor)	80°C
B	Interfaces	Temperature of the interfaces (sensor integrated next to the USB ports)	80°C
C	Display	Temperature of the display (sensor integrated on the display board - the exact position depends on the display diagonal)	80°C: Diagonals 5.7", 7", 10.4", 15"
	Interface board	Temperature of an interface board (sensor integrated on the interface board)	Board-dependent
	I/O board	Temperature of an I/O board (sensor integrated on the I/O board)	Board-dependent

Table 5: Temperature sensor locations

²⁾ The temperature measured approximates the immediate ambient temperature but may also be influenced by neighboring components.

³⁾ The B&R Control Center is included in the ADI driver, which is available in the Downloads section of the B&R website (www.br-automation.com).

2.2 Humidity specifications

The following table lists the minimum and maximum relative humidity values (non-condensing) for the individual components that are relevant for the humidity limitations of a complete system. The lowest and highest common values are always used when establishing these limits.

Component		Operation ¹⁾	Storage / Transport ¹⁾
System units		See temperature humidity diagrams for individual components	
US15W CPU boards		5 to 90%	5 to 95%
Main memory for CPU boards		10 to 90%	5 to 95%
Interface boards	5PP5IF.CETH-00	5 to 90%	5 to 95%
	5PP5IF.CHDA-00	5 to 90%	5 to 95%
	5PP5IF.FETH-00	5 to 90%	5 to 95%
	5PP5IF.FPLM-00	5 to 90%	5 to 95%
	5PP5IF.FCAN-00	5 to 90%	5 to 95%
	5PP5IF.FCAN-00	5 to 90%	5 to 95%
	5PP5IF.FX2X-00	5 to 90%	5 to 95%
I/O board	5PP5IF.FXCM-00	5 to 90%	5 to 95%
	5PP5IO.GNAC-00	5 to 90%	5 to 95%
Accessories	5CFCRD.xxxx-06 CompactFlash cards	85%	85%
	5CFCRD.xxxx-04 CompactFlash cards	85%	85%
	5CFCRD.xxxx-03 CompactFlash cards	8 to 95%	8 to 95%
	5MMUSB.2048-01 flash drive	10 to 90%	5 to 90%
	5MMUSB.4096-01 flash drive	85%	85%

Table 6: Overview of humidity specifications for individual components

1) Specifications correspond to non-condensing relative humidity.

The specifications listed correspond to the relative humidity (non-condensing) at an ambient temperature of 30°C. More detailed information about specific temperature-dependent humidity values can be found in the technical data for the individual components.

2.3 Power management

2.3.1 Supply voltage block diagram

The following block diagram illustrates the simplified structure of the supply voltage for system units.

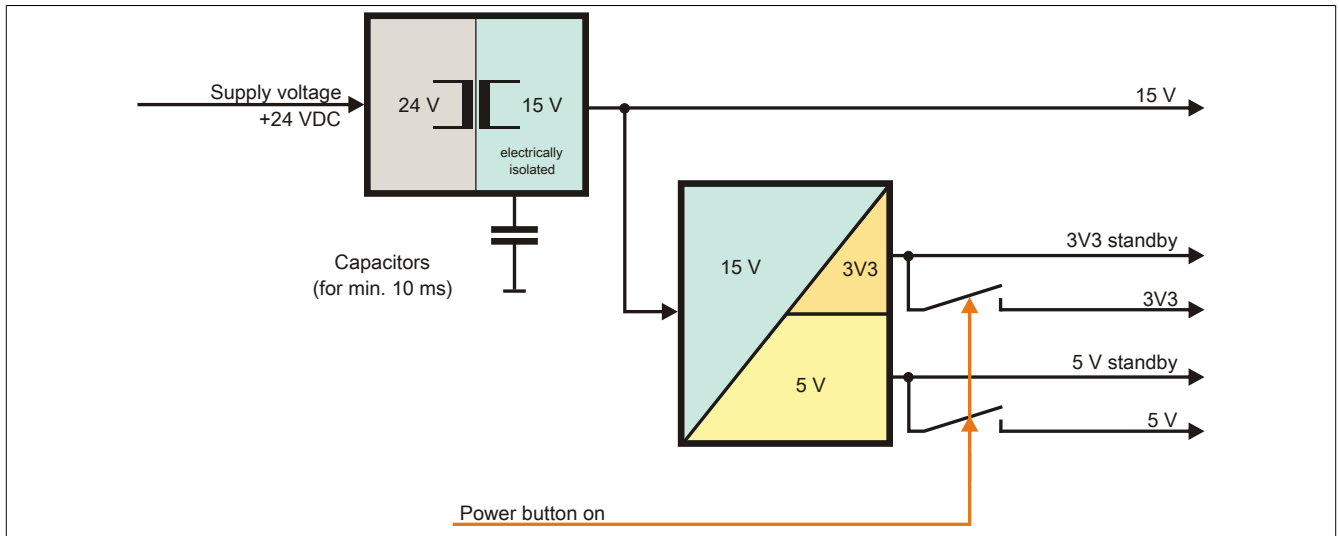

Figure 4: Supply voltage for system units

Description

15 V is generated from the supply voltage using a DC-to-DC converter. This electrically isolated 15 V supplies additional DC-to-DC converters that generate the remaining voltage.

After the system is turned on (e.g. using the power button), the 3V3 and 5 V voltages are active on the system.

2.4 Serial number sticker

A unique serial number sticker with a barcode (Code 128) is affixed to each B&R device for identification purposes. This serial number represents all of the components built into the system (model number, name, revision, serial number and order number).

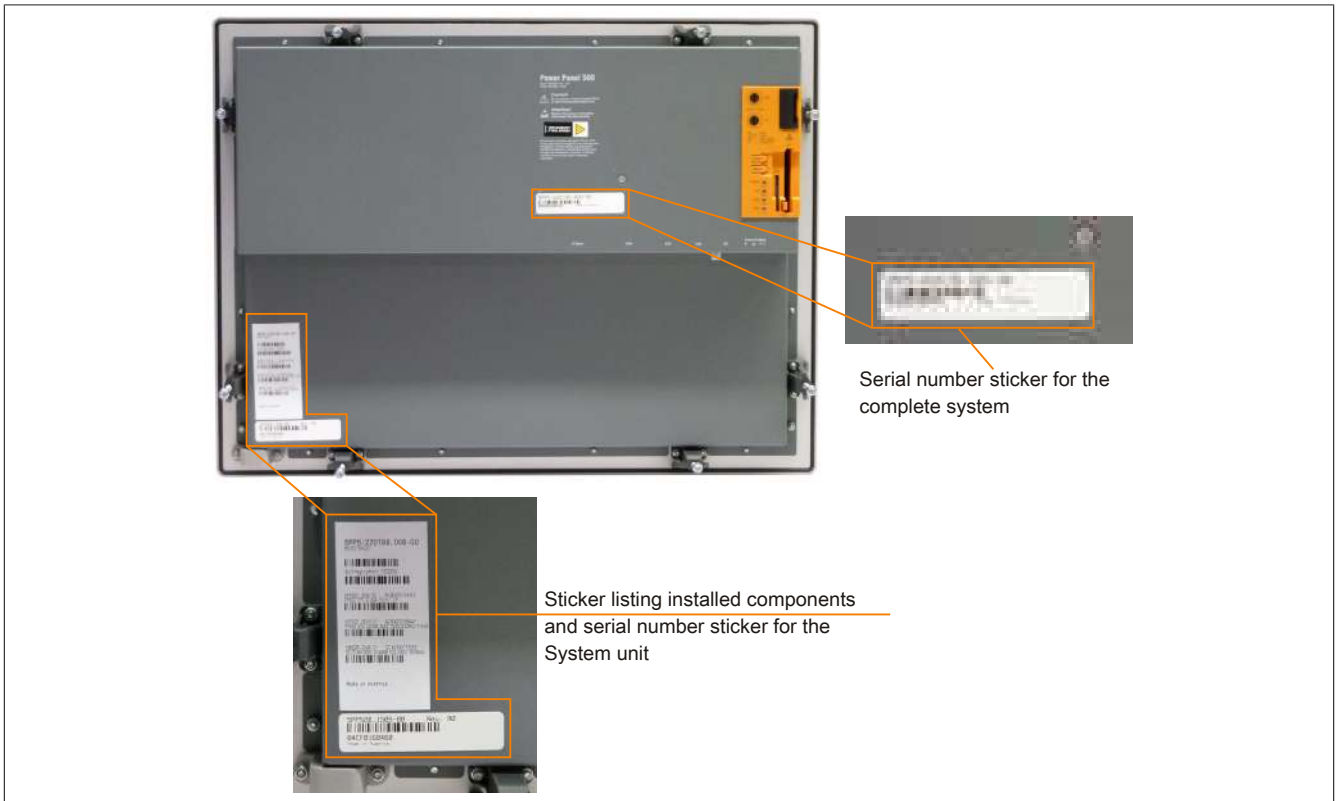

Figure 5: Serial number sticker

This information can also be found on the B&R website by entering the serial number of the complete system in the search field tab (after selecting the "Serial number" option) at the top of the website (www.br-automation.com). The search provides a detailed list of installed components.

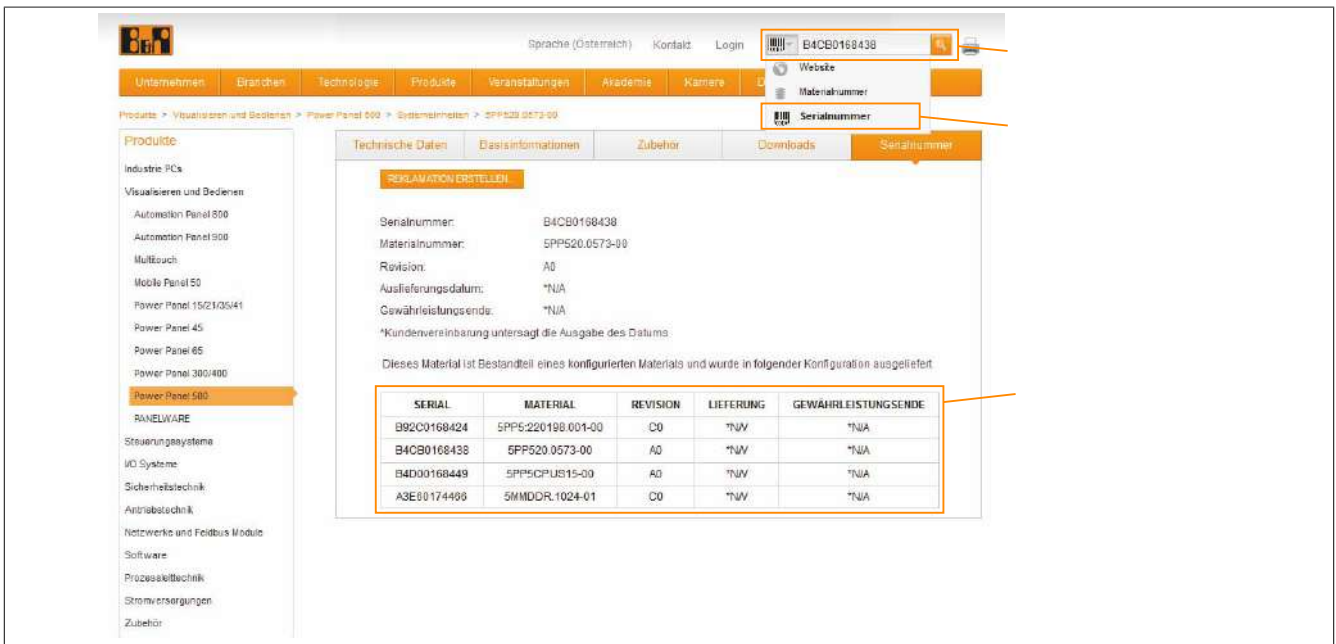

Figure 6: Searching for a serial number

2.5 Device interfaces and slots

2.5.1 Overview of device interfaces

Interfaces for system units with an interface board

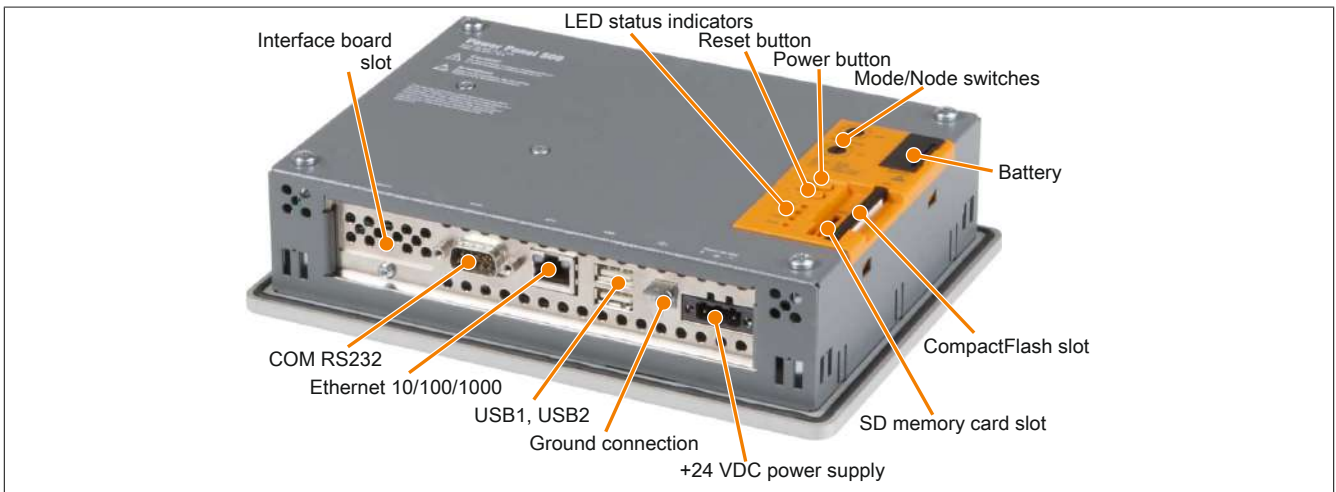

Figure 7: Interfaces with an interface board

Back cover of the system unit

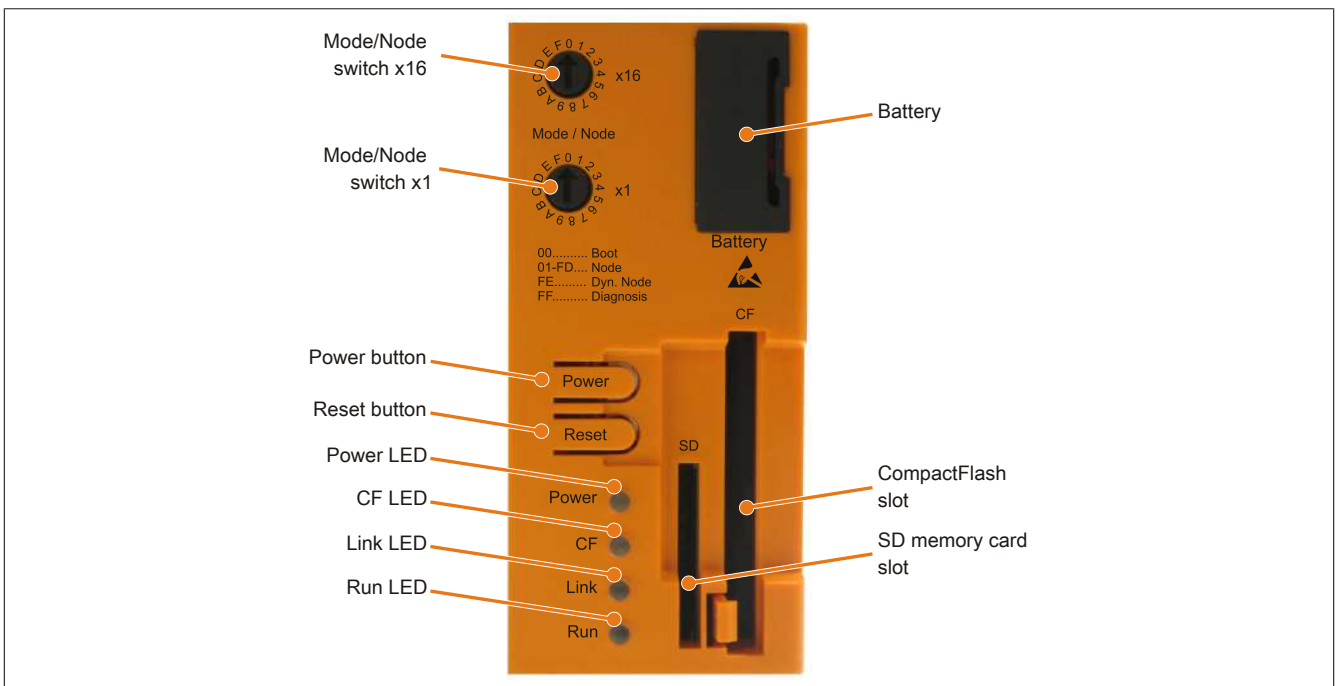

Figure 8: Back cover

2.5.2 +24 VDC power supply

The 3-pin male connector required for the power supply interface is not included in delivery. It can be ordered from B&R using model number 0TB103.9 (screw clamps) or 0TB103.91 (cage clamps).

The pinout is listed in the following table and printed on the housing. The supply voltage is protected internally by a soldered fuse (10 A, fast-acting) to prevent damage to the device in the event of an overload (fuse replacement necessary) or if the voltage supply is connected incorrectly (reverse polarity protection - fuse replacement not necessary). The device must be returned to B&R for repairs if the fuse is blown in the event of an error.

Protected against reverse polarity		3-pin male connector
Pin	Description	
1	+	
2	Functional ground	
3	-	
Model number	Short description	
	Terminal blocks	
0TB103.9	Male connector 24 V 5.08 3-pin screw clamps	
0TB103.91	Male connector 24 V 5.08 3-pin cage clamps	

Table 7: 24 VDC power supply interface

2.5.2.1 Grounding

Caution!

Functional ground (pin 2 of power supply and ground connection) must be kept as short as possible and connected to the largest possible wire cross section at the central grounding point (e.g. the control cabinet or system).

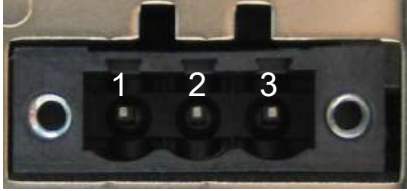
The ground connection is located on the back of the system unit.

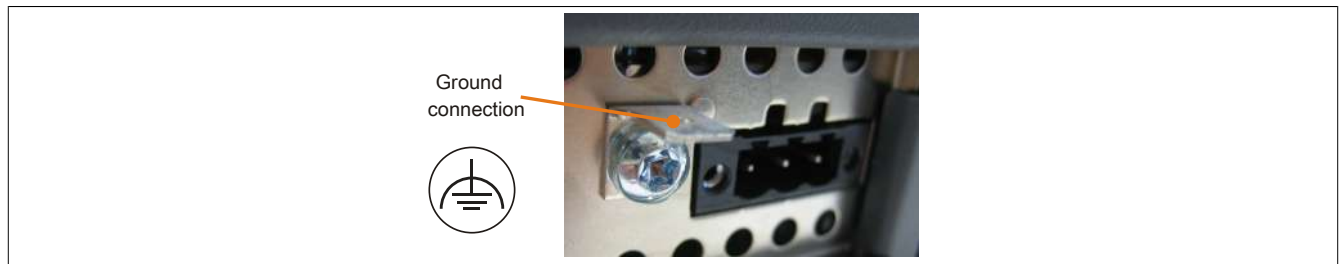

Figure 9: Ground connection

The M4 self-locking nut must be used, for example, to fasten a copper strip to a central grounding point in the control cabinet or system where the device is installed. The largest possible conductor cross section should be used (at least 2.5 mm²).

2.5.3 Serial interface COM

COM serial interface		
RS232		
Type	RS232, modem-capable, not electrically isolated	
UART	16550-compatible, 16-byte FIFO	
Transfer rate	Max. 115 kbaud	
Cable length	Max. 15 meters	
Pin	Assignment	
1	DCD	
2	RXD	
3	TXD	
4	DTR	
5	GND	
6	DSR	
7	RTS	
8	CTS	
9	RI	

9-pin male DSUB connector

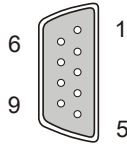

Table 8: COM serial interface - Pinout

2.5.4 Ethernet (ETH)

This Ethernet controller is integrated in the CPU board and connected to external devices via the CPU board.

Ethernet interface (ETH ¹⁾)		
Controller	Intel 82574	
Cabling	S/STP (Cat 5e)	
Transfer rate	10/100/1000 Mbit/s ²⁾	
Cable length	Max. 100 m (min. Cat5e)	
Speed LED	On	Off
Green	100 Mbit/s	10 Mbit/s ³⁾
Orange	1000 Mbit/s	-
Link LED	On	Off
Orange	Link (Ethernet network connection available)	Activity (blinking - data transfer in progress)

Female RJ45 connector

1

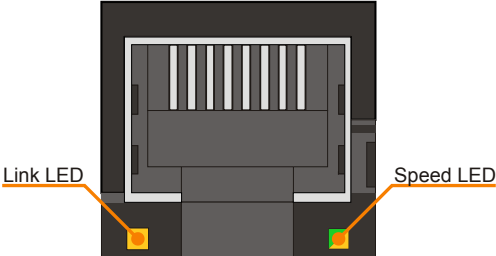

Table 9: Ethernet interface (ETH)

- 1) The interfaces, etc. available on the device or module have been numbered as such for easy identification. This numbering may differ from that used by the particular operating system.
- 2) Switching takes place automatically.
- 3) The 10 Mbit/s transfer speed / connection only exists if the Link LED is also lit at the same time.

Driver support

A special driver is required in order to operate the Intel 82574 Ethernet controller. Drivers for approved operating systems are available in the Downloads section of the B&R website (www.br-automation.com).

Information:

Required drivers can only be downloaded from the B&R website, not from manufacturer websites.

2.5.5 USB interfaces

The PP500 features a USB 2.0 (Universal Serial Bus) host controller with multiple USB interfaces, 2 of which are accessible externally for the user. PP500 devices with a display size of 10.4", 12.1" or 15" are also equipped with a USB interface on the front of the device.

Warning!

Peripheral USB devices can be connected to the USB interfaces on this device. Due to the large number of USB devices available on the market, B&R cannot guarantee their performance. All USB devices provided by B&R are guaranteed to function properly.

Caution!

Because this interface is designed according to general PC specifications, extreme care should be exercised with regard to EMC, cable routing, etc.

USB1, 2

Universal Serial Bus (USB1, USB2) ¹⁾		
Type	USB 2.0	2x USB type A, female 
Design	Type A	
Transfer rate	Low speed (1.5 Mbit/s), full speed (12 Mbit/s), high speed (480 Mbit/s)	
Current load ²⁾ USB1, USB2	Max. 1 A	
Cable length	Max. 5 m (without hub)	

Table 10: USB1, USB2 interfaces

- 1) The interfaces, etc. available on the device or module have been numbered as such for easy identification. This numbering may differ from that used by the particular operating system.
- 2) Each USB interface is protected by a maintenance-free "USB current-limiting circuit breaker" (max. 1 A).

USB3

This front USB port is only available on PP500 devices with a 10.4", 12.1" and 15" display size.

Universal Serial Bus (USB3) ¹⁾		
Type	USB 2.0	1x USB type A, female 
Design	Type A	
Transfer rate	Low speed (1.5 Mbit/s), full speed (12 Mbit/s), high speed (480 Mbit/s)	
Current load ²⁾ USB3	Max. 0.5 A	
Cable length	Max. 5 m (without hub)	

Table 11: USB3 interface

- 1) The interfaces, etc. available on the device or module have been numbered as such for easy identification. This numbering may differ from that used by the particular operating system.
- 2) Each USB interface is protected by a maintenance-free "USB current-limiting circuit breaker" (max. 0.5 A).

2.5.6 Battery

The lithium battery (3 V, 950 mAh) buffers both the internal real-time clock (RTC) as well as data stored in SRAM on interface cards. It is located behind the black cover on the front of the device. The battery's buffer time is at least 4 years (at 50°C, 8.5 µA for the components being supplied and a self-discharge of 40%; if an interface board with SRAM is installed, then the lifespan is reduced to 2½ years). The battery has a limited service life and should be replaced regularly (after the specified service life at the latest).

Battery	
Battery Type	Renata 950 mAh
Removable	Yes, accessible from the outside
Service life	4 years ¹⁾
Model number	Short description
	Batteries
0AC201.91	Lithium batteries, 4 pcs., 3 V / 950 mAh, button cell
4A0006.00-000	Lithium battery, 1 pc., 3 V / 950 mAh, button cell

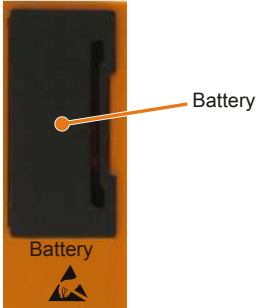

Table 12: Battery

1) At 50°C, 8.5 µA of the supplied components and a self-discharge of 40%. If an interface board with SRAM has been installed, the service life is 2½ years.

Evaluating the battery status

The status of the battery is determined immediately after the device is started and subsequently checked by the system every 24 hours. During this measurement, the battery is subjected to a brief load (approximately 1 second) and then evaluated. Once determined, the battery status is displayed in BIOS (under OEM features - CPU board features - CPU board monitor) and in the B&R Control Center (ADI driver); it can also be read in a customer application using the ADI library.

Battery status	Function
N/A	The hardware or firmware being used is too old and does not support reading the battery status.
GOOD	Data buffering is intact.
BAD	From the point when battery capacity is recognized as insufficient (BAD), data buffering is intact for approximately another 500 hours.

Table 13: Battery status

From the point when battery capacity is recognized as insufficient, data buffering is intact for approximately another 500 hours. When replacing the battery, data is buffered for approximately 10 minutes by a gold leaf capacitor.

2.5.7 CompactFlash slot

This CompactFlash slot is connected to the chipset internally via IDE PATA. Type I CompactFlash cards are supported.

CompactFlash slot	
Connection	PATA master
CompactFlash Type	Type I
Model number	Short description
CompactFlash	
5CFCRD.0512-06	CompactFlash 512 MB B&R
5CFCRD.1024-06	CompactFlash 1024 MB B&R
5CFCRD.2048-06	CompactFlash 2048 MB B&R
5CFCRD.4096-06	CompactFlash 4096 MB B&R
5CFCRD.8192-06	CompactFlash 8192 MB B&R
5CFCRD.016G-06	CompactFlash 16 GB B&R
5CFCRD.032G-06	CompactFlash 32 GB B&R

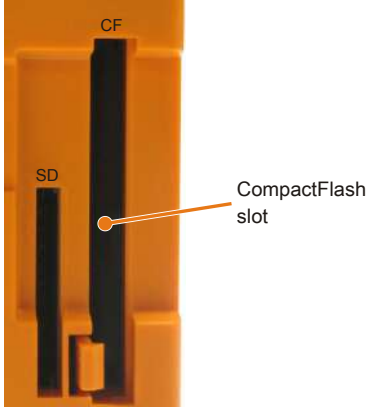

Table 14: CompactFlash slot

Warning!

An- und Abstecken der CompactFlash-Karte darf nur in spannungslosem Zustand erfolgen!

2.5.8 SD memory card slot

The SD memory card slot only supports SD memory cards, not SDHC cards. In addition, SD memory cards can only be used as mass storage devices; booting from SD memory cards is not possible.

SD memory card slot	

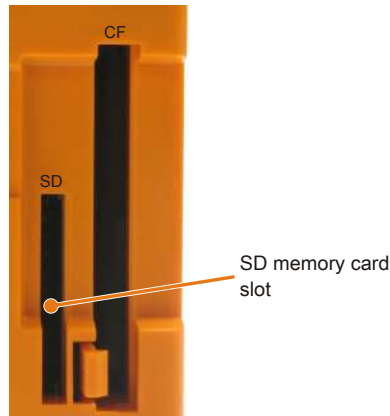

Table 15: SD memory card slot

2.5.9 Power button

The power button provides a wide range of ATX power supply functions.

Power button	
<p>The power button acts like the on/off switch on a normal desktop PC with an ATX power supply:</p> <p>Press and release ... Switches on the device or shuts down the operating system and switches off the device</p> <p>Press and hold ... Switches off the ATX power supply without shutting down the device (data could be lost!)</p> <p>Pressing the power button does not reset the MTCX processor.</p>	

Table 16: Power button

2.5.10 Reset button

Reset button	
<p>Pushing the reset button triggers a hardware and PCI reset.</p> <p>The device is restarted (cold restart). Pressing the reset button does not reset the MTCX processor.</p>	

Table 17: Reset button

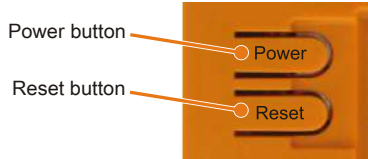
Warning!

A system reset can result in lost data!

2.5.11 Mode/Node switches

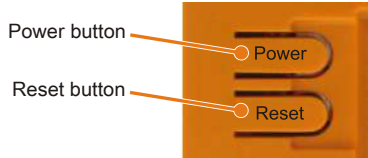
There are two 16-digit hex switches located on the back of the system unit that can be used as operating mode switches. The user can use switch positions 01 to FD as needed and evaluate them in the application program.

Mode/Node switches		
Switch position		
x16	x1	Description
0	0	Boot Default switch position. Not a terminal node switch position.
0...1	F...D	Node Automation Runtime run mode with node 01-FD (CompactFlash Automation Runtime or terminal operation). Can be used as needed, e.g. to set the INA2000 node number of the Ethernet interface.
F	E	Dyn. node Automation Runtime run mode with dynamic node assignment (CompactFlash Automation Runtime or terminal operation). Device addresses can be assigned using software.
F	F	Diagnosis Boots the device in diagnostic mode. Does not initialize program sections in User RAM and User FlashPROM. After diagnostic mode, the CPU always boots with a cold restart.

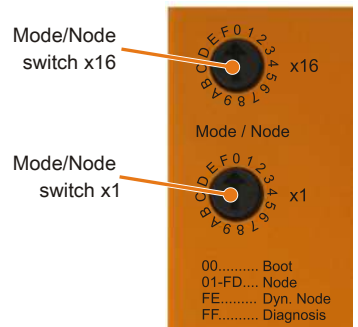



Table 18: Mode/Node switches

2.5.13 Interface board slot

All Power Panel 500 system units have a slot for interface boards.

Interface board slot	
Model number	Short description
	Interface boards
5PP5IF.CETH-00	PP500 interface board; connection for 1x Ethernet 10/100/1000
5PP5IF.CHDA-00	PP500 interface board; connection for 1x MIC, 1x Line IN, 1x Line OUT
5PP5IF.FETH-00	PP500 interface board; connection for 1x Ethernet 10/100/1000, 512 kB SRAM
5PP5IF.FPLM-00	PP500 interface board; connections for 2x POWERLINK
5PP5IF.FCAN-00	PP500 interface board; connection for 1x CAN master, 512 kB SRAM
5PP5IF.FX2X-00	PP500 interface board; connection for 1x X2X master, 512 kB SRAM
5PP5IF.FXCM-00	PP500 interface board; connection for 1x CAN master, 1x X2X master, 512 kB SRAM



Interface board slot with installed interface board

Table 20: Interface board slot

Information:

Interface boards can **ONLY** be installed and replaced by B&R.

2.5.14 I/O board slot

Only the Power Panel 500 system unit 5PP520.0573-01 has a slot for an I/O board.

I/O board slot	
Model number	Short description
	I/O board
5PP5IO.GNAC-00	PP500/APC511 I/O board; connections for 1x USB 2.0, 1x RS232/422/485, HDA Sound, Smart Display Link/DVI-D.

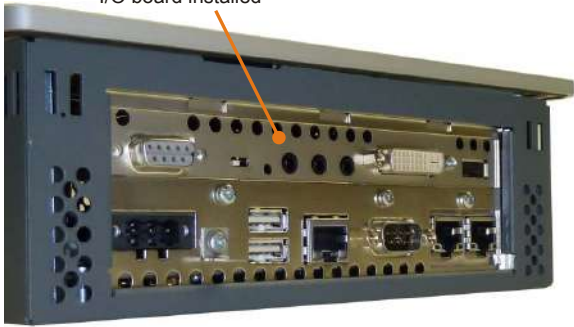

I/O board slot with I/O board installed

Table 21: I/O board slot

Information:

I/O boards can **ONLY** be installed and replaced by B&R.

3 Individual components

3.1 System units

3.1.1 5.7" system units

3.1.1.1 5PP520.0573-00

3.1.1.1.1 General information

- 5.7" TFT VGA color display
- Analog resistive touch screen
- Intel® Atom™ technology
- Compact installation depth
- Fanless operation
- Can be upgraded with interface board

3.1.1.1.2 Order data

Model number	Short description	Figure
System units		
5PP520.0573-00	Power Panel 520 5.7" VGA TFT display with touch screen (resistive); connections for 1x RS232, 2x USB 2.0, 1x Ethernet 10/100/1000; can be expanded with interface board; IP65 protection (front); order male 24 VDC connector for voltage supply separately (screw clamp: 0TB103.9; cage clamp: 0TB103.91)	
Required accessories		
CPU boards		
5PP5CP.US15-00	CPU board Intel Atom Z510 1.1 GHz - Single core - US15W chipset	
5PP5CP.US15-01	CPU board Intel Atom Z520 1.33 GHz - Single core - US15W chipset	
5PP5CP.US15-02	CPU board Intel Atom Z530 1.6 GHz - Single core - US15W chipset	
Main memory		
5MMDDR.0512-01	SO-DIMM DDR2 RAM 512 MB PC2-5300	
5MMDDR.1024-01	SO-DIMM DDR2 RAM 1024 MB PC2-5300	
5MMDDR.2048-01	SO-DIMM DDR2 RAM 2048 MB PC2-5300	
Terminal blocks		
0TB103.9	Connector 24 VDC - 3-pin female - Screw clamps 3.31 mm ²	
0TB103.91	Connector 24 VDC - 3-pin female - Cage clamps 3.31 mm ²	
Optional accessories		
Batteries		
0AC201.91	Lithium batteries 4 pcs., 3 V / 950 mAh button cell We hereby state that the lithium cells contained in this shipment qualify as "partly regulated". Handle with care. If the package is damaged, inspect the cells, repack intact cells and protect cells against short circuits. For emergency information, call RENATA SA at + 41 61 319 28 27	
4A0006.00-000	Lithium battery, 3 V / 950 mAh, button cell	
CompactFlash cards		
5CFCRD.016G-06	CompactFlash 16 GB B&R (SLC)	
5CFCRD.0512-06	CompactFlash 512 MB B&R (SLC)	
5CFCRD.1024-06	CompactFlash 1 GB B&R (SLC)	
5CFCRD.2048-06	CompactFlash 2 GB B&R (SLC)	
5CFCRD.4096-06	CompactFlash 4 GB B&R (SLC)	
5CFCRD.8192-06	CompactFlash 8 GB B&R (SLC)	
Interface boards		
5PP5IF.CETH-00	Ethernet interface card - 1 Ethernet 10/100/1000	
5PP5IF.CHDA-00	Audio interface card - 1 HDA	
5PP5IF.FCAN-00	CAN interface card - 1 CAN master	
5PP5IF.FETH-00	Ethernet interface card - 1 Ethernet 10/100/1000 - 512 kB SRAM	
5PP5IF.FPLM-00	POWERLINK interface card - 2 POWERLINK managing nodes - 512 kB SRAM	
5PP5IF.FX2X-00	X2X Link interface card - 1 X2X Link master - 512 kB SRAM	
5PP5IF.FXCM-00	CAN interface card - 1 CAN master - 1 X2X master - 512 kB SRAM - Can be installed in PP500, APC510, APC511 systems	
USB accessories		
5MMUSB.2048-01	USB 2.0 flash drive, 2048 MB, B&R	
5MMUSB.4096-01	USB 2.0 flash drive, 4096 MB, B&R	

Table 22: 5PP520.0573-00 - Order data

3.1.1.1.3 Technical data

Product ID	5PP520.0573-00
General information	
Cooling	Fanless
LED status indicators	Power, CF, Link, Run
B&R ID code	0xB4CB
Battery	
Type	Renata 950 mAh
Service life	4 years ¹⁾
Removable	Yes, accessible from the outside
Design	Lithium ion
Power button	Yes
Reset button	Yes
Buzzer	Yes
Certification	
CE	Yes
cULus	Yes
GOST-R	Yes
Controller	
Boot loader	BIOS
Mode/Node switches	2, 16 positions each (back)
Watchdog	MTCX
Power failure logic	
Controller	MTCX ²⁾
Buffer time	10 ms
Graphics	
Controller	Intel® Graphics Media Accelerator 500
Memory	
Type	DDR2 SDRAM
Memory size	Max. 2 GB
Interfaces	
COM1 ³⁾	
Type	RS232, modem-capable, not electrically isolated
Design	9-pin male DSUB connector
UART	16550-compatible, 16-byte FIFO
Max. baud rate	115 kbit/s
CompactFlash slot 1	
Type	Type I
SD memory card slot	
Type	SD card
USB	
Quantity	2
Type	USB 2.0
Design	Type A
Transfer rate	Low speed (1.5 Mbit/s), full speed (12 Mbit/s), high speed (480 Mbit/s)
Current load	Max. 1 A per connection
Ethernet	
Quantity	1
Controller	Intel 82574
Design	Shielded RJ45 port
Transfer rate	10/100/1000 Mbit/s
Display	
Type	Color TFT
Display size	5.7" (144 mm)
Colors	262,144
Resolution	VGA, 640 x 480 pixels
Contrast	850:1
Viewing angles	
Horizontal	Direction R = 80° / Direction L = 80°
Vertical	Direction U = 80° / Direction D = 80°
Backlight	
Type	LED
Brightness (dimnable)	Typ. 20 to 400 cd/m ²
Half-brightness time ⁴⁾	50,000 h
Touch screen ⁵⁾	
Type	AMT
Technology	Analog, resistive
Controller	B&R, serial, 12-bit
Transmittance	81% ±3%
Keys	
Function keys	No
System keys	No
Service life	-
LED brightness	-

Table 23: 5PP520.0573-00 - Technical data

Product ID	5PP520.0573-00
Inserts	
Interface board	Yes
I/O board	No
Electrical characteristics	
Nominal voltage	24 VDC ±25%
Nominal current	1 A ⁶⁾
Starting current	Typ. 3 A, max. 50 A for <300 µs
Power consumption	23 W ⁷⁾
Electrical isolation	Yes
Operating conditions	
EN 60529 protection	Back: IP20 (only with an inserted CF card, IF board or optional IF cover) Front: IP65, protection from dust and sprayed water
Environmental conditions	
Temperature	
Operation	0 to 55°C
Storage	-20 to 60°C
Transport	-20 to 60°C
Relative humidity	
Operation	See temperature/humidity diagram
Storage	See temperature/humidity diagram
Transport	See temperature/humidity diagram
Vibration	
Operation (continuous)	2 to 9 Hz: 1.75 mm amplitude / 9 to 200 Hz: 0.5 g
Operation (occasional)	2 to 9 Hz: 3.5 mm amplitude / 9 to 200 Hz: 1 g
Storage	2 to 8 Hz: 7.5 mm amplitude / 8 to 200 Hz: 2 g / 200 to 500 Hz: 4 g
Transport	2 to 8 Hz: 7.5 mm amplitude / 8 to 200 Hz: 2 g / 200 to 500 Hz: 4 g
Shock	
Operation	15 g, 11 ms
Storage	30 g, 6 ms
Transport	30 g, 6 ms
Elevation	
Operation	Max. 3000 m (component-dependent) ⁸⁾
Mechanical characteristics	
Housing	
Material	Galvanized steel plate
Front ⁹⁾	
Frame	Naturally anodized aluminum
Panel overlay	
Material	Polyester
Light background	RAL 9006
Dark gray border around display	RAL 7024
Gasket	Flat gasket around display front
Dimensions	
Width	212 mm
Height	156 mm
Depth	55 mm
Weight	1287 g

Table 23: 5PP520.0573-00 - Technical data

- 1) At 50°C, 8.5 µA of the supplied components and a self-discharge of 40%. If an interface board with SRAM has been installed, the service life is 2½ years.
- 2) Maintenance Controller Extended.
- 3) The COM1 interface is identified in BIOS as the COM A interface.
- 4) At an ambient temperature of 25°C. Reducing the brightness by 50% can result in an approximately 50% increase in the half-brightness time.
- 5) Touch screen drivers for approved operating systems are available in the Downloads section of the B&R website.
- 6) The specified value applies to a nominal voltage of 24 VDC.
- 7) The specified value applies to a system unit with a CPU board but without an interface board.
- 8) The maximum ambient temperature is typically derated by 1°C per 1000 meters (starting at 500 meters above sea level).
- 9) There may be visible deviations in the color and surface appearance depending on the process or batch.

3.1.1.1.4 Dimensions

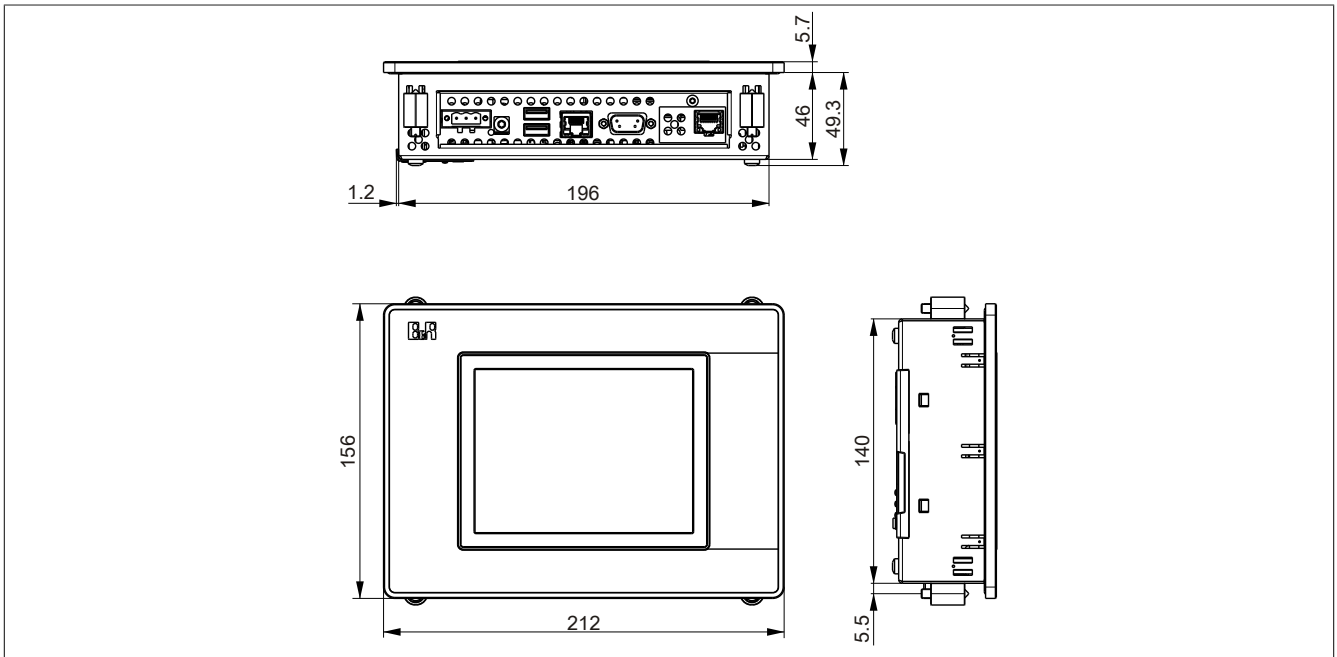

Figure 11: 5PP520.0573-00 - Dimensions

3.1.1.1.5 Cutout installation

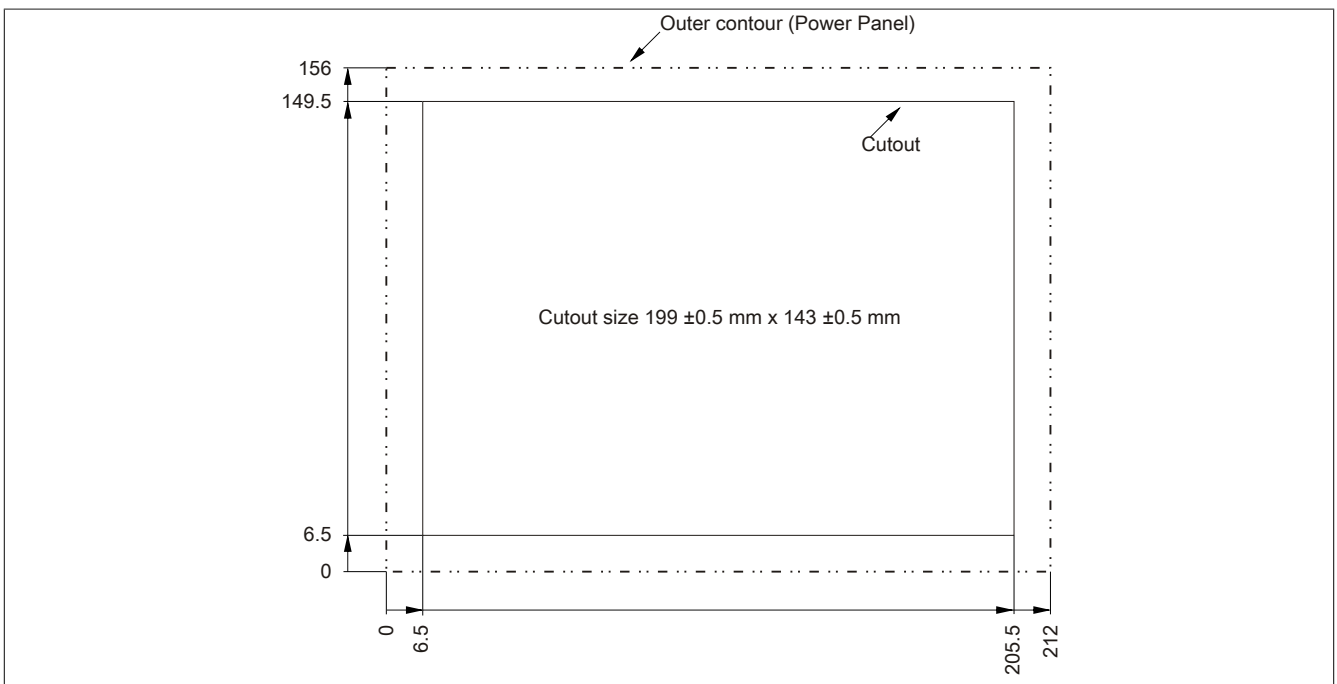

Figure 12: 5PP520.0573-00 - Cutout installation

3.1.1.1.6 Temperature humidity diagram

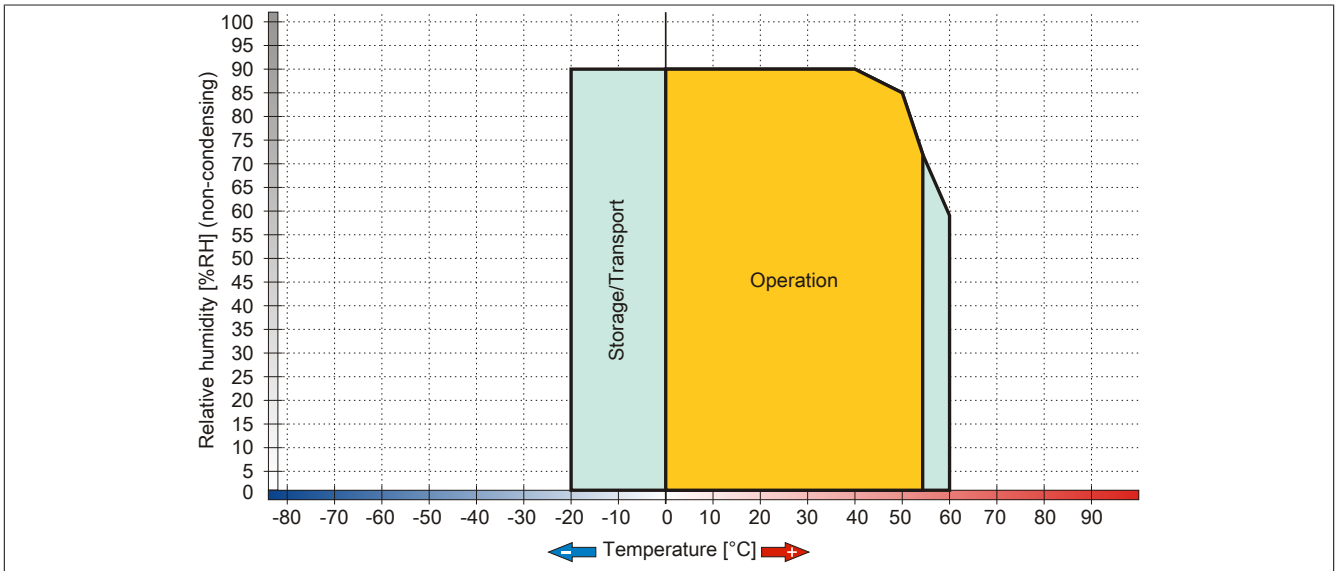

Figure 13: 5PP520.0573-00 - Temperature humidity diagram

3.1.1.2 5PP520.0573-01

3.1.1.2.1 General information

- 5.7" TFT VGA color display
- Analog resistive touch screen
- Intel® Atom™ technology
- Compact installation depth
- Fanless operation
- Can be expanded with an interface or I/O board

3.1.1.2.2 Order data

Model number	Short description	Figure
5PP520.0573-01	Power Panel 520 5.7" VGA TFT display with touch screen (resistive); connections for 1x RS232, 2x USB 2.0, 1x Ethernet 10/100/1000; can be expanded with interface board and I/O board; IP65 protection (front); order male 24 VDC connector for voltage supply separately (screw clamp: 0TB103.9; cage clamp: 0TB103.91)	
	System units	
	Required accessories	
	CPU boards	
5PP5CP.US15-00	CPU board Intel Atom Z510 1.1 GHz - Single core - US15W chipset	
5PP5CP.US15-01	CPU board Intel Atom Z520 1.33 GHz - Single core - US15W chipset	
5PP5CP.US15-02	CPU board Intel Atom Z530 1.6 GHz - Single core - US15W chipset	
	Main memory	
5MMDDR.0512-01	SO-DIMM DDR2 RAM 512 MB PC2-5300	
5MMDDR.1024-01	SO-DIMM DDR2 RAM 1024 MB PC2-5300	
5MMDDR.2048-01	SO-DIMM DDR2 RAM 2048 MB PC2-5300	
	Terminal blocks	
0TB103.9	Connector 24 VDC - 3-pin female - Screw clamps 3.31 mm ²	
0TB103.91	Connector 24 VDC - 3-pin female - Cage clamps 3.31 mm ²	
	Optional accessories	
	Batteries	
0AC201.91	Lithium batteries 4 pcs., 3 V / 950 mAh button cell We hereby state that the lithium cells contained in this shipment qualify as "partly regulated". Handle with care. If the package is damaged, inspect the cells, repack intact cells and protect cells against short circuits. For emergency information, call RENATA SA at + 41 61 319 28 27	
4A0006.00-000	Lithium battery, 3 V / 950 mAh, button cell	
	CompactFlash cards	
5CFCRD.016G-06	CompactFlash 16 GB B&R (SLC)	
5CFCRD.0512-06	CompactFlash 512 MB B&R (SLC)	
5CFCRD.1024-06	CompactFlash 1 GB B&R (SLC)	
5CFCRD.2048-06	CompactFlash 2 GB B&R (SLC)	
5CFCRD.4096-06	CompactFlash 4 GB B&R (SLC)	
5CFCRD.8192-06	CompactFlash 8 GB B&R (SLC)	
	I/O board	
5PP5IO.GNAC-00	Interface board - 1 USB 2.0 - 1 RS232/422/485 - 1 HDA sound - 1 SDL/DVI-D	
	Interface boards	
5PP5IF.CETH-00	Ethernet interface card - 1 Ethernet 10/100/1000	
5PP5IF.CHDA-00	Audio interface card - 1 HDA	
5PP5IF.FCAN-00	CAN interface card - 1 CAN master	
5PP5IF.FETH-00	Ethernet interface card - 1 Ethernet 10/100/1000 - 512 kB SRAM	
5PP5IF.FPLM-00	POWERLINK interface card - 2 POWERLINK managing nodes - 512 kB SRAM	
5PP5IF.FX2X-00	X2X Link interface card - 1 X2X Link master - 512 kB SRAM	
5PP5IF.FXCM-00	CAN interface card - 1 CAN master - 1 X2X master - 512 kB SRAM - Can be installed in PP500, APC510, APC511 systems	
	USB accessories	
5MMUSB.2048-01	USB 2.0 flash drive, 2048 MB, B&R	
5MMUSB.4096-01	USB 2.0 flash drive, 4096 MB, B&R	

Table 24: 5PP520.0573-01 - Order data

3.1.1.2.3 Technical data

Product ID	5PP520.0573-01
General information	
Cooling	Fanless
LED status indicators	Power, CF, Link, Run
B&R ID code	0xB4CC
Battery	
Type	Renata 950 mAh
Service life	4 years ¹⁾
Removable	Yes, accessible from the outside
Design	Lithium ion
Power button	Yes
Reset button	Yes
Buzzer	Yes
Certification	
CE	Yes
cULus	Yes
GOST-R	Yes
Controller	
Boot loader	BIOS
Mode/Node switches	2, 16 positions each (back)
Watchdog	MTCX
Power failure logic	
Controller	MTCX ²⁾
Buffer time	10 ms
Graphics	
Controller	Intel® Graphics Media Accelerator 500
Memory	
Type	DDR2 SDRAM
Memory size	Max. 2 GB
Interfaces	
COM1 ³⁾	
Type	RS232, modem-capable, not electrically isolated
Design	9-pin male DSUB connector
UART	16550-compatible, 16-byte FIFO
Max. baud rate	115 kbit/s
CompactFlash slot 1	
Type	Type I
SD memory card slot	
Type	SD card
USB	
Quantity	2
Type	USB 2.0
Design	Type A
Transfer rate	Low speed (1.5 Mbit/s), full speed (12 Mbit/s), high speed (480 Mbit/s)
Current load	Max. 1 A per connection
Ethernet	
Quantity	1
Controller	Intel 82574
Design	Shielded RJ45 port
Transfer rate	10/100/1000 Mbit/s
Display	
Type	Color TFT
Display size	5.7" (144 mm)
Colors	262,144
Resolution	VGA, 640 x 480 pixels
Contrast	850:1
Viewing angles	
Horizontal	Direction R = 80° / Direction L = 80°
Vertical	Direction U = 80° / Direction D = 80°
Backlight	
Type	LED
Brightness (dimnable)	Typ. 20 to 400 cd/m ²
Half-brightness time ⁴⁾	50,000 h
Touch screen ⁵⁾	
Type	AMT
Technology	Analog, resistive
Controller	B&R, serial, 12-bit
Transmittance	81% ±3%
Keys	
Function keys	No
System keys	No
Service life	-
LED brightness	-

Table 25: 5PP520.0573-01 - Technical data

Product ID	5PP520.0573-01
Inserts	
Interface board	Yes
I/O board	Yes
Electrical characteristics	
Nominal voltage	24 VDC ±25%
Nominal current	1.5 A ⁶⁾
Starting current	Typ. 3 A, max. 50 A for <300 µs
Power consumption	23 W ⁷⁾
Electrical isolation	Yes
Operating conditions	
EN 60529 protection	Back: IP20 (only with an inserted CF card, IF board or optional IF cover) Front: IP65, protection from dust and sprayed water
Environmental conditions	
Temperature	
Operation	0 to 55°C
Storage	-20 to 60°C
Transport	-20 to 60°C
Relative humidity	
Operation	See temperature/humidity diagram
Storage	See temperature/humidity diagram
Transport	See temperature/humidity diagram
Vibration	
Operation (continuous)	2 to 9 Hz: 1.75 mm amplitude / 9 to 200 Hz: 0.5 g
Operation (occasional)	2 to 9 Hz: 3.5 mm amplitude / 9 to 200 Hz: 1 g
Storage	2 to 8 Hz: 7.5 mm amplitude / 8 to 200 Hz: 2 g / 200 to 500 Hz: 4 g
Transport	2 to 8 Hz: 7.5 mm amplitude / 8 to 200 Hz: 2 g / 200 to 500 Hz: 4 g
Shock	
Operation	15 g, 11 ms
Storage	30 g, 6 ms
Transport	30 g, 6 ms
Elevation	
Operation	Max. 3000 m (component-dependent) ⁸⁾
Mechanical characteristics	
Housing	
Material	Galvanized steel plate
Front ⁹⁾	
Frame	Naturally anodized aluminum
Panel overlay	
Material	Polyester
Light background	RAL 9006
Dark gray border around display	RAL 7024
Gasket	Flat gasket around display front
Dimensions	
Width	212 mm
Height	156 mm
Depth	55 mm
Weight	1287 g

Table 25: 5PP520.0573-01 - Technical data

- 1) At 50°C, 8.5 µA of the supplied components and a self-discharge of 40%. If an interface board with SRAM has been installed, the service life is 2½ years.
- 2) Maintenance Controller Extended.
- 3) The COM1 interface is identified in BIOS as the COM A interface.
- 4) At an ambient temperature of 25°C. Reducing the brightness by 50% can result in an approximately 50% increase in the half-brightness time.
- 5) Touch screen drivers for approved operating systems are available in the Downloads section of the B&R website.
- 6) The specified value applies to a nominal voltage of 24 VDC.
- 7) The specified value applies to a system unit with CPU board without an interface and I/O board.
- 8) The maximum ambient temperature is typically derated by 1°C per 1000 meters (starting at 500 meters above sea level).
- 9) There may be visible deviations in the color and surface appearance depending on the process or batch.

3.1.1.2.4 Dimensions

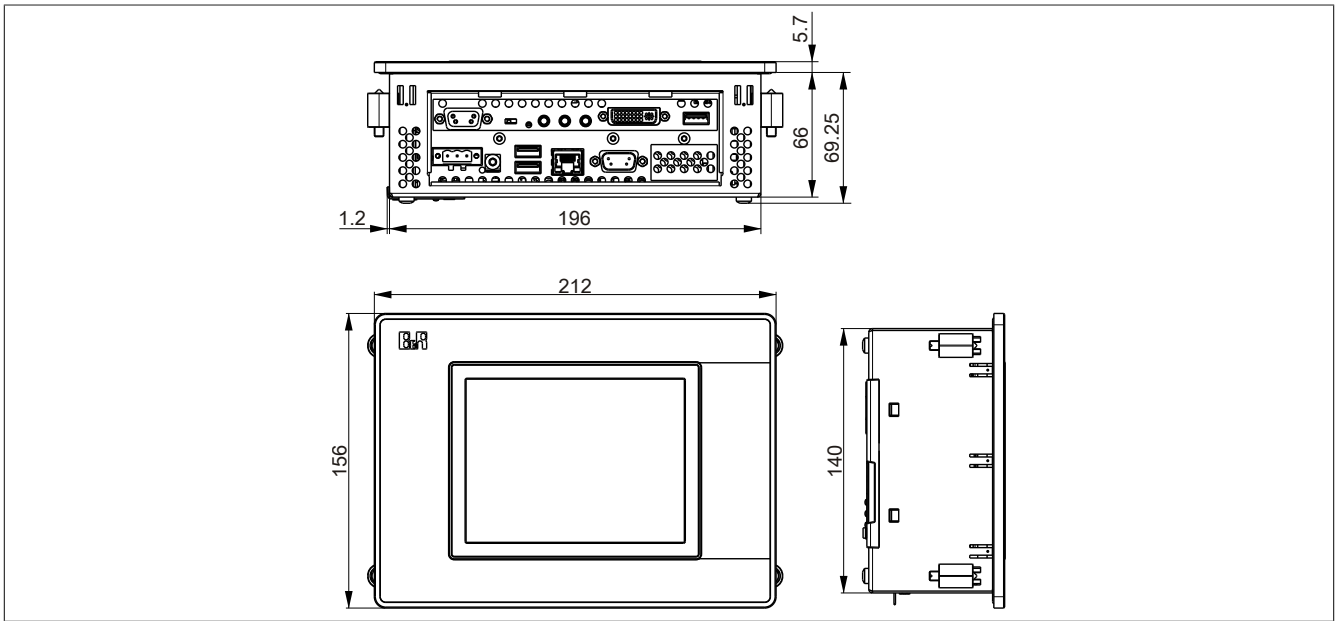

Figure 14: 5PP520.0573-01 - Dimensions

3.1.1.2.5 Cutout installation

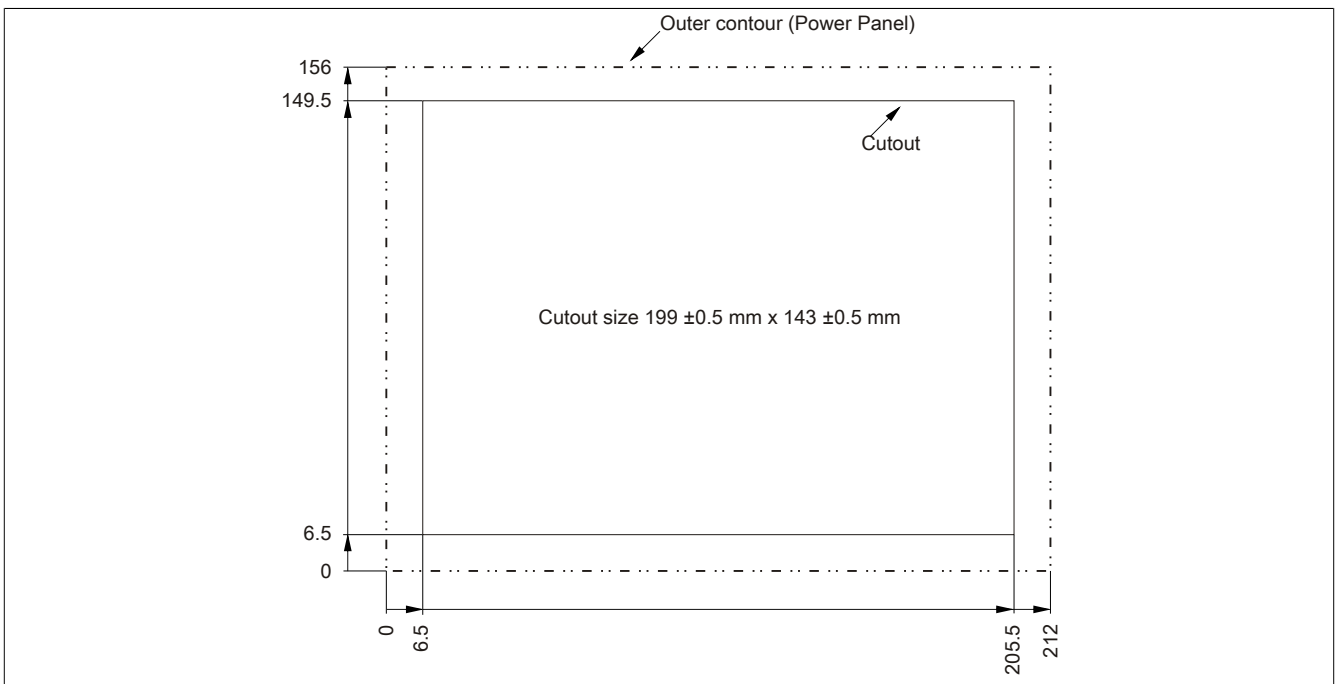

Figure 15: 5PP520.0573-01 - Cutout installation

3.1.1.2.6 Temperature humidity diagram

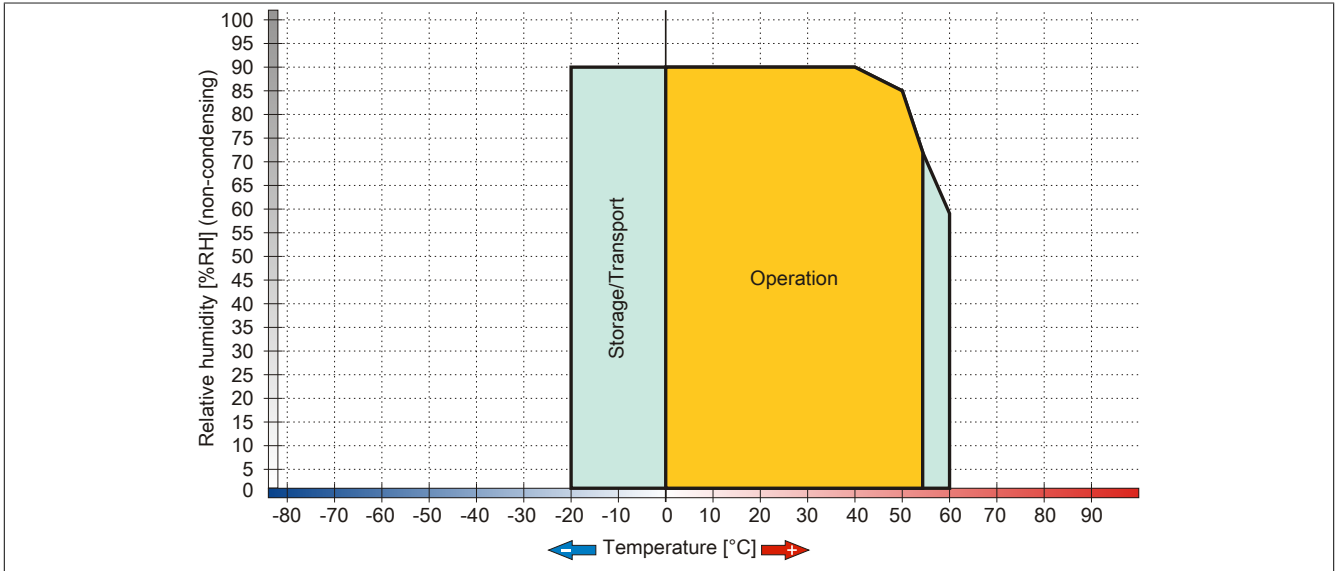

Figure 16: 5PP520.0573-01 - Temperature humidity diagram

3.1.1.3 5PP551.0573-00

3.1.1.3.1 General information

- 5.7" TFT VGA color display
- Function and system keys
- Intel® Atom™ technology
- Compact installation depth
- Fanless operation
- Can be upgraded with interface board

3.1.1.3.2 Order data

Model number	Short description	Figure
5PP551.0573-00	Power Panel 551 5.7" VGA TFT display; 22 function keys and 20 system keys; connections for 1x RS232, 2x USB 2.0, 1x Ethernet 10/100/1000; can be expanded with interface board; IP65 protection (front); order male 24 VDC connector for voltage supply separately (screw clamp: 0TB103.9; cage clamp: 0TB103.91)	
	Required accessories	
	CPU boards	
5PP5CP.US15-00	CPU board Intel Atom Z510 1.1 GHz - Single core - US15W chipset	
5PP5CP.US15-01	CPU board Intel Atom Z520 1.33 GHz - Single core - US15W chipset	
5PP5CP.US15-02	CPU board Intel Atom Z530 1.6 GHz - Single core - US15W chipset	
	Main memory	
5MMDDR.0512-01	SO-DIMM DDR2 RAM 512 MB PC2-5300	
5MMDDR.1024-01	SO-DIMM DDR2 RAM 1024 MB PC2-5300	
5MMDDR.2048-01	SO-DIMM DDR2 RAM 2048 MB PC2-5300	
	Terminal blocks	
0TB103.9	Connector 24 VDC - 3-pin female - Screw clamps 3.31 mm ²	
0TB103.91	Connector 24 VDC - 3-pin female - Cage clamps 3.31 mm ²	
	Optional accessories	
	Batteries	
0AC201.91	Lithium batteries 4 pcs., 3 V / 950 mAh button cell We hereby state that the lithium cells contained in this shipment qualify as "partly regulated". Handle with care. If the package is damaged, inspect the cells, repack intact cells and protect cells against short circuits. For emergency information, call RENATA SA at + 41 61 319 28 27	
4A0006.00-000	Lithium battery, 3 V / 950 mAh, button cell	
	CompactFlash cards	
5CFCRD.016G-06	CompactFlash 16 GB B&R (SLC)	
5CFCRD.0512-06	CompactFlash 512 MB B&R (SLC)	
5CFCRD.1024-06	CompactFlash 1 GB B&R (SLC)	
5CFCRD.2048-06	CompactFlash 2 GB B&R (SLC)	
5CFCRD.4096-06	CompactFlash 4 GB B&R (SLC)	
5CFCRD.8192-06	CompactFlash 8 GB B&R (SLC)	
	Interface boards	
5PP5IF.CETH-00	Ethernet interface card - 1 Ethernet 10/100/1000	
5PP5IF.CHDA-00	Audio interface card - 1 HDA	
5PP5IF.FCAN-00	CAN interface card - 1 CAN master	
5PP5IF.FETH-00	Ethernet interface card - 1 Ethernet 10/100/1000 - 512 kB SRAM	
5PP5IF.FPLM-00	POWERLINK interface card - 2 POWERLINK managing nodes - 512 kB SRAM	
5PP5IF.FX2X-00	X2X Link interface card - 1 X2X Link master - 512 kB SRAM	
5PP5IF.FXCM-00	CAN interface card - 1 CAN master - 1 X2X master - 512 kB SRAM - Can be installed in PP500, APC510, APC511 systems	
	USB accessories	
5MMUSB.2048-01	USB 2.0 flash drive, 2048 MB, B&R	
5MMUSB.4096-01	USB 2.0 flash drive, 4096 MB, B&R	

Table 26: 5PP551.0573-00 - Order data

3.1.1.3.3 Technical data

Product ID	5PP551.0573-00
General information	
Cooling	Fanless
LED status indicators	Power, CF, Link, Run
B&R ID code	0xB604
Battery	
Type	Renata 950 mAh
Service life	4 years ¹⁾
Removable	Yes, accessible from the outside
Design	Lithium ion
Power button	Yes
Reset button	Yes
Buzzer	Yes
Certification	
CE	Yes
cULus	Yes
GOST-R	Yes
GL	Yes ²⁾
Controller	
Boot loader	BIOS
Mode/Node switches	2, 16 positions each (back)
Watchdog	MTCX
Power failure logic	
Controller	MTCX ³⁾
Buffer time	10 ms
Graphics	
Controller	Intel® Graphics Media Accelerator 500
Memory	
Type	DDR2 SDRAM
Memory size	Max. 2 GB
Interfaces	
COM1 ⁴⁾	
Type	RS232, modem-capable, not electrically isolated
Design	9-pin male DSUB connector
UART	16550-compatible, 16-byte FIFO
Max. baud rate	115 kbit/s
CompactFlash slot 1	
Type	Type I
SD memory card slot	
Type	SD card
USB	
Quantity	2
Type	USB 2.0
Design	Type A
Transfer rate	Low speed (1.5 Mbit/s), full speed (12 Mbit/s), high speed (480 Mbit/s)
Current load	Max. 1 A per connection
Ethernet	
Quantity	1
Controller	Intel 82574
Design	Shielded RJ45 port
Transfer rate	10/100/1000 Mbit/s
Display	
Type	Color TFT
Display size	5.7" (144 mm)
Colors	262,144
Resolution	VGA, 640 x 480 pixels
Contrast	850:1
Viewing angles	
Horizontal	Direction R = 80° / Direction L = 80°
Vertical	Direction U = 80° / Direction D = 80°
Backlight	
Type	LED
Brightness (dimnable)	Typ. 20 to 400 cd/m ²
Half-brightness time ⁵⁾	50,000 h
Touch screen ⁶⁾	
Type	-
Technology	-
Controller	-
Transmittance	-
Keys	
Function keys	22 with LED (yellow)
System keys	Numeric keys, cursor block
Service life	>1,000,000 actuations at 1 ±0.3N to 3 ±0.3 N actuating force

Table 27: 5PP551.0573-00 - Technical data

Product ID	5PP551.0573-00
LED brightness Yellow	Typ. 38 mcd
Inserts	
Interface board	Yes
I/O board	No
Electrical characteristics	
Nominal voltage	24 VDC ±25%
Nominal current	1.1 A ⁷⁾
Starting current	Typ. 3 A, max. 50 A for <300 µs
Power consumption	26 W ⁸⁾
Electrical isolation	Yes
Operating conditions	
EN 60529 protection	Back: IP20 (only with an inserted CF card, IF board or optional IF cover) Front: IP65, protection from dust and sprayed water
Environmental conditions	
Temperature	
Operation	0 to 55°C
Storage	-20 to 60°C
Transport	-20 to 60°C
Relative humidity	
Operation	See temperature/humidity diagram
Storage	See temperature/humidity diagram
Transport	See temperature/humidity diagram
Vibration	
Operation (continuous)	2 to 9 Hz: 1.75 mm amplitude / 9 to 200 Hz: 0.5 g
Operation (occasional)	2 to 9 Hz: 3.5 mm amplitude / 9 to 200 Hz: 1 g
Storage	2 to 8 Hz: 7.5 mm amplitude / 8 to 200 Hz: 2 g / 200 to 500 Hz: 4 g
Transport	2 to 8 Hz: 7.5 mm amplitude / 8 to 200 Hz: 2 g / 200 to 500 Hz: 4 g
Shock	
Operation	15 g, 11 ms
Storage	30 g, 6 ms
Transport	30 g, 6 ms
Elevation	
Operation	Max. 3000 m (component-dependent) ⁹⁾
Mechanical characteristics	
Housing	
Material	Galvanized steel plate
Front ¹⁰⁾	
Frame	Naturally anodized aluminum
Panel overlay	
Material	Polyester
Light background	RAL 9006
Dark gray border around display	RAL 7024
Gasket	Flat gasket around display front
Dimensions	
Width	212 mm
Height	245 mm
Depth	54.95 mm
Weight	1750 g

Table 27: 5PP551.0573-00 - Technical data

- 1) At 50°C, 8.5 µA of the supplied components and a self-discharge of 40%. If an interface board with SRAM has been installed, the service life is 2½ years.
- 2) Yes, although applies only if all components installed within the complete system have this certification.
- 3) Maintenance Controller Extended.
- 4) The COM1 interface is identified in BIOS as the COM A interface.
- 5) At an ambient temperature of 25°C. Reducing the brightness by 50% can result in an approximately 50% increase in the half-brightness time.
- 6) Touch screen drivers for approved operating systems are available in the Downloads section of the B&R website.
- 7) The specified value applies to a nominal voltage of 24 VDC.
- 8) The specified value applies to a system unit with a CPU board but without an interface board.
- 9) The maximum ambient temperature is typically derated by 1°C per 1000 meters (starting at 500 meters above sea level).
- 10) There may be visible deviations in the color and surface appearance depending on the process or batch.

3.1.1.3.4 Dimensions

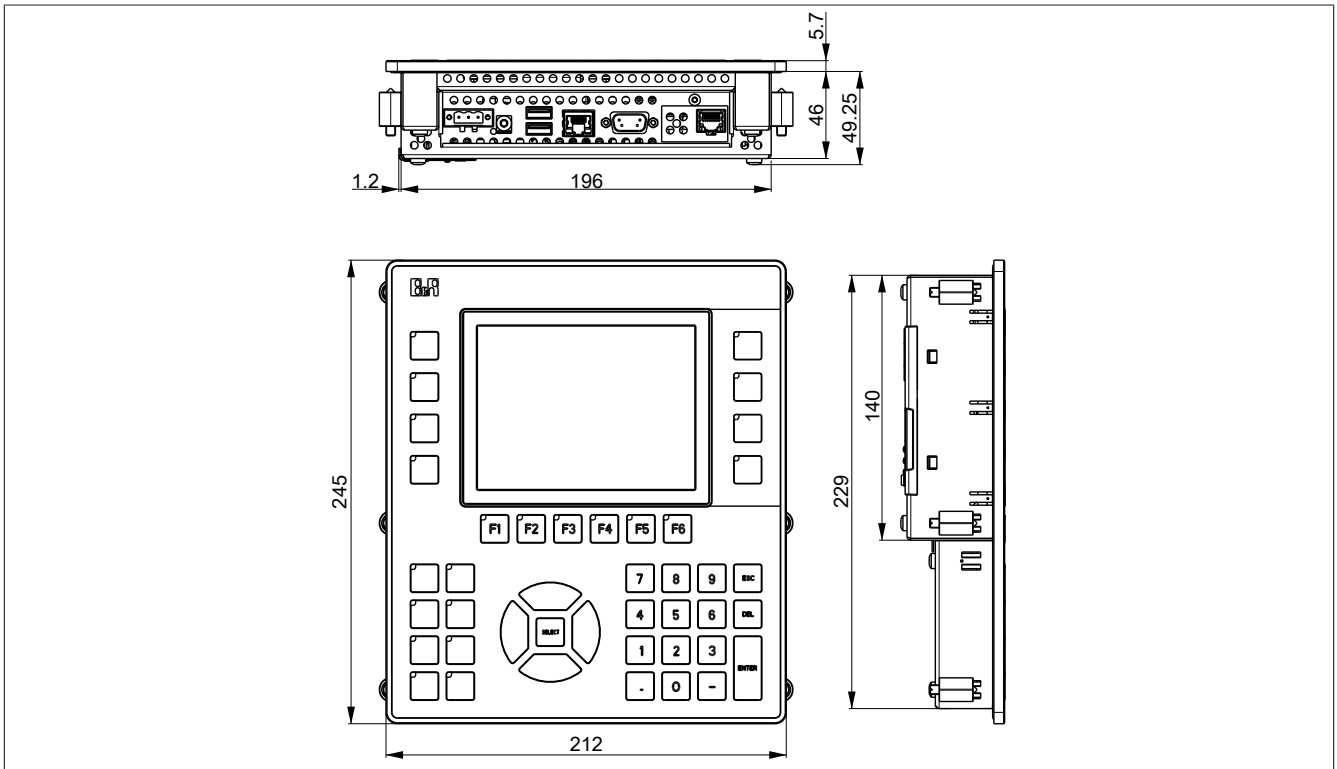

Figure 17: 5PP551.0573-00 - Dimensions

3.1.1.3.5 Cutout installation

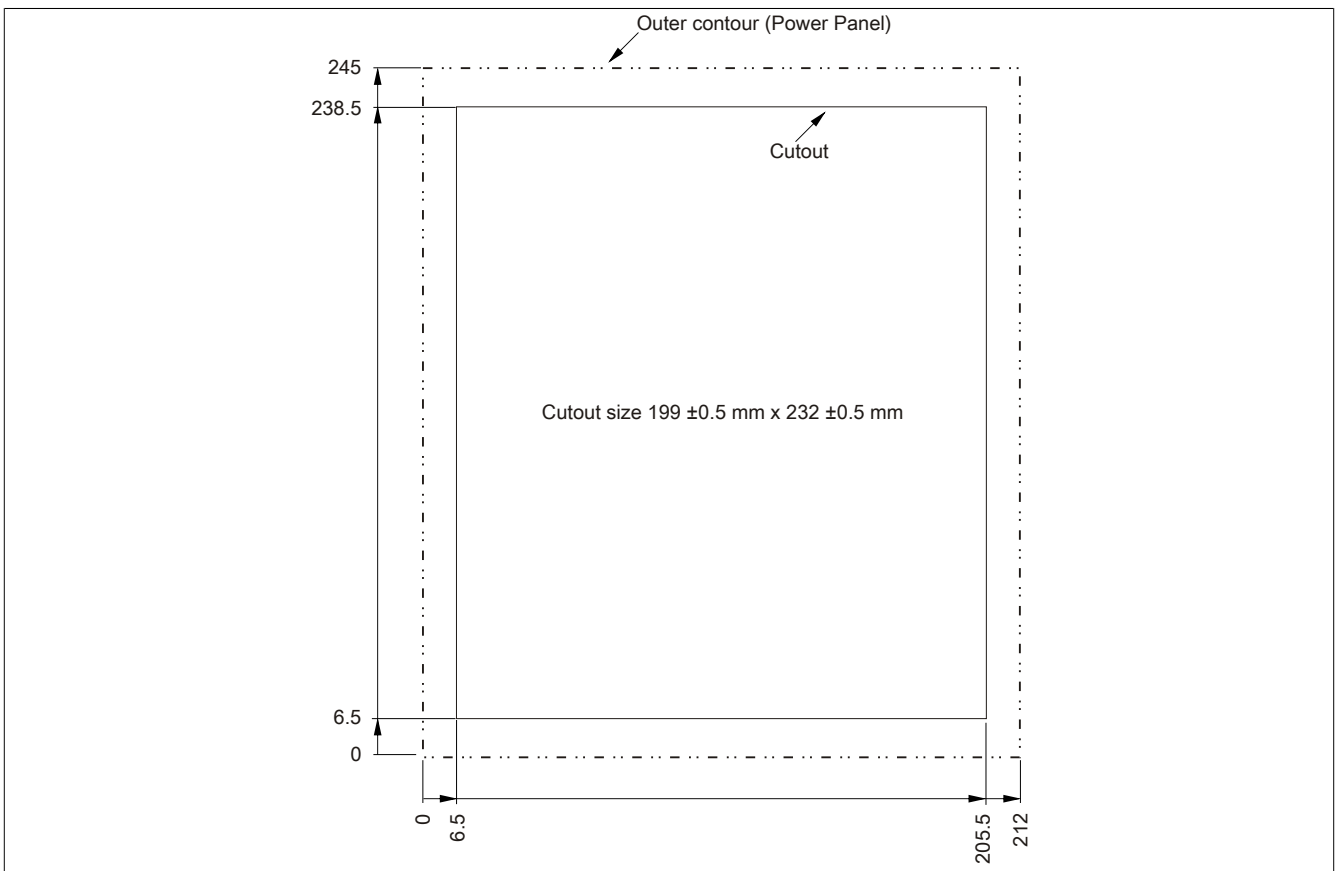

Figure 18: 5PP551.0573-00 - Cutout installation

3.1.1.3.6 Temperature humidity diagram

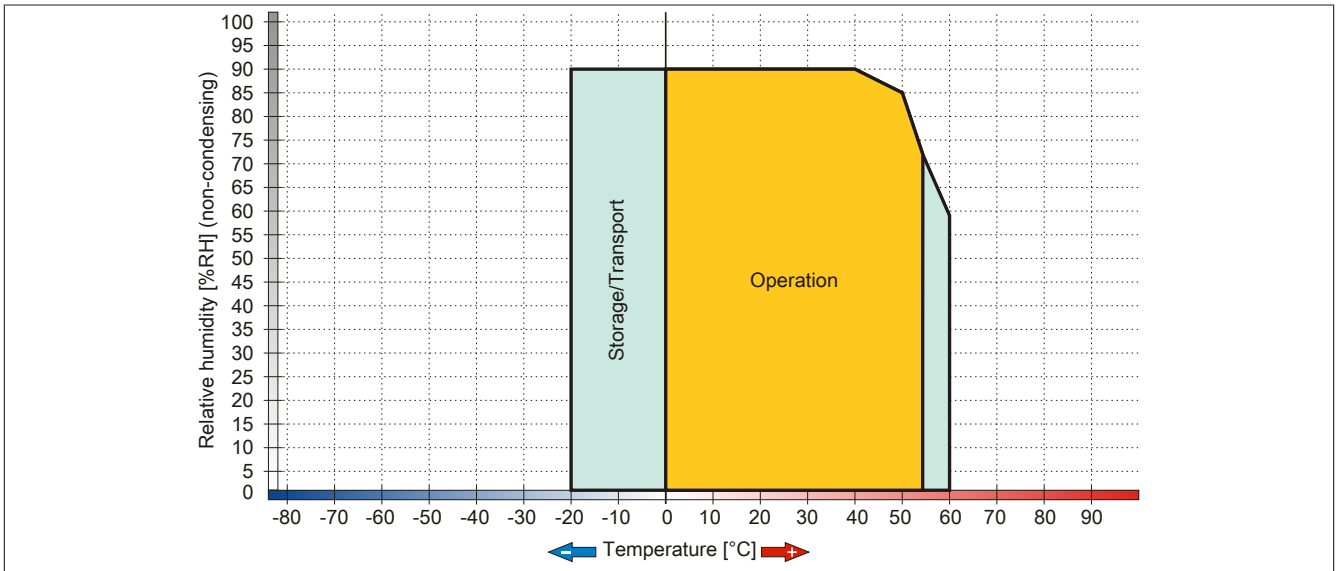

Figure 19: 5PP551.0573-00 - Temperature humidity diagram

3.1.1.4 5PP552.0573-00

3.1.1.4.1 General information

- 5.7" TFT VGA color display
- Function and system keys
- Intel® Atom™ technology
- Compact installation depth
- Fanless operation
- Can be upgraded with interface board

3.1.1.4.2 Order data

Model number	Short description	Figure
	System units	
5PP552.0573-00	Power Panel 552 5.7" VGA TFT display; 20 function keys and 20 system keys; connections for 1x RS232, 2x USB 2.0, 1x Ethernet 10/100/1000; can be expanded with interface board; IP65 protection (front); order male 24 VDC connector for voltage supply separately (screw clamp: 0TB103.9; cage clamp: 0TB103.91)	
	Required accessories	
	CPU boards	
5PP5CP.US15-00	CPU board Intel Atom Z510 1.1 GHz - Single core - US15W chipset	
5PP5CP.US15-01	CPU board Intel Atom Z520 1.33 GHz - Single core - US15W chipset	
5PP5CP.US15-02	CPU board Intel Atom Z530 1.6 GHz - Single core - US15W chipset	
	Main memory	
5MMDDR.0512-01	SO-DIMM DDR2 RAM 512 MB PC2-5300	
5MMDDR.1024-01	SO-DIMM DDR2 RAM 1024 MB PC2-5300	
5MMDDR.2048-01	SO-DIMM DDR2 RAM 2048 MB PC2-5300	
	Terminal blocks	
0TB103.9	Connector 24 VDC - 3-pin female - Screw clamps 3.31 mm ²	
0TB103.91	Connector 24 VDC - 3-pin female - Cage clamps 3.31 mm ²	
	Optional accessories	
	Batteries	
0AC201.91	Lithium batteries 4 pcs., 3 V / 950 mAh button cell We hereby state that the lithium cells contained in this shipment qualify as "partly regulated". Handle with care. If the package is damaged, inspect the cells, repack intact cells and protect cells against short circuits. For emergency information, call RENATA SA at + 41 61 319 28 27	
4A0006.00-000	Lithium battery, 3 V / 950 mAh, button cell	
	CompactFlash cards	
5CFCRD.016G-06	CompactFlash 16 GB B&R (SLC)	
5CFCRD.0512-06	CompactFlash 512 MB B&R (SLC)	
5CFCRD.1024-06	CompactFlash 1 GB B&R (SLC)	
5CFCRD.2048-06	CompactFlash 2 GB B&R (SLC)	
5CFCRD.4096-06	CompactFlash 4 GB B&R (SLC)	
5CFCRD.8192-06	CompactFlash 8 GB B&R (SLC)	
	Interface boards	
5PP5IF.CETH-00	Ethernet interface card - 1 Ethernet 10/100/1000	
5PP5IF.CHDA-00	Audio interface card - 1 HDA	
5PP5IF.FCAN-00	CAN interface card - 1 CAN master	
5PP5IF.FETH-00	Ethernet interface card - 1 Ethernet 10/100/1000 - 512 kB SRAM	
5PP5IF.FPLM-00	POWERLINK interface card - 2 POWERLINK managing nodes - 512 kB SRAM	
5PP5IF.FX2X-00	X2X Link interface card - 1 X2X Link master - 512 kB SRAM	
5PP5IF.FXCM-00	CAN interface card - 1 CAN master - 1 X2X master - 512 kB SRAM - Can be installed in PP500, APC510, APC511 systems	
	USB accessories	
5MMUSB.2048-01	USB 2.0 flash drive, 2048 MB, B&R	
5MMUSB.4096-01	USB 2.0 flash drive, 4096 MB, B&R	

Table 28: 5PP552.0573-00 - Order data

3.1.1.4.3 Technical data

Product ID	5PP552.0573-00
General information	
Cooling	Fanless
LED status indicators	Power, CF, Link, Run
B&R ID code	0xB605
Battery	
Type	Renata 950 mAh
Service life	4 years ¹⁾
Removable	Yes, accessible from the outside
Design	Lithium ion
Power button	Yes
Reset button	Yes
Buzzer	Yes
Certification	
CE	Yes
cULus	Yes
GOST-R	Yes
Controller	
Boot loader	BIOS
Mode/Node switches	2, 16 positions each (back)
Watchdog	MTCX
Power failure logic	
Controller	MTCX ²⁾
Buffer time	10 ms
Graphics	
Controller	Intel® Graphics Media Accelerator 500
Memory	
Type	DDR2 SDRAM
Memory size	Max. 2 GB
Interfaces	
COM1 ³⁾	
Type	RS232, modem-capable, not electrically isolated
Design	9-pin male DSUB connector
UART	16550-compatible, 16-byte FIFO
Max. baud rate	115 kbit/s
CompactFlash slot 1	
Type	Type I
SD memory card slot	
Type	SD card
USB	
Quantity	2
Type	USB 2.0
Design	Type A
Transfer rate	Low speed (1.5 Mbit/s), full speed (12 Mbit/s), high speed (480 Mbit/s)
Current load	Max. 1 A per connection
Ethernet	
Quantity	1
Controller	Intel 82574
Design	Shielded RJ45 port
Transfer rate	10/100/1000 Mbit/s
Display	
Type	Color TFT
Display size	5.7" (144 mm)
Colors	262,144
Resolution	VGA, 640 x 480 pixels
Contrast	850:1
Viewing angles	
Horizontal	Direction R = 80° / Direction L = 80°
Vertical	Direction U = 80° / Direction D = 80°
Backlight	
Type	LED
Brightness (dimnable)	Typ. 20 to 400 cd/m ²
Half-brightness time ⁴⁾	50,000 h
Touch screen ⁵⁾	
Type	-
Technology	-
Controller	-
Transmittance	-
Keys	
Function keys	20 with LED (yellow)
System keys	Numeric keys, cursor block
Service life	>1,000,000 actuations at 1 ±0.3N to 3 ±0.3 N actuating force

Table 29: 5PP552.0573-00 - Technical data

Product ID	5PP552.0573-00
LED brightness Yellow	Typ. 38 mcd
Inserts	
Interface board	Yes
I/O board	No
Electrical characteristics	
Nominal voltage	24 VDC ±25%
Nominal current	1.1 A ⁶⁾
Starting current	Typ. 3 A, max. 50 A for <300 µs
Power consumption	26 W ⁷⁾
Electrical isolation	Yes
Operating conditions	
EN 60529 protection	Back: IP20 (only with an inserted CF card, IF board or optional IF cover) Front: IP65, protection from dust and sprayed water
Environmental conditions	
Temperature	
Operation	0 to 55°C
Storage	-20 to 60°C
Transport	-20 to 60°C
Relative humidity	
Operation	See temperature/humidity diagram
Storage	See temperature/humidity diagram
Transport	See temperature/humidity diagram
Vibration	
Operation (continuous)	2 to 9 Hz: 1.75 mm amplitude / 9 to 200 Hz: 0.5 g
Operation (occasional)	2 to 9 Hz: 3.5 mm amplitude / 9 to 200 Hz: 1 g
Storage	2 to 8 Hz: 7.5 mm amplitude / 8 to 200 Hz: 2 g / 200 to 500 Hz: 4 g
Transport	2 to 8 Hz: 7.5 mm amplitude / 8 to 200 Hz: 2 g / 200 to 500 Hz: 4 g
Shock	
Operation	15 g, 11 ms
Storage	30 g, 6 ms
Transport	30 g, 6 ms
Elevation	
Operation	Max. 3000 m (component-dependent) ⁸⁾
Mechanical characteristics	
Housing	
Material	Galvanized steel plate
Front ⁹⁾	
Frame	Naturally anodized aluminum
Panel overlay	
Material	Polyester
Light background	RAL 9006
Dark gray border around display	RAL 7024
Gasket	Flat gasket around display front
Dimensions	
Width	302 mm
Height	187 mm
Depth	55 mm
Weight	1750 g

Table 29: 5PP552.0573-00 - Technical data

- 1) At 50°C, 8.5 µA of the supplied components and a self-discharge of 40%. If an interface board with SRAM has been installed, the service life is 2½ years.
- 2) Maintenance Controller Extended.
- 3) The COM1 interface is identified in BIOS as the COM A interface.
- 4) At an ambient temperature of 25°C. Reducing the brightness by 50% can result in an approximately 50% increase in the half-brightness time.
- 5) Touch screen drivers for approved operating systems are available in the Downloads section of the B&R website.
- 6) The specified value applies to a nominal voltage of 24 VDC.
- 7) The specified value applies to a system unit with a CPU board but without an interface board.
- 8) The maximum ambient temperature is typically derated by 1°C per 1000 meters (starting at 500 meters above sea level).
- 9) There may be visible deviations in the color and surface appearance depending on the process or batch.

3.1.1.4.4 Dimensions

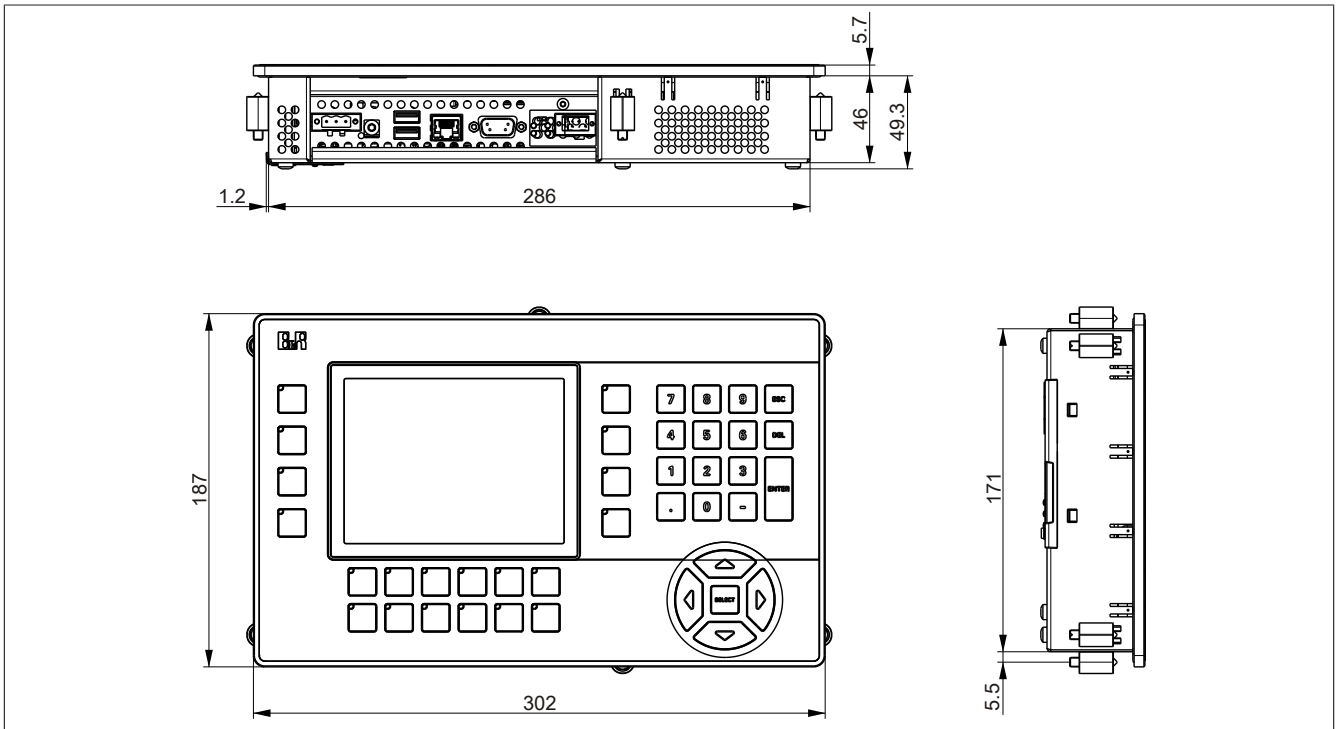

Figure 20: 5PP552.0573-00 - Dimensions

3.1.1.4.5 Cutout installation

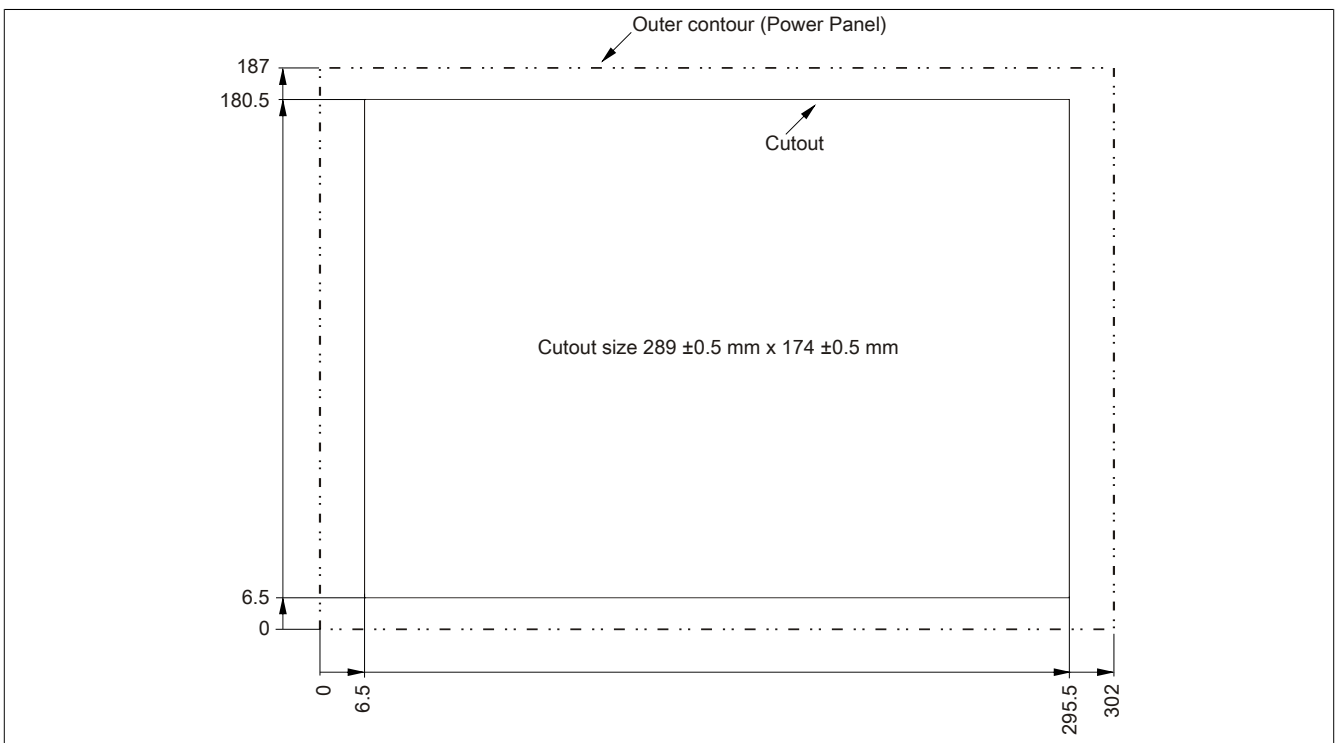

Figure 21: 5PP552.0573-00 - Cutout installation

3.1.1.4.6 Temperature humidity diagram

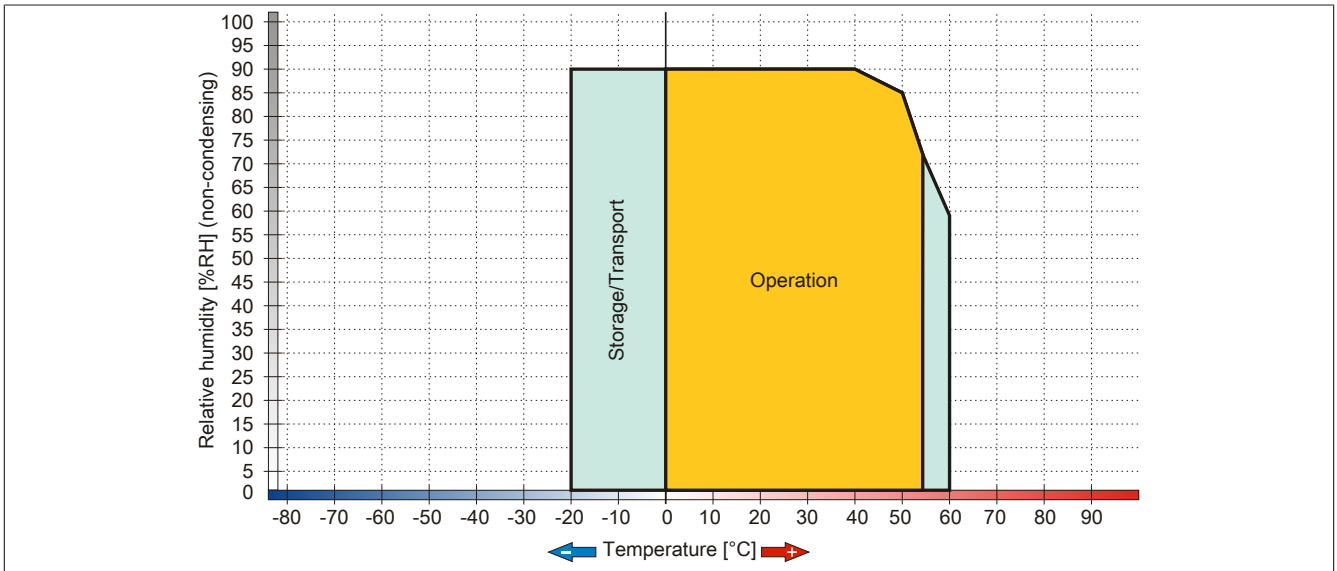

Figure 22: 5PP552.0573-00 - Temperature humidity diagram

3.1.2 7" system unit

3.1.2.1 5PP520.0702-00

3.1.2.1.1 General information

- 7" TFT WVGA color display
- Analog resistive touch screen
- Intel® Atom™ technology
- Compact installation depth
- Fanless operation
- Can be upgraded with interface board

3.1.2.1.2 Order data

Model number	Short description	Figure
System units		
5PP520.0702-00	Power Panel 520 7" WVGA TFT display with touch screen (resistive); connections for 1x RS232, 2x USB 2.0, 1x Ethernet 10/100/1000; can be expanded with interface board; IP65 protection (front); order male 24 VDC connector for voltage supply separately (screw clamp: 0TB103.9; cage clamp: 0TB103.91)	
Required accessories		
CPU boards		
5PP5CP.US15-00	CPU board Intel Atom Z510 1.1 GHz - Single core - US15W chipset	
5PP5CP.US15-01	CPU board Intel Atom Z520 1.33 GHz - Single core - US15W chipset	
5PP5CP.US15-02	CPU board Intel Atom Z530 1.6 GHz - Single core - US15W chipset	
Main memory		
5MMDDR.0512-01	SO-DIMM DDR2 RAM 512 MB PC2-5300	
5MMDDR.1024-01	SO-DIMM DDR2 RAM 1024 MB PC2-5300	
5MMDDR.2048-01	SO-DIMM DDR2 RAM 2048 MB PC2-5300	
Terminal blocks		
0TB103.9	Connector 24 VDC - 3-pin female - Screw clamps 3.31 mm ²	
0TB103.91	Connector 24 VDC - 3-pin female - Cage clamps 3.31 mm ²	
Optional accessories		
Batteries		
0AC201.91	Lithium batteries 4 pcs., 3 V / 950 mAh button cell We hereby state that the lithium cells contained in this shipment qualify as "partly regulated". Handle with care. If the package is damaged, inspect the cells, repack intact cells and protect cells against short circuits. For emergency information, call RENATA SA at + 41 61 319 28 27	
4A0006.00-000	Lithium battery, 3 V / 950 mAh, button cell	
CompactFlash cards		
5CFCRD.016G-06	CompactFlash 16 GB B&R (SLC)	
5CFCRD.0512-06	CompactFlash 512 MB B&R (SLC)	
5CFCRD.1024-06	CompactFlash 1 GB B&R (SLC)	
5CFCRD.2048-06	CompactFlash 2 GB B&R (SLC)	
5CFCRD.4096-06	CompactFlash 4 GB B&R (SLC)	
5CFCRD.8192-06	CompactFlash 8 GB B&R (SLC)	
Interface boards		
5PP5IF.CETH-00	Ethernet interface card - 1 Ethernet 10/100/1000	
5PP5IF.CHDA-00	Audio interface card - 1 HDA	
5PP5IF.FCAN-00	CAN interface card - 1 CAN master	
5PP5IF.FETH-00	Ethernet interface card - 1 Ethernet 10/100/1000 - 512 kB SRAM	
5PP5IF.FPLM-00	POWERLINK interface card - 2 POWERLINK managing nodes - 512 kB SRAM	
5PP5IF.FX2X-00	X2X Link interface card - 1 X2X Link master - 512 kB SRAM	
5PP5IF.FXCM-00	CAN interface card - 1 CAN master - 1 X2X master - 512 kB SRAM - Can be installed in PP500, APC510, APC511 systems	
USB accessories		
5MMUSB.2048-01	USB 2.0 flash drive, 2048 MB, B&R	
5MMUSB.4096-01	USB 2.0 flash drive, 4096 MB, B&R	

Table 30: 5PP520.0702-00 - Order data

3.1.2.1.3 Technical data

Product ID	5PP520.0702-00
General information	
Cooling	Fanless
LED status indicators	Power, CF, Link, Run
B&R ID code	0xB4CD
Battery	
Type	Renata 950 mAh
Service life	4 years ¹⁾
Removable	Yes, accessible from the outside
Design	Lithium ion
Power button	Yes
Reset button	Yes
Buzzer	Yes
Certification	
CE	Yes
cULus	Yes
GOST-R	Yes
GL	Yes ²⁾
Controller	
Boot loader	BIOS
Mode/Node switches	2, 16 positions each (back)
Watchdog	MTCX
Power failure logic	
Controller	MTCX ³⁾
Buffer time	10 ms
Graphics	
Controller	Intel® Graphics Media Accelerator 500
Memory	
Type	DDR2 SDRAM
Memory size	Max. 2 GB
Interfaces	
COM1 ⁴⁾	
Type	RS232, modem-capable, not electrically isolated
Design	9-pin male DSUB connector
UART	16550-compatible, 16-byte FIFO
Max. baud rate	115 kbit/s
CompactFlash slot 1	
Type	Type I
SD memory card slot	
Type	SD card
USB	
Quantity	2
Type	USB 2.0
Design	Type A
Transfer rate	Low speed (1.5 Mbit/s), full speed (12 Mbit/s), high speed (480 Mbit/s)
Current load	Max. 1 A per connection
Ethernet	
Quantity	1
Controller	Intel 82574
Design	Shielded RJ45 port
Transfer rate	10/100/1000 Mbit/s
Display	
Type	Color TFT
Display size	7" (177.8 mm)
Colors	16 million
Resolution	WVGA, 800 x 480 pixels
Contrast	600:1
Viewing angles	
Horizontal	Direction R = 70° / Direction L = 70°
Vertical	Direction U = 60° / Direction D = 60°
Backlight	
Type	LED
Brightness (dimnable)	Typ. 80 to 500 cd/m ²
Half-brightness time ⁵⁾	50,000 h
Touch screen ⁶⁾	
Type	AMT
Technology	Analog, resistive
Controller	B&R, serial, 12-bit
Transmittance	81% ±3%
Keys	
Function keys	No
System keys	No
Service life	-

Table 31: 5PP520.0702-00 - Technical data

Product ID	5PP520.0702-00
LED brightness	-
Inserts	
Interface board	Yes
I/O board	No
Electrical characteristics	
Nominal voltage	24 VDC ±25%
Nominal current	1 A ⁷⁾
Starting current	Typ. 3 A, max. 50 A for <300 µs
Power consumption	24 W ⁸⁾
Electrical isolation	Yes
Operating conditions	
EN 60529 protection	Back: IP20 (only with an inserted CF card, IF board or optional IF cover) Front: IP65, protection from dust and sprayed water
Environmental conditions	
Temperature	
Operation	0 to 55°C
Storage	-20 to 60°C
Transport	-20 to 60°C
Relative humidity	
Operation	See temperature/humidity diagram
Storage	See temperature/humidity diagram
Transport	See temperature/humidity diagram
Vibration	
Operation (continuous)	2 to 9 Hz: 1.75 mm amplitude / 9 to 200 Hz: 0.5 g
Operation (occasional)	2 to 9 Hz: 3.5 mm amplitude / 9 to 200 Hz: 1 g
Storage	2 to 8 Hz: 7.5 mm amplitude / 8 to 200 Hz: 2 g / 200 to 500 Hz: 4 g
Transport	2 to 8 Hz: 7.5 mm amplitude / 8 to 200 Hz: 2 g / 200 to 500 Hz: 4 g
Shock	
Operation	15 g, 11 ms
Storage	30 g, 6 ms
Transport	30 g, 6 ms
Elevation	
Operation	Max. 3000 m (component-dependent) ⁹⁾
Mechanical characteristics	
Housing	
Material	Galvanized steel plate
Front ¹⁰⁾	
Frame	Naturally anodized aluminum
Panel overlay	
Material	Polyester
Light background	RAL 9006
Dark gray border around display	RAL 7024
Gasket	Flat gasket around display front
Dimensions	
Width	212 mm
Height	156 mm
Depth	55 mm
Weight	1200 g

Table 31: 5PP520.0702-00 - Technical data

- 1) At 50°C, 8.5 µA of the supplied components and a self-discharge of 40%. If an interface board with SRAM has been installed, the service life is 2½ years.
- 2) Yes, although applies only if all components installed within the complete system have this certification.
- 3) Maintenance Controller Extended.
- 4) The COM1 interface is identified in BIOS as the COM A interface.
- 5) At an ambient temperature of 25°C. Reducing the brightness by 50% can result in an approximately 50% increase in the half-brightness time.
- 6) Touch screen drivers for approved operating systems are available in the Downloads section of the B&R website.
- 7) The specified value applies to a nominal voltage of 24 VDC.
- 8) The specified value applies to a system unit with a CPU board but without an interface board.
- 9) The maximum ambient temperature is typically derated by 1°C per 1000 meters (starting at 500 meters above sea level).
- 10) There may be visible deviations in the color and surface appearance depending on the process or batch.

3.1.2.1.4 Dimensions

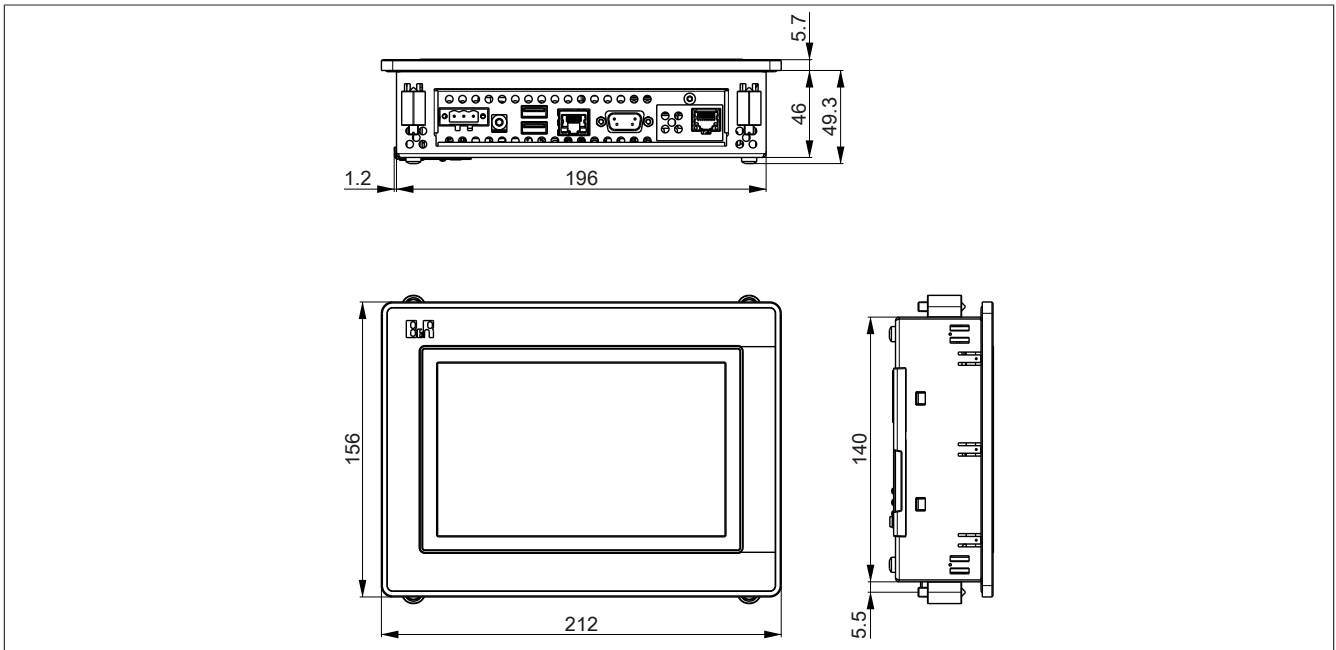

Figure 23: 5PP520.0702-00 - Dimensions

3.1.2.1.5 Cutout installation

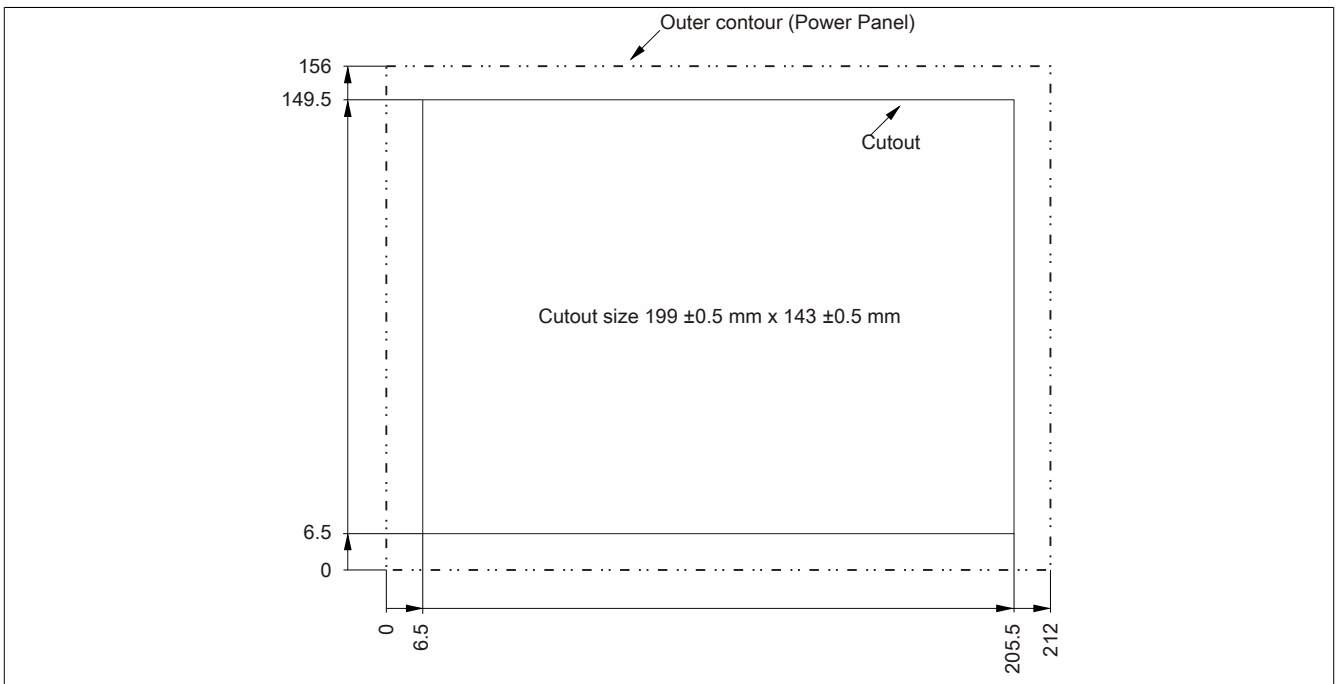

Figure 24: 5PP520.0702-00 - Cutout installation

3.1.2.1.6 Temperature humidity diagram

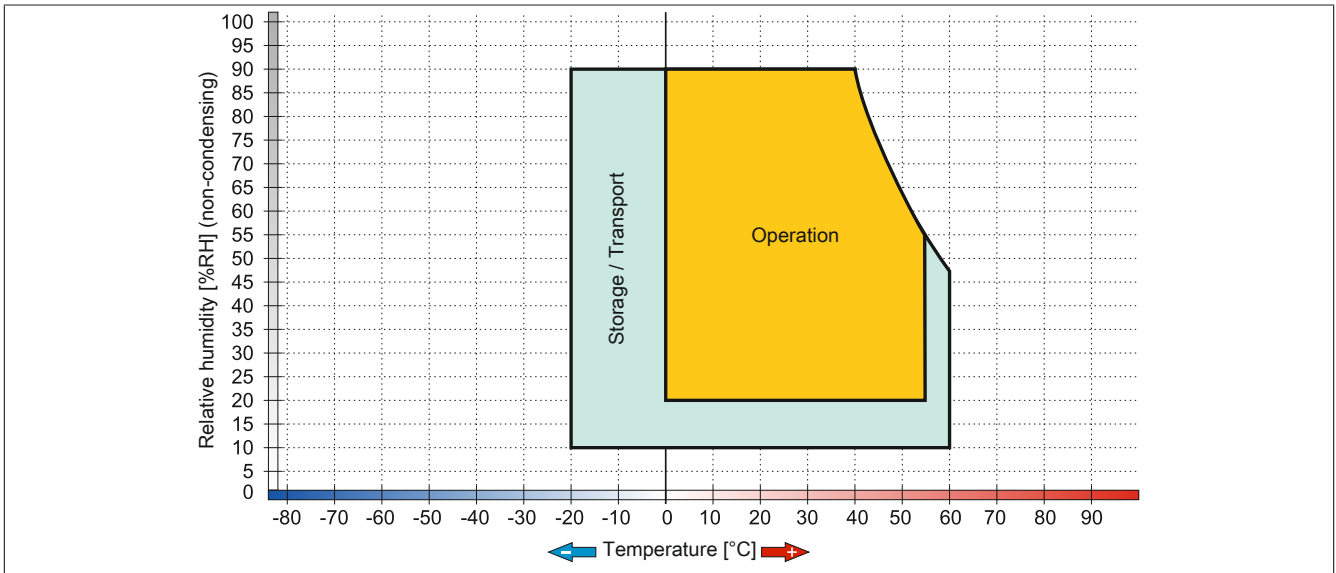

Figure 25: 5PP520.0702-00 - Temperature humidity diagram

3.1.3 10.4" system units

3.1.3.1 5PP520.1043-00

3.1.3.1.1 General information

- 10.4" TFT VGA color display
- Analog resistive touch screen
- Intel® Atom™ technology
- Compact installation depth
- Fanless operation
- Can be upgraded with interface board

3.1.3.1.2 Order data

Model number	Short description	Figure
	System units	
5PP520.1043-00	Power Panel 520 10.4" VGA TFT display with touch screen (resistive); connections for 1x RS232, 3x USB 2.0, 1x Ethernet 10/100/1000; can be expanded with interface board; IP65 protection (front); order male 24 VDC connector for voltage supply separately (screw clamp: 0TB103.9; cage clamp: 0TB103.91)	
	Required accessories	
	CPU boards	
5PP5CP.US15-00	CPU board Intel Atom Z510 1.1 GHz - Single core - US15W chipset	
5PP5CP.US15-01	CPU board Intel Atom Z520 1.33 GHz - Single core - US15W chipset	
5PP5CP.US15-02	CPU board Intel Atom Z530 1.6 GHz - Single core - US15W chipset	
	Main memory	
5MMDDR.0512-01	SO-DIMM DDR2 RAM 512 MB PC2-5300	
5MMDDR.1024-01	SO-DIMM DDR2 RAM 1024 MB PC2-5300	
5MMDDR.2048-01	SO-DIMM DDR2 RAM 2048 MB PC2-5300	
	Terminal blocks	
0TB103.9	Connector 24 VDC - 3-pin female - Screw clamps 3.31 mm ²	
0TB103.91	Connector 24 VDC - 3-pin female - Cage clamps 3.31 mm ²	
	Optional accessories	
	Batteries	
0AC201.91	Lithium batteries 4 pcs., 3 V / 950 mAh button cell We hereby state that the lithium cells contained in this shipment qualify as "partly regulated". Handle with care. If the package is damaged, inspect the cells, repack intact cells and protect cells against short circuits. For emergency information, call RENATA SA at + 41 61 319 28 27	
4A0006.00-000	Lithium battery, 3 V / 950 mAh, button cell	
	CompactFlash cards	
5CFCRD.016G-06	CompactFlash 16 GB B&R (SLC)	
5CFCRD.0512-06	CompactFlash 512 MB B&R (SLC)	
5CFCRD.1024-06	CompactFlash 1 GB B&R (SLC)	
5CFCRD.2048-06	CompactFlash 2 GB B&R (SLC)	
5CFCRD.4096-06	CompactFlash 4 GB B&R (SLC)	
5CFCRD.8192-06	CompactFlash 8 GB B&R (SLC)	
	Interface boards	
5PP5IF.CETH-00	Ethernet interface card - 1 Ethernet 10/100/1000	
5PP5IF.CHDA-00	Audio interface card - 1 HDA	
5PP5IF.FCAN-00	CAN interface card - 1 CAN master	
5PP5IF.FETH-00	Ethernet interface card - 1 Ethernet 10/100/1000 - 512 kB SRAM	
5PP5IF.FPLM-00	POWERLINK interface card - 2 POWERLINK managing nodes - 512 kB SRAM	
5PP5IF.FX2X-00	X2X Link interface card - 1 X2X Link master - 512 kB SRAM	
5PP5IF.FXCM-00	CAN interface card - 1 CAN master - 1 X2X master - 512 kB SRAM - Can be installed in PP500, APC510, APC511 systems	
	USB accessories	
5MMUSB.2048-01	USB 2.0 flash drive, 2048 MB, B&R	
5MMUSB.4096-01	USB 2.0 flash drive, 4096 MB, B&R	

Table 32: 5PP520.1043-00 - Order data

3.1.3.1.3 Technical data

Product ID	5PP520.1043-00
General information	
Cooling	Fanless
LED status indicators	Power, CF, Link, Run
B&R ID code	0xB4CE
Battery	
Type	Renata 950 mAh
Service life	4 years ¹⁾
Removable	Yes, accessible from the outside
Design	Lithium ion
Power button	Yes
Reset button	Yes
Buzzer	Yes
Certification	
CE	Yes
cULus	Yes
GOST-R	Yes
Controller	
Boot loader	BIOS
Mode/Node switches	2, 16 positions each (back)
Watchdog	MTCX
Power failure logic	
Controller	MTCX ²⁾
Buffer time	10 ms
Graphics	
Controller	Intel® Graphics Media Accelerator 500
Memory	
Type	DDR2 SDRAM
Memory size	Max. 2 GB
Interfaces	
COM1 ³⁾	
Type	RS232, modem-capable, not electrically isolated
Design	9-pin male DSUB connector
UART	16550-compatible, 16-byte FIFO
Max. baud rate	115 kbit/s
CompactFlash slot 1	
Type	Type I
SD memory card slot	
Type	SD card
USB	
Quantity	3
Type	USB 2.0
Design	Type A
Transfer rate	Low speed (1.5 Mbit/s), full speed (12 Mbit/s), high speed (480 Mbit/s)
Current load	Max. 1 A per connection
Ethernet	
Quantity	1
Controller	Intel 82574
Design	Shielded RJ45 port
Transfer rate	10/100/1000 Mbit/s
Display	
Type	Color TFT
Display size	10.4" (264 mm)
Colors	16 million
Resolution	VGA, 640 x 480 pixels
Contrast	700:1
Viewing angles	
Horizontal	Direction R = 80° / Direction L = 80°
Vertical	Direction U = 80° / Direction D = 60°
Backlight	
Type	LED
Brightness (dimnable)	Typ. 22.5 to 450 cd/m ²
Half-brightness time ⁴⁾	50,000 h
Touch screen ⁵⁾	
Type	AMT
Technology	Analog, resistive
Controller	B&R, serial, 12-bit
Transmittance	81% ±3%
Keys	
Function keys	No
System keys	No
Service life	-
LED brightness	-

Table 33: 5PP520.1043-00 - Technical data

Product ID	5PP520.1043-00
Inserts	
Interface board	Yes
I/O board	No
Electrical characteristics	
Nominal voltage	24 VDC ±25%
Nominal current	1.2 A ⁶⁾
Starting current	Typ. 3 A, max. 50 A for <300 µs
Power consumption	25.5 W ⁷⁾
Electrical isolation	Yes
Operating conditions	
EN 60529 protection	Back: IP20 (only with an inserted CF card, IF board or optional IF cover) Front: IP65, protection from dust and sprayed water
Environmental conditions	
Temperature	
Operation	0 to 55°C
Storage	-20 to 60°C
Transport	-20 to 60°C
Relative humidity	
Operation	See temperature/humidity diagram
Storage	See temperature/humidity diagram
Transport	See temperature/humidity diagram
Vibration	
Operation (continuous)	2 to 9 Hz: 1.75 mm amplitude / 9 to 200 Hz: 0.5 g
Operation (occasional)	2 to 9 Hz: 3.5 mm amplitude / 9 to 200 Hz: 1 g
Storage	2 to 8 Hz: 7.5 mm amplitude / 8 to 200 Hz: 2 g / 200 to 500 Hz: 4 g
Transport	2 to 8 Hz: 7.5 mm amplitude / 8 to 200 Hz: 2 g / 200 to 500 Hz: 4 g
Shock	
Operation	15 g, 11 ms
Storage	30 g, 6 ms
Transport	30 g, 6 ms
Elevation	
Operation	Max. 3000 m (component-dependent) ⁸⁾
Mechanical characteristics	
Housing	
Material	Galvanized steel plate
Front ⁹⁾	
Frame	Naturally anodized aluminum
Panel overlay	
Material	Polyester
Light background	RAL 9006
Dark gray border around display	RAL 7024
Gasket	Flat gasket around display front
Dimensions	
Width	323 mm
Height	260 mm
Depth	59.7 mm
Weight	2750 g

Table 33: 5PP520.1043-00 - Technical data

- 1) At 50°C, 8.5 µA of the supplied components and a self-discharge of 40%. If an interface board with SRAM has been installed, the service life is 2½ years.
- 2) Maintenance Controller Extended.
- 3) The COM1 interface is identified in BIOS as the COM A interface.
- 4) At an ambient temperature of 25°C. Reducing the brightness by 50% can result in an approximately 50% increase in the half-brightness time.
- 5) Touch screen drivers for approved operating systems are available in the Downloads section of the B&R website.
- 6) The specified value applies to a nominal voltage of 24 VDC.
- 7) The specified value applies to a system unit with a CPU board but without an interface board.
- 8) The maximum ambient temperature is typically derated by 1°C per 1000 meters (starting at 500 meters above sea level).
- 9) There may be visible deviations in the color and surface appearance depending on the process or batch.

3.1.3.1.4 Dimensions

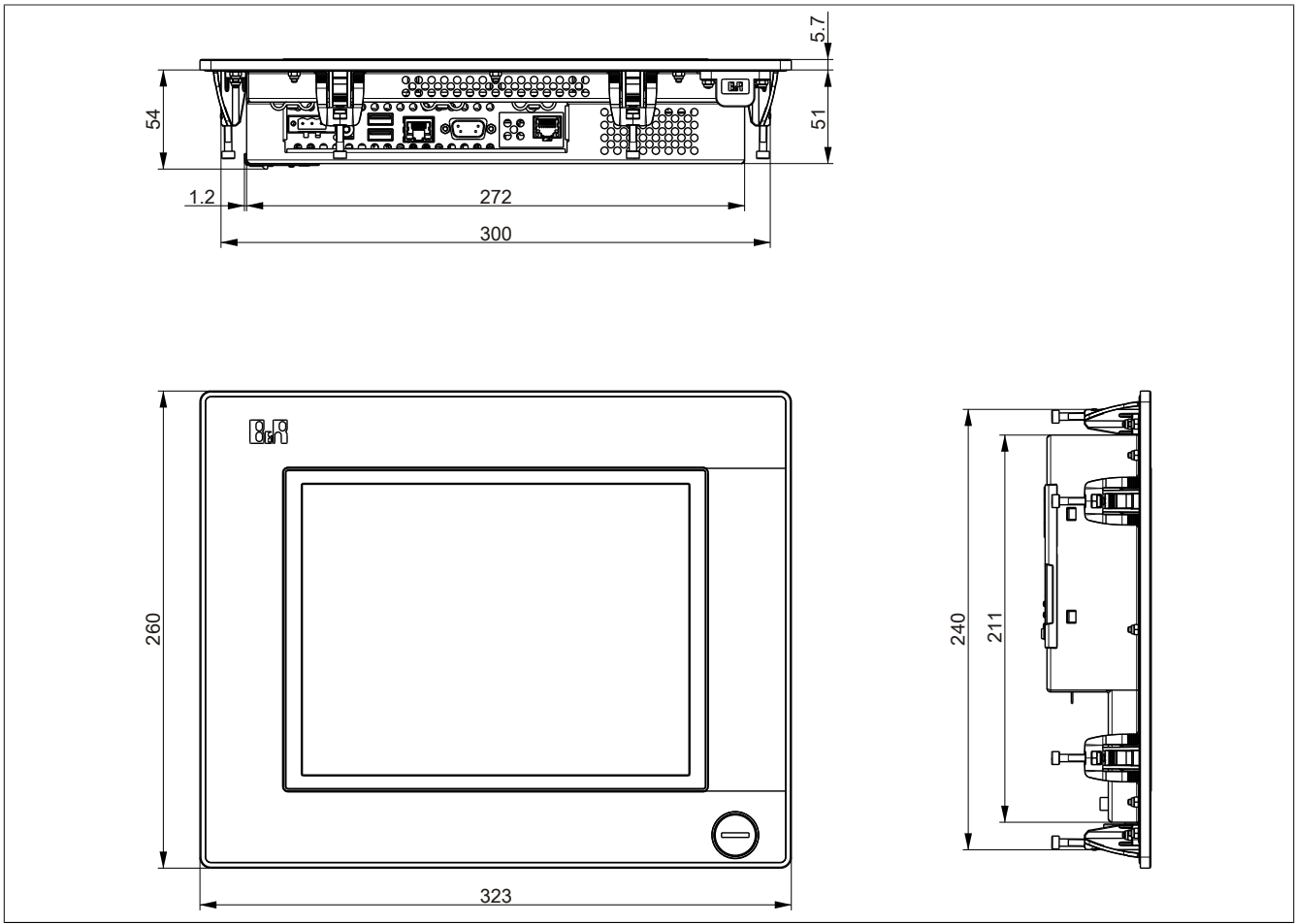

Figure 26: 5PP520.1043-00 - Dimensions

3.1.3.1.5 Cutout installation

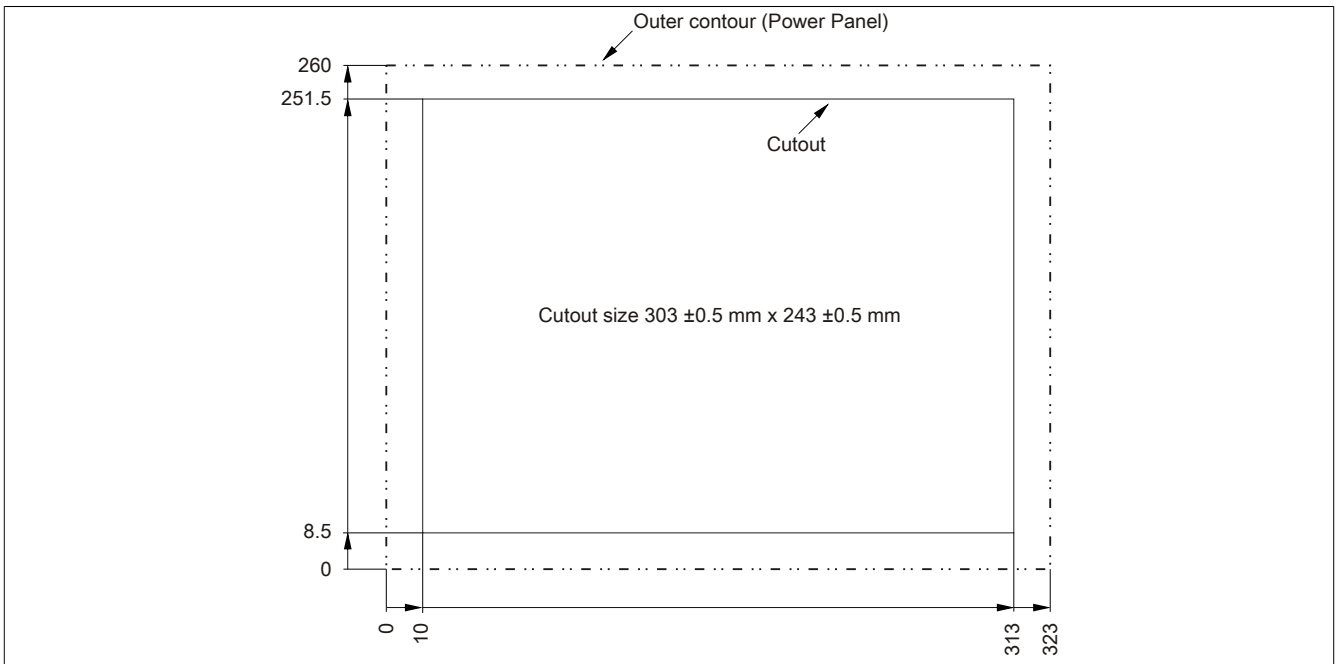

Figure 27: 5PP520.1043-00 - Cutout installation

3.1.3.1.6 Temperature humidity diagram

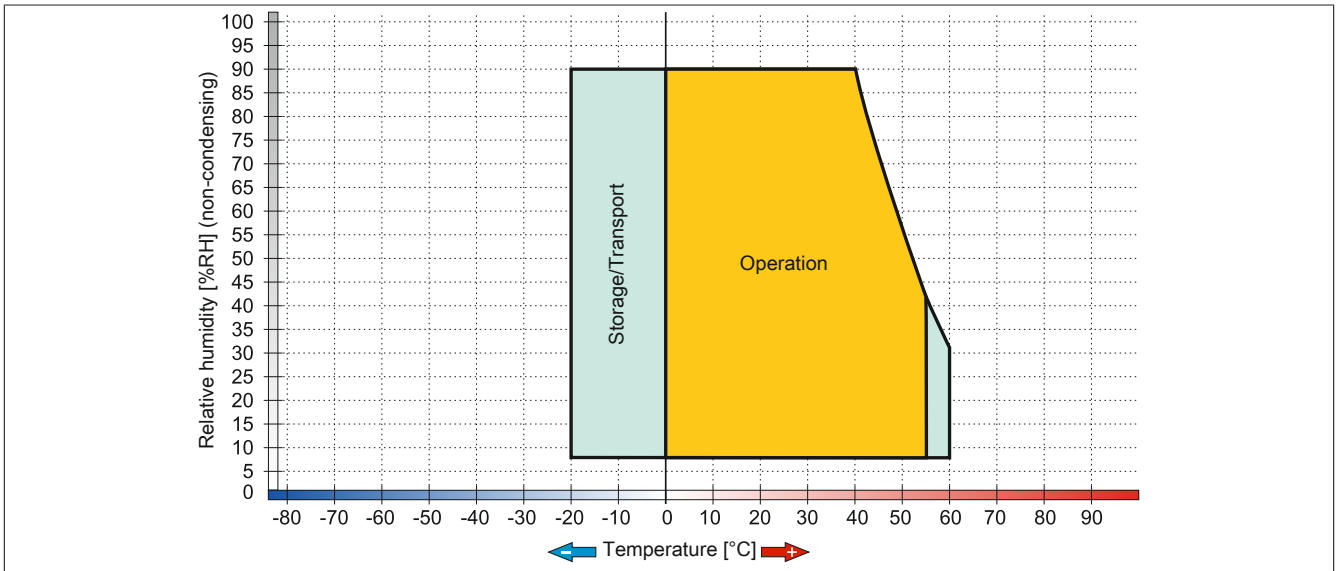

Figure 28: 5PP520.1043-00 - Temperature humidity diagram

3.1.3.2 5PP580.1043-00

3.1.3.2.1 General information

- 10.4" TFT VGA color display
- Analog resistive touch screen and function keys
- Intel® Atom™ technology
- Compact installation depth
- Fanless operation
- Can be upgraded with interface board

3.1.3.2.2 Order data

Model number	Short description	Figure
System units		
5PP580.1043-00	Power Panel 580 10.4" VGA TFT display with touch screen (resistive); 22 function keys; connections for 1x RS232, 3x USB 2.0, 1x Ethernet 10/100/1000; can be expanded with interface board; IP65 protection (front); order male 24 VDC connector for voltage supply separately (screw clamp: 0TB103.9; cage clamp: 0TB103.91)	
Required accessories		
CPU boards		
5PP5CP.US15-00	CPU board Intel Atom Z510 1.1 GHz - Single core - US15W chipset	
5PP5CP.US15-01	CPU board Intel Atom Z520 1.33 GHz - Single core - US15W chipset	
5PP5CP.US15-02	CPU board Intel Atom Z530 1.6 GHz - Single core - US15W chipset	
Main memory		
5MMDDR.0512-01	SO-DIMM DDR2 RAM 512 MB PC2-5300	
5MMDDR.1024-01	SO-DIMM DDR2 RAM 1024 MB PC2-5300	
5MMDDR.2048-01	SO-DIMM DDR2 RAM 2048 MB PC2-5300	
Terminal blocks		
0TB103.9	Connector 24 VDC - 3-pin female - Screw clamps 3.31 mm ²	
0TB103.91	Connector 24 VDC - 3-pin female - Cage clamps 3.31 mm ²	
Optional accessories		
Batteries		
0AC201.91	Lithium batteries 4 pcs., 3 V / 950 mAh button cell We hereby state that the lithium cells contained in this shipment qualify as "partly regulated". Handle with care. If the package is damaged, inspect the cells, repack intact cells and protect cells against short circuits. For emergency information, call RENATA SA at + 41 61 319 28 27	
4A0006.00-000	Lithium battery, 3 V / 950 mAh, button cell	
CompactFlash cards		
5CFCRD.016G-06	CompactFlash 16 GB B&R (SLC)	
5CFCRD.0512-06	CompactFlash 512 MB B&R (SLC)	
5CFCRD.1024-06	CompactFlash 1 GB B&R (SLC)	
5CFCRD.2048-06	CompactFlash 2 GB B&R (SLC)	
5CFCRD.4096-06	CompactFlash 4 GB B&R (SLC)	
5CFCRD.8192-06	CompactFlash 8 GB B&R (SLC)	
Interface boards		
5PP5IF.CETH-00	Ethernet interface card - 1 Ethernet 10/100/1000	
5PP5IF.CHDA-00	Audio interface card - 1 HDA	
5PP5IF.FCAN-00	CAN interface card - 1 CAN master	
5PP5IF.FETH-00	Ethernet interface card - 1 Ethernet 10/100/1000 - 512 kB SRAM	
5PP5IF.FPLM-00	POWERLINK interface card - 2 POWERLINK managing nodes - 512 kB SRAM	
5PP5IF.FX2X-00	X2X Link interface card - 1 X2X Link master - 512 kB SRAM	
5PP5IF.FXCM-00	CAN interface card - 1 CAN master - 1 X2X master - 512 kB SRAM - Can be installed in PP500, APC510, APC511 systems	
USB accessories		
5MMUSB.2048-01	USB 2.0 flash drive, 2048 MB, B&R	
5MMUSB.4096-01	USB 2.0 flash drive, 4096 MB, B&R	

Table 34: 5PP580.1043-00 - Order data

3.1.3.2.3 Technical data

Product ID	5PP580.1043-00
General information	
Cooling	Fanless
LED status indicators	Power, CF, Link, Run
B&R ID code	0xB606
Battery	
Type	Renata 950 mAh
Service life	4 years ¹⁾
Removable	Yes, accessible from the outside
Design	Lithium ion
Power button	Yes
Reset button	Yes
Buzzer	Yes
Certification	
CE	Yes
cULus	Yes
GOST-R	Yes
Controller	
Boot loader	BIOS
Mode/Node switches	2, 16 positions each (back)
Watchdog	MTCX
Power failure logic	
Controller	MTCX ²⁾
Buffer time	10 ms
Graphics	
Controller	Intel® Graphics Media Accelerator 500
Memory	
Type	DDR2 SDRAM
Memory size	Max. 2 GB
Interfaces	
COM1 ³⁾	
Type	RS232, modem-capable, not electrically isolated
Design	9-pin male DSUB connector
UART	16550-compatible, 16-byte FIFO
Max. baud rate	115 kbit/s
CompactFlash slot 1	
Type	Type I
SD memory card slot	
Type	SD card
USB	
Quantity	3
Type	USB 2.0
Design	Type A
Transfer rate	Low speed (1.5 Mbit/s), full speed (12 Mbit/s), high speed (480 Mbit/s)
Current load	Max. 1 A per connection
Ethernet	
Quantity	1
Controller	Intel 82574
Design	Shielded RJ45 port
Transfer rate	10/100/1000 Mbit/s
Display	
Type	Color TFT
Display size	10.4" (264 mm)
Colors	16 million
Resolution	VGA, 640 x 480 pixels
Contrast	700:1
Viewing angles	
Horizontal	Direction R = 80° / Direction L = 80°
Vertical	Direction U = 80° / Direction D = 60°
Backlight	
Type	LED
Brightness (dimnable)	Typ. 22.5 to 450 cd/m ²
Half-brightness time ⁴⁾	50,000 h
Touch screen ⁵⁾	
Type	AMT
Technology	Analog, resistive
Controller	B&R, serial, 12-bit
Transmittance	81% ±3%
Keys	
Function keys	22 with LED (yellow)
System keys	No
Service life	>1,000,000 actuations at 1 ±0.3N to 3 ±0.3 N actuating force

Table 35: 5PP580.1043-00 - Technical data

Product ID	5PP580.1043-00
LED brightness Yellow	Typ. 38 mcd
Inserts	
Interface board	Yes
I/O board	No
Electrical characteristics	
Nominal voltage	24 VDC ±25%
Nominal current	1.2 A ⁶⁾
Starting current	Typ. 3 A, max. 50 A for <300 µs
Power consumption	28.5 W ⁷⁾
Electrical isolation	Yes
Operating conditions	
EN 60529 protection	Back: IP20 (only with an inserted CF card, IF board or optional IF cover) Front: IP65, protection from dust and sprayed water
Environmental conditions	
Temperature	
Operation	0 to 55°C
Storage	-20 to 60°C
Transport	-20 to 60°C
Relative humidity	
Operation	See temperature/humidity diagram
Storage	See temperature/humidity diagram
Transport	See temperature/humidity diagram
Vibration	
Operation (continuous)	2 to 9 Hz: 1.75 mm amplitude / 9 to 200 Hz: 0.5 g
Operation (occasional)	2 to 9 Hz: 3.5 mm amplitude / 9 to 200 Hz: 1 g
Storage	2 to 8 Hz: 7.5 mm amplitude / 8 to 200 Hz: 2 g / 200 to 500 Hz: 4 g
Transport	2 to 8 Hz: 7.5 mm amplitude / 8 to 200 Hz: 2 g / 200 to 500 Hz: 4 g
Shock	
Operation	15 g, 11 ms
Storage	30 g, 6 ms
Transport	30 g, 6 ms
Elevation	
Operation	Max. 3000 m (component-dependent) ⁸⁾
Mechanical characteristics	
Housing	
Material	Galvanized steel plate
Front ⁹⁾	
Frame	Naturally anodized aluminum
Panel overlay	
Material	Polyester
Light background	RAL 9006
Dark gray border around display	RAL 7024
Gasket	Flat gasket around display front
Dimensions	
Width	323 mm
Height	260 mm
Depth	59.7 mm
Weight	2650 g

Table 35: 5PP580.1043-00 - Technical data

- 1) At 50°C, 8.5 µA of the supplied components and a self-discharge of 40%. If an interface board with SRAM has been installed, the service life is 2½ years.
- 2) Maintenance Controller Extended.
- 3) The COM1 interface is identified in BIOS as the COM A interface.
- 4) At an ambient temperature of 25°C. Reducing the brightness by 50% can result in an approximately 50% increase in the half-brightness time.
- 5) Touch screen drivers for approved operating systems are available in the Downloads section of the B&R website.
- 6) The specified value applies to a nominal voltage of 24 VDC.
- 7) The specified value applies to a system unit with a CPU board but without an interface board.
- 8) The maximum ambient temperature is typically derated by 1°C per 1000 meters (starting at 500 meters above sea level).
- 9) There may be visible deviations in the color and surface appearance depending on the process or batch.

3.1.3.2.4 Dimensions

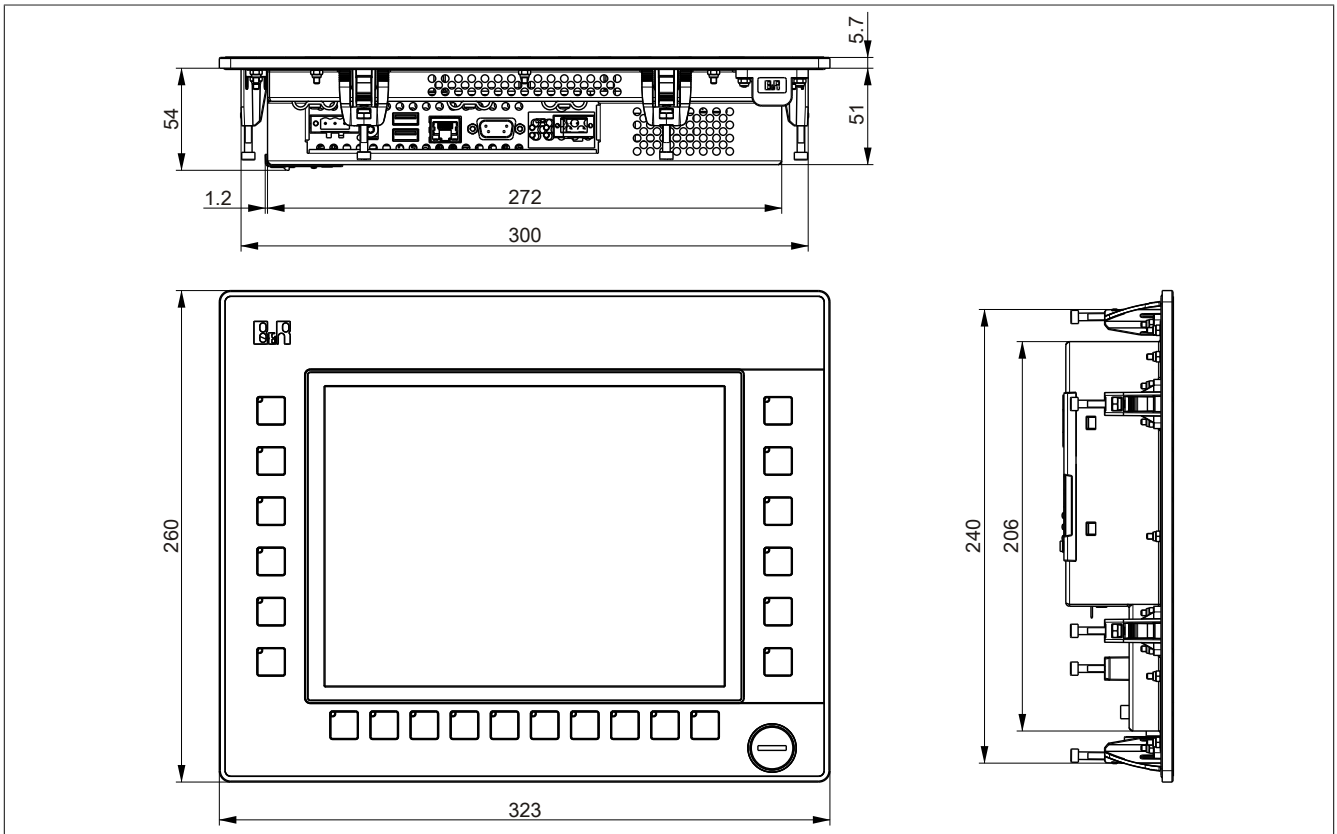

Figure 29: 5PP580.1043-00 - Dimensions

3.1.3.2.5 Cutout installation

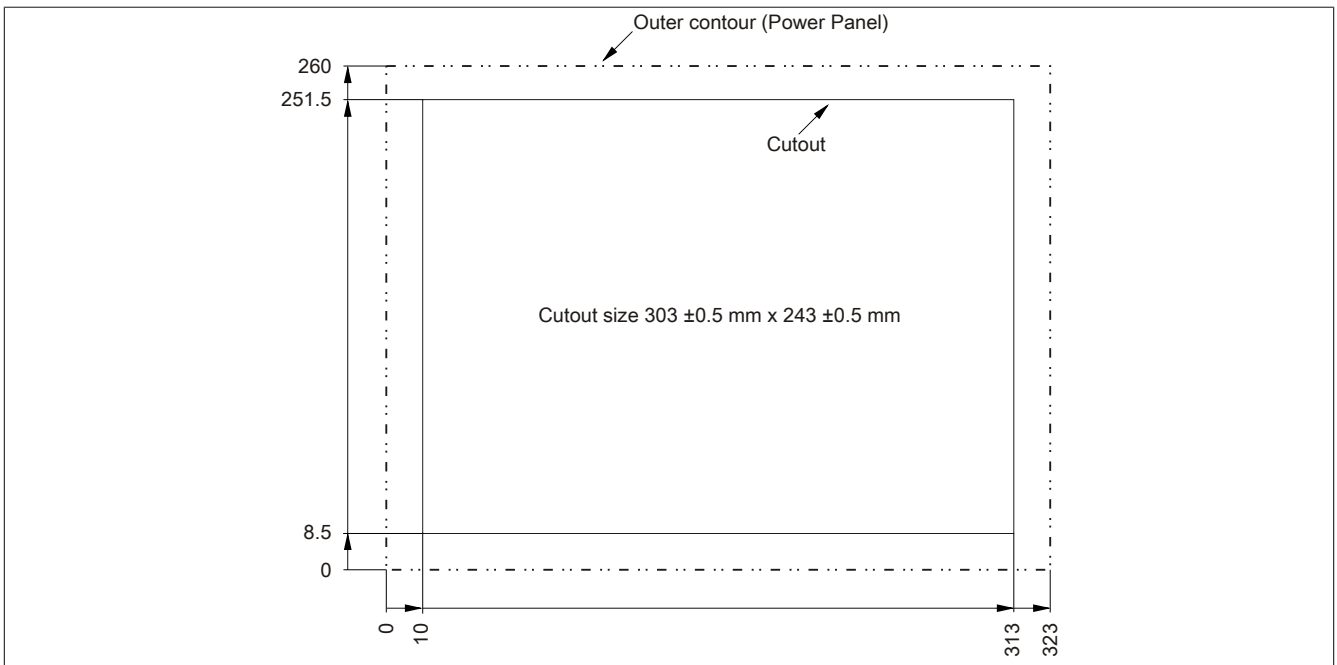

Figure 30: 5PP580.1043-00 - Cutout installation

3.1.3.2.6 Temperature humidity diagram

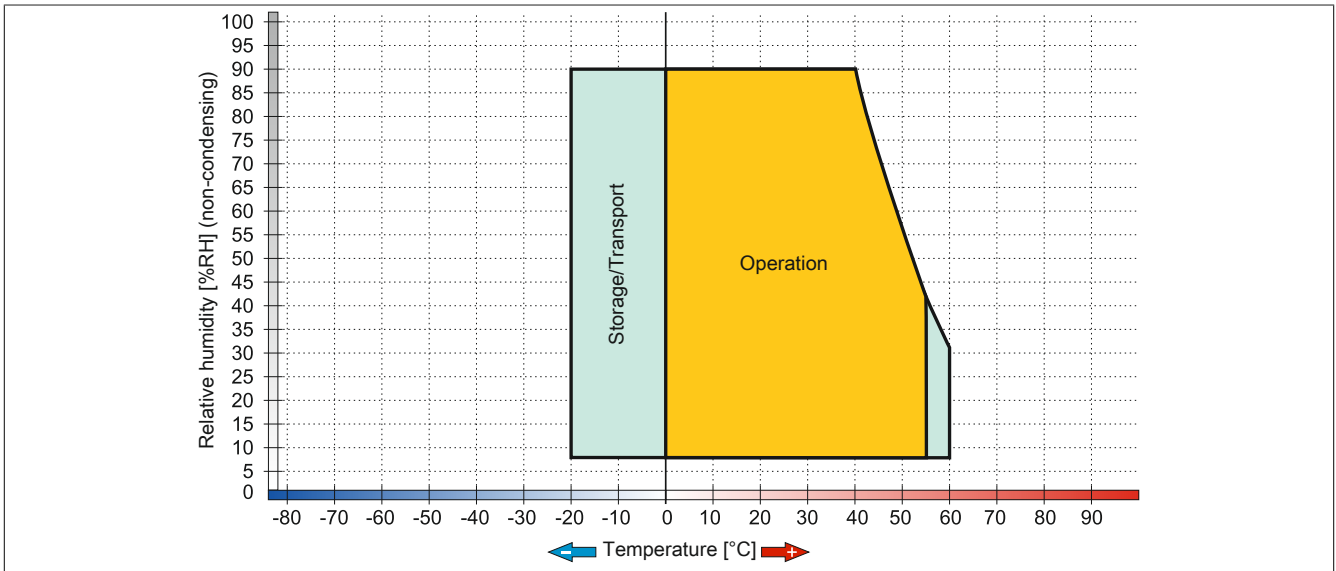

Figure 31: 5PP580.1043-00 - Temperature humidity diagram

3.1.3.3 5PP581.1043-00

3.1.3.3.1 General information

- 10.4" TFT VGA color display
- Analog resistive touch screen plus function and system keys
- Intel® Atom™ technology
- Compact installation depth
- Fanless operation
- Can be upgraded with interface board

3.1.3.3.2 Order data

Model number	Short description	Figure
	System units	
5PP581.1043-00	Power Panel 581 10.4" VGA TFT display with touch screen (resistive); 38 function keys and 20 system keys; connections for 1x RS232, 3x USB 2.0, 1x Ethernet 10/100/1000; can be expanded with interface board; IP65 protection (front); order male 24 VDC connector for voltage supply separately (screw clamp: 0TB103.9; cage clamp: 0TB103.91)	
	Required accessories	
	CPU boards	
5PP5CP.US15-00	CPU board Intel Atom Z510 1.1 GHz - Single core - US15W chipset	
5PP5CP.US15-01	CPU board Intel Atom Z520 1.33 GHz - Single core - US15W chipset	
5PP5CP.US15-02	CPU board Intel Atom Z530 1.6 GHz - Single core - US15W chipset	
	Main memory	
5MMDDR.0512-01	SO-DIMM DDR2 RAM 512 MB PC2-5300	
5MMDDR.1024-01	SO-DIMM DDR2 RAM 1024 MB PC2-5300	
5MMDDR.2048-01	SO-DIMM DDR2 RAM 2048 MB PC2-5300	
	Terminal blocks	
0TB103.9	Connector 24 VDC - 3-pin female - Screw clamps 3.31 mm ²	
0TB103.91	Connector 24 VDC - 3-pin female - Cage clamps 3.31 mm ²	
	Optional accessories	
	Batteries	
0AC201.91	Lithium batteries 4 pcs., 3 V / 950 mAh button cell We hereby state that the lithium cells contained in this shipment qualify as "partly regulated". Handle with care. If the package is damaged, inspect the cells, repack intact cells and protect cells against short circuits. For emergency information, call RENATA SA at + 41 61 319 28 27	
4A0006.00-000	Lithium battery, 3 V / 950 mAh, button cell	
	CompactFlash cards	
5CFCRD.016G-06	CompactFlash 16 GB B&R (SLC)	
5CFCRD.0512-06	CompactFlash 512 MB B&R (SLC)	
5CFCRD.1024-06	CompactFlash 1 GB B&R (SLC)	
5CFCRD.2048-06	CompactFlash 2 GB B&R (SLC)	
5CFCRD.4096-06	CompactFlash 4 GB B&R (SLC)	
5CFCRD.8192-06	CompactFlash 8 GB B&R (SLC)	
	Interface boards	
5PP5IF.CETH-00	Ethernet interface card - 1 Ethernet 10/100/1000	
5PP5IF.CHDA-00	Audio interface card - 1 HDA	
5PP5IF.FCAN-00	CAN interface card - 1 CAN master	
5PP5IF.FETH-00	Ethernet interface card - 1 Ethernet 10/100/1000 - 512 kB SRAM	
5PP5IF.FPLM-00	POWERLINK interface card - 2 POWERLINK managing nodes - 512 kB SRAM	
5PP5IF.FX2X-00	X2X Link interface card - 1 X2X Link master - 512 kB SRAM	
5PP5IF.FXCM-00	CAN interface card - 1 CAN master - 1 X2X master - 512 kB SRAM - Can be installed in PP500, APC510, APC511 systems	
	USB accessories	
5MMUSB.2048-01	USB 2.0 flash drive, 2048 MB, B&R	
5MMUSB.4096-01	USB 2.0 flash drive, 4096 MB, B&R	

Table 36: 5PP581.1043-00 - Order data

3.1.3.3.3 Technical data

Product ID	5PP581.1043-00
General information	
Cooling	Fanless
LED status indicators	Power, CF, Link, Run
B&R ID code	0xB608
Battery	
Type	Renata 950 mAh
Service life	4 years ¹⁾
Removable	Yes, accessible from the outside
Design	Lithium ion
Power button	Yes
Reset button	Yes
Buzzer	Yes
Certification	
CE	Yes
cULus	Yes
GOST-R	Yes
Controller	
Boot loader	BIOS
Mode/Node switches	2, 16 positions each (back)
Watchdog	MTCX
Power failure logic	
Controller	MTCX ²⁾
Buffer time	10 ms
Graphics	
Controller	Intel® Graphics Media Accelerator 500
Memory	
Type	DDR2 SDRAM
Memory size	Max. 2 GB
Interfaces	
COM1 ³⁾	
Type	RS232, modem-capable, not electrically isolated
Design	9-pin male DSUB connector
UART	16550-compatible, 16-byte FIFO
Max. baud rate	115 kbit/s
CompactFlash slot 1	
Type	Type I
SD memory card slot	
Type	SD card
USB	
Quantity	3
Type	USB 2.0
Design	Type A
Transfer rate	Low speed (1.5 Mbit/s), full speed (12 Mbit/s), high speed (480 Mbit/s)
Current load	Max. 1 A per connection
Ethernet	
Quantity	1
Controller	Intel 82574
Design	Shielded RJ45 port
Transfer rate	10/100/1000 Mbit/s
Display	
Type	Color TFT
Display size	10.4" (264 mm)
Colors	16 million
Resolution	VGA, 640 x 480 pixels
Contrast	700:1
Viewing angles	
Horizontal	Direction R = 80° / Direction L = 80°
Vertical	Direction U = 80° / Direction D = 60°
Backlight	
Type	LED
Brightness (dimnable)	Typ. 22.5 to 450 cd/m ²
Half-brightness time ⁴⁾	50,000 h
Touch screen ⁵⁾	
Type	AMT
Technology	Analog, resistive
Controller	B&R, serial, 12-bit
Transmittance	81% ±3%
Keys	
Function keys	38 with LED (yellow)
System keys	Numeric keys, cursor block
Service life	>1,000,000 actuations at 1 ±0.3N to 3 ±0.3 N actuating force

Table 37: 5PP581.1043-00 - Technical data

Product ID	5PP581.1043-00
LED brightness Yellow	Typ. 38 mcd
Inserts	
Interface board	Yes
I/O board	No
Electrical characteristics	
Nominal voltage	24 VDC ±25%
Nominal current	1.2 A ⁶⁾
Starting current	Typ. 3 A, max. 50 A for <300 µs
Power consumption	28.5 W ⁷⁾
Electrical isolation	Yes
Operating conditions	
EN 60529 protection	Back: IP20 (only with an inserted CF card, IF board or optional IF cover) Front: IP65, protection from dust and sprayed water
Environmental conditions	
Temperature	
Operation	0 to 55°C
Storage	-20 to 60°C
Transport	-20 to 60°C
Relative humidity	
Operation	See temperature/humidity diagram
Storage	See temperature/humidity diagram
Transport	See temperature/humidity diagram
Vibration	
Operation (continuous)	2 to 9 Hz: 1.75 mm amplitude / 9 to 200 Hz: 0.5 g
Operation (occasional)	2 to 9 Hz: 3.5 mm amplitude / 9 to 200 Hz: 1 g
Storage	2 to 8 Hz: 7.5 mm amplitude / 8 to 200 Hz: 2 g / 200 to 500 Hz: 4 g
Transport	2 to 8 Hz: 7.5 mm amplitude / 8 to 200 Hz: 2 g / 200 to 500 Hz: 4 g
Shock	
Operation	15 g, 11 ms
Storage	30 g, 6 ms
Transport	30 g, 6 ms
Elevation	
Operation	Max. 3000 m (component-dependent) ⁸⁾
Mechanical characteristics	
Housing	
Material	Galvanized steel plate
Front ⁹⁾	
Frame	Naturally anodized aluminum
Panel overlay	
Material	Polyester
Light background	RAL 9006
Dark gray border around display	RAL 7024
Gasket	Flat gasket around display front
Dimensions	
Width	323 mm
Height	358 mm
Depth	59.7 mm
Weight	3350 g

Table 37: 5PP581.1043-00 - Technical data

- 1) At 50°C, 8.5 µA of the supplied components and a self-discharge of 40%. If an interface board with SRAM has been installed, the service life is 2½ years.
- 2) Maintenance Controller Extended.
- 3) The COM1 interface is identified in BIOS as the COM A interface.
- 4) At an ambient temperature of 25°C. Reducing the brightness by 50% can result in an approximately 50% increase in the half-brightness time.
- 5) Touch screen drivers for approved operating systems are available in the Downloads section of the B&R website.
- 6) The specified value applies to a nominal voltage of 24 VDC.
- 7) The specified value applies to a system unit with a CPU board but without an interface board.
- 8) The maximum ambient temperature is typically derated by 1°C per 1000 meters (starting at 500 meters above sea level).
- 9) There may be visible deviations in the color and surface appearance depending on the process or batch.

3.1.3.3.4 Dimensions

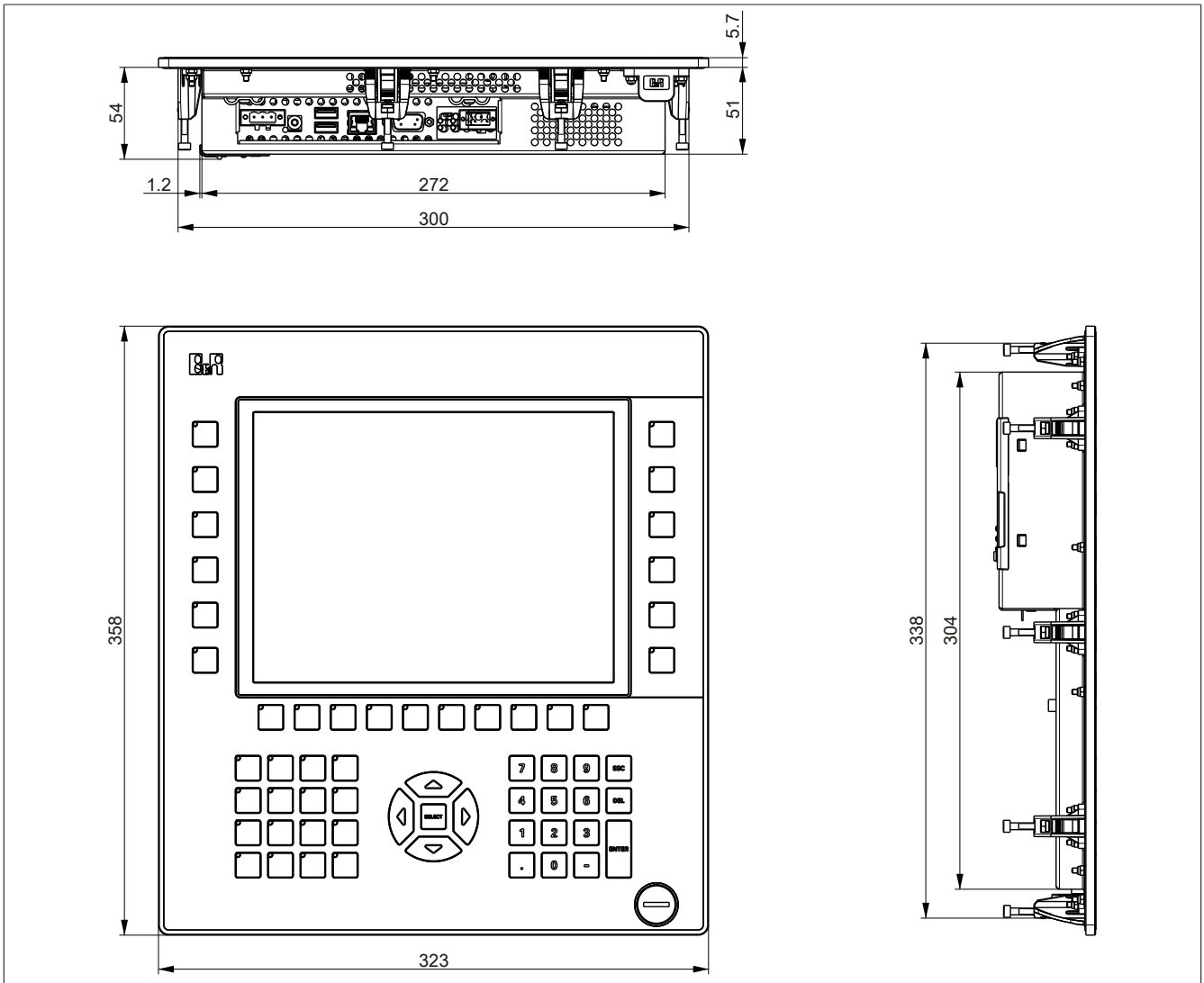

Figure 32: 5PP581.1043-00 - Dimensions

3.1.3.3.5 Cutout installation

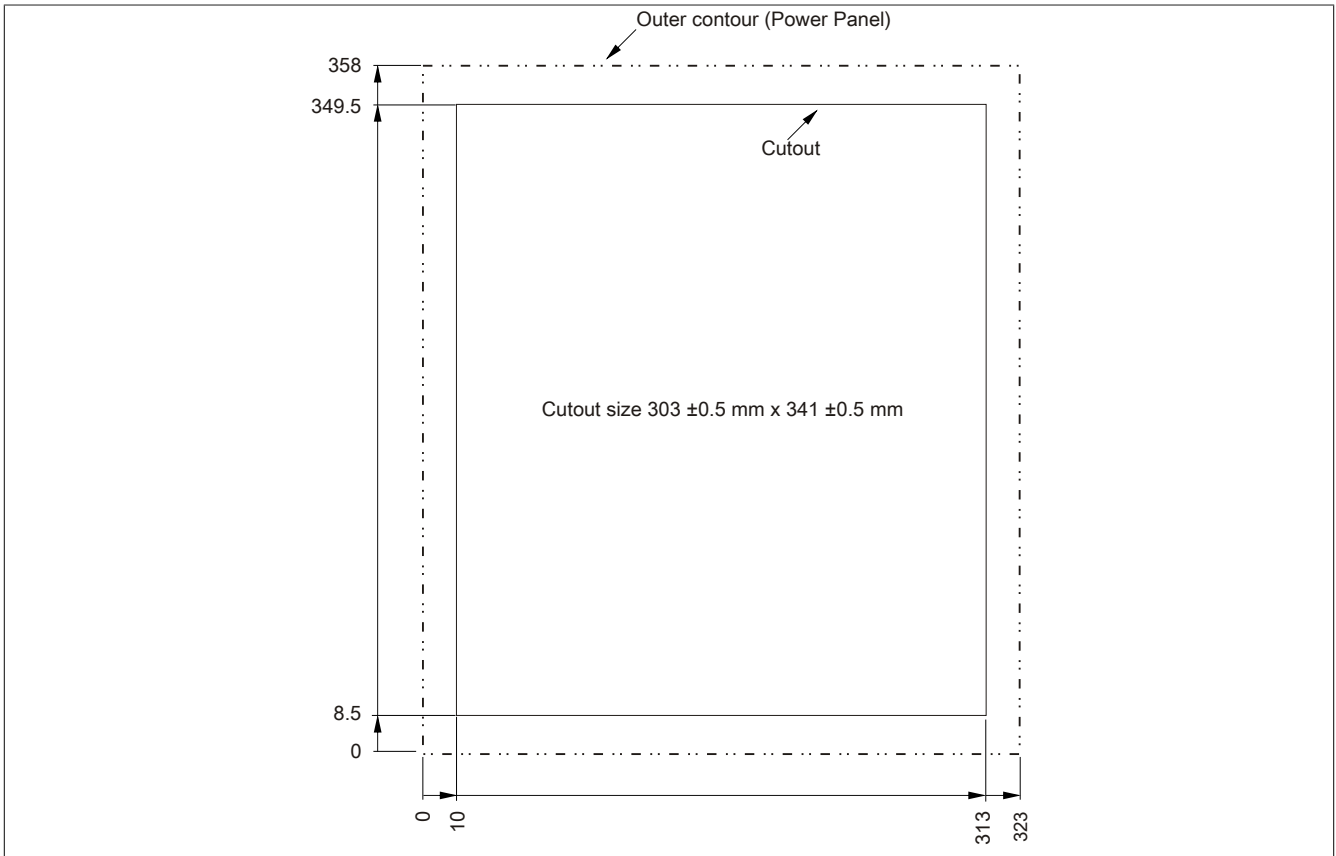

Figure 33: 5PP581.1043-00 - Cutout installation

3.1.3.3.6 Temperature humidity diagram

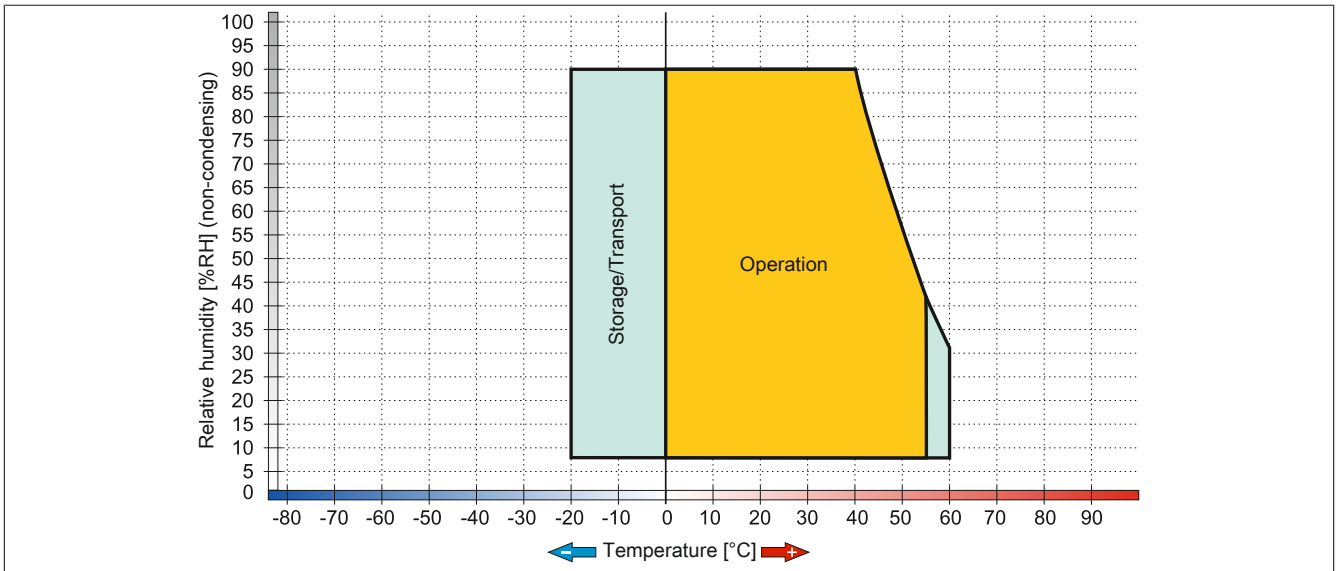

Figure 34: 5PP581.1043-00 - Temperature humidity diagram

3.1.3.4 5PP582.1043-00

3.1.3.4.1 General information

- 10.4" TFT VGA color display
- Analog resistive touch screen plus function and system keys
- Intel® Atom™ technology
- Compact installation depth
- Fanless operation
- Can be upgraded with interface board

3.1.3.4.2 Order data

Model number	Short description	Figure
System units		
5PP582.1043-00	Power Panel 582 10.4" VGA TFT display with touch screen (resistive); 44 function keys and 20 system keys; connections for 1x RS232, 3x USB 2.0, 1x Ethernet 10/100/1000; can be expanded with interface board; IP65 protection (front); order male 24 VDC connector for voltage supply separately (screw clamp: 0TB103.9; cage clamp: 0TB103.91)	
Required accessories		
CPU boards		
5PP5CP.US15-00	CPU board Intel Atom Z510 1.1 GHz - Single core - US15W chipset	
5PP5CP.US15-01	CPU board Intel Atom Z520 1.33 GHz - Single core - US15W chipset	
5PP5CP.US15-02	CPU board Intel Atom Z530 1.6 GHz - Single core - US15W chipset	
Main memory		
5MMDDR.0512-01	SO-DIMM DDR2 RAM 512 MB PC2-5300	
5MMDDR.1024-01	SO-DIMM DDR2 RAM 1024 MB PC2-5300	
5MMDDR.2048-01	SO-DIMM DDR2 RAM 2048 MB PC2-5300	
Terminal blocks		
0TB103.9	Connector 24 VDC - 3-pin female - Screw clamps 3.31 mm ²	
0TB103.91	Connector 24 VDC - 3-pin female - Cage clamps 3.31 mm ²	
Optional accessories		
Batteries		
0AC201.91	Lithium batteries 4 pcs., 3 V / 950 mAh button cell We hereby state that the lithium cells contained in this shipment qualify as "partly regulated". Handle with care. If the package is damaged, inspect the cells, repack intact cells and protect cells against short circuits. For emergency information, call RENATA SA at + 41 61 319 28 27	
4A0006.00-000	Lithium battery, 3 V / 950 mAh, button cell	
CompactFlash cards		
5CFCRD.016G-06	CompactFlash 16 GB B&R (SLC)	
5CFCRD.0512-06	CompactFlash 512 MB B&R (SLC)	
5CFCRD.1024-06	CompactFlash 1 GB B&R (SLC)	
5CFCRD.2048-06	CompactFlash 2 GB B&R (SLC)	
5CFCRD.4096-06	CompactFlash 4 GB B&R (SLC)	
5CFCRD.8192-06	CompactFlash 8 GB B&R (SLC)	
Interface boards		
5PP5IF.CETH-00	Ethernet interface card - 1 Ethernet 10/100/1000	
5PP5IF.CHDA-00	Audio interface card - 1 HDA	
5PP5IF.FCAN-00	CAN interface card - 1 CAN master	
5PP5IF.FETH-00	Ethernet interface card - 1 Ethernet 10/100/1000 - 512 kB SRAM	
5PP5IF.FPLM-00	POWERLINK interface card - 2 POWERLINK managing nodes - 512 kB SRAM	
5PP5IF.FX2X-00	X2X Link interface card - 1 X2X Link master - 512 kB SRAM	
5PP5IF.FXCM-00	CAN interface card - 1 CAN master - 1 X2X master - 512 kB SRAM - Can be installed in PP500, APC510, APC511 systems	
USB accessories		
5MMUSB.2048-01	USB 2.0 flash drive, 2048 MB, B&R	
5MMUSB.4096-01	USB 2.0 flash drive, 4096 MB, B&R	

Table 38: 5PP582.1043-00 - Order data

3.1.3.4.3 Technical data

Product ID	5PP582.1043-00
General information	
Cooling	Fanless
LED status indicators	Power, CF, Link, Run
B&R ID code	0xB609
Battery	
Type	Renata 950 mAh
Service life	4 years ¹⁾
Removable	Yes, accessible from the outside
Design	Lithium ion
Power button	Yes
Reset button	Yes
Buzzer	Yes
Certification	
CE	Yes
cULus	Yes
GOST-R	Yes
Controller	
Boot loader	BIOS
Mode/Node switches	2, 16 positions each (back)
Watchdog	MTCX
Power failure logic	
Controller	MTCX ²⁾
Buffer time	10 ms
Graphics	
Controller	Intel® Graphics Media Accelerator 500
Memory	
Type	DDR2 SDRAM
Memory size	Max. 2 GB
Interfaces	
COM1 ³⁾	
Type	RS232, modem-capable, not electrically isolated
Design	9-pin male DSUB connector
UART	16550-compatible, 16-byte FIFO
Max. baud rate	115 kbit/s
CompactFlash slot 1	
Type	Type I
SD memory card slot	
Type	SD card
USB	
Quantity	3
Type	USB 2.0
Design	Type A
Transfer rate	Low speed (1.5 Mbit/s), full speed (12 Mbit/s), high speed (480 Mbit/s)
Current load	Max. 1 A per connection
Ethernet	
Quantity	1
Controller	Intel 82574
Design	Shielded RJ45 port
Transfer rate	10/100/1000 Mbit/s
Display	
Type	Color TFT
Display size	10.4" (264 mm)
Colors	16 million
Resolution	VGA, 640 x 480 pixels
Contrast	700:1
Viewing angles	
Horizontal	Direction R = 80° / Direction L = 80°
Vertical	Direction U = 80° / Direction D = 60°
Backlight	
Type	LED
Brightness (dimnable)	Typ. 22.5 to 450 cd/m ²
Half-brightness time ⁴⁾	50,000 h
Touch screen ⁵⁾	
Type	AMT
Technology	Analog, resistive
Controller	B&R, serial, 12-bit
Transmittance	81% ±3%
Keys	
Function keys	44 with LED (yellow)
System keys	Numeric keys, cursor block
Service life	>1,000,000 actuations at 1 ±0.3N to 3 ±0.3 N actuating force

Table 39: 5PP582.1043-00 - Technical data

Product ID	5PP582.1043-00
LED brightness Yellow	Typ. 38 mcd
Inserts	
Interface board	Yes
I/O board	No
Electrical characteristics	
Nominal voltage	24 VDC ±25%
Nominal current	1.2 A ⁶⁾
Starting current	Typ. 3 A, max. 50 A for <300 µs
Power consumption	28.5 W ⁷⁾
Electrical isolation	Yes
Operating conditions	
EN 60529 protection	Back: IP20 (only with an inserted CF card, IF board or optional IF cover) Front: IP65, protection from dust and sprayed water
Environmental conditions	
Temperature	
Operation	0 to 55°C
Storage	-20 to 60°C
Transport	-20 to 60°C
Relative humidity	
Operation	See temperature/humidity diagram
Storage	See temperature/humidity diagram
Transport	See temperature/humidity diagram
Vibration	
Operation (continuous)	2 to 9 Hz: 1.75 mm amplitude / 9 to 200 Hz: 0.5 g
Operation (occasional)	2 to 9 Hz: 3.5 mm amplitude / 9 to 200 Hz: 1 g
Storage	2 to 8 Hz: 7.5 mm amplitude / 8 to 200 Hz: 2 g / 200 to 500 Hz: 4 g
Transport	2 to 8 Hz: 7.5 mm amplitude / 8 to 200 Hz: 2 g / 200 to 500 Hz: 4 g
Shock	
Operation	15 g, 11 ms
Storage	30 g, 6 ms
Transport	30 g, 6 ms
Elevation	
Operation	Max. 3000 m (component-dependent) ⁸⁾
Mechanical characteristics	
Housing	
Material	Galvanized steel plate
Front ⁹⁾	
Frame	Naturally anodized aluminum
Panel overlay	
Material	Polyester
Light background	RAL 9006
Dark gray border around display	RAL 7024
Gasket	Flat gasket around display front
Dimensions	
Width	423 mm
Height	288 mm
Depth	59.7 mm
Weight	3500 g

Table 39: 5PP582.1043-00 - Technical data

- 1) At 50°C, 8.5 µA of the supplied components and a self-discharge of 40%. If an interface board with SRAM has been installed, the service life is 2½ years.
- 2) Maintenance Controller Extended.
- 3) The COM1 interface is identified in BIOS as the COM A interface.
- 4) At an ambient temperature of 25°C. Reducing the brightness by 50% can result in an approximately 50% increase in the half-brightness time.
- 5) Touch screen drivers for approved operating systems are available in the Downloads section of the B&R website.
- 6) The specified value applies to a nominal voltage of 24 VDC.
- 7) The specified value applies to a system unit with a CPU board but without an interface board.
- 8) The maximum ambient temperature is typically derated by 1°C per 1000 meters (starting at 500 meters above sea level).
- 9) There may be visible deviations in the color and surface appearance depending on the process or batch.

3.1.3.4.4 Dimensions

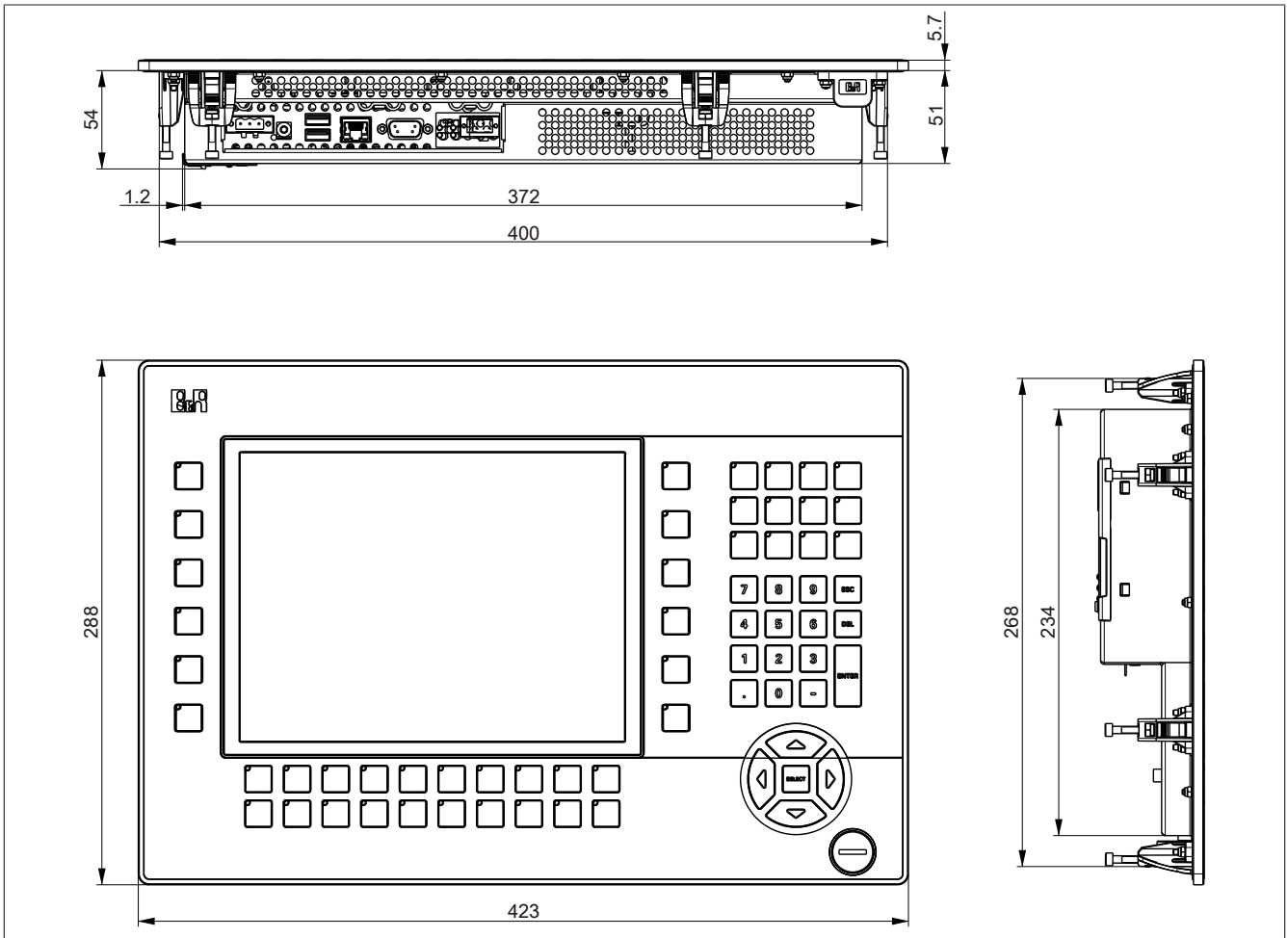

Figure 35: 5PP582.1043-00 - Dimensions

3.1.3.4.5 Cutout installation

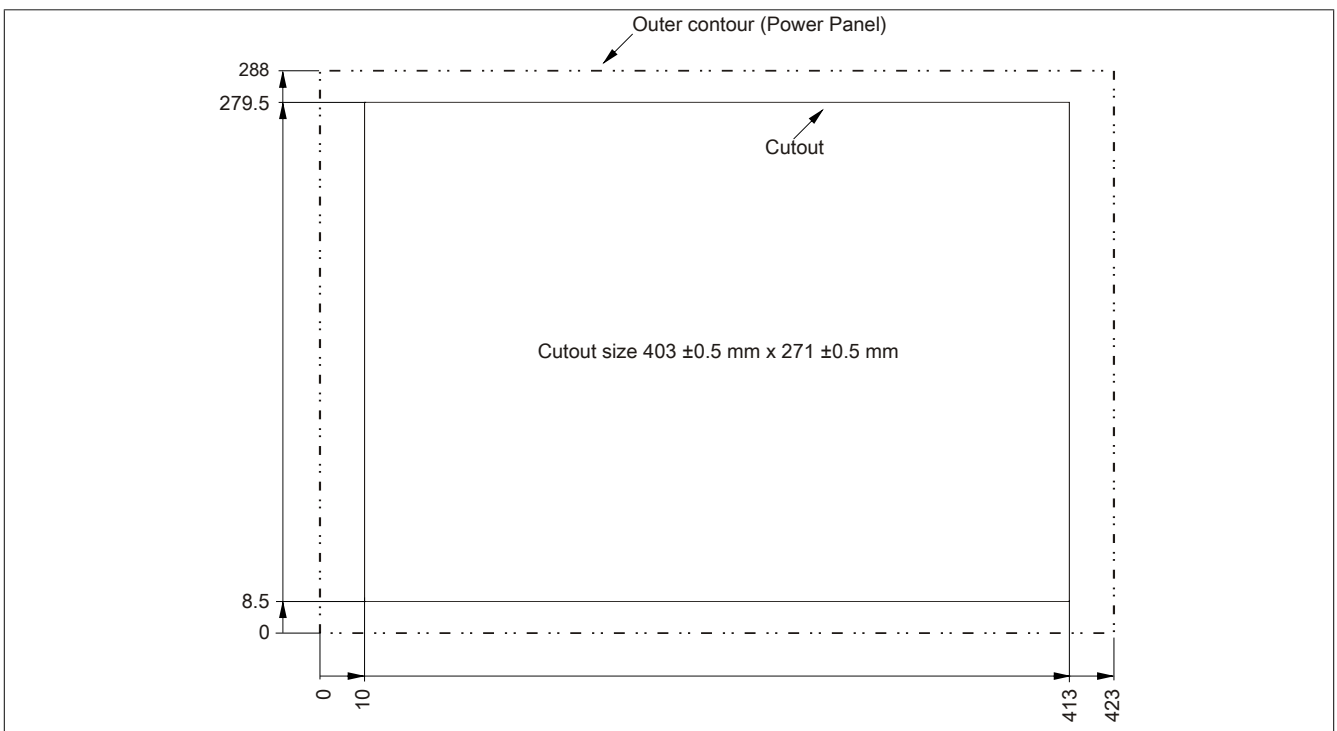

Figure 36: 5PP582.1043-00 - Cutout installation

3.1.3.4.6 Temperature humidity diagram

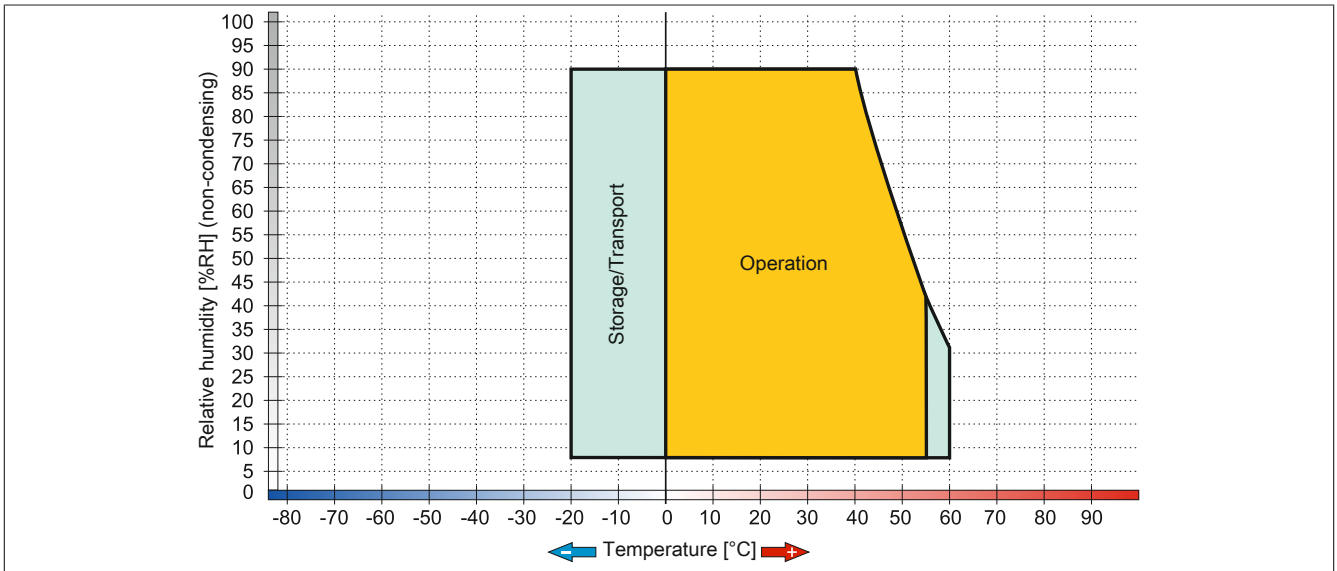

Figure 37: 5PP582.1043-00 - Temperature humidity diagram

3.1.4 12.1" system unit

3.1.4.1 5PP520.1214-00

3.1.4.1.1 General information

- 12.1" TFT SVGA color display
- Analog resistive touch screen
- Intel® Atom™ technology
- Compact installation depth
- Fanless operation
- Can be upgraded with interface board

3.1.4.1.2 Order data

Model number	Short description	Figure
	System units	
5PP520.1214-00	Power Panel 520 12" SVGA TFT display with touch screen (resistive); connections for 1x RS232, 3x USB 2.0, 1x Ethernet 10/100/1000; can be expanded with interface board; IP65 protection (front); order male 24 VDC connector for voltage supply separately (screw clamp: 0TB103.9; cage clamp: 0TB103.91)	
	Required accessories	
	CPU boards	
5PP5CP.US15-00	CPU board Intel Atom Z510 1.1 GHz - Single core - US15W chipset	
5PP5CP.US15-01	CPU board Intel Atom Z520 1.33 GHz - Single core - US15W chipset	
5PP5CP.US15-02	CPU board Intel Atom Z530 1.6 GHz - Single core - US15W chipset	
	Main memory	
5MMDDR.0512-01	SO-DIMM DDR2 RAM 512 MB PC2-5300	
5MMDDR.1024-01	SO-DIMM DDR2 RAM 1024 MB PC2-5300	
5MMDDR.2048-01	SO-DIMM DDR2 RAM 2048 MB PC2-5300	
	Terminal blocks	
0TB103.9	Connector 24 VDC - 3-pin female - Screw clamps 3.31 mm ²	
0TB103.91	Connector 24 VDC - 3-pin female - Cage clamps 3.31 mm ²	
	Optional accessories	
	Batteries	
0AC201.91	Lithium batteries 4 pcs., 3 V / 950 mAh button cell We hereby state that the lithium cells contained in this shipment qualify as "partly regulated". Handle with care. If the package is damaged, inspect the cells, repack intact cells and protect cells against short circuits. For emergency information, call RENATA SA at + 41 61 319 28 27	
4A0006.00-000	Lithium battery, 3 V / 950 mAh, button cell	
	CompactFlash cards	
5CFCRD.016G-06	CompactFlash 16 GB B&R (SLC)	
5CFCRD.0512-06	CompactFlash 512 MB B&R (SLC)	
5CFCRD.1024-06	CompactFlash 1 GB B&R (SLC)	
5CFCRD.2048-06	CompactFlash 2 GB B&R (SLC)	
5CFCRD.4096-06	CompactFlash 4 GB B&R (SLC)	
5CFCRD.8192-06	CompactFlash 8 GB B&R (SLC)	
	Interface boards	
5PP5IF.CETH-00	Ethernet interface card - 1 Ethernet 10/100/1000	
5PP5IF.CHDA-00	Audio interface card - 1 HDA	
5PP5IF.FCAN-00	CAN interface card - 1 CAN master	
5PP5IF.FETH-00	Ethernet interface card - 1 Ethernet 10/100/1000 - 512 kB SRAM	
5PP5IF.FPLM-00	POWERLINK interface card - 2 POWERLINK managing nodes - 512 kB SRAM	
5PP5IF.FX2X-00	X2X Link interface card - 1 X2X Link master - 512 kB SRAM	
5PP5IF.FXCM-00	CAN interface card - 1 CAN master - 1 X2X master - 512 kB SRAM - Can be installed in PP500, APC510, APC511 systems	
	USB accessories	
5MMUSB.2048-01	USB 2.0 flash drive, 2048 MB, B&R	
5MMUSB.4096-01	USB 2.0 flash drive, 4096 MB, B&R	

Table 40: 5PP520.1214-00 - Order data

3.1.4.1.3 Technical data

Product ID	5PP520.1214-00
General information	
Cooling	Fanless
LED status indicators	Power, CF, Link, Run
B&R ID code	0xB4E0
Battery	
Type	Renata 950 mAh
Service life	4 years ¹⁾
Removable	Yes, accessible from the outside
Design	Lithium ion
Power button	Yes
Reset button	Yes
Buzzer	Yes
Certification	
CE	Yes
cULus	Yes
GOST-R	Yes
Controller	
Boot loader	BIOS
Mode/Node switches	2, 16 positions each (back)
Watchdog	MTCX
Power failure logic	
Controller	MTCX ²⁾
Buffer time	10 ms
Graphics	
Controller	Intel® Graphics Media Accelerator 500
Memory	
Type	DDR2 SDRAM
Memory size	Max. 2 GB
Interfaces	
COM1 ³⁾	
Type	RS232, modem-capable, not electrically isolated
Design	9-pin male DSUB connector
UART	16550-compatible, 16-byte FIFO
Max. baud rate	115 kbit/s
CompactFlash slot 1	
Type	Type I
SD memory card slot	
Type	SD card
USB	
Quantity	3
Type	USB 2.0
Design	Type A
Transfer rate	Low speed (1.5 Mbit/s), full speed (12 Mbit/s), high speed (480 Mbit/s)
Current load	Max. 1 A per connection
Ethernet	
Quantity	1
Controller	Intel 82574
Design	Shielded RJ45 port
Transfer rate	10/100/1000 Mbit/s
Display	
Type	Color TFT
Display size	12.1" (307 mm)
Colors	262,144
Resolution	SVGA, 800 x 600 pixels
Contrast	800:1
Viewing angles	
Horizontal	Direction R = 80° / Direction L = 80°
Vertical	Direction U = 35° / Direction D = 60°
Backlight	
Type	LED
Brightness (dimnable)	Typ. 45 to 450 cd/m ²
Half-brightness time ⁴⁾	50,000 h
Touch screen ⁵⁾	
Type	AMT
Technology	Analog, resistive
Controller	B&R, serial, 12-bit
Transmittance	81% ±3%
Keys	
Function keys	No
System keys	No
Service life	-
LED brightness	-

Table 41: 5PP520.1214-00 - Technical data

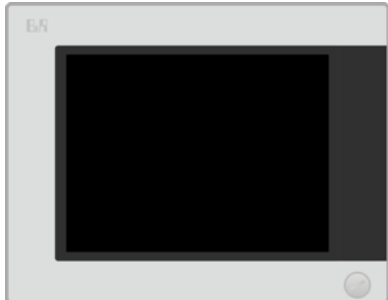
Product ID	5PP520.1214-00
Inserts	
Interface board	Yes
I/O board	No
Electrical characteristics	
Nominal voltage	24 VDC ±25%
Nominal current	1.2 A ⁶⁾
Starting current	Typ. 3 A, max. 50 A for <300 µs
Power consumption	29 W ⁷⁾
Electrical isolation	Yes
Operating conditions	
EN 60529 protection	Back: IP20 (only with an inserted CF card, IF board or optional IF cover) Front: IP65, protection from dust and sprayed water
Environmental conditions	
Temperature	
Operation	0 to 55°C
Storage	-20 to 60°C
Transport	-20 to 60°C
Relative humidity	
Operation	See temperature/humidity diagram
Storage	See temperature/humidity diagram
Transport	See temperature/humidity diagram
Vibration	
Operation (continuous)	2 to 9 Hz: 1.75 mm amplitude / 9 to 200 Hz: 0.5 g
Operation (occasional)	2 to 9 Hz: 3.5 mm amplitude / 9 to 200 Hz: 1 g
Storage	2 to 8 Hz: 7.5 mm amplitude / 8 to 200 Hz: 2 g / 200 to 500 Hz: 4 g
Transport	2 to 8 Hz: 7.5 mm amplitude / 8 to 200 Hz: 2 g / 200 to 500 Hz: 4 g
Shock	
Operation	15 g, 11 ms
Storage	30 g, 6 ms
Transport	30 g, 6 ms
Elevation	
Operation	Max. 3000 m (component-dependent) ⁸⁾
Mechanical characteristics	
Housing	
Material	Galvanized steel plate
Front ⁹⁾	
Frame	Naturally anodized aluminum
Panel overlay	
Material	Polyester
Light background	RAL 9006
Dark gray border around display	RAL 7024
Gasket	Flat gasket around display front
Dimensions	
Width	362 mm
Height	284 mm
Depth	60.2 mm
Weight	3350 g

Table 41: 5PP520.1214-00 - Technical data

- 1) At 50°C, 8.5 µA of the supplied components and a self-discharge of 40%. If an interface board with SRAM has been installed, the service life is 2½ years.
- 2) Maintenance Controller Extended.
- 3) The COM1 interface is identified in BIOS as the COM A interface.
- 4) At an ambient temperature of 25°C. Reducing the brightness by 50% can result in an approximately 50% increase in the half-brightness time.
- 5) Touch screen drivers for approved operating systems are available in the Downloads section of the B&R website.
- 6) The specified value applies to a nominal voltage of 24 VDC.
- 7) The specified value applies to a system unit with a CPU board but without an interface board.
- 8) The maximum ambient temperature is typically derated by 1°C per 1000 meters (starting at 500 meters above sea level).
- 9) There may be visible deviations in the color and surface appearance depending on the process or batch.

3.1.4.1.4 Dimensions

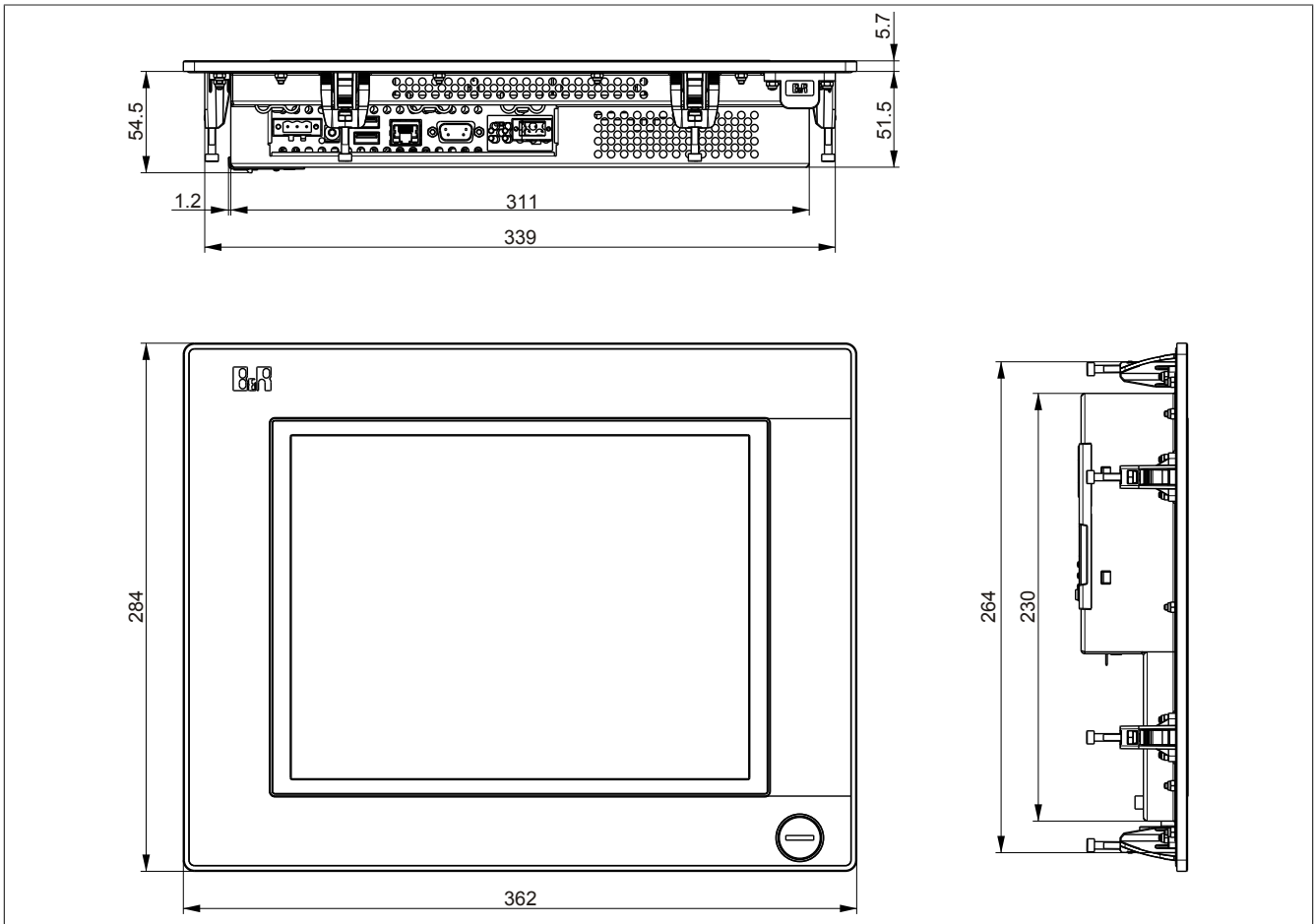

Figure 38: 5PP520.1214-00 - Dimensions

3.1.4.1.5 Cutout installation

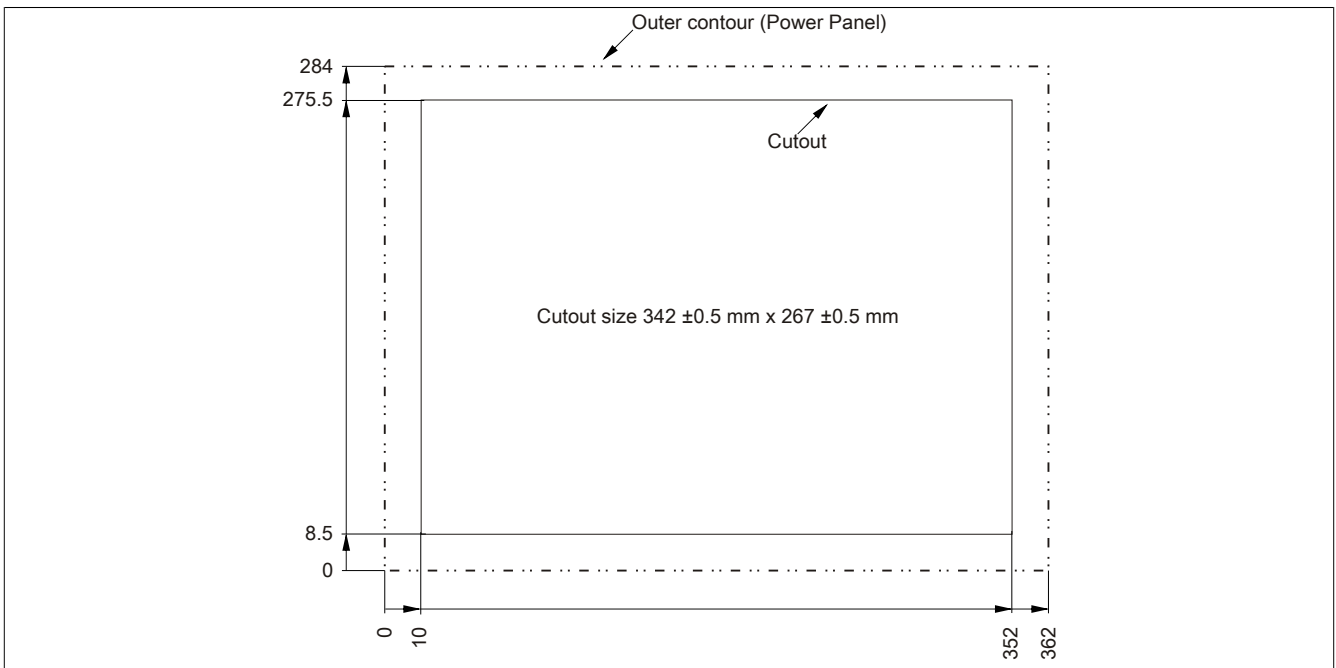

Figure 39: 5PP520.1214-00 - Cutout installation

3.1.4.1.6 Temperature humidity diagram

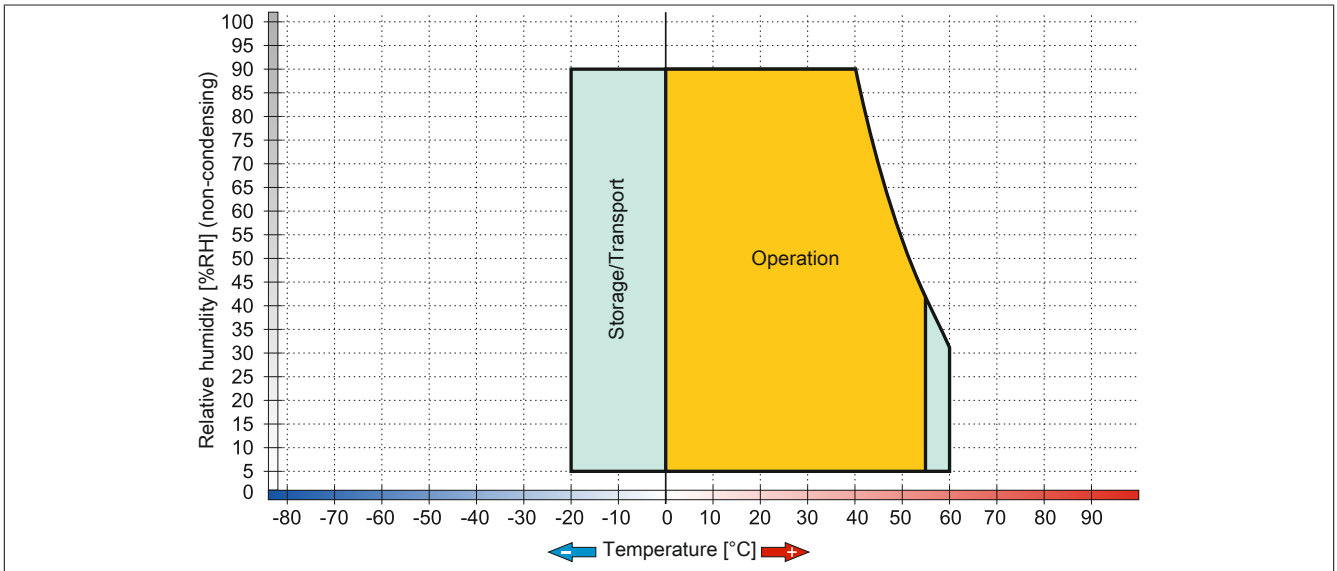

Figure 40: 5PP520.1214-00 - Temperature humidity diagram

3.1.5 15" system units

3.1.5.1 5PP520.1505-00

3.1.5.1.1 General information

- 15" TFT XGA color display
- Analog resistive touch screen
- Intel® Atom™ technology
- Compact installation depth
- Fanless operation
- Can be upgraded with interface board

3.1.5.1.2 Order data

Model number	Short description	Figure
System units		
5PP520.1505-00	Power Panel 520 15" XGA TFT display with touch screen (resistive); connections for 1x RS232, 3x USB 2.0, 1x Ethernet 10/100/1000; can be expanded with interface board; IP65 protection (front); order male 24 VDC connector for supply voltage separately (screw clamp: 0TB103.9; cage clamp: 0TB103.91)	
Required accessories		
CPU boards		
5PP5CP.US15-00	CPU board Intel Atom Z510 1.1 GHz - Single core - US15W chipset	
5PP5CP.US15-01	CPU board Intel Atom Z520 1.33 GHz - Single core - US15W chipset	
5PP5CP.US15-02	CPU board Intel Atom Z530 1.6 GHz - Single core - US15W chipset	
Main memory		
5MMDDR.0512-01	SO-DIMM DDR2 RAM 512 MB PC2-5300	
5MMDDR.1024-01	SO-DIMM DDR2 RAM 1024 MB PC2-5300	
5MMDDR.2048-01	SO-DIMM DDR2 RAM 2048 MB PC2-5300	
Terminal blocks		
0TB103.9	Connector 24 VDC - 3-pin female - Screw clamps 3.31 mm ²	
0TB103.91	Connector 24 VDC - 3-pin female - Cage clamps 3.31 mm ²	
Optional accessories		
Batteries		
0AC201.91	Lithium batteries 4 pcs., 3 V / 950 mAh button cell We hereby state that the lithium cells contained in this shipment qualify as "partly regulated". Handle with care. If the package is damaged, inspect the cells, repack intact cells and protect cells against short circuits. For emergency information, call RENATA SA at + 41 61 319 28 27	
4A0006.00-000	Lithium battery, 3 V / 950 mAh, button cell	
CompactFlash cards		
5CFCRD.016G-06	CompactFlash 16 GB B&R (SLC)	
5CFCRD.0512-06	CompactFlash 512 MB B&R (SLC)	
5CFCRD.1024-06	CompactFlash 1 GB B&R (SLC)	
5CFCRD.2048-06	CompactFlash 2 GB B&R (SLC)	
5CFCRD.4096-06	CompactFlash 4 GB B&R (SLC)	
5CFCRD.8192-06	CompactFlash 8 GB B&R (SLC)	
Interface boards		
5PP5IF.CETH-00	Ethernet interface card - 1 Ethernet 10/100/1000	
5PP5IF.CHDA-00	Audio interface card - 1 HDA	
5PP5IF.FCAN-00	CAN interface card - 1 CAN master	
5PP5IF.FETH-00	Ethernet interface card - 1 Ethernet 10/100/1000 - 512 kB SRAM	
5PP5IF.FPLM-00	POWERLINK interface card - 2 POWERLINK managing nodes - 512 kB SRAM	
5PP5IF.FX2X-00	X2X Link interface card - 1 X2X Link master - 512 kB SRAM	
5PP5IF.FXCM-00	CAN interface card - 1 CAN master - 1 X2X master - 512 kB SRAM - Can be installed in PP500, APC510, APC511 systems	
USB accessories		
5MMUSB.2048-01	USB 2.0 flash drive, 2048 MB, B&R	
5MMUSB.4096-01	USB 2.0 flash drive, 4096 MB, B&R	

Table 42: 5PP520.1505-00 - Order data

3.1.5.1.3 Technical data

Product ID	5PP520.1505-00	
Revision	D0	E0
General information		
Cooling	Fan-free	
LED status indicators	Power, CF, Link, Run	
B&R ID code	0xB4CF	
Battery	Renata 950 mAh	
Type	4 years ¹⁾	
Service life	Yes, accessible from the outside	
Removable	Lithium ion	
Design		
Power button	Yes	
Reset button	Yes	
Buzzer	Yes	
Certification		
CE	Yes	
cULus	Yes	
GOST-R	Yes	
GL	Yes ²⁾	
Controller		
Boot loader	BIOS	
Mode/Node switches	2, 16 positions each (back)	
Watchdog	MTCX	
Power failure logic		
Controller	MTCX ³⁾	
Buffer time	10 ms	
Graphics		
Controller	Intel® Graphics Media Accelerator 500	
Memory		
Type	DDR2 SDRAM	
Memory size	Max. 2 GB	
Interfaces		
COM1 ⁴⁾		
Type	RS232, modem-capable, not electrically isolated	
Design	9-pin male DSUB connector	
UART	16550-compatible, 16-byte FIFO	
Max. baud rate	115 kbit/s	
CompactFlash slot 1		
Type	Type I	
SD memory card slot		
Type	SD card	
USB		
Quantity	3	
Type	USB 2.0	
Design	Type A	
Transfer rate	Low speed (1.5 Mbit/s), full speed (12 Mbit/s), high speed (480 Mbit/s)	
Current load	Max. 1 A per connection	
Ethernet		
Quantity	1	
Controller	Intel 82574	
Design	Shielded RJ45 port	
Transfer rate	10/100/1000 Mbit/s	
Display		
Type	Color TFT	
Display size	15" (381 mm)	
Colors	16 million	
Resolution	XGA, 1024 x 768 pixels	
Contrast	700:1	
Viewing angles		
Horizontal	Direction R = 80° / Direction L = 80°	
Vertical	Direction U = 80° / Direction D = 60° Direction U = 70° / Direction D = 70°	
Backlight		
Type	LED	
Brightness (dimnable)	Typ. 35 to 350 cd/m ²	Typ. 20 to 400 cd/m ²
Half-brightness time ⁵⁾	50,000 h	
Touch screen ⁶⁾		
Type	AMT	
Technology	Analog, resistive	
Controller	B&R, serial, 12-bit	
Transmittance	81% ±3%	
Keys		
Function keys	No	
System keys	No	

Table 43: 5PP520.1505-00, 5PP520.1505-00 - Technical data

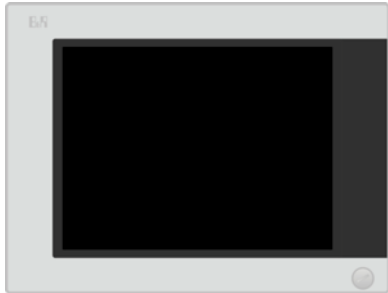
Product ID	5PP520.1505-00
Service life	-
LED brightness	-
Inserts	
Interface board	Yes
I/O board	No
Electrical characteristics	
Nominal voltage	24 VDC ±25%
Nominal current	1.5 A ⁷⁾
Starting current	Typ. 3 A, max. 50 A for <300 µs
Power consumption	31 W ⁸⁾
Electrical isolation	Yes
Operating conditions	
EN 60529 protection	Back: IP20 (only with an inserted CF card, IF board or optional IF cover) Front: IP65, dust and sprayed water protection
Environmental conditions	
Temperature	
Operation	0 to 55°C
Storage	-20 to 60°C
Transport	-20 to 60°C
Relative humidity	
Operation	See temperature humidity diagram
Storage	See temperature humidity diagram
Transport	See temperature humidity diagram
Vibration	
Operation (continuous)	2 to 9 Hz: 1.75 mm amplitude / 9 to 200 Hz: 0.5 g
Operation (occasional)	2 to 9 Hz: 3.5 mm amplitude / 9 to 200 Hz: 1 g
Storage	2 to 8 Hz: 7.5 mm amplitude / 8 to 200 Hz: 2 g / 200 to 500 Hz: 4 g
Transport	2 to 8 Hz: 7.5 mm amplitude / 8 to 200 Hz: 2 g / 200 to 500 Hz: 4 g
Shock	
Operation	15 g, 11 ms
Storage	30 g, 6 ms
Transport	30 g, 6 ms
Elevation	
Operation	Max. 3000 m (component-dependent) ⁹⁾
Mechanical characteristics	
Housing	
Material	Galvanized steel plate
Front ¹⁰⁾	
Frame	Naturally anodized aluminum
Panel overlay	
Material	Polyester
Light background	RAL 9006
Dark gray border around display	RAL 7024
Gasket	Flat gasket around display front
Dimensions	
Width	435 mm
Height	330 mm
Depth	62.7 mm
Weight	5100 g

Table 43: 5PP520.1505-00, 5PP520.1505-00 - Technical data

- 1) At 50°C, 8.5 µA of the supplied components and a self-discharge of 40%. If an interface board with SRAM has been installed, the service life is 2½ years.
- 2) Yes, although applies only if all components installed within the complete system have this certification
- 3) Maintenance Controller Extended.
- 4) The COM1 interface is identified in BIOS as the COM A interface.
- 5) At an ambient temperature of 25°C. Reducing the brightness by 50% can result in an approximately 50% increase in the half-brightness time.
- 6) Touch screen drivers for approved operating systems are available in the Downloads section of the B&R website.
- 7) The specified value applies to a nominal voltage of 24 VDC.
- 8) The specified value applies to a system unit with a CPU board but without an interface board.
- 9) The maximum ambient temperature is typically derated by 1°C per 1000 meters (starting at 500 meters above sea level).
- 10) There may be visible deviations in the color and surface appearance depending on the process or batch.

3.1.5.1.4 Dimensions

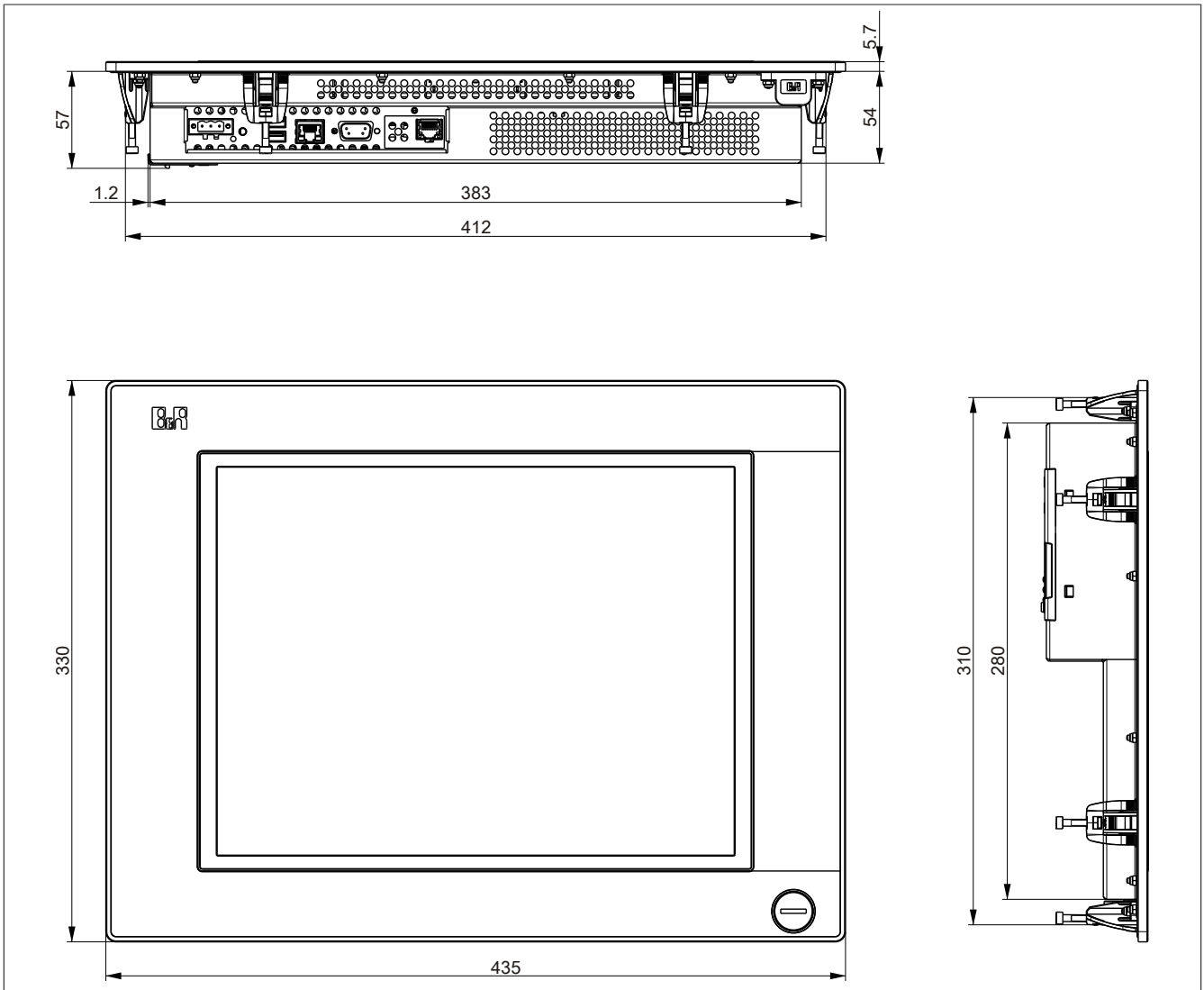

Figure 41: 5PP520.1505-00 - Dimensions

3.1.5.1.5 Cutout installation

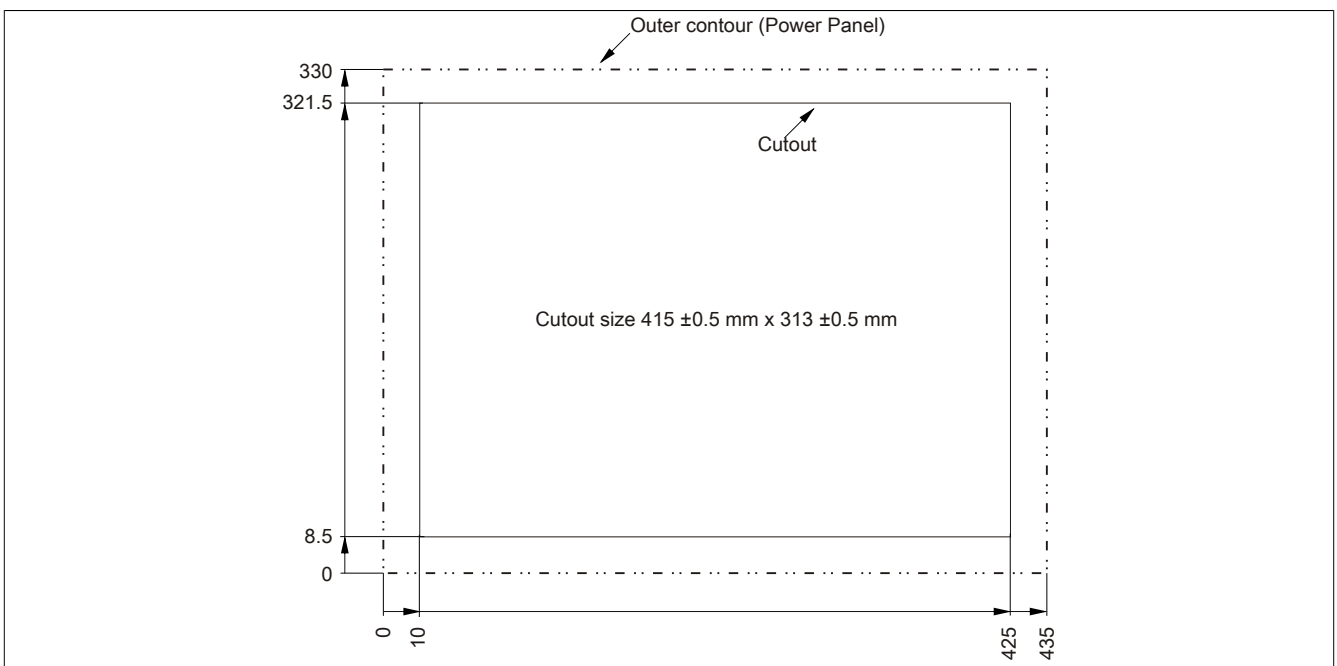

Figure 42: 5PP520.1505-00 - Cutout installation

3.1.5.1.6 Temperature humidity diagram

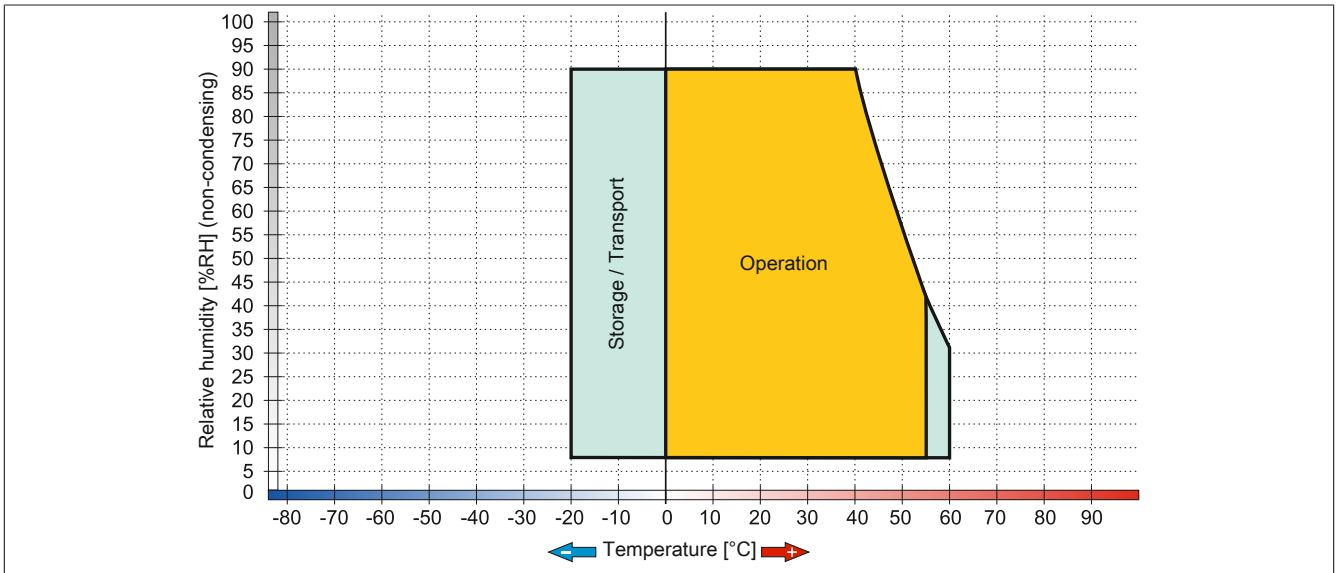

Figure 43: 5PP520.1505-00 - Temperature humidity diagram

3.1.5.2 5PP580.1505-00

3.1.5.2.1 General information

- 15" TFT XGA color display
- Analog resistive touch screen and function keys
- Intel® Atom™ technology
- Compact installation depth
- Fanless operation
- Can be upgraded with interface board

3.1.5.2.2 Order data

Model number	Short description	Figure
	System units	
5PP580.1505-00	Power Panel 580 15" XGA TFT display with touch screen (resistive); 32 function keys; connections for 1x RS232, 3x USB 2.0, 1x Ethernet 10/100/1000; can be expanded with interface board; IP65 protection (front); order male 24 VDC connector for supply voltage separately (screw clamp: 0TB103.9; cage clamp: 0TB103.91)	
	Required accessories	
	CPU boards	
5PP5CP.US15-00	CPU board Intel Atom Z510 1.1 GHz - Single core - US15W chipset	
5PP5CP.US15-01	CPU board Intel Atom Z520 1.33 GHz - Single core - US15W chipset	
5PP5CP.US15-02	CPU board Intel Atom Z530 1.6 GHz - Single core - US15W chipset	
	Main memory	
5MMDDR.0512-01	SO-DIMM DDR2 RAM 512 MB PC2-5300	
5MMDDR.1024-01	SO-DIMM DDR2 RAM 1024 MB PC2-5300	
5MMDDR.2048-01	SO-DIMM DDR2 RAM 2048 MB PC2-5300	
	Terminal blocks	
0TB103.9	Connector 24 VDC - 3-pin female - Screw clamps 3.31 mm ²	
0TB103.91	Connector 24 VDC - 3-pin female - Cage clamps 3.31 mm ²	
	Optional accessories	
	Batteries	
0AC201.91	Lithium batteries 4 pcs., 3 V / 950 mAh button cell We hereby state that the lithium cells contained in this shipment qualify as "partly regulated". Handle with care. If the package is damaged, inspect the cells, repack intact cells and protect cells against short circuits. For emergency information, call RENATA SA at + 41 61 319 28 27	
4A0006.00-000	Lithium battery, 3 V / 950 mAh, button cell	
	CompactFlash cards	
5CFCRD.016G-06	CompactFlash 16 GB B&R (SLC)	
5CFCRD.0512-06	CompactFlash 512 MB B&R (SLC)	
5CFCRD.1024-06	CompactFlash 1 GB B&R (SLC)	
5CFCRD.2048-06	CompactFlash 2 GB B&R (SLC)	
5CFCRD.4096-06	CompactFlash 4 GB B&R (SLC)	
5CFCRD.8192-06	CompactFlash 8 GB B&R (SLC)	
	Interface boards	
5PP5IF.CETH-00	Ethernet interface card - 1 Ethernet 10/100/1000	
5PP5IF.CHDA-00	Audio interface card - 1 HDA	
5PP5IF.FCAN-00	CAN interface card - 1 CAN master	
5PP5IF.FETH-00	Ethernet interface card - 1 Ethernet 10/100/1000 - 512 kB SRAM	
5PP5IF.FPLM-00	POWERLINK interface card - 2 POWERLINK managing nodes - 512 kB SRAM	
5PP5IF.FX2X-00	X2X Link interface card - 1 X2X Link master - 512 kB SRAM	
5PP5IF.FXCM-00	CAN interface card - 1 CAN master - 1 X2X master - 512 kB SRAM - Can be installed in PP500, APC510, APC511 systems	
	USB accessories	
5MMUSB.2048-01	USB 2.0 flash drive, 2048 MB, B&R	
5MMUSB.4096-01	USB 2.0 flash drive, 4096 MB, B&R	

Table 44: 5PP580.1505-00 - Order data

3.1.5.2.3 Technical data

Product ID	5PP580.1505-00	
Revision	C0	D0
General information		
Cooling	Fan-free	
LED status indicators	Power, CF, Link, Run	
B&R ID code	0xB607	
Battery	Renata 950 mAh	
Type	4 years ¹⁾	
Service life	Yes, accessible from the outside	
Removable	Lithium ion	
Design	Yes	
Power button	Yes	
Reset button	Yes	
Buzzer	Yes	
Certification	Yes	
CE	Yes	
cULus	Yes	
GOST-R	Yes	
Controller		
Boot loader	BIOS	
Mode/Node switches	2, 16 positions each (back)	
Watchdog	MTCX	
Power failure logic	MTCX ²⁾	
Controller	10 ms	
Buffer time	Intel® Graphics Media Accelerator 500	
Graphics	Controller	
Controller	DDR2 SDRAM	
Memory	Max. 2 GB	
Type		
Memory size		
Interfaces		
COM1 ³⁾	RS232, modem-capable, not electrically isolated	
Type	9-pin male DSUB connector	
Design	16550-compatible, 16-byte FIFO	
UART	115 kbit/s	
Max. baud rate		
CompactFlash slot 1	Type I	
Type	SD card	
SD memory card slot	Type	
Type	3	
USB	USB 2.0	
Quantity	Type A	
Type	Low speed (1.5 Mbit/s), full speed (12 Mbit/s), high speed (480 Mbit/s)	
Design	Max. 1 A per connection	
Transfer rate		
Current load		
Ethernet	1	
Quantity	Intel 82574	
Controller	Shielded RJ45 port	
Design	10/100/1000 Mbit/s	
Transfer rate		
Display		
Type	Color TFT	
Display size	15" (381 mm)	
Colors	16 million	
Resolution	XGA, 1024 x 768 pixels	
Contrast	700:1	
Viewing angles	Direction R = 80° / Direction L = 80°	
Horizontal	Direction U = 80° / Direction D = 60°	
Vertical	Direction U = 70° / Direction D = 70°	
Backlight	LED	
Type	Typ. 33 to 350 cd/m ²	
Brightness (dimnable)	50,000 h	
Half-brightness time ⁴⁾	Typ. 20 to 400 cd/m ²	
Touch screen ⁵⁾	AMT	
Type	Analog, resistive	
Technology	B&R, serial, 12-bit	
Controller	81% ±3%	
Transmittance		
Keys		
Function keys	32 with LED (yellow)	
System keys	No	
Service life	>1,000,000 actuations at 1 ±0.3N to 3 ±0.3 N actuating force	

Table 45: 5PP580.1505-00, 5PP580.1505-00 - Technical data

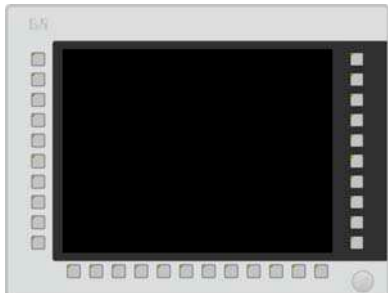
Technical data • Individual components

Product ID	5PP580.1505-00
LED brightness Yellow	Typ. 38 mcd
Inserts	
Interface board	Yes
I/O board	No
Electrical characteristics	
Nominal voltage	24 VDC ±25%
Nominal current	1.4 A ⁶⁾
Starting current	Typ. 3 A, max. 50 A for <300 µs
Power consumption	34 W ⁷⁾
Electrical isolation	Yes
Operating conditions	
EN 60529 protection	Back: IP20 (only with an inserted CF card, IF board or optional IF cover) Front: IP65, dust and sprayed water protection
Environmental conditions	
Temperature	
Operation	0 to 55°C
Storage	-20 to 60°C
Transport	-20 to 60°C
Relative humidity	
Operation	See temperature humidity diagram
Storage	See temperature humidity diagram
Transport	See temperature humidity diagram
Vibration	
Operation (continuous)	2 to 9 Hz: 1.75 mm amplitude / 9 to 200 Hz: 0.5 g
Operation (occasional)	2 to 9 Hz: 3.5 mm amplitude / 9 to 200 Hz: 1 g
Storage	2 to 8 Hz: 7.5 mm amplitude / 8 to 200 Hz: 2 g / 200 to 500 Hz: 4 g
Transport	2 to 8 Hz: 7.5 mm amplitude / 8 to 200 Hz: 2 g / 200 to 500 Hz: 4 g
Shock	
Operation	15 g, 11 ms
Storage	30 g, 6 ms
Transport	30 g, 6 ms
Elevation	
Operation	Max. 3000 m (component-dependent) ⁸⁾
Mechanical characteristics	
Housing	
Material	Galvanized steel plate
Front ⁹⁾	
Frame	Naturally anodized aluminum
Panel overlay	
Material	Polyester
Light background	RAL 9006
Dark gray border around display	RAL 7024
Gasket	Flat gasket around display front
Dimensions	
Width	435 mm
Height	330 mm
Depth	62.7 mm
Weight	4900 g

Table 45: 5PP580.1505-00, 5PP580.1505-00 - Technical data

- 1) At 50°C, 8.5 µA of the supplied components and a self-discharge of 40%. If an interface board with SRAM has been installed, the service life is 2½ years.
- 2) Maintenance Controller Extended.
- 3) The COM1 interface is identified in BIOS as the COM A interface.
- 4) At an ambient temperature of 25°C. Reducing the brightness by 50% can result in an approximately 50% increase in the half-brightness time.
- 5) Touch screen drivers for approved operating systems are available in the Downloads section of the B&R website.
- 6) The specified value applies to a nominal voltage of 24 VDC.
- 7) The specified value applies to a system unit with a CPU board but without an interface board.
- 8) The maximum ambient temperature is typically derated by 1°C per 1000 meters (starting at 500 meters above sea level).
- 9) There may be visible deviations in the color and surface appearance depending on the process or batch.

3.1.5.2.4 Dimensions

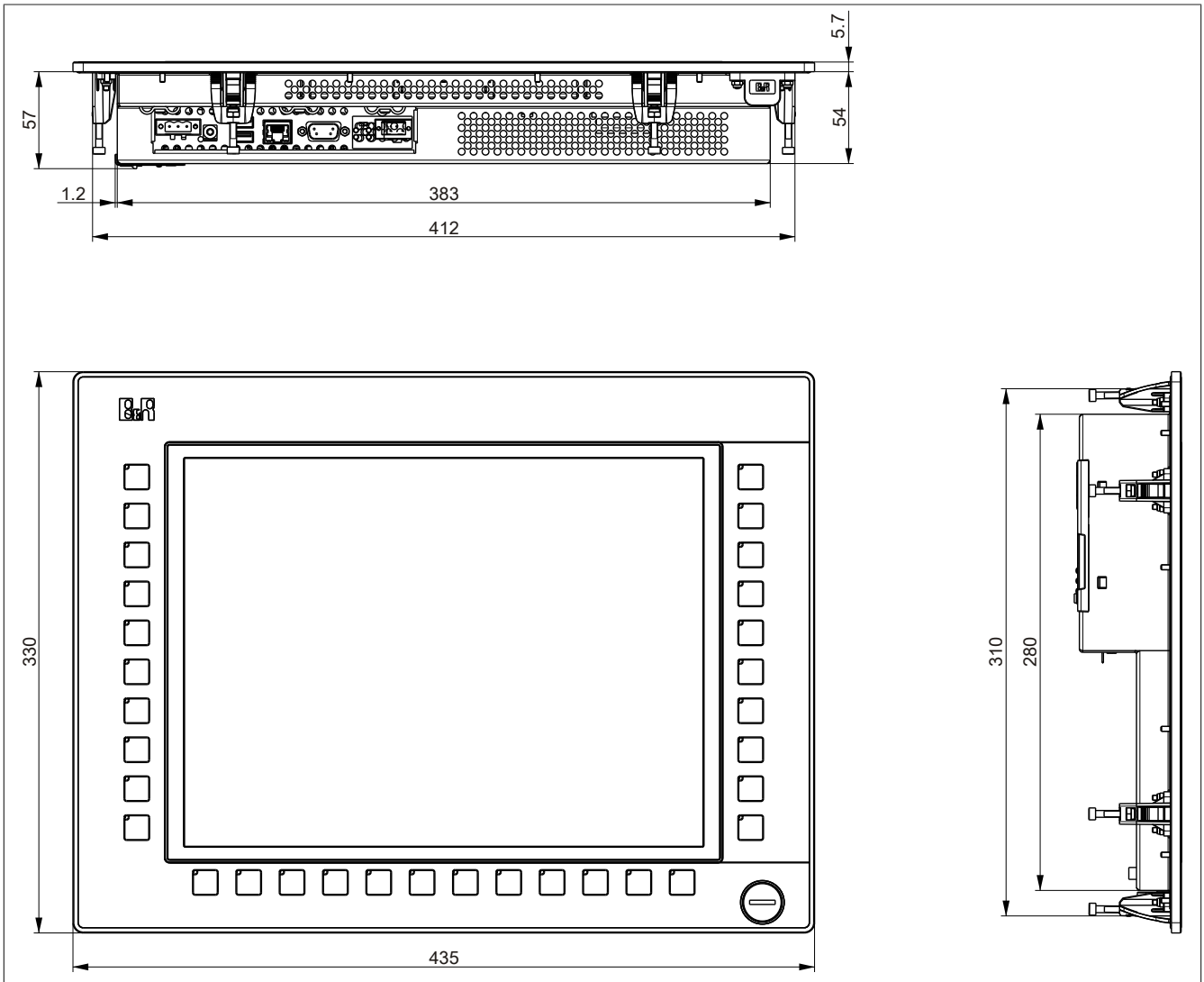

Figure 44: 5PP580.1505-00 - Dimensions

3.1.5.2.5 Cutout installation

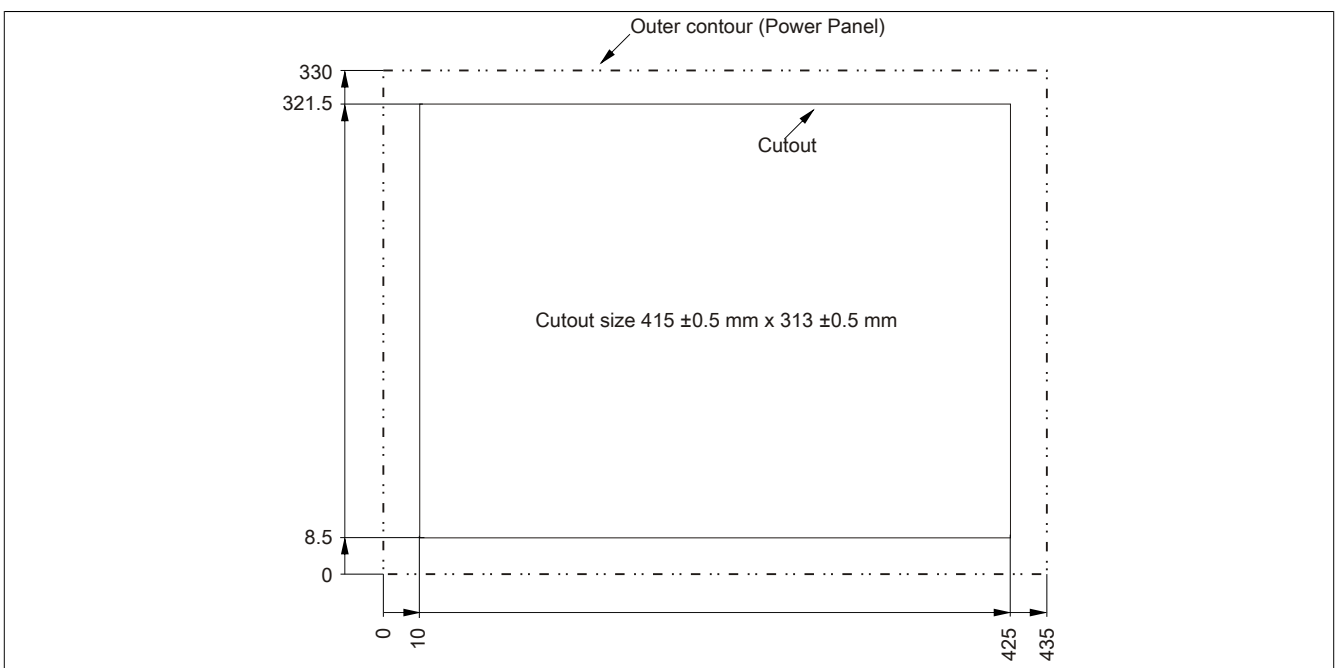

Figure 45: 5PP580.1505-00 - Cutout installation

3.1.5.2.6 Temperature humidity diagram

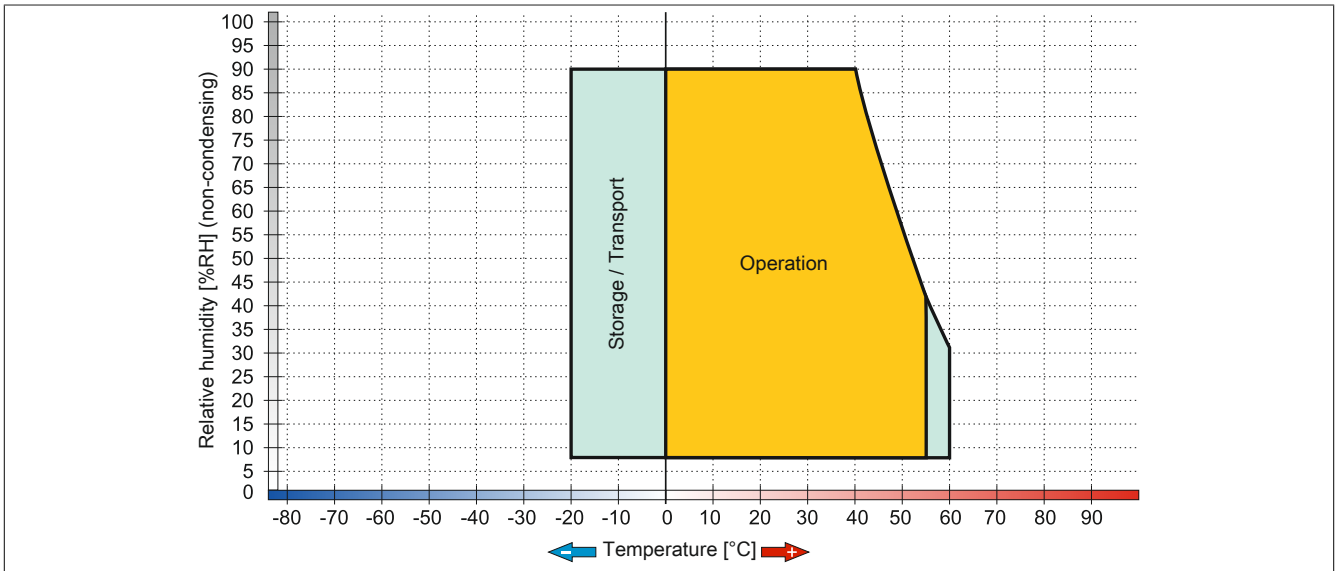

Figure 46: 5PP580.1505-00 - Temperature humidity diagram

3.1.5.3 5PP581.1505-00

3.1.5.3.1 General information

- 15" TFT XGA color display
- Analog resistive touch screen plus function and system keys
- Intel® Atom™ technology
- Compact installation depth
- Fanless operation
- Can be upgraded with interface board

3.1.5.3.2 Order data

Model number	Short description	Figure
System units		
5PP581.1505-00	Power Panel 581 15" XGA TFT display with touch screen (resistive); 32 function keys and 92 system keys; connections for 1x RS232, 3x USB 2.0, 1x Ethernet 10/100/1000; can be expanded with interface board; IP65 protection (front); order male 24 VDC connector for supply voltage separately (screw clamp: 0TB103.9; cage clamp: 0TB103.91)	
Required accessories		
CPU boards		
5PP5CP.US15-00	CPU board Intel Atom Z510 1.1 GHz - Single core - US15W chipset	
5PP5CP.US15-01	CPU board Intel Atom Z520 1.33 GHz - Single core - US15W chipset	
5PP5CP.US15-02	CPU board Intel Atom Z530 1.6 GHz - Single core - US15W chipset	
Main memory		
5MMDDR.0512-01	SO-DIMM DDR2 RAM 512 MB PC2-5300	
5MMDDR.1024-01	SO-DIMM DDR2 RAM 1024 MB PC2-5300	
5MMDDR.2048-01	SO-DIMM DDR2 RAM 2048 MB PC2-5300	
Terminal blocks		
0TB103.9	Connector 24 VDC - 3-pin female - Screw clamps 3.31 mm ²	
0TB103.91	Connector 24 VDC - 3-pin female - Cage clamps 3.31 mm ²	
Optional accessories		
Batteries		
0AC201.91	Lithium batteries 4 pcs., 3 V / 950 mAh button cell We hereby state that the lithium cells contained in this shipment qualify as "partly regulated". Handle with care. If the package is damaged, inspect the cells, repack intact cells and protect cells against short circuits. For emergency information, call RENATA SA at + 41 61 319 28 27	
4A0006.00-000	Lithium battery, 3 V / 950 mAh, button cell	
CompactFlash cards		
5CFCRD.016G-06	CompactFlash 16 GB B&R (SLC)	
5CFCRD.0512-06	CompactFlash 512 MB B&R (SLC)	
5CFCRD.1024-06	CompactFlash 1 GB B&R (SLC)	
5CFCRD.2048-06	CompactFlash 2 GB B&R (SLC)	
5CFCRD.4096-06	CompactFlash 4 GB B&R (SLC)	
5CFCRD.8192-06	CompactFlash 8 GB B&R (SLC)	
Interface boards		
5PP5IF.CETH-00	Ethernet interface card - 1 Ethernet 10/100/1000	
5PP5IF.CHDA-00	Audio interface card - 1 HDA	
5PP5IF.FCAN-00	CAN interface card - 1 CAN master	
5PP5IF.FETH-00	Ethernet interface card - 1 Ethernet 10/100/1000 - 512 kB SRAM	
5PP5IF.FPLM-00	POWERLINK interface card - 2 POWERLINK managing nodes - 512 kB SRAM	
5PP5IF.FX2X-00	X2X Link interface card - 1 X2X Link master - 512 kB SRAM	
5PP5IF.FXCM-00	CAN interface card - 1 CAN master - 1 X2X master - 512 kB SRAM - Can be installed in PP500, APC510, APC511 systems	
USB accessories		
5MMUSB.2048-01	USB 2.0 flash drive, 2048 MB, B&R	
5MMUSB.4096-01	USB 2.0 flash drive, 4096 MB, B&R	

Table 46: 5PP581.1505-00 - Order data

3.1.5.3.3 Technical data

Product ID	5PP581.1505-00	
Revision	C0	D0
General information		
Cooling	Fan-free	
LED status indicators	Power, CF, Link, Run	
B&R ID code	0xB60A	
Battery	Renata 950 mAh	
Type	4 years ¹⁾	
Service life	Yes, accessible from the outside	
Removable	Lithium ion	
Design		
Power button	Yes	
Reset button	Yes	
Buzzer	Yes	
Certification		
CE	Yes	
cULus	Yes	
GOST-R	Yes	
Controller		
Boot loader	BIOS	
Mode/Node switches	2, 16 positions each (back)	
Watchdog	MTCX	
Power failure logic		
Controller	MTCX ²⁾	
Buffer time	10 ms	
Graphics		
Controller	Intel® Graphics Media Accelerator 500	
Memory		
Type	DDR2 SDRAM	
Memory size	Max. 2 GB	
Interfaces		
COM1 ³⁾	RS232, modem-capable, not electrically isolated	
Type	9-pin male DSUB connector	
Design	16550-compatible, 16-byte FIFO	
UART	115 kbit/s	
Max. baud rate		
CompactFlash slot 1		
Type	Type I	
SD memory card slot		
Type	SD card	
USB		
Quantity	3	
Type	USB 2.0	
Design	Type A	
Transfer rate	Low speed (1.5 Mbit/s), full speed (12 Mbit/s), high speed (480 Mbit/s)	
Current load	Max. 1 A per connection	
Ethernet		
Quantity	1	
Controller	Intel 82574	
Design	Shielded RJ45 port	
Transfer rate	10/100/1000 Mbit/s	
Display		
Type	Color TFT	
Display size	15" (381 mm)	
Colors	16 million	
Resolution	XGA, 1024 x 768 pixels	
Contrast	700:1	
Viewing angles		
Horizontal	Direction R = 80° / Direction L = 80°	
Vertical	Direction U = 80° / Direction D = 60° Direction U = 70° / Direction D = 70°	
Backlight		
Type	LED	
Brightness (dimnable)	Typ. 33 to 350 cd/m ²	Typ. 20 to 400 cd/m ²
Half-brightness time ⁴⁾	50,000 h	
Touch screen ⁵⁾		
Type	AMT	
Technology	Analog, resistive	
Controller	B&R, serial, 12-bit	
Transmittance	81% ±3%	
Keys		
Function keys	32 with LED (yellow)	
System keys	Alphanumeric keys, numeric keys, cursor block	
Service life	>1,000,000 actuations at 1 ±0.3N to 3 ±0.3 N actuating force	

Table 47: 5PP581.1505-00, 5PP581.1505-00 - Technical data

Product ID	5PP581.1505-00
LED brightness Yellow	Typ. 38 mcd
Inserts	
Interface board	Yes
I/O board	No
Electrical characteristics	
Nominal voltage	24 VDC ±25%
Nominal current	1.4 A ⁶⁾
Starting current	Typ. 3 A, max. 50 A for <300 µs
Power consumption	34 W ⁷⁾
Electrical isolation	Yes
Operating conditions	
EN 60529 protection	Back: IP20 (only with an inserted CF card, IF board or optional IF cover) Front: IP65, dust and sprayed water protection
Environmental conditions	
Temperature	
Operation	0 to 55°C
Storage	-20 to 60°C
Transport	-20 to 60°C
Relative humidity	
Operation	See temperature humidity diagram
Storage	See temperature humidity diagram
Transport	See temperature humidity diagram
Vibration	
Operation (continuous)	2 to 9 Hz: 1.75 mm amplitude / 9 to 200 Hz: 0.5 g
Operation (occasional)	2 to 9 Hz: 3.5 mm amplitude / 9 to 200 Hz: 1 g
Storage	2 to 8 Hz: 7.5 mm amplitude / 8 to 200 Hz: 2 g / 200 to 500 Hz: 4 g
Transport	2 to 8 Hz: 7.5 mm amplitude / 8 to 200 Hz: 2 g / 200 to 500 Hz: 4 g
Shock	
Operation	15 g, 11 ms
Storage	30 g, 6 ms
Transport	30 g, 6 ms
Elevation	
Operation	Max. 3000 m (component-dependent) ⁸⁾
Mechanical characteristics	
Housing	
Material	Galvanized steel plate
Front ⁹⁾	
Frame	Naturally anodized aluminum
Panel overlay	
Material	Polyester
Light background	RAL 9006
Dark gray border around display	RAL 7024
Gasket	Flat gasket around display front
Dimensions	
Width	435 mm
Height	430 mm
Depth	62.7 mm
Weight	5800 g

Table 47: 5PP581.1505-00, 5PP581.1505-00 - Technical data

- 1) At 50°C, 8.5 µA of the supplied components and a self-discharge of 40%. If an interface board with SRAM has been installed, the service life is 2½ years.
- 2) Maintenance Controller Extended.
- 3) The COM1 interface is identified in BIOS as the COM A interface.
- 4) At an ambient temperature of 25°C. Reducing the brightness by 50% can result in an approximately 50% increase in the half-brightness time.
- 5) Touch screen drivers for approved operating systems are available in the Downloads section of the B&R website.
- 6) The specified value applies to a nominal voltage of 24 VDC.
- 7) The specified value applies to a system unit with a CPU board but without an interface board.
- 8) The maximum ambient temperature is typically derated by 1°C per 1000 meters (starting at 500 meters above sea level).
- 9) There may be visible deviations in the color and surface appearance depending on the process or batch.

3.1.5.3.4 Dimensions

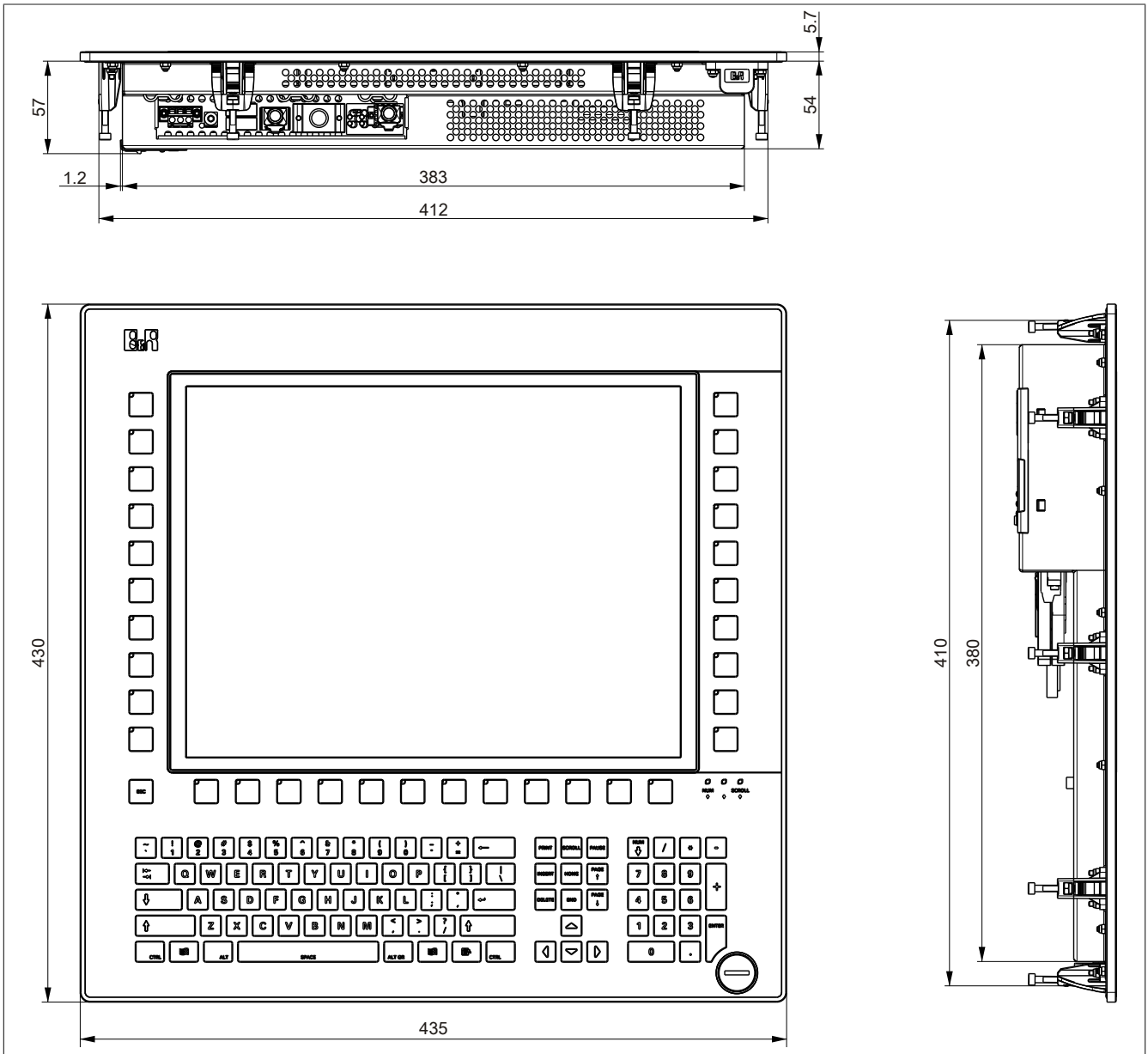

Figure 47: 5PP581.1505-00 - Dimensions

3.1.5.3.5 Cutout installation

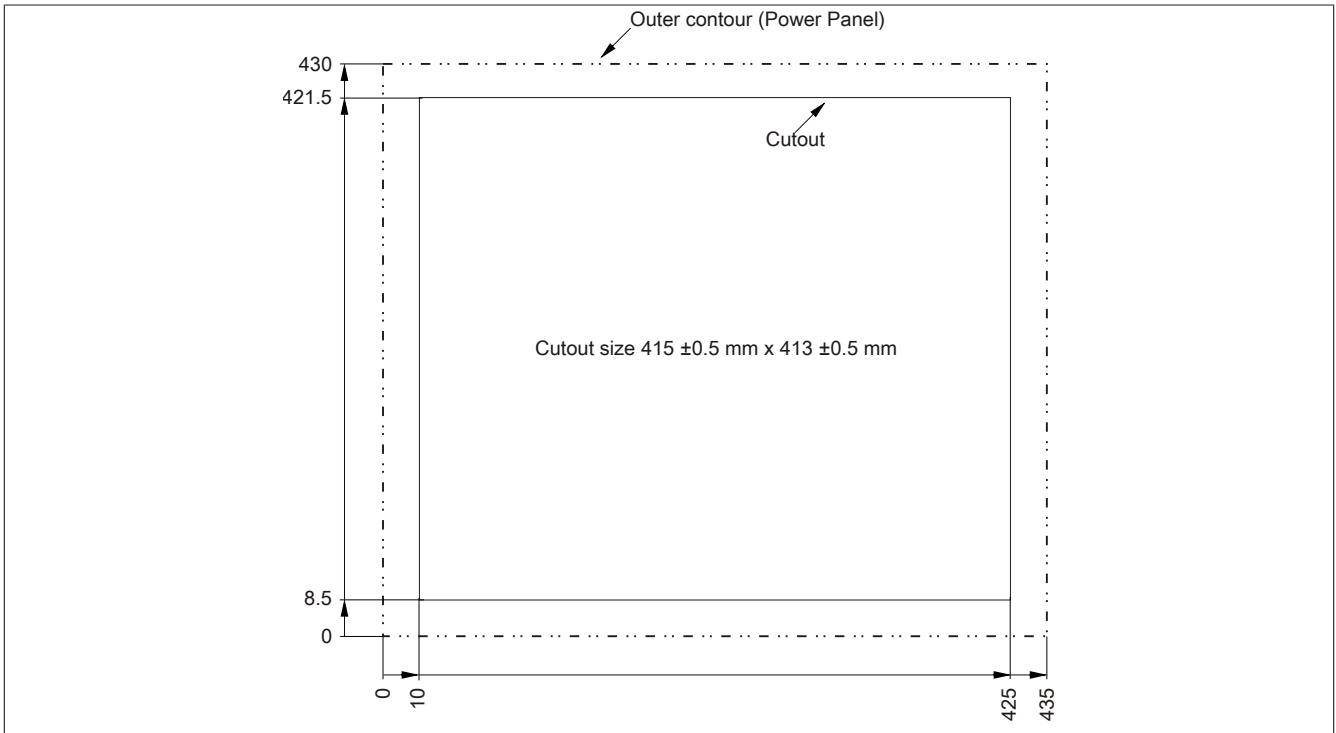

Figure 48: 5PP581.1505-00 - Cutout installation

3.1.5.3.6 Temperature humidity diagram

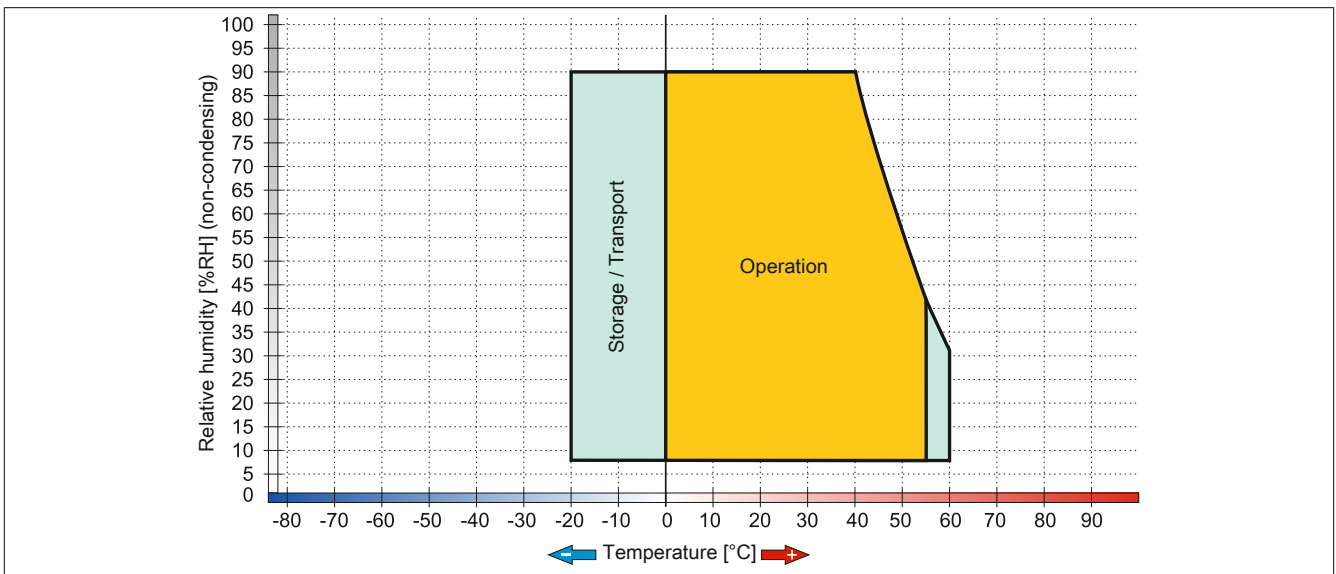

Figure 49: 5PP581.1505-00 - Temperature humidity diagram

3.2 US15W CPU boards

3.2.1 General information

These CPU boards are based on the Intel® US15W chipset and contain one DDR2 memory slot for a maximum of 2 GB. In addition, the Intel® GMA 500 with 128 MB memory is also integrated.

- Intel® Atom™ technology
- Intel® US15W chipset
- 1x DDR2 memory slot
- Intel® GMA 500
- Insyde BIOS

3.2.2 Order data

Model number	Short description	Figure
CPU boards		
5PP5CP.US15-00	CPU board Intel Atom Z510 1.1 GHz - Single core - US15W chipset	
5PP5CP.US15-01	CPU board Intel Atom Z520 1.33 GHz - Single core - US15W chipset	
5PP5CP.US15-02	CPU board Intel Atom Z530 1.6 GHz - Single core - US15W chipset	
Required accessories		
Main memory		
5MMDDR.0512-01	SO-DIMM DDR2 RAM 512 MB PC2-5300	
5MMDDR.1024-01	SO-DIMM DDR2 RAM 1024 MB PC2-5300	
5MMDDR.2048-01	SO-DIMM DDR2 RAM 2048 MB PC2-5300	

Table 48: 5PP5CP.US15-00, 5PP5CP.US15-01, 5PP5CP.US15-02 - Order data

3.2.3 Technical data

Product ID	5PP5CP.US15-00	5PP5CP.US15-01	5PP5CP.US15-02
General information			
Certification			
CE		Yes	
cULus		Yes	
GOST-R		Yes	
GL		Yes ¹⁾	
Controller			
Boot loader	BIOS Insyde		
Processor			
Type	Intel® Atom™ Z510PT	Intel® Atom™ Z520PT	Intel® Atom™ Z530P
Clock frequency	1100 MHz	1330 MHz	1600 MHz
Number of cores		1	
Architecture		45 nm	
L1 cache		32 kB	
L2 cache		512 kB	
External bus	400 MHz	533 MHz	533 MHz
Intel® 64 Architecture		No	
Intel® Hyper-Threading Technology		Yes	
Intel® Virtualization Technology (VT-x)	No	Yes	Yes
Enhanced Intel SpeedStep® Technology		Yes	
Expanded command set		SSE2, SSE3, SSSE3	
Chipset	Intel® US15WPT	Intel® US15WPT	Intel® US15WP
Real-time clock			
Precision	At 25°C: typ. 12 ppm (1 seconds) per day ²⁾		
Battery-backed	Yes		
Memory slot			
Number of memory channels	1		
Type	DDR2		
Memory size	Max. 2 GB		

Table 49: 5PP5CP.US15-00, 5PP5CP.US15-01, 5PP5CP.US15-02 - Technical data

Product ID	5PP5CP.US15-00	5PP5CP.US15-01	5PP5CP.US15-02
Graphics	Intel® Graphics Media Accelerator 500 Up to 256 MB ³⁾ Max. 32-bit Depends on the system unit used ⁴⁾		
Controller			
Memory			
Color depth			
Resolution			
Power management	ACPI 3.0		

Table 49: 5PP5CP.US15-00, 5PP5CP.US15-01, 5PP5CP.US15-02 - Technical data

- 1) Yes, although applies only if all components installed within the complete system have this certification
- 2) At 50 °C, 8.5 µA of the supplied components and a self discharge of 40 %.
- 3) Allocated in main memory.
- 4) For PP500: The maximum resolution is determined automatically by the selection of the PP500 system unit.

3.3 Main memory

3.3.1 Order data

Model number	Short description	Figure
	Main memory	
5MMDDR.0512-01	SO-DIMM DDR2 RAM 512 MB PC2-5300	
5MMDDR.1024-01	SO-DIMM DDR2 RAM 1024 MB PC2-5300	
5MMDDR.2048-01	SO-DIMM DDR2 RAM 2048 MB PC2-5300	

Table 50: 5MMDDR.0512-01, 5MMDDR.1024-01, 5MMDDR.2048-01 - Order data

3.3.2 Technical data

Product ID	5MMDDR.0512-01	5MMDDR.1024-01	5MMDDR.2048-01
General information			
Certification			
CE		Yes	
cULus		Yes	
GOST-R		Yes	
GL		Yes ¹⁾	
Controller			
Memory			
Type		SO-DIMM DDR2 SDRAM	
Memory size	512 MB	1 GB	2 GB
Construction		200-pin	
Organization	64M x 64-bit	128M x 64-bit	256M x 64-bit
Speed		DDR2-667 (PC2-5300)	

Table 51: 5MMDDR.0512-01, 5MMDDR.1024-01, 5MMDDR.2048-01 - Technical data

1) Yes, although applies only if all components installed within the complete system have this certification

Information:

A main memory module can only be replaced at B&R.

3.4 Interface boards

Information:

Interface boards can **ONLY** be installed and replaced by B&R.

3.4.1 5PP5IF.CETH-00

3.4.1.1 General information

The interface board 5PP5IF.CETH-00 has a 10/100/1000 Mbit/sec network connection, 512 kB SRAM and can be used as an additional network interface in a Power Panel 500, Automation PC 510 or Automation PC 511.

- 1 network connection (10/100/1000 Mbit/s)
- Compatible with the PP500, APC511 and APC511

This interface board can be operated with Automation Runtime beginning with Automation Studio 3.0.90.18 and Automation Runtime D4.01.

3.4.1.2 Order data

Model number	Short description	Figure
Interface boards		
5PP5IF.CETH-00	Ethernet interface card - 1 Ethernet 10/100/1000	

Table 52: 5PP5IF.CETH-00 - Order data

3.4.1.3 Technical data

Product ID	5PP5IF.CETH-00
General information	
B&R ID code	0xB4D5
Diagnostics	
Data transfer	Yes, using status LED
Certification	
CE	Yes
cULus	Yes
GOST-R	Yes
GL	Yes ¹⁾
Interfaces	
Ethernet	
Quantity	1
Controller	Intel 82574
Design	Shielded RJ45 port
Transfer rate	10/100/1000 Mbit/s
Cable length	Max. 100 m between two stations (segment length)
Electrical characteristics	
Power consumption	2 W
Environmental conditions	
Temperature	
Operation	0 to 55°C
Storage	-20 to 60°C
Transport	-20 to 60°C
Relative humidity	
Operation	5 to 90%, non-condensing
Storage	5 to 95%, non-condensing
Transport	5 to 95%, non-condensing

Table 53: 5PP5IF.CETH-00 - Technical data

1) Yes, although applies only if all components installed within the complete system have this certification

3.4.1.3.1 Ethernet interface (ETH)

Ethernet connection ¹⁾		
Controller	Intel 82574	
Cabling	S/STP (Cat 5e)	
Transfer rate	10/100/1000 Mbit/s ¹⁾	
Cable length	Max. 100 m (min. Cat 5e)	
Speed LED	On	Off
Green	100 Mbit/s	10 Mbit/s ²⁾
Orange	1000 Mbit/s	-
Link LED	On	Off
Orange	Link (Ethernet network connection available)	Activity (blinking - data transfer in progress)

Female RJ45 connector

1

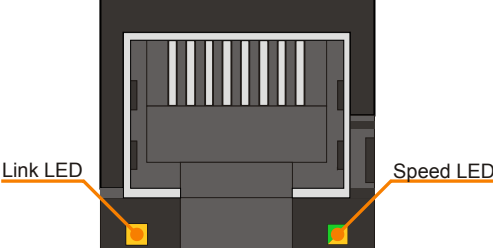

Table 54: 5PP5IF.CETH-00 - Ethernet interface

- 1) The interfaces, etc. available on the device or module have been numbered as such for easy identification. This numbering may differ from that used by the particular operating system.
- 2) Switching takes place automatically.
- 3) The 10 Mbit/s transfer speed / connection is only present if the IF slot Link LED is also lit at the same time.

A special driver is required in order to operate the Intel 82574 Ethernet controller. Drivers for approved operating systems are available in the Downloads section of the B&R website (www.br-automation.com).

Information:

Required drivers can only be downloaded from the B&R website, not from manufacturer websites.

3.4.2 5PP5IF.CHDA-00

3.4.2.1 General information

The 5PP5IF.CHDA-00 interface board has an HDA sound chip with externally accessible MIC, Line IN and Line OUT channels.

- 1x MIC
- 1x Line IN
- 1x Line OUT
- Compatible with the PP500, APC511 and APC511

This interface board can be operated with Automation Runtime beginning with Automation Studio 3.0.90.18 and Automation Runtime A4.01.

3.4.2.2 Order data

Model number	Short description	Figure
5PP5IF.CHDA-00	Audio interface card - 1 HDA	

Table 55: 5PP5IF.CHDA-00 - Order data

3.4.2.3 Technical data

Product ID	5PP5IF.CHDA-00
General information	
B&R ID code	0xB4D6
Certification	
CE	Yes
cULus	Yes
GOST-R	Yes
Interfaces	
Audio	
Type	HDA sound
Controller	Realtek ALC 662
Inputs	Microphone, Line IN
Outputs	Line OUT
Electrical characteristics	
Power consumption	2 W
Environmental conditions	
Temperature	
Operation	0 to 55°C
Storage	-20 to 60°C
Transport	-20 to 60°C
Relative humidity	
Operation	5 to 90%, non-condensing
Storage	5 to 95%, non-condensing
Transport	5 to 95%, non-condensing

Table 56: 5PP5IF.CHDA-00 - Technical data

3.4.2.3.1 MIC, Line IN, Line OUT

MIC, Line IN, Line OUT		
Controller	Realtek ALC 662	
MIC	Connection of a mono microphone with a 3.5 mm jack	
Line IN	Stereo Line IN signal supplied via a 3.5 mm jack	
Line OUT	Connection of a stereo playback device (e.g. amplifier) via a 3.5 mm jack	

Table 57: MIC, Line IN, Line OUT

A special driver is required in order to operate the audio controller. Drivers for approved operating systems are available in the Downloads section of the B&R website (www.br-automation.com).

Information:

Required drivers can only be downloaded from the B&R website, not from manufacturer websites.

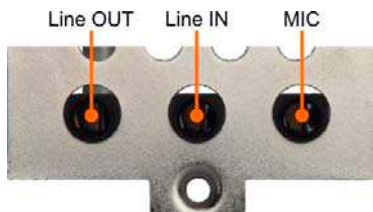
3.4.3 5PP5IF.FETH-00

3.4.3.1 General information

The interface board 5PP5IF.FETH-00 has a 10/100/1000 Mbit/sec network connection, 512 kB SRAM and can be used as an additional network interface in a Power Panel 500, Automation PC 510 or Automation PC 511.

- 1 network connection (10/100/1000 Mbit/s)
- 512 kB SRAM
- Compatible with the PP500, APC511 and APC511

This interface board can only be operated with Automation Runtime (beginning with Automation Studio 3.0.90.18 and Automation Runtime D4.01).

3.4.3.2 Order data

Model number	Short description	Figure
	Interface boards	
5PP5IF.FETH-00	Ethernet interface card - 1 Ethernet 10/100/1000 - 512 kB SRAM	

Table 58: 5PP5IF.FETH-00 - Order data

3.4.3.3 Technical data

Product ID	5PP5IF.FETH-00
General information	
B&R ID code	0xB7C4
Diagnostics	
Data transfer	Yes, using status LED
Certification	
CE	Yes
cULus	Yes
GOST-R	Yes
GL	Yes ¹⁾
Controller	
SRAM	
Value	512 kB
Battery-backed	Yes
Remanent variables in power failure mode	256 kB (e.g. for Automation Runtime, see AS help system) ²⁾
Interfaces	
Ethernet	
Quantity	1
Controller	Intel 82574
Design	Shielded RJ45 port
Transfer rate	10/100/1000 Mbit/s
Cable length	Max. 100 m between two stations (segment length)
Electrical characteristics	
Power consumption	4 W
Environmental conditions	
Temperature	
Operation	0 to 50°C
Storage	-20 to 60°C
Transport	-20 to 60°C
Relative humidity	
Operation	5 to 90%, non-condensing
Storage	5 to 95%, non-condensing
Transport	5 to 95%, non-condensing

Table 59: 5PP5IF.FETH-00 - Technical data

- 1) Yes, although applies only if all components installed within the complete system have this certification.
 2) With optimized access using write combining

3.4.3.3.1 Ethernet interface (ETH)

Ethernet connection ¹⁾		
Controller	Intel 82574	
Cabling	S/STP (Cat 5e)	
Transfer rate	10/100/1000 Mbit/s ¹⁾	
Cable length	Max. 100 m (min. Cat 5e)	
Speed LED	On	Off
Green	100 Mbit/s	10 Mbit/s ²⁾
Orange	1000 Mbit/s	-
Link LED	On	Off
Orange	Link (Ethernet network connection available)	Activity (blinking - data transfer in progress)

Female RJ45 connector

1

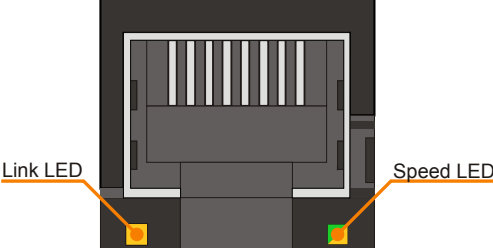

Table 60: 5PP51F.FETH-00 - Ethernet interface

- 1) The interfaces, etc. available on the device or module have been numbered as such for easy identification. This numbering may differ from that used by the particular operating system.
- 2) Switching takes place automatically.
- 3) The 10 Mbit/s transfer speed / connection is only present if the IF slot Link LED is also lit at the same time.

A special driver is required in order to operate the Intel 82574 Ethernet controller. Drivers for approved operating systems are available in the Downloads section of the B&R website (www.br-automation.com).

Information:

Required drivers can only be downloaded from the B&R website, not from manufacturer websites.

3.4.4 5PP5IF.FPLM-00

3.4.4.1 General information

The 5PP5IF.FPLM-00 interface board has two POWERLINK connections and 512 kB SRAM.

This integrated hub allows for the easiest possible implementation of a simple tree structure or optional ring redundancy without extra effort.

With pollresponse chaining (PRC), the module offers a solution for the highest demands on response time and the shortest cycle times. When combined with the B&R control system, poll-response chaining provides ideal performance, particularly for central control tasks.

- 2x POWERLINK connections
- 512 kB SRAM
- Integrated hub for efficient cabling
- Configurable ring redundancy
- Poll response chaining
- Compatible with the PP500, APC511 and APC511

This interface board can only be operated with Automation Runtime.

Information:

Ring redundancy and simultaneous poll-response chaining operation is not possible with this IF board.

3.4.4.2 Order data

Model number	Short description	Figure
	Interface boards	
5PP5IF.FPLM-00	POWERLINK interface card - 2 POWERLINK managing nodes - 512 kB SRAM	

Table 61: 5PP5IF.FPLM-00 - Order data

3.4.4.3 Technical data

Product ID	5PP5IF.FPLM-00
General information	
B&R ID code	0xB4D8
Diagnostics	
Data transfer	Yes, using status LED
Certification	
CE	Yes
cULus	Yes
GOST-R	Yes
GL	Yes ¹⁾
Controller	
SRAM	
Value	512 kB
Battery-backed	Yes
Remanent variables in power failure mode	256 kB (e.g. for Automation Runtime, see AS help system) ²⁾
Interfaces	
POWERLINK	
Quantity	2
Transmission	100 Base-T (ANSI/IEEE 802.3)
Type	POWERLINK (V1/V2)
Design	2x shielded RJ45 port (hub)
Transfer rate	100 Mbit/s
Cable length	Max. 100 m between two stations (segment length)
Electrical characteristics	
Power consumption	3 W

Table 62: 5PP5IF.FPLM-00 - Technical data

Product ID	5PP5IF.FPLM-00
Environmental conditions	
Temperature	
Operation	0 to 55°C
Storage	-20 to 60°C
Transport	-20 to 60°C
Relative humidity	
Operation	5 to 90%, non-condensing
Storage	5 to 95%, non-condensing
Transport	5 to 95%, non-condensing

Table 62: 5PP5IF.FPLM-00 - Technical data

- 1) Yes, although applies only if all components installed within the complete system have this certification.
- 2) With optimized access using write combining

3.4.4.3.1 POWERLINK interface

POWERLINK		
Cabling	S/STP (Cat 5e)	
Cable length	Max. 100 m (min. Cat 5e)	
Speed LED	On	Off
Green/Red	see Status / Error LED	
Link LED	On	Off
Yellow	Link (POWERLINK network connection available)	Activity (blinking - data transfer in progress)

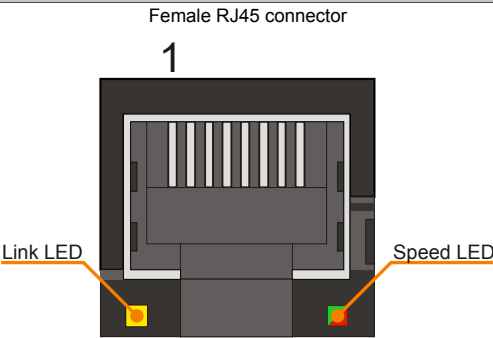

Table 63: 5PP5IF.FPLM-00 - POWERLINK interface

3.4.4.3.2 Status/Error LED

The Status/Error LED is a green and red dual LED. The LED status can have different meanings depending on the operating mode.

Ethernet mode

In this mode, the interface is operated as an Ethernet interface.

Green - Status	Description
On	Interface being operated as an Ethernet interface

Table 64: Status/Error LED - Ethernet mode

POWERLINK V1

LED status indicators		Status of the POWERLINK station
Green	Red	
On	Off	The POWERLINK station is running with no errors.
Off	On	A fatal system error has occurred. The error type can be read using the PLC logbook. An irreparable problem has occurred. The system cannot properly carry out its tasks. This state can only be changed by resetting the module.
Blinking alternately		The POWERLINK managing node has failed. This error code can only occur when operated as a controlled node.
Off	Blinking	System failure. The red blinking LED signals a certain type of error using a blink code (see section "System stop error codes" on page 114).

Table 65: Status/Error LED - POWERLINK V1 operating mode

POWERLINK

Red - Error	Description
On	<p>The interface is in an error state (failed Ethernet frames, increased number of collisions on the network, etc.). If an error occurs in the following states, then the green LED blinks over the red LED:</p> <ul style="list-style-type: none"> • BASIC_ETHERNET • PRE_OPERATIONAL_1 • PRE_OPERATIONAL_2 • READY_TO_OPERATE

Table 66: Status/Error LED - POWERLINK - Error

Green - Status	Description
Off NOT_ACTIVE	<p>State The interface is in the NOT_ACTIVE state or:</p> <ul style="list-style-type: none"> • Switched off • Starting up • Not configured correctly in Automation Studio • Defective <p>Managing node (MN) The bus is being monitored for POWERLINK frames. If a frame is not received within the configured time window (timeout), the interface switches immediately to PRE_OPERATIONAL_1 mode (single flash). If POWERLINK communication is detected before the time expires, however, then the MN will not be started.</p> <p>Controlled node (CN) The bus is being monitored for POWERLINK frames. If a corresponding frame is not received within the defined time frame (timeout), then the module switches immediately to BASIC_ETHERNET mode (flickering). If POWERLINK communication is detected before this time expires, however, the interface switches immediately to PRE_OPERATIONAL_1 mode (single flash).</p>
Green flickering (approx. 10 Hz) BASIC_ETHERNET	<p>State The interface is in the BASIC_ETHERNET state and being operated as an Ethernet TCP/IP interface.</p> <p>Managing node (MN) This state can only be exited by resetting the interface.</p> <p>Controlled node (CN) If POWERLINK communication is detected while in this state, the interface switches to the PRE_OPERATIONAL_1 state (single flash).</p>
Single flash (approx. 1 Hz) PRE_OPERATIONAL_1	<p>State The interface status is in the PRE_OPERATIONAL_1 state.</p> <p>Managing node (MN) The MN starts "reduced cycle" operation. Cyclic communication is not yet taking place.</p> <p>Controlled node (CN) The module can be configured by the MN in this state. The CN waits until it receives an SoC frame and then switches to the PRE_OPERATIONAL_2 state (double flash). An LED lit red in this state indicates failure of the MN.</p>

Table 67: Status/Error LED - POWERLINK - Status

Green - Status	Description
Double flash (approx. 1 Hz) PRE_OPERATIONAL_2	<p>State The interface is in the PRE_OPERATIONAL_2 state.</p> <p>Managing node (MN) The MN begins cyclic communication (cyclic input data is not yet being evaluated). The CNs are configured in this state.</p> <p>Controlled node (CN) The interface can be configured by the MN in this state. A command then switches the state to READY_TO_OPERATE (triple flash). An LED lit red in this mode indicates failure of the MN.</p>
Triple flash (approx. 1 Hz) READY_TO_OPERATE	<p>State The interface is in the READY_TO_OPERATE state.</p> <p>Managing node (MN) Cyclic and asynchronous communication is taking place. Any received PDO data is ignored.</p> <p>Controlled node (CN) The configuration of the module is completed. Normal cyclic and asynchronous communication is taking place. The PDO data being sent corresponds to the PDO mapping. Cyclic data is not yet being evaluated, however. An LED lit red in this mode indicates failure of the MN.</p>
On OPERATIONAL	<p>State The interface is in the OPERATIONAL state. PDO mapping is active and cyclic data is being evaluated.</p>
Blinking (approx. 2.5 Hz) STOPPED	<p>State The interface is in the STOPPED state.</p> <p>Managing node (MN) This status is not possible for the MN.</p> <p>Controlled node (CN) No output data is being produced, and no input data is being received. It is only possible to enter or leave this mode after the MN has given the appropriate command.</p>

Table 67: Status/Error LED - POWERLINK - Status

System stop error codes

Incorrect configuration or defective hardware can cause a system stop error.

The error code is indicated by the red Error LED using four switch-on phases. Each switch-on phase has a duration of either 150 ms or 600 ms. The error code is repeated every 2 seconds.

Error description	Error code indicated by red Status LED									
RAM error: The interface is defective and must be replaced.	•	•	•	-	Pause	•	•	•	-	Pause
Hardware error: The interface or a system component is defective and must be replaced.	-	•	•	-	Pause	-	•	•	-	Pause

Table 68: System stop error codes

Key	•	...150 ms
	-	...600 ms
	Pause	2 second delay

3.4.4.4 Updating firmware

The firmware is a component of Automation Studio. The module is updated to this version automatically.

To update the firmware included in Automation Studio, the hardware must be upgraded (see "Project management" / "Automation Studio upgrade" in the Automation Studio help system).

3.4.5 5PP5IF.FCAN-00

3.4.5.1 General information

The 5PP5IF.FCAN-00 interface board has one CAN bus master interface and 512 kB SRAM.

- 1x CAN bus master interface
- 512 kB SRAM
- Compatible with the PP500, APC511 and APC511

This interface board can only be operated with Automation Runtime.

3.4.5.2 Order data

Model number	Short description	Figure
	Interface boards	
5PP5IF.FCAN-00	CAN interface card - 1 CAN master	
	Required accessories	
	Terminal blocks	
0TB1208.3100	Connector, 8-pin cage clamp, 1 mm ² , protected against vibration by the screw flange	

Table 69: 5PP5IF.FCAN-00 - Order data

3.4.5.3 Technical data

Product ID	5PP5IF.FCAN-00
General information	
B&R ID code	0xB4DA
Diagnostics Module status Data transfer Terminating resistor	Yes, using status LED Yes, using status LED Yes, using status LED
Certification CE cULus GOST-R GL	Yes Yes Yes Yes ¹⁾
Controller	
SRAM Value Battery-backed Remanent variables in power failure mode	512 kB Yes 256 kB (e.g. for Automation Runtime, see AS help system) ²⁾
Interfaces	
CAN Quantity Design Transfer rate Terminating resistor Type Default setting	1 8-pin male connector Max. 500 kbit/s Can be enabled or disabled using a sliding switch Disabled
Electrical characteristics	
Power consumption	3 W
Environmental conditions	
Temperature Operation Storage Transport	0 to 55°C -20 to 60°C -20 to 60°C
Relative humidity Operation Storage Transport	5 to 90%, non-condensing 5 to 95%, non-condensing 5 to 95%, non-condensing

Table 70: 5PP5IF.FCAN-00 - Technical data

- 1) Yes, although applies only if all components installed within the complete system have this certification.
- 2) With optimized access using write combining

3.4.5.3.1 CAN bus interface

CAN bus	
The electrically isolated CAN bus interface is a 8-pin connector.	
Transfer rate	Max. 500 kbit/s
Cable length	Max. 1000 meters
Pin	Assignment
1	-
2	-
3	-
4	CAN _L (CAN ground)
5	SHLD (shield)
6	SHLD (shield)
7	CAN_L (CAN Low)
8	CAN_H (CAN High)

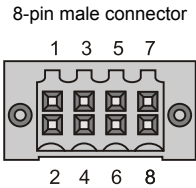

8-pin male connector

Table 71: 5PP5IF.FCAN-00 - CAN bus interface

3.4.5.3.2 LED status indicators

LED status indicators			
LED	Color	Status	Description
CAN	Yellow	On	Sending data
		Off	Receiving data
LED status	Green	On	Interface module active
	Red	On	CPU starting up
TERM LED	Yellow	On	Terminating resistor switched on
		Off	Terminating resistor switched off

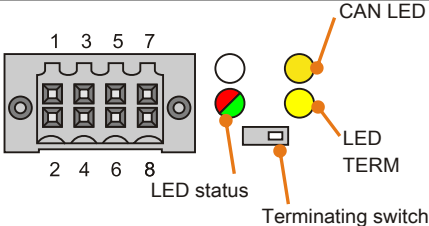

Table 72: 5PP5IF.FCAN-00 - LED status indicators

3.4.5.3.3 CAN terminating switch

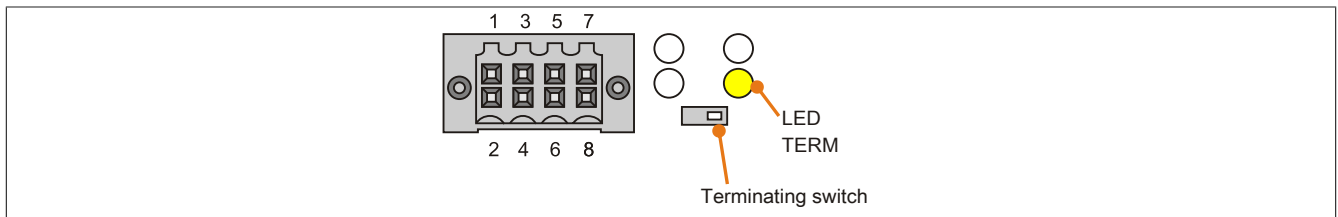

Figure 50: CAN terminating switch

A CAN terminating resistor is integrated on the interface board. It can be turned on and off with a switch on the front. An active terminating resistor is indicated by the TERM LED.

3.4.5.4 Updating firmware

The firmware is a component of Automation Studio. The module is updated to this version automatically.

To update the firmware included in Automation Studio, the hardware must be upgraded (see "Project management" / "Automation Studio upgrade" in the Automation Studio help system).

3.4.6 5PP5IF.FX2X-00

3.4.6.1 General information

The 5PP5IF.FX2X-00 interface board has one X2X Link master interface and 512 kB SRAM.

- 1x X2X Link master interface
- 512 kB SRAM
- Compatible with the PP500, APC511 and APC511

This interface board can only be operated with Automation Runtime.

3.4.6.2 Order data

Model number	Short description	Figure
	Interface boards	
5PP5IF.FX2X-00	X2X Link interface card - 1 X2X Link master - 512 kB SRAM	
	Required accessories	
	Terminal blocks	
0TB1208.3100	Connector, 8-pin cage clamp, 1 mm ² , protected against vibration by the screw flange	

Table 73: 5PP5IF.FX2X-00 - Order data

3.4.6.3 Technical data

Product ID	5PP5IF.FX2X-00	
General information		
B&R ID code	0xB4D9	
Diagnostics		
Module status	Yes, using status LED	
Data transfer	Yes, using status LED	
Certification		
CE	Yes	
cULus	Yes	
GOST-R	Yes	
GL	Yes ¹⁾	
Controller		
SRAM		
Value	512 kB	
Battery-backed	Yes	
Remanent variables in power failure mode	256 kB (e.g. for Automation Runtime, see AS help system) ²⁾	
Interfaces		
X2X		
Type	X2X Link master	
Quantity	1	
Design	8-pin male connector	
Electrical characteristics		
Power consumption	3 W	
Environmental conditions		
Temperature		
Operation	0 to 55°C	
Storage	-20 to 60°C	
Transport	-20 to 60°C	
Relative humidity		
Operation	5 to 90%, non-condensing	
Storage	5 to 95%, non-condensing	
Transport	5 to 95%, non-condensing	

Table 74: 5PP5IF.FX2X-00 - Technical data

- 1) Yes, although applies only if all components installed within the complete system have this certification.
- 2) With optimized access using write combining

3.4.6.3.1 X2X Link master interface

X2X Link Master connection	
The electrically isolated X2X Link master interface is a 8-pin connector.	
Pin	Assignment
1	X2X _\
2	X2X
3	X2X _⊥
4	-
5	SHLD (shield)
6	SHLD (shield)
7	-
8	-

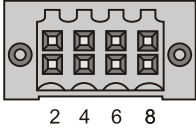

8-pin male connector

Table 75: 5PP5IF.FX2X-00 - X2X Link master interface

3.4.6.3.2 LED status indicators

LED status indicators			
LED	Color	Status	Description
X2X	Yellow	On	Sending data
		Off	Receiving data
LED status	Green	On	Interface module active
	Red	On	CPU starting up

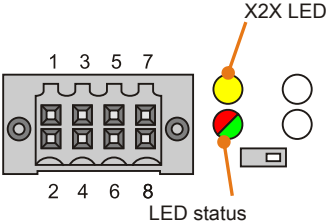

Table 76: 5PP5IF.FX2X-00 - LED status indicators

3.4.6.4 Updating firmware

The firmware is a component of Automation Studio. The module is updated to this version automatically.

To update the firmware included in Automation Studio, the hardware must be upgraded (see "Project management" / "Automation Studio upgrade" in the Automation Studio help system).

3.4.7 5PP5IF.FXCM-00

3.4.7.1 General information

The 5PP5IF.FXCM-00 interface board has one combined CAN master and , one X2X Link master interface and 512 kB SRAM.

- 1x CAN bus master interface
- 1x X2X Link master interface
- 512 kB SRAM
- Compatible with the PP500, APC511 and APC511

This interface board can only be operated with Automation Runtime.

3.4.7.2 Order data

Model number	Short description	Figure
5PP5IF.FXCM-00	Interface boards CAN interface card - 1 CAN master - 1 X2X master - 512 kB SRAM - Can be installed in PP500, APC510, APC511 systems	
	Required accessories	
	Terminal blocks	
0TB1208.3100	Connector, 8-pin cage clamp, 1 mm ² , protected against vibration by the screw flange	

Table 77: 5PP5IF.FXCM-00 - Order data

3.4.7.3 Technical data

Product ID	5PP5IF.FXCM-00
General information	
B&R ID code	0xBB9D
Diagnostics	
Module status	Yes, using status LED
Data transfer	Yes, using status LED
Terminating resistor	Yes, using status LED
Certification	
CE	Yes
cULus	Yes
GOST-R	Yes
GL	Yes ¹⁾
Controller	
SRAM	
Value	512 kB
Battery-backed	Yes
Remanent variables in power failure mode	256 kB (e.g. for Automation Runtime, see AS help system) ²⁾
Interfaces	
CAN	
Quantity	1
Design	8-pin male connector
Transfer rate	Max. 500 kbit/s
Terminating resistor	
Type	Can be enabled or disabled using a sliding switch
Default setting	Disabled
X2X	
Type	X2X Link master
Quantity	1
Design	8-pin male connector
Electrical characteristics	
Power consumption	3 W
Environmental conditions	
Temperature	
Operation	0 to 55°C
Storage	-20 to 60°C
Transport	-20 to 60°C
Relative humidity	
Operation	5 to 90%, non-condensing
Storage	5 to 95%, non-condensing
Transport	5 to 95%, non-condensing

Table 78: 5PP5IF.FXCM-00 - Technical data

1) Yes, although applies only if all components installed within the complete system have this certification.
 2) With optimized access using write combining

3.4.7.3.1 CAN bus master interface

CAN bus master	
The electrically isolated CAN bus master interface is a 8-pin connector.	
Transfer rate	Max. 500 kbit/s
Cable length	Max. 1000 meters
Pin	Assignment
1	-
2	-
3	-
4	CAN _⊥ (CAN ground)
5	SHLD (shield)
6	SHLD (shield)
7	CAN_L (CAN Low)
8	CAN_H (CAN High)

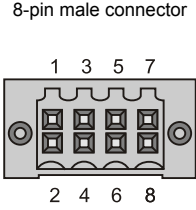

Table 79: 5PP5IF.FCAN-00 - CAN bus master interface

3.4.7.3.2 X2X Link master interface

X2X Link Master connection	
The electrically isolated X2X Link master interface is a 8-pin connector.	
Pin	Assignment
1	X2X _⊥
2	X2X
3	X2X _⊥
4	-
5	SHLD (shield)
6	SHLD (shield)
7	-
8	-

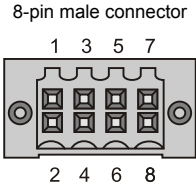

Table 80: 5PP5IF.FX2X-00 - X2X Link master interface

3.4.7.3.3 LED status indicators

LED status indicators			
LED	Color	Status	Description
X2X	Yellow	On	Sending data
		Off	Receiving data
CAN	Yellow	On	Sending data
		Off	Receiving data
LED status	Green	On	Interface module active
	Red	On	CPU starting up
TERM LED	Yellow	On	Terminating resistor switched on
		Off	Terminating resistor switched off

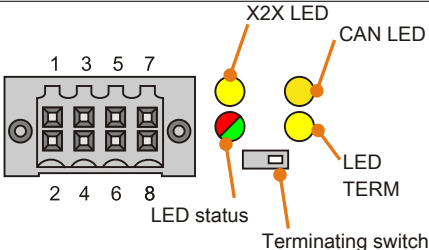

Table 81: 5PP5IF.FXCM-00 - LED status indicators

3.4.7.3.4 CAN terminating switch

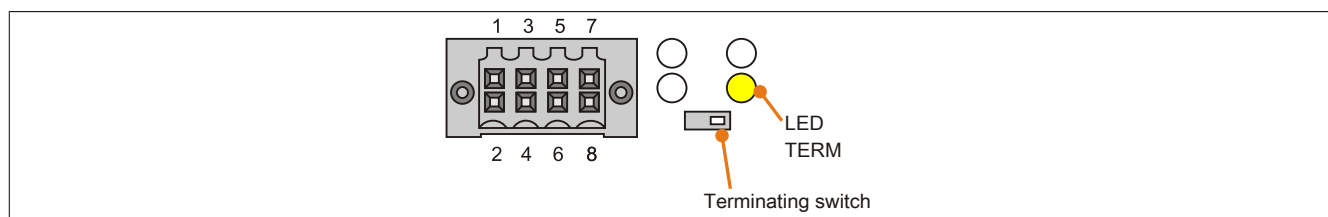

Figure 51: CAN terminating switch

A CAN terminating resistor is integrated on the interface board. It can be turned on and off with a switch on the front. An active terminating resistor is indicated by the TERM LED.

3.4.7.4 Updating firmware

The firmware is a component of Automation Studio. The module is updated to this version automatically.

To update the firmware included in Automation Studio, the hardware must be upgraded (see "Project management" / "Automation Studio upgrade" in the Automation Studio help system).

3.5 I/O boards

Information:

I/O boards can ONLY be installed and replaced by B&R.

Information:

I/O boards can only be operated in the system unit 5PP520.0573-01.

3.5.1 5PP5IO.GNAC-00

3.5.1.1 General information

The 5PP5IO.GNAC-00 I/O board has 1x RS232/422/485 interface, 1x USB 2.0 connection, 1x HDA sound connection and 1x female Smart Display Link/DVI connector. This I/O board can be connected to and operated on Power Panel 500 and Automation PC 511 systems with an I/O board slot.

- 1x USB 2.0
- 1x RS232/422/485
- 1x HDA sound
- 1x Smart Display Link / DVI
- Compatible with the PP500 and APC511

3.5.1.2 Order data

Model number	Short description	Figure
5PP5IO.GNAC-00	I/O board Interface board - 1 USB 2.0 - 1 RS232/422/485 - 1 HDA sound - 1 SDL/DVI-D	

Table 82: 5PP5IO.GNAC-00 - Order data

3.5.1.3 Technical data

Product ID	5PP5IO.GNAC-00
General information	
B&R ID code	0xB4DD
Certification	
CE	Yes
cULus	Yes
GOST-R	Yes
Interfaces	
COM2 ¹⁾	
Type	RS232/422/485, electrically isolated
Design	9-pin female DSUB connector
UART	16550-compatible, 16-byte FIFO
Max. baud rate	115 kbit/s
USB	
Quantity	1
Type	USB 2.0
Design	Type A
Transfer rate	Low speed (1.5 Mbit/s), full speed (12 Mbit/s), high speed (480 Mbit/s)
Current load	Max. 1 A
Monitor/Panel interface	
Design	Female DVI-I connector
Type	SDL/DVI
Audio	
Type	HDA sound
Inputs	Microphone, Line IN
Outputs	Line OUT
Electrical characteristics	
Power consumption	7 W

Table 83: 5PP5IO.GNAC-00 - Technical data

Product ID	5PP5IO.GNAC-00
Environmental conditions	
Temperature	
Operation	0 to 50°C
Storage	-20 to 60°C
Transport	-20 to 60°C
Relative humidity	
Operation	5 to 90%, non-condensing
Storage	5 to 95%, non-condensing
Transport	5 to 95%, non-condensing

Table 83: 5PP5IO.GNAC-00 - Technical data

1) The COM2 interface is identified in BIOS as the COM D interface.

3.5.1.3.1 Panel interface - SDL (Smart Display Link) / DVI

Panel interface - SDL (Smart Display Link) / DVI	
The following overview lists the video signals available on the panel output. For details, see the technical data for the CPU board being used.	
CPU board	Video signals with all system unit variants
5PP5CP.US15-00	DVI, SDL
5PP5CP.US15-01	DVI, SDL
5PP5CP.US15-02	DVI, SDL

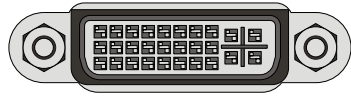

Table 84: Panel interface - DVI, SDL

Information:

Only digital panels can be connected to the panel interface (analog monitors not permitted).

Pinout

Pin	Assignment	Description	Pin	Assignment	Description
1	TMDS data 2-	DVI lane 2 (negative)	16	HPD	Hot plug detect
2	TMDS data 2+	DVI lane 2 (positive)	17	TMDS data 0-	DVI lane 0 (negative)
3	TMDS data 2/4 SHIELD	Shield for data pair 2 and 4	18	TMDS data 0+	DVI lane 0 (positive)
4	SDL-	SDL lane (negative)	19	TMDS Data 0/ XUSB1 SHIELD	Shield for data pair 0 and USB1
5	SDL+	SDL lane (positive)	20	XUSB1-	USB lane 1 (negative)
6	DDC clock	DDC-based control signal (clock)	21	XUSB1+	USB lane 1 (positive)
7	DDC data	DDC-based control signal (data)	22	TMDS clock shield	Shield for clock pair
8	N/C	Not connected	23	TMDS clock+	DVI clock (positive)
9	TMDS data 1-	DVI lane 1 (negative)	24	TMDS clock -	DVI clock (negative)
10	TMDS DATA 1+	DVI lane 1 (negative) HDMI clock (positive)	C1	N/C	Not connected
11	TMDS DATA 1/ XUSB0 SHIELD	Shield for data pair 1 and USB0	C2	N/C	Not connected
12	XUSB0-	USB lane 0 (negative)	C3	N/C	Not connected
13	XUSB0+	USB lane 0 (positive)	C4	N/C	Not connected
14	+5 V power ¹⁾	+5 V power supply	C5	N/C	Not connected
15	Ground (return for +5 V, HSync and VSync)	Ground			

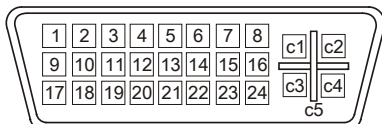

Table 85: DVI interface - Pinout

1) Protected internally by a multifuse.

Cable lengths and resolutions for SDL transmission

The following table lists the relationship between segment lengths and maximum resolution depending on the SDL cable being used:

SDL cable Segment length [m]	Resolution						
	VGA 640 x 480	SVGA 800 x 600	XGA 1024 x 768	HD 1366 x 768	SXGA 1280 x 1024	UXGA 1600 x 1200	FHD 1920 x 1080
0.8	5CASDL.0008-00	5CASDL.0008-00	5CASDL.0008-00	5CASDL.0008-00	5CASDL.0008-00	5CASDL.0008-00	5CASDL.0008-00
1.8	5CASDL.0018-00	5CASDL.0018-00	5CASDL.0018-00	5CASDL.0018-00	5CASDL.0018-00	5CASDL.0018-00	5CASDL.0018-00
	5CASDL.0018-01	5CASDL.0018-01	5CASDL.0018-01	5CASDL.0018-01	5CASDL.0018-01	5CASDL.0018-01	5CASDL.0018-01
	5CASDL.0018-03	5CASDL.0018-03	5CASDL.0018-03	5CASDL.0018-03	5CASDL.0018-03	5CASDL.0018-03	5CASDL.0018-03
5	5CASDL.0050-00	5CASDL.0050-00	5CASDL.0050-00	5CASDL.0050-00	5CASDL.0050-00	5CASDL.0050-00	5CASDL.0050-00
	5CASDL.0050-01	5CASDL.0050-01	5CASDL.0050-01	5CASDL.0050-01	5CASDL.0050-01	5CASDL.0050-01	5CASDL.0050-01
	5CASDL.0050-03	5CASDL.0050-03	5CASDL.0050-03	5CASDL.0050-03	5CASDL.0050-03	5CASDL.0050-03	5CASDL.0050-03
10	5CASDL.0100-00	5CASDL.0100-00	5CASDL.0100-00	5CASDL.0100-00	5CASDL.0100-00	5CASDL.0100-00	5CASDL.0100-00
	5CASDL.0100-01	5CASDL.0100-01	5CASDL.0100-01	5CASDL.0100-01	5CASDL.0100-01	5CASDL.0100-01	5CASDL.0100-01
	5CASDL.0100-03	5CASDL.0100-03	5CASDL.0100-03	5CASDL.0100-03	5CASDL.0100-03	5CASDL.0100-03	5CASDL.0100-03
15	5CASDL.0150-00	5CASDL.0150-00	5CASDL.0150-00	5CASDL.0150-00	5CASDL.0150-00	-	-
	5CASDL.0150-01	5CASDL.0150-01	5CASDL.0150-01	5CASDL.0150-01	5CASDL.0150-01	-	-
	5CASDL.0150-03	5CASDL.0150-03	5CASDL.0150-03	5CASDL.0150-03	5CASDL.0150-03	-	5CASDL.0150-03
20	5CASDL.0200-00	5CASDL.0200-00	5CASDL.0200-00	5CASDL.0200-00	5CASDL.0200-00	-	-
	5CASDL.0200-03	5CASDL.0200-03	5CASDL.0200-03	5CASDL.0200-03	5CASDL.0200-03	-	5CASDL.0200-03
25	5CASDL.0250-00	5CASDL.0250-00	5CASDL.0250-00	5CASDL.0250-00	-	-	-
	5CASDL.0250-03	5CASDL.0250-03	5CASDL.0250-03	5CASDL.0250-03	-	-	-
30	5CASDL.0300-00	5CASDL.0300-00	-	-	-	-	-
	5CASDL.0300-03	5CASDL.0300-03	5CASDL.0300-13	5CASDL.0300-13	5CASDL.0300-13	-	5CASDL.0300-13
40	5CASDL.0400-13	5CASDL.0400-13	5CASDL.0400-13	5CASDL.0400-13	5CASDL.0400-13	-	5CASDL.0400-13

Table 86: Cable lengths and resolutions for SDL transmission

Cable lengths and resolutions for DVI transmission

The following table lists the relationship between segment lengths and maximum resolution depending on the DVI cable being used:

DVI cable Segment length [m]	Resolution						
	VGA 640 x 480	SVGA 800 x 600	XGA 1024 x 768	HD 1366 x 768	SXGA 1280 x 1024	UXGA 1600 x 1200	FHD 1920 x 1080
1.8	5CADVI.0018-00	5CADVI.0018-00	5CADVI.0018-00	5CADVI.0018-00	5CADVI.0018-00	5CADVI.0018-00	5CADVI.0018-00
5	5CADVI.0050-00	5CADVI.0050-00	5CADVI.0050-00	5CADVI.0050-00	5CADVI.0050-00	5CADVI.0050-00	5CADVI.0050-00

Table 87: Cable lengths and resolutions for DVI transmission

The maximum cable length for DVI transfer is limited to 5 m due to the USB specification.

3.5.1.3.2 Pinout

COM serial interface			
	RS232	RS422/485	
Type	RS232, not modem-capable, electrically isolated		
UART	16550-compatible, 16-byte FIFO		
Transfer rate	Max. 115 kbit/s		
Bus length	Max. 15 m	Max. 1200 m	
Pin	RS232 - Pinout	RS422 - Pinout	
1	N/C	TXD\	
2	RXD	N/C	
3	TXD	N/C	
4	N/C	TXD	
5	GND	GND	
6	N/C	RXD\	
7	RTS	N/C	
8	CTS	N/C	
9	N/C	RXD	

9-pin male DSUB connector

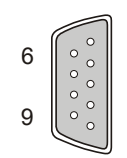

Table 88: COM - Pinout

3.5.1.3.3 I/O address and IRQ

Resource	Default setting	Additional setting options
I/O address	2E8h	238h, 2F8h, 328h, 338h, 3E8h, 3F8h ¹⁾
IRQ	10	3, 4, 5, 6, 11, 12 ¹⁾

Table 89: RS232/422/485 - I/O address and IRQ

1) If these settings are not already used in the system.

3.5.1.3.4 RS232 - Bus length and cable type

The maximum transfer rate of 115 kbit/s depends on the cable type being used.

Extension	Transfer rate
≤15 m	Typ. 64 kbit/s
≤10 m	Typ. 115 kbit/s
≤5 m	Typ. 115 kbit/s

Table 90: RS232 - Bus length and transfer rate

The material used for the cable should have all or most of the following properties in order to achieve an optimal transfer rate.

RS232 cables	Property
Signal lines	
Cable cross section	4x 0.16 mm ² (26 AWG), tinned copper stranded wire
Wire insulation	PE
Conductor resistance	≤82 Ω/ km
Stranding	Wires stranded in pairs
Shield	Paired shield with aluminum foil
Grounding line	
Cable cross section	1x 0.34 mm ² (22 AWG / 19), tinned copper stranded wire
Wire insulation	PE
Conductor resistance	≤59 Ω/km
Outer sheathing	
Material	PUR mixture
Features	Halogen-free
Complete shielding	From tinned copper wires

Table 91: RS232 - Cable requirements

3.5.1.3.5 RS422 - Bus length and cable type

The RTS line must be switched on to switch the transmitter to active.

The maximum transfer rate of 115 kbit/s depends on the type of cable being used.

Extension	Transfer rate
1200 m	Typ. 115 kbit/s

Table 92: RS422 - Bus length and transfer rate

The material used for the cable should have all or most of the following properties in order to achieve an optimal transfer rate.

RS422 cable	Property
Signal lines	
Cable cross section	4x 0.25 mm ² (24 AWG / 19), tinned copper stranded wire
Wire insulation	PE
Conductor resistance	≤82 Ω/km
Stranding	Wires stranded in pairs
Shield	Paired shield with aluminum foil
Grounding line	
Cable cross section	1x 0.34 mm ² (22 AWG / 19), tinned copper stranded wire
Wire insulation	PE
Conductor resistance	≤59 Ω/km
Outer sheathing	
Material	PUR mixture
Features	Halogen-free
Complete shielding	From tinned copper wires

Table 93: RS422 - Cable requirements

3.5.1.3.6 When operated as an RS485 interface

When operated in this mode, the pins of the RS422 default interface (1, 4, 6 and 9) must be used. Pins should be connected as shown.

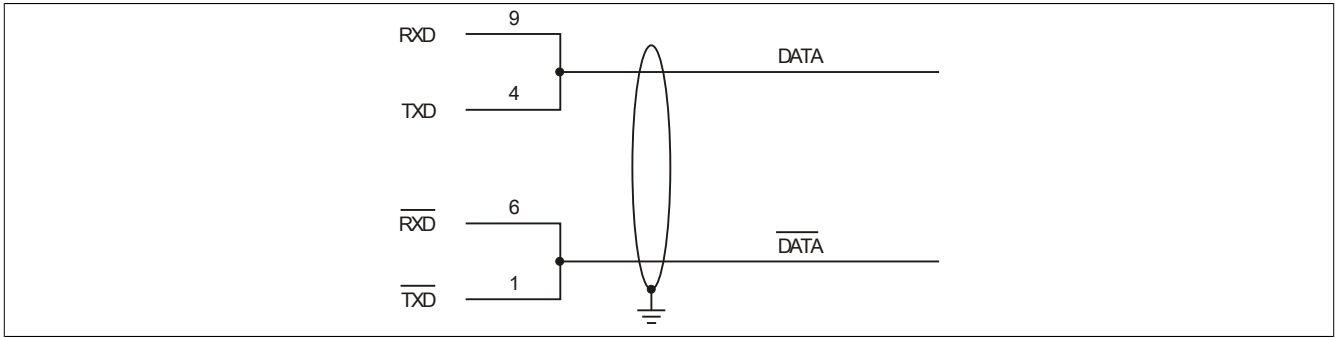

Figure 52: RS232/RS422/RS485 interface - Operation in RS485 mode

The RTS line must be switched by the driver for each transmission or reception; there is no automatic switch-back mechanism. This cannot be configured in Windows.

The voltage drop resulting from long cable lengths can lead to greater potential differences between bus stations, which can hinder communication. This can be improved by running ground wire with the others.

3.5.1.3.7 RS485 - Bus length and cable type

The maximum transfer rate of 115 kbit/s depends on the type of cable being used.

Extension	Transfer rate
1200 m	Typ. 115 kbit/s

Table 94: RS485 - Bus length and transfer rate

The material used for the cable should have all or most of the following properties in order to achieve an optimal transfer rate.

RS485 cables	Property
Signal lines	
Cable cross section	4x 0.25 mm ² (24 AWG / 19), tinned copper stranded wire
Wire insulation	PE
Conductor resistance	≤82 Ω/km
Stranding	Wires stranded in pairs
Shield	Paired shield with aluminum foil
Grounding line	
Cable cross section	1x 0.34 mm ² (22 AWG / 19), tinned copper stranded wire
Wire insulation	PE
Conductor cross section	≤59 Ω/km
Outer sheathing	
Material	PUR mixture
Features	Halogen-free
Complete shielding	From tinned copper wires

Table 95: RS485 - Cable requirements

3.5.1.3.8 Terminating resistor

A terminating resistor for the serial interface is already integrated on the I/O board. It can be enabled or disabled with a switch between the serial interface and the audio interface. An active terminating resistor is indicated by a yellow LED.

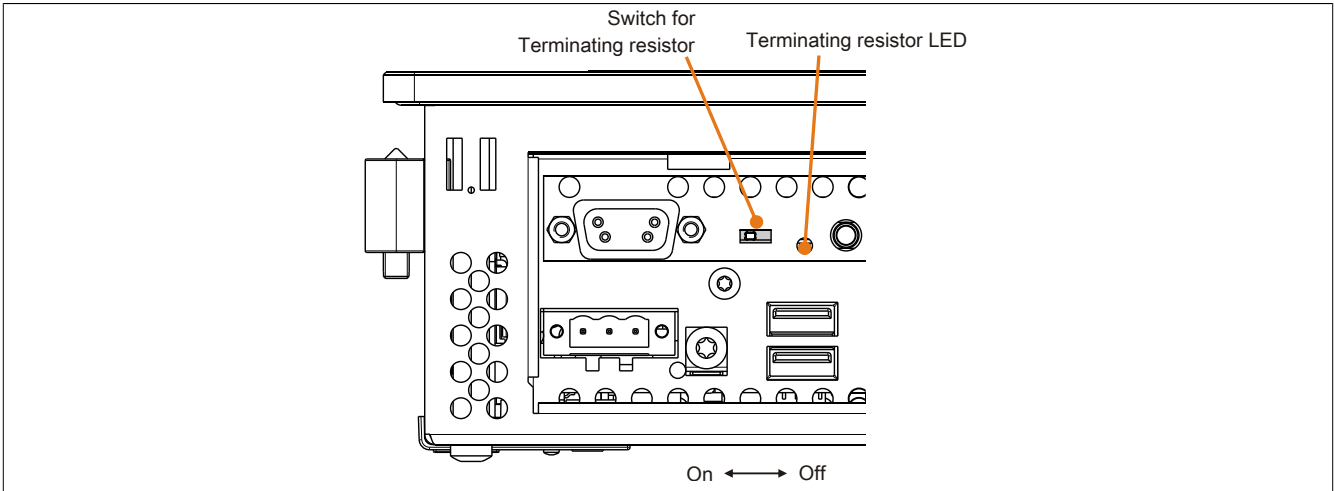

Figure 53: Serial Interface (COM) terminating resistor

3.5.1.3.9 USB interface (USB4)

The I/O board features a USB 2.0 (Universal Serial Bus) host controller with multiple USB ports, 1 of which is accessible externally for the user.

Warning!

Peripheral USB devices can be connected to the USB interfaces on this device. Due to the large number of USB devices available on the market, B&R cannot guarantee their performance. All USB devices provided by B&R are guaranteed to function properly.

Caution!

Because this interface is designed according to general PC specifications, extreme care should be exercised with regard to EMC, cable routing, etc.

Universal Serial Bus (USB4) ¹⁾		
Transfer rate	Low speed (1.5 Mbit/s), full speed (12 Mbit/s), high speed (480 Mbit/s)	1x USB type A, female 
Power supply ²⁾ USB4	Max. 1 A	
Cable length	Max. 5 m (without hub)	

Table 96: USB4 interface

- 1) The interfaces, etc. available on the I/O board have been numbered as such for easy identification. This numbering may differ from that used by the particular operating system.
- 2) Each USB port is protected by a maintenance-free "USB current-limiting circuit breaker" (max. 1 A).

3.5.1.3.10 MIC, Line IN, Line OUT

MIC, Line IN, Line OUT		
Controller	Realtek ALC 662	3.5 mm jack, female 
MIC	Connection of a mono microphone with a 3.5 mm jack	
Line IN	Stereo Line IN signal supplied via a 3.5 mm jack	
Line OUT	Connection of a stereo playback device (e.g. amplifier) via a 3.5 mm jack	

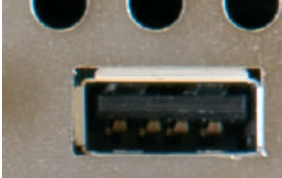
Table 97: MIC, Line IN, Line OUT

A special driver is required in order to operate the audio controller. Drivers for approved operating systems are available in the Downloads section of the B&R website (www.br-automation.com).

Information:

Required drivers can only be downloaded from the B&R website, not from manufacturer websites.

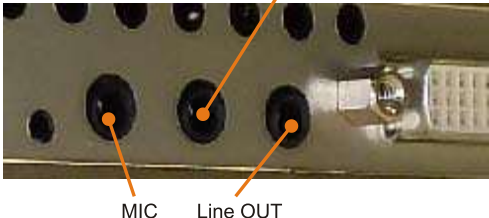
Chapter 3 • Installation

1 Installation

Danger!

- All supplied power must be disconnected before removing device covers or components or installing/removing accessories, hardware or cables.
- The power cable must be disconnected from the device and from the voltage supply.
- All covers, components, accessories, hardware and cables must be installed or connected before the device can be connected to the power supply and turned on.

B&R Industrial PCs are best mounted in a wall cutout using the retaining clips or clamping blocks found on the housing (designs may vary).

1.1 Important installation information

- Environmental conditions must be taken into consideration.
- When installed in an enclosure, enough space must be available for air to circulate sufficiently.
- This device must be installed on a flat, clean and burr-free surface.
- This device is only certified for operation in enclosed rooms.
- This device must not be subjected to direct sunlight.
- Ventilation holes must not be covered.
- This device must be installed using one of the approved mounting orientations.
- The wall or control cabinet must be able to withstand four times the total weight of the device.
- The flex radius of connected cables (DVI, SDL, USB, etc.) must not be exceeded.
- This device must be installed in a position that minimizes glare on the screen.
- This device must be installed in a position and orientation that make viewing as easy as possible for the operator.

1.2 Installation with clamping blocks

Clamping blocks are used to mount PP500 devices with a diagonal of 10.4", 12" or 15".

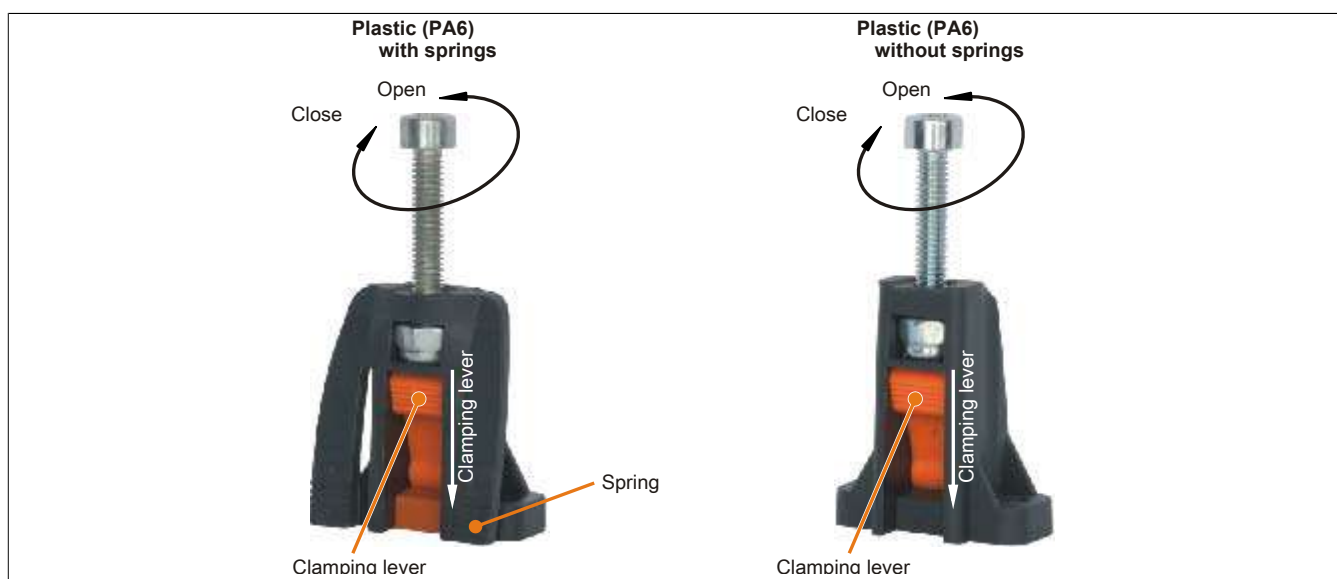

Figure 54: Clamping blocks

Clamping blocks are designed to clamp a maximum thickness of 10 mm and minimum thickness of 2 mm.

A hex key (3 mm) is needed to tighten and loosen the screws. The maximum torque when tightening the clamp is 0.5 Nm.

Devices must be installed on flat, clean and burr-free surface; uneven areas can cause damage to the display when the screws are tightened or intrusion of dust and water.

1.2.1 Procedure

1. Insert the device into the front side of the smooth, flat installation cutout. The number and design of the clamping blocks may vary depending on the size of the device. The required dimensions of the installation cutout can be found in section 3 "Individual components".

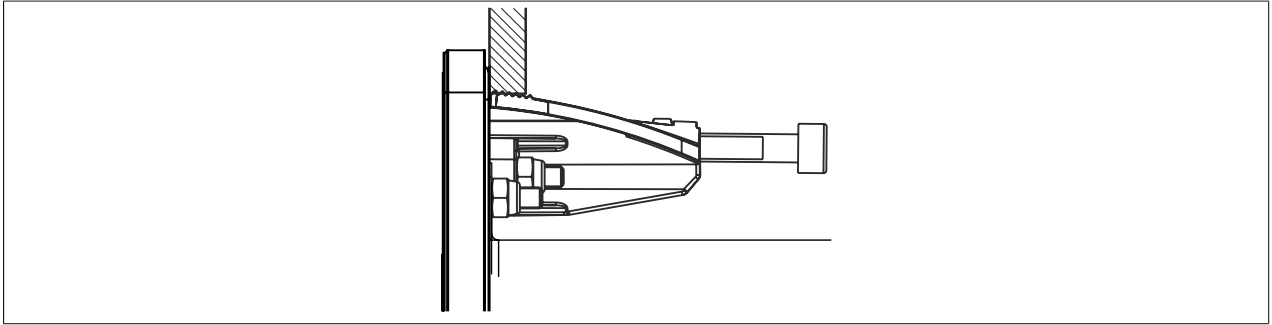

Figure 55: Device with clamping block inserted in cutout

2. Fasten the clamping blocks to the wall or control cabinet by tightening the screws with a hex key (M4). Tightening the screw presses down the integrated clamping lever to hold the device securely in place. The fastening torque should be approximately 0.5 Nm.

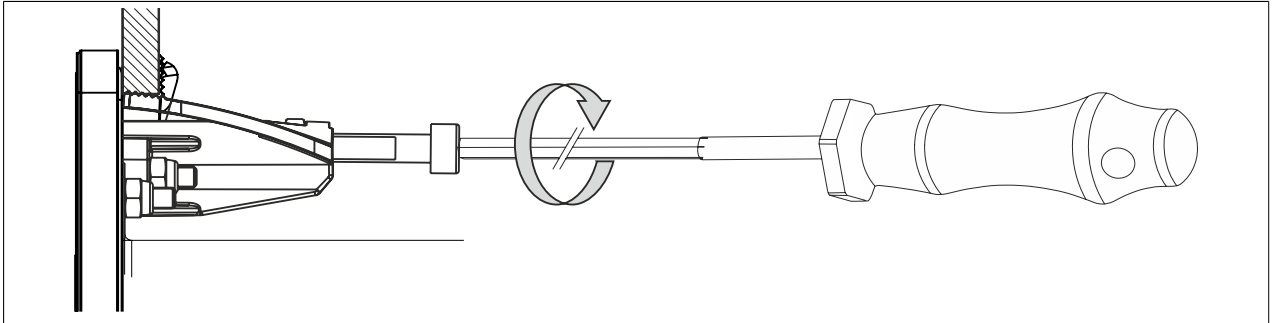

Figure 56: Fastening the clamping blocks

1.3 Installation with retaining clips

Retaining clips are used to mount PP500 devices with a diagonal of 5.7" or 7".

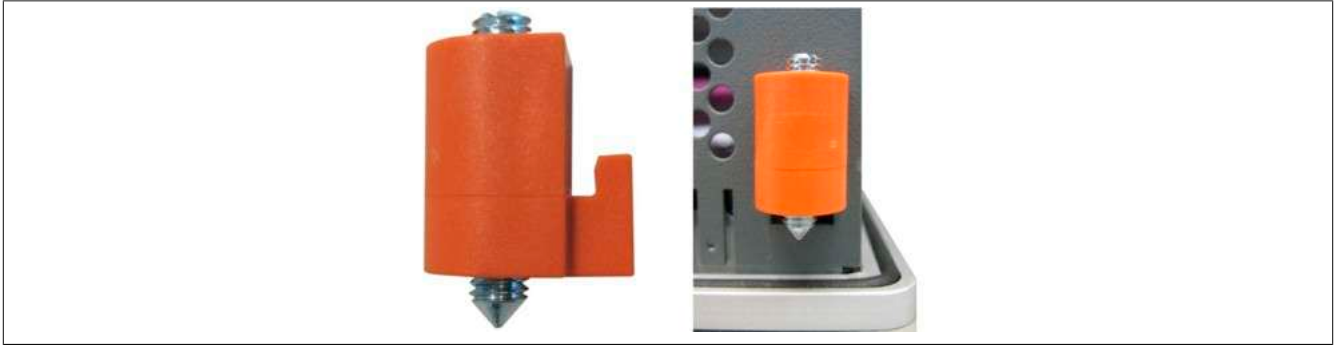

Figure 57: Retaining clips

Retaining clips are designed to clamp a maximum thickness of 6 mm and minimum thickness of 2 mm.

A large flat-head screwdriver is needed to tighten and loosen the screws. The maximum torque for the retaining clips is 0.5 Nm.

Devices must be installed on flat, clean and burr-free surface; uneven areas can cause damage to the display when the screws are tightened or intrusion of dust and water.

1.3.1 Procedure

1. Insert the device into the front side of the smooth, flat installation cutout. The required dimensions of the installation cutout can be found in section 3 "Individual components".
2. Place the retaining clips on the B&R device. To do this, hook the clips into the openings on the sides of the B&R device (indicated by the orange circles). The number of openings may vary depending on the size of the device.

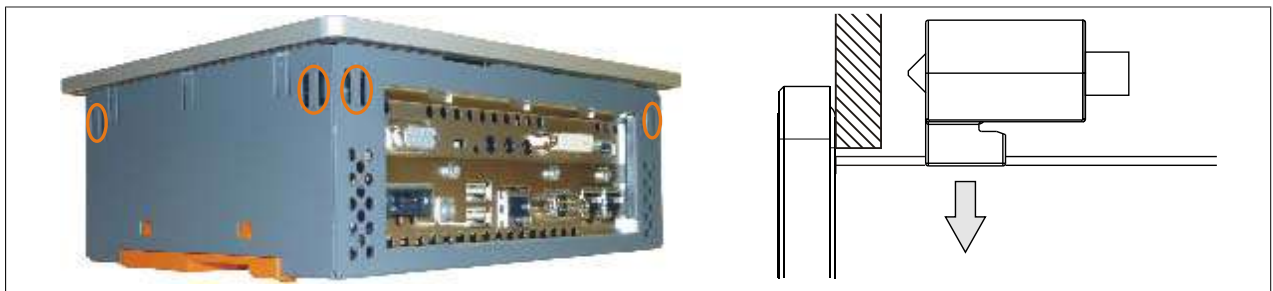

Figure 58: Inserting the retaining clips

3. Slide the retaining clips all the way to the back of the openings.

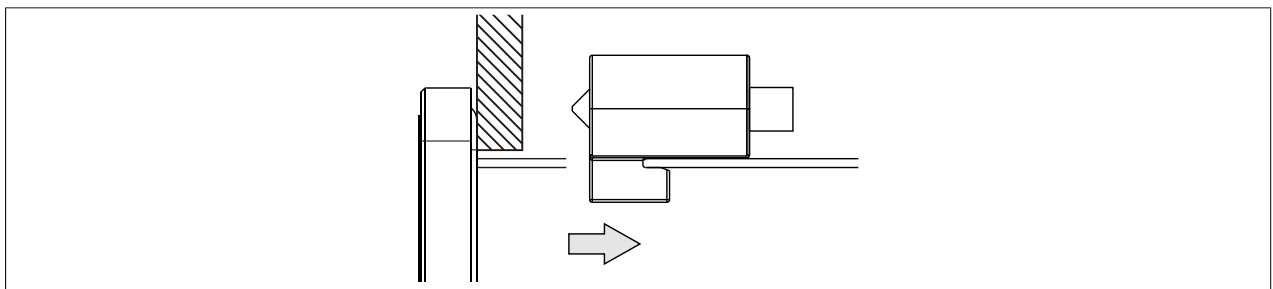

Figure 59: Sliding the retaining clips back

4. Now fasten the retaining clips to the wall or control cabinet by tightening the screws with a flat-head screwdriver. The fastening torque should be approximately 0.5 Nm.

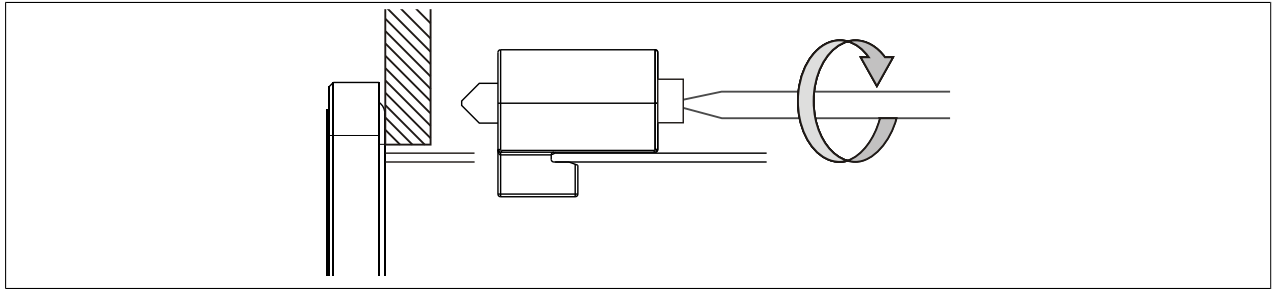

Figure 60: Mounting with retaining clamps

1.4 Mounting orientations

The following diagrams show the approved mounting orientations for the Power Panel 500. These mounting orientations apply to all Power Panel 500 devices.

1.4.1 Mounting orientation 0°

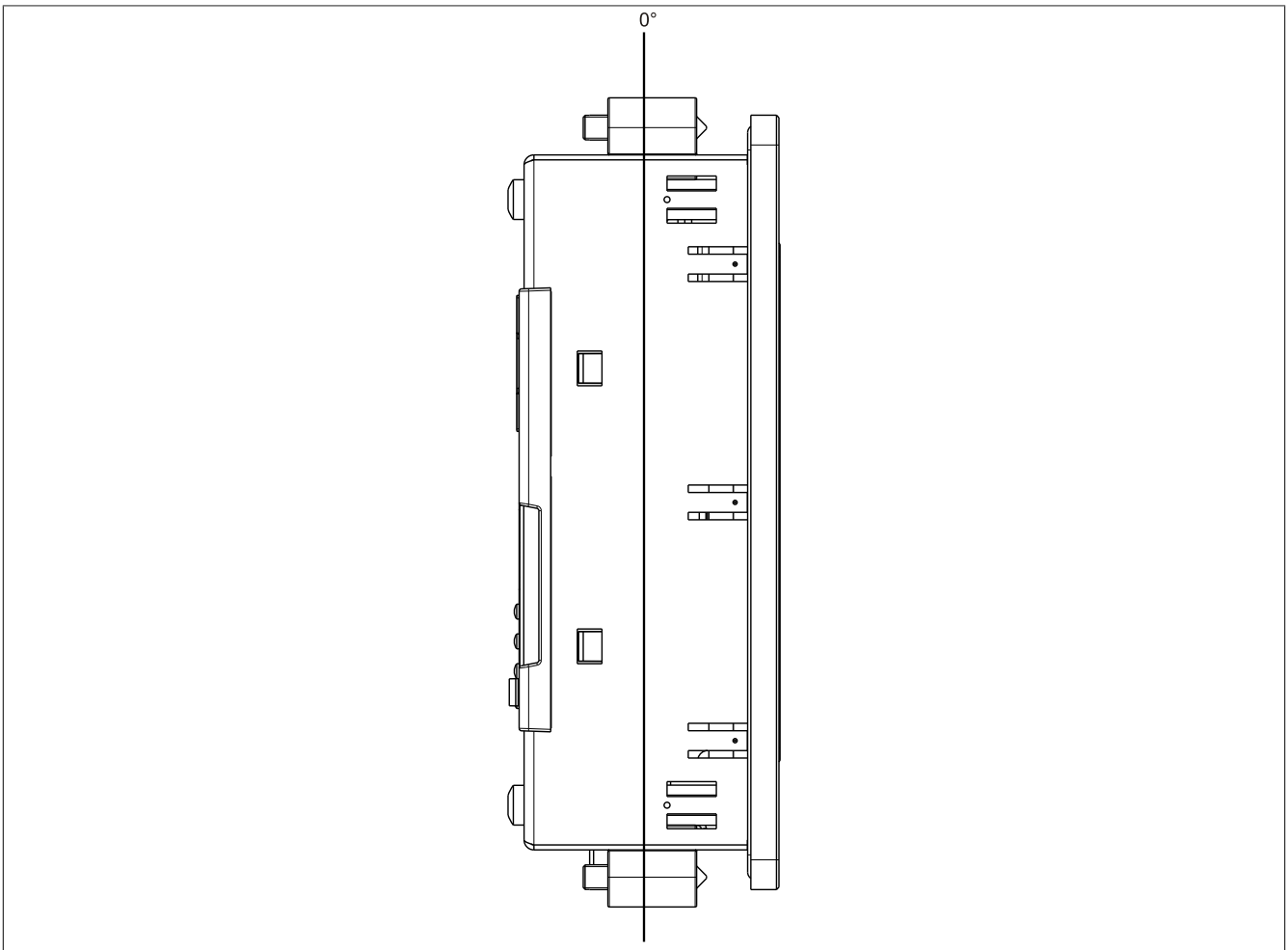

Figure 61: Mounting orientation 0°

In order to facilitate natural air circulation, devices must be mounted according to the spacing indicated in the section "Spacing for air circulation" on page 138.

1.4.2 Mounting orientation 45°

The maximum ambient temperature specification must be **reduced by 5°C** when using a 45° mounting orientation.

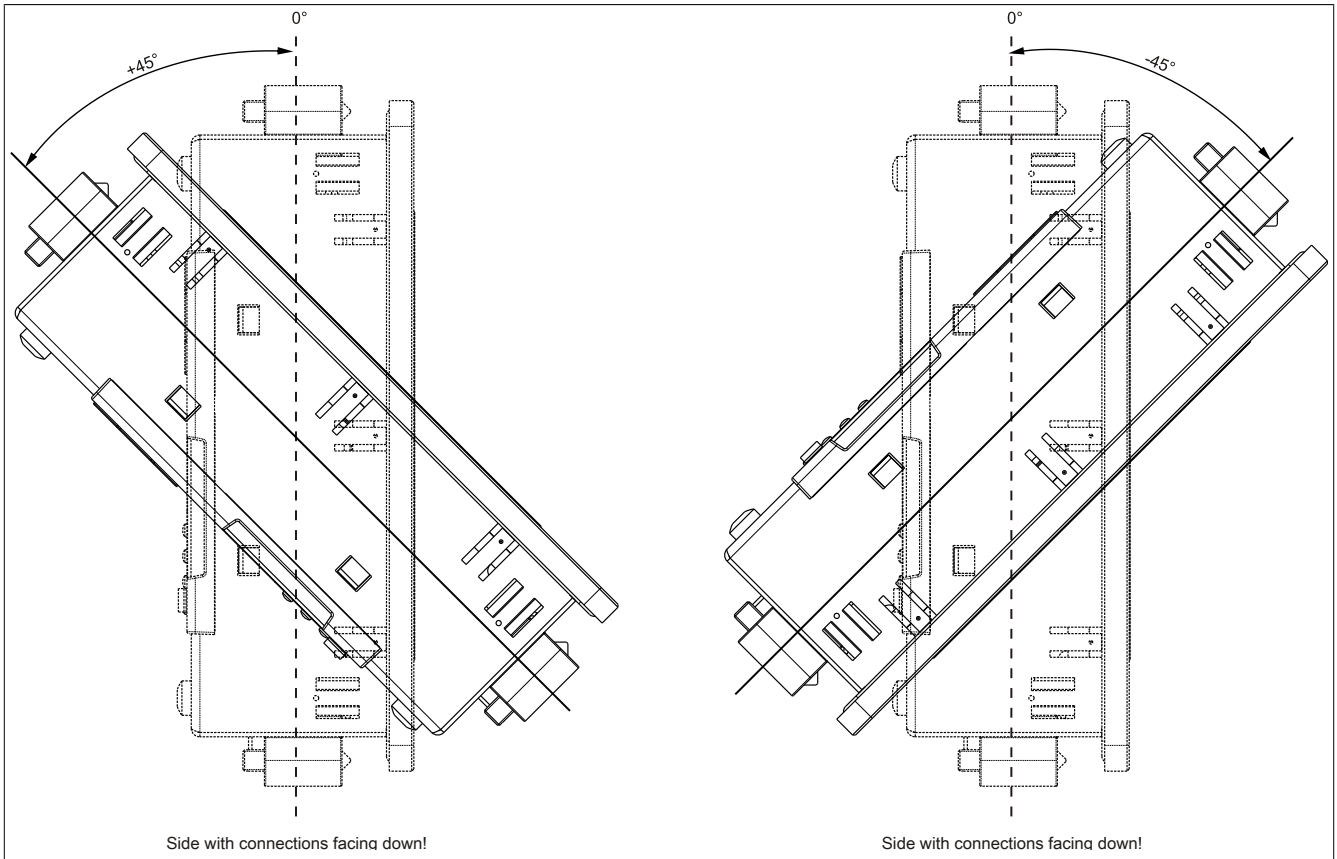

Figure 62: Mounting orientation -45° or +45°.

In order to facilitate natural air circulation, devices must be mounted according to the spacing indicated in the section "Spacing for air circulation" on page 138.

1.4.3 Mounting orientation 90°

The maximum ambient temperature specification must be **reduced by 10°C** when using a 90° (horizontal) mounting orientation.

Warning!

This orientation is not permitted for Power Panel 500 devices with a I/O board (5PP520.0573-01).

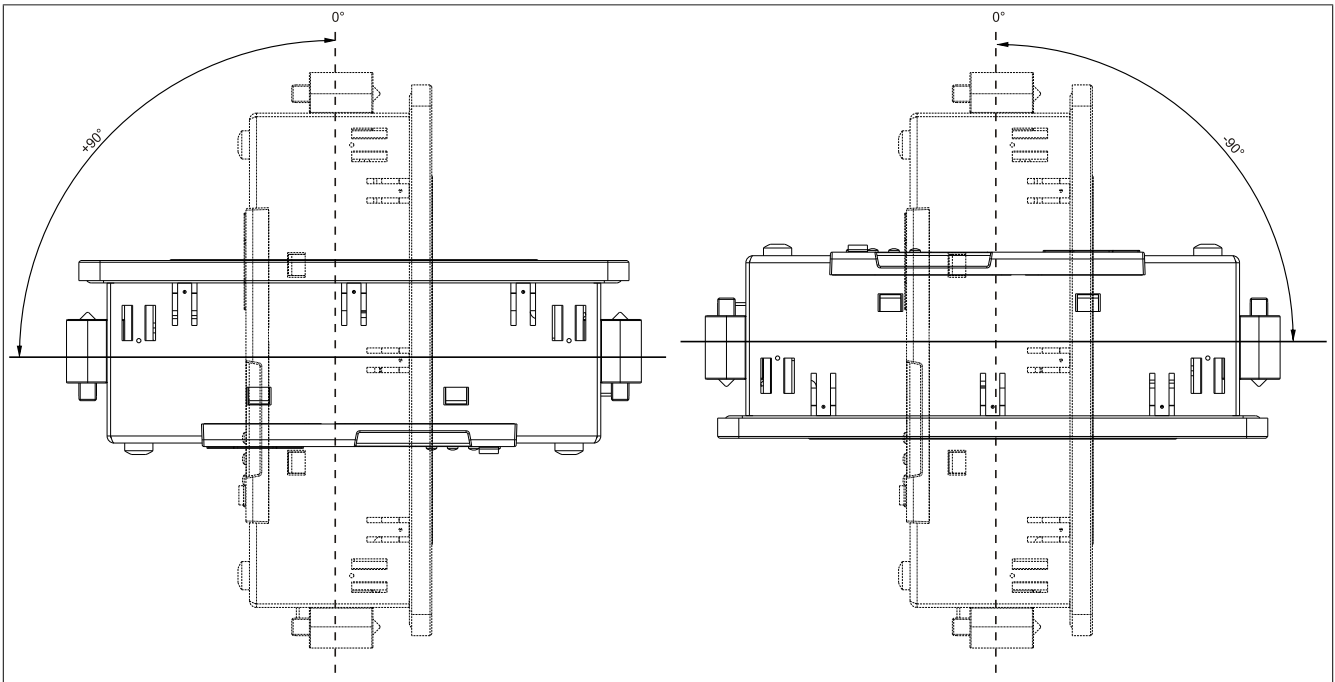

Figure 63: Mounting orientation -90° or +90°.

In order to facilitate natural air circulation, devices must be mounted according to the spacing indicated in the section "Spacing for air circulation" on page 138.

1.4.4 Mounting orientation 90° vertical

The maximum ambient temperature specification must be **reduced by 5°C** when using a 90° (vertical) mounting orientation.

For Power Panel 500 devices with an I/O board (5PP520.0573-01), the maximum ambient temperature doesn't have to be derated.

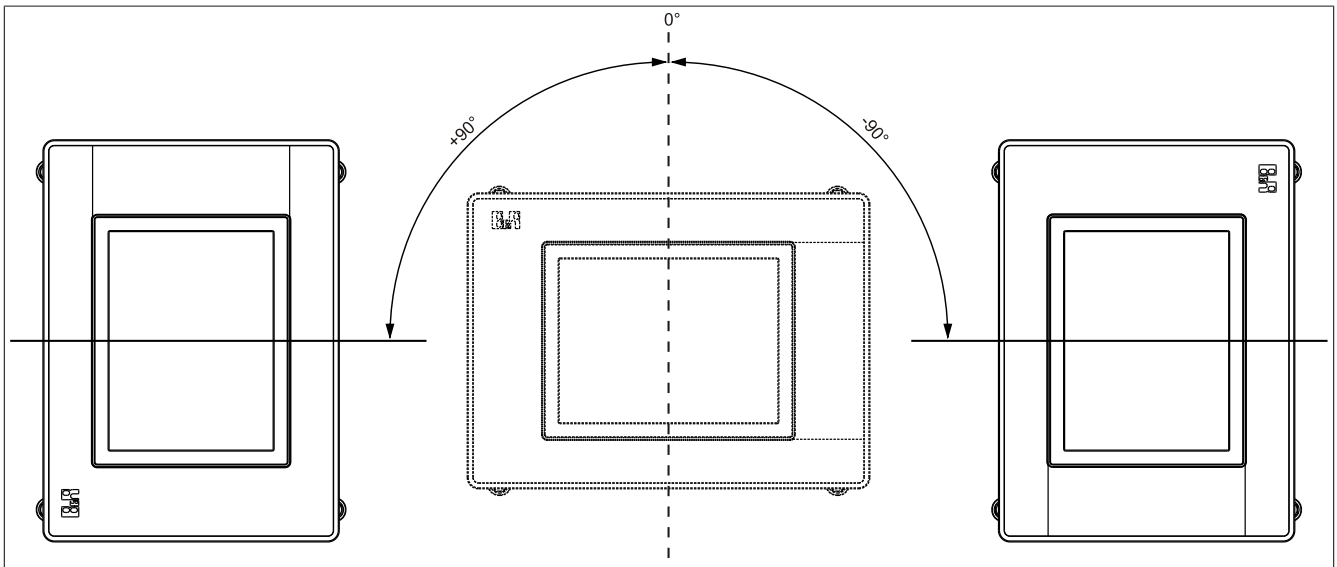

Figure 64: Mounting orientation -90° or +90° vertical

In order to facilitate natural air circulation, devices must be mounted according to the spacing indicated in the section "Spacing for air circulation" on page 138.

1.4.5 Mounting orientation 180°

There are no limitations with respect to ambient temperature when mounted at 180°.

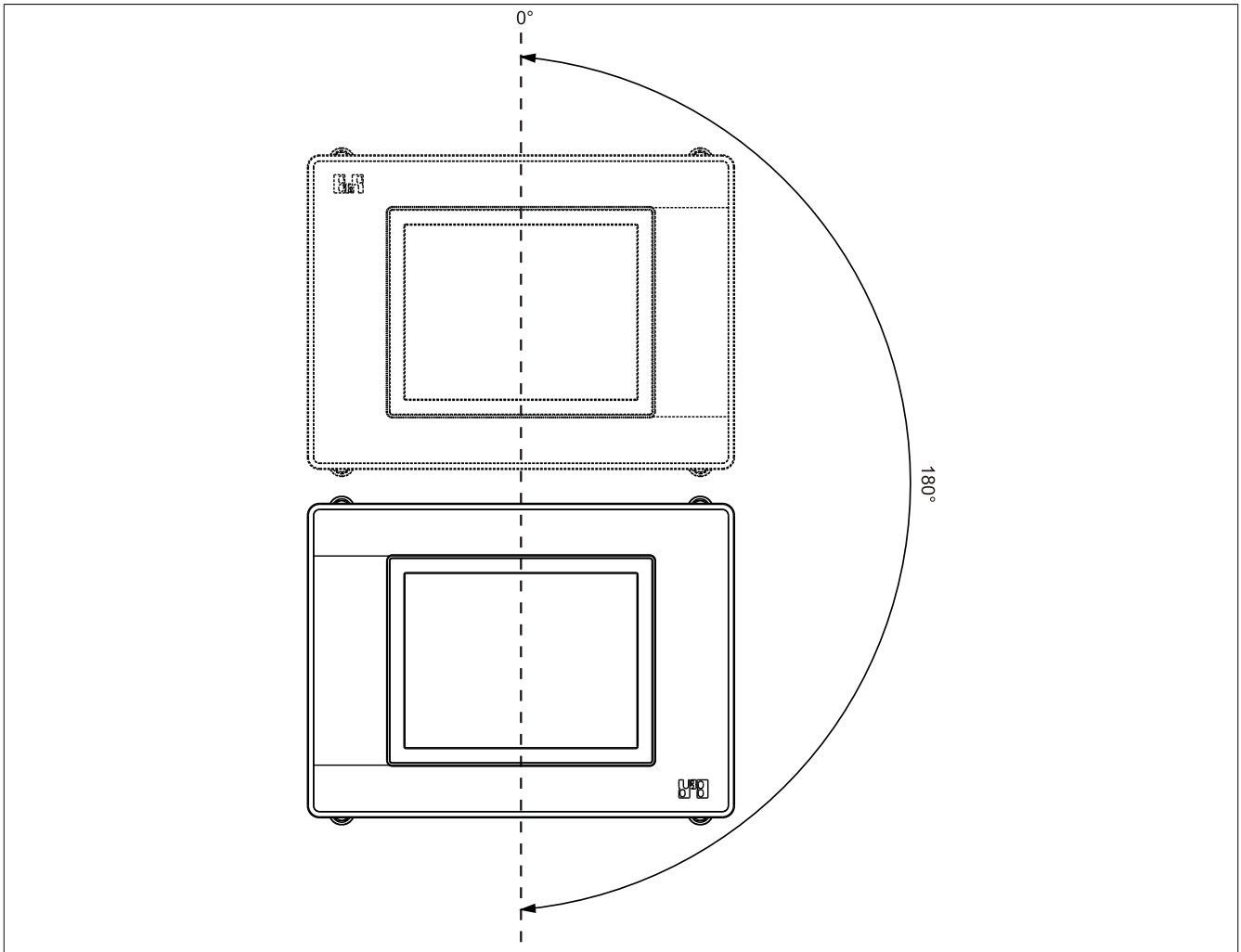

Figure 65: Mounting orientation 180°

In order to facilitate natural air circulation, devices must be mounted according to the spacing indicated in the section "Spacing for air circulation" on page 138.

1.5 Spacing for air circulation

In order to guarantee sufficient air circulation, allow the specified amount of space above, below, to the side and behind the Power Panel 500. The minimum specified spacing is indicated in the following diagram. This applies to all Power Panel 500 variants.

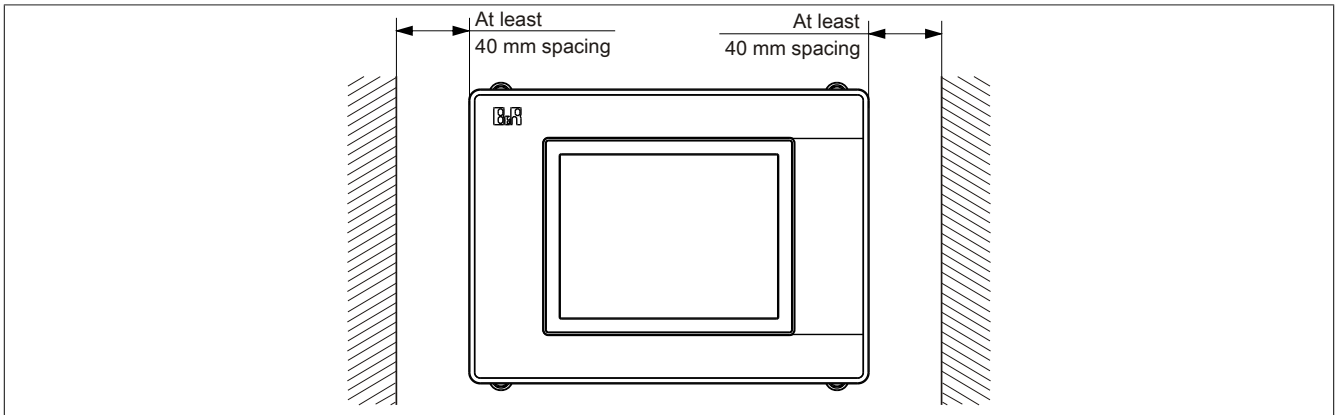

Figure 66: Spacing for air circulation - Front view

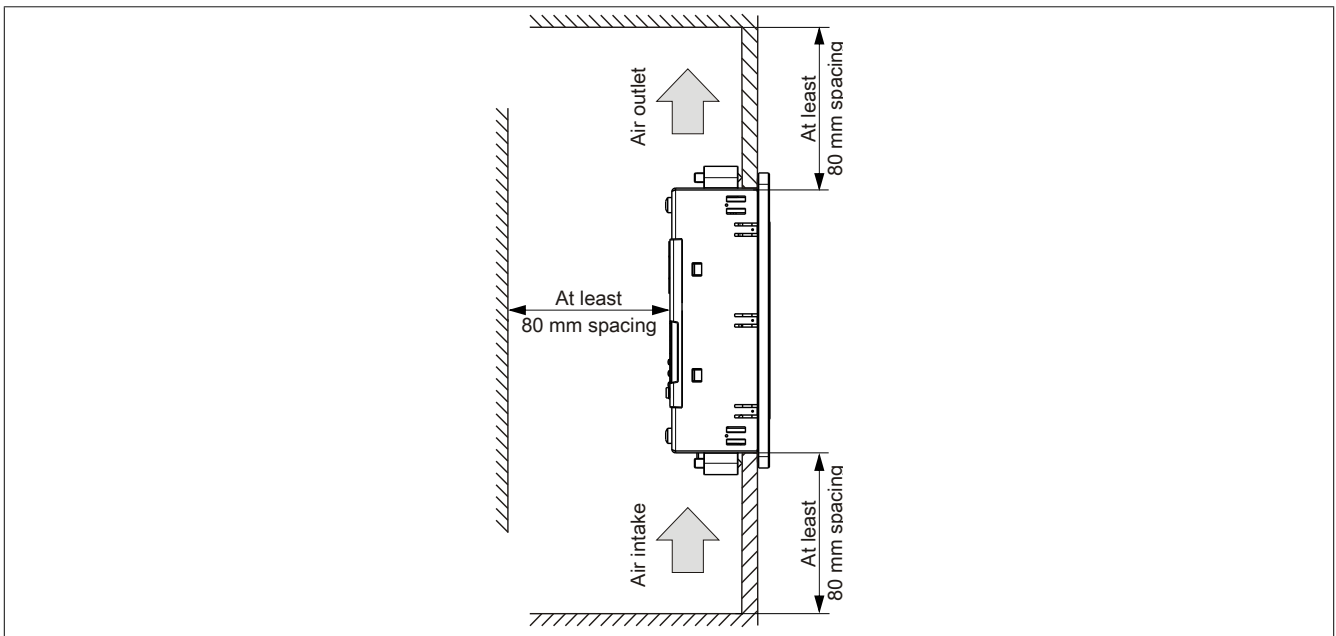

Figure 67: Spacing for air circulation - Side view

Information:

The spacing specifications for air circulation are based on the worst-case scenario for operation at the maximum specified ambient temperature (see "Temperature specifications" in the chapter "Technical data").

If the spacing specifications for air circulation cannot be adhered to, then the maximum specified temperatures for the temperature sensors (see "Temperature sensor locations" in the chapter "Technical data") must be monitored by the user and appropriate measures taken if they are exceeded.

2 General instructions for performing temperature testing

The purpose of these instructions is to explain general procedures for performing application-specific temperature testing on B&R Industrial PCs and Power Panels. Nevertheless, these instructions are meant to serve only as a guideline.

2.1 Procedure

In order to obtain accurate results, the testing conditions should match the conditions in the field. This means that for the duration of the temperature tests, the target application should be running, the PC should be installed in the control cabinet that will be used, etc.

In addition, a temperature sensor should be installed for the device being tested to provide live monitoring of the ambient temperature. In order to obtain accurate measurements, this sensor should be installed at a distance of 5 to 10 cm from the B&R Industrial PC near the air intake (not near the exhaust).

All B&R Industrial PCs and Power Panels are equipped with internal temperature sensors. These are installed in different locations for each series. The number of sensors and the temperature limits also vary from series to series.

For information about the locations of temperature sensors and the maximum specified values, please see section "Temperature sensor locations" in chapter 2 "Technical data".

To ensure that the thermal situation is evaluated reliably, a minimum of 8 hours is recommended for testing.

2.2 Evaluating temperatures in Windows operating systems

2.2.1 Evaluating with the B&R Control Center

The B&R Control Center can be used to evaluate the temperatures. Temperatures can be viewed on the "Temperatures" property page. The B&R Control Center is available at no cost in the Downloads section of the B&R website (www.br-automation.com). The B&R Control Center uses the B&R Automation Device Interface (ADI).

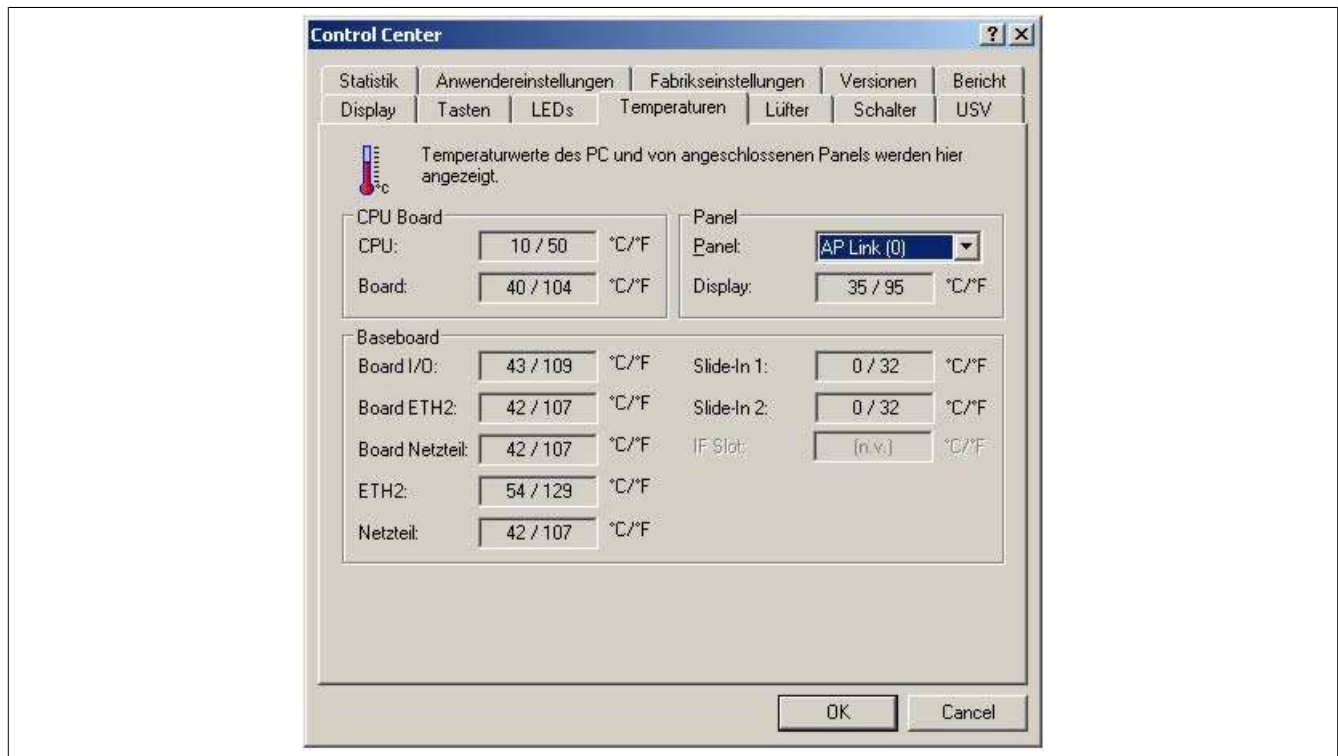

A separate application can be developed if it is necessary to collect historical data.

Information:

Software development kits such as the ADI .NET SDK are available on the B&R website (www.br-automation.com).

2.2.2 Evaluating with the BurnInTest tool from Passmark

If a separate application is not created or used to evaluate the temperature, then B&R recommends using the BurnInTest software tool from Passmark.

Standard and Professional versions of BurnInTest are available. In addition to the software package, there are also various loopback plugs (serial, parallel, USB, etc.) and test CDs/DVDs available. The exact software and loopback plugs used will determine the corresponding load that can be generated on the system and peripheral devices.

Information:

Loopback plugs are also available from Passmark. More information is available at www.passmark.com.

The following screenshots are based on Passmark BurnInTest Pro V4 and a 2-slot APC810 with DVD.

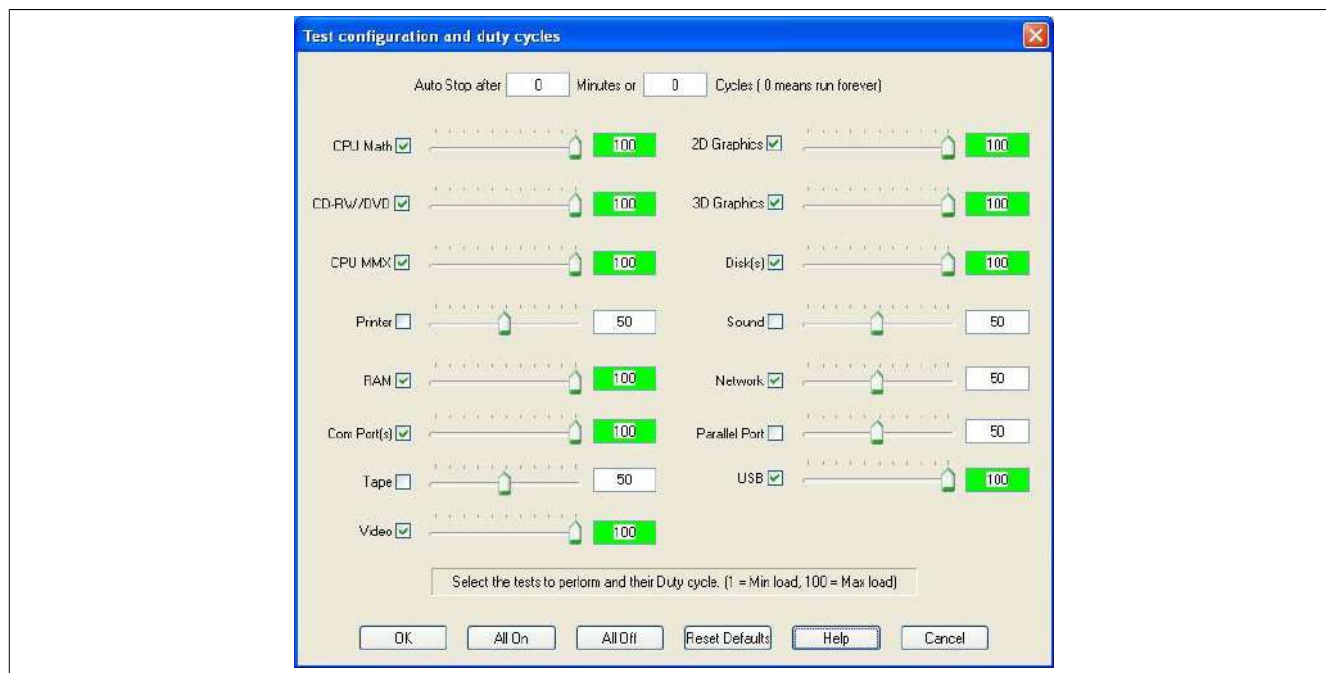

Figure 68: Settings for Passmark BurnInTest Pro V4 and a 2-slot APC810 with DVD

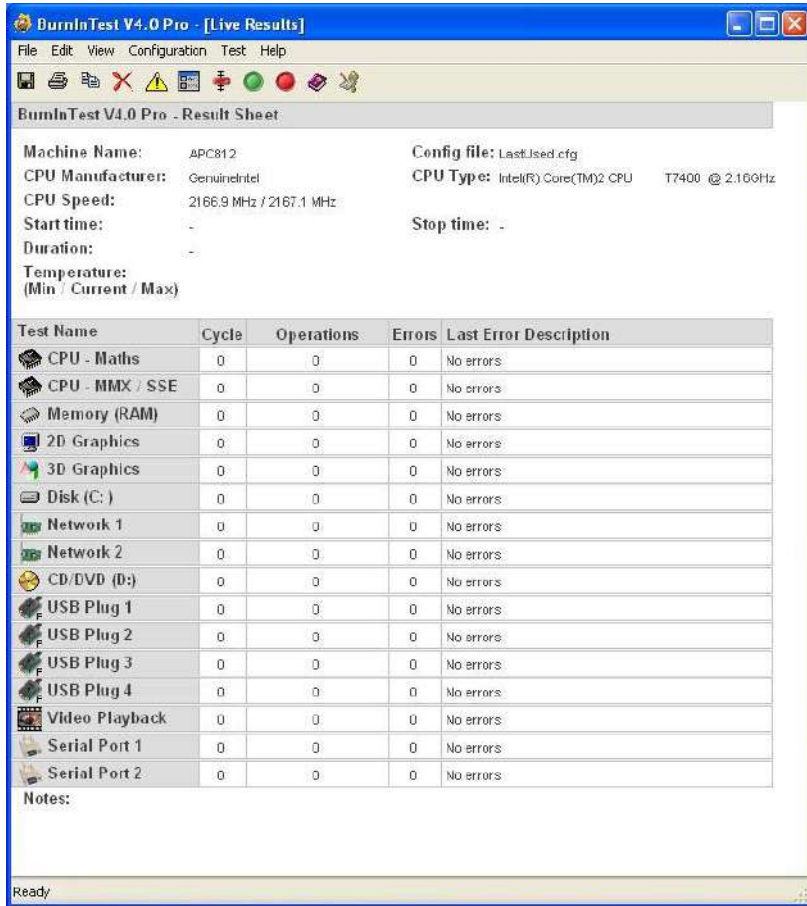

Figure 69: Test overview of a 2-slot APC810 with DVD

The respective test properties may need to be fine-tuned depending on the availability of a loopback plug and DVDs.

Information:

USB flash drives can also be used if a USB loopback plug is not available. The USB flash drives must be detected as formatted drives in Windows. The test USB must then be deselected, and the USB flash drives must be configured as the testing device in the disk properties.



Information:

Serial loopback plugs are relatively easy to create. Simply connect several pins on the serial interface with wires.

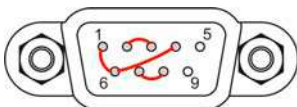

2.3 Evaluating temperatures in operating systems other than Windows

For applications that don't use Windows, temperatures can be evaluated with the help of the B&R implementation guide. In addition to the implementation guide, there are also programs available in MS-DOS.

The implementation guide only describes device-specific functions and not the main functions of the example programs.

If code from the example programs is used, it is important to observe the notes in the implementation guide regarding TODO statements, I/O access functions, etc.

Information:

Example programs and implementation guides for all B&R Industrial PCs and Power Panels are available at no cost from the B&R website (www.br-automation.com).

2.4 Evaluating the measurement results

The maximum temperature value recorded by each sensor must not exceed the temperature limits specified in the user's manuals.

If the temperature tests cannot be performed in a climate-controlled chamber, they can still be performed in an office environment. In this case, however, it is necessary to measure the ambient temperature. Experience at B&R has shown that values measured on passive systems (systems without a fan kit) can be projected linearly based on the ambient temperature. In order to be able to project the temperature values for systems with a fan kit, the fans must be running. It is also important to take values such as speed into consideration.

If the temperature tests are performed in a climate-controlled chamber with fans, the fans will cool the devices and skew the results. Measurement results for passive devices would therefore be unusable in this case. In order to obtain accurate results in climate-controlled chambers with fans, the fans must be turned off and the device must be allowed to run for a sufficient amount of time (several hours) before beginning the test.

Example using a 2-slot APC810

The following example is only valid if the instructions for installation and mounting orientation provided in the user's manual are observed.

Temperature sensor	Measured temperature	Projected temperature	
Ambient temperature	20°C	35°C	45°C
CPU	48°C	63°C	73°C
CPU board	51°C	66°C	76°C
Board I/O	51°C	66°C	76°C
Board ETH2	52°C	67°C	77°C
Board power supply	51°C	66°C	76°C
ETH2	65°C	80°C	90°C
Power supply	51°C	66°C	76°C

Table 98: Evaluation example using a 2-slot APC810

3 Cable connections

Flex radius specifications must be taken into account when installing or connecting cables.

Information:

The maximum torque for the locating screws is 0.5 Nm.

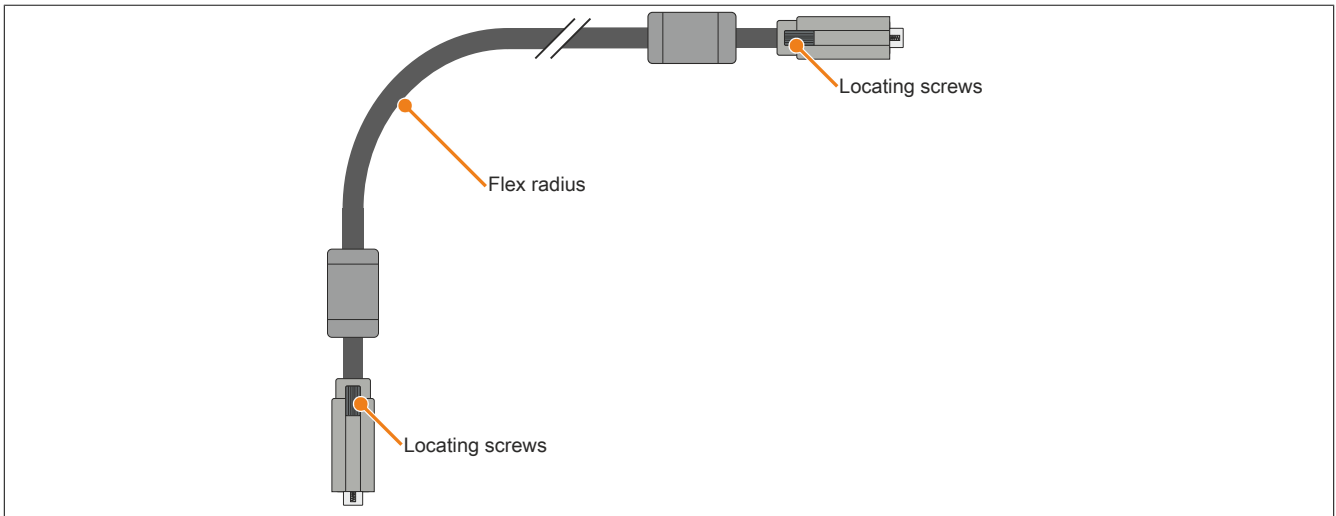

Figure 70: Flex radius - Cable connection

Information:

The specified flex radius is listed in the technical data for the respective cable.

4 Grounding concept

Functional ground is a current path of low impedance between electrical circuits and ground. It is used, for example, to improve immunity to disturbances and not necessarily as a protective measure. It therefore serves only to deflect disturbances, not to provide any kind of protection against electric shock.

This device comes equipped with two functional ground connections:

- Power supply
- Ground connection

To guarantee safe conductance of electric disturbances, the following points must be observed:

- The device must be connected to the central grounding point in the control cabinet using the shortest route possible.
- A cable with a minimum cross section of 2.5 mm² per connection should be used. If a cable with wire end sleeves is connected to the 0TB103.9 or 0TB103.91 terminal block, then a cable with maximum 1.5 mm² per connection is possible.
- Note the line shielding concept. All data cables connected to the device must be shielded.

Symbol indicating functional ground on the B&R device: 

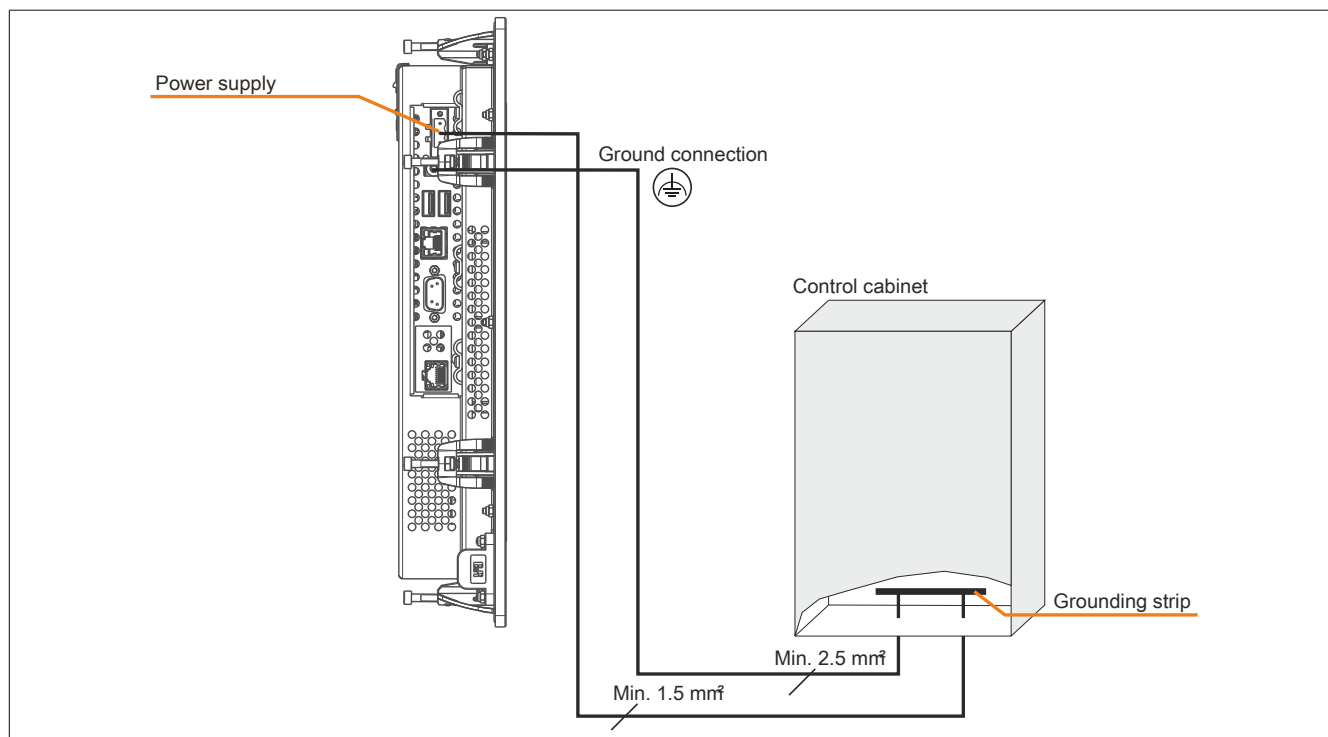

Figure 71: Grounding concept

5 Connecting peripheral USB devices

Warning!

Peripheral USB devices can be connected to the USB interfaces on this device. Due to the vast number of USB devices available on the market, B&R cannot guarantee their performance. USB devices from B&R are guaranteed to function properly, however.

5.1 Locally on the PP500

Many different peripheral USB devices can be connected to the 2 or 3 USB ports. USB ports USB1 and USB2 can each handle a load of 1 A, and USB3 (only on PP500 devices with 10.4", 12.1" and 15" displays) can handle 500 mA. The maximum transfer rate is USB 2.0.



Figure 72: Local connection of USB peripheral devices on the PP500

5.2 Remote connection to Automation Panel 900 via DVI

Many different peripheral USB devices can be connected to the 2 or 3 USB ports on the Automation Panel 900. These can each handle a load of 500 mA. The maximum transfer rate is USB 2.0.

Information:

Automation Panel 900 devices can only be connected to a Power Panel 500 with an I/O board.

Information:

Only end devices (not hubs) can be connected to the Automation Panel 900.



Figure 73: Remote connection of USB peripheral devices on the APC900 via DVI

5.3 Remote connection to Automation Panel 800 / 900 via SDL

Many different peripheral USB devices can be connected to the 2 or 3 USB ports on Automation Panel 900 or the USB interfaces on Automation Panel 800 devices. These can each handle a load of 500 mA. The maximum transfer rate is USB 1.1.

Information:

Automation Panel 800 / 900 devices can only be connected to a Power Panel 500 with an I/O board.

Information:

Only end devices (no hubs) can be connected to the Automation Panel 800 / 900.



Figure 74: Remote connection of USB peripheral devices on the APC800/900 via SDL

6 Key and LED configuration

Each button and LED can be individually configured and adapted directly to the application. Various B&R tools are available for this:

- B&R Key Editor for Windows operating systems
- Visual Components for Automation Runtime

Keys and LEDs from each device are processed by the matrix controller in a bit sequence of 128 bits each.

The positions of keys and LEDs in the matrix are shown as hardware numbers. These hardware numbers can be read directly from the target system using the B&R Key Editor or B&R Control Center.

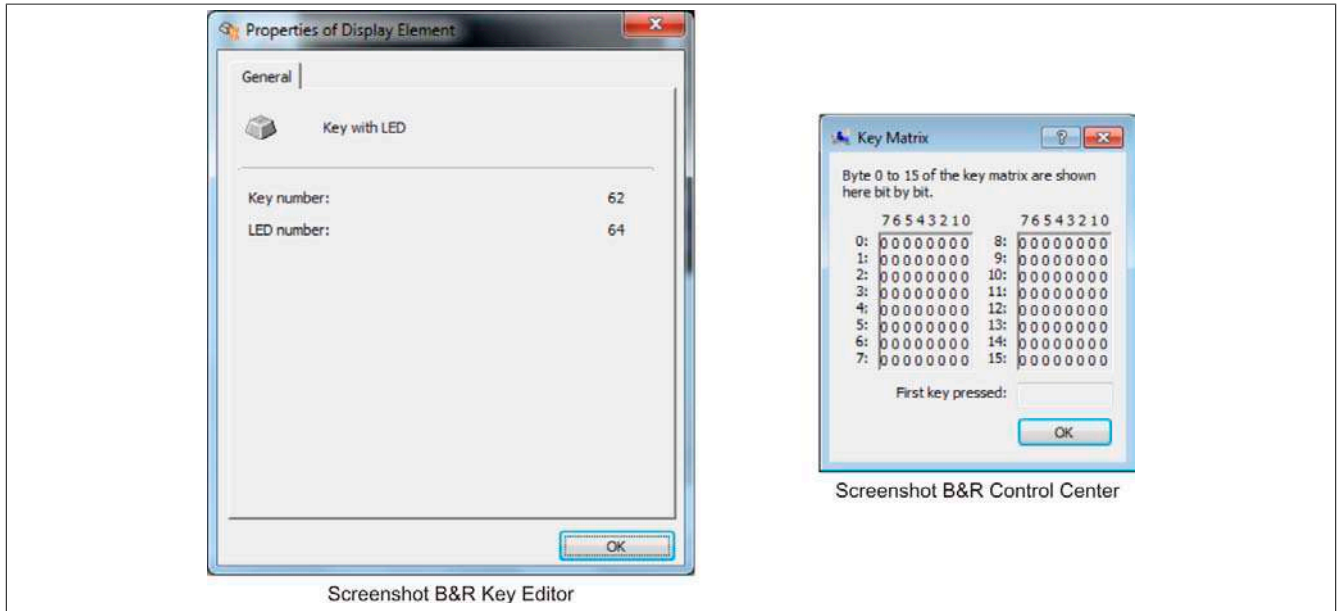

Figure 75: Hardware numbers in the B&R Key Editor and B&R Control Center

The images below show the positions of buttons and LEDs in the matrix. This information is indicated as follows.

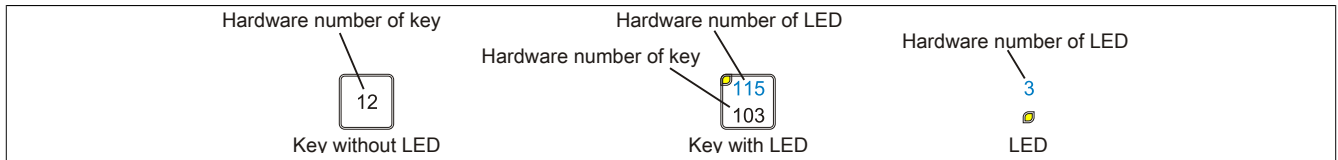

Figure 76: Display - Keys and LEDs

6.1 5PP551.0573-00

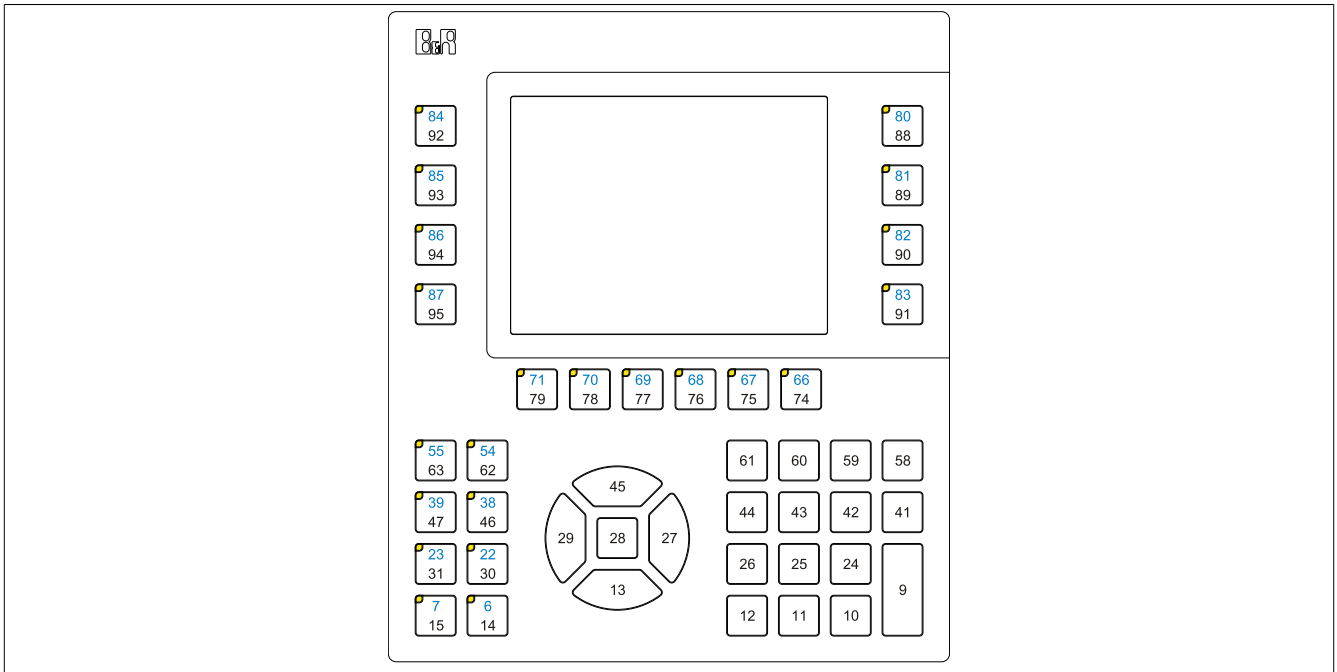

Figure 77: 5PP551.0573-00 - Key and LED configuration

6.2 5PP552.0573-00

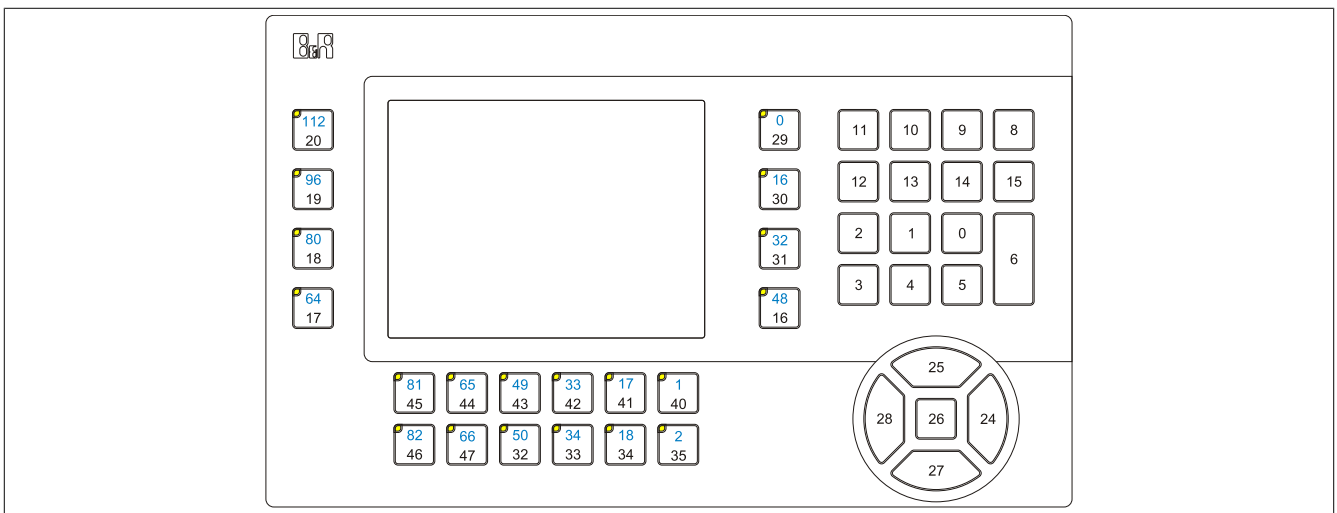

Figure 78: 5PP552.0573-00 - Key and LED configuration

6.3 5PP580.1043-00

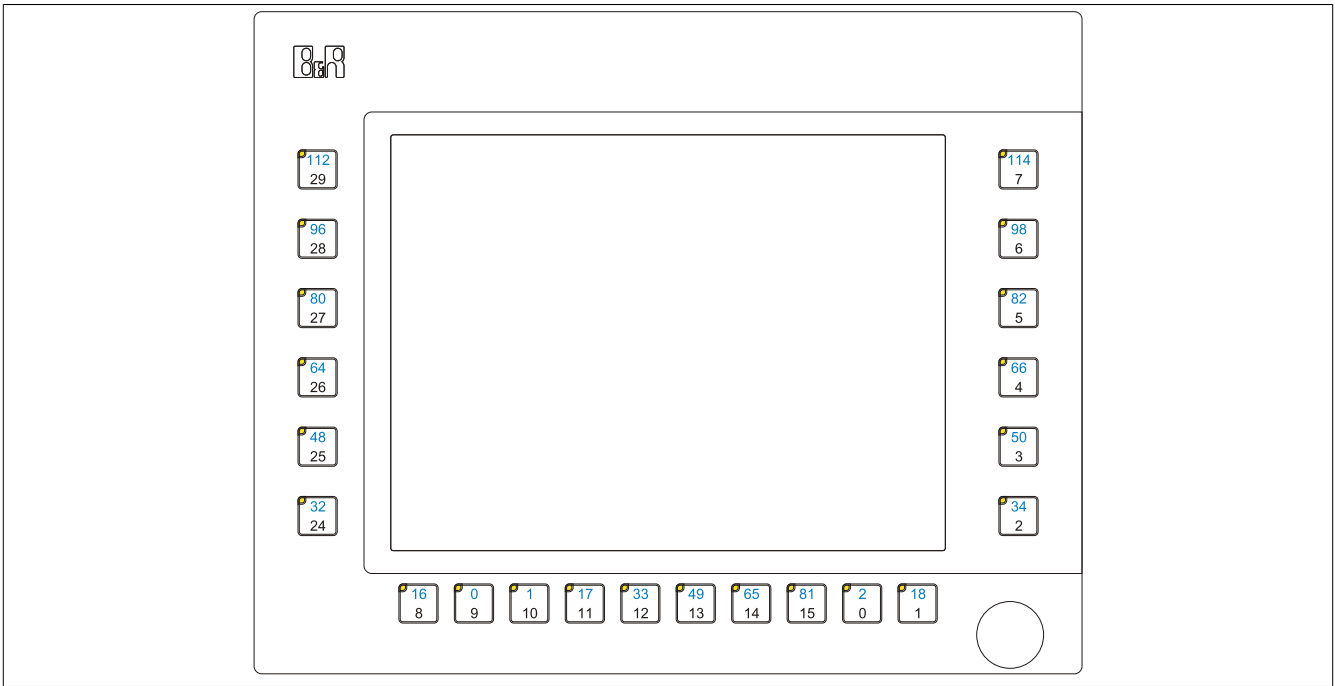

Figure 79: 5PP580.1043-00 - Key and LED configuration

6.4 5PP581.1043-00

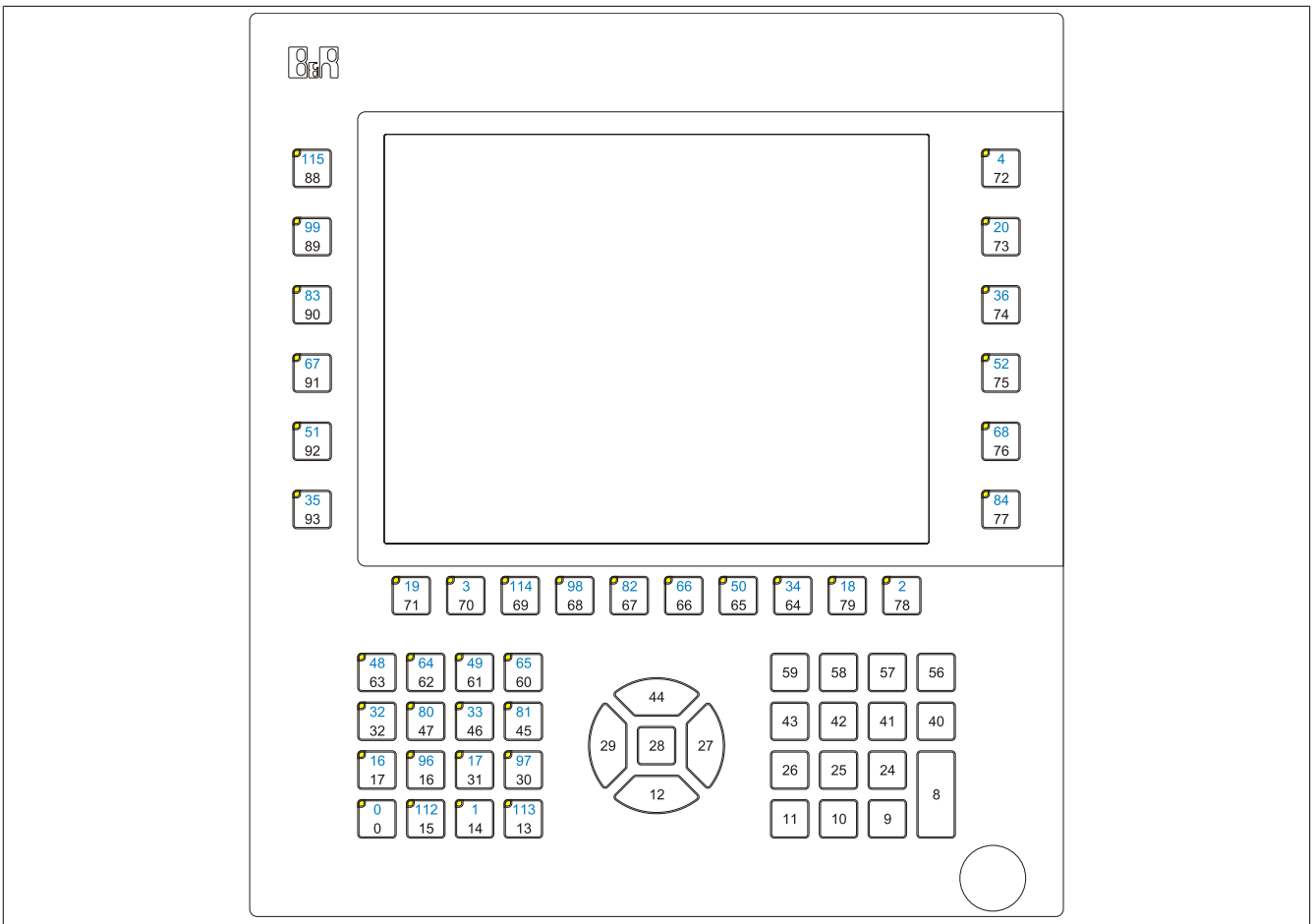

Figure 80: 5PP581.1043-00 - Key and LED configuration

6.5 5PP582.1043-00

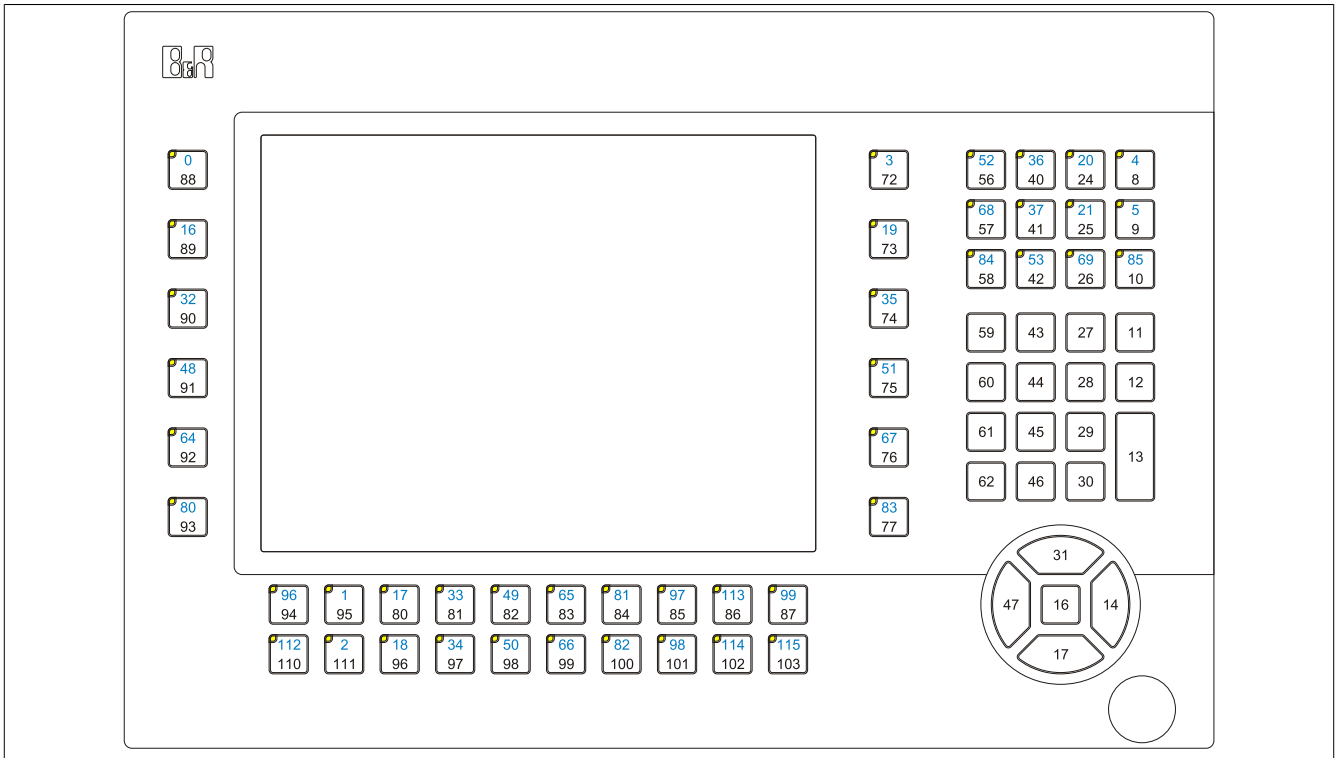

Figure 81: 5PP582.1043-00 - Key and LED configuration

6.6 5PP580.1505-00

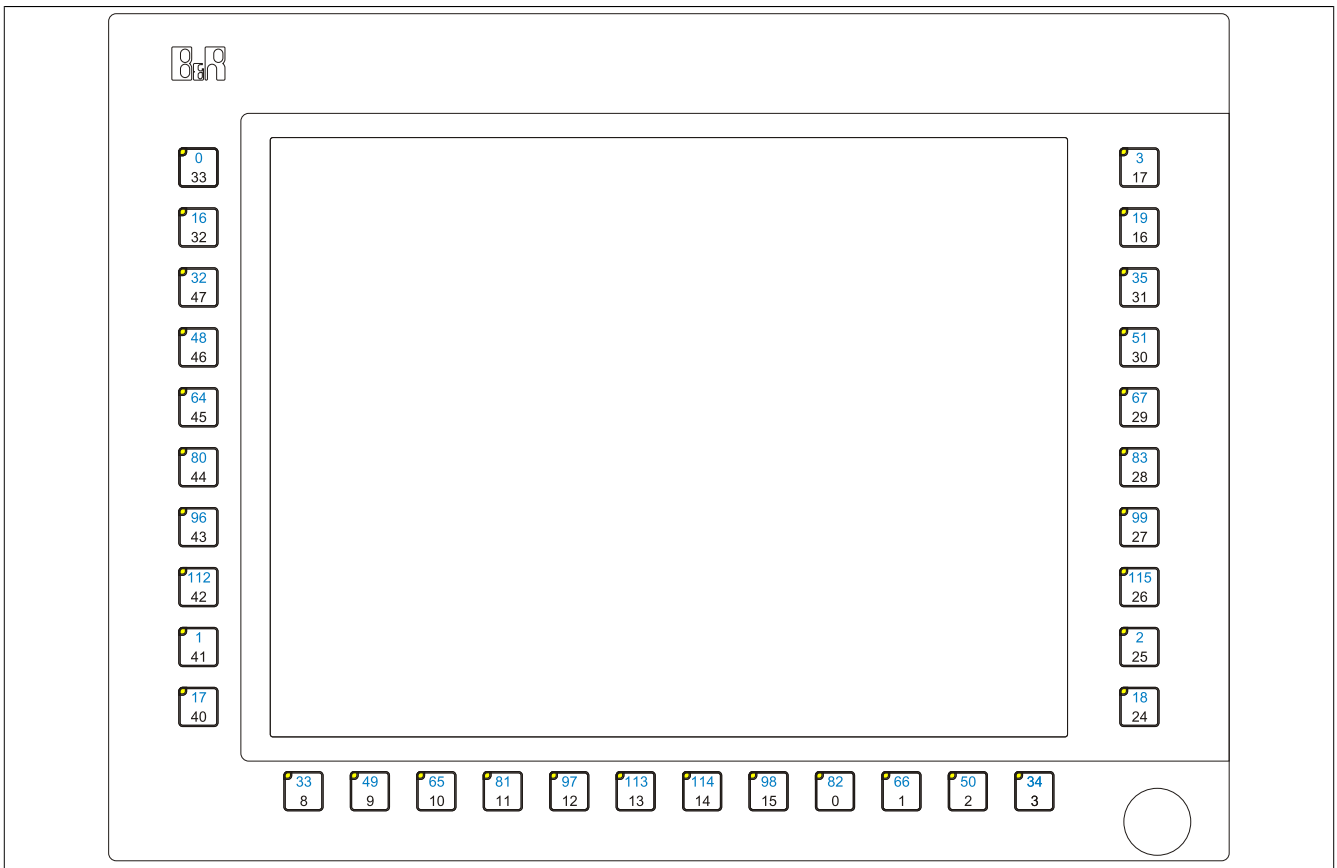

Figure 82: 5PP580.1505-00 - Key and LED configuration

6.7 5PP581.1505-00

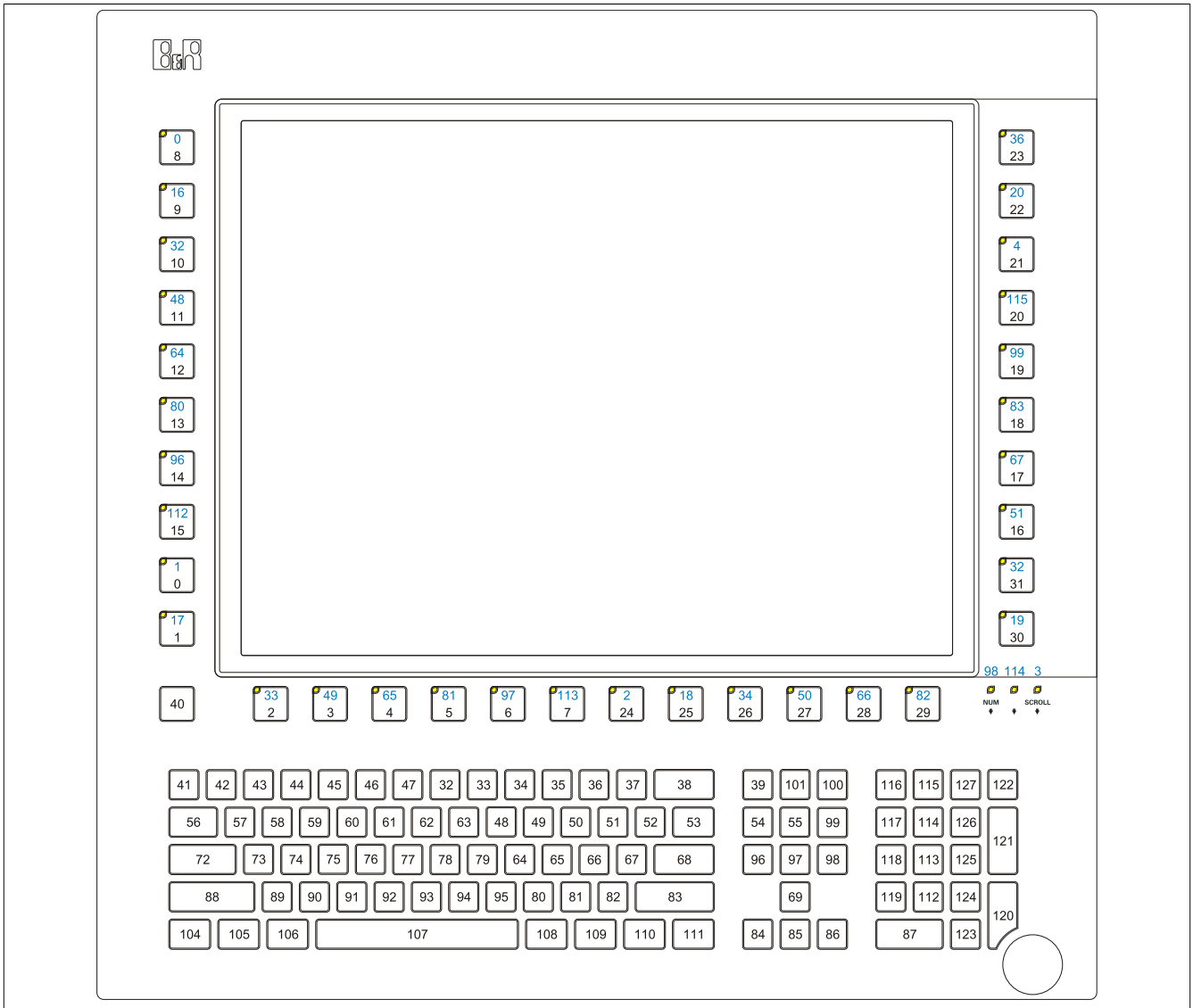

Figure 83: 5PP581.1505-00 - Key and LED configuration

7 Touch screen calibration

B&R touch screen devices are equipped with a B&R touch controller that supports hardware calibration. As a result, devices are pre-calibrated when delivered. This is an advantageous feature when replacing devices of the same model or type since it avoids having to recalibrate the new device. Nevertheless, calibrating the device is still recommended in order to achieve the best results and to better adapt the touch screen to the user's preferences.

7.1 Windows CE

Windows CE starts the touch screen calibration sequence during its first boot in its default configuration (i.e. delivered state).

7.2 Windows XP Professional

After installing Windows XP Professional on the device, the touch screen driver must be installed in order to operate the touch screen. The necessary driver is available in the Downloads section of the B&R website (www.br-automation.com).

7.3 Windows Embedded Standard 2009

After starting Windows Embedded Standard 2009 on the Panel PC or Power Panel for the first time (first boot agent), the corresponding touch screen driver is installed automatically.

On all other devices, the touch screen driver must be installed in order to operate the touch screen. The necessary driver is available in the Downloads section of the B&R website (www.br-automation.com).

7.4 Windows 7 Professional / Ultimate

After installing Windows 7 on the device, the touch screen driver must be installed in order to operate the touch screen. The necessary driver is available in the Downloads section of the B&R website (www.br-automation.com).

7.5 Windows Embedded Standard 7 Embedded / Premium

A touch screen driver will be installed automatically if a touch controller is detected during the Windows Embedded Standard 7 installation.

The touch screen driver must be installed manually if a touch controller was not detected during the Windows Embedded Standard 7 setup or if an Automation Panel has been connected after setup. The necessary driver is available in the Downloads section of the B&R website (www.br-automation.com).

7.6 Automation Runtime / Visual Components

The touch screen must be calibrated once for the customer application when commissioning the device and project.

8 Tips for extending the service life of the display

8.1 Backlight

The service life of the backlight is specified by its "half-brightness time". For example, a specified operating time of 50,000 hours means that the display would still retain 50% of its brightness after this time.

8.1.1 How can the service life of the backlight be extended?

- By setting the display brightness to the lowest value that is still comfortable for the eyes
- By using dark images
- By reducing the brightness by 50%, which can result in an approximately 50% increase in the half-brightness time

8.2 Screen burn-in

Screen burn-in refers to the "burning in" of a static image on a display after being displayed for a prolonged period of time. Nevertheless, static images are not the only cause of screen burn-in. Screen burn-in is also referred to as burn-in effect, image retention, memory effect, memory sticking or ghost image.

There are basically two types:

- Area type: This type of screen burn-in is indicated by a dark gray image. The effect will disappear if the display is switched off for a long period of time.
- Line type: This type of screen burn-in can cause lasting damage.

8.2.1 What causes screen burn-in?

- Static images
- No screensaver
- Sharp transitions in contrast (e.g. black/white)
- High ambient temperatures
- Operation outside of specifications

8.2.2 How can screen burn-in be avoided?

- By constantly changing between static and dynamic images
- By avoiding excessive brightness differences between foreground and background elements
- By using colors with similar brightness
- By using complementary colors in follow-up images
- By using a screensaver

9 Pixel errors

Information:

Displays may contain defective pixels (dead/stuck pixels) that result from the manufacturing process. These flaws are not grounds for reclamation or initiating a warranty claim.

10 Known problems/issues

The following issues for the PP500 devices are known:

- HD resolution (1366x768) is not completely supported by VBIOS, which causes display errors after POST. The image flickers and is shifted down a line. BIOS POST and BIOS Setup are still displayed correctly, however. This effect occurs when using operating systems for which no driver is available (e.g. MS-DOS) or before the operating system's graphics driver is started (e.g. Windows XP boot logo). HD resolution is displayed corrected again when Windows XP or Windows 7 is booted properly with an installed graphics driver.
- The monitor/panel interface does not support RGB signals.

Chapter 4 • Software

1 BIOS options

Information:

The following diagrams, BIOS menu items and their descriptions refer to BIOS version 1.00. It is therefore possible that these diagrams and BIOS descriptions will not correspond with the BIOS version actually installed.

1.1 General information

BIOS is an acronym for "Basic Input/Output System". It is the most basic standardized interface between the user and the system (hardware). The BIOS system used in this B&R Industrial PC is produced by Insyde.

The BIOS Setup utility can be used to modify basic system configuration settings. These settings are stored in CMOS and EEPROM memory (as a backup).

CMOS data is buffered by a battery (if present) and continues to remain stored on the B&R Industrial PC even when the power is turned off (no 24 VDC supply).

1.2 BIOS Setup and boot procedure

BIOS is immediately activated when switching on the power supply or pressing the power button on the B&R Industrial PC. The system checks if the setup data from EEPROM memory is "OK". If the data is "OK", then it is transferred to CMOS. If the data is "Not OK", then the CMOS data is checked to see whether it is valid. An error message is output if the CMOS data contains errors, and the boot procedure can be continued by pressing <F1>. To prevent an error message from appearing at each restart, the BIOS Setup utility can be opened by pressing . The settings can then be re-saved.

BIOS reads the system configuration information, checks and configures the system with the Power-On Self-Test (POST).

When these "preliminaries" are finished, BIOS looks for an operating system on the available data storage devices (hard drive, floppy drive, etc.). BIOS then launches the operating system and hands over to it the control of system operations.

To enter BIOS Setup, the <F2> key must be pressed after the USB controller has been initialized as soon as the following message appears on the monitor (during POST): "Press F2 to go to Setup Utility"

Information:

The POST screen is only displayed for a fraction of a second due to optimized boot procedures. It is still possible to enter BIOS, however.

Processor Type : Intel(R) Atom(TM) CPU Z520 @ 1.33GHz

System Memory Speed : 533 MHz

CPUID : 106C2

F2 is pressed. Go to Setup Utility.

Other Device 1 : BR-SSD-C004G-01-0101

Figure 84: Bootscreen

1.2.1 BIOS Setup keys

The following keys are enabled during POST:

Information:

Key signals from USB keyboards will only be registered after the USB controller has been initialized.

Keys	Function
F2	Opens the main BIOS Setup screen
F12	<p>Opens the boot menu. This lists all bootable devices that are connected to the system. Select the device to boot from with cursor ↑, cursor ↓ and <ENTER>. Use the ESC key to exit the boot menu.</p> 
<Pause>	Pauses POST. Pressing any other key resumes POST.

Table 99: BIOS-relevant keys for POST

The following keys can be used once inside BIOS Setup:

Key	Function
F1	Opens general help information
Cursor ↑	Moves to the previous item
Cursor ↓	Moves to the next item
Cursor ←	Moves to the previous menu
Cursor →	Go to the next menu
F5/F6	Change BIOS settings
Enter	Changes to the selected screen
F9	Loads and configures CMOS default values for all BIOS settings
F10	Saves and exits
ESC	Exits a submenu

Table 100: BIOS-relevant keys

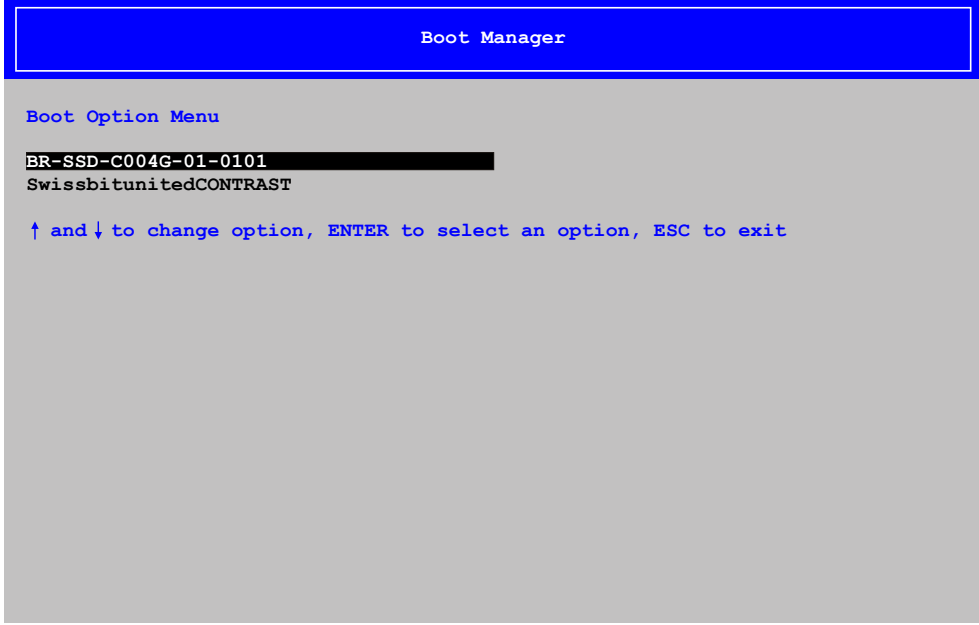
1.3 Main

The main BIOS Setup screen appears immediately after the <F2> button is pressed during startup.

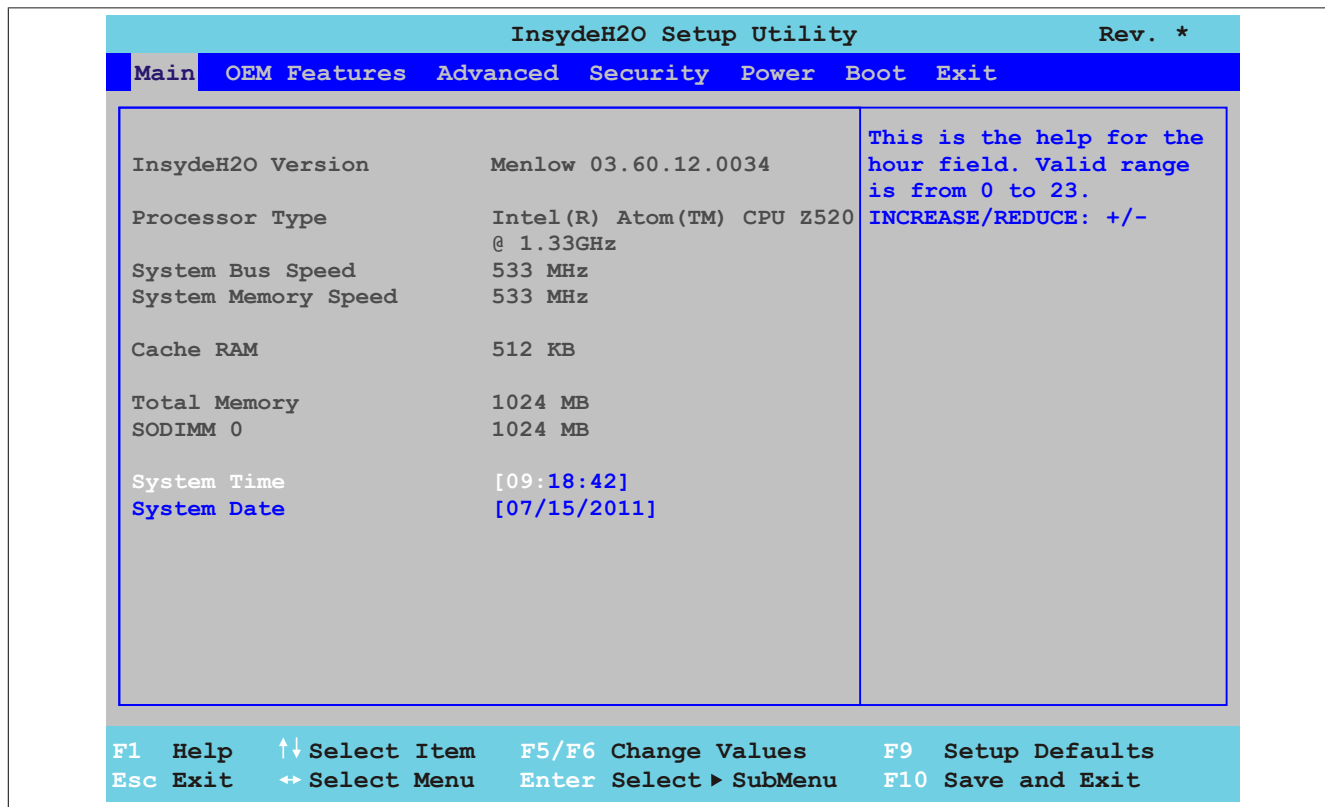

Figure 85: US15W Main - Menü

BIOS setting	Function	Configuration options	Effect
InsydeH2O version	Displays the BIOS InsydeH2O version	None	-
Processor type	Displays the processor type	None	-
System bus speed	Displays the system bus speed		
System memory speed	Displays the system memory speed	None	-
Cache RAM	Displays the cache RAM in the system	None	-
Total memory	Displays the entire system memory size	None	-
SODIMM 0	Displays the amount of RAM in the SODIMM 0 slot	None	-
System time	The currently configured system time setting. This is buffered by the CMOS battery when the system is switched off.	Changes the system time	Sets the system time in the format Hour:Minute:Second (hh:mm:ss)
System date	The currently configured system date. This is buffered by the CMOS battery when the system is switched off.	Changes the system date	Sets the system date in the format Month:Day:Year (mm.dd.yyyy)

Table 101: US15W Main menu - Configuration options

1.4 OEM features

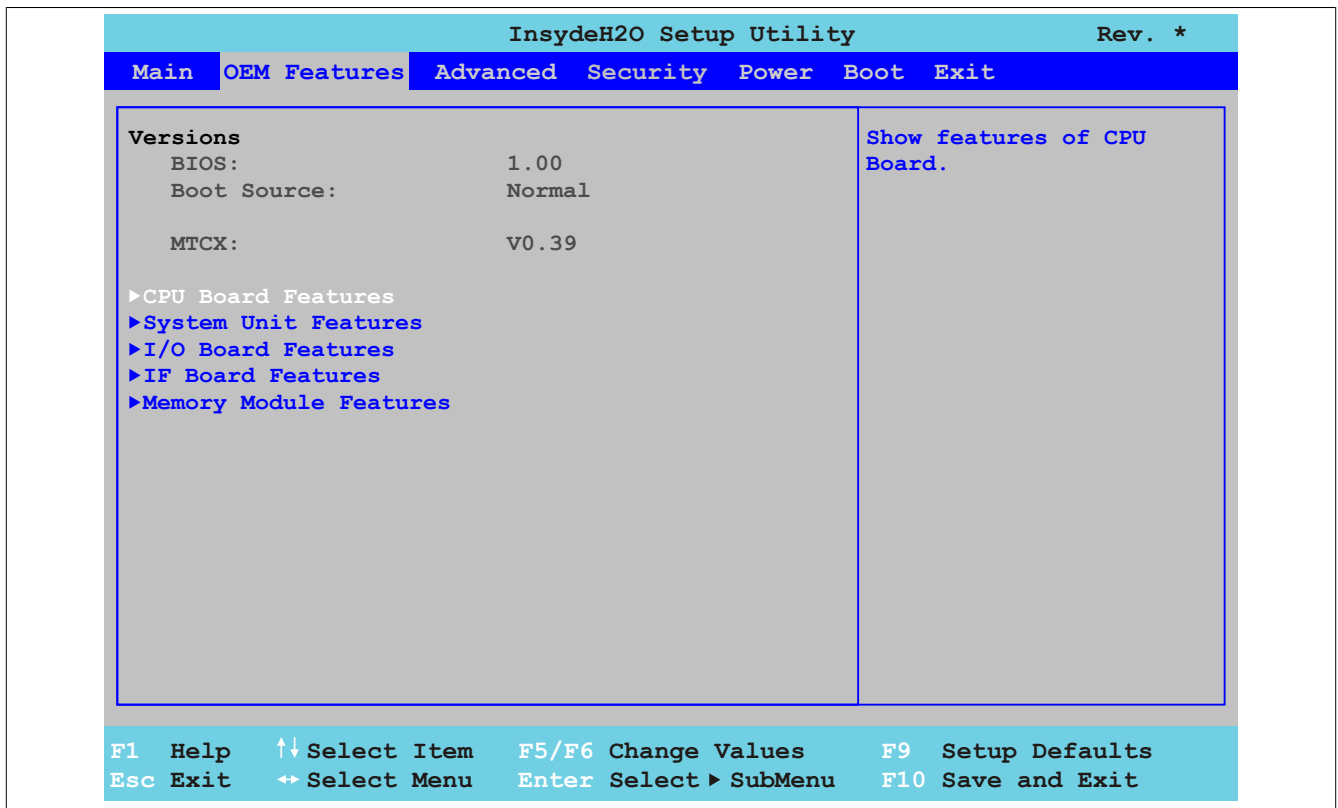

Figure 86: US15W OEM Features - Menü

BIOS setting	Function	Configuration options	Effect
BIOS	Displays the installed B&R BIOS version	None	-
Boot source	Displays whether the normal BIOS version or the backup BIOS version (backup) is booted		Information: If a BIOS update failed, then the backup BIOS will be loaded automatically. The BIOS update can then be attempted again.
MTCX	Displays the installed MTCX version	None	
CPU board features	Displays and configures device-specific settings for the CPU board	Enter	Opens the submenu See "CPU board features" on page 160
System unit features	Displays and configures device-specific settings for the system unit	Enter	Opens the submenu See "System unit features" on page 165
I/O board features¹⁾	Displays device-specific information for the I/O board	Enter	Opens the submenu See "I/O board features" on page 169
IF board features²⁾	Displays device-specific information for the IF board	Enter	Opens the submenu See "IF board features" on page 174
Memory module features	Displays device-specific information for the main memory	Enter	Opens the submenu See "Memory module features" on page 176

Table 102: US15W OEM features menu - Configuration options

- 1) This submenu is only displayed if there is an I/O board connected to the system unit.
- 2) This submenu is only displayed if there is an interface board connected to the system unit.

1.4.1 CPU board features

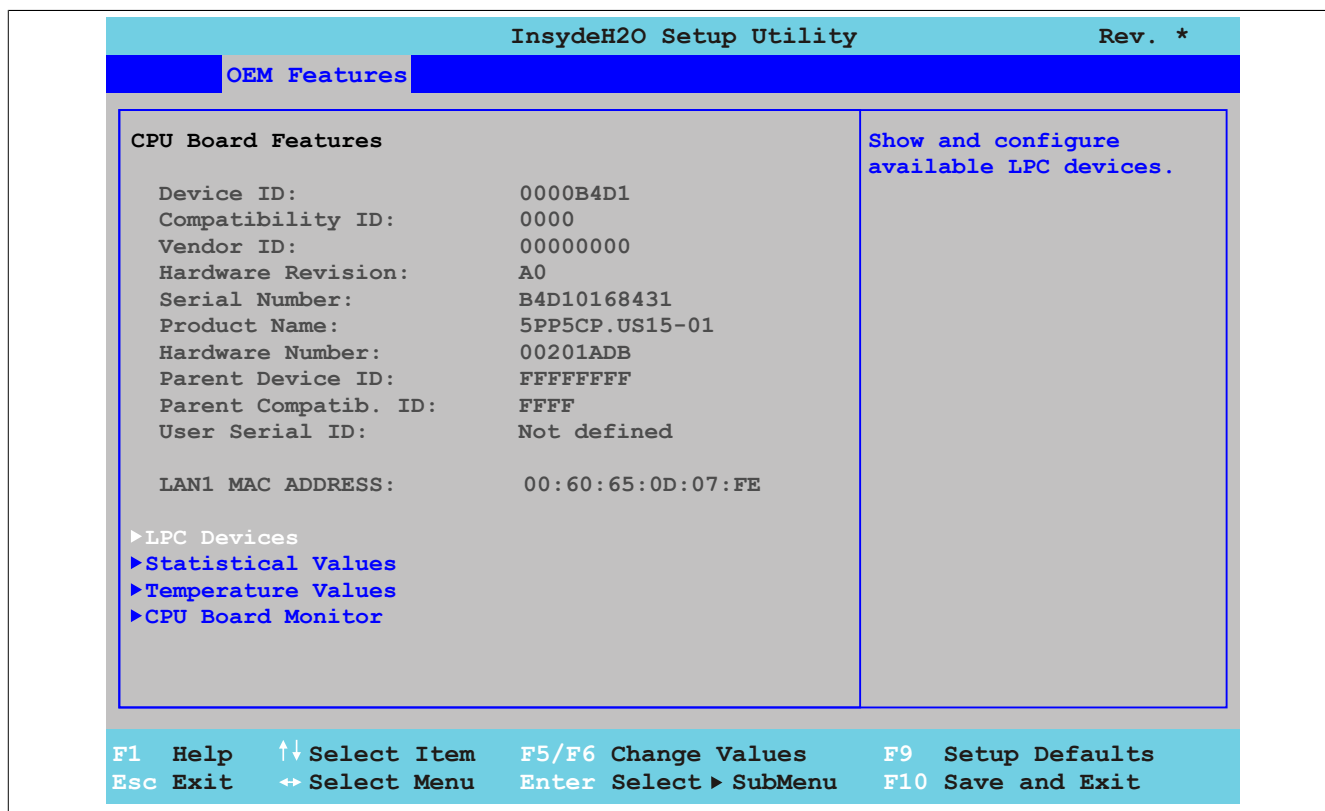

Figure 87: US15W OEM Features - CPU Board Features

BIOS setting	Function	Configuration options	Effect
Device ID	Displays the device ID of the CPU board	None	-
Compatibility ID	Displays the version of the device within the same B&R device ID. This ID is needed for Automation Runtime.	None	-
Vendor ID	Displays the vendor ID	None	-
Hardware revision	Displays the hardware revision of the CPU board	None	-
Serial number	Displays the B&R serial number	None	-
Product name	Displays the B&R model number	None	-
Hardware number	Displays the hardware number of the CPU board	None	-
Parent device ID	Displays the manufacturer number	None	-
Parent compatib. ID	Displays the manufacturer ID	None	-
User serial ID	Displays the user serial ID. This 8-digit hexadecimal value can be freely specified by the user (e.g. to give the device a unique ID) and can only be changed using the "B&R Control Center" included with the ADI driver.	None	-
LAN1 MAC ADDRESS	Displays the assigned MAC address for the ETH interface	None	-
LPC devices	Configures LPC devices	Enter	Opens the submenu See "LPC devices" on page 161
Statistical values	Displays statistical values	Enter	Opens the submenu See "Statistical values" on page 162
Temperature values	Displays current temperature values	Enter	Opens the submenu See "Temperature values" on page 163
CPU board monitor	Displays current voltage values on the CPU board being used	Enter	Opens the submenu See "CPU board monitor" on page 164

Table 103: US15W OEM features - CPU board features - Configuration options

1.4.1.1 LPC devices

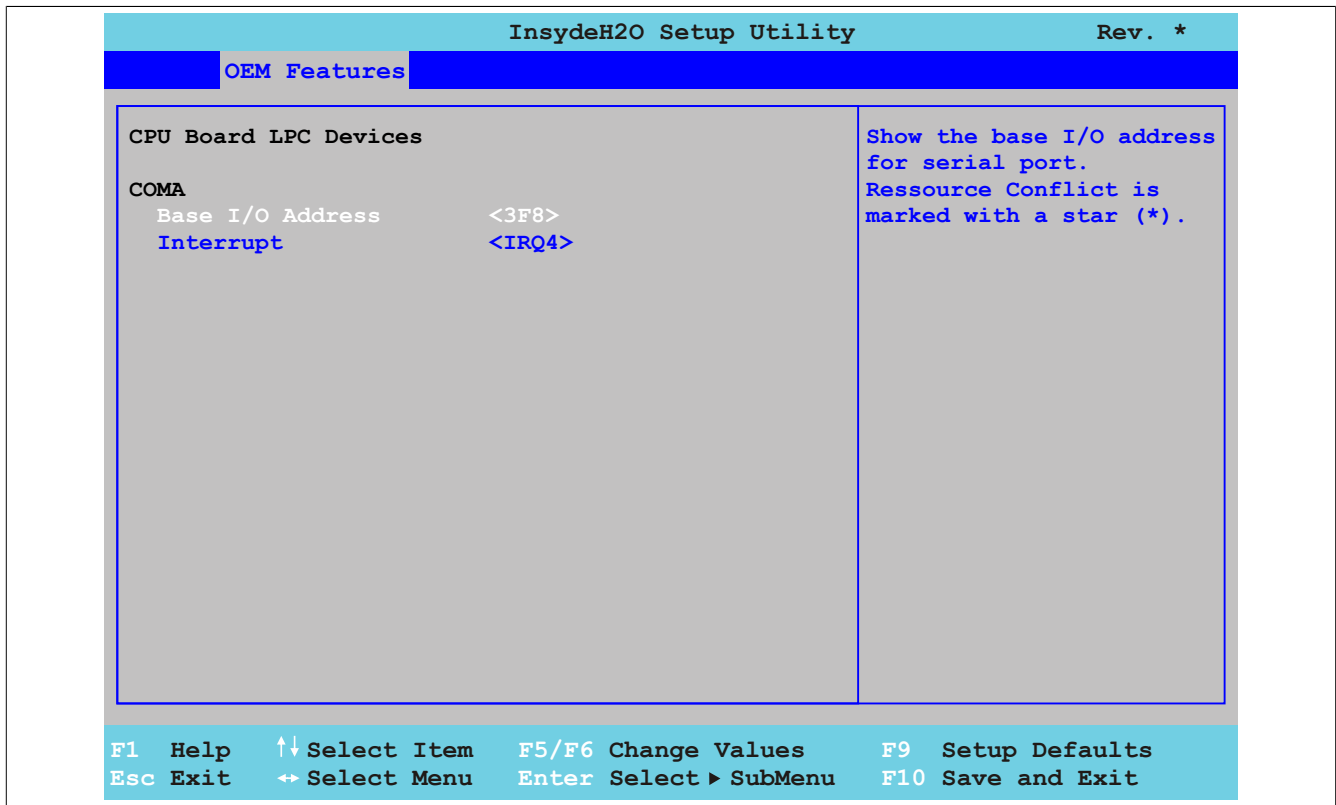

Figure 88: US15W OEM Features - CPU Board Features - LPC Devices

BIOS setting	Function	Configuration options	Effect
COMA	Settings for the COM serial interface	None	-
Base I/O address	Selects the base I/O address of the COM port	Disabled, 238, 2E8, 2F8, 328, 338, 3E8, 3F8	Disables or assigns the selected base I/O address
Interrupt	Selects the interrupt for the COM port	IRQ3, IRQ4, IRQ5, IRQ6, IRQ10, IRQ11, IRQ12	Assigns the selected interrupt

Table 104: US15W OEM features - CPU board features - LPC devices - Configuration options

Information:

A resource conflict can occur with respect to the base I/O address or the interrupt settings (indicated by a warning). In order to still be able to make these settings, the setting for the base I/O address or interrupt currently being used must be changed first.

1.4.1.2 Statistical values

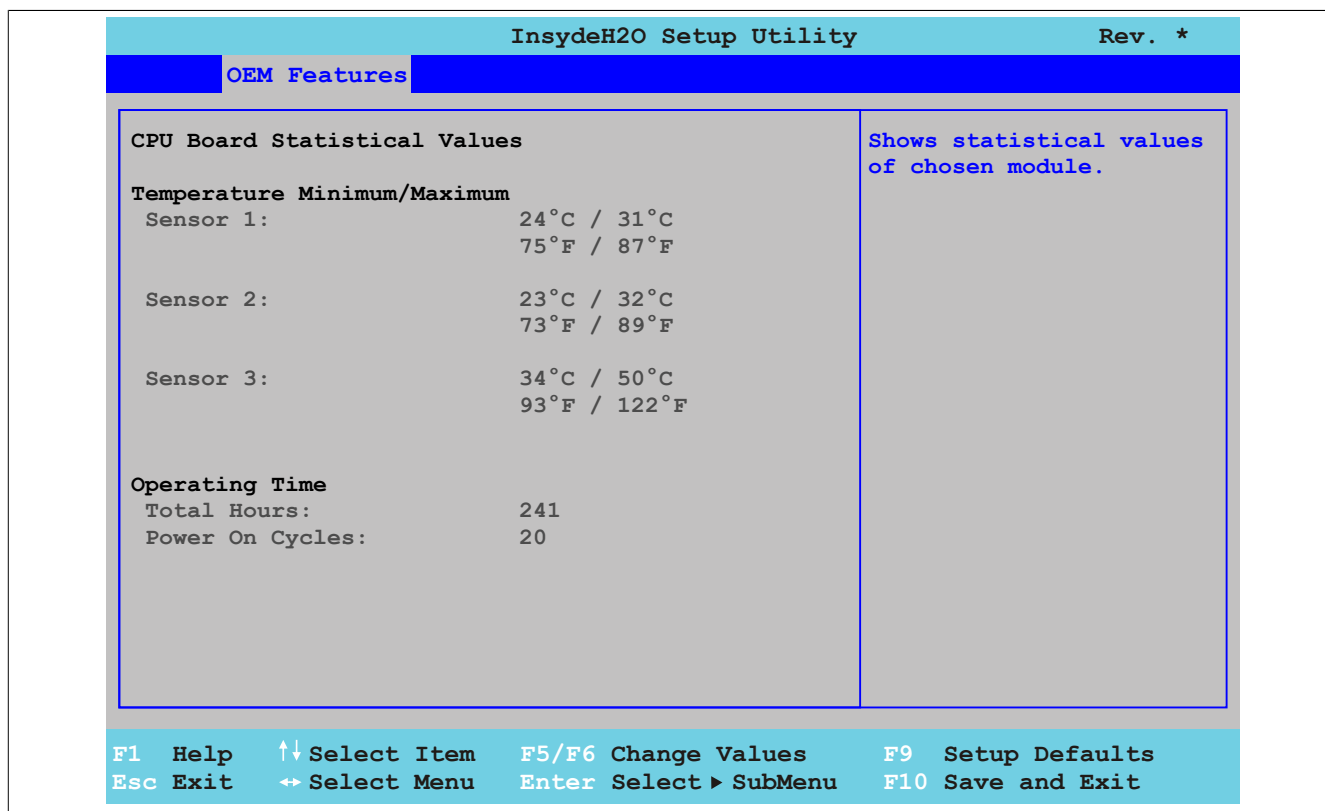

Figure 89: US15W OEM Features - CPU Board Features - Statistical Values

BIOS setting	Function	Configuration options	Effect
Sensor 1	Displays the minimum and maximum temperature of sensor 1 (interfaces) in °C and °F	None	-
Sensor 2	Displays the minimum and maximum temperature of sensor 2 (CPU) in °C and °F	None	-
Sensor 3	Displays the minimum and maximum temperature of sensor 3 (main memory) in °C and °F	None	-
Total hours	Displays the runtime in hours	None	-
Power on cycles	Displays the number of power-on cycles. Each restart increases the counter by one.	None	-

Table 105: US15W OEM features - CPU board features - Statistical values - Configuration options

1.4.1.3 Temperature values

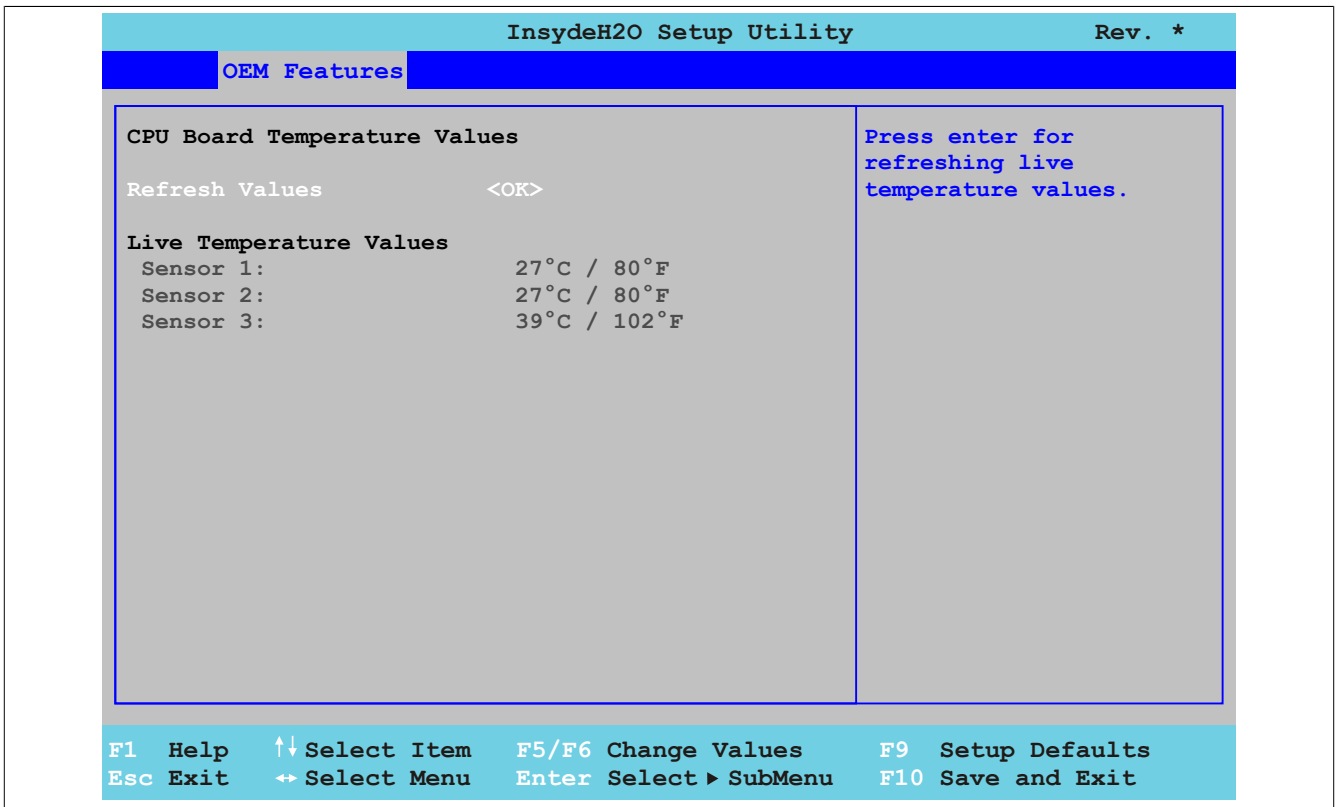

Figure 90: US15W OEM Features - CPU Board Features - Temperature Values

BIOS setting	Function	Configuration options	Effect
Refresh values	Option for refreshing the temperature values	OK	Refreshes the temperature values shown below
Sensor 1	Displays the current temperature of sensor 1 (interfaces) in °C and °F	None	-
Sensor 2	Displays the current temperature of sensor 2 (CPU) in °C and °F	None	-
Sensor 3	Displays the current temperature of sensor 3 (main memory) in °C and °F	None	-

Table 106: US15W OEM features - CPU board features - Temperature values - Configuration options

1.4.1.4 CPU board monitor

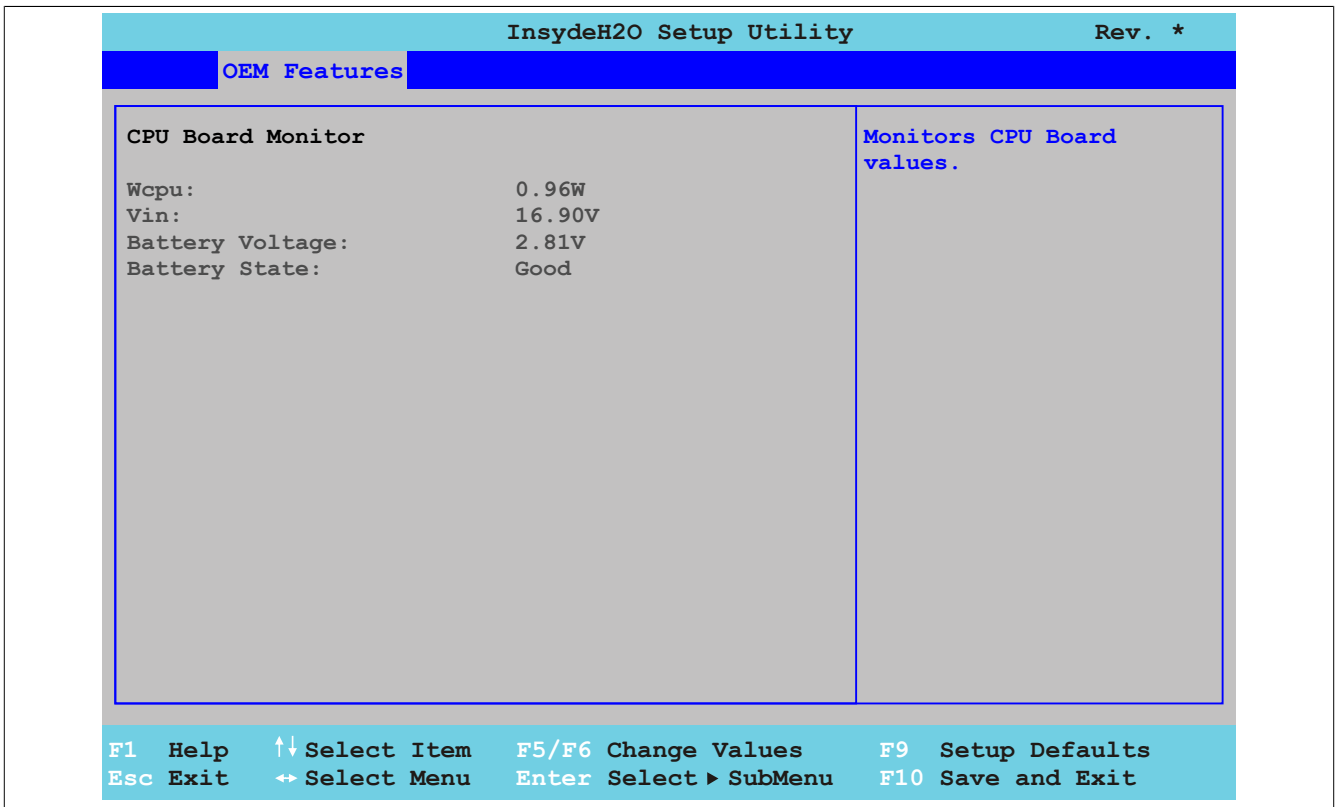

Figure 91: US15W OEM Features - CPU Board Features - CPU Board Monitor

BIOS setting	Function	Configuration options	Effect
Wcpu:	Displays the CPU power consumption in watts	None	-
Vin:	Displays the current voltage of the power supply in volts	None	-
Battery voltage:	Displays the battery voltage in volts	None	-
Battery state:	Displays the status of the battery	None	-

Table 107: US15W OEM features - CPU board features - CPU board monitor - Configuration options

1.4.2 System unit features

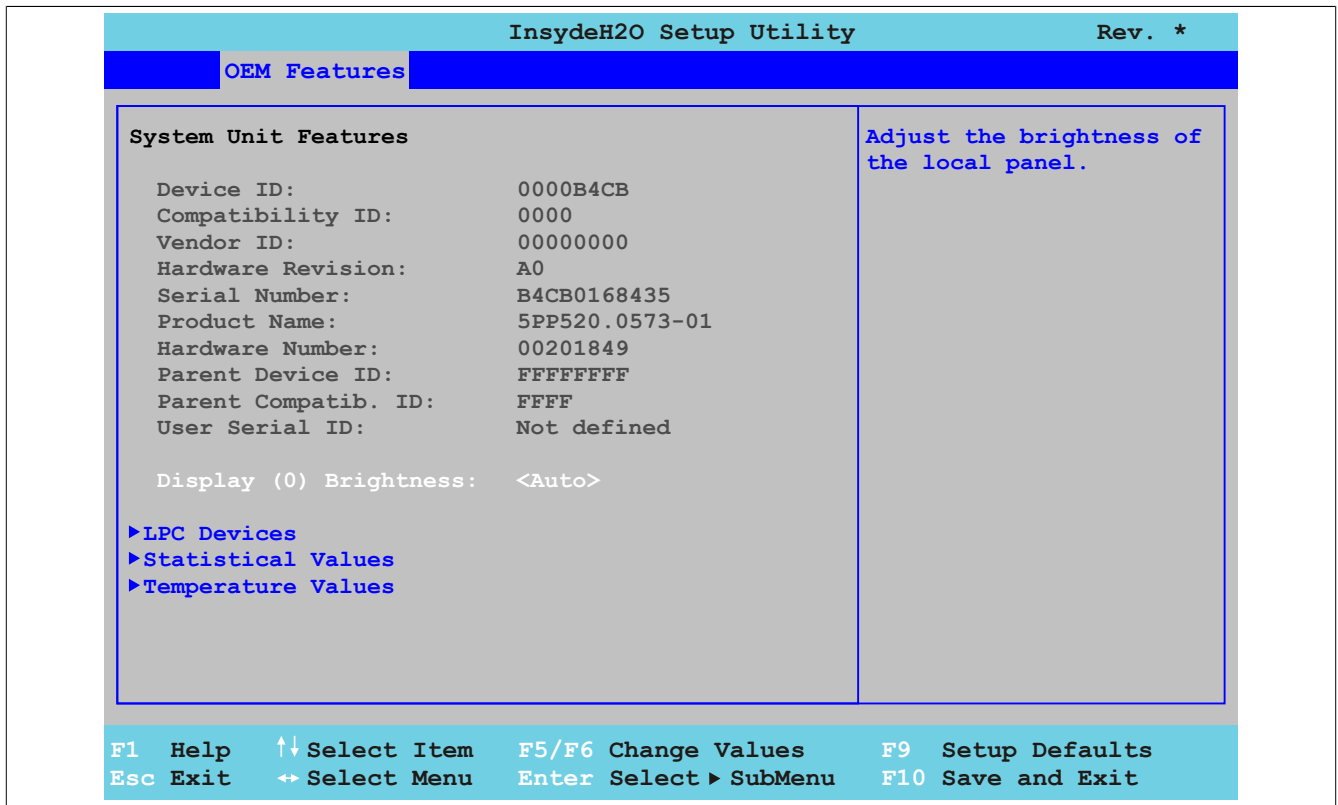

Figure 92: US15W OEM Features - System Unit Features

BIOS setting	Function	Configuration options	Effect
Device ID	Displays the device code of the Power Panel device	None	-
Compatibility ID	Displays the version of the device within the same B&R device ID. This ID is needed for Automation Runtime.	None	-
Vendor ID	Displays the vendor ID	None	-
Hardware revision	Displays the system unit hardware revision	None	-
Serial number	Displays the B&R serial number	None	-
Product name	Displays the B&R model number	None	-
Hardware number	Displays the system unit hardware number	None	-
Parent device ID	Displays the manufacturer number	None	-
Parent compatib. ID	Displays the manufacturer ID	None	-
User serial ID	Displays the user serial ID. This 8-digit hexadecimal value can be freely specified by the user (e.g. to give the device a unique ID) and can only be changed using the "B&R Control Center" included with the ADI driver.	None	-
Display (0) brightness ¹⁾	Option for setting the intensity of the display backlight	Auto	Automatically configures the optimal brightness configured using the factory settings. A brightness value between 100% and 0% is set.
		0%, 10%, 20%, 30%, 40%, 50%, 60%, 70%, 80%, 90%, 100%	Sets the desired brightness within the factory setting limits
LPC devices	Configures LPC devices	Enter	Opens the submenu See "LPC devices" on page 166
Statistical values	Displays statistical values	Enter	Opens the submenu See "Statistical values" on page 167
Temperature values	Displays current temperature values	Enter	Opens the submenu See "Temperature values" on page 168

Table 108: US15W OEM features - System unit features - Configuration options

1) This setting is only available for PP500 system units.

1.4.2.1 LPC devices

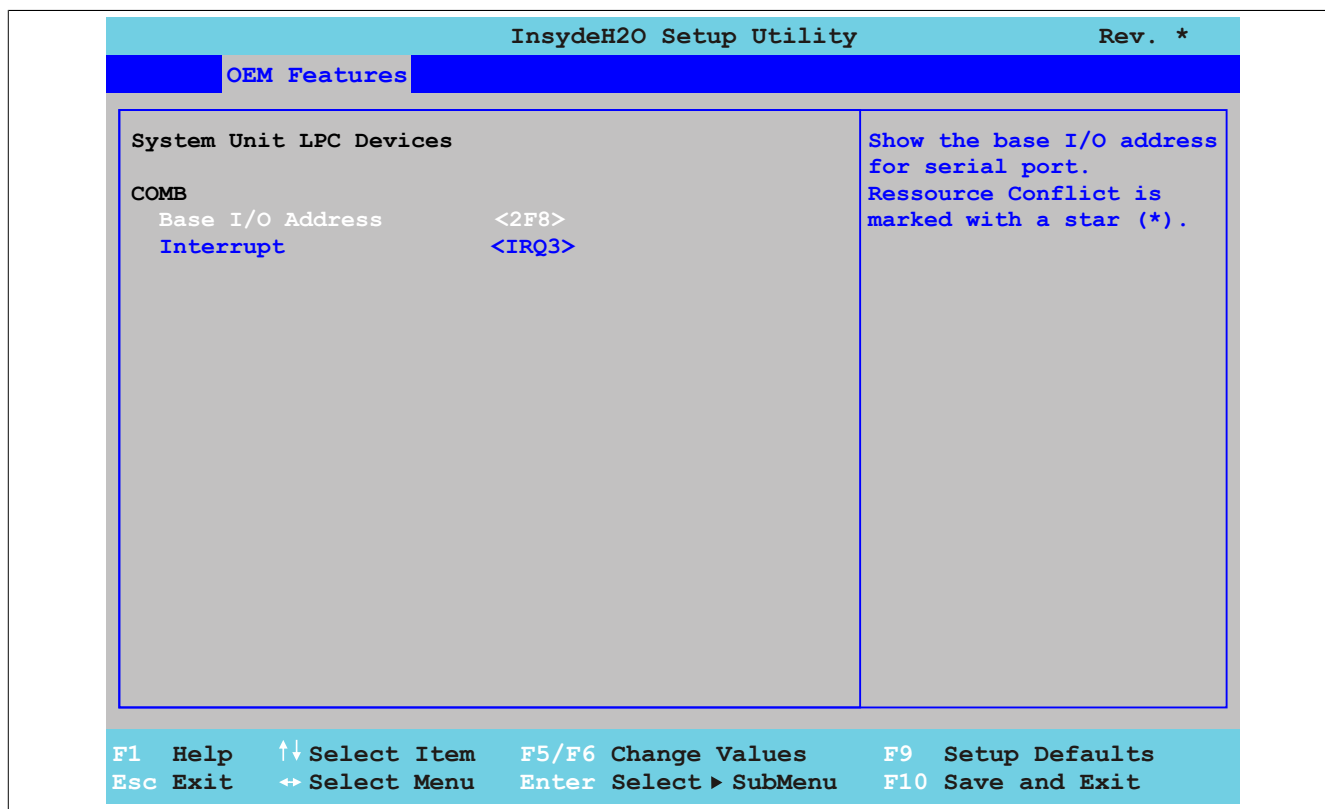

Figure 93: US15W OEM Features - System Unit Features - LPC Devices

BIOS setting	Function	Configuration options	Effect
COMB	Settings for the COM serial interface	None	-
Base I/O address	Selects the base I/O address of the COM port	Disabled, 238, 2E8, 2F8, 328, 338, 3E8, 3F8	Disables or assigns the selected base I/O address
Interrupt	Selects the interrupt for the COM port	IRQ3, IRQ4, IRQ5, IRQ6, IRQ10, IRQ11, IRQ12	Assigns the selected interrupt

Table 109: US15W OEM features - System unit features - LPC devices - Configuration options

Information:

A resource conflict can occur with respect to the base I/O address or the interrupt settings (indicated by a warning). In order to still be able to make these settings, the setting for the base I/O address or interrupt currently being used must be changed first.

1.4.2.2 Statistical values

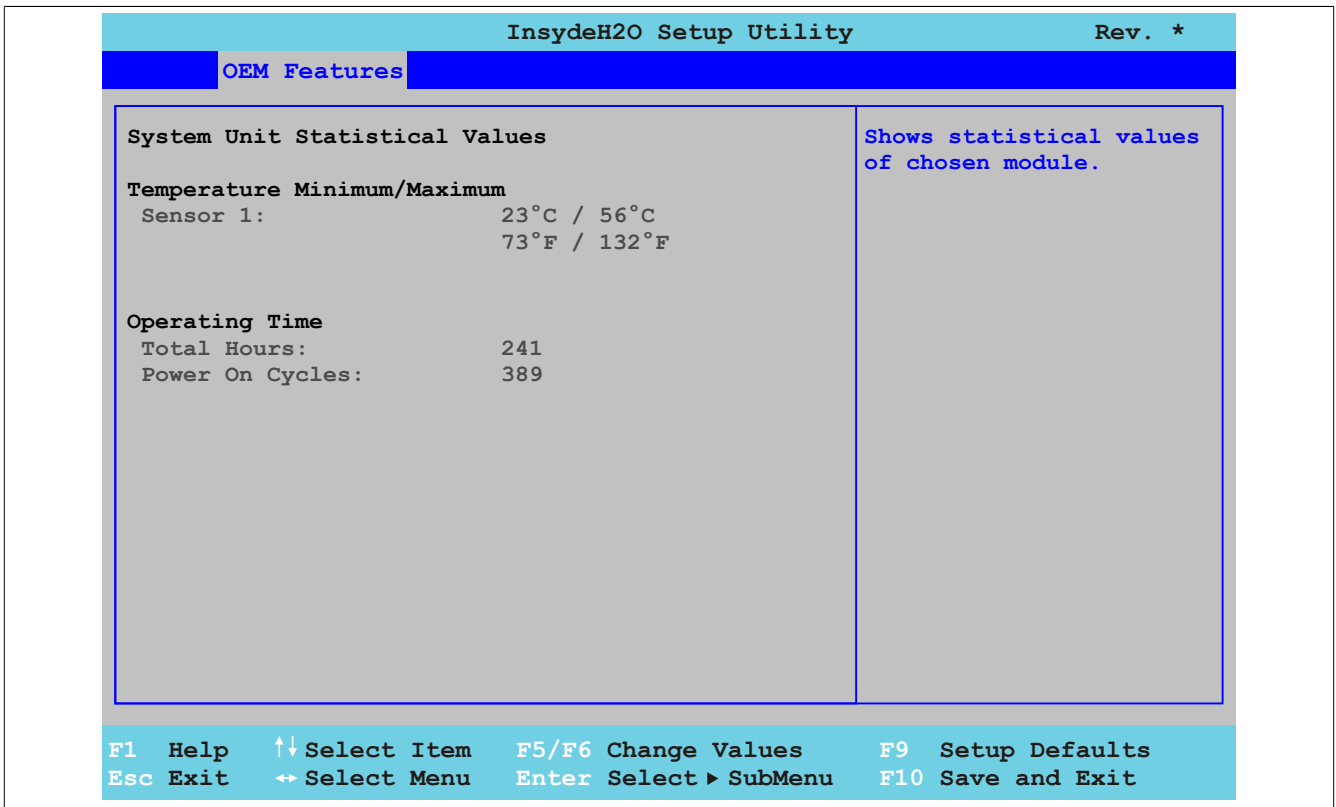

Figure 94: US15W OEM Features - System Unit Features - Statistical Values

BIOS setting	Function	Configuration options	Effect
Sensor 1	Displays the minimum and maximum temperature of sensor 1 in °C and °F	None	-
Total hours	Displays the runtime in hours	None	-
Power on cycles	Displays the number of power-on cycles. Each restart increases the counter by one.	None	-

Table 110: US15W OEM features - System unit features - Statistical values - Configuration options

1.4.2.3 Temperature values

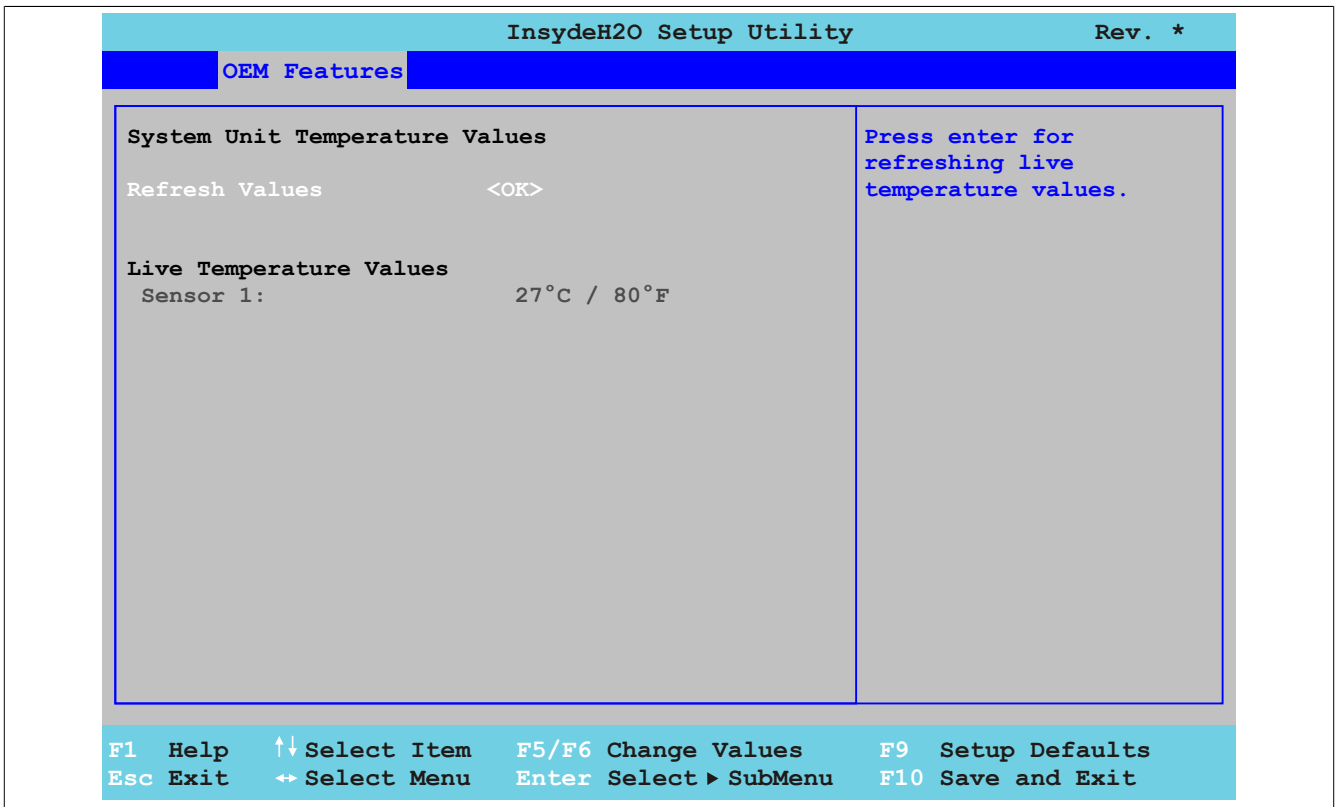

Figure 95: US15W OEM Features - System Unit Features - Temperature Values

BIOS setting	Function	Configuration options	Effect
Refresh values	Option for refreshing the temperature values	OK	Refreshes the temperature values shown below
Sensor 1	Displays the current temperature of sensor 1 in °C and °F	None	-

Table 111: US15W OEM features - System unit features - Temperature values - Configuration options

1.4.3 I/O board features

Information:

The values and menus shown may vary depending on which I/O board is connected.

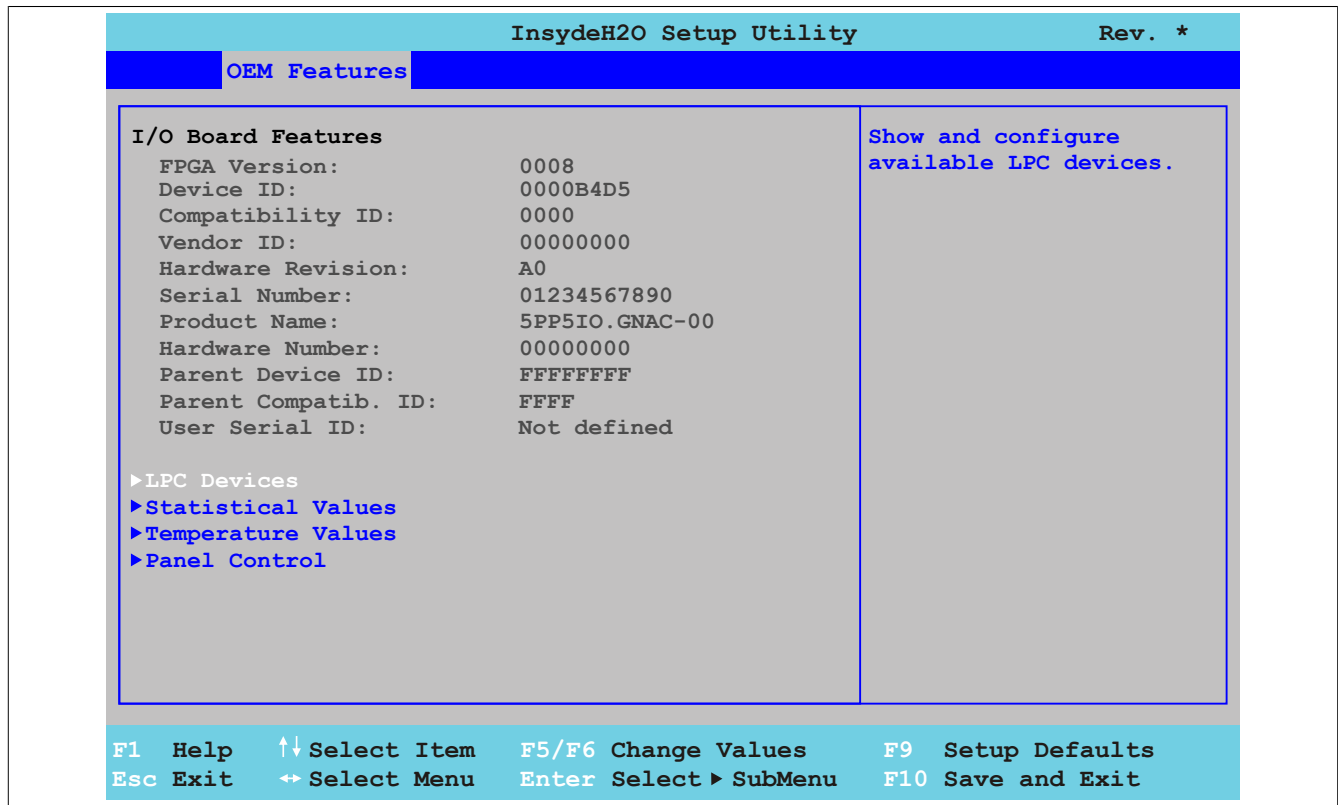

Figure 96: US15W OEM Features - I/O Board Features

BIOS setting	Function	Configuration options	Effect
FPGA version	Displays the FPGA version of the I/O board	None	-
Device ID	Displays the device ID of the I/O board	None	-
Compatibility ID	Displays the version of the device within the same B&R device ID. This ID is needed for Automation Runtime.	None	-
Vendor ID	Displays the vendor ID	None	-
Hardware revision	Displays the hardware revision of the I/O board	None	-
Serial number	Displays the B&R serial number	None	-
Product name	Displays the B&R model number	None	-
Hardware number	Displays the hardware number of the I/O board	None	-
Parent device ID	Displays the manufacturer number	None	-
Parent compatib. ID	Displays the manufacturer ID	None	-
User serial ID	Displays the user serial ID. This 8-digit hexadecimal value can be freely specified by the user (e.g. to give the device a unique ID) and can only be changed using the "B&R Control Center" included with the ADI driver.	None	-
LPC devices	Configures LPC devices	Enter	Opens the submenu See "LPC devices" on page 170
Statistical values	Displays statistical values	Enter	Opens the submenu See "Statistical values" on page 171
Temperature values	Displays current temperature values	Enter	Opens the submenu See "Temperature values" on page 172
Panel control	Configures special settings for connected panels (display units)	Enter	Opens the submenu See "Panel control" on page 173

Table 112: US15W OEM features - I/O board features - Configuration options

1.4.3.1 LPC devices

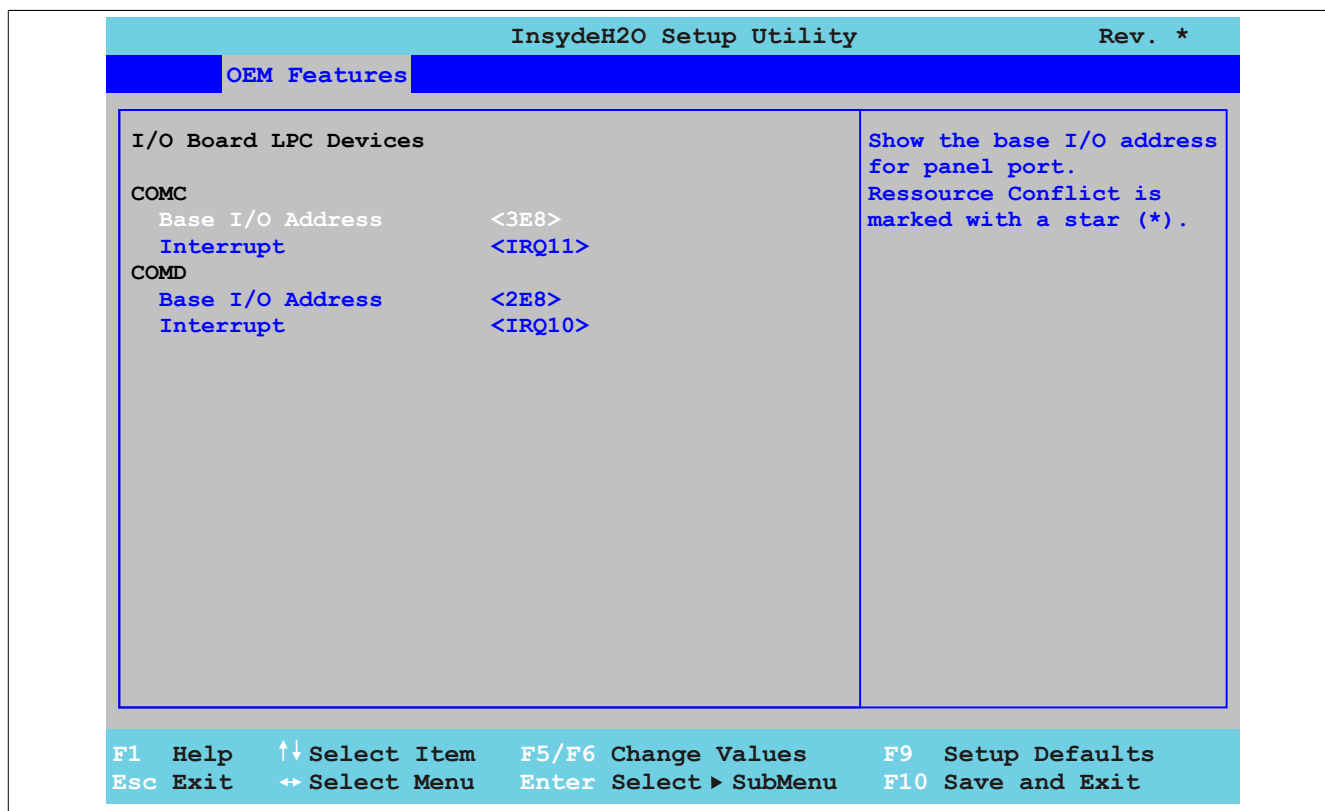

Figure 97: US15W OEM Features - I/O Board Features - LPC Devices

BIOS setting	Function	Configuration options	Effect
COMC	Setting for the panel interface on the I/O board	None	-
Base I/O address	Selects the base I/O address of the COM port	Disabled, 238, 2E8, 2F8, 328, 338, 3E8, 3F8	Disables or assigns the selected base I/O address
Interrupt	Selects the interrupt for the COM port	IRQ3, IRQ4, IRQ5, IRQ6, IRQ10, IRQ11, IRQ12	Assigns the selected interrupt
COMD	Setting for the serial interface (COM) on the I/O board	None	-
Base I/O address	Selects the base I/O address of the COM port	Disabled, 238, 2E8, 2F8, 328, 338, 3E8, 3F8	Disables or assigns the selected base I/O address
Interrupt	Selects the interrupt for the COM port	IRQ3, IRQ4, IRQ5, IRQ6, IRQ10, IRQ11, IRQ12	Assigns the selected interrupt

Table 113: US15W OEM features - I/O board features - LPC devices - Configuration options

Information:

A resource conflict can occur with respect to the base I/O address or the interrupt settings (indicated by a warning). In order to still be able to make these settings, the setting for the base I/O address or interrupt currently being used must be changed first.

1.4.3.2 Statistical values

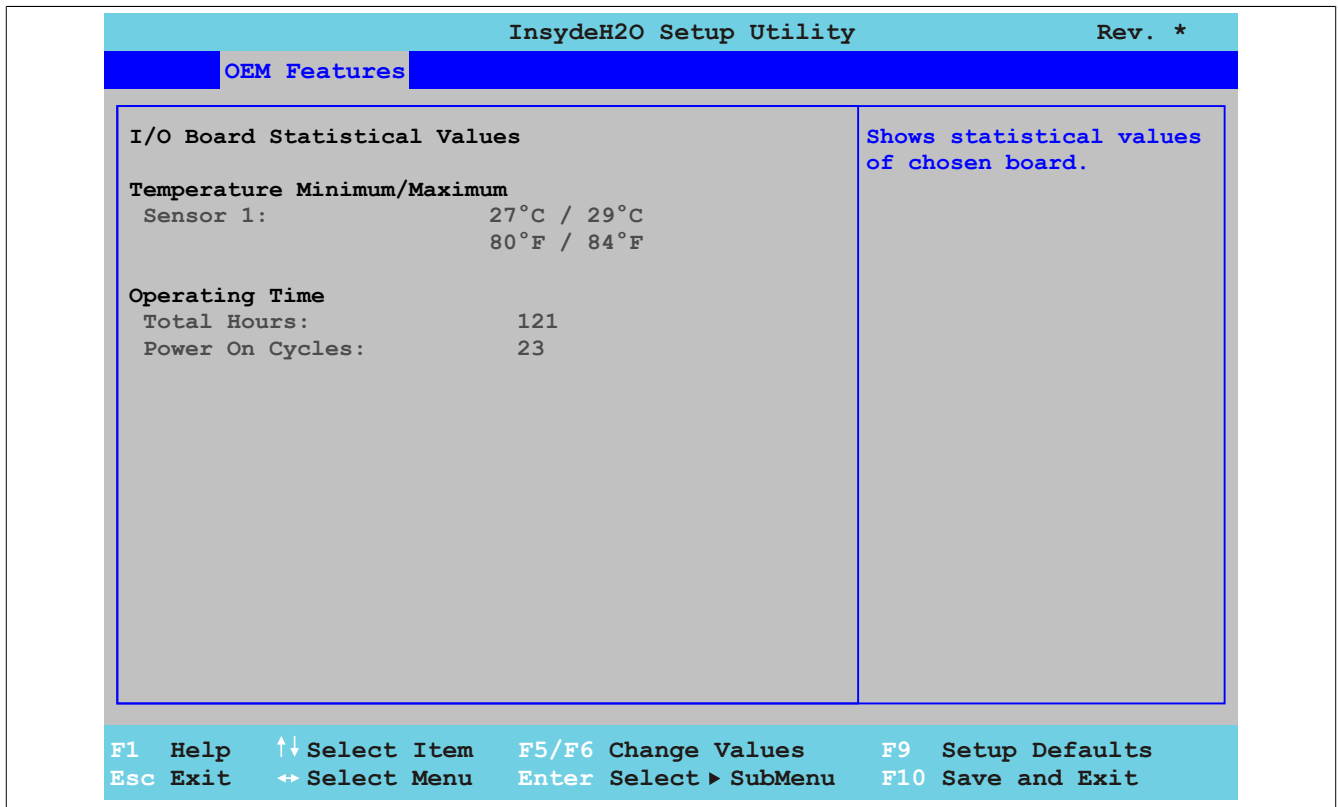

Figure 98: US15W OEM Features - I/O Board Features - Statistical Values

BIOS setting	Function	Configuration options	Effect
Sensor 1	Displays the minimum and maximum temperature of sensor 1 in °C and °F		
Total hours	Displays the runtime in hours	None	-
Power on cycles	Displays the number of power-on cycles. Each restart increases the counter by one.	None	-

Table 114: US15W OEM features - I/O board features - Statistical values - Configuration options

1.4.3.3 Temperature values

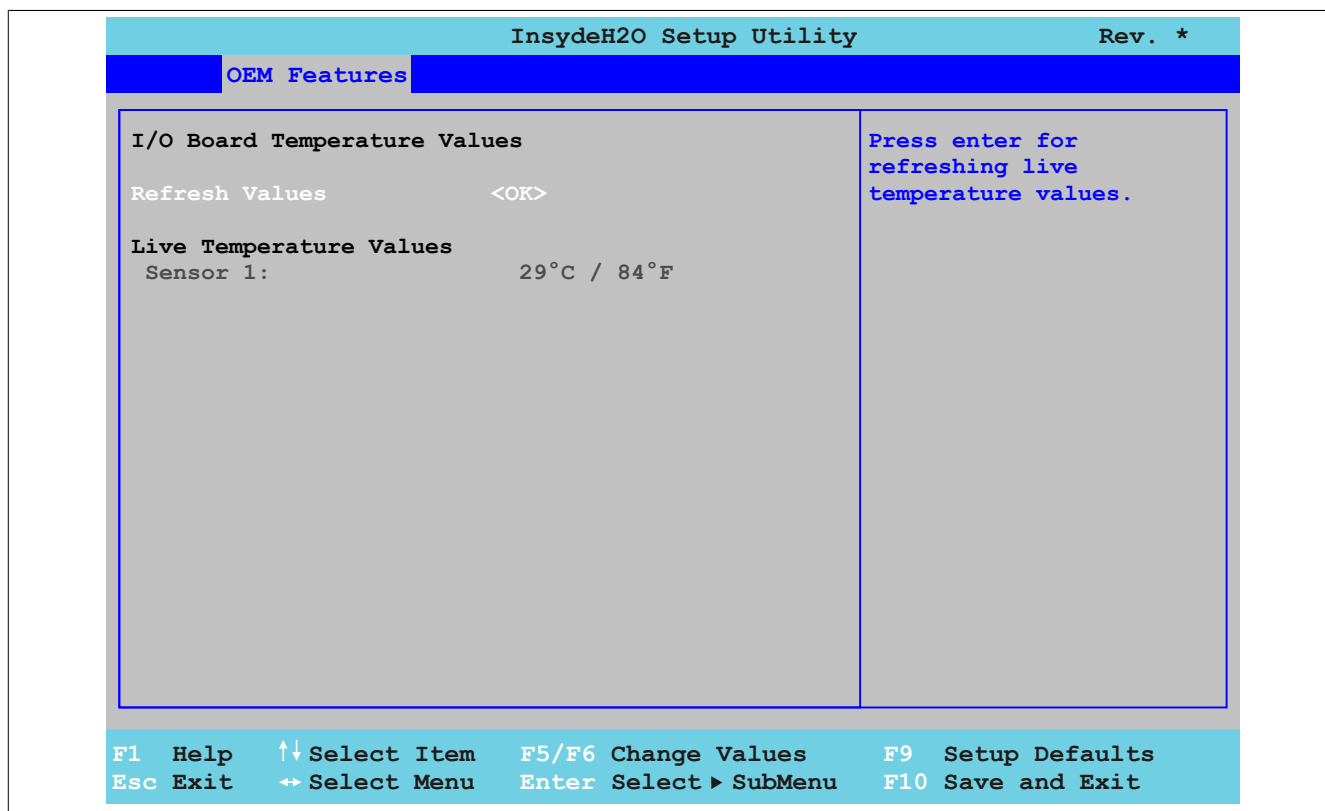

Figure 99: US15W OEM Features - I/O Board Features - Temperature Values

BIOS setting	Function	Configuration options	Effect
Refresh values	Option for refreshing the temperature values	OK	Refreshes the temperature values shown below
Sensor 1	Displays the current temperature of sensor 1 (interfaces) in °C and °F	None	-

Table 115: US15W OEM features - I/O board features - Temperature values - Configuration options

1.4.3.4 Panel control

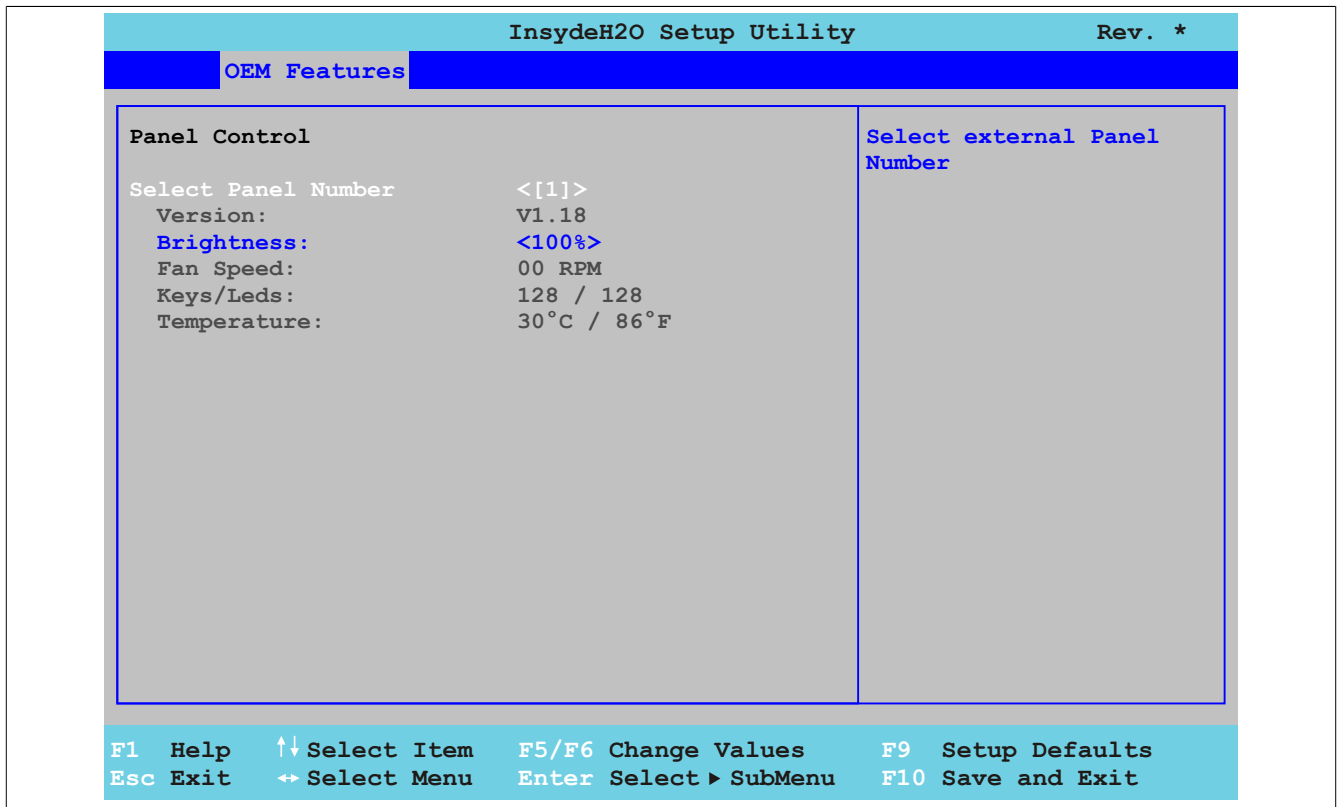

Figure 100: US15W OEM Features - I/O Board Features - Panel Control

BIOS setting	Function	Configuration options	Effect
Select panel number	Selects the panel number for which the values should be displayed and/or changed	0...15	Selects panel 0-15
Version	Displays the firmware version of the SDLR controller	None	-
Brightness	Sets the brightness of the selected panel	0%, 10%, 20%, 30%, 40%, 50%, 60%, 70%, 80%, 90%, 100%	Sets the brightness (in %) of the selected panel Changes take effect after saving and restarting the system (e.g. by pressing <F10>).
Fan speed	Displays the fan speed of the selected panel	None	-
Keys/LEDs	Displays the available keys and LEDs on the selected panel	None	-
Temperature	Displays the temperature of the selected panel in °C and °F	None	-

Table 116: US15W OEM features - I/O board features - Panel control - Configuration options

1.4.4 IF board features

Information:

The values and menus shown may vary depending on which interface board is connected.

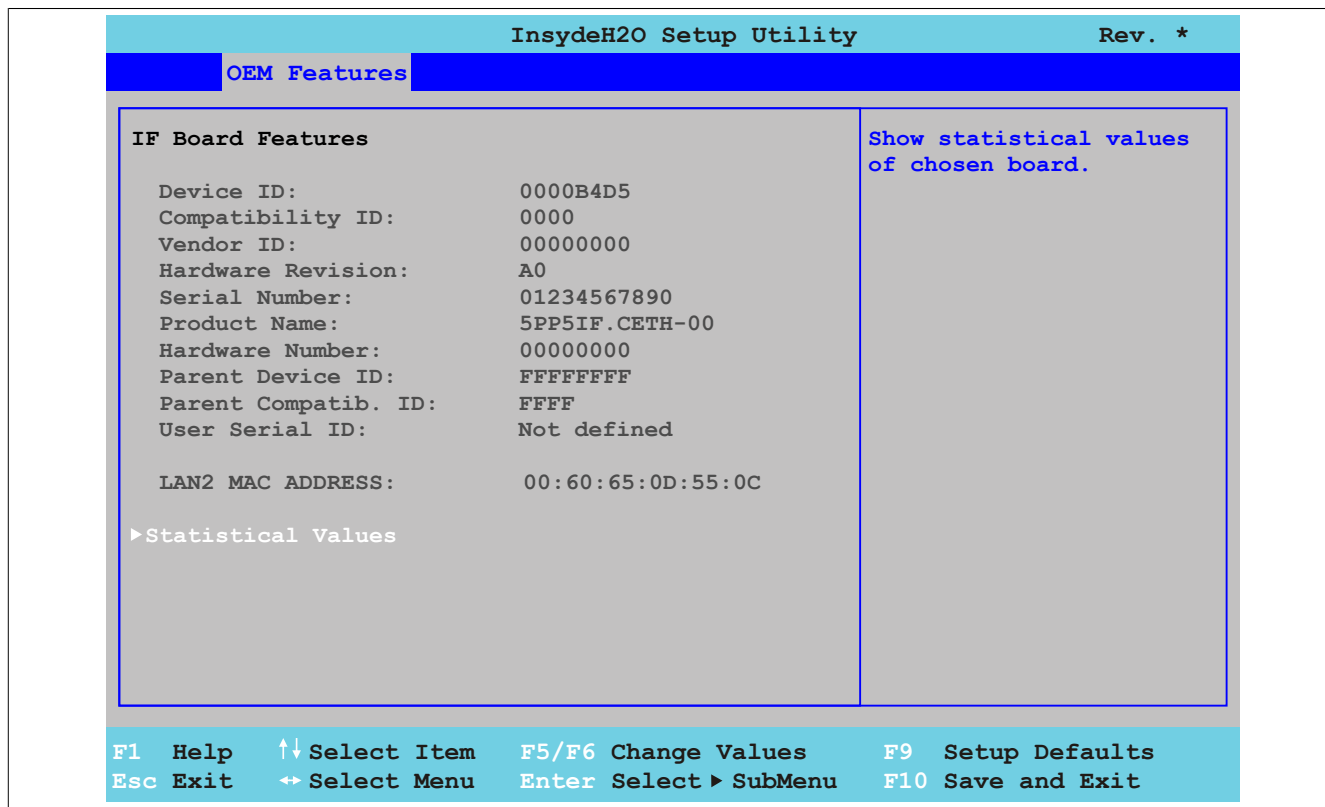

Figure 101: US15W OEM Features - IF Board Features

BIOS setting	Function	Configuration options	Effect
Device ID	Displays the device ID of the IF board	None	-
Compatibility ID	Displays the version of the device within the same B&R device ID. This ID is needed for Automation Runtime.	None	-
Vendor ID	Displays the vendor ID	None	-
Hardware revision	Displays the IF board hardware revision	None	-
Serial number	Displays the B&R serial number	None	-
Product name	Displays the B&R model number	None	-
Hardware number	Displays the IF board hardware number.	None	-
Parent device ID	Displays the manufacturer number	None	-
Parent compatib. ID	Displays the manufacturer ID	None	-
User serial ID	Displays the user serial ID. This 8-digit hexadecimal value can be freely specified by the user (e.g. to give the device a unique ID) and can only be changed using the "B&R Control Center" included with the ADI driver.	None	-
LAN2 MAC ADDRESS ¹⁾	Displays the assigned MAC address for the ETH interface	None	-
Statistical values	Displays statistical values	Enter	Opens the submenu See "Statistical values" on page 175

Table 117: US15W OEM features - IF board features - Configuration options

1) LAN2 MAC ADDRESS is only displayed for interface board 5PP5IF.CETH-00.

1.4.4.1 Statistical values

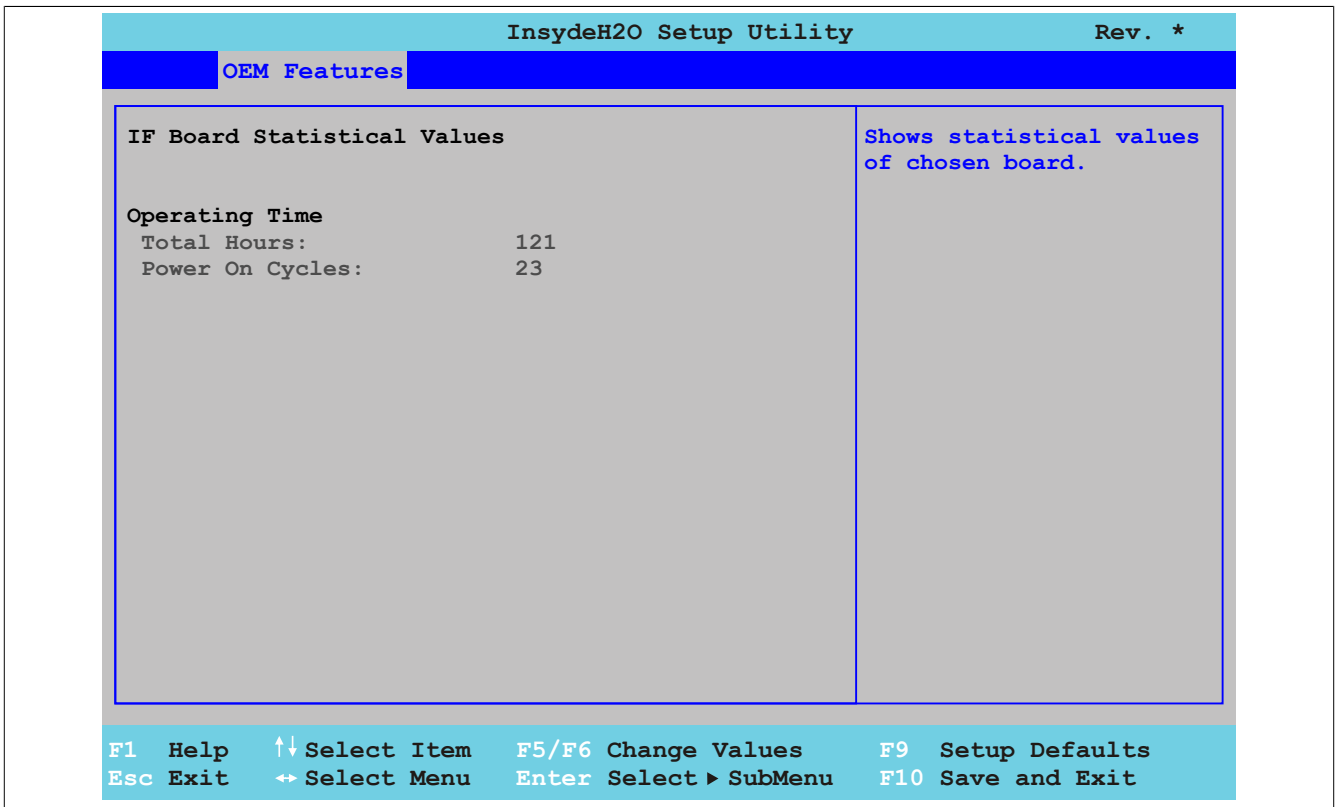

Figure 102: US15W OEM Features - IF Board Features - Statistical Values

BIOS setting	Function	Configuration options	Effect
Total hours	Displays the runtime in hours	None	-
Power on cycles	Displays the number of power-on cycles. Each restart increases the counter by one.	None	-

Table 118: US15W OEM features - IF board features - Statistical values - Configuration options

1.4.5 Memory module features

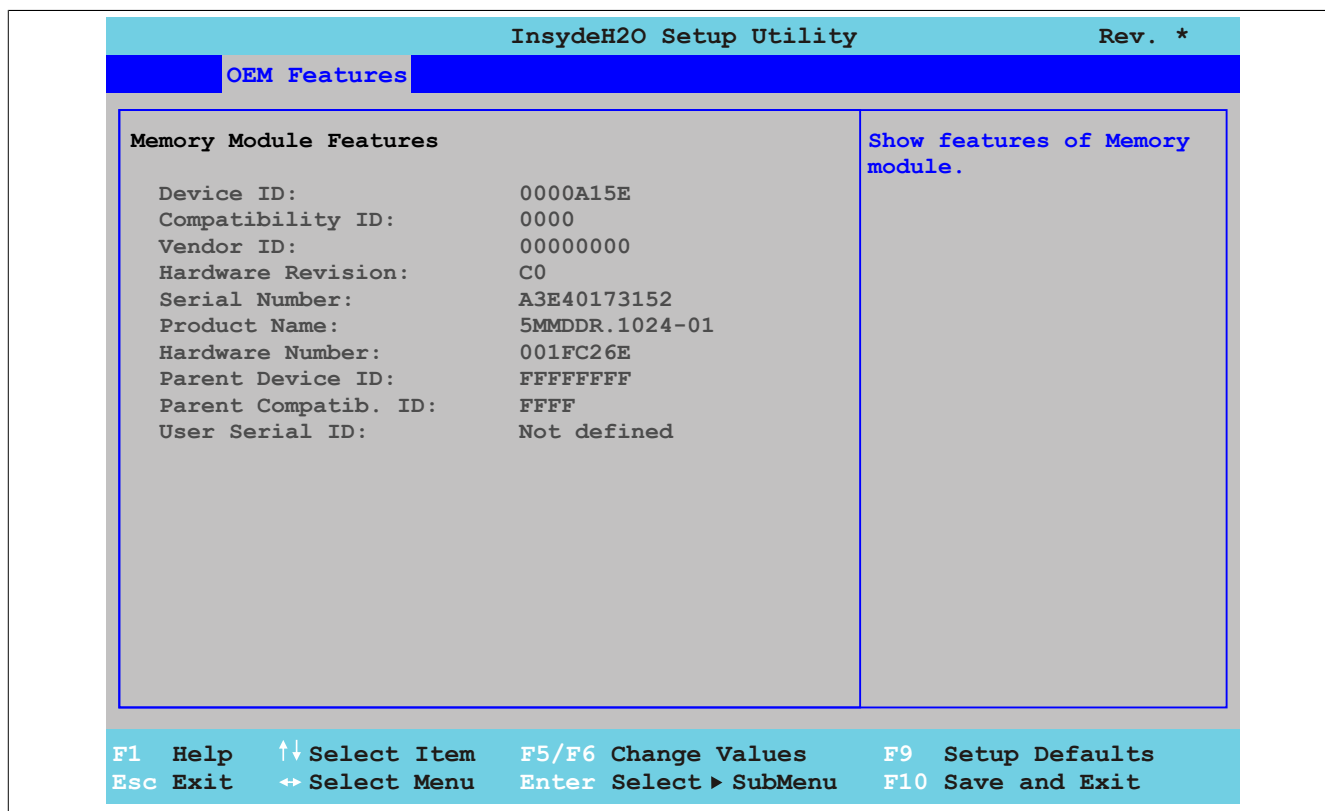

Figure 103: US15W OEM Features - Memory Module Features

BIOS setting	Function	Configuration options	Effect
Device ID	Displays the device ID of the RAM	None	-
Compatibility ID	Displays the version of the device within the same B&R device ID. This ID is needed for Automation Runtime.	None	-
Vendor ID	Displays the vendor ID	None	-
Hardware revision	Displays the hardware revision of the main memory	None	-
Serial number	Displays the B&R serial number	None	-
Product name	Displays the B&R model number	None	-
Hardware number	Displays the hardware number of the main memory	None	-
Parent device ID	Displays the manufacturer number	None	-
Parent compatib. ID	Displays the manufacturer ID	None	-
User serial ID	Displays the user serial ID. This 8-digit hexadecimal value can be freely specified by the user (e.g. to give the device a unique ID) and can only be changed using the "B&R Control Center" included with the ADI driver.	None	-

Table 119: US15W OEM features - Memory module features - Configuration options

1.5 Advanced

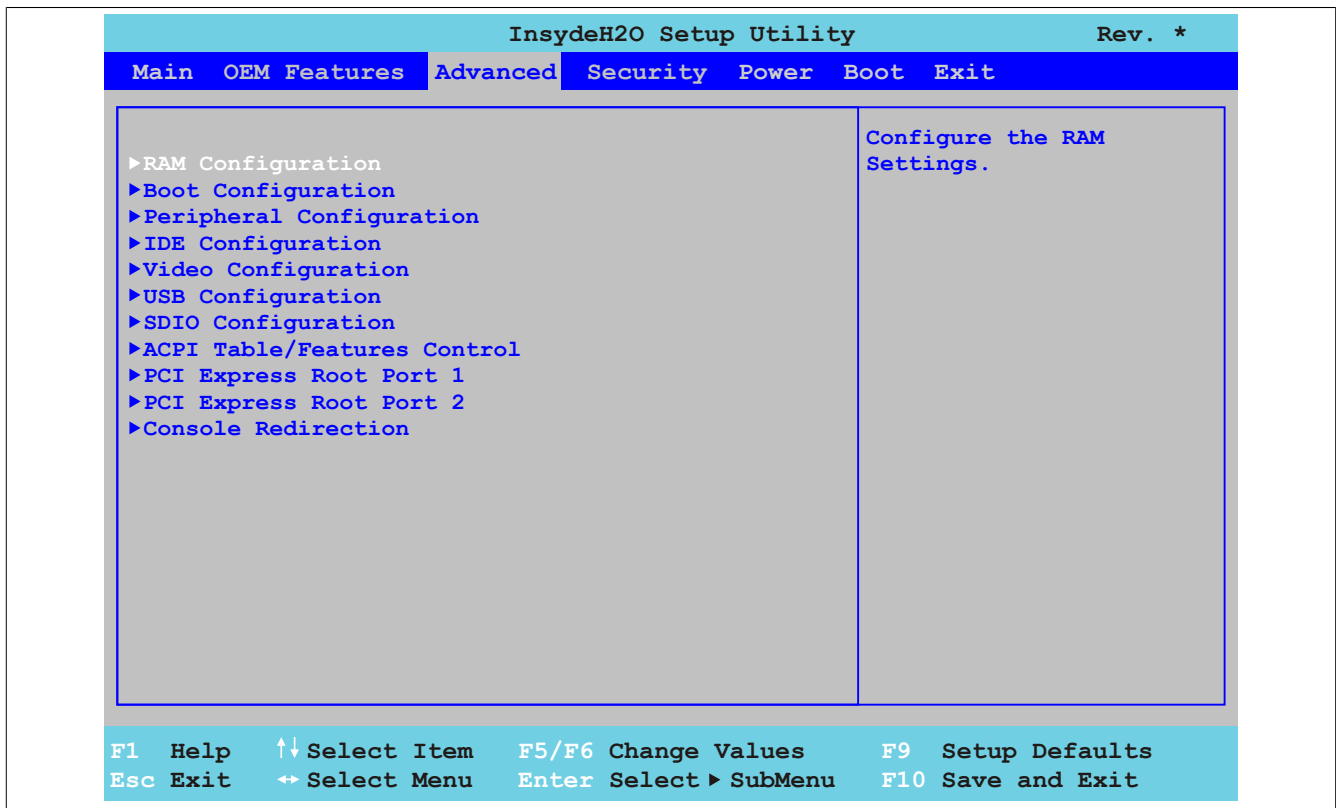

Figure 104: US15W Advanced - Menü

BIOS setting	Function	Configuration options	Effect
RAM configuration	Configures RAM settings	Enter	Opens the submenu See "RAM configuration" on page 178
Boot configuration	Configures boot settings	Enter	Opens the submenu See "Boot configuration" on page 179
Peripheral configuration¹⁾	Configures peripheral settings	Enter	Opens the submenu See "Peripheral configuration" on page 180
IDE configuration	Configures IDE functions	Enter	Opens the submenu See "IDE configuration" on page 181
Video configuration	Configures graphics settings	Enter	Opens the submenu See "Video configuration" on page 184
USB configuration	Configures USB settings	Enter	Opens the submenu See "USB configuration" on page 185
SDIO configuration²⁾	Configures SDIO settings	Enter	Opens the submenu See "SDIO configuration" on page 186

Table 120: US15W Advanced menu - Configuration options

BIOS setting	Function	Configuration options	Effect
ACPI table/features control configuration	Configures ACPI table/features	Enter	Opens the submenu See "ACPI table/features control" on page 187
PCI Express root port 1	Configures PCI Express settings on port 1 Warning! Improper settings can cause instability or device problems. It is therefore strongly recommended that these settings only be changed by experienced users.	Enter	Opens the submenu See "PCI Express root port 1" on page 187
PCI Express root port 2	Configures PCI Express settings on port 2 Warning! Improper settings can cause instability or device problems. It is therefore strongly recommended that these settings only be changed by experienced users.	Enter	Opens the submenu See "PCI Express root port 2" on page 190
Console redirection ³⁾	Configures the remote console	Enter	Opens the submenu See "Console redirection" on page 191

Table 120: US15W Advanced menu - Configuration options

- 1) This menu option is only available if there is an audio connection.
- 2) SDIO - Secure digital input output.
- 3) These settings are only visible to Automation PC 511 system units without an I/O board. The mode/node switches must be set to "00" (default).

1.5.1 RAM configuration

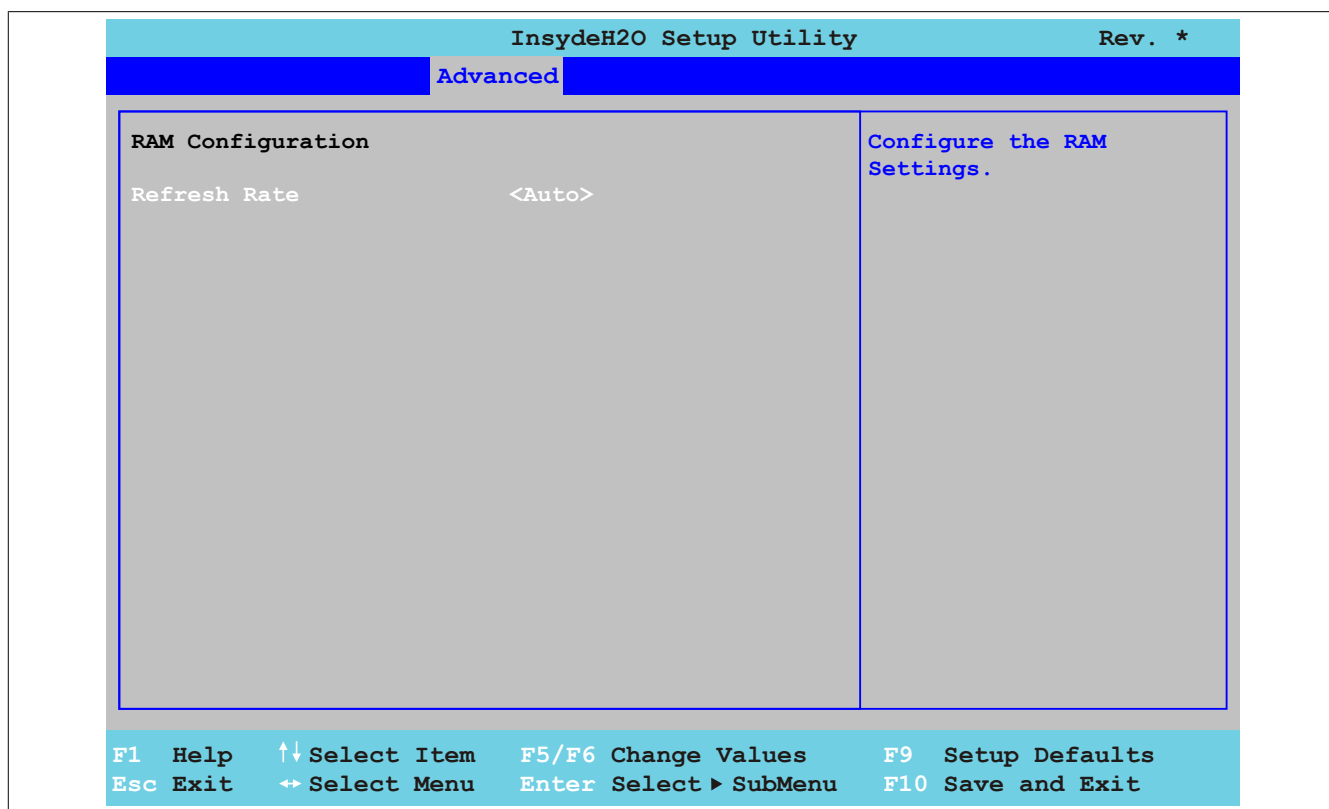

Figure 105: US15W Advanced - RAM Configuration

BIOS setting	Function	Configuration options	Effect
Refresh rate	Option for configuring the DRAM refresh rate	Auto	Reads the DRAM refresh rate from the SPD data of the DRAM module
		7.8 μs	The DRAM refresh rate is set manually.
		3.9 μs	The DRAM refresh rate is set manually.

Table 121: US15W Advanced - RAM configuration - Configuration options

1.5.2 Boot configuration

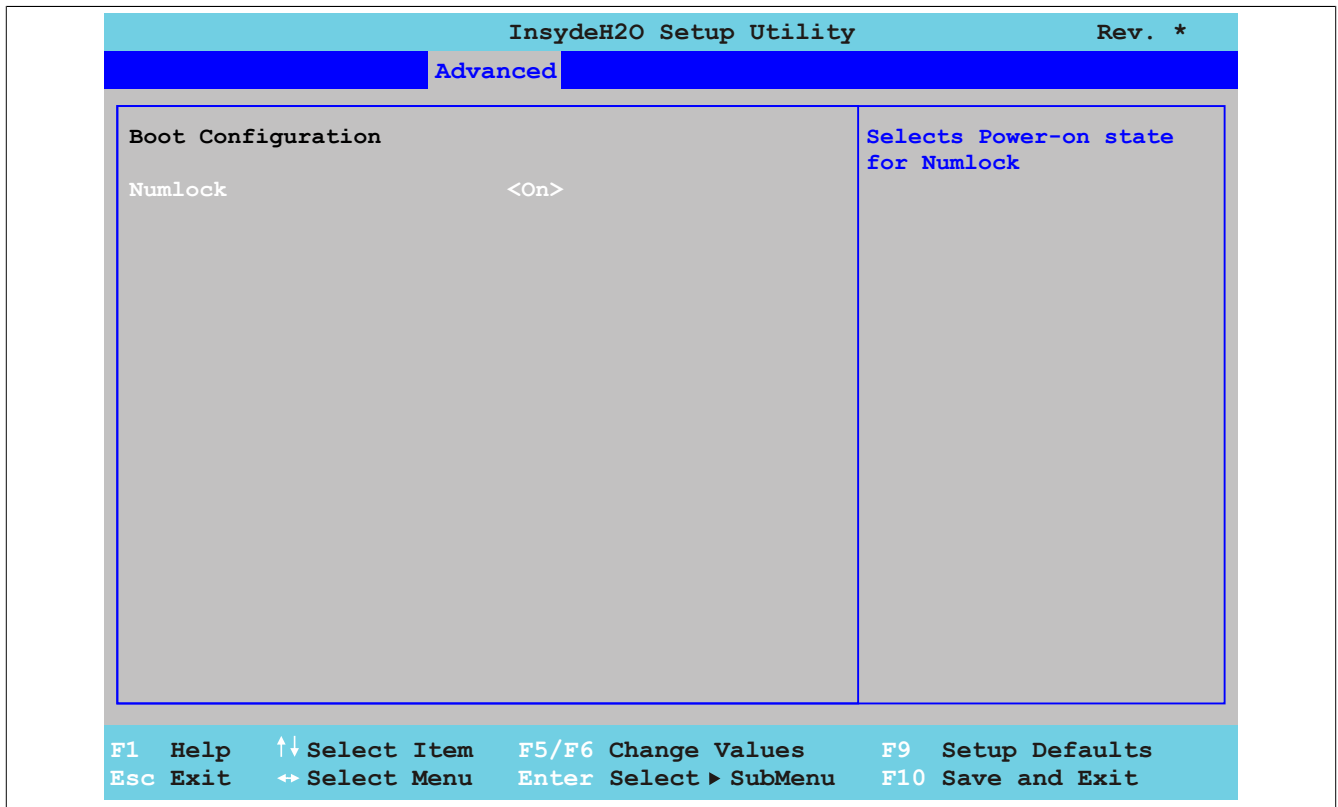

Figure 106: US15W Advanced - Boot Configuration

BIOS setting	Function	Configuration options	Effect
NumLock	Defines the state of the NumLock key on the numeric keypad when booting	On	Enables the numeric keypad
		Off	Only enables the cursor (movement) functions of the numeric keypad

Table 122: US15W Advanced - Boot configuration - Configuration options

1.5.3 Peripheral configuration

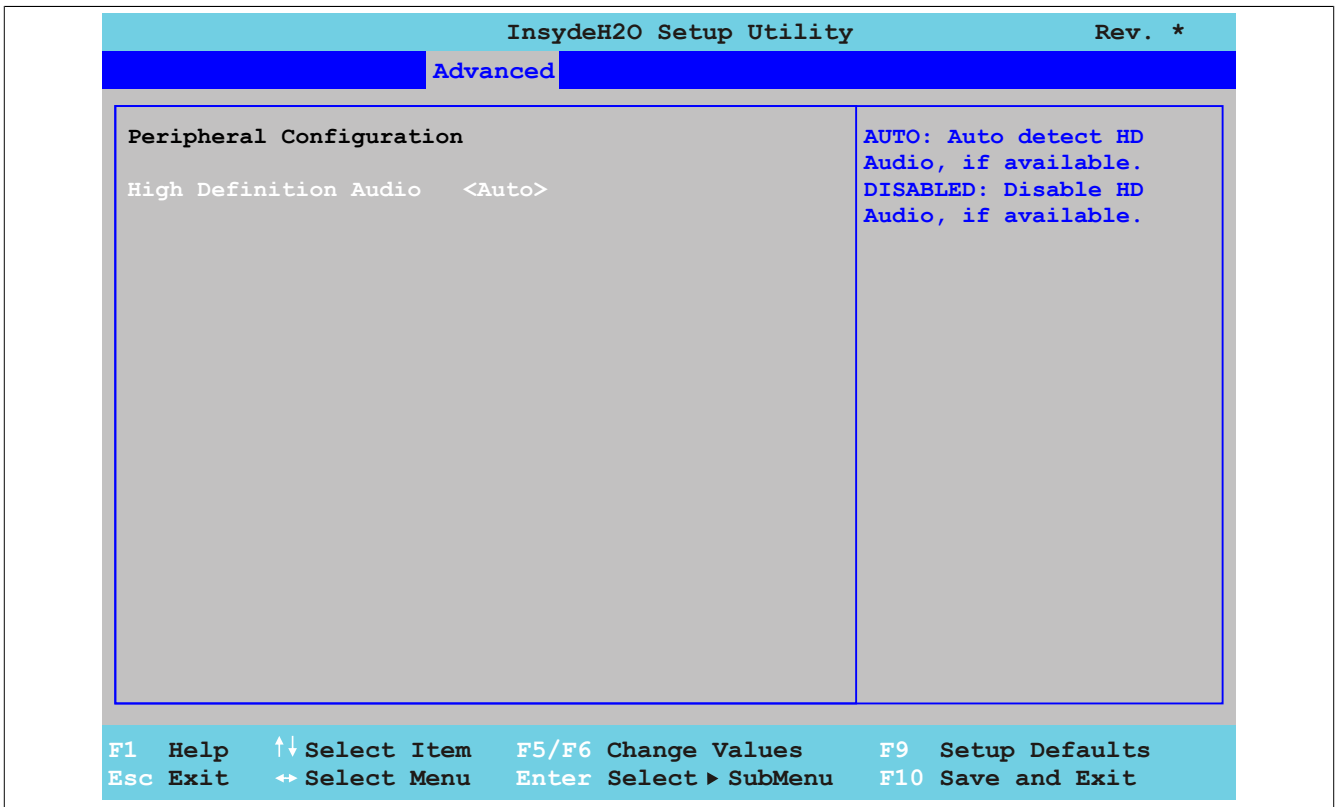

Figure 107: US15W Advanced - Peripheral Configuration

BIOS setting	Function	Configuration options	Effect
High definition audio	Option for enabling/disabling audio support	Disabled	Disables the audio controller
		Auto	Enables HDA (high definition audio). The HDA controller automatically detects installed audio devices.

Table 123: US15W Advanced - Peripheral configuration - Configuration options

Information:

The menu option "Peripheral configuration" is only displayed if there is an audio connection.

1.5.4 IDE configuration

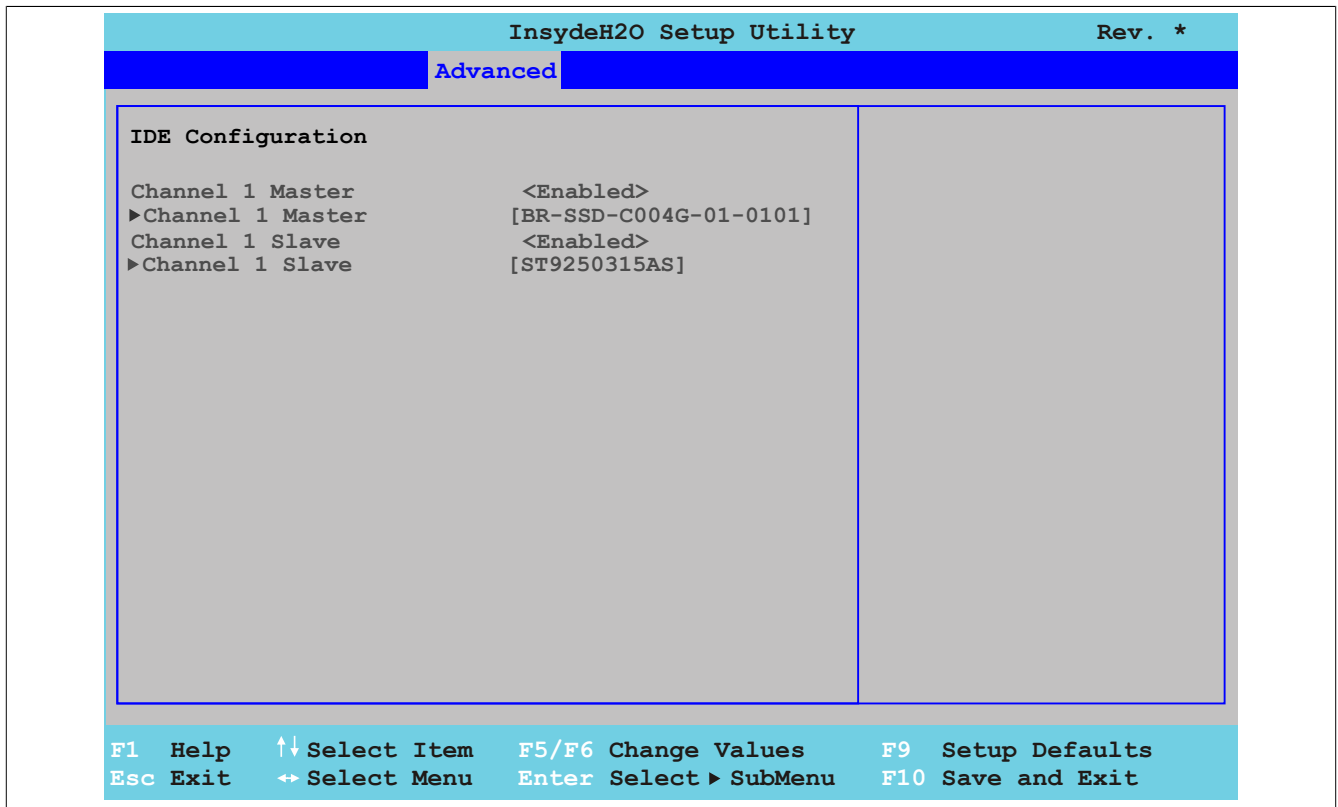

Figure 108: US15W Advanced - IDE Configuration

BIOS setting	Function	Configuration options	Effect
Channel 1 master	Option for enabling/disabling the drive connected to the channel 1 master	Disabled	Disables mass memory
		Enabled	Enables mass memory
Channel 1 master	Displays the drive that is connected to the channel 1 master	Enter	Opens the submenu See "Channel 1 master" on page 182
Channel 1 slave	Option for enabling/disabling the drive connected to the channel 1 slave	Disabled	Disables mass memory
		Enabled	Enables mass memory
Channel 1 slave	Displays the drive that is connected to the channel 1 slave	Enter	Opens the submenu See "Channel 1 slave" on page 183

Table 124: US15W Advanced - IDE configuration - Configuration options

1.5.4.1 Channel 1 master

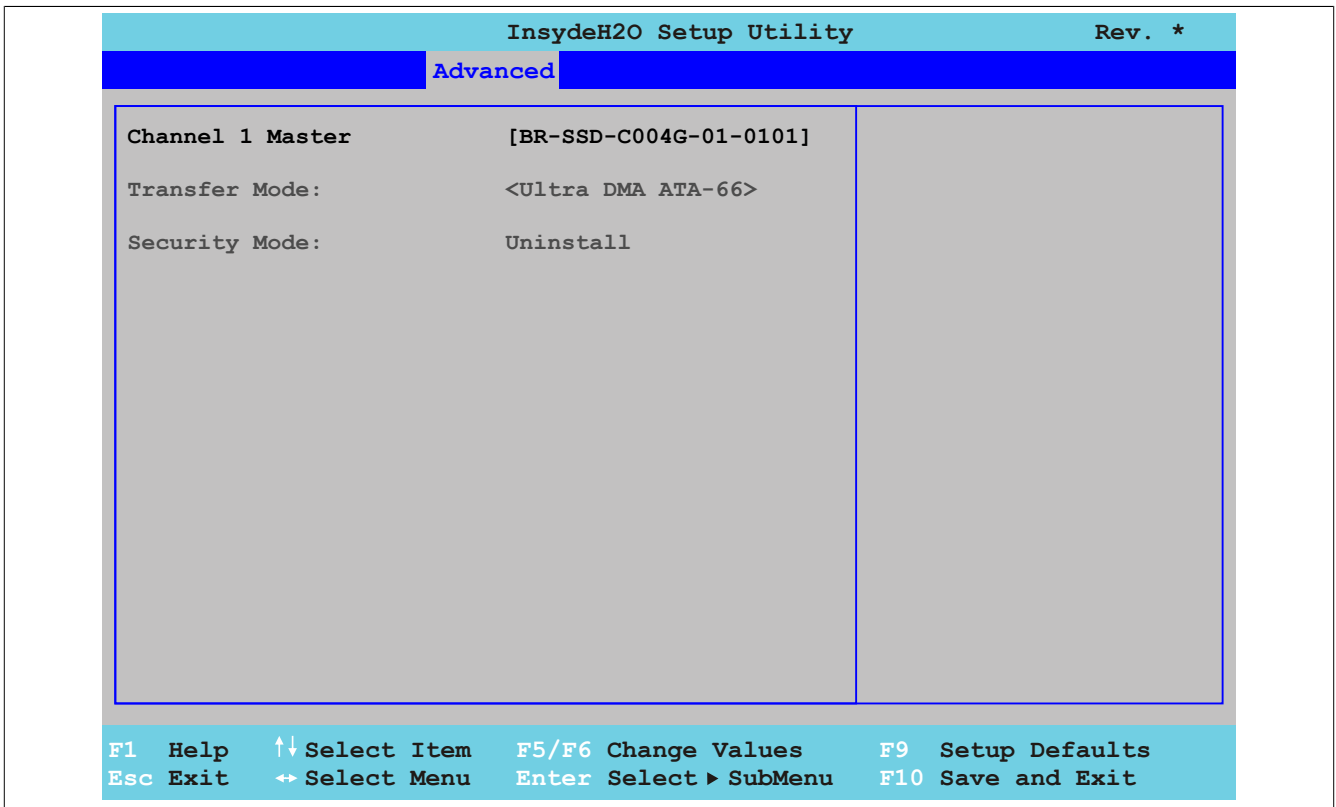

Figure 109: US15W Advanced - IDE Configuration - Channel 1 Master

BIOS setting	Function	Configuration options	Effect
Transfer mode	Displays the transfer mode used between the channel 1 master drive and the system memory	None	-
Security mode		None	-

Table 125: US15W Advanced - IDE configuration - Channel 1 master - Configuration options

1.5.4.2 Channel 1 slave

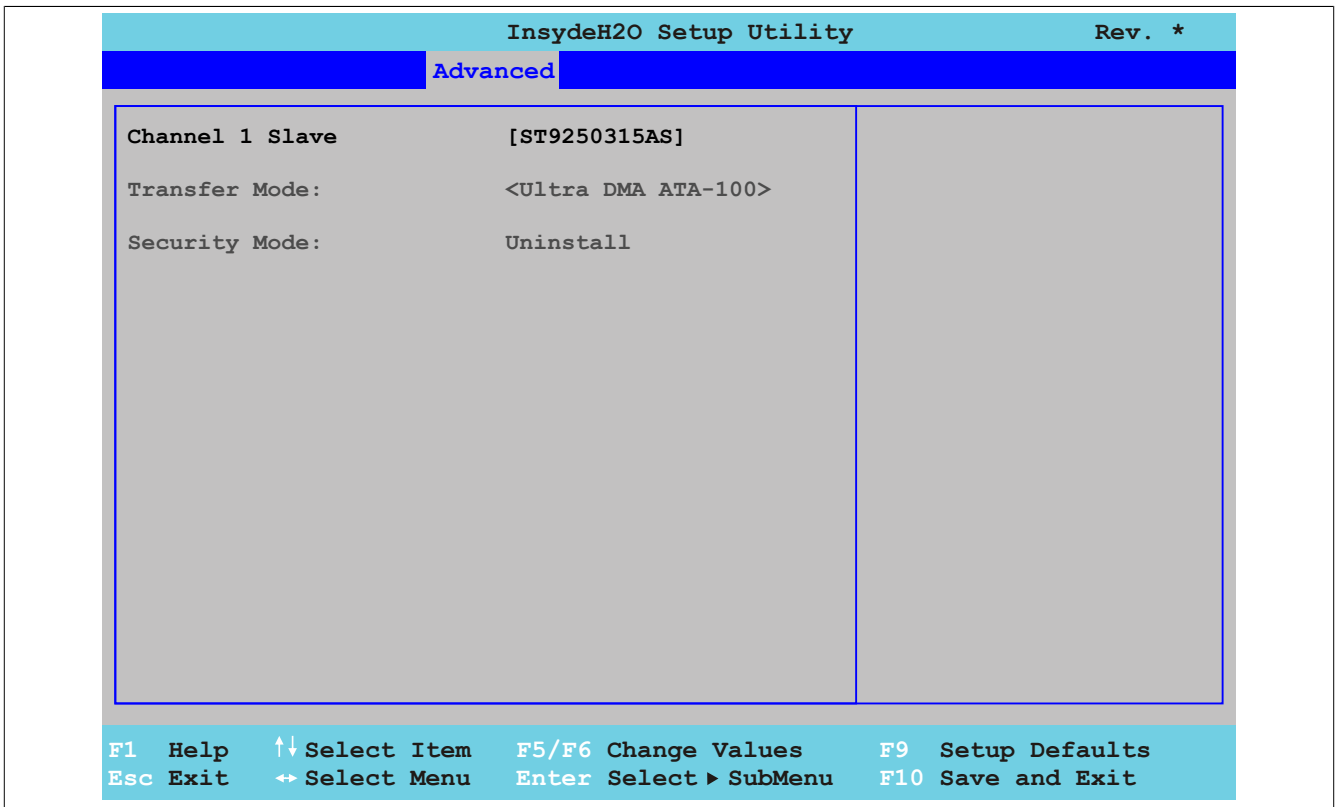

Figure 110: US15W Advanced - IDE Configuration - Channel 1 Slave

BIOS setting	Function	Configuration options	Effect
Transfer mode	Displays the transfer mode used between the channel 1 slave drive and the system memory	None	-
Security mode		None	-

Table 126: US15W Advanced - IDE configuration - Channel 1 slave - Configuration options

1.5.5 Video configuration

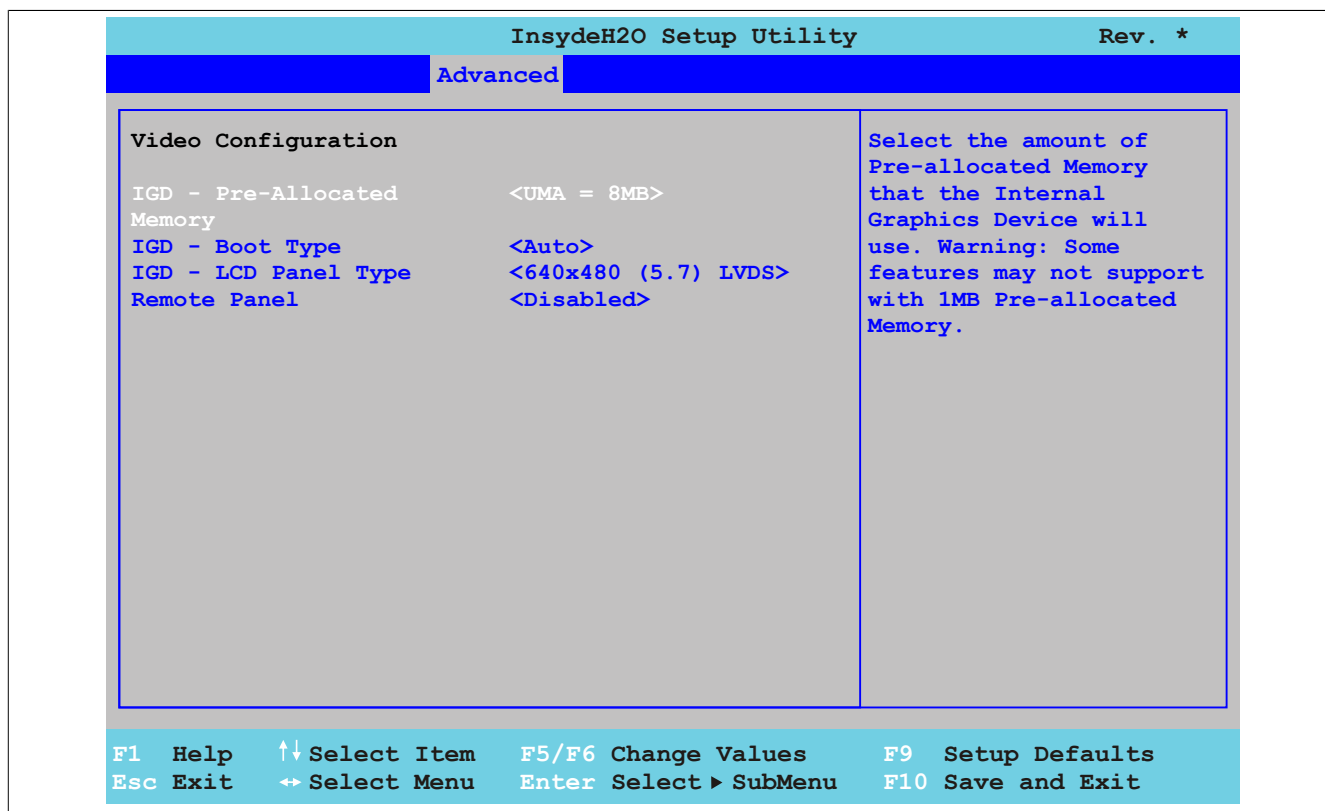

Figure 111: US15W Advanced - Video Configuration

BIOS setting	Function	Configuration options	Effect
IGD - Pre-allocated memory	Option for setting the amount of memory used for the internal graphics controller	UMA = 1 MB	Allocates 1 MB main memory
		UMA = 4 MB	Allocates 4 MB main memory
		UMA = 8 MB	Allocates 8 MB main memory
	Information: Some functions are not supported with the setting "UMA = 1 MB".		
IGD - Boot type	Option for defining the enabled panel during POST	Auto	Automatically selects one of the panels listed under "IGD - LCD panel type"
		LFP(LVDS)	Shows POST on the Power Panel 500 display (LFP = local flat panel)
		EFP(SDL or DVI)	Shows POST on an external panel (EFP = external flat panel)
IGD - LCD panel type ¹⁾	Option for configuring the display resolution	640x480 (5.7) LVDS	640 x 480 resolution (for 5.7" displays)
		800x480 (7.0) LVDS	800 x 480 resolution (for 7" displays)
		800x600 (8.4) LVDS	800 x 600 resolution (for 8.4" displays)
		640x480 (10.4) LVDS	640 x 480 resolution (for 10.4" displays)
		800x600 (12.0) LVDS	800 x 600 resolution (for 12.0" displays)
		1024x768 (15.0) LVDS	1024 x 768 resolution (for 15" displays)
Remote Panel ²⁾	Option for controlling the device remotely (with no display connected) from another PC via the Ethernet interface. This makes it possible to make BIOS settings.	Enabled	Enables this function
		Disabled	Disables this function

Table 127: US15W Advanced - Video configuration - Configuration options

- 1) This setting is only available for PP500 system units.
- 2) This setting is only shown if an I/O board is installed. This option does not appear if a display is connected or integrated. It is also shown on APC511 system units if no I/O board is installed.

1.5.6 USB configuration

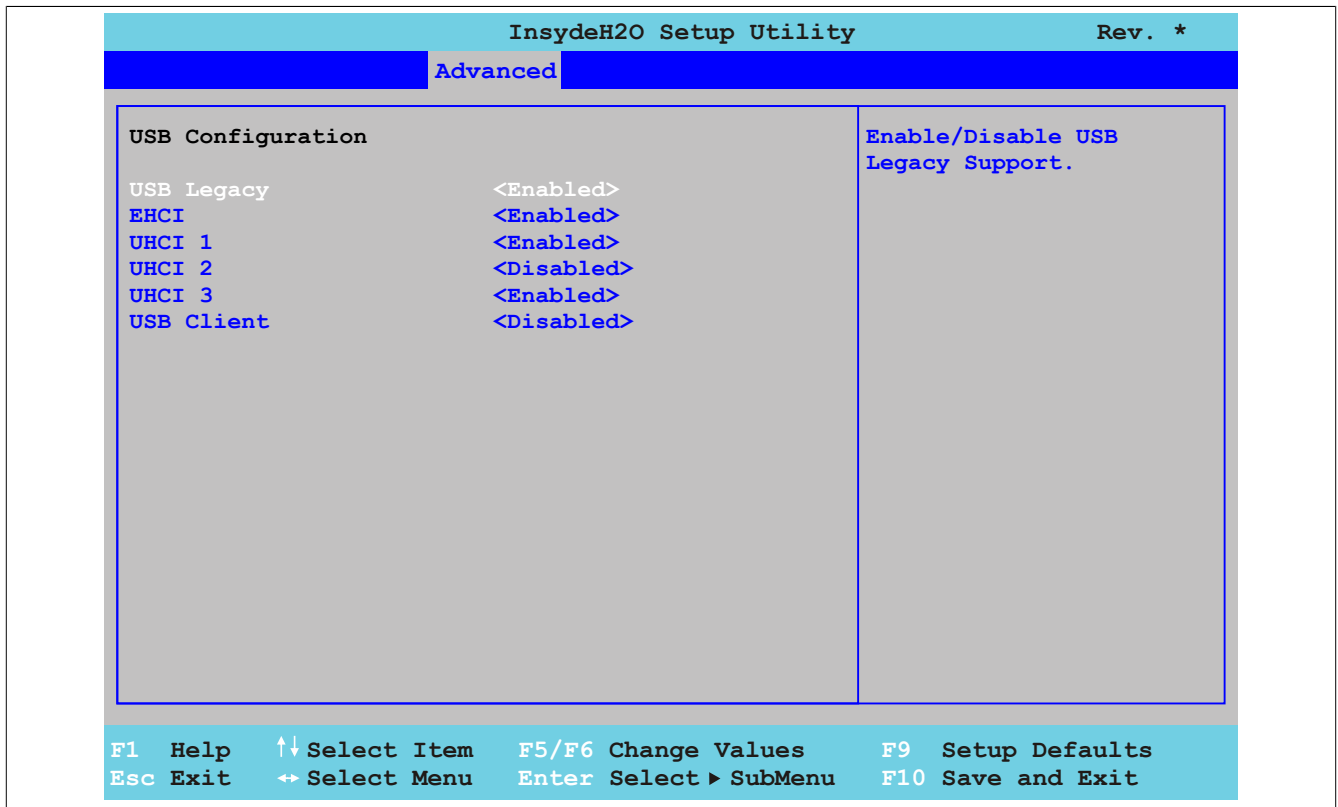

Figure 112: US15W Advanced - USB Configuration

BIOS setting	Function	Configuration options	Effect
USB Legacy	Enables/Disables Legacy USB support. USB ports do not function during startup. USB support is available again after the operating system has started. A USB keyboard is still recognized during POST.	Enabled	Enables this function
		Disabled	Disables this function
EHCI	Allows support for operating systems to be set up without the fully automatic EHCI function	Enabled	Enables USB support USB 2.0 support is enabled as soon as a USB 2.0 device is connected to the interface.
		Disabled	Disables USB 2.0 support
UHCI 1	Configures USB UHCI controller 1 for USB ports 1, 2 and 3	Enabled	Enables USB support
		Disabled	Disables USB support
			<p>Warning!</p> <p>If this setting is <i>Disabled</i>, then the settings <i>UHCI 2</i> and <i>UHCI 3</i> will also be set to <i>Disabled</i> and all USB ports will be disabled. As a result, it will no longer be possible to enter BIOS.</p> <p>However, if UHCI 1 has been disabled, then you can use the Backup BIOS to once again enter BIOS. For more information, see "OEM features" on page 159</p>
UHCI 2 ¹⁾	Configures USB UHCI controller 2 for USB ports on the I/O board	Enabled	Enables USB support
		Disabled	Disables USB support
UHCI 3 ¹⁾	Configures USB UHCI controller 3 for USB port 3	Enabled	Enables USB support
		Disabled	Disables USB support
USB client	Setting for USB client support	Enabled	Enables USB Client support
		Disabled	Disables USB Client support

Table 128: US15W Advanced - USB configuration - Configuration options

1) These settings are only possible if UHCI 1 is set to Enabled.

1.5.7 SDIO configuration

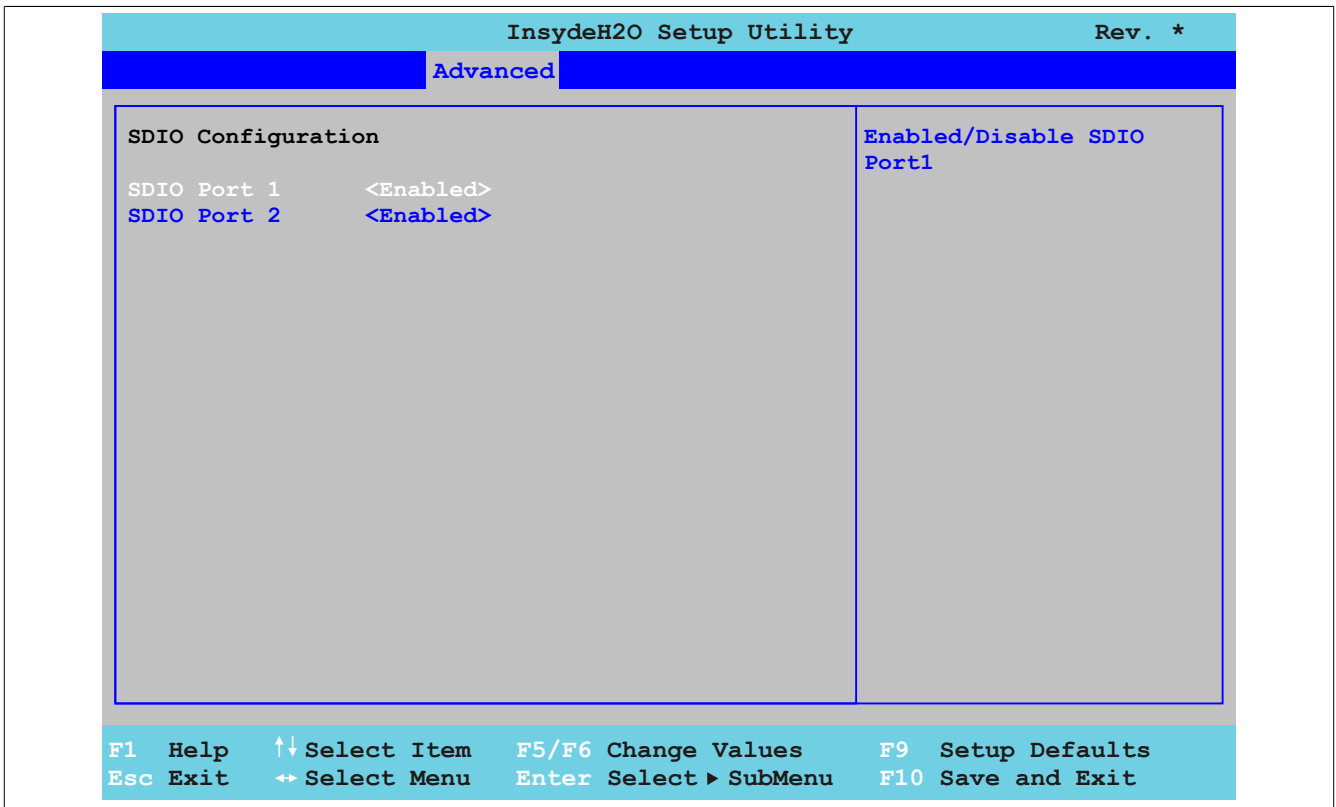

Figure 113: US15W Advanced - SDIO Configuration

BIOS setting	Function	Configuration options	Effect
SDIO port 1	Option for enabling/disabling SDIO port 1 (secure digital input output - SD memory card slot)	Enabled	Enables this function
		Disabled	Disables this function
SDIO port 2	Option for enabling/disabling SDIO port 2 (secure digital input output - SD memory card slot)	Enabled	Enables this function
		Disabled	Disables this function

Table 129: US15W Advanced - SDIO configuration - Configuration options

1.5.8 ACPI table/features control

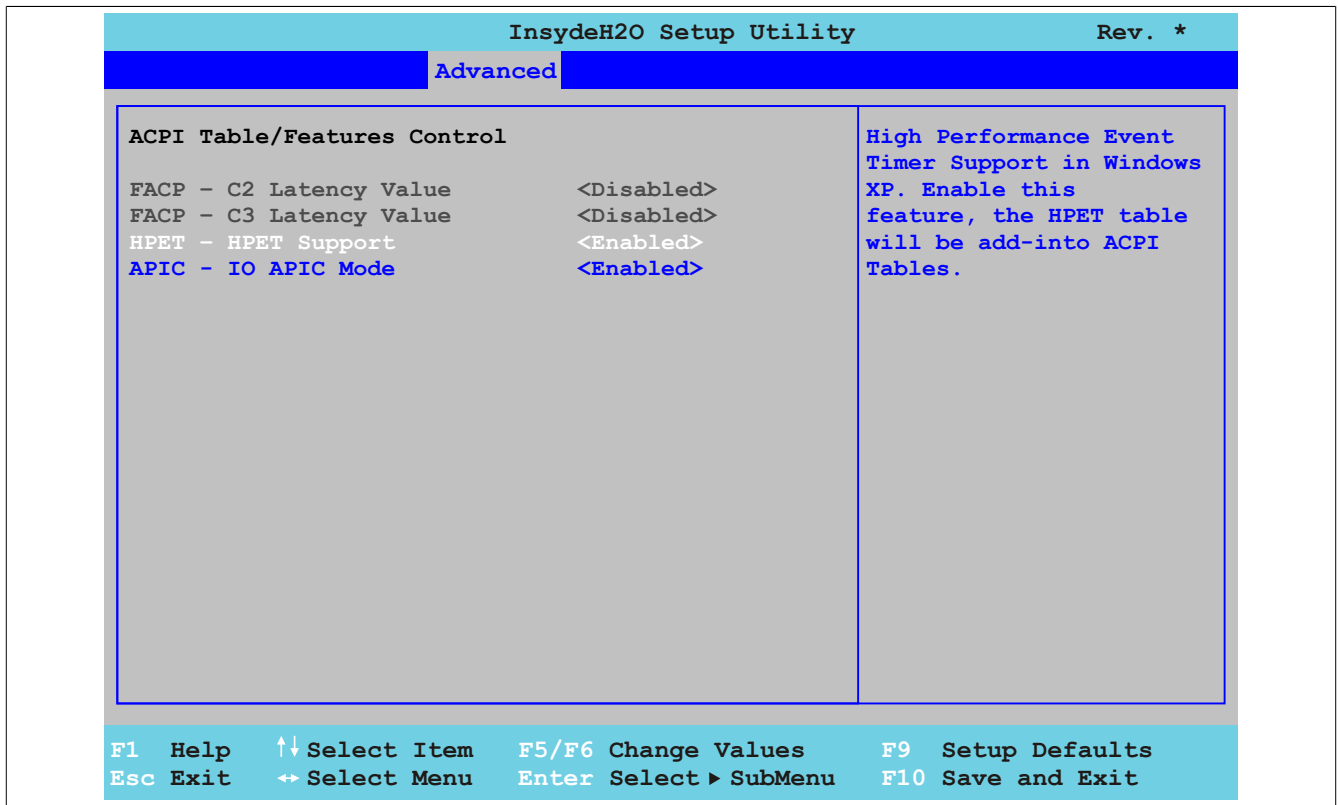

Figure 114: US15W Advanced - ACPI Table/Features Control

BIOS setting	Function	Configuration options	Effect
FACP – C2 latency value ¹⁾	Option for setting a latency period in the C2 state	Enabled	Enables this function Sets a latency of 1 μ s (i.e. the C2 state will be entered within 1 μ s and exited again within 1 μ s)
		Disabled	Disables this function
FACP – C3 latency value ¹⁾	Option for setting a latency period in the C3 state	Enabled	Enables this function Sets a latency of 85 μ s (i.e. the C3 state will be entered within 85 μ s and exited again within 85 μ s)
		Disabled	Disables this function
HPET – HPET support	The HPET is a timer inside the PC. It is able to trigger an interrupt with a high degree of accuracy, which allows other programs to better synchronize a variety of applications.	Enabled	Enables this function This function is recommended for multimedia applications.
		Disabled	Disables this function
APIC - I/O APIC mode	This option controls the support of the advanced programmable interrupt controller in the processor.	Enabled	Enables this function
		Disabled	Disables this function

Warning!

Windows XP will not be started if this setting is disabled.

Table 130: US15W Advanced - ACPI table/features control - Configuration options

1) These settings are only possible if *C-States* under the *Advanced CPU control* menu item is set to *Enabled*.

1.5.9 PCI Express root port 1

Warning!

Improper settings can cause instability or device problems. It is therefore strongly recommended that these settings only be changed by experienced users.

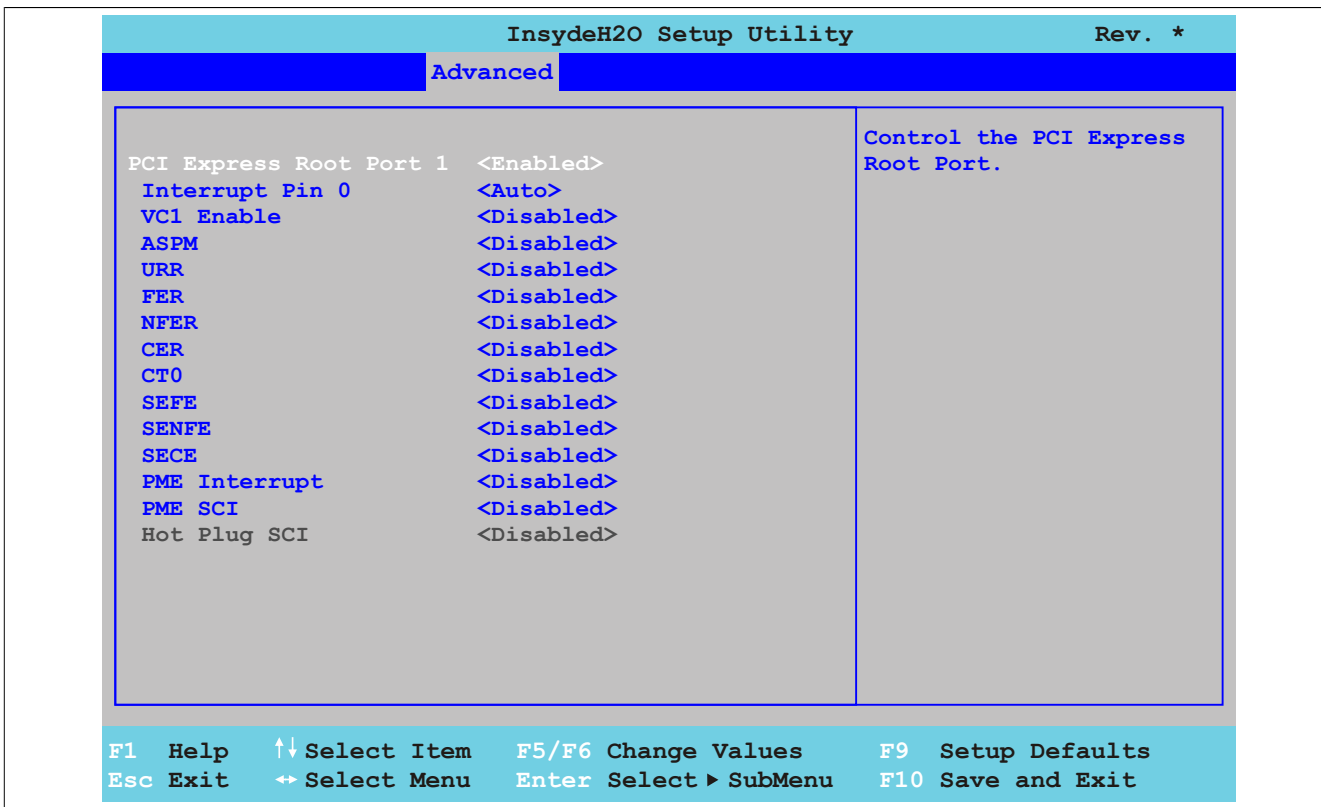

Figure 115: US15W Advanced - PCI Express Root Port 1

BIOS setting	Function	Configuration options	Effect
PCI Express root port 1	Option for enabling/disabling PCI Express root port 1	Enabled	Enables PCI Express root port 1
		Disabled	Disables PCI Express root port 1 and 2
Interrupt pin 0		Auto	Enables IRQ for root port 1
		Disabled	Disables IRQ for root port 1
VC1 enable	Virtual channel 1	Auto	Configures the mapping under the "VC1/TC mapping" setting in BIOS
		Disabled	Disables this function Automatically uses the TC0 traffic class and maps it to the VC0 virtual channel
VC1/TC mapping ¹⁾	Option for defining which traffic will be mapped to which virtual channel	TC0	TBD
		TC1	Maps the TC1 traffic class manually to the VC1 virtual channel
		TC2	Maps the TC2 traffic class manually to the VC1 virtual channel
		TC3	Maps the TC3 traffic class manually to the VC1 virtual channel
		TC4	Maps the TC4 traffic class manually to the VC1 virtual channel
		TC5	Maps the TC5 traffic class manually to the VC1 virtual channel
		TC6	Maps the TC6 traffic class manually to the VC1 virtual channel
		TC7	Maps the TC7 traffic class manually to the VC1 virtual channel
ASPM	<i>Active state power management</i> Option for configuring a power saving function (L0s/L1) for PCIe link cards if they do not require full power	Enabled	Enables this function
		Disabled	Disables this function
Automatic ASPM ²⁾	Option for manually or automatically configuring ASPM.	Auto	Automatic assignment by BIOS and the operating system
		Manual	Assignment under the BIOS setting "ASPM L0s" and "ASPM L1"
ASPM L0s ³⁾	Option for configuring the L0 power saving function	Disabled	Disables this function
		Root port only	Enables the power saving function for the root port
		Endpoint port only	Enables the power saving function for the endpoint port
		Root & endpoint ports	Enables the power saving function for the root and endpoint ports
ASPM L1 ³⁾	Option for configuring the L1 power saving function Power consumption is lower than with L0, but the exit latency is higher.	Enabled	Enables this function
		Disabled	Disables this function
URR	<i>Unsupported Request (UR) reporting</i>	Enabled	Enables this function

Table 131: US15W Advanced - PCI Express root port 1 - Configuration options

BIOS setting	Function	Configuration options	Effect
	Option for reporting unsupported requests. Logging of error messages received by the root port is controlled exclusively by the root control register.	Disabled	Disables this function
FER	<i>Fatal error reporting</i> Option for reporting fatal errors. All of the functions of a multifunction device will be monitored. The report for the root port takes place internally inside the root complex.	Enabled	Enables this function
		Disabled	Disables this function
NFER	<i>Non-fatal error reporting</i> Option for reporting non-fatal errors. All of the functions of a multifunction device will be monitored. The report for the root port takes place internally inside the root complex.	Enabled	Enables this function
		Disabled	Disables this function
CER	<i>Correctable error reporting</i> Option for reporting non-fatal errors. All of the functions of a multifunction device will be monitored. The report for the root port takes place internally inside the root complex.	Enabled	Enables this function
		Disabled	Disables this function
CT0	<i>PCI Express completion timer T0</i> Option for enabling/disabling the PCI Express completion timer	Enabled	Enables this function
		Disabled	Disables this function
SEFE	<i>System error on fatal error</i> Option for generating a system error if a fatal error is registered by a device on the root port or by the root port itself	Enabled	Enables this function
		Disabled	Disables this function
SENF	<i>System error on non-fatal error</i> Option for generating a system error if a non-fatal error is registered by a device on the root port or by the root port itself	Enabled	Enables this function
		Disabled	Disables this function
SECE	<i>System error on correctable error</i> Option for generating a system error if a correctable error is registered by a device on the root port or by the root port itself	Enabled	Enables this function
		Disabled	Disables this function
PME interrupt	<i>Power management event interrupt</i> Option for generating a PME interrupt An interrupt is generated when a PME message is received from a PCIe device.	Enabled	Enables this function Generates a PME interrupt when a PME message is received
		Disabled	Disables this function
PME SCI	Option for generating an SCI if power management is detected	Enabled	Enables this function Enables the root port to generate an SCI if power management is detected
		Disabled	Disables this function
Hot plug SCI	Option for generating an SCI if hot plugging is detected	Enabled	Enables this function Enables the root port to generate an SCI if hot plugging is detected
		Disabled	Disables this function

Table 131: US15W Advanced - PCI Express root port 1 - Configuration options

- 1) These settings are only possible if *VC1 Enable* is set to *Auto*.
- 2) These settings are only possible if *ASPM* is set to *Enabled*.
- 3) These settings are only possible if *Automatic ASPM* is set to *Manual*.

1.5.10 PCI Express root port 2

Warning!

Improper settings can cause instability or device problems. It is therefore strongly recommended that these settings only be changed by experienced users.

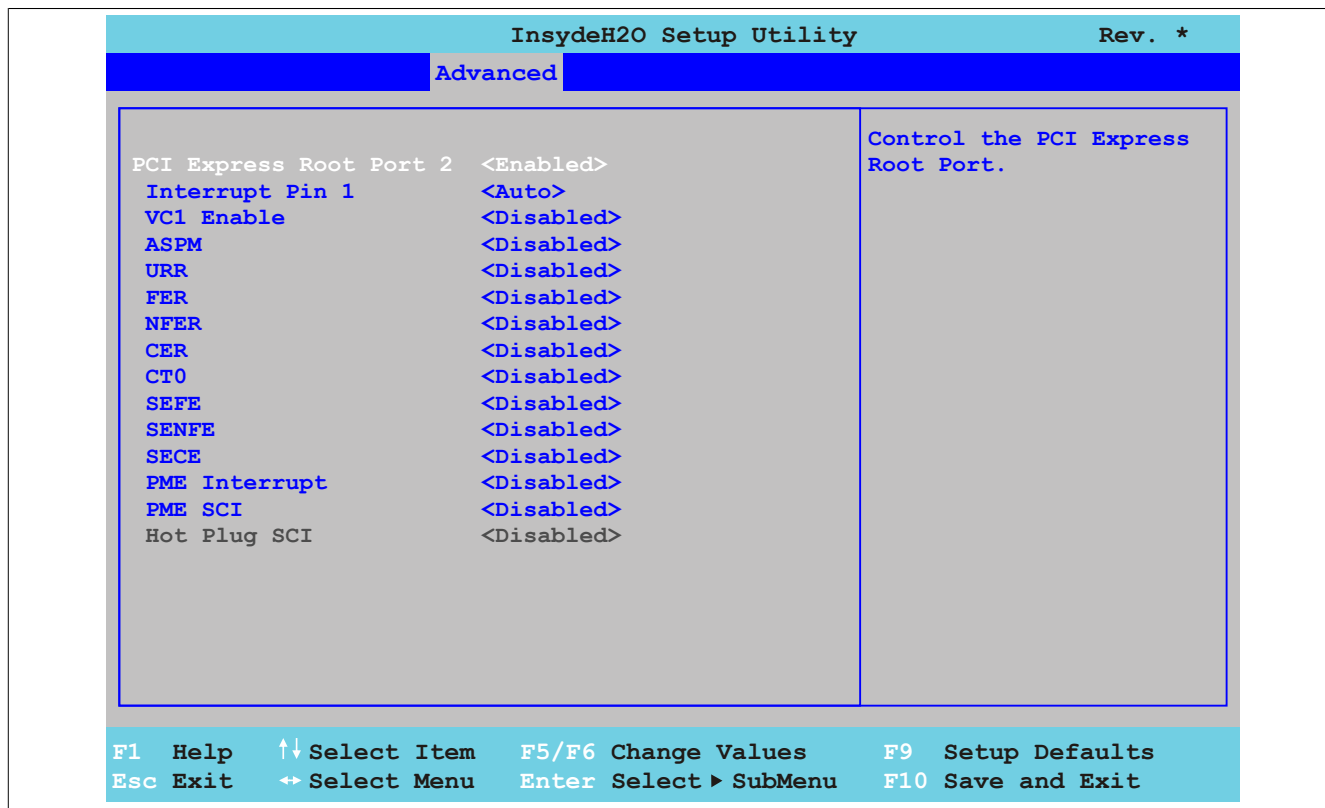

Figure 116: US15W Advanced - PCI Express Root Port 2

BIOS setting	Function	Configuration options	Effect
PCI Express root port 2	Option for enabling/disabling PCI Express root port 2	Enabled	Enables PCI Express root port 2
		Disabled	Disables PCI Express root port 2
Interrupt pin 1	<p>Information:</p> <p>This function is disabled by default when using ARwin and/or a fieldbus card. This function must be disabled in order to use a fieldbus card.</p>	Auto	Enables IRQ for root port 2
		Disabled	Disables IRQ for root port 2
VC1 enable	Virtual channel 1	Auto	Configures the mapping under the "VC1/TC mapping" setting in BIOS
		Disabled	Disables this function Automatically uses the TC0 traffic class and maps it to the VC0 virtual channel
VC1/TC mapping ¹⁾	Option for defining which traffic will be mapped to which virtual channel	TC0	TBD
		TC1	Maps the TC1 traffic class manually to the VC1 virtual channel
		TC2	Maps the TC2 traffic class manually to the VC1 virtual channel
		TC3	Maps the TC3 traffic class manually to the VC1 virtual channel
		TC4	Maps the TC4 traffic class manually to the VC1 virtual channel
		TC5	Maps the TC5 traffic class manually to the VC1 virtual channel
		TC6	Maps the TC6 traffic class manually to the VC1 virtual channel
ASPM	Active state power management Option for configuring a power saving function (L0s/L1) for PCIe link cards if they do not require full power	Enabled	Enables this function
		Disabled	Disables this function

Table 132: US15W Advanced - PCI Express root port 2 - Configuration options

BIOS setting	Function	Configuration options	Effect
Automatic ASPM ²⁾	Option for manually or automatically configuring ASPM.	Auto	Automatic assignment by BIOS and the operating system
		Manual	Assignment under the BIOS setting "ASPM L0s" and "ASPM L1"
ASPM L0s ³⁾	Option for configuring the L0 power saving function	Disabled	Disables this function
		Root port only	Enables the power saving function for the root port
		Endpoint port only	Enables the power saving function for the endpoint port
		Root & endpoint ports	Enables the power saving function for the root and endpoint ports
ASPM L1 ³⁾	Option for configuring the L1 power saving function. Power consumption is lower than with L0, but the exit latency is higher.	Enabled	Enables this function
		Disabled	Disables this function
URR	<i>Unsupported Request (UR) reporting</i> Option for reporting unsupported requests. Logging of error messages received by the root port is controlled exclusively by the root control register.	Enabled	Enables this function
		Disabled	Disables this function
FER	<i>Fatal error reporting</i> Option for reporting fatal errors. All of the functions of a multifunction device will be monitored. The report for the root port takes place internally inside the root complex.	Enabled	Enables this function
		Disabled	Disables this function
NFER	<i>Non-fatal error reporting</i> Option for reporting non-fatal errors. All of the functions of a multifunction device will be monitored. The report for the root port takes place internally inside the root complex.	Enabled	Enables this function
		Disabled	Disables this function
CER	<i>Correctable error reporting</i> Option for reporting non-fatal errors. All of the functions of a multifunction device will be monitored. The report for the root port takes place internally inside the root complex.	Enabled	Enables this function
		Disabled	Disables this function
CT0	<i>PCI Express completion timer T0</i> Option for enabling/disabling the PCI Express completion timer Information: This setting should be set to "Enabled" if the system detected an ROB (processor reorder buffer) timeout.	Enabled	Enables this function
		Disabled	Disables this function
SEFE	<i>System error on fatal error</i> Option for generating a system error if a fatal error is registered by a device on the root port or by the root port itself	Enabled	Enables this function
		Disabled	Disables this function
SENF	<i>System error on non-fatal error</i> Option for generating a system error if a non-fatal error is registered by a device on the root port or by the root port itself	Enabled	Enables this function
		Disabled	Disables this function
SECE	<i>System error on correctable error</i> Option for generating a system error if a correctable error is registered by a device on the root port or by the root port itself	Enabled	Enables this function
		Disabled	Disables this function
PME interrupt	<i>Power management event interrupt</i> Option for generating a PME interrupt An interrupt is generated when a PME message is received from a PCIe device.	Enabled	Enables this function Generates a PME interrupt when a PME message is received
		Disabled	Disables this function
PME SCI	Option for generating an SCI if power management is detected	Enabled	Enables this function Enables the root port to generate an SCI if power management is detected
		Disabled	Disables this function
Hot plug SCI	Option for generating an SCI if hot plugging is detected	Enabled	Enables this function Enables the root port to generate an SCI if hot plugging is detected
		Disabled	Disables this function

Table 132: US15W Advanced - PCI Express root port 2 - Configuration options

- 1) These settings are only possible if *VC1 Enable* is set to *Auto*.
- 2) These settings are only possible if *ASPM* is set to *Enabled*.
- 3) These settings are only possible if *Automatic ASPM* is set to *Manual*.

1.5.11 Console redirection

Information:

These settings are only visible to Automation PC 511 system units without an I/O board. The mode/node switches must be set to "00" (default).

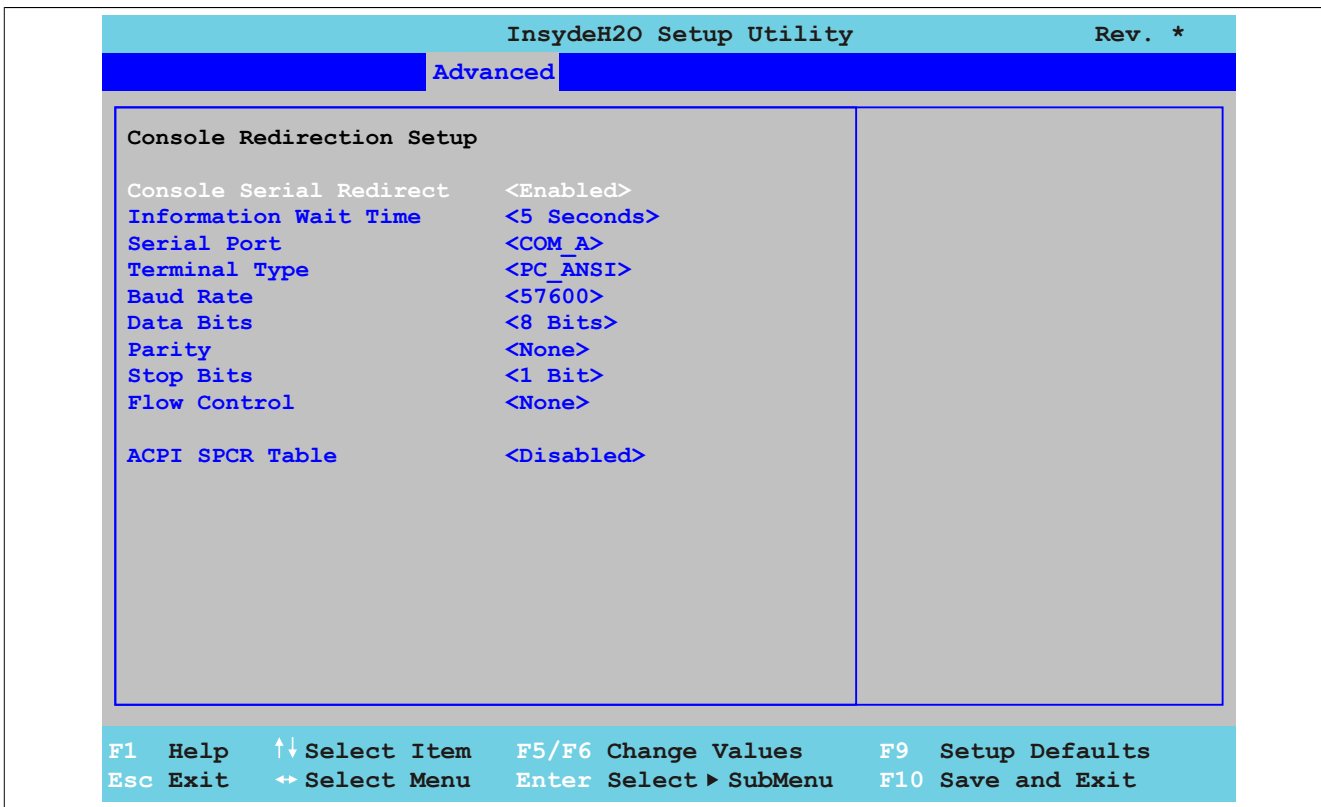

Figure 117: US15W Advanced - Console Redirection

BIOS setting	Function	Configuration options	Effect
Console serial redirect	Option for configuring the remote console. The remote console can be used to access BIOS Setup via the serial interface using a terminal emulator (PuTTY or HyperTerminal).	Enabled	Enables this function
		Disabled	Disables this function
	Information: This setting is automatically enabled when using an APC511 without an I/O board and mode/node switch position "00" (default).		
Information wait time	Option for configuring the amount of time for the remote console to wait before accessing BIOS for the first time	0 seconds, 2 seconds, 5 seconds, 10 seconds, 30 seconds	The remote console waits x seconds before accessing BIOS for the first time.
Serial port	Option for configuring the serial interface	COM_A	Uses the COMA serial interface for access
		COM_B	Uses the COMB serial interface for access
		COM_C	Uses the COMC serial interface for access
		COM_D	Uses the COMD serial interface for access
		All ports	TBD
Terminal type	Option for configuring keyboard input	VT_100	Enables the VT100 convention (ASCII character set)
		VT_100+	Enables the VT100+ convention (ASCII character set and support for color, function keys, etc)
		VT_UTF8	Enables the VT-UTF8 convention (uses UTF8 encoding to assign Unicode characters to one or more bytes)
		PC_ANSI	Enables the PC ANSI convention (extended ASCII character set).
Baud rate	Option for setting the transfer rate of the serial interface (bits per second)	1200, 2400, 4800, 9600, 19200, 38400, 57600, 115200	Enables a transfer rate of x bits
Data bits	Option for configuring the character length (data bits) to use for serial communication	7 bits 8 bits	Character length with 7 bits Character length with 8 bits
Parity	Option for configuring the parity bit to use for serial communication	None	Parity bit not used
		Even	Uses an even number of parity bits
		Odd	Uses an odd number of parity bits
Stop bits	Option for configuring the stop bits to use for serial communication	1-bit	Uses 1 bit as the stop bit
		2-bit	Uses 2 bits as the stop bit
Flow control	Option for configuring the data flow control	None	Disables data flow control

Table 133: US15W Advanced - Console redirection - Configuration options

BIOS setting	Function	Configuration options	Effect
		RTS/CTS	Enables hardware handshake
		XON/XOFF	Enables software handshake
ACPI SPCR table	Option for configuring ACPI serial port console redirection (SPCR)	Enabled	Enables this function
		Disabled	Disables this function

Table 133: US15W Advanced - Console redirection - Configuration options

1.6 Security

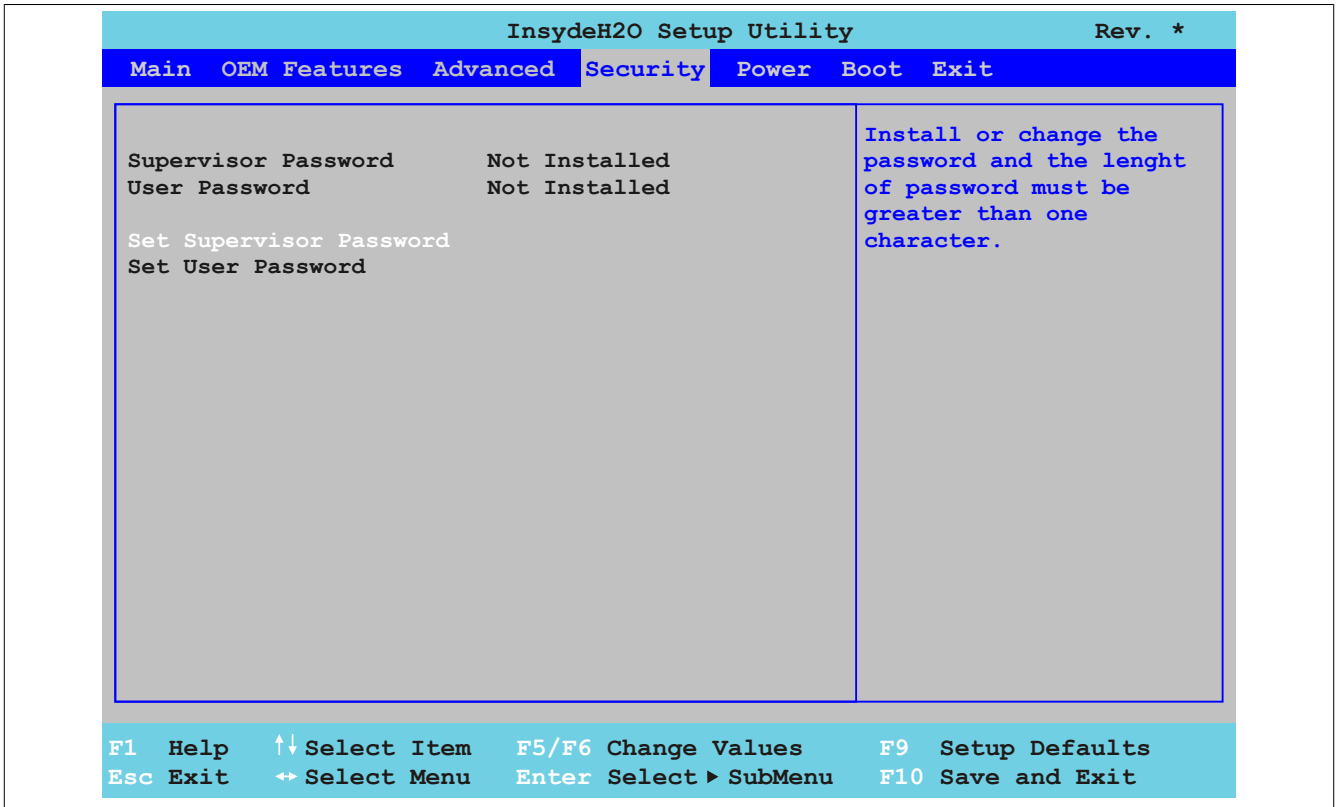

Figure 118: US15W Security - Menü

BIOS setting	Function	Configuration options	Effect
Supervisor password	Displays whether a supervisor password has been set	None	-
User password	Displays whether a user password has been set	None	-
Set supervisor password	Option for entering/changing a supervisor password. A supervisor password is necessary to edit all BIOS settings.	Enter	Password entry
Set user password	Option for entering/changing a user password. The user password allows the user to edit only certain BIOS settings.	Enter	Password entry

Table 134: US15W Security menu - Configuration options

1.6.1 Set supervisor password

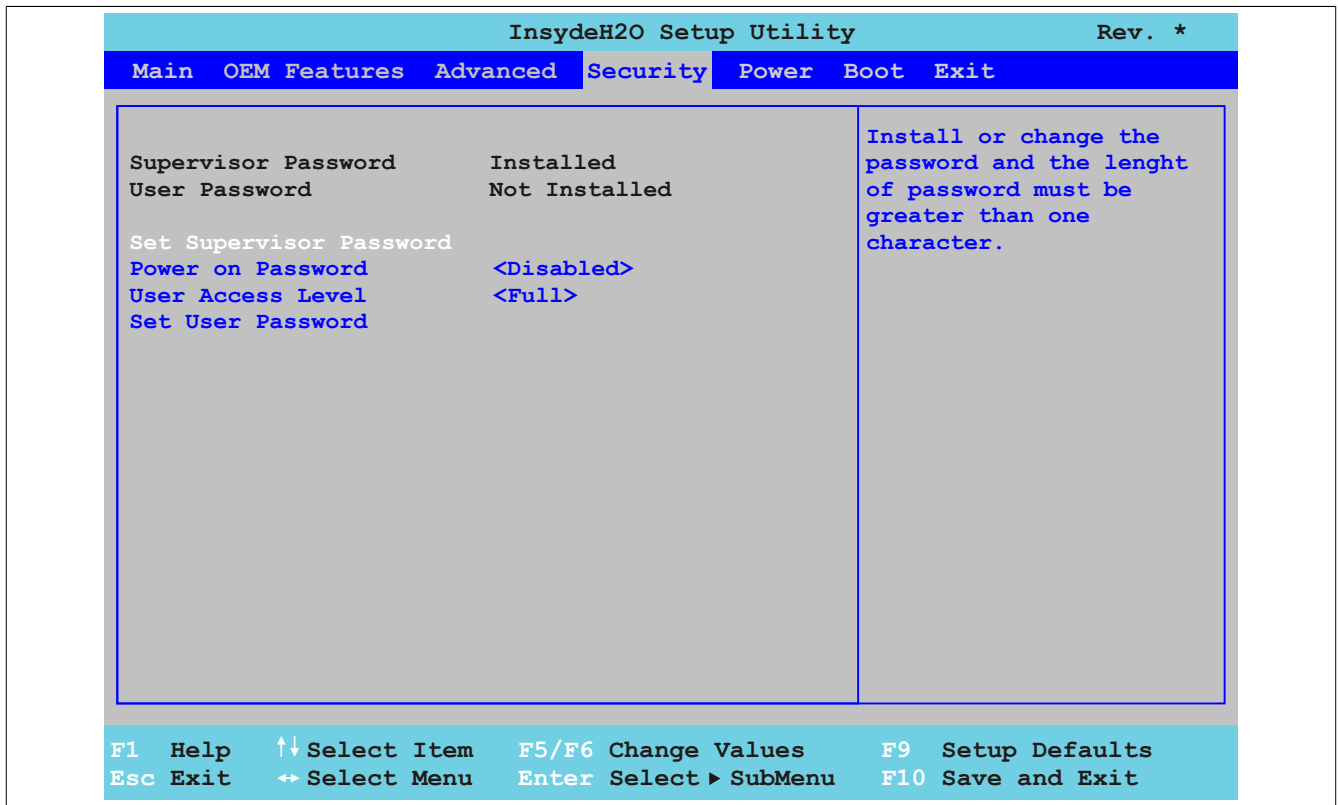

Figure 119: US15W Security - Set Supervisor Password

BIOS setting	Function	Configuration options	Effect
Supervisor password	Displays whether a supervisor password has been set	None	-
User password	Displays whether a user password has been set	None	-
Set supervisor password	Option for entering/changing a supervisor password. A supervisor password is necessary to edit all BIOS settings.	Enter	Password entry
Power on password	The supervisor password must be entered to access BIOS or start the operating system.	Enabled	Supervisor password necessary for POST
		Disabled	Supervisor password necessary for POST, but not to start the operating system
User access level	Assigns operational permissions in BIOS. These settings are only relevant if a user password has been created.	View only	The user can only view BIOS settings (unable to make changes).
		Limited	The user can view all BIOS settings, but only some changes are possible. Settings that the user can change: Main - System time, Main - System date, Advanced - Boot configuration - Numlock
		Full	The user has full access to BIOS and can make any necessary changes.

Table 135: US15W Security - Set supervisor password - Configuration options

1.6.2 Set user password

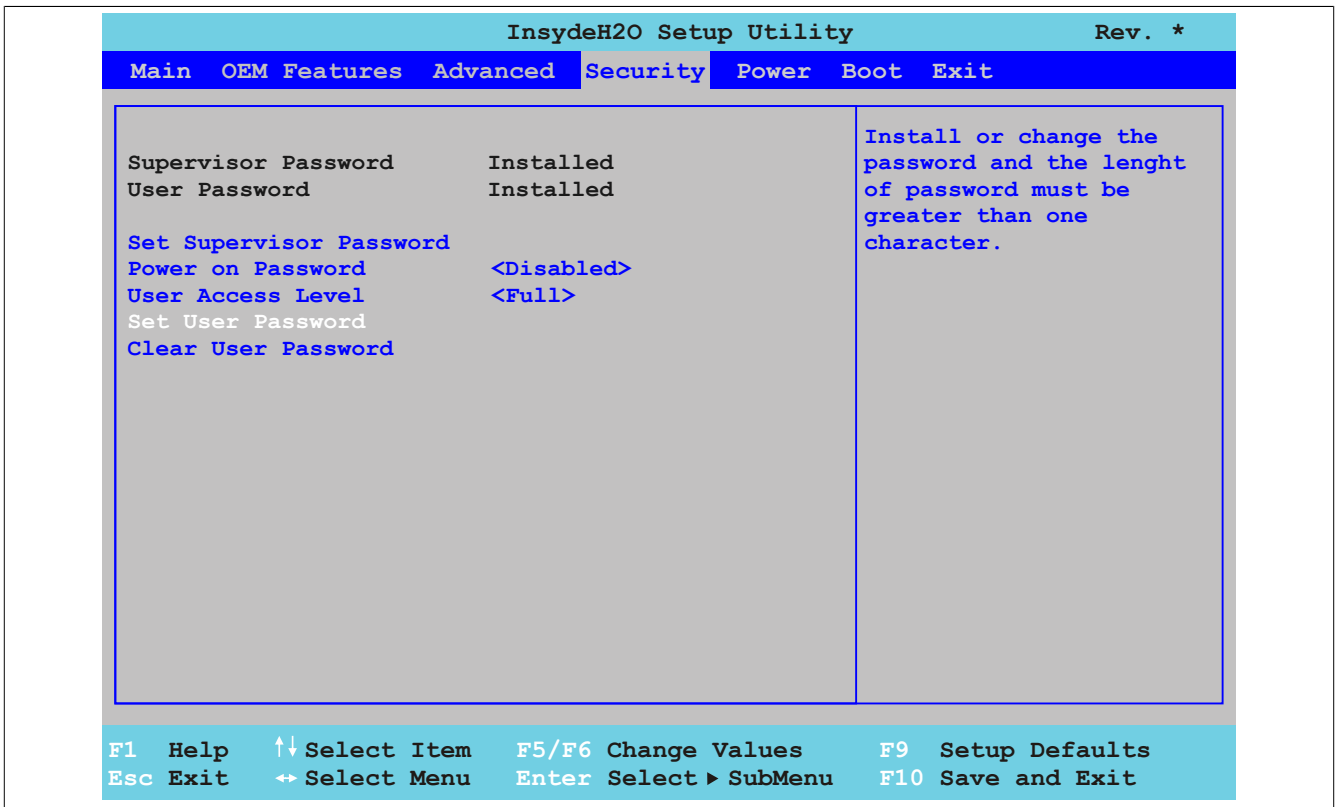

Figure 120: US15W Security - Set User Password

BIOS setting	Function	Configuration options	Effect
Supervisor password	Displays whether a supervisor password has been set	None	-
User password	Displays whether a user password has been set	None	-
Set user password	Option for entering/changing a user password. The user password allows the user to edit only certain BIOS settings.	Enter	Password entry
Clear user password ¹⁾	Option for clearing the user password		Clears the user password

Table 136: US15W Security - Set user password - Configuration options

1) This setting is only visible if a user password was created with *Set user password*.

1.7 Power

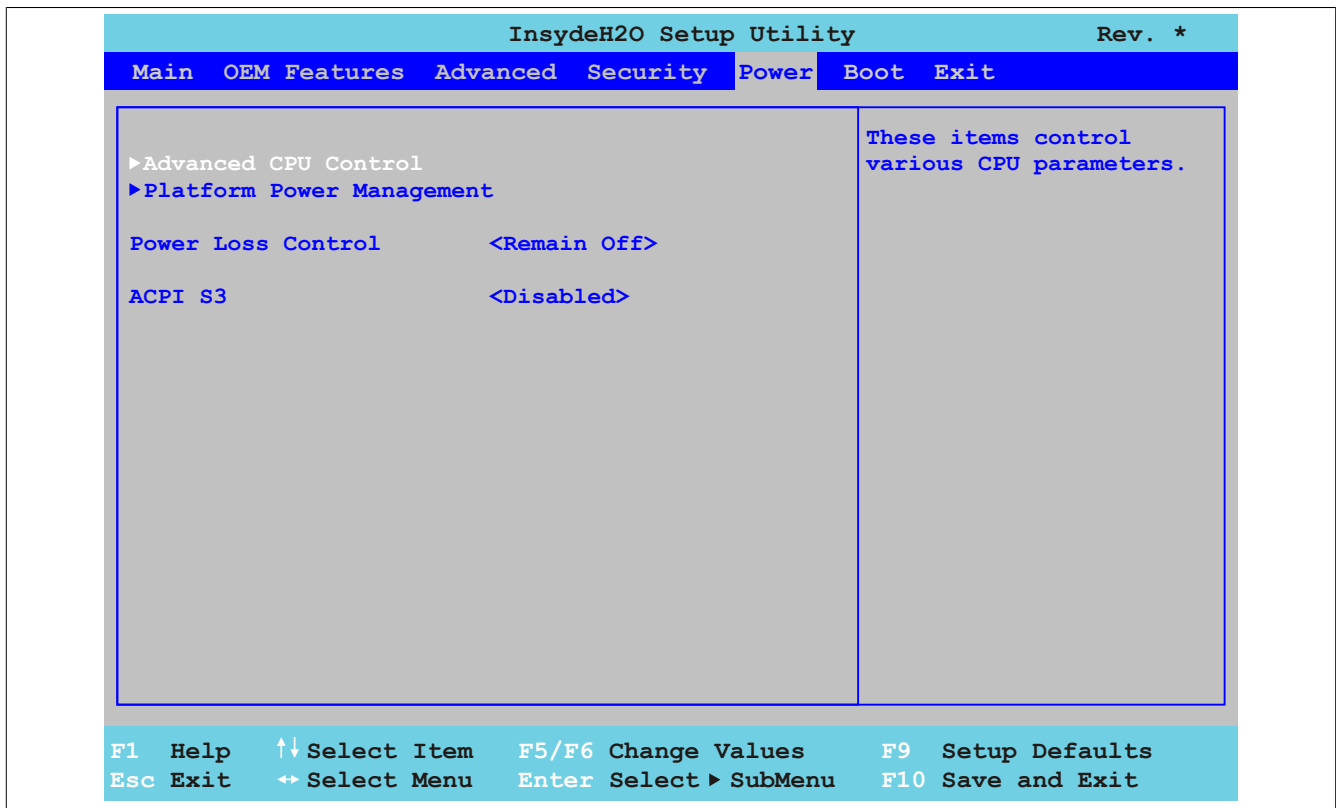

Figure 121: US15W Power - Menü

BIOS setting	Function	Configuration options	Effect
Advanced CPU control	Configures advanced CPU control settings	None	Opens the submenu See "Advanced CPU control" on page 198
Platform power management	Configures platform power management settings	None	Opens the submenu See "Platform power management" on page 201
Power loss control	Option for determining what should happen after a power failure	Remain off	The device remains off.
		Turn on	The device turns back on.
ACPI S3	Option for determining whether or not the operating system should be written to the RAM and whether only RAM should be supplied with power	Enabled	Enables this function
		Disabled	Disables the function

Table 137: US15W Power menu - Configuration options

1.7.1 Advanced CPU control

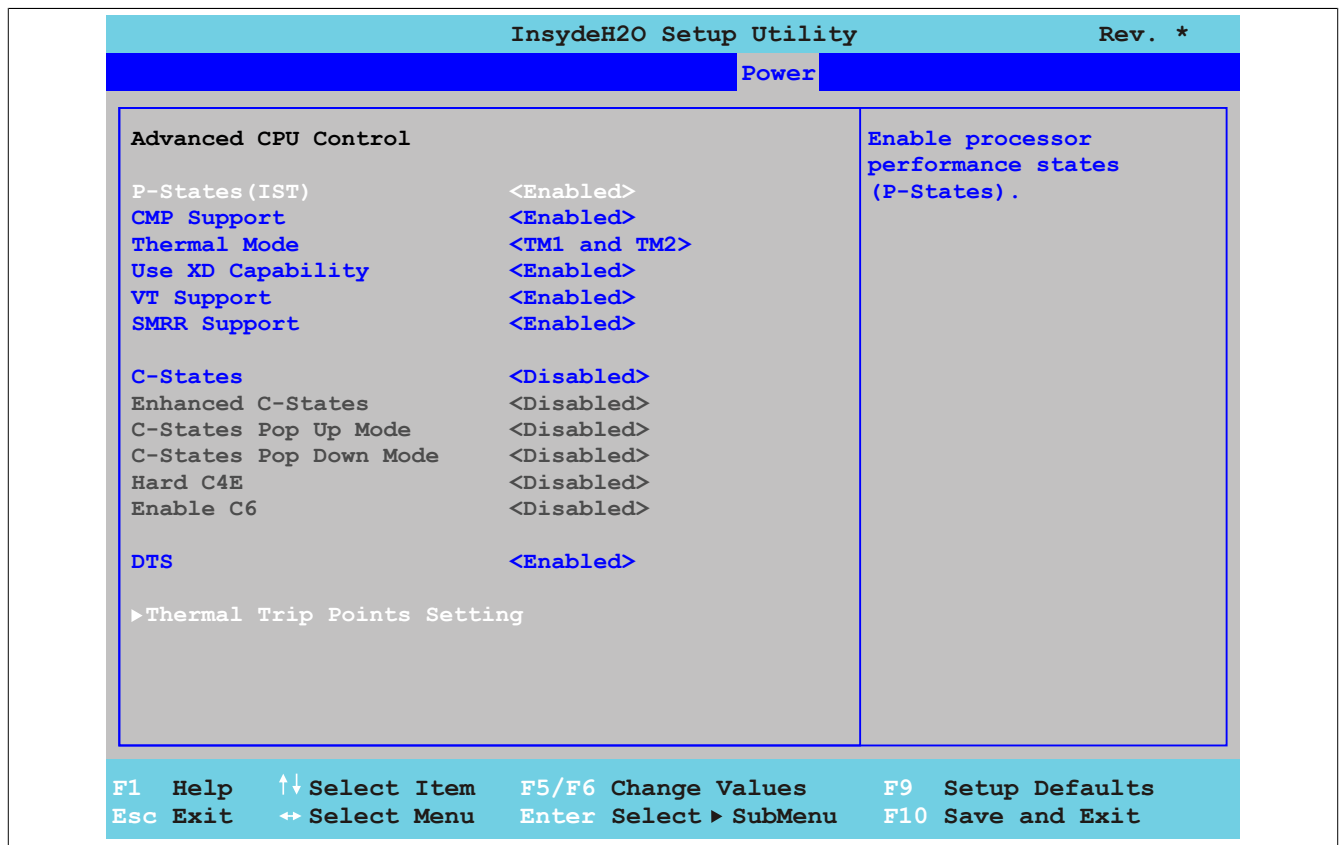

Figure 122: US15W Power - Advanced - CPU Control

BIOS setting	Function	Configuration options	Effect
P-States(IST)	Option for controlling the Intel(R) SpeedStep(TM) technology. The processor clock speed is increased or decreased according to the number of calculations that must be made. As a result, the power consumption depends largely on the processor load.	Enabled	The processor speed is regulated by the operating system.
		Disabled	Disables SpeedStep technology
CMP support	<p>This option supports the use of multiple CPUs (CMP = core multi-processing).</p> <p>Information:</p> <p>In order to use ARwin, CMP support must be switched off to avoid runtime violations.</p>	Enabled	Enables this function
		Disabled	Disables this function
Thermal mode ¹⁾	<p>Option for configuring temperature monitoring</p> <p>Information:</p> <p>To operate the processor within the specified values, changing the default setting (TM1 and TM2) is not recommended.</p>	Disabled	Disables temperature monitoring
		TM1	Enables Intel Thermal Mode 1 If the CPU reaches excessive temperatures, the processor speed will be reduced by 50%.
		TM2	Enables Intel Thermal Mode 2 If the CPU reaches excessive temperatures, the SpeedStep technology will be enabled.
		TM1 and TM2	Enables Intel Thermal Mode 1 and 2. If the CPU reaches excessive temperatures, TM1 reduces the processor speed by 50% and TM2 enables Intel SpeedStep technology.
Use XD capability	This option is a safety feature that protects specific data regions of system memory from potentially damaging code.	Enabled	Enables this function
		Disabled	Disables this function
VT support	<p>Option for enabling/disabling a virtual machine</p> <p>Information:</p> <p>A restart is required in order to apply changes made to this setting.</p>	Enabled	Allows a virtual machine to use the additional hardware capacity
		Disabled	Disables this function

Table 138: US15W Power - Advanced CPU control - Configuration options

BIOS setting	Function	Configuration options	Effect
SMRR support	The SMRR (system management range register) limits cacheable references of addresses in SM-RAM so that code can be run in SMM (system management mode). In some circumstances, an intruder who is logged on as administrator could configure the Intel processor to gain access to the SMM. Enabling SMRR reduces this risk of unauthorized access.	Enabled	Enables this function
		Disabled	Disables this function
C-States	This setting allows the operating system to set the processor clock speed on its own, thereby saving energy.	Enabled	Enables this function The processors are operated at different frequencies to save energy.
		Disabled	Disables this function Both processors are operated at the same frequency.
Enhanced C-States ²⁾	This setting allows the operating system to set the processor clock speed on its own, thereby saving energy.	Enabled	Enables this function
		Disabled	Disables this function
C-State pop up mode	This setting makes it possible to detect bus master requests and assign processor clock frequencies, thereby saving energy.	Enabled	If the ICH receives a bus master request, then the system changes from the C3/C4 state to the C2 state and the bus master is enabled automatically.
		Disabled	Bus master data transfer is a break event, and the ICH will attempt to return to the C0 state.
C-State pop down mode ³⁾	This setting makes it possible to detect bus master requests and assign processor clock frequencies, thereby saving energy.	Enabled	If the ICH does not receive a bus master request, then the system will be reset back to the C3/C4 state.
		Disabled	The ICH will not attempt to automatically return to C3/C4 state.
Hard C4E ⁴⁾	Power management for the Intel Atom processor - Enhanced C4 support	Enabled	Enables this function Reduces CPU voltage and turns off the memory cache
		Disabled	Disables this function
Enable C6	Power management for the Intel Atom processor - C6 support	Enabled	Enables this function Reduces the internal CPU voltage (can also be 0 V)
		Disabled	Disables this function
DTS	Option for enabling or disabling the CPU digital thermal sensor function	Enabled	Enables this function
		Disabled	Disables this function
Thermal trip points setting ⁵⁾	Configures thermal trip points settings	Enter	Opens the submenu See "Thermal trip points settings" on page 200

Table 138: US15W Power - Advanced CPU control - Configuration options

- 1) These settings are only possible if *P-States(IST)* is set to *Enabled*.
- 2) These settings are only possible if *C-States* is set to *Enabled*.
- 3) These settings are only possible if *C-States pop up mode* is set to *Enabled*.
- 4) These settings are only possible if *Enhanced C-States* is set to *Enabled*.
- 5) These settings are only possible if *DTS* is set to *Enabled*.

1.7.1.1 Thermal trip points settings

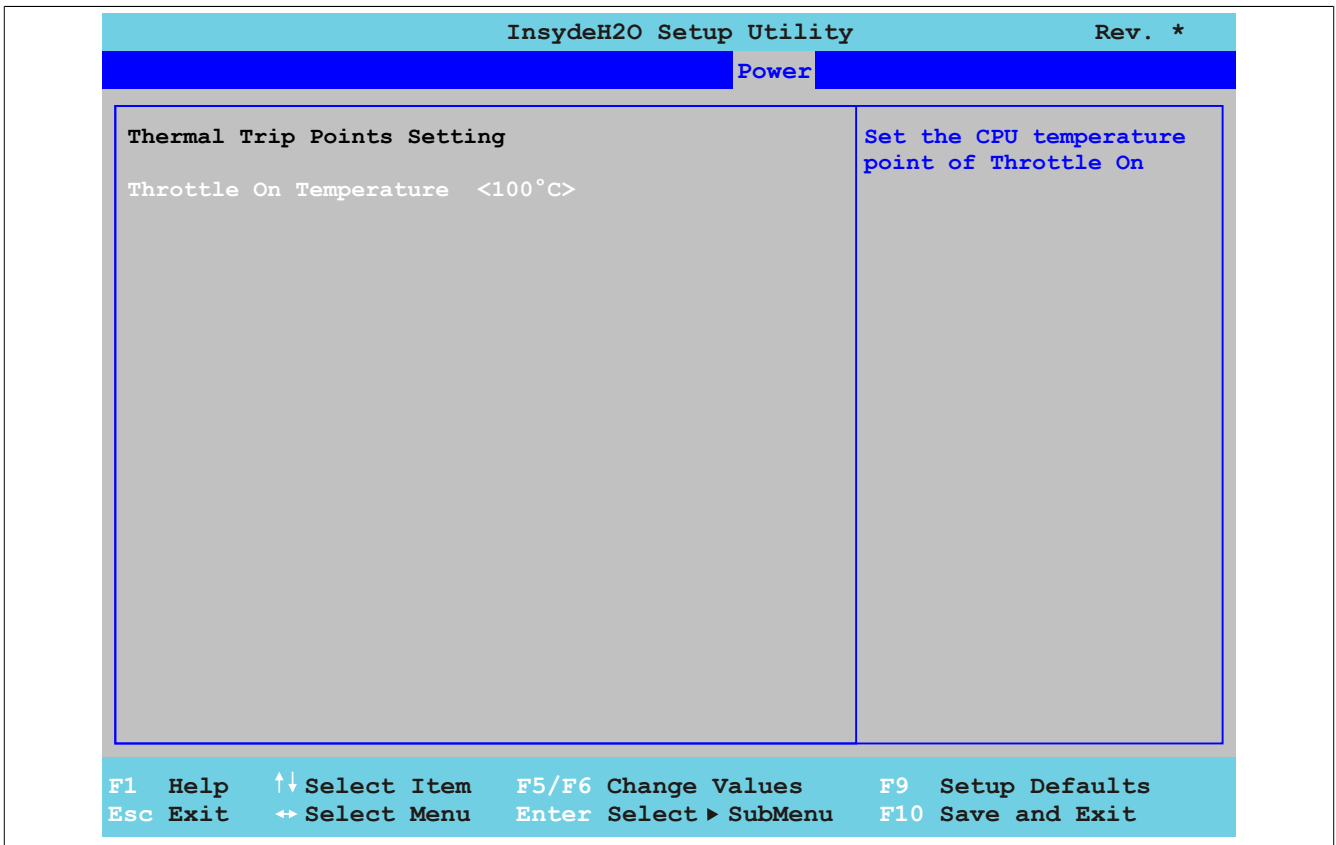

Figure 123: US15W Power - Advanced - CPU Control - Thermal Trip Points Settings

BIOS setting	Function	Configuration options	Effect
Throttle on temperature	Option for configuring a CPU temperature at which the operating system throttles the system	40°C, 45°C, 50°C, 55°C, 60°C, 65°C, 70°C, 75°C, 80°C, 85°C, 90°C, 95°C, 100°C	Temperature setting for the thermal trip point. Configurable in increments of 5 degrees.

Table 139: US15W Power - CPU control - Thermal trip points settings - Configuration options

1.7.2 Platform power management

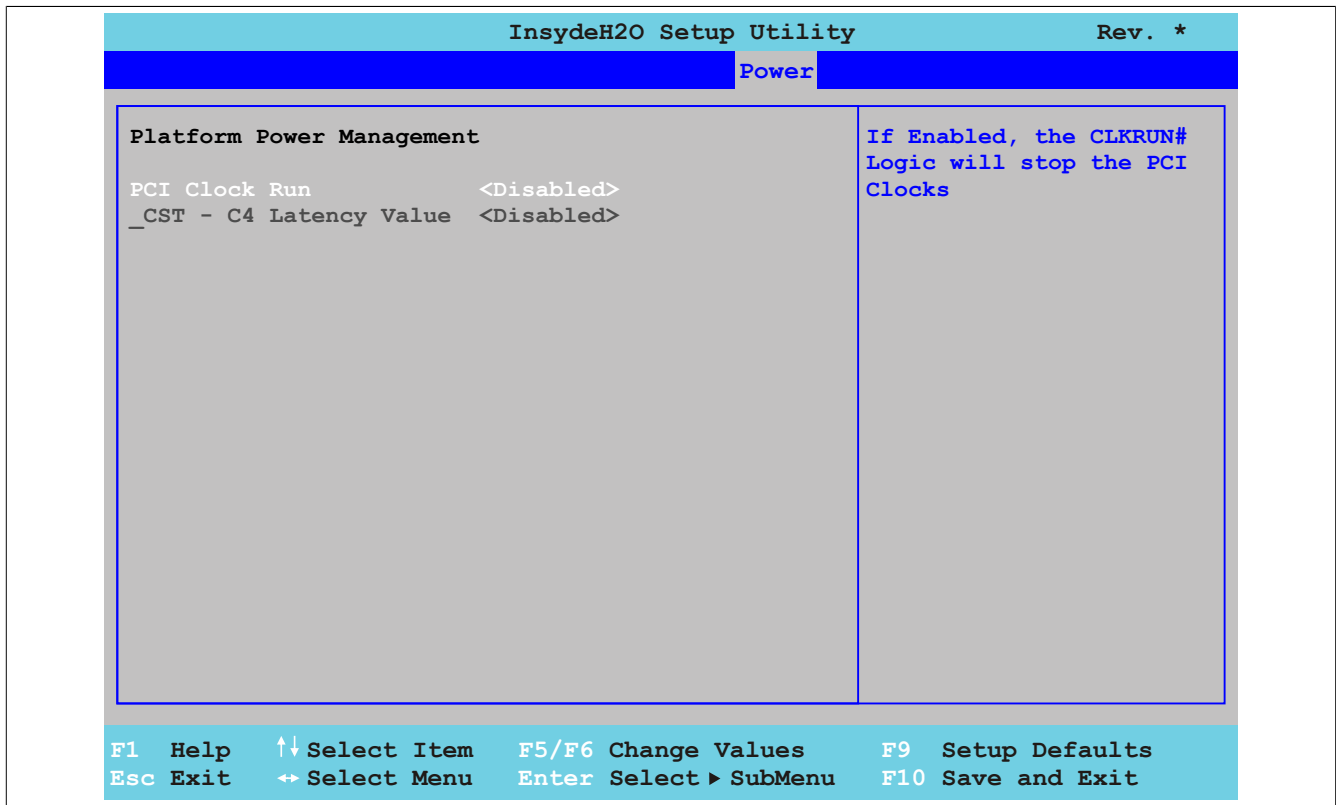

Figure 124: US15W Power - Platform Power Management

BIOS setting	Function	Configuration options	Effect
PCI clock run	Option for enabling/disabling the PCI clocks to save energy	Enabled	Enables this function
		Disabled	Disables this function
_CST - C4 latency value ¹⁾	Option for enabling/disabling the latency period for C4 C-States in the ACPI _CST object Information: For more detailed information about this setting, see the ACPI specification (www.acpi.info).	Enabled	Enables this function
		Disabled	Disables this function
C4 on C3 - Deeper sleep ²⁾	Fine-tunes the power saving function on an ACPI operating system	Enabled	Brings the processor to C4 if the operating system is initiated in a C3 state
		Disabled	Disables this function

Table 140: US15W Power - Platform power management - Configuration options

- 1) These settings are only possible if *C-States* under the *Advanced CPU control* menu item is set to *Enabled*.
 2) These settings are only possible if *_CST - C4 Latency Value* is set to *Enabled*.

1.8 Boot

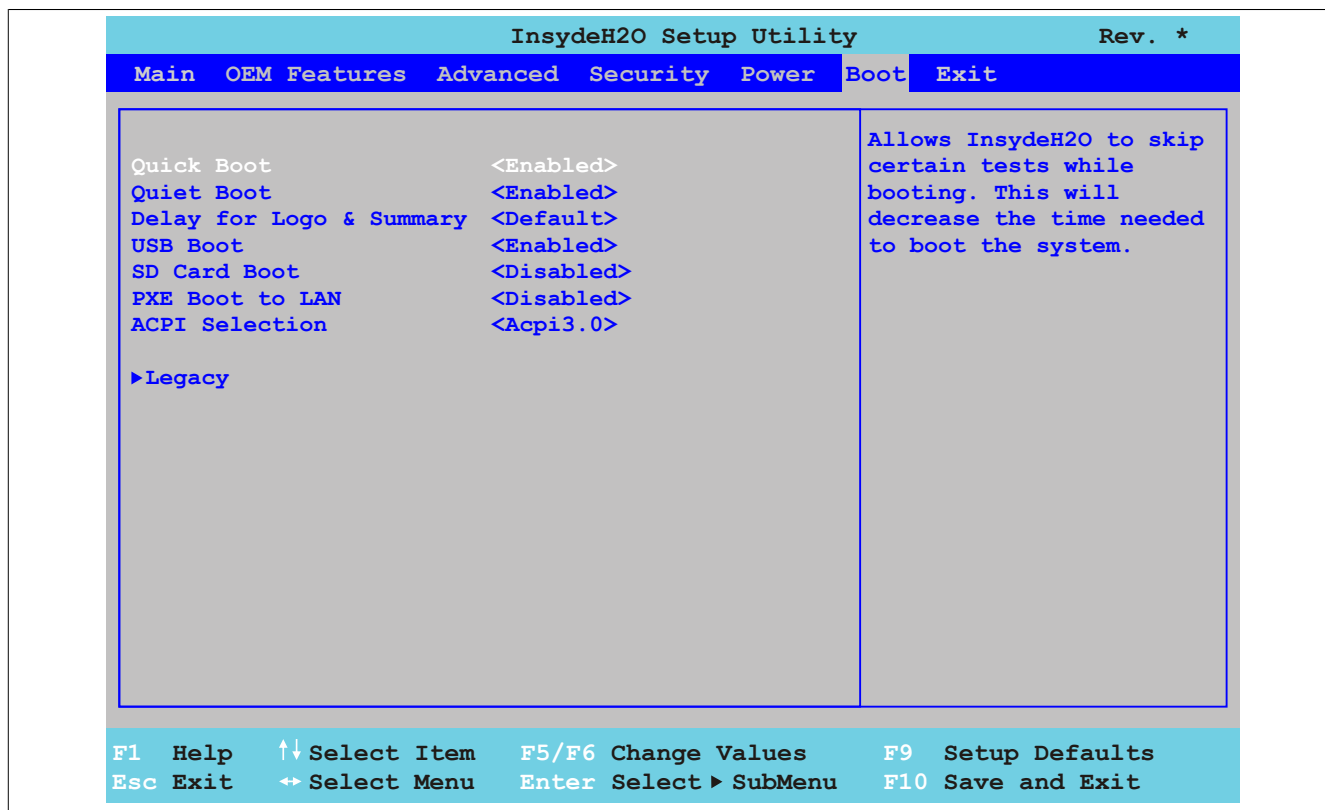

Figure 125: US15W Boot - Menü

BIOS setting	Function	Configuration options	Effect
Quick boot	This function reduces the boot time by skipping some POST tests.	Enabled	Enables this function
		Disabled	Disables this function
Quiet boot	Determines whether the POST message or the OEM logo (default = black background) is displayed	Enabled	Displays the OEM logo instead of the POST message
		Disabled	Displays the POST message
Delay for logo & summary	Option for setting the display duration of the logo and summary screen	Default	Minimizes the display duration for a quick boot procedure
		1 sec., 1.5 sec., 2 sec., 2.5 sec., 3 sec., 4 sec., 5 sec., 10 sec., 20 sec.	Allows a display duration of x seconds to be defined
USB boot	Function for enabling/disabling the option of booting from USB devices	Enabled	Enables this function
		Disabled	Disables this function
SD card boot	Function for enabling/disabling the option of booting from SD cards	Enabled	Enables this function
		Disabled	Disables this function
<div style="border-left: 2px solid black; padding-left: 10px;"> <p>Warning!</p> <p>SD memory cards can only be used as mass storage devices. It is not possible to boot from an SD card.</p> </div>			
PXE boot to LAN	Function for enabling/disabling the option of booting from LAN (ETH)	Enabled	Enables this function
		Disabled	Disables this function
ACPI selection	Option for setting the power option specifications to be supported. The ACPI functions must be supported by the drivers and operating systems being used.	Acpi 1.0B	Uses ACPI functions in accordance with v1.0B
		Acpi 3.0	Uses ACPI functions in accordance with v3.0
		Acpi 4.0	Uses ACPI functions in accordance with v4.0
Legacy	Configures and displays the boot order	Enter	Opens the submenu See "Legacy" on page 203

Table 141: US15W Boot menu - Configuration options

1.8.1 Legacy

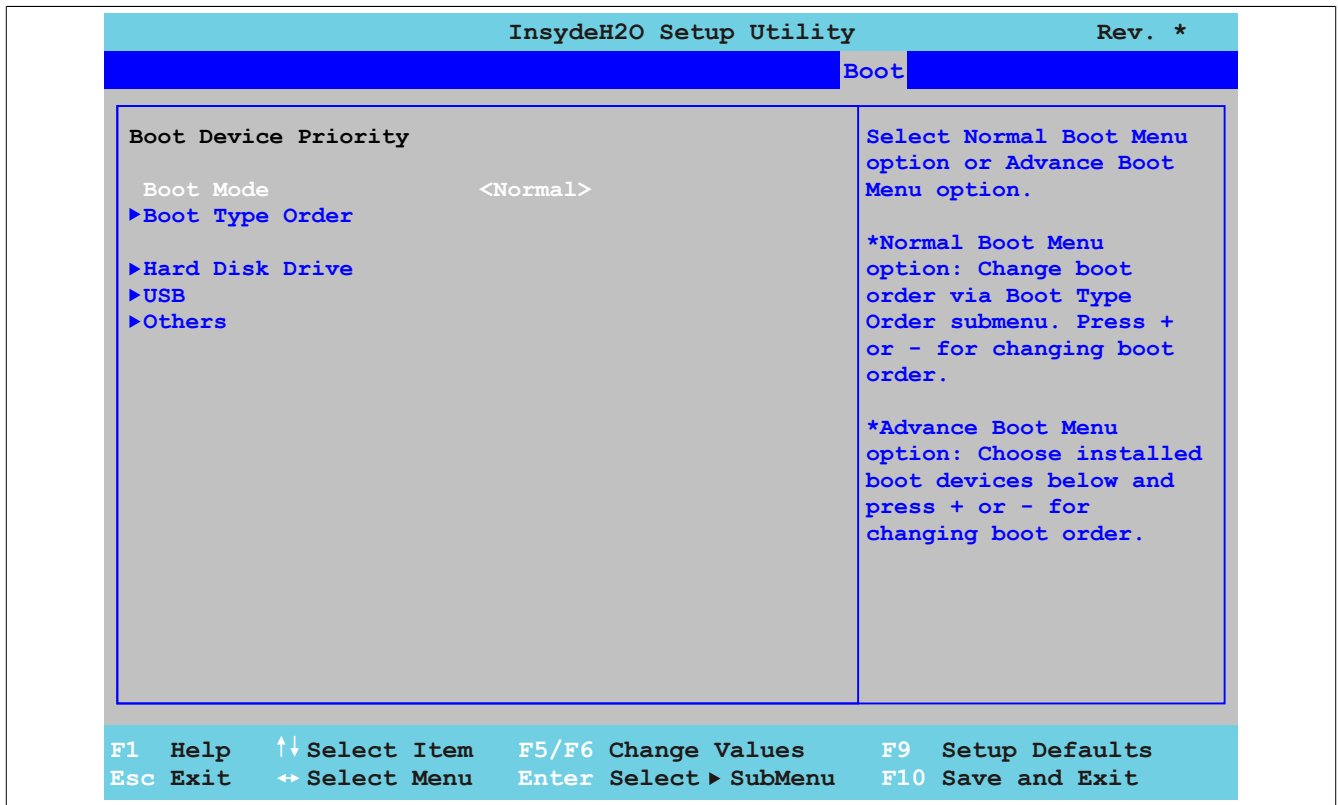

Figure 126: US15W Boot - Legacy

BIOS setting	Function	Configuration options	Effect
Boot mode	Boot mode configuration	Normal	Displays the submenus for changing the boot sequence settings
		Advanced	Displays only the product names of connected bootable devices. The boot sequence can be defined here.
Boot type order ¹⁾	Configures boot type order settings	Enter	Opens the submenu See "Boot type order" on page 204
Hard disk drive ¹⁾²⁾	Displays inserted CompactFlash cards	Enter	Opens the submenu See "Hard disk drive" on page 205
USB ¹⁾³⁾	Displays connected USB flash drives	Enter	Opens the submenu See "USB" on page 205
Others ¹⁾⁴⁾	Displays CPU boards / baseboards for PXE booting with onboard Ethernet interfaces	Enter	Opens the submenu See "Other" on page 206

Table 142: US15W Boot - Legacy - Configuration options

- 1) These submenus are only shown if *Normal boot mode* is set to *Normal*.
- 2) Only shown if a CompactFlash card is connected.
- 3) Only shown if a USB flash drive is connected.
- 4) Only shown if *PXE boot to LAN* is set to *Enabled* in the boot menu.

1.8.1.1 Boot type order

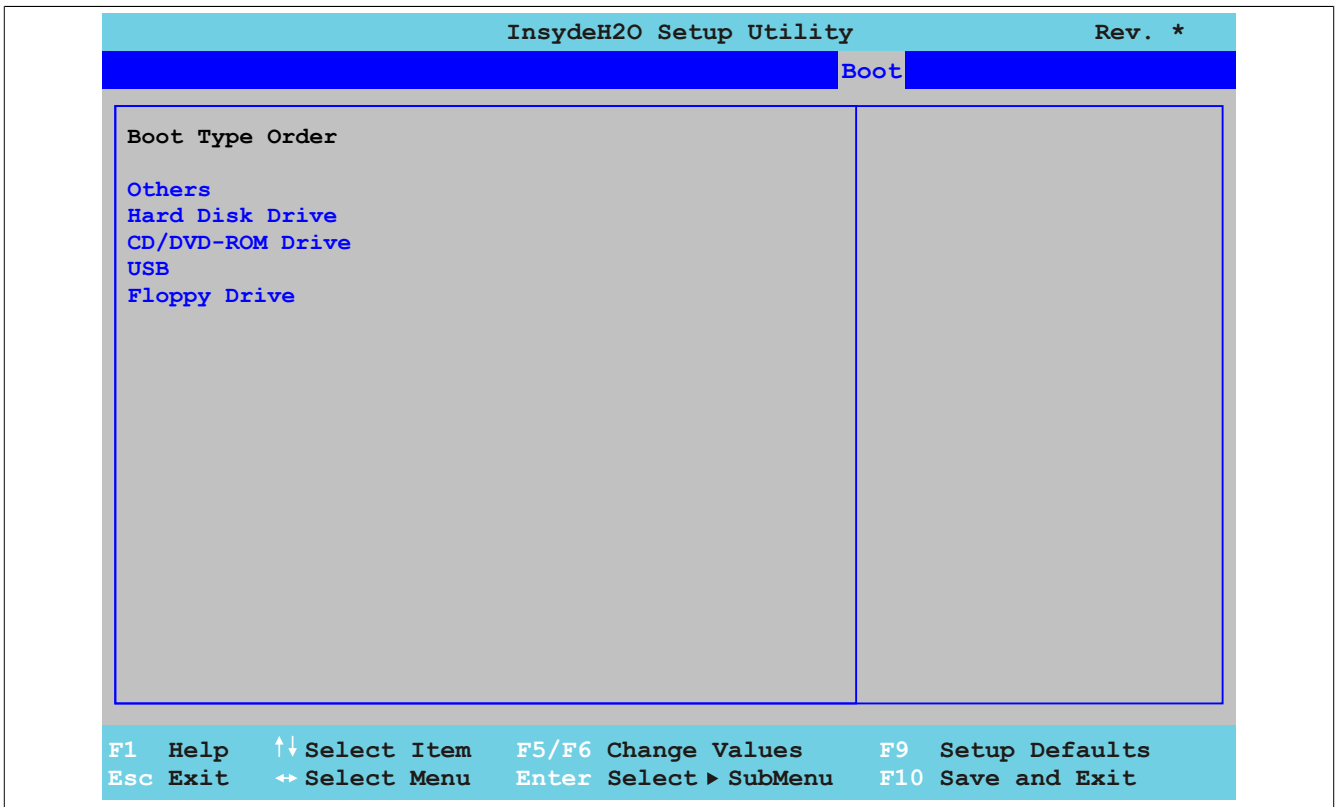

Figure 127: US15W Boot - Legacy - Boot Type Order

BIOS setting	Function	Configuration options	Effect
Others	Option for selecting drives to be used for booting	Others	Specifies the desired boot sequence
Hard disk drive		Hard disk drive	
CD/DVD ROM drive		CD/DVD ROM drive	
USB		USB	
Floppy drive		Floppy drive	

Table 143: US15W Boot - Legacy - Boot type order - Configuration options

1.8.1.2 Hard disk drive

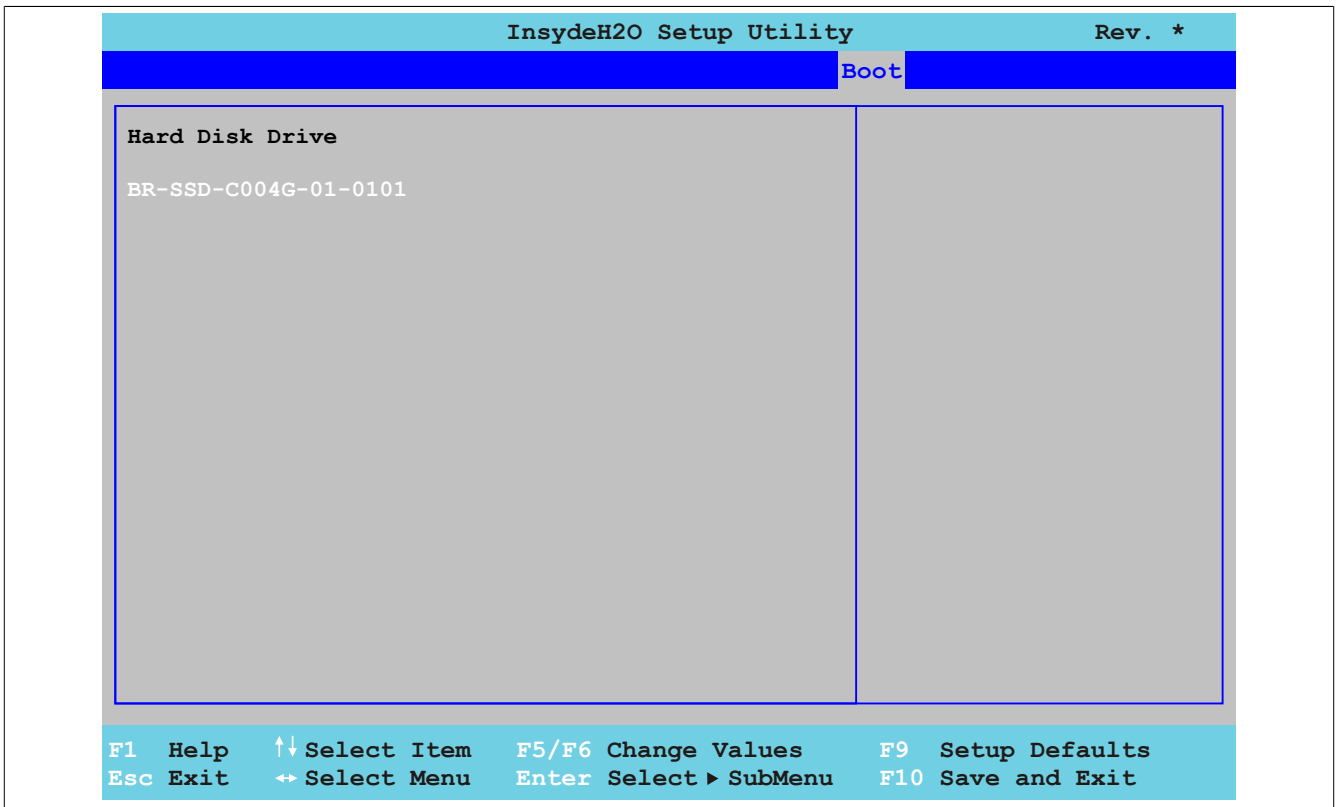

Figure 128: US15W Boot - Legacy - Hard Disk Drive

BIOS setting	Function	Configuration options	Effect
	Displays inserted CompactFlash cards	None	-

Table 144: US15W Boot - Legacy - Hard disk drive - Configuration options

1.8.1.3 USB

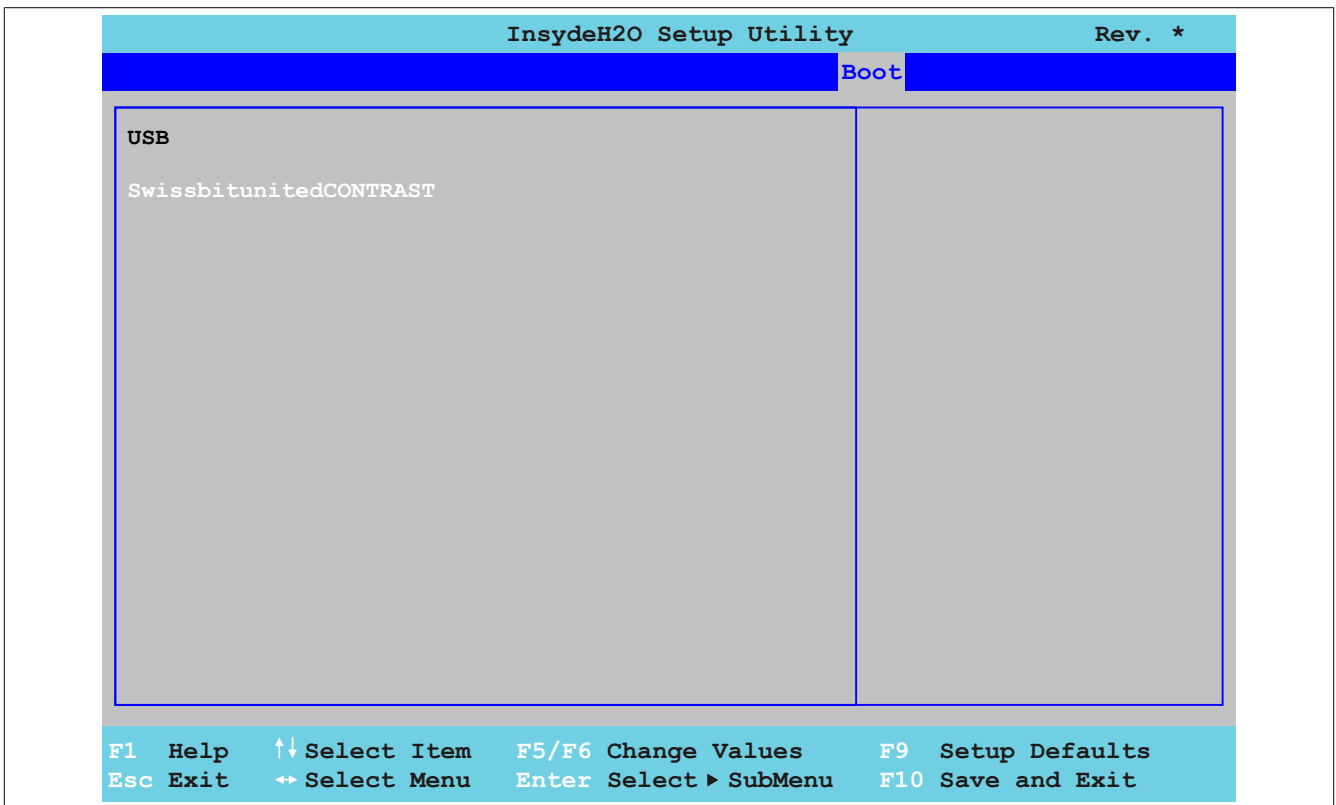

Figure 129: US15W Boot - Legacy - USB

BIOS setting	Function	Configuration options	Effect
-	Displays connected USB flash drives	None	-

Table 145: US15W Boot - Legacy - USB - Configuration options

1.8.1.4 Other

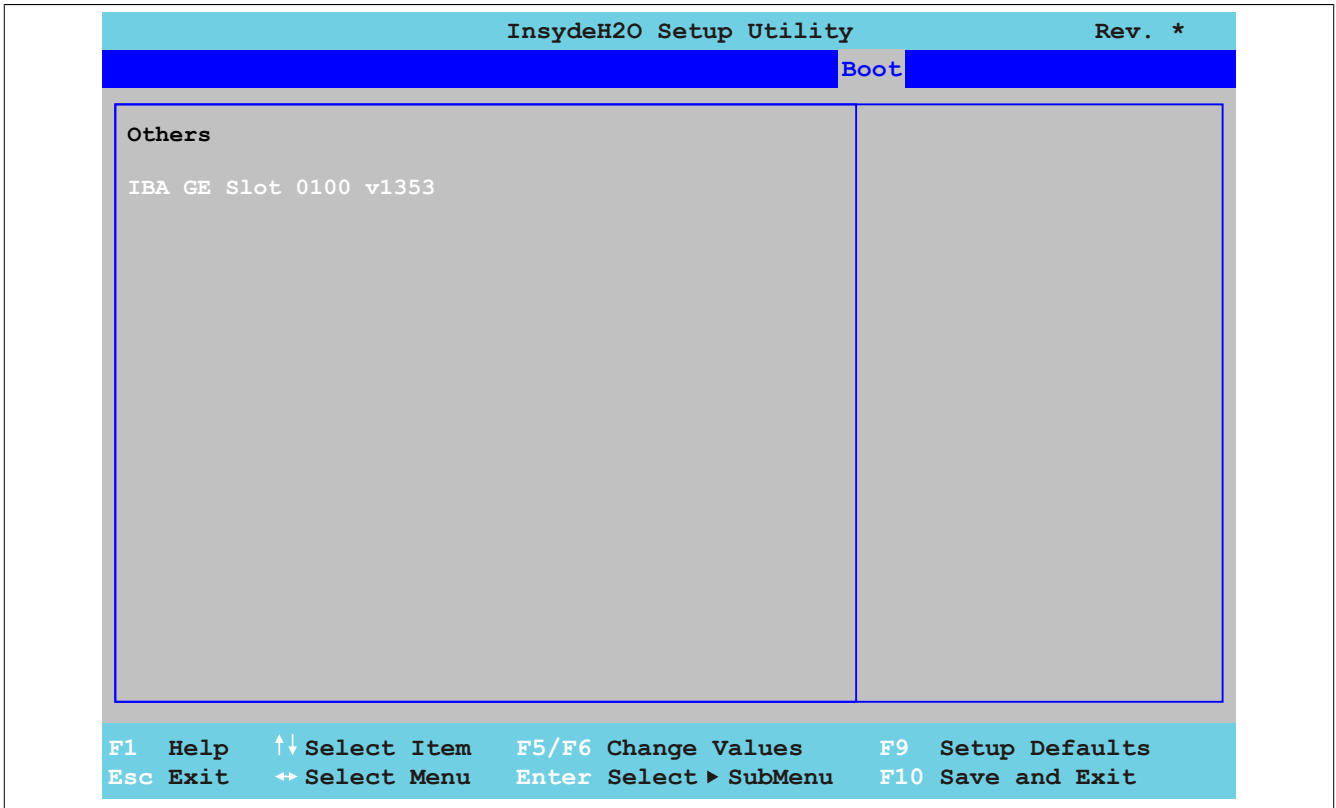

Figure 130: US15W Boot - Legacy - Others

BIOS setting	Function	Configuration options	Effect
-	Displays CPU boards / baseboards for PXE booting with onboard Ethernet interfaces	None	-

Table 146: US15W Boot - Legacy - Others - Configuration options

1.9 Exit

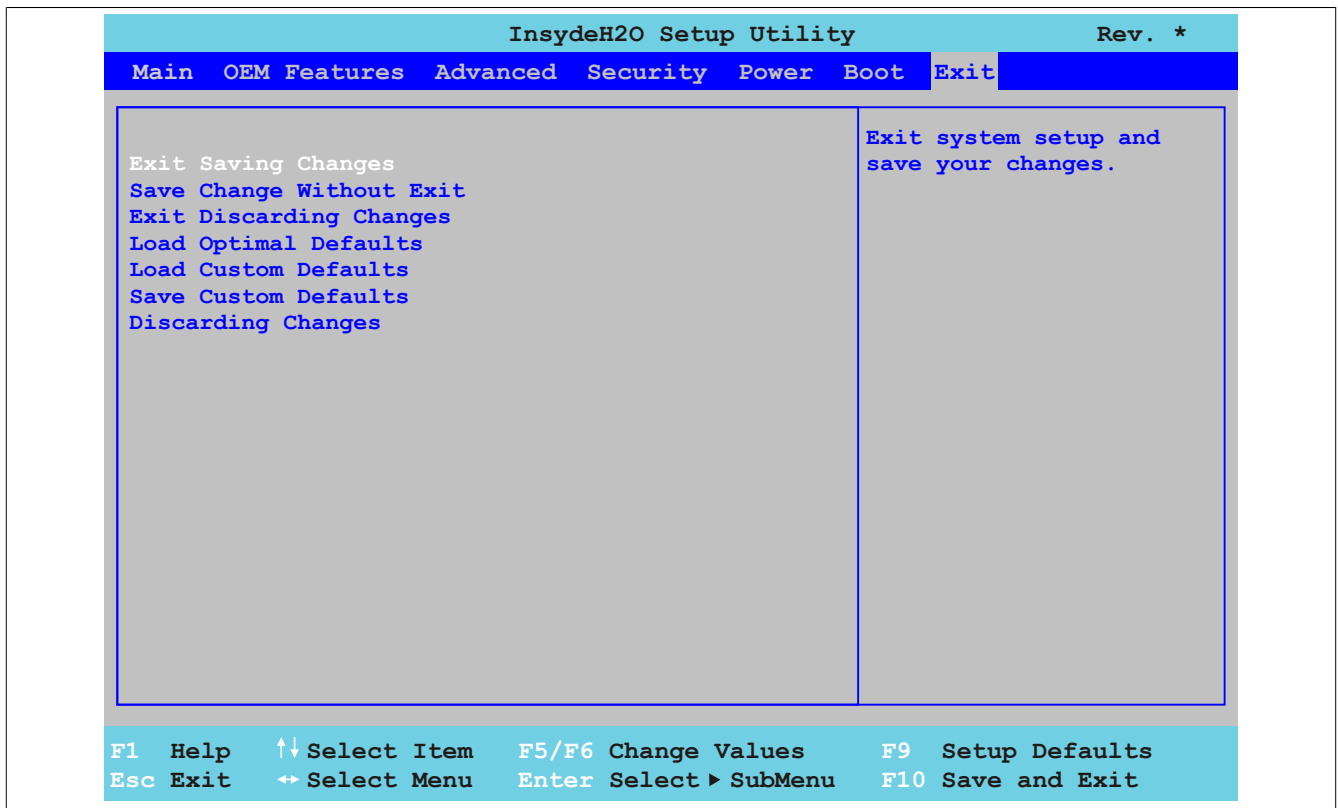

Figure 131: US15W Exit - Menü

BIOS setting	Function	Configuration options	Effect
Exit saving changes	Selecting this option closes BIOS Setup. Any changes made are saved to CMOS after confirmation, and the system is rebooted.	OK / Cancel	
Save change without exit	Selecting and confirming this option saves any changes made to CMOS.	OK / Cancel	
Exit discarding changes	Selecting this option closes BIOS Setup without saving any changes made. The system is then rebooted.	OK / Cancel	
Load optimal defaults	This option loads the CMOS default values defined by the mode/node switches. These values are loaded for all BIOS settings.	OK / Cancel	
Load custom defaults	This option loads the CMOS values defined by the mode/node switches. These values are loaded for all BIOS settings.	OK / Cancel	
Save custom defaults	This saves defined CMOS vales. These settings are saved for all BIOS configurations.	OK / Cancel	
Discarding changes	In the event that settings were made that the user can no longer remember, they can be reset as long as they have not yet been saved.	OK / Cancel	

Table 147: US15W Exit menu - Configuration options

1.10 BIOS default settings

If the "Load optimal defaults" function is selected in the main BIOS Setup screen, or if "Exit" is selected (or <F9> is pressed) in the individual setup screens, the following BIOS settings are the optimized values that will be used.

1.10.1 Main

Setting/Option	Profile 0	My setting
InsydeH2O version	-	
Processor type	-	
System bus speed	-	
System memory speed	-	
Cache RAM	-	
Total memory	-	
SODIMM 0	-	
System time	-	
System date	-	

Table 148: US15W - Main - Overview of profile settings

1.10.2 OEM features

Setting/Option	Profile 0	My setting
BIOS	-	
Boot source	-	
MTCX	-	

Table 149: US15W - OEM features - Overview of profile settings

1.10.2.1 CPU board features

Setting/Option	Profile 0	My setting
Device ID	-	
Compatibility ID	-	
Vendor ID	-	
Hardware revision	-	
Serial number	-	
Product name	-	
Hardware number	-	
Parent device ID	-	
Parent compatib. ID	-	
User serial ID	-	
LAN1 MAC ADDRESS	-	
LPC devices		
COMA	-	
Base I/O address	3F8	
Interrupt	IRQ4	
Statistical values		
Sensor 1	-	
Sensor 2	-	
Sensor 3	-	
Total hours	-	
Power on cycles	-	
Temperature values		
Refresh values	-	
Sensor 1	-	
Sensor 2	-	
Sensor 3	-	
Temperature values		
Wcpu	-	
Vin	-	
Battery voltage	-	
Battery state	-	

Table 150: US15W - CPU board features - Overview of profile settings

1.10.2.2 System unit features

Setting/Option	Profile 0	My setting
Device ID	-	
Compatibility ID	-	
Vendor ID	-	
Hardware revision	-	
Serial number	-	
Product name	-	
Hardware number	-	
Parent device ID	-	
Parent compatib. ID	-	
User serial ID	-	
Display (0) brightness	Auto	
LPC devices		
COMB	-	
Base I/O address	2F8	
Interrupt	IRQ3	
Statistical values		
Sensor 1	-	
Total hours	-	
Power on cycles	-	
Temperature values		
Refresh values	-	
Sensor 1	-	

Table 151: US15W - System unit features - Overview of profile settings

1.10.2.3 I/O board features

Setting/Option	Profile 0	My setting
FPGA version	-	
Device ID	-	
Compatibility ID	-	
Vendor ID	-	
Hardware revision	-	
Serial number	-	
Product name	-	
Hardware number	-	
Parent device ID	-	
Parent compatib. ID	-	
User serial ID	-	
I/O board LPC devices		
COMC	-	
Base I/O address	3E8	
Interrupt	IRQ11	
COMD	-	
Base I/O address	2E8	
Interrupt	IRQ10	
Statistical values		
Sensor 1	-	
Total hours	-	
Power on cycles	-	
Refresh values		
Sensor 1	-	
Panel control		
Select panel number	1	
Version	-	
Brightness	100%	
Fan speed	-	
Keys/LEDs	-	
Temperature	-	

Table 152: US15W - I/O board features - Overview of profile settings

1.10.2.4 IF board features

Setting/Option	Profile 0	My setting
Device ID	-	
Compatibility ID	-	
Vendor ID	-	
Hardware revision	-	
Serial number	-	

Table 153: US15W - IF board features - Overview of profile settings

Setting/Option	Profile 0	My setting
Product name	-	
Hardware number	-	
Parent device ID	-	
Parent compatib. ID	-	
User serial ID	-	
LAN2 MAC ADDRESS	-	
Statistical values		
Total hours	-	
Power on cycles	-	

Table 153: US15W - IF board features - Overview of profile settings

1.10.2.5 Memory module features

Setting/Option	Profile 0	My setting
Device ID	-	
Compatibility ID	-	
Vendor ID	-	
Hardware revision	-	
Serial number	-	
Product name	-	
Hardware number	-	
Parent device ID	-	
Parent compatib. ID	-	
User serial ID	-	

Table 154: US15W - Memory module features - Overview of profile settings

1.10.3 Advanced

1.10.3.1 RAM configuration

Setting/Option	Profile 0	My setting
Refresh rate	Auto	

Table 155: US15W - RAM configuration - Overview of profile settings

1.10.3.2 Boot configuration

Setting/Option	Profile 0	My setting
NumLock	On	

Table 156: US15W - Boot configuration - Overview of profile settings

1.10.3.3 Peripheral configuration

Setting/Option	Profile 0	My setting
High definition audio ¹⁾	Auto	

Table 157: US15W - Peripheral configuration - Overview of profile settings

1) This menu option is only available if there is an audio connection.

1.10.3.4 IDE configuration

Setting/Option	Profile 0	My setting
Channel 1 master	Enabled ¹⁾	
Channel 1 master		
Transfer mode	-	
Security mode	-	
Channel 1 slave	Enabled ¹⁾	
Channel 1 slave		
Transfer mode	-	
Security mode	-	

Table 158: US15W - IDE configuration - Overview of profile settings

1) Only with drive installed.

1.10.3.5 Video configuration

Setting/Option	Profile 0	My setting
IGD - Pre-allocated memory	UMA = 8 MB	
IGD - Boot type	Auto	
IGD - LCD panel type ¹⁾	640x480 (5.7) LVDS	
Remote Panel	Disabled ²⁾	

Table 159: US15W - Video configuration - Overview of profile settings

- 1) This setting is only available for PP500 system units.
- 2) This option is enabled by default on APC511 system units without an I/O board.

1.10.3.6 USB configuration

Setting/Option	Profile 0	My setting
USB Legacy	Enabled	
EHCI	Enabled	
UHCI 1	Enabled	
UHCI 2	If an I/O board is not connected: Disabled If an I/O board is connected: Enabled	
UHCI 3	Enabled	
USB client	Disabled	

Table 160: US15W - USB configuration - Overview of profile settings

1.10.3.7 SDIO configuration

Setting/Option	Profile 0	My setting
SDIO port 1	Enabled	
SDIO port 2	Enabled	

Table 161: US15W - SDIO configuration - Overview of profile settings

1.10.3.8 ACPI table/features control

Setting/Option	Profile 0	My setting
FACP - C2 latency value	Disabled	
FACP - C3 latency value	Disabled	
HPET - HPET support	Enabled	
APIC - I/O APIC mode	Enabled	

Table 162: US15W - ACPI table/features control - Overview of profile settings

1.10.3.9 PCI Express root port 1

Setting/Option	Profile 0	My setting
PCI Express root port 1	Enabled	
Interrupt pin 0	Auto	
VC1 enable	Disabled	
VC1/TC mapping	Disabled	
ASPM	Disabled	
Automatic ASPM	Disabled	
ASPM L0s	Disabled	
ASPM L1s	Disabled	
URR	Disabled	
FER	Disabled	
NFER	Disabled	
CER	Disabled	
CT0	Disabled	
SEFE	Disabled	
SENF	Disabled	
SECE	Disabled	
PME interrupt	Disabled	
PME SCI	Disabled	
Hot plug SCI	Disabled	

Table 163: US15W - PCI Express root port 1 - Overview of profile settings

1.10.3.10 PCI Express root port 2

Setting/Option	Profile 0	My setting
PCI Express root port 2	Enabled	
Interrupt pin 1	If a fieldbus card is not connected: Auto If a fieldbus card is connected: Disabled	
VC1 enable	Disabled	
VC1/TC mapping	Disabled	
ASPM	Disabled	
Automatic ASPM	Disabled	
ASPM L0s	Disabled	
ASPM L1s	Disabled	
URR	Disabled	
FER	Disabled	
NFER	Disabled	
CER	Disabled	
CT0	Disabled	
SEFE	Disabled	
SENF	Disabled	
SECE	Disabled	
PME interrupt	Disabled	
PME SCI	Disabled	
Hot plug SCI	Disabled	

Table 164: US15W - PCI Express root port 2 - Overview of profile settings

1.10.3.11 Console redirection

Setting/Option	Profile 0	My setting
Console serial redirect	Enabled	
Information wait time	5 seconds	
Serial port	COM_A	
Terminal type	PC_ANSI	
Baud rate	57600	
Data bits	8 bits	
Parity	None	
Stop bits	1-bit	
Flow control	None	
ACPI SPCR table	Disabled	

Table 165: US15W - Console redirection - Overview of profile settings

1.10.4 Power

Setting/Option	Profile 0	My setting
Power loss control	Read from EEPROM data	
ACPI S3	Disabled	

Table 166: US15W Power - Overview of profile settings

1.10.4.1 Advanced CPU control

Setting/Option	Profile 0	My setting
P-States(IST)	Enabled	
CMP support	Enabled	
Thermal mode	TM1 and TM2	
Use XD capability	Enabled	
VT support	Enabled	
SMRR support	Enabled	
C-States	Disabled	
Enhanced C-States	Disabled	
C-States pop up mode	Disabled	
C-States pop down mode	Disabled	
Hard C4E	Disabled	
Enable C6	Disabled	
DTS	Enabled	
Thermal trip points setting		
Throttle on temperature	100°C	

Table 167: US15W - Advanced CPU control - Overview of profile settings

1.10.4.2 Platform power management

Setting/Option	Profile 0	My setting
PCI clock run	Disabled	
_CST - C4 latency value	Disabled	
C4 on C3 - Deeper sleep	Disabled	

Table 168: US15W - Platform power management - Overview of profile settings

1.10.5 Boot

Setting/Option	Profile 0	My setting
Quick boot	Enabled	
Quiet boot	Enabled	
Delay for logo & summary	Default	
USB boot	Enabled	
SD card boot	Disabled	
PXE boot to LAN	Disabled	
ACPI selection	Acpi3.0	

Table 169: US15W Boot - Overview of profile settings

1.11 Allocation of resources

1.11.1 RAM address assignment

RAM address	Address in hexadecimal	Resource
(TOM - FB ¹⁾) – TOM ²⁾	N.A.	ACPI reclaim, MPS and NVS area ³⁾
(TOM - FB - TSEG ⁴⁾) – (TOM - FB)	N.A.	VGA frame buffer ⁵⁾
1024 kB – (TOM - 8 MB - 192 kB)	100000h - N.A.	Extended memory
896 kB – 1024 kB	0E0000h - 0FFFFFFh	Runtime BIOS
832 kB – 896 kB	0D0000h - 0DFFFFh	Upper memory
640 kB – 832 kB	0A0000h - 0CFFFFh	Video memory and BIOS
639 kB – 640 kB	09FC00h - 09FFFFh	Extended BIOS data
0 – 639 kB	000000h - 09FC00h	Conventional memory

Table 170: RAM address assignment

- 1) FB - VGA frame buffer.
- 2) TOM = Top of memory: max. installed DRAM.
- 3) Only if ACPI Aware OS is set to "YES" in the setup.
- 4) TSEG - Intended internally by BIOS for SMI handling.
- 5) The VGA frame buffer can be reduced to 1 MB in the setup.

1.11.2 I/O address assignment

I/O address	Resource
0000h - 00FFh	Motherboard resources
01F0h - 01F7h	Primary IDE channel
03B0h - 03DFh	Video system
03F6h - 03F6h	Primary IDE channel command port
03F7h - 03F7h	Primary IDE channel status port
03F8h - 03FFh	COM1
0480h - 04BFh	Motherboard resources
04D0h - 04D1h	Motherboard resources
0800h - 087Fh	Motherboard resources
0CF8h - 0CFBh	PCI config address register
0CFCh - 0CFFh	PCI config data register
0D00h - FFFFh	PCI / PCI Express bus ¹⁾
4100h - 417Fh	MTCX
FF00h - FF07h	IDE bus master register

Table 171: I/O address assignment

- 1) The BIOS assigns the PCI and PCI Express bus I/O resources from FFF0h downward. Devices that are not compatible with PnP/PCI/PCI Express cannot use the I/O resources in this range.

1.11.3 Interrupt assignments in PIC mode

IRQ	0	1	2	3	4	5	6	7	8	9	10	11	12	13	14	15	NMI	NONE
System timer	•																	
Keyboard		•																
IRQ cascade			•															
COM1 (serial port A)				○	•	○	○				○	○	○					
COM2 (serial port B)				•	○	○	○				○	○	○					
ACPI ¹⁾										•								
Real-time clock									•									
Coprocessor (FPU)														•				
Primary IDE channel															•			
Secondary IDE channel																•		

Table 172: IRQ interrupt assignments in PIC mode

- 1) Advanced Configuration and Power Interface.

- ... Default setting
- ... Optional setting

1.11.4 Interrupt assignments in APIC mode

A total of 23 IRQs are available in APIC (Advanced Programmable Interrupt Controller) mode. Enabling this option is only effective if done before the operating system is installed.

IRQ	0	1	2	3	4	5	6	7	8	9	10	11	12	13	14	15	16	17	18	19	20	21	22	23	NMI	NONE
System timer	•																									
Keyboard		•																								
IRQ cascade			•																							
COM1 (serial port A)				○	•	○	○				○	○	○													
COM2 (serial port B)				•	○	○	○				○	○	○													
ACPI ¹⁾										•																
Real-time clock									•																	
Coprocessor (FPU)														•												
Primary IDE channel															•											
Secondary IDE channel																•										
PIRQ A ²⁾																	•									
PIRQ B ³⁾																		•								
PIRQ C ⁴⁾																			•							
PIRQ D ⁵⁾																				•						
PIRQ E ⁶⁾																					•					
PIRQ F ⁷⁾																						•				
PIRQ G ⁸⁾																							•			
PIRQ H ⁹⁾																								•		

Table 173: IRQ interrupt assignments in APIC mode

- 1) Advanced Configuration and Power Interface.
- 2) PIRQ A: for IF board; GMA500 graphics controller, LPC, root port 1, Ethernet controller, USB client
- 3) PIRQ B: for IF board; root port 2
- 4) PIRQ C: for IF board
- 5) PIRQ D: for IF board; HD audio
- 6) PIRQ E: UHCI host controller 0, SDIO 0 controller
- 7) PIRQ F: UHCI host controller 1, SDIO 1 controller
- 8) PIRQ G: UHCI host controller 2, SDIO 2 controller
- 9) PIRQ H: EHCI host controller

- ... Default setting
- ... Optional setting

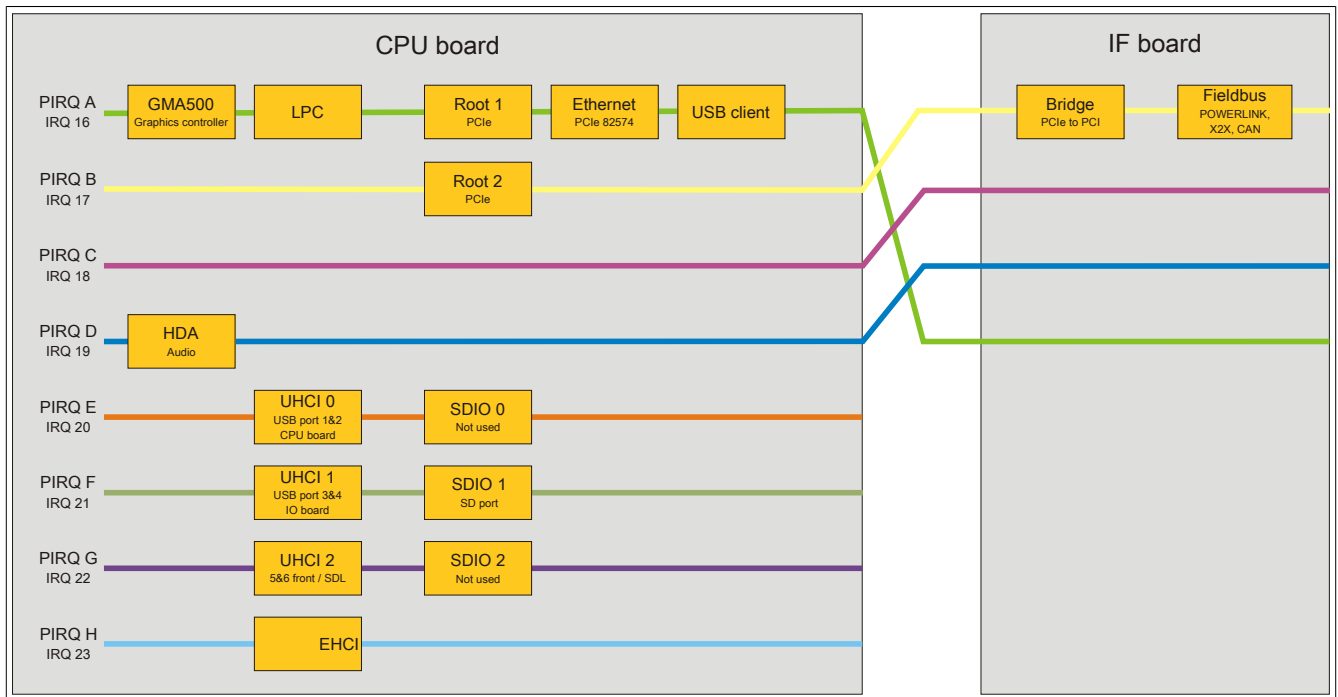

Figure 132: Interrupt routing with enabled APIC - Beginning with BIOS version N0.15

2 Upgrade information

Warning!

The BIOS and firmware on B&R devices must be kept current. New versions can be downloaded from the B&R website (www.br-automation.com).

2.1 BIOS upgrade

An upgrade may be necessary in order to accomplish the following:

- Updating implemented functions or adding newly implemented functions or components to BIOS Setup (information about changes can be found in the Readme file for the BIOS upgrade).

2.1.1 Important information

Information:

Customized BIOS settings are deleted when upgrading BIOS.

Before starting an upgrade, it helps to determine the various software versions.

2.1.1.1 Which BIOS version and firmware are already installed on the device?

This information can be found on the following BIOS Setup screen:

- After switching on the device, BIOS Setup can be accessed by pressing <F2>.
- The current BIOS and MTCX version can be viewed in BIOS under "OEM features".

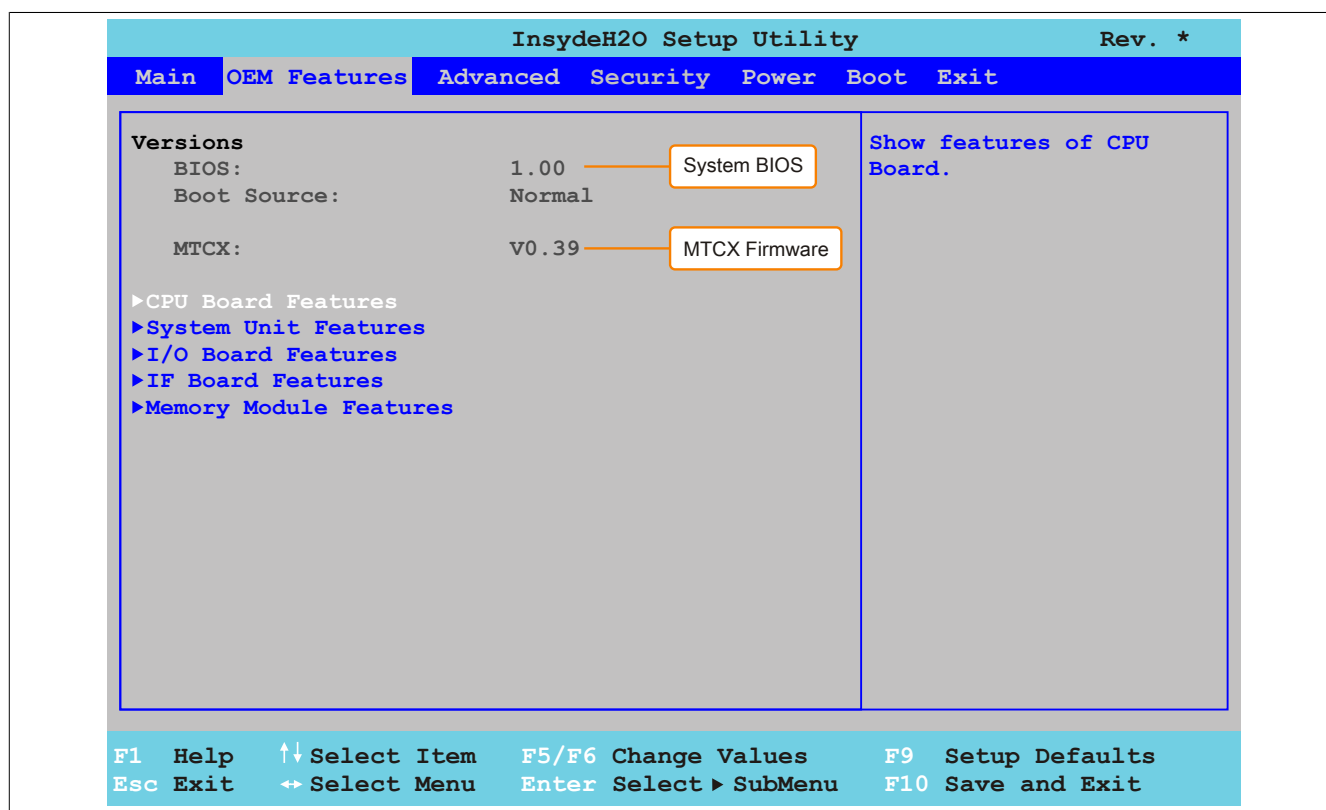

Figure 133: BIOS und MTCX Softwareversionen

Information about BIOS and firmware versions can also be found in the Control Center (Start menu / Control Panel / Control Center / Versions).

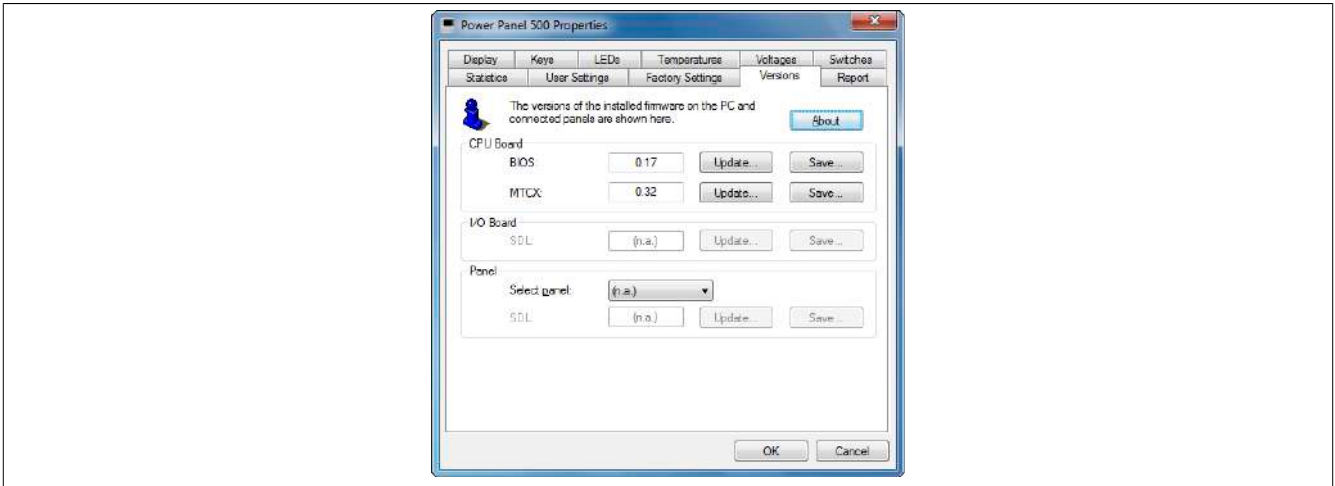

Figure 134: BIOS and MTCX software versions - Control Center

2.1.2 Using the Control Center

1. Download the .zip file from the B&R website (www.br-automation.com).
2. Open the **Control Center** in the Control Panel.
3. Select the **Versions** tab.
4. Under **CPU board**, click on **Update** for **BIOS**. This brings up the "Open" dialog box.
5. Enter the name of the BIOS file or select the file under **Filename**.
6. Click on **Open**. This brings up the "Open" dialog box.

The transfer can be canceled by clicking on **Cancel**. "Cancel" is disabled when writing to flash memory.

Deleting the data in flash memory can take several seconds depending on the memory block being used. The progress indicator is not updated during this time.

Information:

The system must be restarted for the BIOS settings to take effect and for the updated version to be displayed. The user is prompted to restart the system when closing the Control Center.

Information:

For more information about saving and updating BIOS, please refer to the help documentation for the Control Center.

2.2 Firmware upgrade

The latest firmware upgrade is available in the Downloads section of the B&R website (www.br-automation.com).

2.2.1 Procedure

1. Download the .zip file from the B&R website (www.br-automation.com).
2. Open the **Control Center** in the Control Panel.
3. Select the **Versions** tab.
4. Under **CPU board**, click **Update** for **MTCX** or **MTCX FPGA**. This brings up the "Open" dialog box.
5. Enter the name of the firmware file or select the file under **Filename**.
6. Click on **Open**. This brings up the "Open" dialog box.

The transfer can be canceled by clicking on **Cancel**. **Cancel** is disabled when writing to flash memory.

Warning!

Do not press any panel keys while the firmware is being transferred! This can disrupt the procedure.

Deleting the data in flash memory can take several seconds depending on the memory block being used. The progress indicator is not updated during this time.

Information:

Power to the PC must be shut off and turned back on for the new firmware to take effect and for the updated version to be displayed. The user is prompted to do this when closing the Control Center.

Information:

For more information about saving and updating firmware, please refer to the help documentation for the Control Center.

2.3 Upgrade problems

Potential upgrade problems are listed in the Readme.txt files on the upgrade disks.

3 Windows XP Professional

3.1 General information

Information:

Discontinuation of support for Windows XP by Microsoft:

After April 8th, 2014, Microsoft will no longer be providing any security updates, hotfixes, support (free or paid) or technical resources for Windows XP.

3.2 Order data

Model number	Short description	Figure
	Windows XP Professional	
5SWWXP.0600-GER	Windows XP Professional SP3 - German - CD	
5SWWXP.0600-ENG	Windows XP Professional SP3 - English - CD	
5SWWXP.0600-MUL	Windows XP Professional SP3 - Multilingual - CD	

Table 174: 5SWWXP.0600-GER, 5SWWXP.0600-ENG, 5SWWXP.0600-MUL - Order data

3.3 Overview

Model number	Edition	Target system	Chipset	Service pack	Language	Minimum hard disk space required	Minimum RAM required
5SWWXP.0600-GER	Professional	APC510 APC511 APC620 APC810 APC820 APC910 PPC700 PPC725 PPC800 PPC900 PP500	945GME GM45 QM77/HM76 NM10 US15W	SP3	German	≤2.1 GB	128 MB
5SWWXP.0600-ENG	Professional	APC510 APC511 APC620 APC810 APC820 APC910 PPC700 PPC725 PPC800 PPC900 PP500	945GME GM45 QM77/HM76 NM10 US15W	SP3	English	≤2.1 GB	128 MB
5SWWXP.0600-MUL	Professional	APC510 APC511 APC620 APC810 APC820 APC910 PPC700 PPC725 PPC800 PPC900 PP500	945GME GM45 QM77/HM76 NM10 US15W	SP3	Multilingual	≤2.1 GB	128 MB

3.4 Installation

B&R preinstalls the required Windows XP Professional version on the desired storage device (e.g. CompactFlash card, etc.). All of the drivers required for operation (graphics, network, etc.) are also installed in this process.

3.5 Drivers

Current drivers for all approved operating systems are available in the Downloads section of the B&R website (www.br-automation.com).

Information:

Required drivers can only be downloaded from the B&R website, not from manufacturer websites.

3.6 Supported display resolutions

In accordance with Microsoft requirements, Windows XP Professional requires SVGA resolution (800 x 600) or higher in order to allow unimpeded operation of the Windows user interface (including system dialog boxes and apps, etc.). A lower resolution can be selected for applications.

4 Windows 7

4.1 General information

Windows® 7 offers a wealth of innovative features and performance improvements. Faster switching to power saving mode, quicker restores, less memory usage and high-speed detection of USB devices are just a few of the advantages provided by Windows® 7. Both English and German are available in Windows® 7 Professional, while Windows® 7 Ultimate supports up to 35 different languages (up to 36 languages in Service Pack 1). Product activation is not necessary on B&R PCs, which is a huge advantage for simple logistical procedures relating to machine automation.

All of the Windows® operating systems offered by B&R are from the Microsoft Embedded division. This guarantees much longer availability, especially compared to products offered on the consumer market.

4.2 Order data

Model number	Short description	Figure
	Windows 7 Professional/Ultimate	
5SWWI7.0100-GER	Windows 7 Professional - 32-bit - German - DVD	
5SWWI7.1100-GER	Windows 7 Professional SP1 - 32-bit - German - DVD	
5SWWI7.0100-ENG	Windows 7 Professional - 32-bit - English - DVD	
5SWWI7.1100-ENG	Windows 7 Professional SP1 - 32-bit - English - DVD	
5SWWI7.0300-MUL	Windows 7 Professional - 32-bit - Multilingual - DVD	
5SWWI7.1300-MUL	Windows 7 Ultimate SP1 - 32-bit - Multilingual - DVD	

Table 175: 5SWWI7.0100-GER, 5SWWI7.1100-GER, 5SWWI7.0100-ENG, 5SWWI7.1100-ENG, 5SWWI7.0300-MUL, 5SWWI7.1300-MUL - Order data

4.3 Overview

Model number	Edition	Target system	Chipset	Service pack	Architecture	Language	Minimum hard disk space required	Minimum RAM required
5SWWI7.0100-GER	Professional	APC510 APC511 APC810 APC910 PPC800 PP500	945GME GM45 QM77/HM76 US15W		32-bit	German	16 GB	1 GB
5SWWI7.1100-GER	Professional	APC510 APC511 APC810 APC910 APC2100 PPC800 PPC900 PPC2100 PP500	945GME GM45 QM77/HM76 NM10 US15W Bay Trail	SP1	32-bit	German	16 GB	1 GB
5SWWI7.0100-ENG	Professional	APC510 APC511 APC810 APC910 PPC800 PP500	945GME GM45 QM77/HM76 US15W		32-bit	English	16 GB	1 GB
5SWWI7.1100-ENG	Professional	APC510 APC511 APC810 APC910 APC2100 PPC800 PPC900 PPC2100 PP500	945GME GM45 QM77/HM76 NM10 US15W Bay Trail	SP1	32-bit	English	16 GB	1 GB
5SWWI7.0300-MUL	Ultimate	APC510 APC511 APC810 APC910 PPC800 PP500	945GME GM45 QM77/HM76 US15W		32-bit	Multilingual	16 GB ¹⁾	1 GB
5SWWI7.1300-MUL	Ultimate	APC510 APC511 APC810 APC910 APC2100 PPC800 PPC900 PPC2100 PP500	945GME GM45 QM77/HM76 NM10 US15W Bay Trail	SP1	32-bit	Multilingual	16 GB ¹⁾	1 GB

1) The memory used by additional language packs is not taken into account in the minimum size of the disk.

4.4 Installation

B&R preinstalls the required Windows 7 version on the desired storage device (e.g. CompactFlash card, etc.). All of the drivers required for operation (graphics, network, etc.) are also installed in this process.

4.5 Drivers

Current drivers for all approved operating systems are available in the Downloads section of the B&R website (www.br-automation.com).

Information:

Required drivers can only be downloaded from the B&R website, not from manufacturer websites.

4.6 Special considerations, limitations

- Windows 7 does not contain a Beep.sys file, which means that an audible signal is not sounded when pressing a key, for example.
- There is currently no support for the Windows 7 system rating (although this does not apply to PP500, APC2100, APC510, APC511, APC910, PPC2100 or PPC800 devices with an NM10 chipset).

4.7 Supported display resolutions

In accordance with Microsoft requirements, Windows 7 requires XGA resolution (1024 x 768) or higher in order to allow unimpeded operation of the Windows user interface (including system dialog boxes, etc.). A lower resolution can be selected for applications.

5 Windows Embedded Standard 2009

5.1 General information

Windows® Embedded Standard 2009 is the modular version of Windows® XP Professional. It is used if XP applications should be executed with a minimal operating system size. Together with CompactFlash memory, Windows® Embedded Standard 2009 makes it possible to use the Microsoft desktop operating system in harsh environmental conditions. In addition to the familiar features included in Windows® XP Professional, Windows® Embedded Standard 2009 has been improved with regard to dependability by adding a write filter for individual memory partitions. By protecting individual partitions such as the boot partition, the PC system can be started without problems even after an unexpected power failure. B&R offers complete images for industrial PCs, Power Panel and Mobile Panel devices to make the transition to Windows® Embedded Standard 2009 as easy as possible. In addition to Windows® Embedded Standard 2009, the standard Windows® XP Professional operating system is also available in English, German and a multilingual version.

Windows® Embedded Standard 2009 is based on the same binary files as Windows® XP Professional with Service Pack 3 and is optimally tailored to the hardware being used. In other words, only the functions and modules required by the respective device are included. Windows® Embedded Standard 2009 is also based on the same reliable code as Windows® XP Professional with SP3. It provides industry with leading reliability, security and performance improvements as well as the latest technology for web browsing and extensive device support.

5.2 Order data

Model number	Short description	Figure
	Windows Embedded Standard 2009	
5SWWXP.0736-ENG	Microsoft OEM Windows Embedded Standard 2009, English; for PP500; order CompactFlash separately (at least 1 GB).	

Table 176: 5SWWXP.0736-ENG - Order data

5.3 Overview

Model number	Target system	Chipset	Language	Minimum disk size	Minimum RAM required
5SWWXP.0736-ENG	PP500	US15W	English	1 GB	256 MB

5.4 Features with WES2009 (Windows Embedded Standard 2009)

The following list of features shows the most important device functions included in Windows Embedded Standard 2009.

Function	Included?
Enhanced Write Filter (EWF)	✓
File-Based Write Filter (FBWF)	✓
Page file	Configurable
Administrator accounts	✓
User accounts	Configurable
Explorer shell	✓
Registry filter	✓
Internet Explorer 8.0	✓
Internet Information Service (IIS)	-
Terminal service	✓
Windows Firewall	✓
MSN Explorer	-
Outlook Express	-
Administrative Tools	✓
Remote Desktop	✓
Remote Assistance	-
.NET Framework	-
ASP.NET	-
OpenGL support	✓
Local network bridge	✓
Codepages / User locales / Keyboards	✓
Disk Management Service	✓
Windows Installer Service	✓
Class Installer	✓
CoDevice Installer	✓

Table 177: Device functions in Windows Embedded Standard 2009

Function	Included?
Media Player 64	✓
DirectX 9.0c	✓
Accessories	✓
Number of fonts	89

Table 177: Device functions in Windows Embedded Standard 2009

5.5 Installation

Windows Embedded Standard 2009 is already preinstalled on a suitable CompactFlash card by B&R (minimum 1 GB). The system is then automatically configured when it is switched on for the first time. This procedure takes approximately 10 minutes, with the device being rebooted a number of times.

5.6 Drivers

All drivers required for operation are preinstalled along with the operating system. If an older version of a driver is still being used, its latest version can be downloaded and installed from the B&R website (www.br-automation.com). It is important that Enhanced Write Filter (EWF) is disabled for this.

5.6.1 Touch screen driver

The touch screen driver is installed automatically during Windows Embedded Standard 2009 setup. If an Automation Panel 800/900 is connected later on, the additional touch screen interface needs to be selected in the touch screen settings in the Windows Control Panel. It is important that both the Enhanced Write Filter (EWF) and the File Based Write Filter (FBWF) are disabled for this.

Information:

Required drivers can only be downloaded from the B&R website, not from manufacturer websites.

5.7 Supported display resolutions

In accordance with Microsoft requirements, Windows Embedded Standard 2009 requires SVGA resolution (800 x 600) or higher in order to allow unimpeded operation of the Windows user interface (including system dialog boxes, etc.). A lower resolution can be selected for applications.

6 Windows Embedded Standard 7

6.1 General information

The successor to Windows® XP Embedded is Windows® Embedded Standard 7. As with previous versions, this embedded operating system offers full system support for B&R Industrial PCs. In addition to brand new features that are also included in Windows® 7 Professional, Windows® Embedded Standard 7 includes embedded components such as Enhanced Write Filter, File-Based Write Filter, Registry Filter and USB Boot. Windows® Embedded Standard 7 is available in two different versions. The main difference between them has to do with multilingual support. Windows® Embedded Standard 7 is only available in a single language, whereas Windows® Embedded Standard 7 Premium supports the installation of several languages simultaneously.

With Windows® Embedded Standard 7, Microsoft has made substantial improvements in the area of security. The AppLocker program, available in the premium version, can prevent the execution of unknown or potentially undesired applications that are being installed over a network or from drives that are directly connected. A tiered approach allows the differentiation between scripts (.ps1, .bat, .cmd, .vbs and .js), installation files (.msi, .msp) and libraries (.dll, .ocx). AppLocker can also be configured to record undesired activity and display it in the Event Viewer. Windows® Embedded Standard 7 is available as both a 32-bit and 64-bit version⁴⁾, which ensures that even the most demanding applications have the level of support they need.

6.2 Order data

Model number	Short description	Figure
	Windows Embedded Standard 7	
5SWWI7.0536-ENG	Microsoft OEM Windows Embedded Standard 7 32-bit, English; for PP500; please order CompactFlash separately (minimum 8 GB).	
5SWWI7.1536-ENG	Microsoft OEM Windows Embedded Standard 7 32-bit, Service Pack 1, English; for PP500; order CompactFlash separately (at least 16 GB).	
5SWWI7.0736-MUL	Microsoft OEM Windows Embedded Standard 7 Premium 32-bit, multilanguage; for PP500; please order CompactFlash separately (minimum 8 GB).	
5SWWI7.1736-MUL	Microsoft OEM Windows Embedded Standard 7 Premium 32-bit, Service Pack 1, multilingual; for PP500; order CompactFlash separately (at least 16 GB).	
	Required accessories	
	CompactFlash cards	
5CFCRD.016G-06	CompactFlash 16 GB B&R (SLC)	
5CFCRD.032G-06	CompactFlash 32 GB B&R (SLC)	
5CFCRD.8192-06	CompactFlash 8 GB B&R (SLC)	
	Optional accessories	
	Windows Embedded Standard 7	
5SWWI7.0900-MUL	Windows Embedded Standard 7 - 32-bit - Language Pack - DVD	
5SWWI7.1900-MUL	Windows Embedded Standard 7 SP1 - 32-bit - Language Pack DVD	

Table 178: 5SWWI7.0536-ENG, 5SWWI7.1536-ENG, 5SWWI7.0736-MUL, 5SWWI7.1736-MUL - Order data

6.3 Overview

Model number	Edition	Target system	Chipset	Service pack	Architecture	Language	Minimum disk size	Minimum RAM required
5SWWI7.0536-ENG	Embedded	PP500	US15W		32-bit	English	8 GB	1 GB
5SWWI7.1536-ENG	Embedded	PP500	US15W	SP1	32-bit	English	16 GB	1 GB
5SWWI7.0736-MUL	Premium	PP500	US15W		32-bit	Multilingual	8 GB ¹⁾	1 GB
5SWWI7.1736-MUL	Premium	PP500	US15W	SP1	32-bit	Multilingual	16 GB ²⁾	1 GB

- 1) The memory space needed for additional language packs is not included in the minimum size specified for the data storage medium.
- 2) The memory used by additional language packs is not taken into account in the minimum size of the disk.

⁴⁾ 64-bit versions are not supported by all systems.

6.4 Features with WES7 (Windows Embedded Standard 7)

The feature list displays the essential device functions and differences in Windows Embedded Standard 7 and Windows Embedded Standard 7 Premium.

Function	Windows Embedded Standard 7	Windows Embedded Standard 7 Premium
Enhanced Write Filter (EWF)	✓	✓
File-Based Write Filter (FBWF)	✓	✓
Administrator accounts	✓	✓
User accounts	Configurable	Configurable
Windows Explorer shell	✓	✓
Registry filter	✓	✓
Internet Explorer 8.0	✓	✓
Internet Information Service (IIS) 7.0	✓	✓
Anti-malware (Windows Defender)	-	✓
Add-ons (Snipping Tool, Sticky Notes)	-	✓
Windows Firewall	✓	✓
.NET Framework 3.5	✓	✓
Remote Desktop Protocol 7.0	✓	✓
File Compression Utility	✓	✓
Windows Installer Service	✓	✓
Windows XP mode	-	-
Media Player 12	✓	✓
DirectX	✓	✓
Multilingual user interface packs in the same image	-	✓
International components and language services	✓	✓
Language pack setup	✓	✓
Windows update	Configurable	Configurable
Windows PowerShell 2.0	✓	✓
BitLocker	-	✓
AppLocker	-	✓
Tablet PC support	-	✓
Multitouch Support	-	✓
Boot from USB flash drive	✓	✓
Accessories	✓	✓
Page file	Configurable	Configurable
Number of fonts	134	134

Table 179: Device functions in Windows Embedded Standard 7

6.5 Installation

Windows Embedded Standard 7 wird schon im Hause B&R auf einer geeigneten CompactFlash-Karte (mind. 8 GByte bzw. 16 GByte) vorinstalliert. The system is then automatically configured when it is switched on for the first time. Dieser Vorgang nimmt ca. 30 Minuten in Anspruch und das Gerät wird dabei einige Male automatisch rebootet.

Information:

If Enhanced Write Filter (EWF) should be used, all mass storage devices should be disconnected from the system during installation or SYSPREP (except for the boot drive). It is also possible to disable additional mass storage devices in BIOS.

6.6 Drivers

All drivers required for operation are preinstalled along with the operating system. If an older version of a driver is still being used, its latest version can be downloaded and installed from the B&R website (www.br-automation.com). It is important that Enhanced Write Filter (EWF) is disabled for this.

6.6.1 Touch screen driver

A touch screen driver will be installed automatically if a touch controller is detected during the Windows Embedded Standard 7 installation. If a touch controller is not detected during Windows Embedded Standard 7 installation or a B&R Automation Panel is connected at a later time, then the touch screen driver needs to be installed manually or the additional touch screen interface must be selected in the touch screen settings in the Windows Control Panel. The driver is available in the Downloads section of the B&R website (www.br-automation.com). It is important that both Enhanced Write Filter (EWF) and File Based Write Filter (FBWF) are disabled for this.

Information:

Required drivers can only be downloaded from the B&R website, not from manufacturer websites.

6.7 Supported display resolutions

In accordance with Microsoft requirements, Windows Embedded Standard 7 requires XGA resolution (1024 x 768) or higher in order to allow unimpeded operation of the Windows user interface (including system dialog boxes and apps, etc.). A lower resolution can be selected for applications.

7 Windows CE

7.1 General information

B&R Windows CE is an operating system that is optimally tailored to B&R's devices, i.e. it includes only the functions and modules that are required by each device. This makes this operating system extremely robust and stable. A further advantage of B&R Windows CE compared to other operating systems are the low licensing costs.

7.2 Order data

Model number	Short description	Figure
5SWWCE.0836-ENG	Microsoft OEM Windows CE 6.0 Professional, English; for PP500; order CompactFlash separately (at least 128 MB).	
Required accessories		
CompactFlash cards		
5CFCRD.0128-03	CompactFlash 128 MB Western Digital (SLC)	
5CFCRD.016G-06	CompactFlash 16 GB B&R (SLC)	
5CFCRD.0256-03	CompactFlash 256 MB Western Digital (SLC)	
5CFCRD.0512-03	CompactFlash 512 MB Western Digital (SLC)	
5CFCRD.0512-06	CompactFlash 512 MB B&R (SLC)	
5CFCRD.1024-03	CompactFlash 1 GB Western Digital (SLC)	
5CFCRD.1024-06	CompactFlash 1 GB B&R (SLC)	
5CFCRD.2048-03	CompactFlash 2 GB Western Digital (SLC)	
5CFCRD.2048-06	CompactFlash 2 GB B&R (SLC)	
5CFCRD.4096-03	CompactFlash 4 GB Western Digital (SLC)	
5CFCRD.4096-06	CompactFlash 4 GB B&R (SLC)	
5CFCRD.8192-03	CompactFlash 8 GB Western Digital (SLC)	
5CFCRD.8192-06	CompactFlash 8 GB B&R (SLC)	

Table 180: 5SWWCE.0836-ENG - Order data

7.3 Overview

Model number	Target system	Chipset	Language	Minimum disk size	Minimum RAM required
5SWWCE.0836-ENG	PP500	US15W	English	128 MB	128 MB

7.4 Windows CE 6.0 features

Detailed information about Windows CE for B&R devices is available in the Downloads section of the B&R website (www.br-automation.com).

Features	Windows CE 6.0
Supported screen resolutions	WVGA (TFT), VGA (TFT), SVGA (TFT), XGA (TFT)
Chipset	Intel US15W
Color depth	16-bit or 65,536 colors ¹⁾
Graphics card driver	Intel(R) embedded graphics driver
Main memory	Automatic detection and use of up to 512 MB RAM
Boot time / Startup time	Approx. 25 seconds
Screen rotation	Not supported
Web browser	Internet Explorer
.NET	Compact Framework
Image size	Approx. 40 MB ²⁾ , uncompressed
Custom keys	Supported
PVI	Supported
Automation Device Interface	Supported
Remote Desktop Protocol for thin clients	Supported
B&R VNC Viewer	Supported
B&R Task Manager	Supported
B&R Picture Viewer	Supported
Compatible with zenOn	Yes
Compatible with Wonderware	No
Serial interfaces for any use	2
DirectX	No
Audio ports	"Line OUT" and "MIC" are supported. "Line IN" is not supported.

Table 181: Windows CE 6.0 features

- 1) The color depth depends on the display used.
- 2) The "Compress Windows CE image" function in the B&R Embedded OS Installer can be used to reduce the image size.

7.5 Requirements

The device must fulfill the following criteria to be able run the Windows CE operating system.

- At least 128 MB main memory
- At least one 128 MB CompactFlash card (size should be specified when ordered)

7.6 Installation

Windows CE is usually preinstalled at B&R.

7.7 B&R Embedded OS Installer

The B&R Embedded OS Installer makes it possible to install existing B&R Windows CE images. The 4 files NK.BIN, BLDR, LOGOXRES.BMP and LOGOQVGA.BMP must be available from an already functioning B&R Windows CE installation.

The B&R Embedded OS Installer is available in the Downloads section of the B&R website (www.br-automation.com). Additional information is available in the online help documentation for the B&R Embedded OS Installer.

8 Automation Runtime

8.1 General information

An integral component of Automation Studio is the Automation Runtime real-time operating system. This real-time operating system is the software kernel that allows applications to run on a target system.

- Guaranteed highest possible performance for the hardware being used
- Runs on all B&R target systems
- Makes the application hardware-independent
- Easy portability of applications between B&R target systems
- Deterministic behavior guaranteed by cyclic system
- Configurable jitter tolerance in all task classes
- Supports all major programming languages such as IEC 61131-3 and C
- Extensive function library conforming to IEC 61131-3 as well as the expanded B&R Automation library
- Integrated into Automation NET. Access to all networks and bus systems via function calls or the Automation Studio™ configuration

B&R Automation Runtime is fully embedded in the corresponding target system (the hardware where Automation Runtime is installed). It allows application programs to access I/O systems (e.g. via the fieldbus) and other devices (interfaces, networks, etc.).

8.2 Order data

Model number	Short description	Figure
	Technology Guard	
0TG1000.01	Technology Guard	
1TG4600.10-5	Automation Runtime Windows, TG license	
1TG4601.06-5	Automation Runtime Embedded, TG license	
1TG4601.06-T	Automation Runtime Embedded Terminal TG license	

Table 182: 0TG1000.01, 1TG4600.10-5, 1TG4601.06-5, 1TG4601.06-T - Order data

8.3 Automation Runtime Windows (ARwin)

System requirements

In order to run Automation Runtime Windows on a Power Panel 500, the following software versions (or higher) are required:

- ARwin upgrade AR A4.00
- Automation Studio V3.0.90
- Technology Guard

8.4 Automation Runtime Embedded (ARemb)

System requirements

In order to run Automation Runtime Embedded on a Power Panel 500, the following software versions (or higher) are required:

- ARemb upgrade AR A4.00
- Automation Studio V3.0.90
- Visual Components Runtime (VC) V3.95.2
- Technology Guard

Information:

Audio output in ARemb supported with AR 4.01 and higher.

8.5 Technology Guarding

Technology Guarding is a licensing approach used to safeguard individual software components. Licenses are stored on a "Technology Guard" (also referred to simply as a dongle), which is connected to an available USB interface on the target system.

The B&R software components Automation Runtime Embedded (ARemb), Automation Runtime Windows (ARwin) and Automation Runtime Embedded Terminal require a license, so a Technology Guard must always be used.

Information:

Licensing with the Technology Guarding wizard is available in Automation Studio 4.1 and Automation Runtime 4.08 and higher. Earlier versions of Automation Runtime do not require a Technology Guard.

Additional information about Technology Guarding can be found in the Automation Studio help system.

9 Debian (GNU/Linux)

9.1 General information

A Linux or GNU/Linux system is an open, Unix-like multiuser operating system based on the Linux kernel and GNU software. Widespread use and commercial applications were made possible starting in 1992 with the licensing of the Linux kernel under the GPL.

The Debian 6.0 operating system developed by B&R already contains all of the necessary drivers for the devices and can be used immediately without additional work.

Advantages of Debian:

- High degree of stability
- Wide selection of packages
- Suitable packages with real-time kernels already available

For more information about Debian, see <http://www.debian.org>.

9.2 Order data

Model number	Short description	Figure
	Debian 6.0	
5SWLIN.0136-MUL	Debian 6.0 - 32-bit - Multilingual - For PP500	

Table 183: 5SWLIN.0136-MUL - Order data

9.3 Overview

Model number	Target system	Chipset	Architecture	Language	Minimum disk size	Minimum RAM required
5SWLIN.0136-MUL	PP500	US15W	32-bit	Multilingual	4 GB	512 MB

9.4 Features

- Gnome desktop
- Touch drivers (for Power Panel 500 and Automation Panels with a resistive touch screen)
- MTCX driver
- ADI library
- HMI diagnostics tool
- Tool for right-click support via touch screen
- Tool for setting the display brightness
- Virtual keyboard
- Support for the following resolutions:

Display size	Display resolution
5.7"	VGA, 640 x 480
7"	WVGA, 800 x 480
10.4"	VGA, 640 x 480
12.1"	SVGA, 800 x 600
15"	XGA, 1024 x 768

Table 184: Debian-supported resolutions

Detailed information about Debian 6.0 for B&R devices is available in the Downloads area of the B&R website (www.br-automation.com).

9.5 Installation

B&R preinstalls Debian 6.0 on the desired storage device (e.g. CompactFlash card, etc.). All of the drivers required for operation (graphics, network, etc.) are also installed in this process.

Debian 6.0 can also be downloaded from the Debian website (<http://www.debian.org>) and installed separately. The Debian website provides more detailed instructions.

Notes regarding installation on B&R devices are included in a separate document that can be downloaded from the B&R website (www.br-automation.com).

Installation packages for the necessary B&R adjustments are also available on the B&R website (www.br-automation.com).

9.6 Drivers

All drivers required for operation are preinstalled along with the operating system.

The most current versions of B&R-specific drivers can be downloaded and installed from the B&R website (www.br-automation.com).

10 B&R Automation Device Interface (ADI) - Control Center

The ADI (Automation Device Interface) enables access to specific functions on B&R devices. Settings for devices can be read and configured using the B&R Control Center applet in the Control Panel.

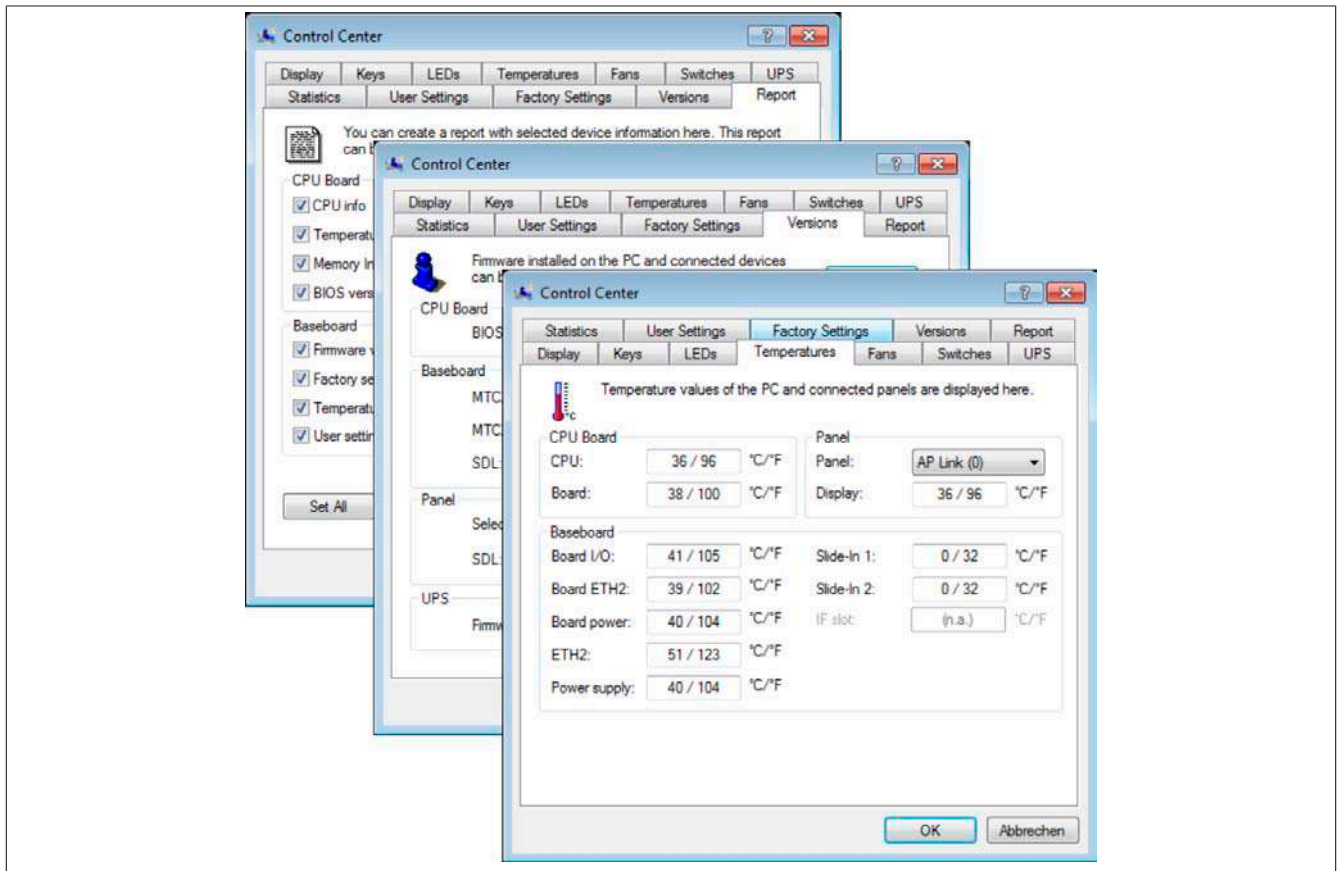

Figure 135: ADI Control Center screenshots - Examples

Information:

The temperature and voltage values (e.g. CPU temperature, core voltage, battery voltage) shown in the corresponding ADI window represent uncalibrated values for informational purposes. They cannot be used to draw any conclusions about hardware alarms or error conditions. The hardware components used have automatic diagnostic functions that can be applied in the event of error.

10.1 Functions

Information:

The functions provided by the Automation Device Interface (ADI) - Control Center vary according to the device series.

- Changing display-specific parameters
- Reading device-specific keys
- Updating the key configuration
- Enabling device-specific LEDs on a membrane keypad or keys
- Reading and calibrating control devices (e.g. key switches, handwheels, joysticks, potentiometers)
- Reading temperatures, fan speeds, statistical data and switch settings
- Reading operating hours (power-on hours)
- Reading user and factory settings
- Reading software versions
- Updating and backing up BIOS and firmware
- Creating reports about the current system (support assistance)
- Setting the SDL equalizer value when adjusting SDL cables
- Changing the user serial ID

Supports the following systems:

- Automation PC 510
- Automation PC 511
- Automation PC 620
- Automation PC 810
- Automation PC 820
- Automation PC 910
- Automation PC 2100
- Panel PC 300
- Panel PC 700
- Panel PC 725
- Panel PC 800
- Panel PC 900
- Panel PC 2100
- Power Panel 100/200
- Power Panel 300/400
- Power Panel 500
- Mobile Panel 40/50
- Mobile Panel 100/200
- Connected Automation Panel 800
- Connected Automation Panel 900
- Connected Automation Panel 1000

10.2 Installation

A detailed description of the Control Center can be found in the integrated help system. The B&R Automation Device Interface (ADI) driver (also includes the Control Center) is available at no charge in the Downloads section of the B&R website (www.br-automation.com).

1. Download and unzip the .zip archive.
2. Close all applications.
3. Run the Setup.exe file (e.g. double-click on it in Explorer).

Information:

The ADI driver is already included in B&R images of embedded operating systems.

If a more current ADI driver version exists (see the Downloads section of the B&R website), it can be installed later. It is important that Enhanced Write Filter (EWF) is disabled for this.

11 B&R Automation Device Interface (ADI) Development Kit

This software can be used to access B&R Automation Device Interface (ADI) functions directly from Windows applications created in one of the following development environments:

- Microsoft Visual C++ 6.0
- Microsoft Visual Basic 6.0
- Microsoft Embedded Visual C++ 4.0
- Microsoft Visual Studio 2008 (or newer)

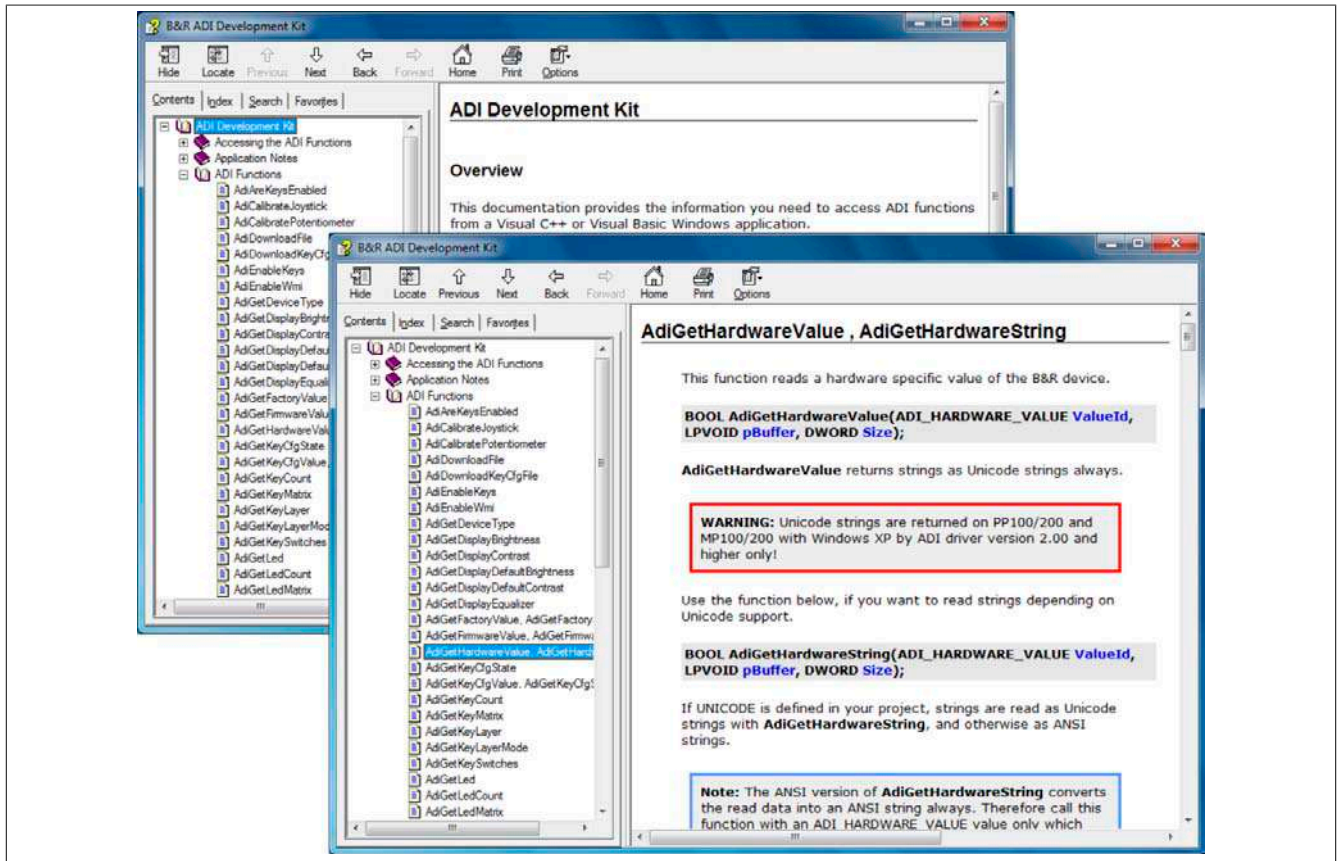

Figure 136: ADI Development Kit Screenshots (Version 3.70)

Features:

- One Microsoft Visual Basic module with ADI function declarations
- Header files and import libraries for Microsoft Visual C++
- Help files for Visual Basic and Visual C++
- Sample projects for Visual Basic and Visual C++
- ADI DLL (for application testing if no ADI driver is installed)

The following systems are supported (version 3.70 and higher):

- Automation PC 510
- Automation PC 511
- Automation PC 620
- Automation PC 810
- Automation PC 820
- Automation PC 910
- Automation PC 2100
- Panel PC 300
- Panel PC 700
- Panel PC 800
- Panel PC 900
- Panel PC 2100

- Power Panel 100/200
- Power Panel 300/400
- Power Panel 500
- Mobile Panel 40/50
- Mobile Panel 100/200

The ADI driver installed on the stated product series must be suitable for that device. The ADI driver is already included in B&R images of embedded operating systems.

A detailed description of how to use ADI functions can be found in the help system.

The B&R Automation Device Interface (ADI) development kit is available at no cost in the Downloads section of the B&R website (www.br-automation.com).

12 B&R Automation Device Interface (ADI) .NET SDK

This software can be used to access B&R Automation Device Interface (ADI) functions directly from .NET applications created using Microsoft Visual Studio 2005 or later.

Supported programming languages:

- Visual Basic
- Visual C++
- Visual C#

System requirements

- Development system: PC with Windows XP or Windows 7 and
 - Microsoft Visual Studio 2005 (or newer)
 - Microsoft .NET Framework 2.0 and/or Microsoft .NET Compact Framework 2.0 (or newer)

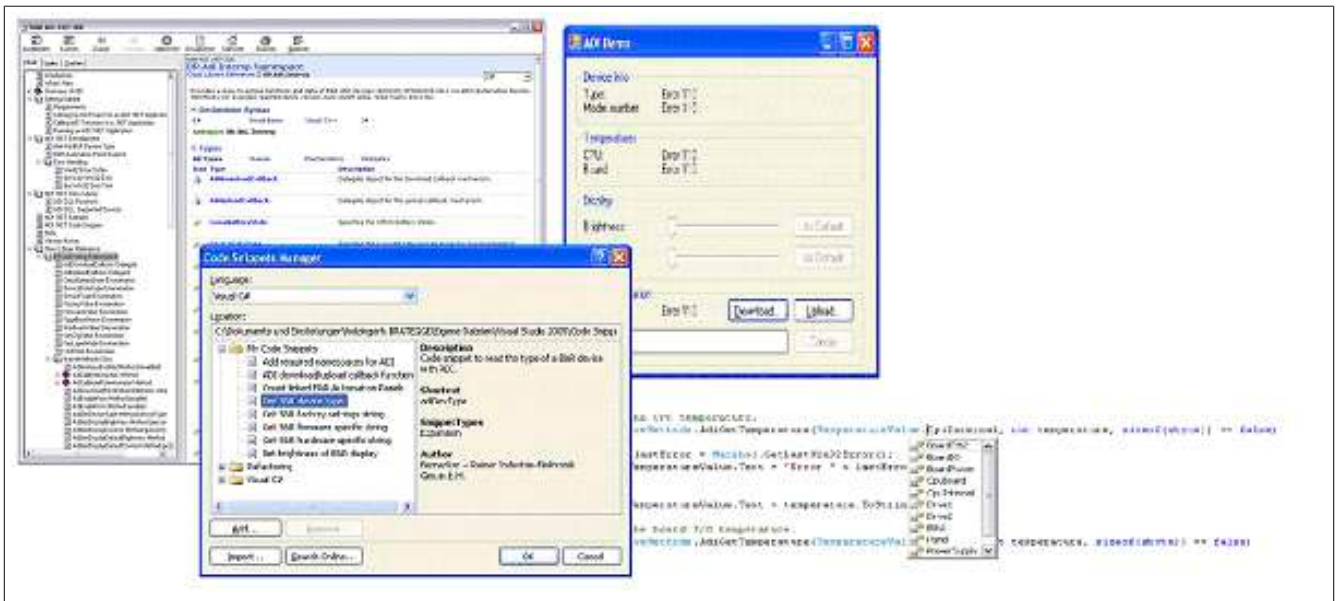

Figure 137: ADI .NET SDK screenshots (version 2.10)

Features (version 2.10 and higher)

- ADI .NET class library
- Help files in HTML Help 1.0 format (.chm), MS Help 2.0 format (.HxS) and MS Help Viewer format (.MSHC) (help documentation is in English only)
- Sample projects and code snippets for Visual Basic, Visual C++ and Visual C#
- ADI DLL (for application testing if no ADI driver is installed)

The following systems are supported (version 2.10 and higher):

- Automation PC 510
- Automation PC 511
- Automation PC 620
- Automation PC 810
- Automation PC 820
- Automation PC 910
- Automation PC 2100
- Panel PC 300
- Panel PC 700
- Panel PC 800
- Panel PC 900
- Panel PC 2100
- Power Panel 100/200
- Power Panel 300/400

- Power Panel 500
- Mobile Panel 40/50
- Mobile Panel 100/200

The ADI driver installed on the stated product series must be suitable for that device. The ADI driver is already included in B&R images of embedded operating systems.

A detailed description of how to use ADI functions can be found in the help system.

The ADI .NET SDK is available in the Downloads section of the B&R website (www.br-automation.com).

13 B&R Key Editor

On display devices, it is often necessary to adapt the function keys and LEDs directly to the application software being used. The B&R Key Editor makes it quick and easy to implement a unique configuration for the application.

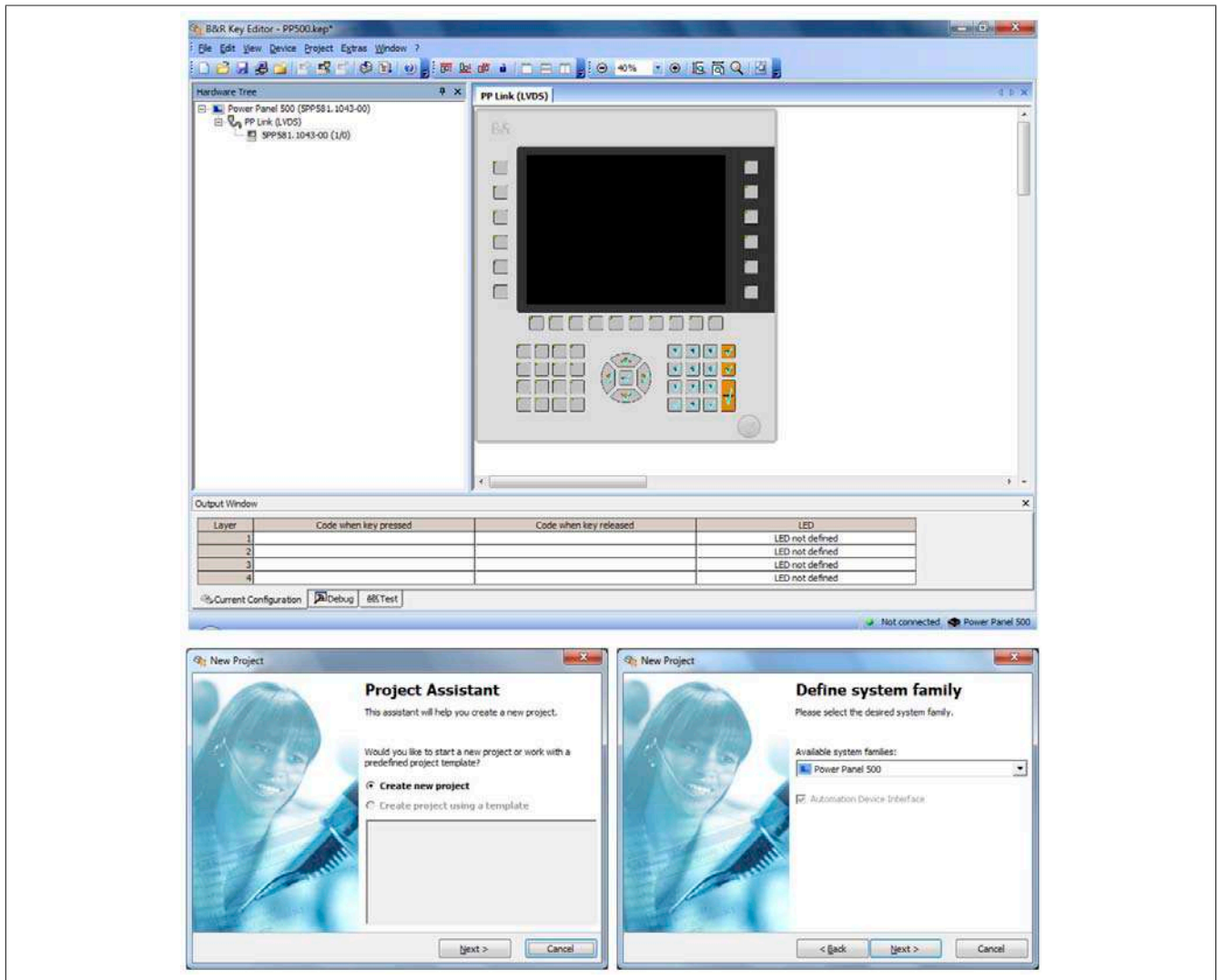

Figure 138: B&R Key Editor screenshots (version 3.60)

Features:

- Configuration of normal keyboard keys (A, B, C, etc.)
- Keyboard shortcuts (CTRL+C, SHIFT+DEL, etc.) using only one key
- Special key functions (change brightness, etc.)
- Assignment of functions to LEDs (HDD access, power, etc.)
- 4 assignments possible per key (using layers)
- Configuration of the panel locking time when multiple Automation Panel 900 devices are connected to Automation PC and Panel PC devices.

The following systems are supported (version 3.60 and higher):

- Automation PC 510
- Automation PC 511
- Automation PC 620
- Automation PC 810
- Automation PC 820
- Automation PC 910
- Automation PC 2100
- Automation Panel 800
- Automation Panel 830

- Automation Panel 900
- Automation Panel 9x3
- Automation Panel 9xD
- Automation Panel 1000
- IPC2000, IPC2001, IPC2002
- IPC5000, IPC5600
- IPC5000C, IPC5600C
- Mobile Panel 40/50
- Mobile Panel 100/200
- Panel PC 300
- Panel PC 700
- Panel PC 800
- Panel PC 900
- Panel PC 2100
- Power Panel 100/200
- Power Panel 300/400
- Power Panel 500

A detailed guide for configuring keys and LEDs can be found in the B&R Key Editor's help system. The B&R Key Editor is available at no cost in the Downloads section of the B&R website (www.br-automation.com).

14 B&R KCF Editor

The B&R KCF Editor can be used as a simple alternative to the B&R Key Editor. The function keys and LEDs can also be adjusted to the application software with it. Unlike B&R Key Editor, operation does not take place via the graphic display, but via a simple Windows dialog box. Therefore the B&R KCF Editor can be used for devices that are not yet supported in the B&R Key Editor. The B&R KCF Editor is a portable application and can be started on the target device without prior installation e.g. directly from a USB flash drive. An installed ADI driver is required for the full range of functions.

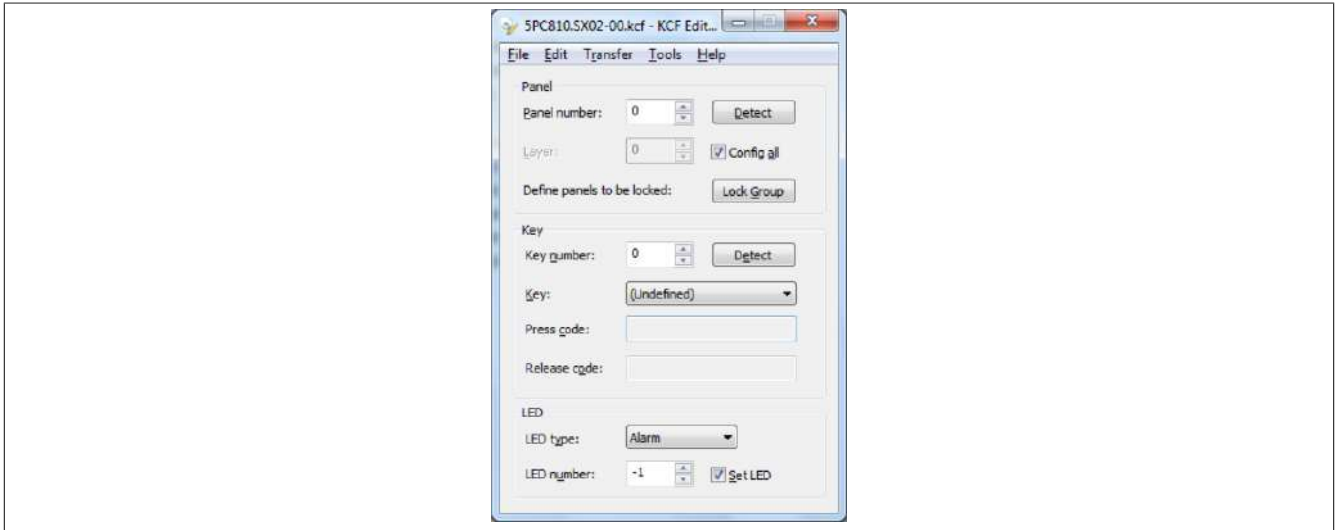

Figure 139: B&R KCF Editor screenshot (version 1.0)

Features

- Configuration of normal keyboard keys (A, B, C, etc.)
- Special key functions (change brightness, etc.)
- Assignment of LED functions (HDD access, power, etc.)
- 4 assignments possible per key (using layers)
- Configuration of the panel locking time when multiple Automation Panel devices are connected to B&R PCs.
- Export and import of the configuration (using .ini files)
- Saving the configuration as a report (as a text file)

Additional features if the KCF Editor is executed on the target device⁵⁾

- Panel and key detection
- LED test
- Downloading/uploading the configuration

The following systems are supported (version 1.0 and higher)

- Automation PCs
- Panel PCs
- Automation Panels
- Power Panels
- Mobile panels

A detailed guide for configuring keys and LEDs can be found in the user's manual of the B&R KCF Editor. The B&R KCF Editor and user's manual are available at no cost in the Downloads section of the B&R website (www.br-automation.com).

⁵⁾ For these features the ADI driver must be installed on the B&R PC.

15 HMI Service Center

15.1 5SWUTI.0001-000

15.1.1 General information

The HMI Service Center is a software tool used to test B&R Industrial PCs and Automation Panels. These tests cover many different aspects, including COM interfaces, network connectivity, SRAM, etc.

The test system consists of a USB flash drive with an installed Windows PE 5.1 operating system and the HMI Service Center.

Details regarding the HMI Service Center are available in the HMI Service Center user's manual. This can be downloaded for free from the B&R website (www.br-automation.com).

15.1.2 Order data

Model number	Short description	Figure
	Accessories	
5SWUTI.0001-000	HMI Service Center USB flash drive	

Table 185: 5SWUTI.0001-000 - Order data

Chapter 5 • Standards and certifications

1 Standards and guidelines

1.1 CE mark



Product complies with all applicable directives and their harmonized EN standards.

1.2 EMC directive

These devices meet the requirements of EC directive "2004/108/EC Electromagnetic compatibility" and are designed for the following areas:

EN 61131-2:2007	Programmable logic controllers - Part 2: Equipment requirements and tests
EN 61000-6 -2:2005	Electromagnetic compatibility (EMC) - Part 6-2: Generic standards - Immunity for industrial environments
EN 61000-6 -4:2007	Electromagnetic compatibility (EMC) - Part 6-4: Generic standards - Emission standard for industrial environments

1.3 Low voltage directive

These devices satisfy the requirements of EC directive "2006/95/EC Low voltage directive" and are designed for the following areas:

EN 61131-2:2007	Programmable logic controllers - Part 2: Equipment requirements and tests
EN 60204-1:2006 + A1:2009	Safety of machinery - Electrical equipment of machines - Part 1: General requirements

2 Certifications

Danger!

A complete system can only receive certification if **ALL** of the individual components it includes have the applicable certifications. If an individual component is being used that **DOES NOT** have an applicable certification, then the complete system **WILL NOT** receive certification.

B&R products and services comply with applicable standards. This includes international standards from organizations such as ISO, IEC and CENELEC, as well as national standards from organizations such as UL, CSA, FCC, VDE, ÖVE, etc. We are committed to ensuring the reliability of our products in an industrial environment.

Unless otherwise specified, the following certifications apply:

2.1 UL certification



Products with this mark have been tested by Underwriters Laboratories and are listed as "Industrial Control Equipment". This mark is valid for the USA and Canada and simplifies the certification of your machines and systems in these areas.

Underwriters Laboratories (UL) in accordance with the UL508 standard - 17th Edition Canadian (CSA) standard in accordance with C22.2 No. 142-M1987

2.2 GOST-R



Products with this mark have been certified by an accredited testing laboratory and have been approved for import to the Russian Federation (based on CE compliance).

2.3 GL certification (Germanischer Lloyd)



Some B&R products have been certified by Germanischer Lloyd and are approved for use in maritime environments. GL certificates (type approval) are generally accepted by other classification societies during ship acceptance procedures.

Germanischer Lloyd (GL) in accordance with standard GL 2003 (Category C EMC 1)

Category C concerns devices that are protected from the effects of weather. EMC 1 defines the radiated and conducted emission limits for devices installed on a ship's bridge.

Information:

Line filter 5AC804.MFLT-00 is absolutely mandatory in the supply line when used in a maritime environment. Additional information can be found on page Connecting to the end device.

The following table lists revisions from which GL certification applies to individual components.

Standards and certifications • Certifications

Model number	Short description	GL beginning with rev.
5PP551.0573-00	Power Panel 551 5.7" VGA TFT display; 22 function keys and 20 system keys; connections for 1x RS232, 2x USB 2.0, 1x Ethernet 10/100/1000; can be expanded with interface board; IP65 protection (front); order 24 VDC connector for supply voltage separately (screw clamp: 0TB103.9; cage clamp: 0TB103.91)	D0
5PP520.0702-00	Power Panel 520 7" WVGA TFT display with touch screen (resistive); connections for 1x RS232, 2x USB 2.0, 1x Ethernet 10/100/1000; can be expanded with interface board; IP65 protection (front); order male 24 VDC connector for supply voltage separately (screw clamp: 0TB103.9; cage clamp: 0TB103.91)	D0
5PP520.1505-00	Power Panel 520 15" XGA TFT display with touch screen (resistive); connections for 1x RS232, 3x USB 2.0, 1x Ethernet 10/100/1000; can be expanded with interface board; IP65 protection (front); order male 24 VDC connector for supply voltage separately (screw clamp: 0TB103.9; cage clamp: 0TB103.91)	D0
5PP5CP.US15-00	Intel Atom Z510 CPU board, 1100 MHz, single core, 400 MHz FSB, 512 kB L2 cache; US15W chipset; 1 slot for SO-DIMM DDR2 module	E0
5PP5CP.US15-01	Intel Atom Z520 CPU board, 1330 MHz, single core, 533 MHz FSB, 512 kB L2 cache; US15W chipset; 1 slot for SO-DIMM DDR2 module	E0
5PP5CP.US15-02	Intel Atom Z530 CPU board, 1600 MHz, single core, 533 MHz FSB, 512 kB L2 cache; US15W chipset; 1 slot for SO-DIMM DDR2 module	E0
5MMDDR.0512-01	SO-DIMM DDR2 RAM 512 MB PC2-5300	D0
5MMDDR.1024-01	SO-DIMM DDR2 RAM 1024 MB PC2-5300	D0
5MMDDR.2048-01	SO-DIMM DDR2 RAM 2048 MB PC2-5300	D0
5PP5IF.CETH-00	PP500 interface board; connection for 1x Ethernet 10/100/1000	E0
5PP5IF.FETH-00	PP500 interface board; connection for 1x Ethernet 10/100/1000, 512 kB SRAM	C0
5PP5IF.FPLM-00	PP500 interface board; connections for 2x POWERLINK (with integrated hub); 512 kB SRAM	D0
5PP5IF.FCAN-00	PP500 interface board; connection for 1x CAN master, 512 kB SRAM; order connector separately (cage clamp 0TB1208.3100)	D0
5PP5IF.FX2X-00	PP500 interface board; connection for 1x X2X master, 512 kB SRAM; order connector separately (cage clamp 0TB1208.3100)	E0
5PP5IF.FXCM-00	PP500 interface board; connection for 1x CAN master, 1x X2X master, 512 kB SRAM; order connector separately (cage clamp 0TB1208.3100)	E0
5CFCRD.0512-06	CompactFlash 512 MB B&R (SLC)	D0
5CFCRD.1024-06	CompactFlash 1 GB B&R (SLC)	D0
5CFCRD.2048-06	CompactFlash 2 GB B&R (SLC)	D0
5CFCRD.4096-06	CompactFlash 4 GB B&R (SLC)	D0
5CFCRD.8192-06	CompactFlash 8 GB B&R (SLC)	D0
5CFCRD.016G-06	CompactFlash 16 GB B&R (SLC)	D0
5CFCRD.032G-06	CompactFlash 32 GB B&R (SLC)	C0
5CFCRD.0512-04	CompactFlash 512 MB B&R (SLC)	D0
5CFCRD.1024-04	CompactFlash 1 GB B&R (SLC)	D0
5CFCRD.2048-04	CompactFlash 2 GB B&R (SLC)	D0
5CFCRD.4096-04	CompactFlash 4 GB B&R (SLC)	D0
5CFCRD.8192-04	CompactFlash 8 GB B&R (SLC)	D0
5CFCRD.016G-04	CompactFlash 16 GB B&R (SLC)	E0
5CFCRD.0064-03	CompactFlash 64 MB Western Digital (SLC)	E0
5CFCRD.0128-03	CompactFlash 128 MB Western Digital (SLC)	E0
5CFCRD.0256-03	CompactFlash 256 MB Western Digital (SLC)	E0
5CFCRD.0512-03	CompactFlash 512 MB Western Digital (SLC)	E0
5CFCRD.1024-03	CompactFlash 1 GB Western Digital (SLC)	E0
5CFCRD.2048-03	CompactFlash 2 GB Western Digital (SLC)	F0
5CFCRD.4096-03	CompactFlash 4 GB Western Digital (SLC)	E0
5CFCRD.8192-03	CompactFlash 8 GB Western Digital (SLC)	E0
5AC804.MFLT-00	Line filter	D0

Table 186: GL certifications

Certificate no. 37036 – 12 HH

		GL 
<h2 style="text-align: center;">Type Approval Certificate</h2>		
This is to certify that the undernoted product(s) has/have been tested in accordance with the relevant requirements of the GL Type Approval System.		
Certificate No.	37 036 - 12 HH	
Company	Bernecker + Rainer Industrie-Elektronik GmbH B&R Straße 1 5142 Eggelsberg, Austria	
Product Description	Power Panel	
Type	Power Panel 520 and 551, ATOM, up to 2GB RAM, 1 Interface slot (No hard disks or rotation devices)	
Environmental Category	C, EMC1	
Technical Data / Range of Application	System unit: 5PP551.0573-(X)00 (5.7" function keys only) 5PP520.0702-(X)00 (7" touch only) 5PP520.1044-(X)00 (10.4" touch only) 5PP520.1505-(X)00 (15" touch only)	
	Options: CPU board: 5PP5CP.US15-00, 5PP5CP.US15-01, 5PP5CP.US15-02 Main memory: 5MMDDR.XXXX-01 Compact flash: 5CFCRD.XXXX-(X)XX IF board: 5PP5IF.FXCM-(X)00, 5PP5IF.FX2X-(X)00, 5PP5IF.FCAN-(X)00, 5PP5IF.CCAN-(X)00, 5PP5IF.FETH-(X)00, 5PP5IF.CETH-(X)00, 5PP5IF.XDPM-(X)00, 5PP5IF.XPNM-(X)00, 5PP5IF.FPLM-(X)00	
	(X) ... Optional alphanumeric character for customized versions X ... Alphanumeric character	
Test Standard	Guidelines for the Performance of Type Approvals Chapter 2, Edition 2003 Guidelines for the Use of Computer and Computer Systems, Edition 1994	
Documents	Test reports : (MIKES) E35552-00-00MH, S35592-00-00AV, E35551-00-00MH, S35593-00-00AV, E35307-00-00KA, S35591-00-00AV, E35553-00-00MH, S35590-00-00AV, (B&R) 5PP520.1505-00 Test description V1.03 (28.10.2011), Manual MAPP500-GER V1_11	
Remarks	Filter 5AC804.MFLT-00 to be used in DC power line	
Valid until	2017-01-25	
Page	1 of 1	Type Approval Symbol 
File No.	I.B.05	
Hamburg,	2012-01-26	
Germanischer Lloyd	 Dr. Joannis Papanuskas	 Burkhard Lilienthal
This certificate is issued on the basis of "Guidelines for the Performance of Type Approvals Part 1, Procedure".		

Figure 140: GL certificate no. 37036 – 12 HH

Chapter 6 • Accessories

The following accessories have successfully completed functional testing at B&R and are approved for use with this device. Nevertheless, it is important to observe any limitations that may apply to the complete system when operated with other individual components. When operating the complete system, the specifications for the individual components must be observed.

All components listed in this manual have been subjected to extensive system and compatibility testing and are approved for use. B&R can make no guarantee regarding the functionality of non-approved accessories.

1 Replacement CMOS batteries

1.1 0AC201.91 / 4A0006.00-000

1.1.1 General information

This lithium battery is needed to back BIOS CMOS data and the real-time clock (RTC).

The battery is subject to wear and must be replaced when the battery power is insufficient ("Bad" status).

1.1.2 Order data

Model number	Short description	Figure
	Batteries	
0AC201.91	Lithium batteries 4 pcs., 3 V / 950 mAh button cell We hereby state that the lithium cells contained in this shipment qualify as "partly regulated". Handle with care. If the package is damaged, inspect the cells, repack intact cells and protect cells against short circuits. For emergency information, call RENATA SA at + 41 61 319 28 27	
4A0006.00-000	Lithium battery, 3 V / 950 mAh, button cell	

Table 187: 0AC201.91, 4A0006.00-000 - Order data

1.1.3 Technical data

Warning!

The battery is only permitted to be replaced by a Renata CR2477N battery. The use of another battery may present a risk of fire or explosion.

The battery may explode if handled improperly. Do not recharge, disassemble or dispose of in fire.

Information:

The following characteristics, features and limit values only apply to this accessory and can deviate from those specified for the complete system. The data specifications for the complete system take precedence over those of individual components.

Product ID	0AC201.91	4A0006.00-000
General information		
Storage time	Max. 3 years at 30°C	
Certification		
CE	Yes	
cULus	Yes	
Electrical characteristics		
Capacity	950 mAh	
Self-discharging	<1% per year (at 23°C)	
Voltage range	3 V	

Table 188: 0AC201.91, 4A0006.00-000 - Technical data

Product ID	0AC201.91	4A0006.00-000
Environmental conditions		
Temperature Storage	-20 to 60°C	
Relative humidity Operation	0 to 95%	
Storage	0 to 95%	
Transport	0 to 95%	

Table 188: 0AC201.91, 4A0006.00-000 - Technical data

2 Power connectors

2.1 0TB103.9x

2.1.1 General information

This single-row, 3-pin 0TB103 terminal block is used to connect the voltage supply.

2.1.2 Order data

Model number	Short description	Figure
	Terminal blocks	
0TB103.9	Connector 24 VDC - 3-pin female - Screw clamps 3.31 mm ²	
0TB103.91	Connector 24 VDC - 3-pin female - Cage clamps 3.31 mm ²	

Table 189: 0TB103.9, 0TB103.91 - Order data

2.1.3 Technical data

Information:

The following characteristics, features and limit values only apply to this accessory and can deviate from those specified for the complete system. The data specifications for the complete system take precedence over those of individual components.

Product ID	0TB103.9	0TB103.91
General information		
Certification		
CE		Yes
cULus		Yes
cULus HazLoc Class 1 Division 2		Yes ¹⁾
GL		Yes ²⁾
Terminal block		
Note	Protected against vibration by the screw flange Nominal values according to UL	
Number of pins	3 (female)	
Type of terminal clamp	Screw clamps	Cage clamps ³⁾
Cable type	Only copper wires (no aluminum wires!)	
Distance between contacts	5.08 mm	
Connection cross section		
AWG wire	26 to 14 AWG	26 to 12 AWG
Wire end sleeves with plastic covering		0.20 to 1.50 mm ²
Solid wires		0.20 to 2.50 mm ²
Fine strand wires	0.20 to 1.50 mm ²	0.20 to 2.50 mm ²
With wire end sleeves		0.20 to 1.50 mm ²
Tightening torque	0.4 Nm	-
Electrical characteristics		
Nominal voltage	300 V	
Nominal current ⁴⁾	10 A / contact	
Contact resistance	≤5 mΩ	

Table 190: 0TB103.9, 0TB103.91 - Technical data

- 1) Yes, although applies only if all components installed within the complete system have this certification and the complete system itself carries the corresponding mark.
- 2) Yes, although applies only if all components installed within the complete system have this certification.
- 3) Cage clamp terminal blocks cannot be used side-by-side.
- 4) The limit data for each I/O module must be taken into consideration.

3 Interface board connector

3.1 0TB1208.3100

3.1.1 General information

The 2-row 8-pin terminal block TB1208 is used to connect to various Power Panel 500 interface boards.

3.1.2 Order data

Model number	Short description	Figure
	Terminal blocks	
0TB1208.3100	Connector, 8-pin cage clamp, 1 mm ² , protected against vibration by the screw flange	

Table 191: 0TB1208.3100 - Order data

3.1.3 Technical data

Product ID	0TB1208.3100
General information	
Certification	
CE	Yes
cULus	Yes
GL	Yes ¹⁾
Terminal block	
Note	Nominal values according to UL
Number of pins	8 (female)
Type of terminal clamp	Tension spring connection
Cable type	Only copper wires (no aluminum wires!)
Distance between contacts	3.5 mm
Connection cross section	
AWG wire	28 to 18 AWG
Wire end sleeves with plastic covering	0.13 to 0.34 mm ²
Solid wires	0.20 to 1 mm ²
Fine strand wires	0.20 to 1 mm ²
With wire end sleeves	0.13 to 0.34 mm ²
Electrical characteristics	
Nominal voltage	300 V
Nominal current ²⁾	10 A / contact

Table 192: 0TB1208.3100 - Technical data

- 1) Yes, although applies only if all components installed within the complete system have this certification
 2) The limit data for each I/O module must be taken into consideration.

4 CompactFlash cards

4.1 General information

CompactFlash cards are storage media that are easy to replace. Due to their robustness against environmental influences (e.g. temperature, shock, vibration, etc.), CompactFlash cards are ideal for use as storage media in industrial environments.

4.2 General information

In order to be suited for use in industrial automation, CompactFlash cards must be highly reliable. The following items are very important to achieving the necessary level of reliability:

- The flash technology used
- An efficient algorithm for maximizing service life
- Good mechanisms for detecting and fixing errors in the flash memory

4.2.1 Flash technology

Currently, CompactFlash cards are available with MLC (multi-level cell) and SLC (single-level cell) flash blocks. SLC flash memory has a service life 10 times longer than MLC, which is why only CompactFlash cards with SLC flash blocks are suited for industrial applications.

4.2.2 Wear leveling

Wear leveling is an algorithm that can be used to maximize the service life of a CompactFlash card. There are three different algorithms:

- No wear leveling
- Dynamic wear leveling
- Static wear leveling

The basic idea behind wear leveling is to distribute data over a broad area of blocks or cells on the disk so that the same areas don't have to be cleared and reprogrammed over and over again.

4.2.2.1 No wear leveling

The earliest CompactFlash cards didn't have an algorithm for maximizing service life. The service life of a CompactFlash card was determined only by the guaranteed lifespan of the flash blocks.

4.2.2.2 Dynamic wear leveling

Dynamic wear leveling makes it possible to utilize unused flash blocks when writing to a file.

If the disk is 80% full with files, then only 20% can be used for wear leveling.

The service life of the CompactFlash card is therefore dependent on the amount of unused flash blocks.

4.2.2.3 Static wear leveling

Static wear leveling monitors which data is rarely modified. From time to time, the controller then moves this data to blocks that have already been used frequently in order to prevent further wear on those cells.

4.2.3 ECC error correction

Bit errors can be caused by inactivity or when a certain cell is being operated. Error correction coding (ECC) implemented via hardware or software can detect and correct many errors of this type.

4.2.4 S.M.A.R.T. support

Self-Monitoring, Analysis and Reporting Technology (S.M.A.R.T.) is an industry standard for mass storage devices that has been introduced to monitor important parameters and quickly detect imminent failures. Critical performance and calibration data is monitored and stored in order to help predict the probability of errors.

4.2.5 Maximum reliability

CompactFlash cards used by B&R use SLC flash blocks and static wear leveling together with a powerful ECC algorithm to provide maximum reliability.

4.3 5CFCRD.xxxx-06

4.3.1 General information

Information:

B&R CompactFlash cards 5CFCRD.xxxx-06 and CompactFlash cards from a different manufacturer cannot be used in the same system at the same time. Due to differences in technology (older vs. newer technologies), problems can occur during system startup that are caused by different boot times.

see "Known problems/issues" on page 268

Information:

5CFCRD.xxxx-06 CompactFlash cards are supported on B&R devices with WinCE version ≥ 6.0 .

4.3.2 Order data

Model number	Short description	Figure
	CompactFlash cards	
5CFCRD.0512-06	CompactFlash 512 MB B&R (SLC) \geq Rev. F0	
5CFCRD.1024-06	CompactFlash 1 GB B&R (SLC) \geq Rev. F0	
5CFCRD.2048-06	CompactFlash 2 GB B&R (SLC) \geq Rev. F0	
5CFCRD.4096-06	CompactFlash 4 GB B&R (SLC) \geq Rev. F0	
5CFCRD.8192-06	CompactFlash 8 GB B&R (SLC) \geq Rev. F0	
5CFCRD.016G-06	CompactFlash 16 GB B&R (SLC) \geq Rev. E0	
5CFCRD.032G-06	CompactFlash 32 GB B&R (SLC) \geq Rev. D0	

Table 193: 5CFCRD.0512-06, 5CFCRD.1024-06, 5CFCRD.2048-06, 5CFCRD.4096-06, 5CFCRD.8192-06, 5CFCRD.016G-06, 5CFCRD.032G-06 - Order data

Model number	Short description	Figure
	CompactFlash cards	
5CFCRD.0512-06	CompactFlash 512 MB B&R (SLC) \leq Rev. E0	
5CFCRD.1024-06	CompactFlash 1 GB B&R (SLC) \leq Rev. E0	
5CFCRD.2048-06	CompactFlash 2 GB B&R (SLC) \leq Rev. E0	
5CFCRD.4096-06	CompactFlash 4 GB B&R (SLC) \leq Rev. E0	
5CFCRD.8192-06	CompactFlash 8 GB B&R (SLC) \leq Rev. E0	
5CFCRD.016G-06	CompactFlash 16 GB B&R (SLC) \leq Rev. D0	
5CFCRD.032G-06	CompactFlash 32 GB B&R (SLC) \leq Rev. C0	

Table 194: 5CFCRD.0512-06, 5CFCRD.1024-06, 5CFCRD.2048-06, 5CFCRD.4096-06, 5CFCRD.8192-06, 5CFCRD.016G-06, 5CFCRD.032G-06 - Order data

4.3.3 Technical data

Caution!

A sudden loss of power may result in data loss! In very rare cases, the mass storage device may also become damaged.

To prevent damage and loss of data, the use of a UPS device is recommended.

Information:

The following characteristics, features and limit values only apply to this accessory and can deviate from those specified for the complete system. The data specifications for the complete system take precedence over those of individual components.

Product ID	5CFCRD. 0512-06 ≥ Rev. F0	5CFCRD. 1024-06 ≥ Rev. F0	5CFCRD. 2048-06 ≥ Rev. F0	5CFCRD. 4096-06 ≥ Rev. F0	5CFCRD. 8192-06 ≥ Rev. F0	5CFCRD. 016G-06 ≥ Rev. E0	5CFCRD. 032G-06 ≥ Rev. D0
General information							
Capacity	512 MB	1 GB	2 GB	4 GB	8 GB	16 GB	32 GB
Data retention	10 years						
Data reliability	<1 unrecoverable error in 10 ¹⁴ bit read accesses						
Lifetime monitoring	Yes						
MTBF	>3,000,000 hours (at 25°C)						
Maintenance	None						
Supported operating modes	PIO Mode 0-6, Multiword DMA Mode 0-4, Ultra DMA Mode 0-4						
Sequential read							
Typical	42 MB/s	42 MB/s	59 MB/s	59 MB/s	59 MB/s	59 MB/s	58 MB/s
Maximum	53 MB/s	53 MB/s	65 MB/s	65 MB/s	65 MB/s	65 MB/s	65 MB/s
Sequential write							
Typical	25 MB/s	25 MB/s	31 MB/s	31 MB/s	31 MB/s	31 MB/s	31 MB/s
Maximum	27 MB/s	27 MB/s	35 MB/s	35 MB/s	35 MB/s	35 MB/s	35 MB/s
Certification							
CE	Yes						
cULus	Yes						
cULus HazLoc Class 1 Division 2	-	-	-	-	-	Yes ¹⁾	-
ATEX Zone 22	-	-	-	-	-	Yes ¹⁾	-
GOST-R	Yes						
GL	Yes ²⁾						
Endurance							
SLC flash	Yes						
Guaranteed data volume							
Guaranteed ³⁾	50 TB	100 TB	200 TB	400 TB	800 TB	1600 TB	3200 TB
Over 5 years, equates to ³⁾	27.40 GB/day	54.79 GB/day	109.59 GB/day	219.18 GB/day	438.36 GB/day	876.72 GB/day	1753.44 GB/day
Clear/Write cycles							
Guaranteed	100,000						
Wear leveling	Static						
Error correction coding (ECC)	Yes						
S.M.A.R.T. support	Yes						
Support							
Hardware	PP300/400, PP500, PPC300, PPC700, PPC725, PPC800, APC620, APC810, APC820						
Operating systems							
Windows 7 32-bit	No	No	No	No	No	Yes	Yes
Windows 7 64-bit	No	No	No	No	No	No	Yes
Windows Embedded Standard 7, 32-bit	No	No	No	No	Yes	Yes	Yes
Windows Embedded Standard 7, 64-bit	No	No	No	No	No	Yes	Yes
Windows XP Professional	No	No	No	Yes	Yes	Yes	Yes
Windows XP Embedded	Yes						
Windows Embedded Standard 2009	No	Yes	Yes	Yes	Yes	Yes	Yes
Windows CE 6.0	Yes	Yes	Yes	Yes	Yes	Yes ⁴⁾	Yes ⁴⁾
Windows CE 5.0	No						
Software							
PVI Transfer	≥V3.2.3.8 (part of PVI Development Setup ≥ V2.06.00.3011)	≥V3.2.3.8 (part of PVI Development Setup ≥ V2.06.00.3011)	≥V3.2.3.8 (part of PVI Development Setup ≥ V2.06.00.3011)	≥V3.2.3.8 (part of PVI Development Setup ≥ V2.06.00.3011)	≥V3.2.3.8 (part of PVI Development Setup ≥ V2.06.00.3011)	≥V3.6.8.40 (part of PVI Development Setup ≥ V3.0.0.3020)	≥V4.0.0.8 (part of PVI Development Setup ≥ V3.0.2.3014)
B&R Embedded OS Installer	≥V3.10	≥V3.10	≥V3.10	≥V3.10	≥V3.10	≥V3.20	≥V3.21

Table 195: 5CFCRD.0512-06, 5CFCRD.1024-06, 5CFCRD.2048-06, 5CFCRD.4096-06, 5CFCRD.8192-06, 5CFCRD.016G-06, 5CFCRD.032G-06 - Technical data

Product ID	5CFCRD.0512-06 ≥ Rev. F0	5CFCRD.1024-06 ≥ Rev. F0	5CFCRD.2048-06 ≥ Rev. F0	5CFCRD.4096-06 ≥ Rev. F0	5CFCRD.8192-06 ≥ Rev. F0	5CFCRD.016G-06 ≥ Rev. E0	5CFCRD.032G-06 ≥ Rev. D0
Environmental conditions							
Temperature							
Operation	0 to 70°C						
Storage	-50 to 100°C						
Transport	-50 to 100°C						
Relative humidity							
Operation	Max. 85% at 85°C						
Storage	Max. 85% at 85°C						
Transport	Max. 85% at 85°C						
Vibration							
Operation	20 g peak, 20 to 2000 Hz, 4 in each direction (JEDEC JESD22, method B103) 5.35 g RMS, 15 min. per level (IEC 68-2-6)						
Storage	20 g peak, 20 to 2000 Hz, 4 in each direction (JEDEC JESD22, method B103) 5.35 g RMS, 15 min. per level (IEC 68-2-6)						
Transport	20 g peak, 20 to 2000 Hz, 4 in each direction (JEDEC JESD22, method B103) 5.35 g RMS, 15 min. per level (IEC 68-2-6)						
Shock							
Operation	1500 g peak, 0.5 ms 5 times (JEDEC JESD22, method B110) 30 g, 11 ms 1 times (IEC 68-2-27)						
Storage	1500 g peak, 0.5 ms 5 times (JEDEC JESD22, method B110) 30 g, 11 ms 1 times (IEC 68-2-27)						
Transport	1500 g peak, 0.5 ms 5 times (JEDEC JESD22, method B110) 30 g, 11 ms 1 times (IEC 68-2-27)						
Elevation							
Operation	Max. 4572 m						
Mechanical characteristics							
Dimensions							
Width	42.8 ±0.10 mm						
Length	36.4 ±0.15 mm						
Height	3.3 ±0.10 mm						
Weight	10 g						

Table 195: 5CFCRD.0512-06, 5CFCRD.1024-06, 5CFCRD.2048-06, 5CFCRD.4096-06, 5CFCRD.8192-06, 5CFCRD.016G-06, 5CFCRD.032G-06 - Technical data

- 1) Yes, although applies only if all components installed within the complete system have this certification and the complete system itself carries the corresponding mark.
- 2) Yes, although applies only if all components installed within the complete system have this certification.
- 3) Endurance of B&R CFs (with linear written block size ≥128 kB).
- 4) Not supported by the B&R Embedded OS Installer.

Caution!

A sudden loss of power may result in data loss! In very rare cases, the mass storage device may also become damaged.

To prevent damage and loss of data, the use of a UPS device is recommended.

Information:

The following characteristics, features and limit values only apply to this accessory and can deviate from those specified for the complete system. The data specifications for the complete system take precedence over those of individual components.

Product ID	5CFCRD.0512-06 ≤ Rev. E0	5CFCRD.1024-06 ≤ Rev. E0	5CFCRD.2048-06 ≤ Rev. E0	5CFCRD.4096-06 ≤ Rev. E0	5CFCRD.8192-06 ≤ Rev. E0	5CFCRD.016G-06 ≤ Rev. D0	5CFCRD.032G-06 ≥ Rev. C0
General information							
Capacity	512 MB	1 GB	2 GB	4 GB	8 GB	16 GB	32 GB
Data retention	10 years						
Data reliability	<1 unrecoverable error in 10 ¹⁴ bit read accesses						
Lifetime monitoring	Yes						
MTBF	>3,000,000 hours (at 25°C)						
Maintenance	None						
Supported operating modes	PIO Mode 0-6, Multiword DMA Mode 0-4, Ultra DMA Mode 0-4						
Sequential read							
Typical	33 MB/s	33 MB/s	33 MB/s	33 MB/s	33 MB/s	36 MB/s	36 MB/s
Maximum	35 MB/s	35 MB/s	35 MB/s	34 MB/s	34 MB/s	37 MB/s	37 MB/s
Sequential write							
Typical	15 MB/s	15 MB/s	15 MB/s	14 MB/s	14 MB/s	28 MB/s	28 MB/s
Maximum	18 MB/s	18 MB/s	18 MB/s	17 MB/s	17 MB/s	30 MB/s	30 MB/s

Table 196: 5CFCRD.0512-06, 5CFCRD.1024-06, 5CFCRD.2048-06, 5CFCRD.4096-06, 5CFCRD.8192-06, 5CFCRD.016G-06, 5CFCRD.032G-06 - Technical data

Product ID	5CFCRD.0512-06 ≤ Rev. E0	5CFCRD.1024-06 ≤ Rev. E0	5CFCRD.2048-06 ≤ Rev. E0	5CFCRD.4096-06 ≤ Rev. E0	5CFCRD.8192-06 ≤ Rev. E0	5CFCRD.016G-06 ≤ Rev. D0	5CFCRD.032G-06 ≥ Rev. C0	
Certification								
CE	Yes							
cULus	Yes							
cULus HazLoc Class 1 Division 2	-	-	-	-	-	Yes ¹⁾	-	
ATEX Zone 22	-	-	-	-	-	Yes ¹⁾	-	
GOST-R	Yes							
GL	Yes ²⁾							
Endurance								
SLC flash	Yes							
Guaranteed data volume								
Guaranteed ³⁾	50 TB	100 TB	200 TB	400 TB	800 TB	1600 TB	3200 TB	
Over 5 years, equates to ³⁾	27.40 GB/day	54.79 GB/day	109.59 GB/day	219.18 GB/day	438.36 GB/day	876.72 GB/day	1753.44 GB/day	
Clear/Write cycles								
Guaranteed	100,000							
Wear leveling	Static							
Error correction coding (ECC)	Yes							
S.M.A.R.T. support	Yes							
Support								
Hardware	PP300/400, PP500, PPC300, PPC700, PPC725, PPC800, APC620, APC810, APC820							
Operating systems								
Windows 7 32-bit	No	No	No	No	No	Yes	Yes	
Windows 7 64-bit	No	No	No	No	No	No	Yes	
Windows Embedded Standard 7, 32-bit	No	No	No	No	Yes	Yes	Yes	
Windows Embedded Standard 7, 64-bit	No	No	No	No	No	Yes	Yes	
Windows XP Professional	No	No	No	Yes	Yes	Yes	Yes	
Windows XP Embedded	Yes							
Windows Embedded Standard 2009	No	Yes	Yes	Yes	Yes	Yes	Yes	
Windows CE 6.0	Yes	Yes	Yes	Yes	Yes	Yes	Yes	
Windows CE 5.0	No							
Software								
PVI Transfer	≥V3.2.3.8 (part of PVI Development Setup ≥ V2.06.00.3011)	≥V3.2.3.8 (part of PVI Development Setup ≥ V2.06.00.3011)	≥V3.2.3.8 (part of PVI Development Setup ≥ V2.06.00.3011)	≥V3.2.3.8 (part of PVI Development Setup ≥ V2.06.00.3011)	≥V3.2.3.8 (part of PVI Development Setup ≥ V2.06.00.3011)	≥V3.2.3.8 (part of PVI Development Setup ≥ V2.06.00.3011)	≥V3.6.8.40 (part of PVI Development Setup ≥ V3.0.0.3020)	≥V4.0.0.8 (part of PVI Development Setup ≥V3.0.2.3014)
B&R Embedded OS Installer	≥V3.10	≥V3.10	≥V3.10	≥V3.10	≥V3.10	≥V3.10	≥V3.20	≥V3.21
Environmental conditions								
Temperature								
Operation	0 to 70°C							
Storage	-50 to 100°C							
Transport	-50 to 100°C							
Relative humidity								
Operation	Max. 85% at 85°C							
Storage	Max. 85% at 85°C							
Transport	Max. 85% at 85°C							
Vibration								
Operation	20 g peak, 20 to 2000 Hz, 4 in each direction (JEDEC JESD22, method B103) 5.35 g RMS, 15 min. per level (IEC 68-2-6)							
Storage	20 g peak, 20 to 2000 Hz, 4 in each direction (JEDEC JESD22, method B103) 5.35 g RMS, 15 min. per level (IEC 68-2-6)							
Transport	20 g peak, 20 to 2000 Hz, 4 in each direction (JEDEC JESD22, method B103) 5.35 g RMS, 15 min. per level (IEC 68-2-6)							
Shock								
Operation	1500 g peak, 0.5 ms 5 times (JEDEC JESD22, method B110) 30 g, 11 ms 1 times (IEC 68-2-27)							
Storage	1500 g peak, 0.5 ms 5 times (JEDEC JESD22, method B110) 30 g, 11 ms 1 times (IEC 68-2-27)							
Transport	1500 g peak, 0.5 ms 5 times (JEDEC JESD22, method B110) 30 g, 11 ms 1 times (IEC 68-2-27)							
Elevation								
Operation	Max. 4572 m							

Table 196: 5CFCRD.0512-06, 5CFCRD.1024-06, 5CFCRD.2048-06, 5CFCRD.4096-06, 5CFCRD.8192-06, 5CFCRD.016G-06, 5CFCRD.032G-06 - Technical data

Product ID	5CFCRD. 0512-06 ≤ Rev. E0	5CFCRD. 1024-06 ≤ Rev. E0	5CFCRD. 2048-06 ≤ Rev. E0	5CFCRD. 4096-06 ≤ Rev. E0	5CFCRD. 8192-06 ≤ Rev. E0	5CFCRD. 016G-06 ≤ Rev. D0	5CFCRD. 032G-06 ≥ Rev. C0
Mechanical characteristics							
Dimensions							
Width	42.8 ±0.10 mm						
Length	36.4 ±0.15 mm						
Height	3.3 ±0.10 mm						
Weight	10 g						

Table 196: 5CFCRD.0512-06, 5CFCRD.1024-06, 5CFCRD.2048-06, 5CFCRD.4096-06, 5CFCRD.8192-06, 5CFCRD.016G-06, 5CFCRD.032G-06 - Technical data

- 1) Yes, although applies only if all components installed within the complete system have this certification and the complete system itself carries the corresponding mark.
- 2) Yes, although applies only if all components installed within the complete system have this certification.
- 3) Endurance of B&R CFs (with linear written block size ≥128 kB).
- 4) Not supported by the B&R Embedded OS Installer.

4.3.4 Temperature/Humidity diagram

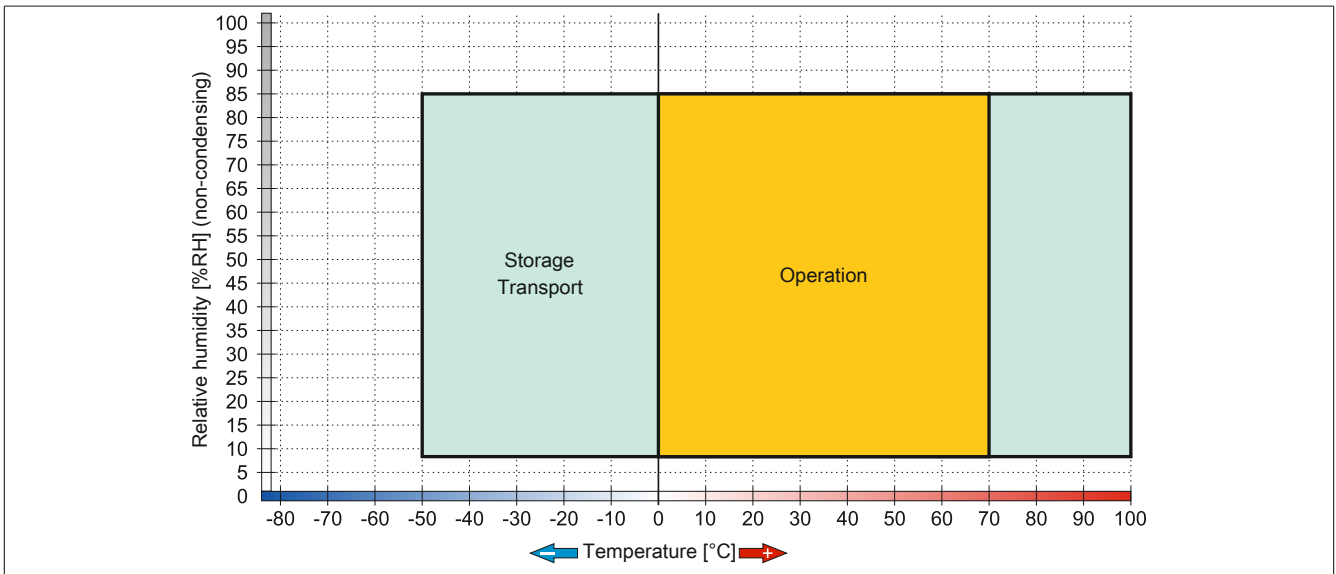

Figure 141: 5CFCRD.xxxx-06 - Temperature/Humidity diagram for CompactFlash cards

4.3.5 Dimensions

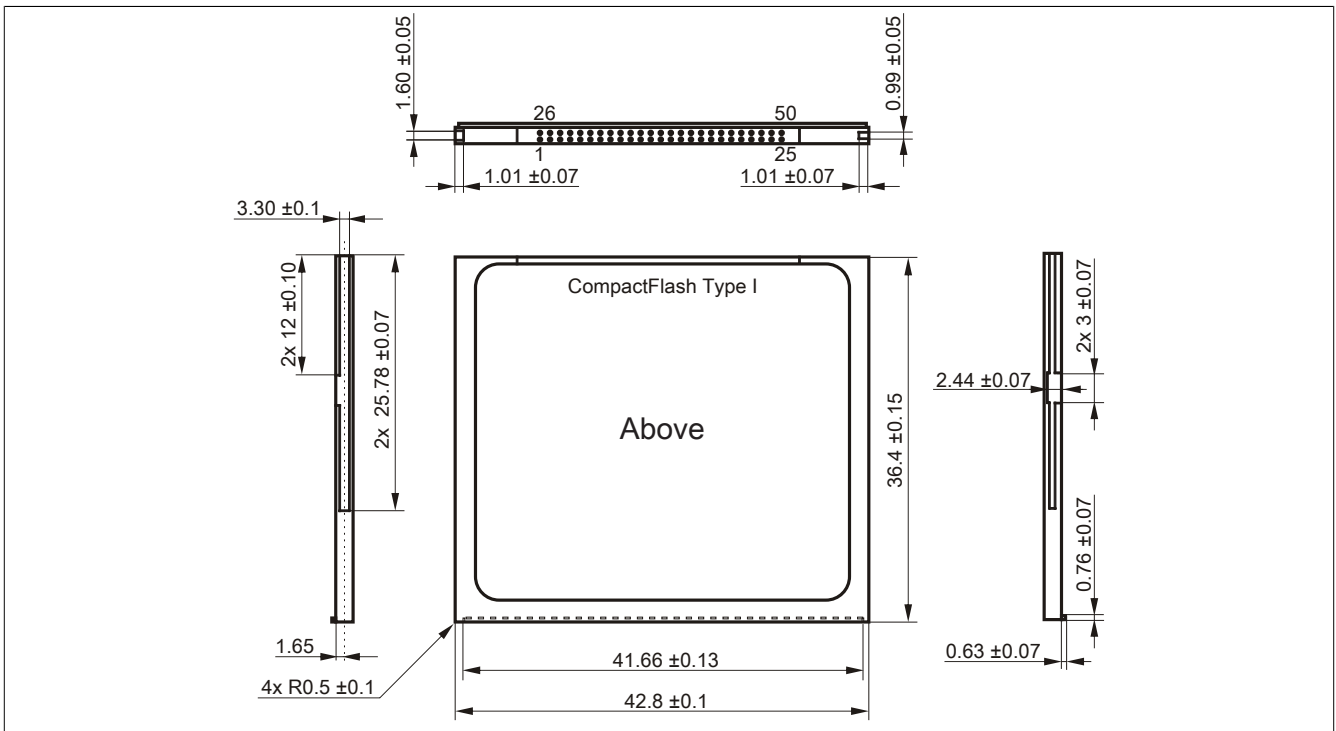

Figure 142: Type I CompactFlash card - Dimensions

4.3.6 Benchmark

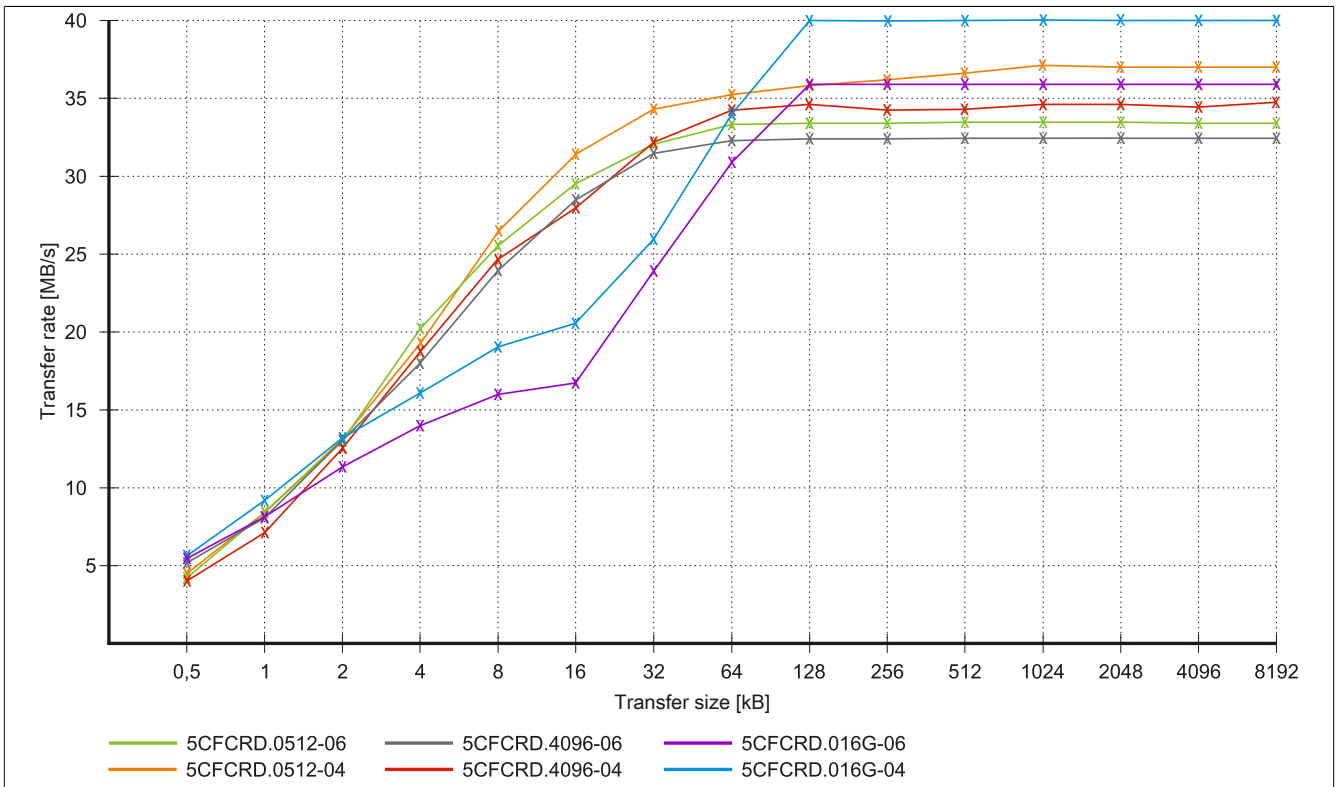

Figure 143: ATTO Disk Benchmark v2.34 read comparison - 5CFCRD.xxxx-04 and 5CFCRD.xxxx-06

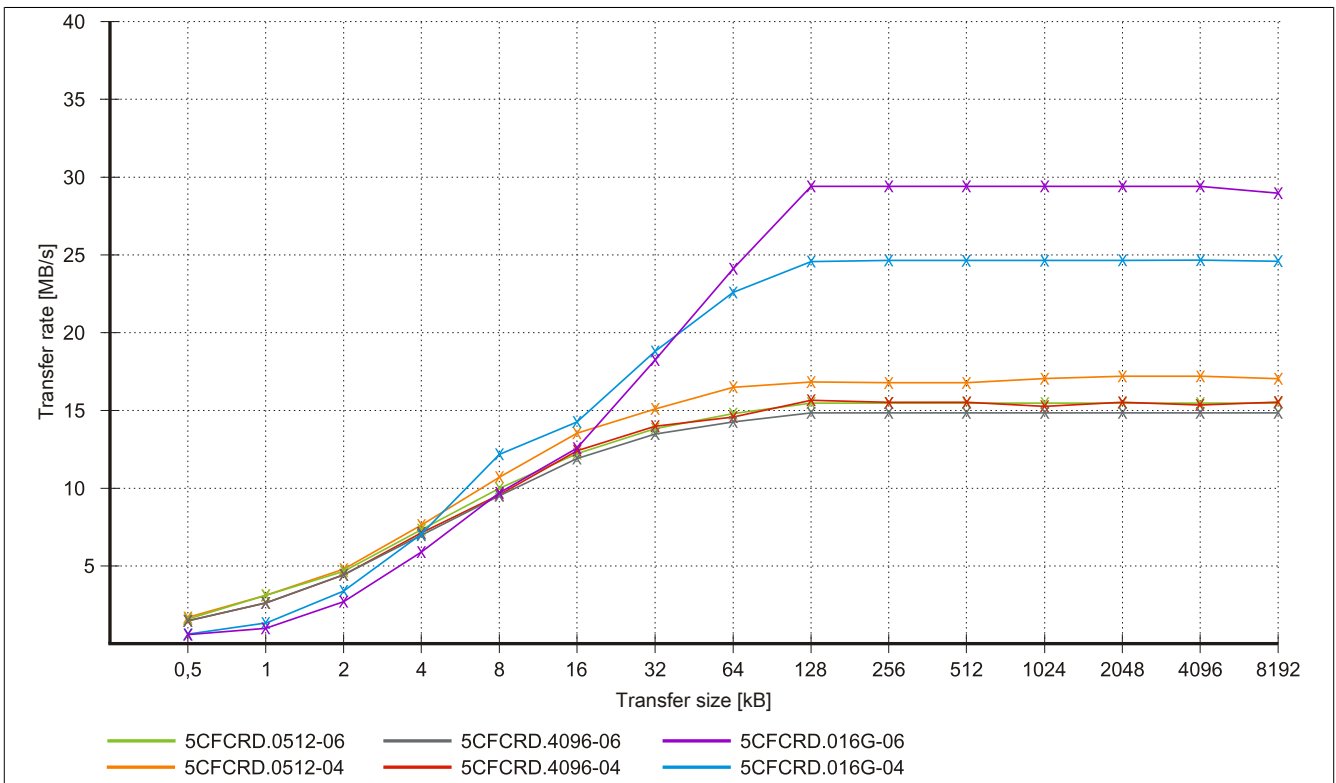

Figure 144: ATTO Disk Benchmark v2.34 write comparison - 5CFCRD.xxxx-04 and 5CFCRD.xxxx-06

4.4 5CFCRD.xxxx-04

4.4.1 General information

Information:

B&R CompactFlash cards 5CFCRD.xxxx-04 and CompactFlash cards from a different manufacturer cannot be used in the same system at the same time. Due to differences in technology (older vs. newer technologies), problems can occur during system startup that are caused by different boot times.

see "Known problems/issues" on page 268

Information:

5CFCRD.xxxx-04 CompactFlash cards are supported on B&R devices with WinCE version ≥ 6.0 .

4.4.2 Order data

Model number	Short description	Figure
	CompactFlash cards	
5CFCRD.0512-04	CompactFlash 512 MB B&R (SLC)	
5CFCRD.1024-04	CompactFlash 1 GB B&R (SLC)	
5CFCRD.2048-04	CompactFlash 2 GB B&R (SLC)	
5CFCRD.4096-04	CompactFlash 4 GB B&R (SLC)	
5CFCRD.8192-04	CompactFlash 8 GB B&R (SLC)	
5CFCRD.016G-04	CompactFlash 16 GB B&R (SLC)	

Table 197: 5CFCRD.0512-04, 5CFCRD.1024-04, 5CFCRD.2048-04, 5CFCRD.4096-04, 5CFCRD.8192-04, 5CFCRD.016G-04 - Order data

4.4.3 Technical data

Caution!

A sudden loss of power may result in data loss! In very rare cases, the mass storage Card device may also become damaged.

To prevent damage and loss of data, the use of a UPS device is recommended.

Information:

The following characteristics, features and limit values only apply to this accessory and can deviate from those specified for the complete system. The data specifications for the complete system take precedence over those of individual components.

Product ID	5CFCRD.0512-04	5CFCRD.1024-04	5CFCRD.2048-04	5CFCRD.4096-04	5CFCRD.8192-04	5CFCRD.016G-04
General information						
Capacity	512 MB	1 GB	2 GB	4 GB	8 GB	16 GB
Data retention	10 years					
Data reliability	<1 unrecoverable error in 10^{14} bit read accesses					
Lifetime monitoring	Yes					
MTBF	>3,000,000 hours (at 25°C)					
Maintenance	None					
Supported operating modes	PIO Mode 0-6, Multiword DMA Mode 0-4, Ultra DMA Mode 0-4					
Sequential read						
Typical	35 MB/s (240X) ¹⁾	35 MB/s (240X) ¹⁾	35 MB/s (240X) ¹⁾	33 MB/s (220X) ¹⁾	27 MB/s (180X) ¹⁾	36 MB/s (240X) ¹⁾
Maximum	37 MB/s (260X) ¹⁾	37 MB/s (260X) ¹⁾	37 MB/s (260X) ¹⁾	34 MB/s (226X) ¹⁾	28 MB/s (186X) ¹⁾	37 MB/s (247X) ¹⁾

Table 198: 5CFCRD.0512-04, 5CFCRD.1024-04, 5CFCRD.2048-04, 5CFCRD.4096-04, 5CFCRD.8192-04, 5CFCRD.016G-04 - Technical data

Accessories • CompactFlash cards

Product ID	5CFCRD.0512-04	5CFCRD.1024-04	5CFCRD.2048-04	5CFCRD.4096-04	5CFCRD.8192-04	5CFCRD.016G-04
Sequential write						
Typical	17 MB/s (110X)	17 MB/s (110X)	17 MB/s (110X)	16 MB/s (106X)	15 MB/s (100X)	18 MB/s (120X)
Maximum	20 MB/s (133X)	20 MB/s (133X)	20 MB/s (133X)	18 MB/s (120X)	17 MB/s (110X)	19 MB/s (126X)
Certification				Yes		
CE				Yes		
cULus				Yes		
GOST-R	-	Yes	Yes	Yes	Yes	Yes
GL				Yes ²⁾		
Endurance						
SLC flash	Yes					
Guaranteed data volume						
Guaranteed ³⁾	50 TB	100 TB	200 TB	400 TB	800 TB	1600 TB
Results for 5 years ³⁾	27.40 GB/day	54.79 GB/day	109.9 GB/day	219.8 GB/day	438.6 GB/day	876.72 GB/day
Clear/Write cycles						
Typical ⁴⁾	2,000,000					
Guaranteed	100,000					
Wear leveling	Static					
Error correction coding (ECC)	Yes					
S.M.A.R.T. support	No					
Support						
Hardware	PP300/400, PP500, PPC300, PPC700, PPC725, PPC800, APC620, APC810, APC820					
Operating systems						
Windows 7 32-bit	No	No	No	No	No	Yes
Windows 7 64-bit				No		
Windows Embedded Standard 7, 32-bit	No	No	No	No	Yes	Yes
Windows Embedded Standard 7, 64-bit	No	No	No	No	No	Yes
Windows XP Professional	No	No	No	Yes	Yes	Yes
Windows XP Embedded				Yes		
Windows Embedded Standard 2009	No	Yes	Yes	Yes	Yes	Yes
Windows CE 6.0	Yes	Yes	Yes	Yes	Yes	Yes ⁵⁾
Windows CE 5.0				No		
Software						
PVI Transfer	≥ V3.2.3.8 (part of PVI Development Setup ≥ V2.06.00.3011)	≥ V3.2.3.8 (part of PVI Development Setup ≥ V2.06.00.3011)	≥ V3.2.3.8 (part of PVI Development Setup ≥ V2.06.00.3011)	≥ V3.2.3.8 (part of PVI Development Setup ≥ V2.06.00.3011)	≥ V3.2.3.8 (part of PVI Development Setup ≥ V2.06.00.3011)	≥ V3.6.8.40 (part of PVI Development Setup ≥ V3.0.0.3020)
B&R Embedded OS Installer	≥V3.10	≥V3.10	≥V3.10	≥V3.10	≥V3.10	≥V3.20
Environmental conditions						
Temperature						
Operation	0 to 70°C					
Storage	-65 to 150°C					
Transport	-65 to 150°C					
Relative humidity						
Operation	Max. 85% at 85°C					
Storage	Max. 85% at 85°C					
Transport	Max. 85% at 85°C					
Vibration						
Operation	20 g peak, 20 to 2000 Hz, 4 in each direction (JEDEC JESD22, method B103) 5.35 g RMS, 15 min per level (IEC 68-2-6)					
Storage	20 g peak, 20 to 2000 Hz, 4 in each direction (JEDEC JESD22, method B103) 5.35 g RMS, 15 min per level (IEC 68-2-6)					
Transport	20 g peak, 20 to 2000 Hz, 4 in each direction (JEDEC JESD22, method B103) 5.35 g RMS, 15 min per level (IEC 68-2-6)					
Shock						
Operation	1500 g peak, 0.5 ms 5 times (JEDEC JESD22, method B110) 30 g, 11 ms 1 times (IEC 68-2-27)					
Storage	1500 g peak, 0.5 ms 5 times (JEDEC JESD22, method B110) 30 g, 11 ms 1 times (IEC 68-2-27)					
Transport	1500 g peak, 0.5 ms 5 times (JEDEC JESD22, method B110) 30 g, 11 ms 1 times (IEC 68-2-27)					
Elevation						
Operation	Max. 4572 m					
Mechanical characteristics						
Dimensions						
Width	42.8 ±0.10 mm					
Length	36.4 ±0.15 mm					
Height	3.3 ±0.10 mm					
Weight	10 g					

Table 198: 5CFCRD.0512-04, 5CFCRD.1024-04, 5CFCRD.2048-04, 5CFCRD.4096-04, 5CFCRD.8192-04, 5CFCRD.016G-04 - Technical data

- Speed specification with 1X = 150 Kb/s. All specifications refer to Samsung flash chips, CompactFlash cards in UDMA mode 4 and 30 ns cycle time in True IDE mode with sequential write/read test.
- Yes, although applies only if all components installed within the complete system have this certification

- 3) Endurance of B&R CFs (with linear written block size ≥ 128 kB).
- 4) Depends on the average file size.
- 5) Not supported by the B&R Embedded OS Installer.

4.4.4 Temperature/Humidity diagram

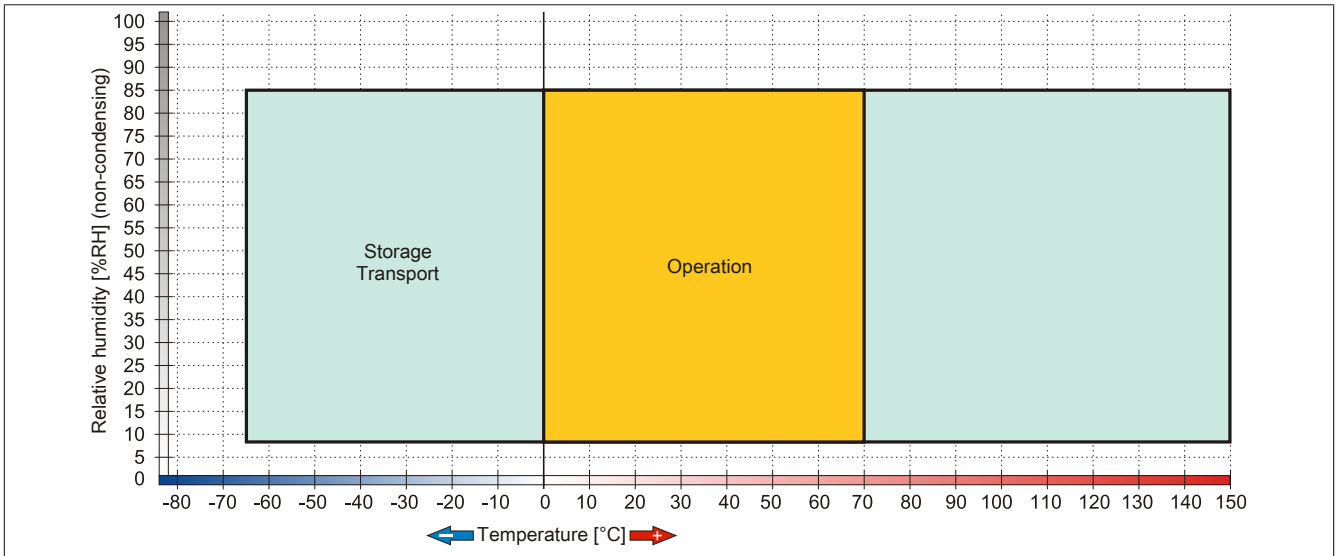

Figure 145: 5CFCRD.xxxx-04 - Temperature/Humidity diagram for CompactFlash cards

4.4.5 Dimensions

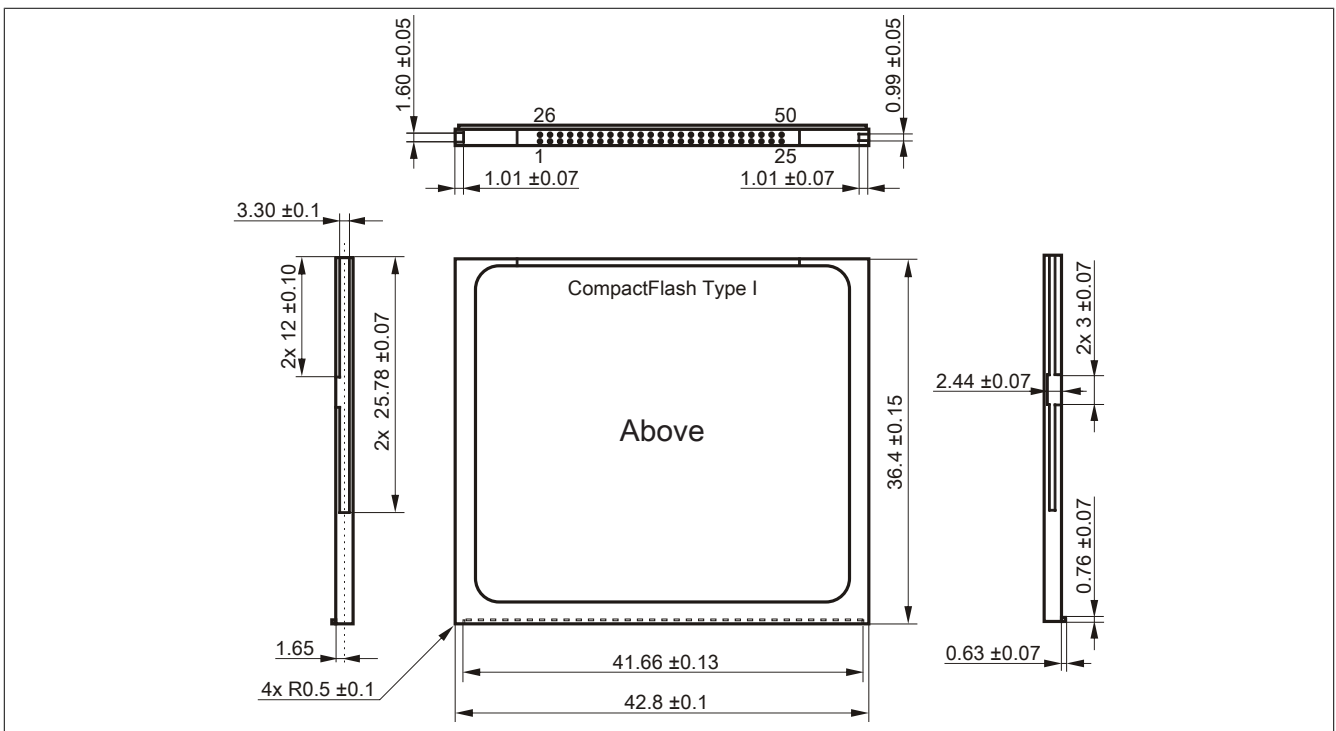

Figure 146: Type I CompactFlash card - Dimensions

4.4.6 Benchmark

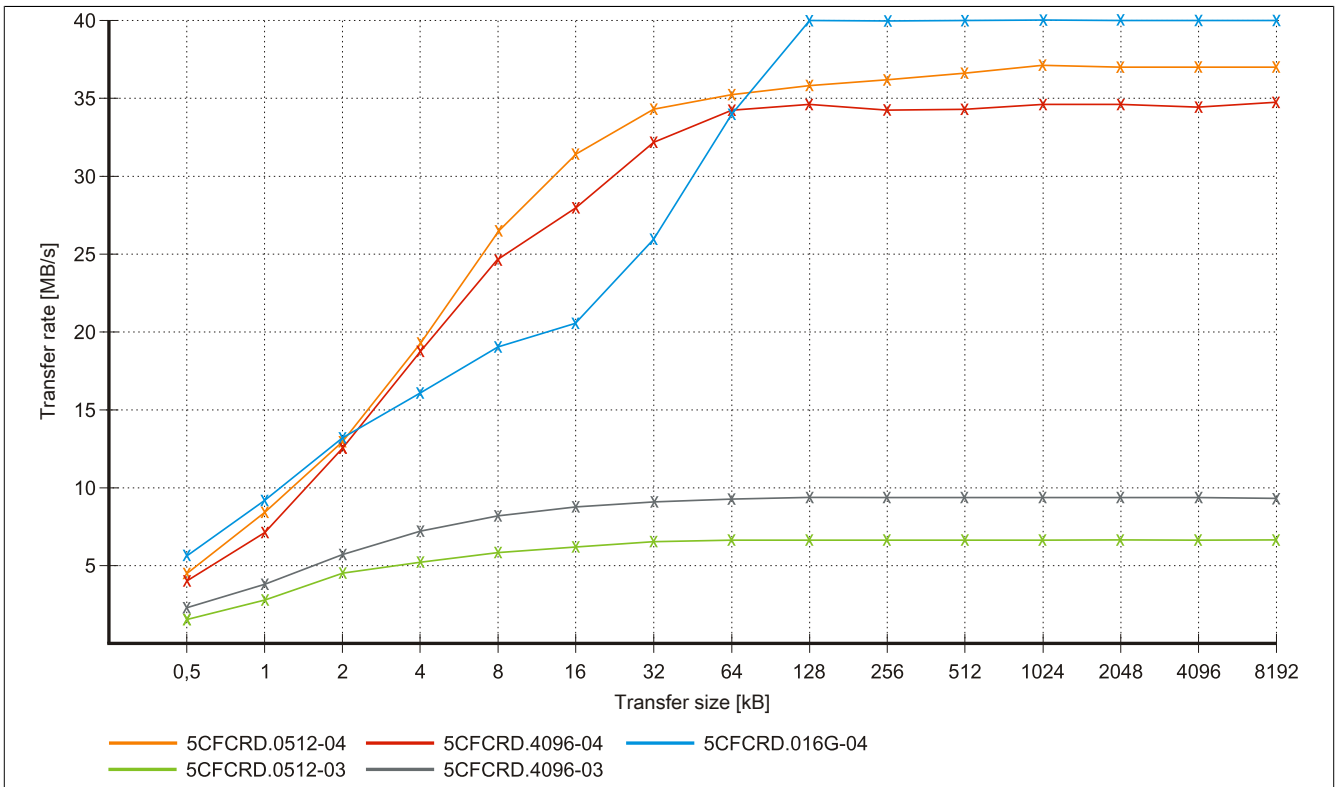

Figure 147: ATTO Disk Benchmark v2.34 read comparison - 5CFCRD.xxxx-03 and 5CFCRD.xxxx-04

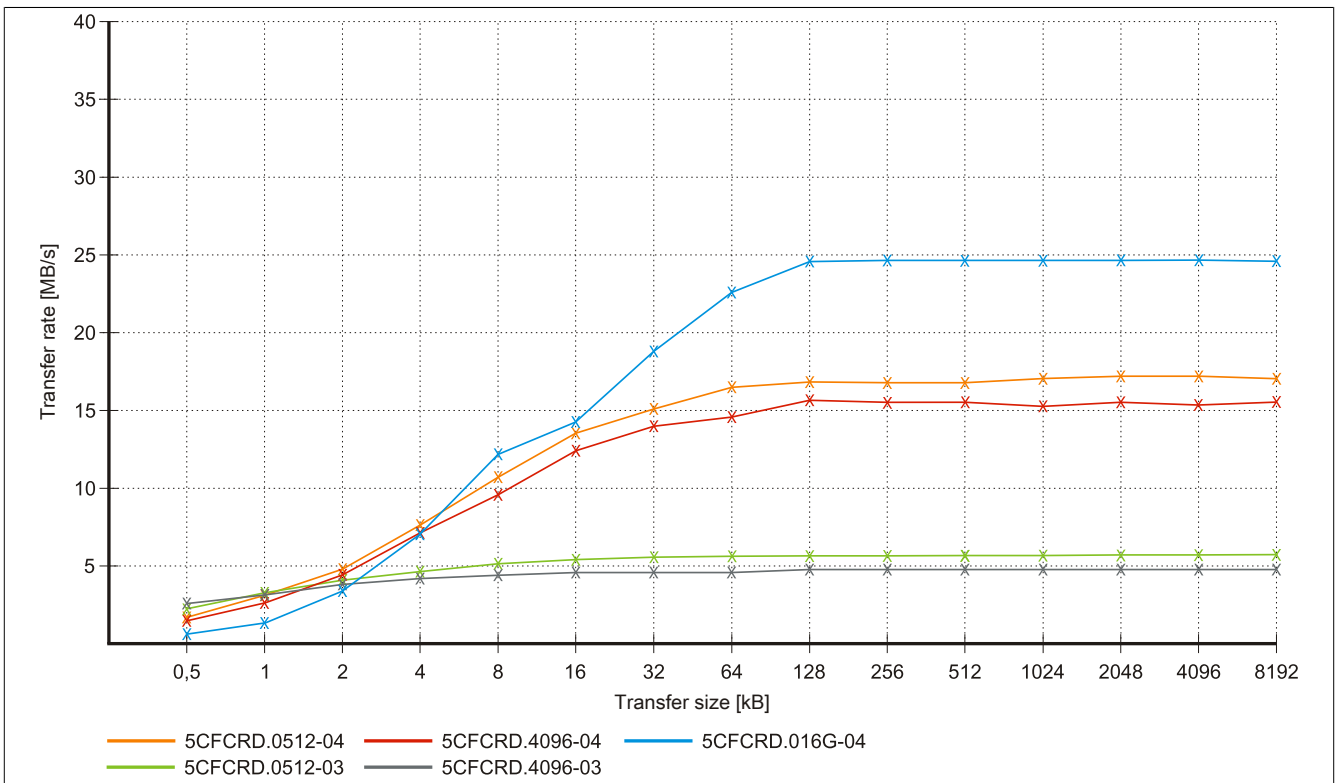

Figure 148: ATTO Disk Benchmark v2.34 write comparison - 5CFCRD.xxxx-03 and 5CFCRD.xxxx-04

4.5 5CFCRD.xxxx-03

4.5.1 General information

Information:

Western Digital CompactFlash cards 5CFCRD.xxxx and CompactFlash cards from a different manufacturer cannot be used in the same system at the same time. Due to differences in technology (older vs. newer technologies), problems can occur during system startup that are caused by different boot times.

see "Known problems/issues" on page 268

Information:

On Windows CE 5.0 devices, 5CFCRD.xxxx-03 CompactFlash cards up to 1 GB are supported.

Information:

On CompactFlash cards 5CFCRD.xxxx-03, only the sticker and the description have changed. The technical data has not been changed.

4.5.2 Order data

Model number	Short description	Figure
	CompactFlash cards	
5CFCRD.0064-03	CompactFlash 64 MB Western Digital (SLC)	
5CFCRD.0128-03	CompactFlash 128 MB Western Digital (SLC)	
5CFCRD.0256-03	CompactFlash 256 MB Western Digital (SLC)	
5CFCRD.0512-03	CompactFlash 512 MB Western Digital (SLC)	
5CFCRD.1024-03	CompactFlash 1 GB Western Digital (SLC)	
5CFCRD.2048-03	CompactFlash 2 GB Western Digital (SLC)	
5CFCRD.4096-03	CompactFlash 4 GB Western Digital (SLC)	
5CFCRD.8192-03	CompactFlash 8 GB Western Digital (SLC)	

Table 199: 5CFCRD.0064-03, 5CFCRD.0128-03, 5CFCRD.0256-03, 5CFCRD.0512-03, 5CFCRD.1024-03, 5CFCRD.2048-03, 5CFCRD.4096-03, 5CFCRD.8192-03 - Order data

4.5.3 Technical data

Caution!

A sudden loss of power may result in data loss! In very rare cases, the mass storage device may also become damaged.

To prevent damage and loss of data, B&R recommends that you use a UPS device.

Information:

The following characteristics, features and limit values only apply to this accessory and can deviate from those specified for the complete system. The data specifications for the complete system take precedence over those of individual components.

Product ID	5CFCRD.0064-03	5CFCRD.0128-03	5CFCRD.0256-03	5CFCRD.0512-03	5CFCRD.1024-03	5CFCRD.2048-03	5CFCRD.4096-03	5CFCRD.8192-03
General information								
Capacity	64 MB	128 MB	256 MB	512 MB	1 GB	2 GB	4 GB	8 GB
Data retention	10 years							
Data reliability	<1 unrecoverable error in 10 ¹⁴ bit read accesses							
Lifetime monitoring	Yes							

Table 200: 5CFCRD.0064-03, 5CFCRD.0128-03, 5CFCRD.0256-03, 5CFCRD.0512-03, 5CFCRD.1024-03, 5CFCRD.2048-03, 5CFCRD.4096-03, 5CFCRD.8192-03 - Technical data

Accessories • CompactFlash cards

Product ID	5CFCRD.0064-03	5CFCRD.0128-03	5CFCRD.0256-03	5CFCRD.0512-03	5CFCRD.1024-03	5CFCRD.2048-03	5CFCRD.4096-03	5CFCRD.8192-03
MTBF	>4,000,000 hours (at 25°C)							
Maintenance	None							
Supported operating modes	PIO Mode 0-4, Multiword DMA Mode 0-2							
Sequential read Typical	8 MB/s							
Sequential write Typical	6 MB/s							
Certification CE cULus GOST-R GL	Yes Yes Yes Yes ¹⁾							
Endurance								
SLC flash	Yes							
Clear/Write cycles Typical	>2,000,000							
Wear leveling	Static							
Error correction coding (ECC)	Yes							
S.M.A.R.T. support	No							
Support								
Hardware	MP100/200, PP100/200, PP300/400, PP500, PPC300, PPC700, PPC725, PPC800, Provit 2000, Provit 5000, APC620, APC680, APC810, APC820							
Operating systems								
Windows 7 32-bit	No							
Windows 7 64-bit	No							
Windows Embedded Standard 7, 32-bit	No	No	No	No	No	No	No	Yes
Windows Embedded Standard 7, 64-bit	No							
Windows XP Professional	No	No	No	No	No	No	Yes	Yes
Windows XP Embedded	No	No	No	Yes	Yes	Yes	Yes	Yes
Windows Embedded Standard 2009	No	No	No	No	Yes	Yes	Yes	Yes
Windows CE 6.0	Yes	Yes	Yes	Yes	Yes	Yes	Yes	Yes ²⁾
Windows CE 5.0	Yes	Yes	Yes	Yes	Yes	No	No	No
Software								
PVI Transfer	≥V2.57 (part of PVI Development Setup ≥ V2.5.3.3005)							
B&R Embedded OS Installer	≥V2.21							
Environmental conditions								
Temperature								
Operation	0 to 70°C							
Storage	-50 to 100°C							
Transport	-50 to 100°C							
Relative humidity								
Operation	8 to 95%, non-condensing							
Storage	8 to 95%, non-condensing							
Transport	8 to 95%, non-condensing							
Vibration								
Operation	Max. 16.3 g (159 m/s ² 0-peak)							
Storage	Max. 30 g (294 m/s ² 0-peak)							
Transport	Max. 30 g (294 m/s ² 0-peak)							
Shock								
Operation	Max. 1000 g (9810 m/s ² 0-peak)							
Storage	Max. 3000 g (29430 m/s ² 0-peak)							
Transport	Max. 3000 g (29430 m/s ² 0-peak)							
Elevation								
Operation	Max. 24383 m							
Mechanical characteristics								
Dimensions								
Width	42.8 ±0.10 mm							
Length	36.4 ±0.15 mm							
Height	3.3 ±0.10 mm							
Weight	11.4 g							

Table 200: 5CFCRD.0064-03, 5CFCRD.0128-03, 5CFCRD.0256-03, 5CFCRD.0512-03, 5CFCRD.1024-03, 5CFCRD.2048-03, 5CFCRD.4096-03, 5CFCRD.8192-03 - Technical data

- 1) Yes, although applies only if all components installed within the complete system have this certification
- 2) Not supported by the B&R Embedded OS Installer.

4.5.4 Temperature/Humidity diagram

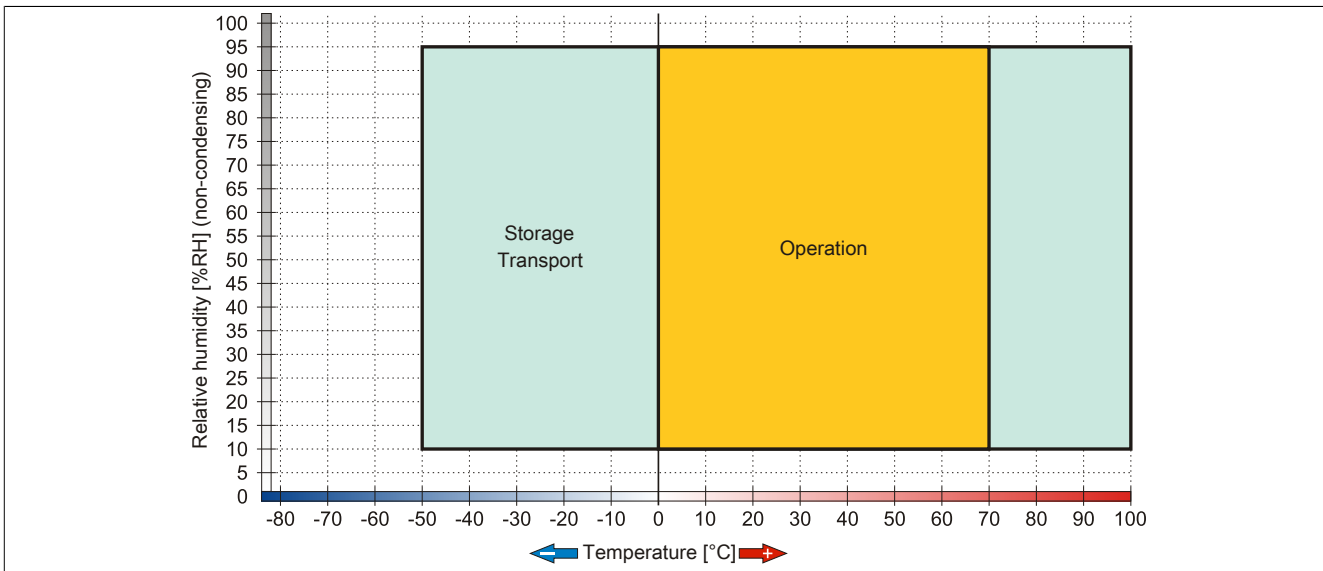

Figure 149: 5CFCRD.xxxx-03 - Temperature/Humidity diagram for CompactFlash cards

4.5.5 Dimensions

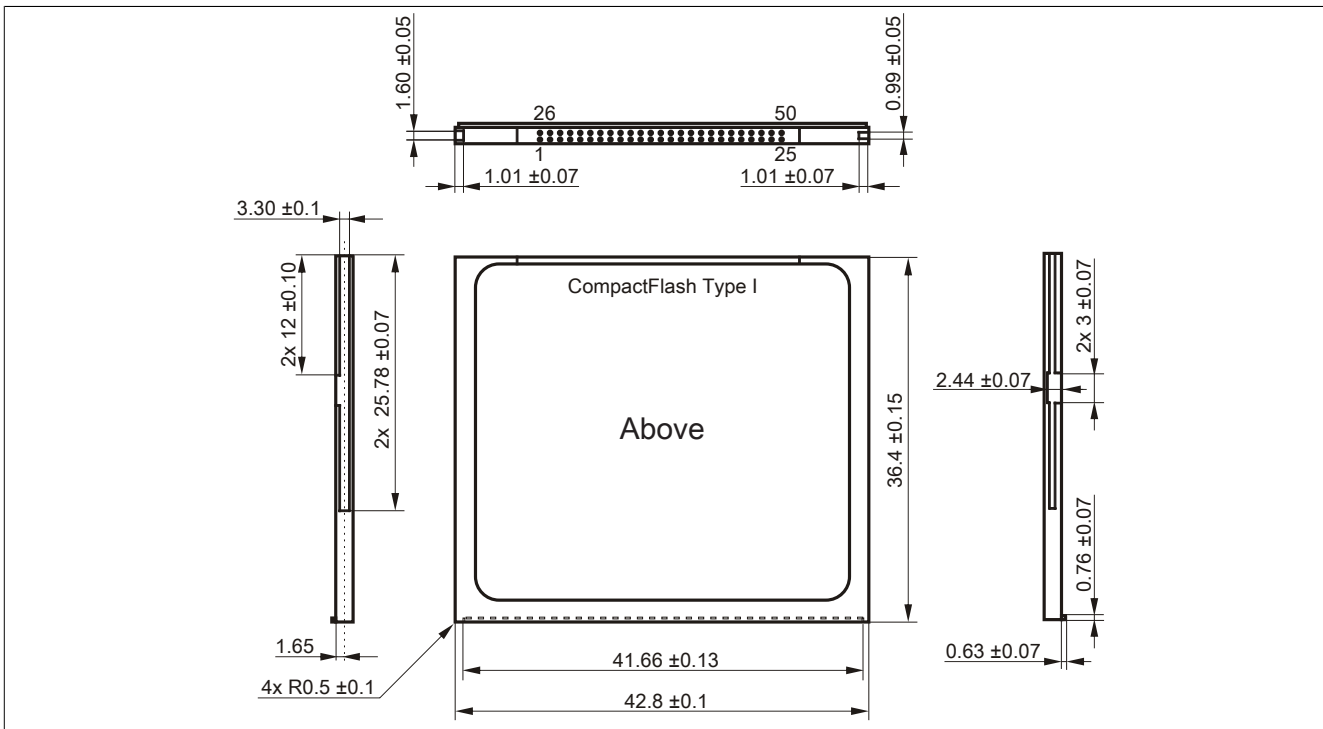

Figure 150: Type I CompactFlash card - Dimensions

4.6 Known problems/issues

The following is a known issue for devices with two CompactFlash slots:

- Using two different types of CompactFlash cards can cause problems with Automation PCs and Panel PCs. For example, it is possible that one of the two cards is not detected during system startup. This is caused by different startup speeds. CompactFlash cards with older technology require significantly more time during system startup than CompactFlash cards with newer technology. This behavior occurs near the end of the time frame provided for startup. The problem described can occur because the startup time for the CompactFlash cards fluctuates due to the different components being used. Depending on the CompactFlash card being used, this error might never, sometimes or always occur.

5 USB media drive

5.1 5MD900.USB2-02

5.1.1 General information

The USB media drive is equipped with a DVD-R/RW DVD+R/RW drive, CompactFlash slot and one USB interface on both the front and back.

- Desktop or cabinet-mounted operation (mounting rail brackets)
- Integrated DVD-R/RW DVD+R/RW drive
- Integrated IDE/ATAPI CompactFlash slot (hot pluggable)
- Integrated USB 2.0 connection
- +24 VDC supply (back)
- USB 2.0 connection (back)
- Optional front cover

5.1.2 Order data

Model number	Short description	Figure
USB accessories		
5MD900.USB2-02	USB 2.0 drive combination - DVD-R/RW, DVD+R/RW - CompactFlash slot	
Required accessories		
Other		
5SWUTI.0000-00	OEM Nero CD-RW Software, only available with a CD writer.	
Terminal blocks		
0TB103.9	Connector 24 VDC - 3-pin female - Screw clamps 3.31 mm ²	
0TB103.91	Connector 24 VDC - 3-pin female - Cage clamps 3.31 mm ²	
USB cables		
5CAUSB.0018-00	USB 2.0 connection cable type A - type B, 1.8 m	
5CAUSB.0050-00	USB 2.0 connection cable type A - type B, 5 m	

Table 201: 5MD900.USB2-02 - Order data

5.1.3 Interfaces

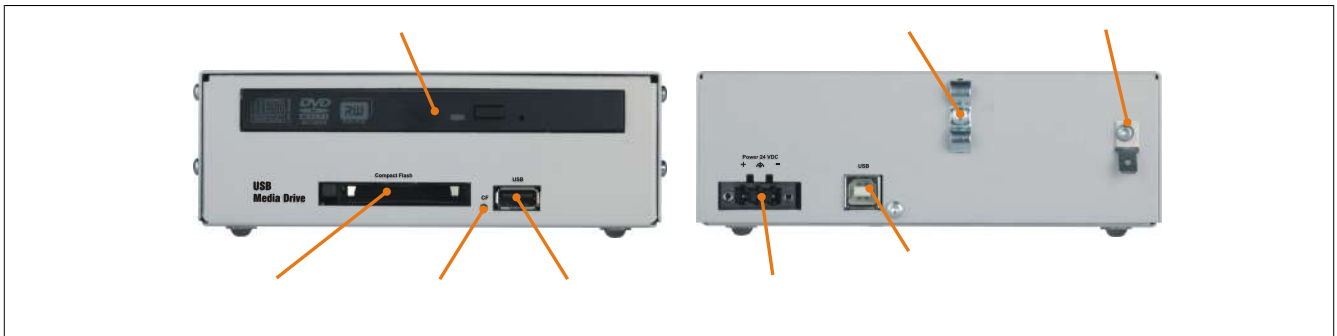

5.1.4 Technical data

Product ID	5MD900.USB2-02
General information	
Max. cable length	5 m (without hub)
Certification	
CE	Yes
cULus	Yes
GOST-R	Yes
Interfaces	
CompactFlash slot 1	
Type	Type I
Connection	IDE/ATAPI
Activity LED	Signals read or write access to an inserted CompactFlash card

Table 202: 5MD900.USB2-02 - Technical data

Product ID	5MD900.USB2-02
USB	
Type	USB 2.0
Design	Type A front Type B back
Transfer rate	Low speed (1.5 Mbit/s), full speed (12 Mbit/s), high speed (480 Mbit/s)
Current load	Max. 500 mA
CD / DVD drive	
Data buffer capacity	2 MB
Data transfer rate	Max. 33.3 MB/s
Speed	Max. 5090 rpm ±1%
Noise level	Approx. 45 dBA at a distance of 50 cm (full read access)
Compatible formats	CD-DA, CD-ROM mode 1/mode 2 CD-ROM XA mode 2 (form 1, form 2) Photo CD (single-/multi-session), Enhanced CD, CD text DVD-ROM, DVD-R, DVD-RW, DVD-Video DVD-RAM (4.7GB, 2.6GB) DVD+R, DVD+R (dual layer), DVD+RW
Laser class	Class 1 laser
Service life	60000 POH (power-on hours)
Interface	IDE (ATAPI)
Startup time	
CD	Max. 14 seconds (from 0 rpm to read operation)
DVD	Max. 15 seconds (from 0 rpm to read operation)
Access time	
CD	Typ. 140 ms (24x)
DVD	Typ. 150 ms (8x)
Readable media	
CD	CD/CD-ROM (12 cm, 8 cm), CD-R, CD-RW
DVD	DVD-ROM, DVD-R, DVD-RW, DVD-RAM, DVD+R, DVD+R (dual layer), DVD+RW
Writable media	
CD	CD-R, CD-RW
DVD	DVD-R/RW, DVD-RAM (4.7 GB), DVD+R/RW, DVD+R (dual layer)
Read speed	
CD	24x
DVD	8x
Write speed	
CD-R	10 to 24x
CD-RW	10 to 24x
DVD+R	3.3 to 8x
DVD+R (dual layer)	2.4 to 4x
DVD+RW	3.3 to 8x
DVD-R	2 to 6x
DVD-R (dual layer)	2 to 4x
DVD-RAM	3 to 5x
DVD-RW	2 to 6x
Write methods	
CD	Disk at once, session at once, packet write, track at once
DVD	Disk at once, incremental, overwrite, sequential
Electrical characteristics	
Nominal voltage	24 VDC ±25%
Operating conditions	
EN 60529 protection	Front: IP65 (only with optional front cover), back: IP20
Environmental conditions	
Temperature ¹⁾	
Operation	5 to 45°C
Storage	-20 to 60°C
Transport	-40 to 60°C
Relative humidity	
Operation	20 to 80%
Storage	5 to 90%
Transport	5 to 95%
Vibration	
Operation	5 to 500 Hz: 0.3 g (2.9 m/s ² 0-peak)
Storage	10 to 100 Hz: 2 g (19.6 m/s ² 0-peak)
Transport	10 to 100 Hz: 2 g (19.6 m/s ² 0-peak)
Shock	
Operation	5 g, 11 ms
Storage	60 g, 11 ms
Transport	60 g, 11 ms
Elevation	
Operation	Max. 3000 m

Table 202: 5MD900.USB2-02 - Technical data

Product ID	5MD900.USB2-02
Mechanical characteristics	
Dimensions	
Width	156 mm
Height	52 mm
Depth	140 mm
Weight	Approx. 1100 g (without front cover)

Table 202: 5MD900.USB2-02 - Technical data

- 1) Temperature specifications refer to operation at 500 meters. The maximum ambient temperature is typically derated by 1°C per 1000 meters (starting at 500 meters above sea level).

5.1.5 Dimensions

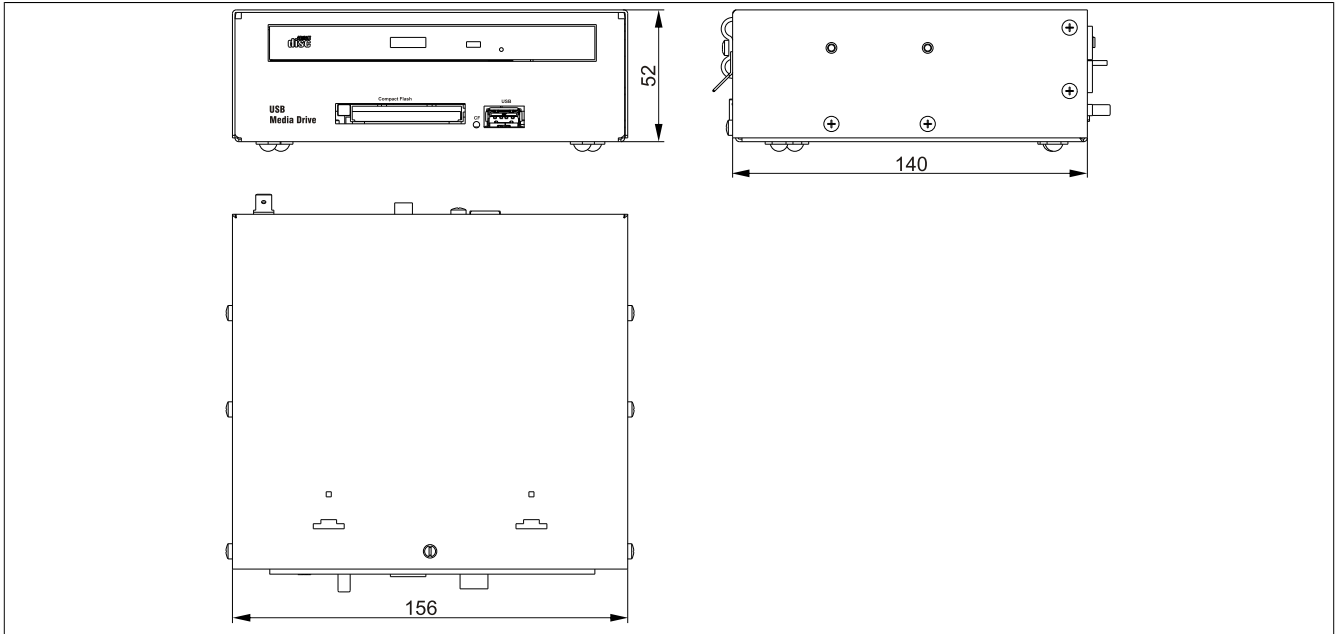

Figure 151: 5MD900.USB2-02 - Dimensions

5.1.6 Dimensions with front cover

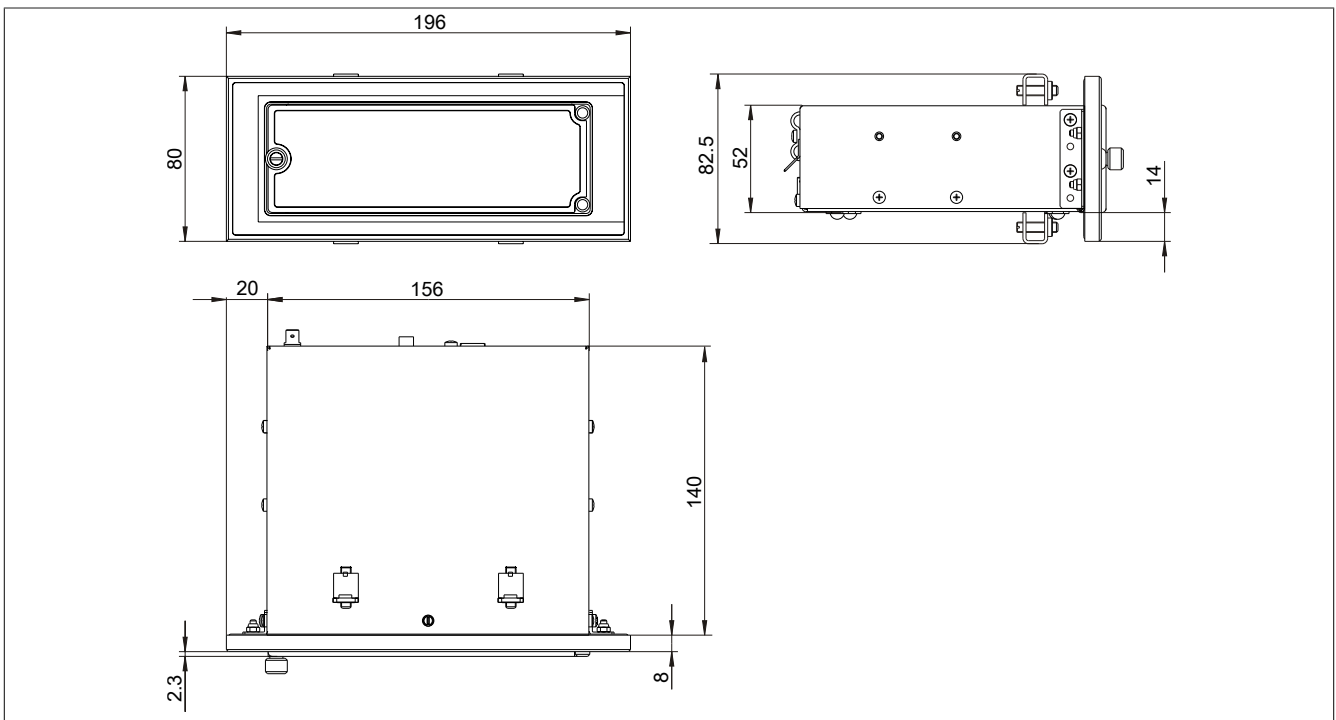

Figure 152: USB media drive with front cover - Dimensions

5.1.7 Cutout installation

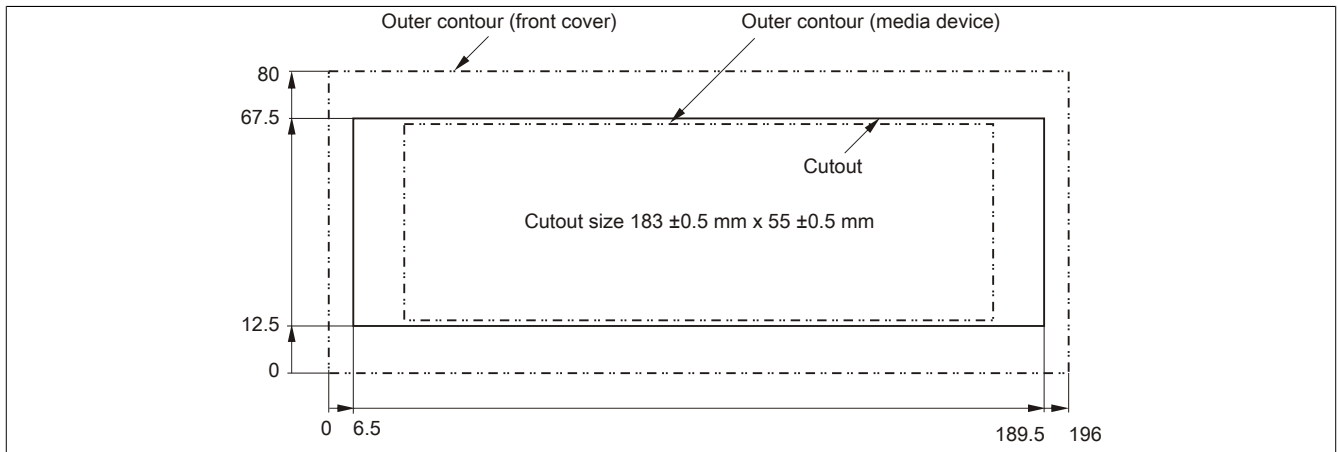

Figure 153: USB media drive with front cover - Installation cutout

5.1.8 Content of delivery

Quantity	Component
1	USB media drive
2	Mounting rail brackets

Table 203: 5MD900.USB2-02 - Content of delivery

5.1.9 Installation

The USB media drive can be operated as a desktop device (rubber feet) or cabinet-mounted device (2 mounting rail brackets included).

5.1.9.1 Mounting orientations

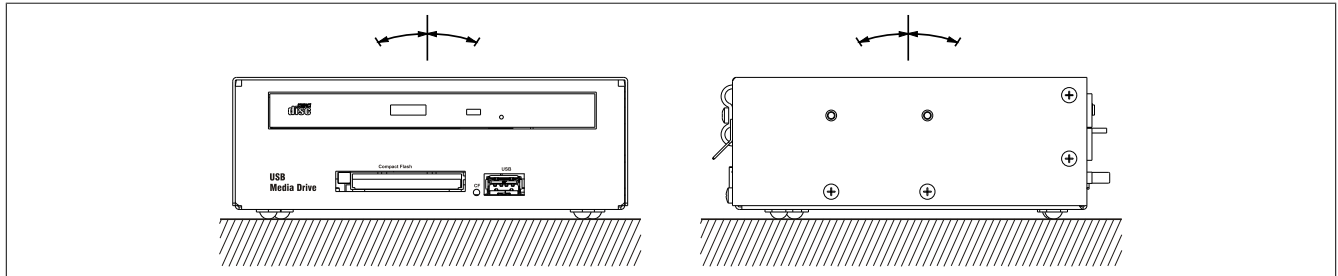

Figure 154: 5MD900.USB2-02 - Mounting orientation

5.2 5A5003.03

5.2.1 General information

This front cover can be mounted on the front of the USB media drive (model number 5MD900.USB2-00, 5MD900.USB2-01 or 5MD900.USB2-02) to protect the interface.

5.2.2 Order data

Model number	Short description	Figure
	USB accessories	
5A5003.03	Front cover for drives - 5A5003.02 - 5MD900.USB2	

Table 204: 5A5003.03 - Order data

5.2.3 Technical data

Product ID	5A5003.03
General information	
Certification	
CE	Yes
cULus	Yes
GOST-R	Yes
Mechanical characteristics	
Front	
Panel overlay	
Light background	Similar to Pantone 427CV
Dimensions	
Width	196 mm
Height	80 mm
Depth	8 mm

Table 205: 5A5003.03 - Technical data

5.2.4 Dimensions

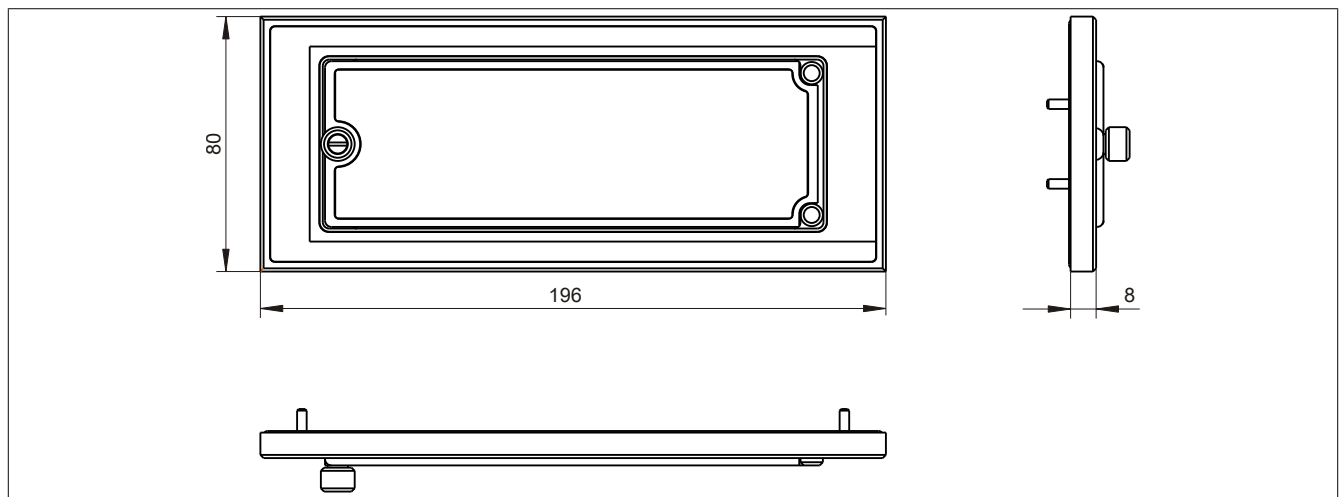

Figure 155: 5A5003.03 - Dimensions

5.2.5 Content of delivery

Quantity	Component
1	Front cover 5A5003.03 for the USB media drive
4	M3 locknut
4	Cover retaining clip

Table 206: 5A5003.03 - Content of delivery

5.2.6 Installation

The front cover is attached with 2 mounting rail brackets (included with the USB media drive) and 4 M3 locknuts. The 4 retaining clips provided can be used to mount the USB media drive and front cover as a whole, for example in a control cabinet door.

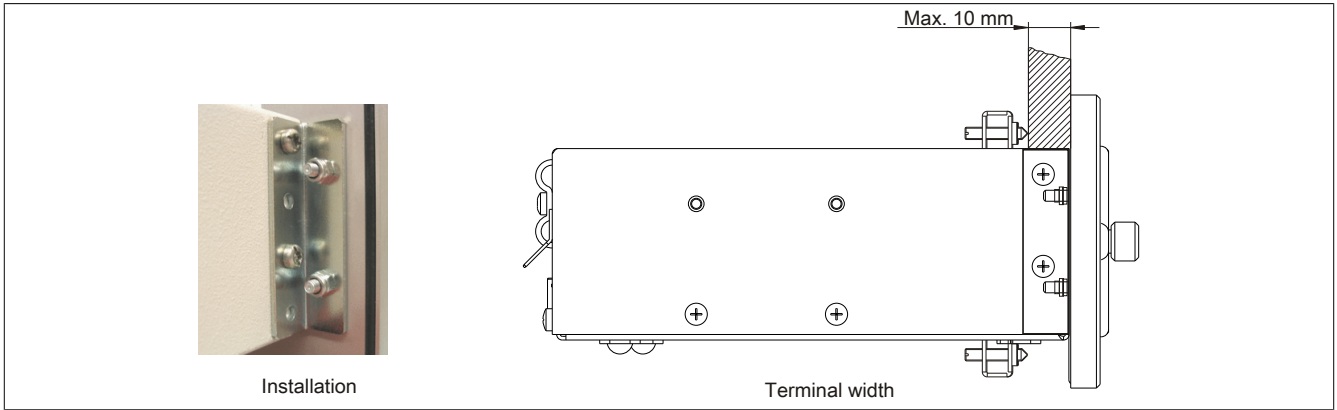

Figure 156: Front cover mounting and installation depth

5.2.6.1 Cutout installation

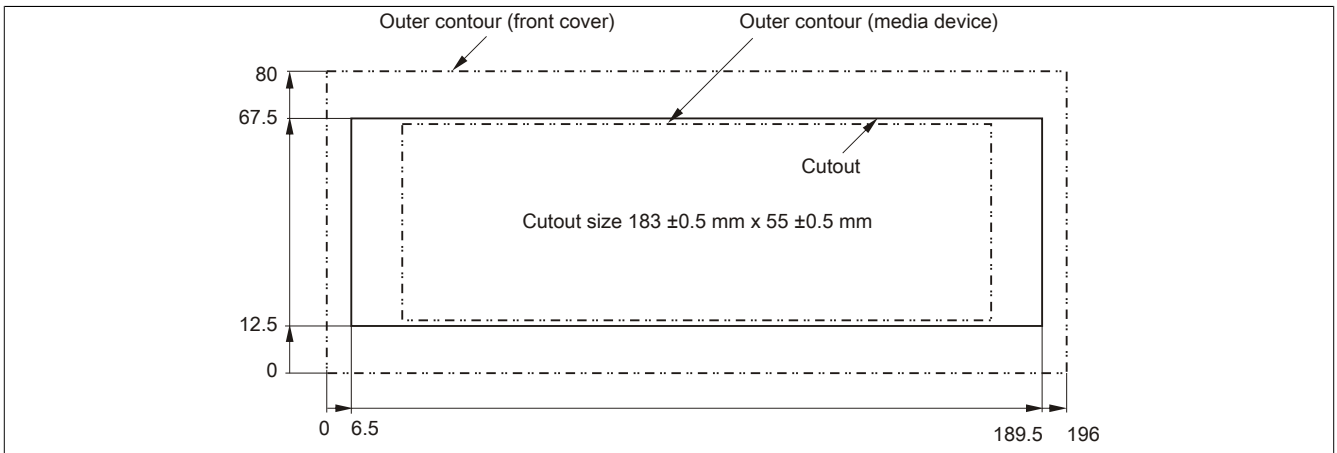

Figure 157: USB media drive with front cover - Installation cutout

6 USB flash drives

6.1 5MMUSB.xxxx-01

6.1.1 General information

USB flash drives are storage media that are easy to exchange. Because of their high-speed data transfer (USB 2.0), USB flash drives are ideal for use as portable data storage. Without requiring additional drivers ("hot plugging", except in the case of Windows 98SE), the USB flash drive can immediately act as an additional drive for reading or writing data.

Information:

Due to the large number of USB flash drives available on the market as well as their short product life cycle, we reserve the right to supply alternative products at any time. The following measures may therefore be necessary in order to boot from these flash drives as well:

- The flash drive must be reformatted or in some cases even repartitioned (set active partition).
- The flash drive must be the first bootable device in the BIOS boot order; alternatively, the IDE controllers can be disabled in BIOS. This can be avoided in most cases if the "fdisk /mbr" command is additionally executed on the USB flash drive.

6.1.2 Order data

Model number	Short description	Figure
	USB accessories	
5MMUSB.2048-01	USB 2.0 flash drive, 2048 MB, B&R	
5MMUSB.4096-01	USB 2.0 flash drive, 4096 MB, B&R	

Table 207: 5MMUSB.2048-01, 5MMUSB.4096-01 - Order data

6.1.3 Technical data

Product ID	5MMUSB.2048-01	5MMUSB.4096-01
General information		
Capacity	2 GB	4 GB
LED status indicators	1 LED (green) ¹⁾	
MTBF	>3,000,000 hours	
Type	USB 1.1, USB 2.0	
Maintenance	None	
Default file system	FAT16	FAT32
Certification		
CE	Yes	
GOST-R	Yes	
Interfaces		
USB		
Type	USB 1.1, USB 2.0	
Connection	To any USB type A interface	
Transfer rate	Low speed (1.5 Mbit/s), full speed (12 Mbit/s), high speed (480 Mbit/s)	
Sequential reading	Full speed max. 1 MB/s, high speed max. 32 MB/s	
Sequential writing	Full speed max. 0.9 MB/s, high speed max. 23 MB/s	
Endurance		
SLC flash	Yes	
Data retention	>10 years	
Data reliability	<1 unrecoverable error in 10 ¹⁴ bit read accesses	
Connection cycles	>1,500	
Support		
Operating systems		
Windows 7	Yes	
Windows XP Professional	Yes	
Windows XP Embedded	Yes	
Windows ME	Yes	
Windows 2000	Yes	
Windows CE 5.0	Yes	
Windows CE 4.2	Yes	

Table 208: 5MMUSB.2048-01, 5MMUSB.4096-01 - Technical data

Product ID	5MMUSB.2048-01	5MMUSB.4096-01
Electrical characteristics		
Current consumption	Max. 500 µA sleep mode, max. 120 mA read/write	
Environmental conditions		
Temperature		
Operation	0 to 70°C	
Storage	-50 to 100°C	
Transport	-50 to 100°C	
Relative humidity		
Operation	85%, non-condensing	
Storage	85%, non-condensing	
Transport	85%, non-condensing	
Vibration		
Operation	20 to 2000 Hz: 20 g (peak)	
Storage	20 to 2000 Hz: 20 g (peak)	
Transport	20 to 2000 Hz: 20 g (peak)	
Shock		
Operation	Max. 1500 g (peak)	
Storage	Max. 1500 g (peak)	
Transport	Max. 1500 g (peak)	
Elevation		
Operation	Max. 3048 m	
Storage	Max. 12192 m	
Transport	Max. 12192 m	
Mechanical characteristics		
Dimensions		
Width	17.97 mm	
Length	67.85 mm	
Height	8.35 mm	

Table 208: 5MMUSB.2048-01, 5MMUSB.4096-01 - Technical data

1) Indicates data being transferred (sending and receiving).

6.1.4 Temperature/Humidity diagram

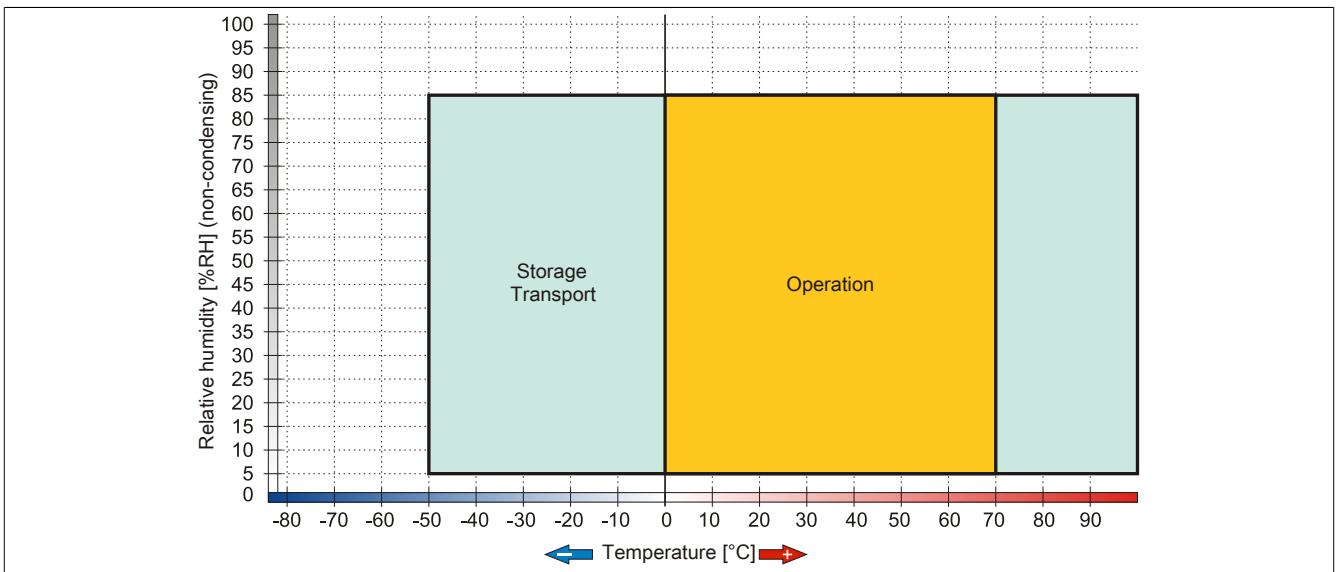

Figure 158: 5MMUSB.xxx-01 - Temperature/Humidity diagram

7 USB interface cover

7.1 5AC900.1201-00

7.1.1 General information

Flat front-side USB interface cover for Automation Panel 900, Power Panel 500, Panel PC 700 and Panel PC 800 devices.

7.1.2 Order data

Model number	Short description	Figure
	Accessories	
5AC900.1201-00	USB interface cover M20 IP65 flat	

Table 209: 5AC900.1201-00 - Order data

7.2 5AC900.1201-01

7.2.1 General information

Round front-side knurled USB interface cover (with anti-loss strap) for Automation Panel 900, Power Panel 500, Panel PC 700 and Panel PC 800 devices.

7.2.2 Order data

Model number	Short description	Figure
	Accessories	
5AC900.1201-01	USB interface cover M20 IP65 curved	

Table 210: 5AC900.1201-01 - Order data

8 Clamping blocks

8.1 5AC900.BLOC-00

8.1.1 General information

These replacement clamping blocks are used to mount B&R panel devices.

8.1.2 Order data

Model number	Short description	Figure
	Accessories	
5AC900.BLOC-00	Terminal block with brackets, 10 pcs.; replacement part	

Table 211: 5AC900.BLOC-00 - Order data

8.2 5AC900.BLOC-01

8.2.1 General information

These replacement clamping blocks are used to mount B&R panel devices.

8.2.2 Order data

Model number	Short description	Figure
	Accessories	
5AC900.BLOC-01	Clamping block without brackets, 10 pcs.; replacement part	

Table 212: 5AC900.BLOC-01 - Order data

9 Retaining clips

9.1 5AC900.CLIP-01

9.1.1 General information

These replacement clips are used to mount B&R panel devices.

9.1.2 Order data

Model number	Short description	Figure
	Accessories	
5AC900.CLIP-01	Plastic retaining clips, 12 pcs.; replacement part	

Table 213: 5AC900.CLIP-01 - Order data

10 Line filter

10.1 5AC804.MFLT-00

10.1.1 General information

The 5AC804.MFLT-00 line filter may be necessary to satisfy requirements regarding conducted disturbances in supply lines in accordance with the 2003 edition of GL EMC1 (Germanischer Lloyd).

The line filter should be installed as close to the end device as possible; the supply line from the end device to the line filter should be kept as short as possible.

10.1.2 Order data

Model number	Short description	Figure
5AC804.MFLT-00	Accessories Line filter	

Table 214: 5AC804.MFLT-00 - Order data

10.1.3 Technical data

Information:

The following characteristics, features and limit values only apply to this accessory and can deviate from those specified for the complete system. The data specifications for the complete system take precedence over those of individual components.

Product ID	5AC804.MFLT-00
General information	
Certification	
CE	Yes
cULus	Yes
cULus HazLoc Class 1 Division 2	Yes ¹⁾
GOST-R	Yes
GL	Yes ²⁾
Terminal block	
Connection cross section	
With wire end sleeves	1.5 mm ²
Flexible	0.2 to 1.5 mm ²
Inflexible	0.2 to 2.5 mm ²
Electrical characteristics	
Nominal voltage	24 VDC -25% / +30%
Nominal current	8 A
Environmental conditions	
Temperature	
Operation	-25 to 65°C
Storage	-25 to 65°C
Transport	-25 to 65°C
Mechanical characteristics	
Housing	
Material	Galvanized steel plate
Dimensions	
Width	54 mm
Length	94 mm
Depth	32.15 mm
Weight	205 g

Table 215: 5AC804.MFLT-00 - Technical data

- 1) Yes, although applies only if all components installed within the complete system have this certification and the complete system itself carries the corresponding mark.
- 2) Yes, although applies only if all components installed within the complete system have this certification

10.1.4 Dimensions

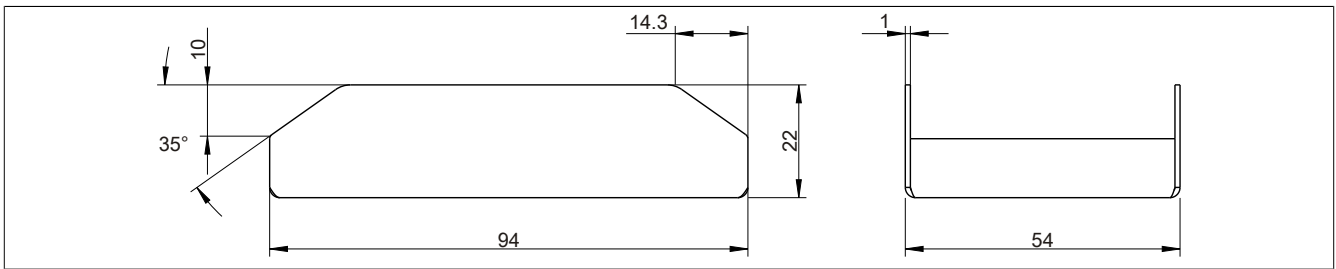

Figure 159: 5AC804.MFLT-00 - Dimensions

10.1.5 Drilling template

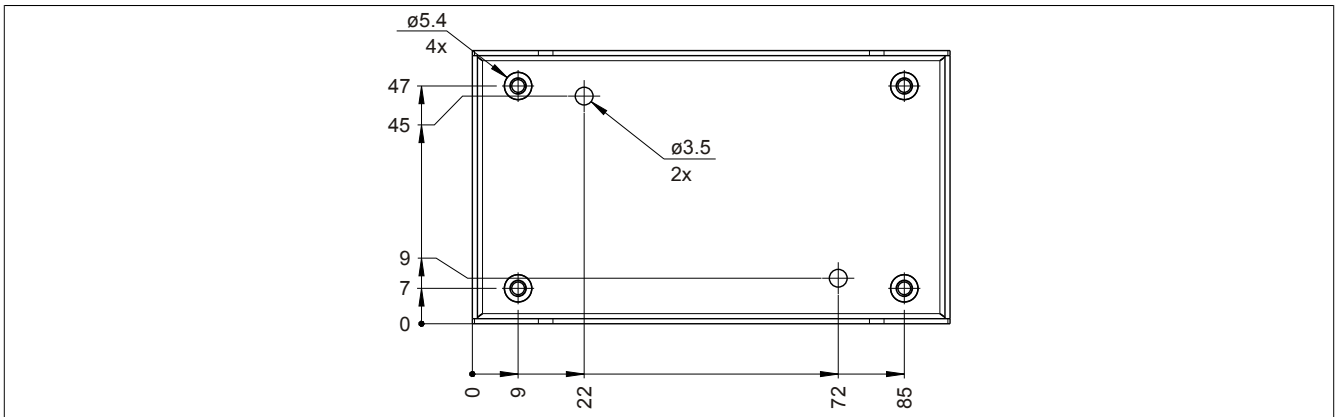

Figure 160: 5AC804.MFLT-00 - Drilling template

10.1.6 Connecting to the end device

The line filter must be connected between the voltage supply and the end device.

The following points must be observed:

- Use shielded, twisted wires.
- Keep the lines as short as possible (voltage supply - line filter - end device).
- The line filter must be installed on an uncoated, oil-free metallic surface.

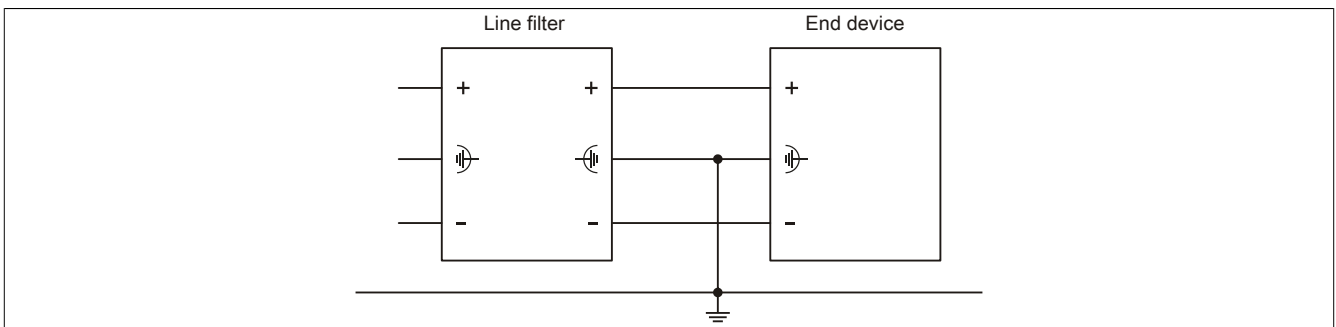

Figure 161: Connection example

Chapter 7 • Maintenance and service

This chapter describes service/maintenance work that can be carried out by a qualified end user.

1 Cleaning

Danger!

This device can only be cleaned when switched off in order to prevent unintended functions from being triggered when handling the touch screen or pressing keys.

This device should be cleaned with a moist cloth. The cloth should be moistened with water and detergent, a screen cleaning agent or alcohol (ethanol). The cleaning agent should be applied to the cloth beforehand, not sprayed directly on the device! Aggressive solvents, chemicals, scouring agents, pressurized air or steam jets should never be used.

Information:

Displays with a touch screen should be cleaned regularly.

2 Replacing the battery

The lithium battery buffers the internal real-time clock (RTC) and CMOS data.

Information:

- The product design allows the battery to be changed with the B&R device switched either on or off. In some countries, safety regulations do not allow batteries to be changed while the module is switched on.
- Any BIOS settings that have been made will remain when the battery is changed with the power turned off (stored in nonvolatile EEPROM). The date and time must be reset later since this data is lost when the battery is changed.
- The battery should only be replaced by qualified personnel.

Warning!

The battery is only permitted to be replaced by a Renata CR2477N battery. The use of another battery may present a risk of fire or explosion.

The battery may explode if handled improperly. Do not recharge, disassemble or dispose of in fire.

The following replacement lithium batteries are available: 4A0006.00-000 (1 pc.) and 0AC201.91 (4 pcs.).

2.1 Evaluating the battery status

The status of the battery is determined immediately after the device is started and subsequently checked by the system every 24 hours. During this measurement, the battery is subjected to a brief load (approximately 1 second) and then evaluated. Once determined, the battery status is displayed in BIOS (Advanced - OEM features - System board features - Voltage values) and in the B&R Control Center (ADI driver); it can also be read in a customer application using the ADI library.

Battery status	Function
N/A	The hardware or firmware being used is too old and does not support reading the battery status.
GOOD	Data buffering is intact.
BAD	From the point when battery capacity is recognized as insufficient (BAD), data buffering is intact for approximately another 500 hours.

Table 216: Battery status

From the point when battery capacity is recognized as insufficient, data buffering is intact for approximately another 500 hours. When replacing the battery, data is buffered for approximately 10 minutes by a gold leaf capacitor.

2.2 Procedure

- Disconnect the power supply to the B&R Industrial PC.
- Touch the housing or ground connection in order to discharge any electrostatic charge from your body.
- Remove the cover from the battery compartment and carefully pull out the battery using the removal strip.

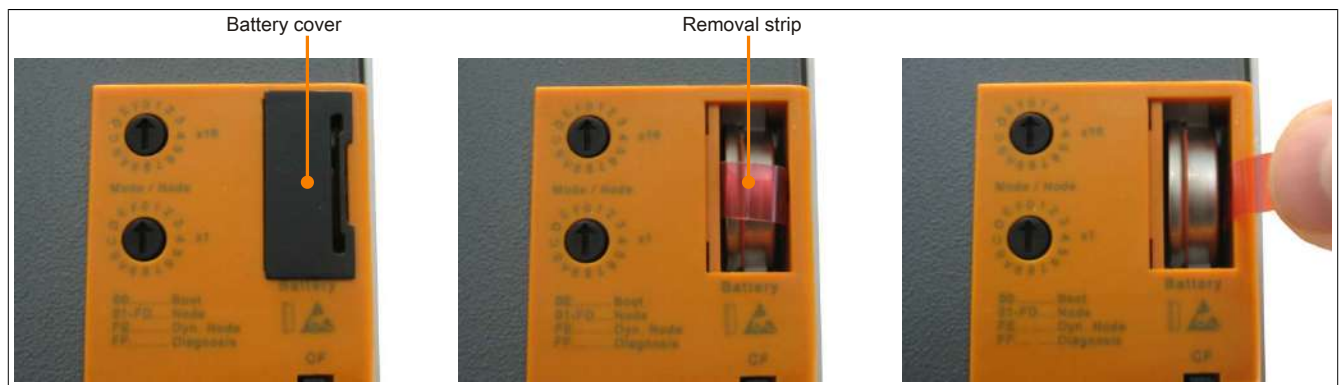

Figure 162: Removing the battery

- The battery should not be held by its edges. Insulated tweezers may also be used to insert the battery.

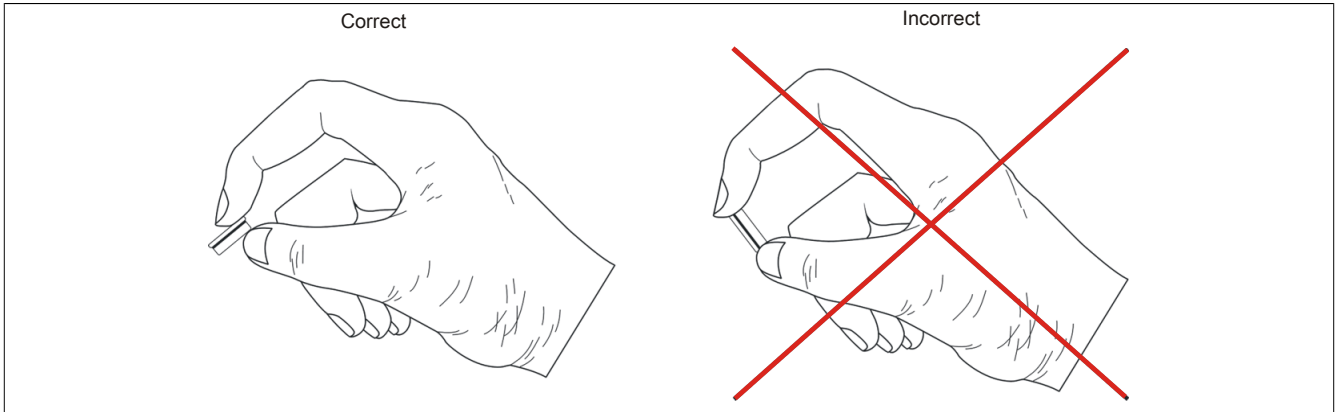

Figure 163: Battery handling

- Insert the new battery with the correct polarity.

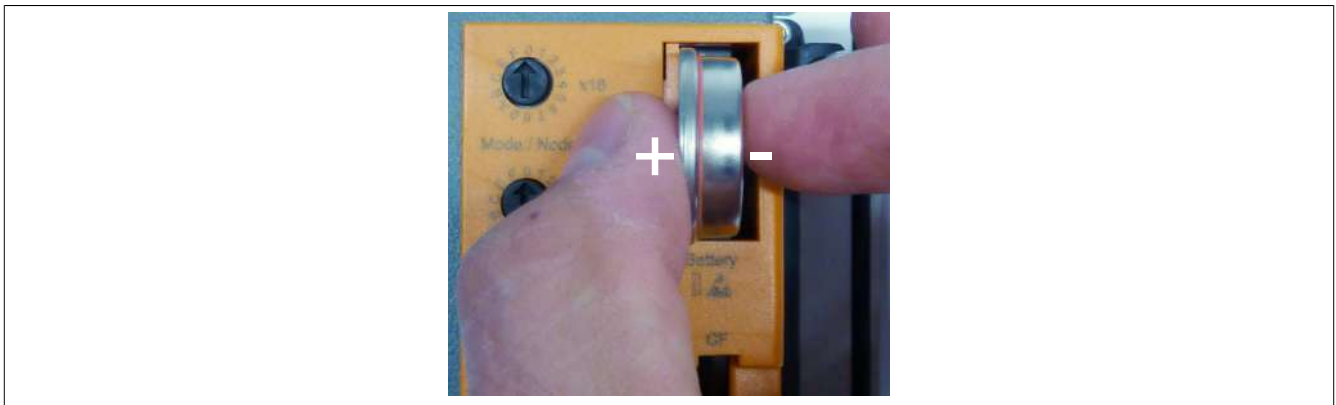

Figure 164: Insert battery

- To make the next battery replacement easier, be sure the removal strip is in place when inserting the battery.
- Reconnect the power supply to the B&R Industrial PC (plug in the power cable).
- Reset the date and time in BIOS.

Warning!

Lithium batteries are considered hazardous waste. Used batteries should be disposed of in accordance with applicable local regulations.

3 Replacing a CompactFlash card

Caution!

Power must be turned off before replacing CompactFlash cards.

The CompactFlash card can be replaced quickly and easily by pressing the ejector (see image) with a pointed object such as a pen.

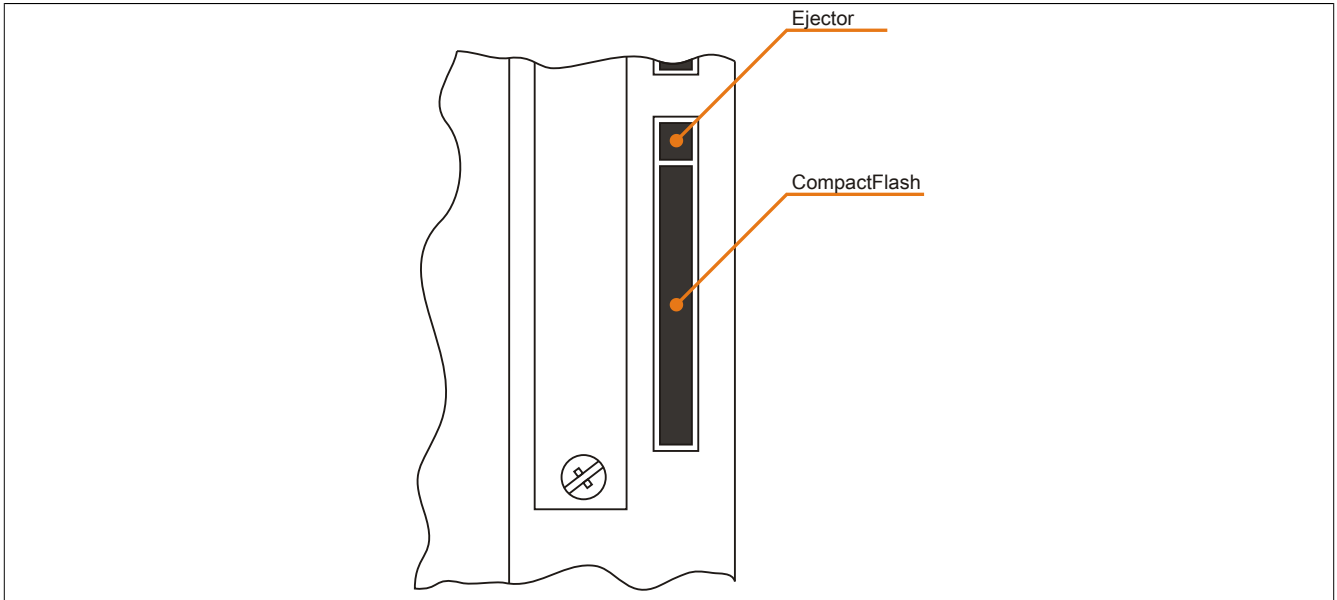

Figure 165: CompactFlash + ejector

Appendix A

1 Maintenance Controller Extended (MTCX)

The MTCX controller (FPGA processor) is located on the CPU board.

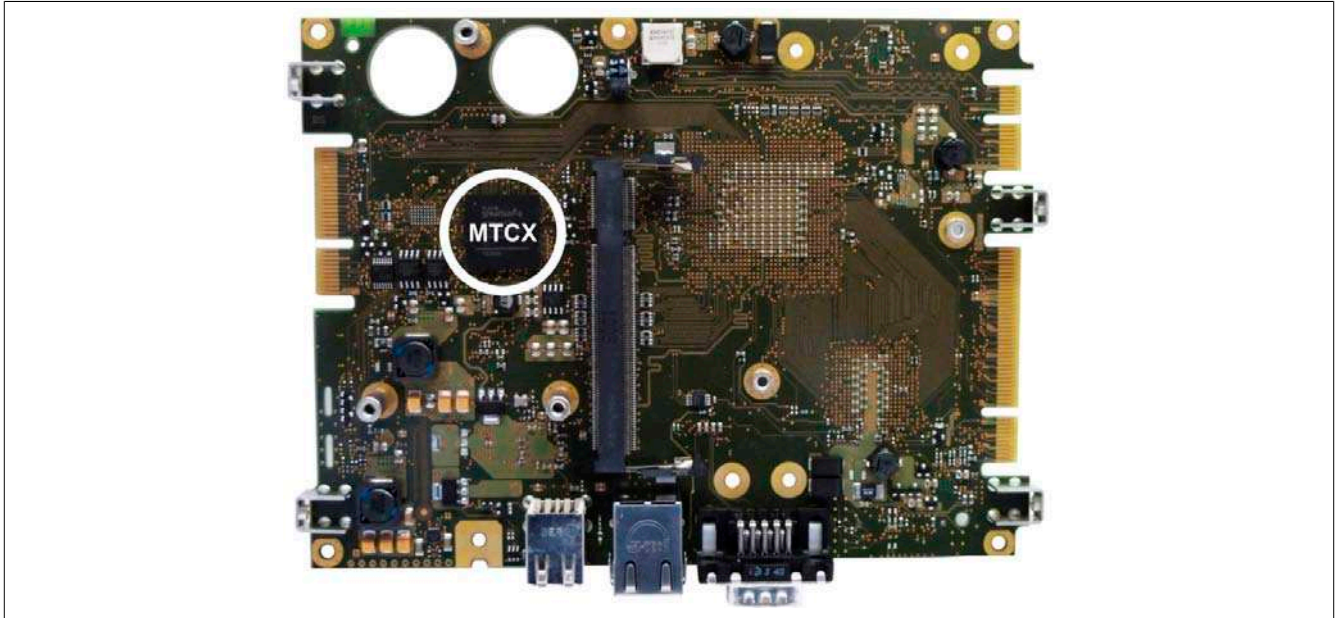

Figure 166: MTCX controller location

The MTCX is responsible for the following monitoring and control functions:

- Power failure logic
- Watchdog handling (NMI and reset handling)
- Temperature monitoring (I/O area, power supply)
- Key and LED handling/coordination
- Advanced desktop operation (keys, USB forwarding)
- Backlight control for the display
- Statistical data recording (power cycles - records every switch-on and power-on; each full hour is counted, i.e. not increased at 50 minutes)
- LED status indicators (Power, CF, Link, Run)

Extended MTCX functions are available by upgrading firmware ⁶⁾. The version can be read in BIOS ("OEM features" on page 159) or approved Microsoft Windows operating systems via the B&R Control Center.

⁶⁾ Available in the Downloads section of the B&R website (www.br-automation.com).

2 5-wire AMT touch screen

2.1 Technical data

Information:

The following characteristics, features and limit values only apply to this individual component and can deviate from those specified for the complete system. For the complete system in which this individual component is used, refer to the data given specifically for that device.

Product ID	5-wire AMT touch screen
General information	
Certification	
CE	Yes
c-UL-us	Yes
Manufacturer	AMT
Release pressure	< 1 N
Light permeability	81 ±3%
Environmental conditions	
Temperature	
Operation	- 20 to 70°C
Storage	- 40 to 80°C
Transport	- 40 to 80°C
Relative humidity	
Operation	90% at max. 50°C
Storage	90% RH at max. 60°C for 504 hours
Transport	90% RH at max. 60°C for 504 hours
Operating conditions	
Service life	36 million touch operations at the same position (release pressure: 250 g, interval: 2x per second)
Chemical resistance ¹⁾	Acetone, methylene chloride, methyl ethyl ketone, isopropyl alcohol, hexane, turpentine, mineral spirits, unleaded gasoline, diesel, motor oil, gear lubricating oil, antifreeze, ammonia-based glass cleaner, chemical cleaning agents, household cleaning agents, vinegar, coffee, tea, lubricant, cooking oil, salt
Enabling driver	Finger, pointer, credit card, glove
	Touch screen drivers for approved operating systems are available in the Downloads section of the B&R website (www.br-automation.com).

Table 217: 5-wire AMT touch screen - Technical data

- 1) The active area of the touch screen is resistant to these chemicals for a period of one hour at 25°C.

2.2 Temperature/Humidity diagram

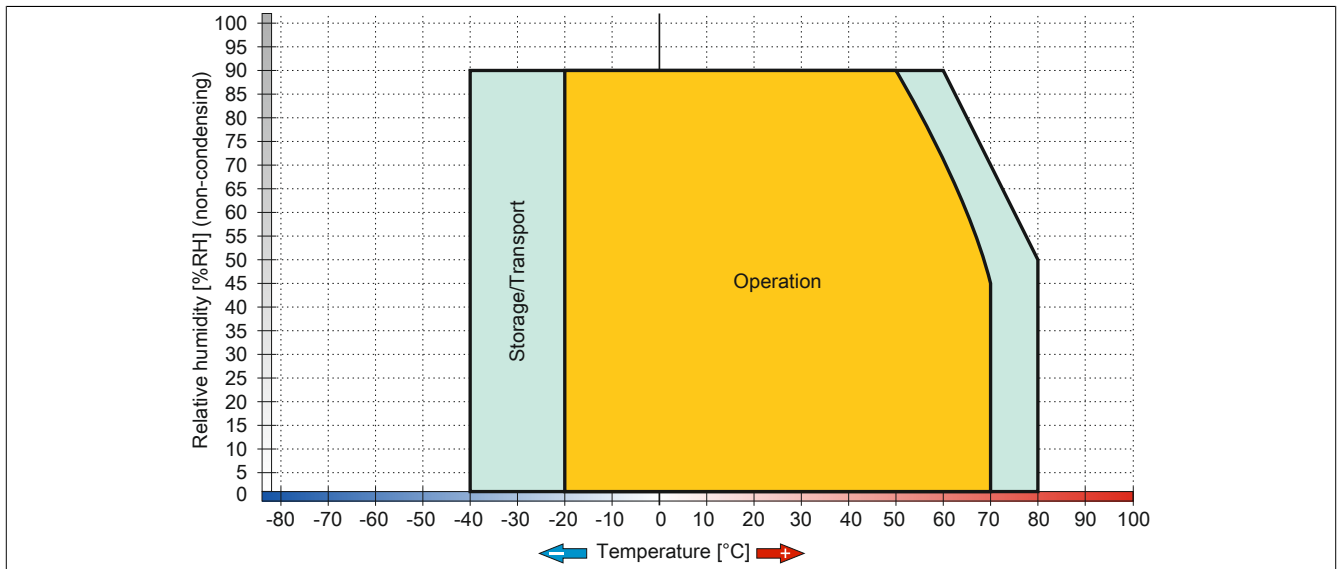

Figure 167: 5-wire AMT touch screen - Temperature/Humidity diagram

2.3 Cleaning

Danger!

This device can only be cleaned when switched off in order to prevent unintended functions from being triggered when handling the touch screen or pressing keys.

This device should be cleaned with a moist cloth. The cloth should be moistened with water and detergent, a screen cleaning agent or alcohol (ethanol). The cleaning agent should be applied to the cloth beforehand, not sprayed directly on the device! Aggressive solvents, chemicals, scouring agents, pressurized air or steam jets should never be used.

Information:

Displays with a touch screen should be cleaned regularly.

3 Panel overlay

The panel overlay conforms to DIN 42115 (Part 2). This means it is resistant to exposure to the following chemicals for a 24-hour period with no visible signs of damage:

Information:

The following characteristics, features and limit values only apply to this individual component and can deviate from those specified for the complete system.

Ethanol Cyclohexanol Diacetone alcohol Glycol Isopropanol Glycerine Methanol Triacetin Dowandol DRM/PM	Formaldehyde 37 to 42% Acetaldehyde Aliphatic hydrocarbons Toluene Xylene White spirits	Trichloroethane Ethyl acetate Diethyl ether N-Butyl acetate Amyl acetate Butylcellosolve Ether
Acetone Methyl ethyl ketone Dioxan Cyclohexanone MIBK Isophorone	Formic acid < 50% Acetic acid < 50% Phosphoric acid < 30% Hydrochloric acid < 36% Nitric acid < 10% Trichloroacetic acid < 50% Sulphuric acid < 10%	Sodium hypochlorite < 20% Hydrogen peroxide < 25% Potassium carbonate Washing agents Tenside Fabric conditioner Ferrous chloride (FeCl ₂) Ferrous chloride (FeCl ₃) Dibutyl phthalate Dioctyl phthalate Sodium carbonate
Ammonia < 40% Caustic soda < 40% Potassium hydroxide Alkali carbonate Bichromate Potassium Acetonitrile Sodium bisulphate	Cutting oil Diesel oil Linseed oil Paraffin oil Blown castor oil Silicon oil Turpentine oil substitute Brake fluid Aviation fuel Gasoline Water Sea water Decon	

Table 218: Chemical resistance of the panel overlay

The panel overlay conforms to DIN 42115 section 2 for exposure to glacial acetic acid for less than one hour without visible damage.

4 Viewing angles

Viewing angle specifications (R, L, U, D) for the display types are listed in the technical data for each device.

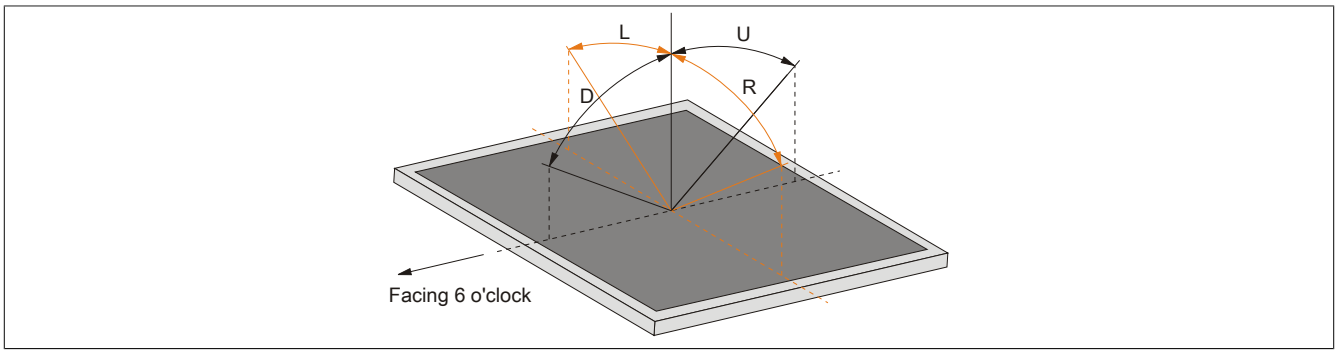

5 Mounting compatibility

This section describes the compatibility of the installation dimensions for Power Panel 100/200, Power Panel 300/400, Power Panel 500, Automation Panel 900, Automation Panel 1000, Automation Panel 700 and Panel PC 800 devices according to device display size.

The outer dimensions of the device types are identical for the respective display sizes.

Information:

The AP1000 device name refers to the Automation Panel 1000 as well as the Panel PC 900 and Panel PC 2100 with a built in AP1000 display unit.

The different device types are abbreviated as follows:

Device type	Abbreviation
Power Panel 100/200	PP100/200
Power Panel 300/400	PP300/400
Power Panel 500	PP500
Automation Panel 900	AP900
Automation Panel 1000	AP1000
Panel PC 700	PPC700
Panel PC 800	PPC800

Table 219: Product abbreviations

5.1 Compatibility overview

The following table provides an overview of PP100/200, PP300/400, PP500, AP900, AP1000, PPC700 and PPC800 devices. Detailed information can be found in the section "Compatibility details".

Information:

Cutout tolerance values for the PP100/200, PP300/400, PP500, AP900, PPC700 and PPC800 are $\pm 0,5$ mm. The cutout tolerance values from the AP1000 are $+0$ mm/ -0.5 mm.

Compatibilities between device types is represented on each line by matching symbols.

Display size	Format		PP100/200	PP300/400	PP500	AP900	AP1000 ¹⁾	PPC700	PPC800
5.7"	Horizontal1	Outer dimensions	■ 212 x 156	■ 212 x 156	■ 212 x 156	-	■ 212 x 156	-	-
		Installation dimensions	● 199 x 143	● 199 x 143	● 199 x 143	-	● 199 x 143	-	-
	Horizontal2	Outer dimensions	■ 302 x 187	■ 302 x 187	■ 302 x 187	-	-	-	-
		Installation dimensions	● 289 x 174	● 289 x 174	● 289 x 174	-	-	-	-
	Vertical1	Outer dimensions	■ 212 x 245	■ 212 x 245	■ 212 x 245	-	■ 212 x 245	-	-
		Installation dimensions	● 199 x 226.8	● 199 x 226.8	▲ 199 x 232	-	▲ 199 x 232	-	-
7"	Horizontal1	Outer dimensions	-	-	■ 212 x 156	-	■ 212 x 156	-	-
		Installation dimensions	-	-	▲ 199 x 143	-	▲ 199 x 143	-	-
10.4"	Horizontal1	Outer dimensions	■ 323 x 260	■ 323 x 260	■ 323 x 260	■ 323 x 260	■ 323 x 260	■ 323 x 260	-
		Installation dimensions	● 303 x 243	● 303 x 243	● 303 x 243	● 303 x 243	● 303 x 243	● 303 x 243	● 303 x 243
	Horizontal2	Outer dimensions	■ 423 x 288	■ 423 x 288	■ 423 x 288	■ 423 x 288	■ 423 x 288	■ 423 x 288	-
		Installation dimensions	● 402 x 266.5	● 402 x 266.5	▲ 403 x 271	□ 402 x 271	▲ 403 x 271	□ 402 x 271	-
	Vertical1	Outer dimensions	■ 323 x 358	■ 323 x 358	■ 323 x 358	■ 323 x 358	■ 323 x 358	■ 323 x 358	-
		Installation dimensions	● 303 x 336	● 303 x 336	▲ 303 x 341	▲ 303 x 341	▲ 303 x 341	▲ 303 x 341	-

Table 220: Device compatibilityoverview

Appendix A • Mounting compatibility

Display size	Format		PP100/200	PP300/400	PP500	AP900	AP1000 ¹⁾	PPC700	PPC800
12.1"	Horizontal1	Outer dimensions	■ 362 x 284	■ 362 x 284	■ 362 x 284	■ 362 x 284	■ 362 x 284	■ 362 x 284	-
		Installation dimensions	● 345 x 267	● 345 x 267	▲ 342 x 267	▲ 342 x 267	▲ 342 x 267	▲ 342 x 267	-
15"	Horizontal1	Outer dimensions	■ 435 x 330	■ 435 x 330	■ 435 x 330	■ 435 x 330	■ 435 x 330	■ 435 x 330	■ 435 x 330
		Installation dimensions	● 415 x 312	● 415 x 312	▲ 415 x 313	● 415 x 312	▲ 415 x 313	● 415 x 312	● 415 x 312
	Vertical1	Outer dimensions	■ 435 x 430	■ 435 x 430	■ 435 x 430	■ 435 x 430	-	■ 435 x 430	-
		Installation dimensions	● 415 x 412	● 415 x 412	▲ 415 x 413	● 415 x 412	-	● 415 x 412	-
17"	Horizontal1	Outer dimensions	-	-	-	■ 477 x 390	-	■ 477 x 390	-
		Installation dimensions	-	-	-	▲ 460 x 373	-	▲ 460 x 373	-
19"	Horizontal1	Outer dimensions	-	-	-	■ 527 x 421	■ 527 x 421	■ 527 x 421	■ 527 x 421
		Installation dimensions	-	-	-	▲ 510 x 404	▲ 510 x 404	▲ 510 x 404	▲ 510 x 404
21.3"	Horizontal1	Outer dimensions	-	-	-	■ 583 x 464	-	-	-
		Installation dimensions	-	-	-	▲ 566 x 447	-	-	-

Table 220: Device compatibility overview

- 1) The AP1000 device name refers to the Automation Panel 1000 as well as the Panel PC 900 and Panel PC 2100 with a built in AP1000 display unit.

5.2 Compatibility details

5.2.1 Example

The dimensions (all in mm) shown in this image apply to the other figures below.

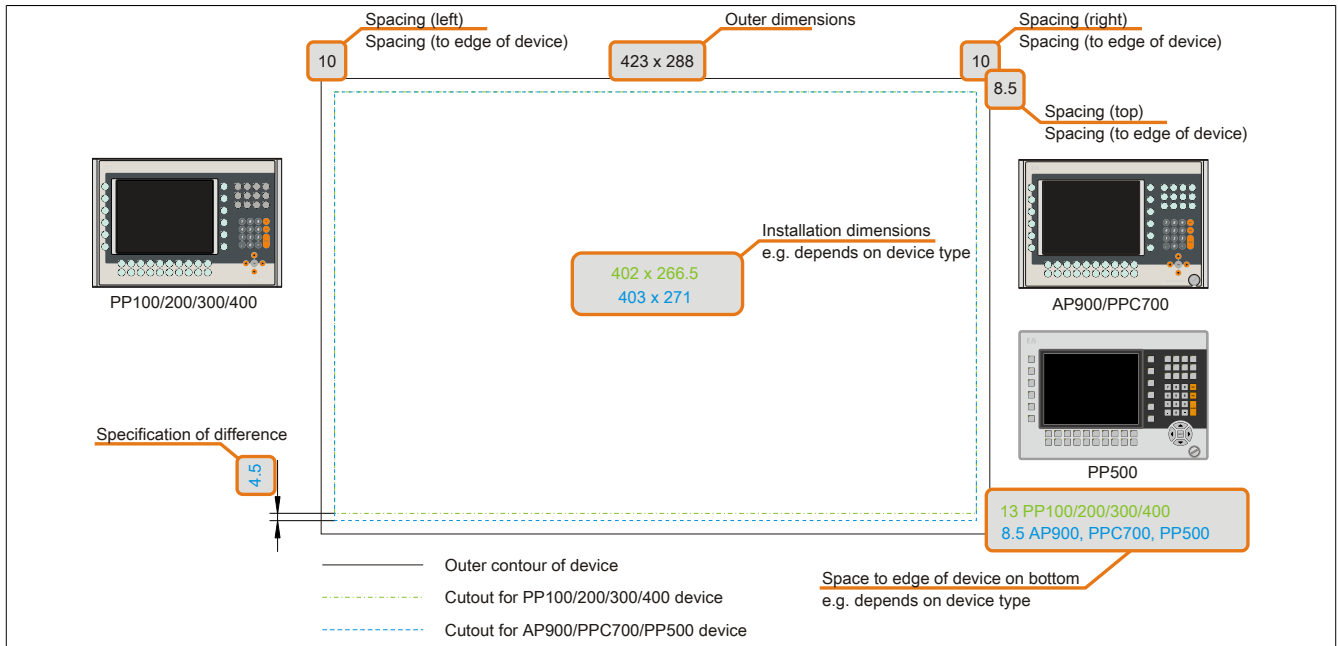

Figure 168: Overview of compatibility figures

5.2.2 5.7" devices

Cutout tolerance values for the PP100/200, PP300/400, PP500, AP900, PPC700 and PPC800 are $\pm 0,5$ mm. The cutout tolerance values from the AP1000 are $+0$ mm/ -0.5 mm.

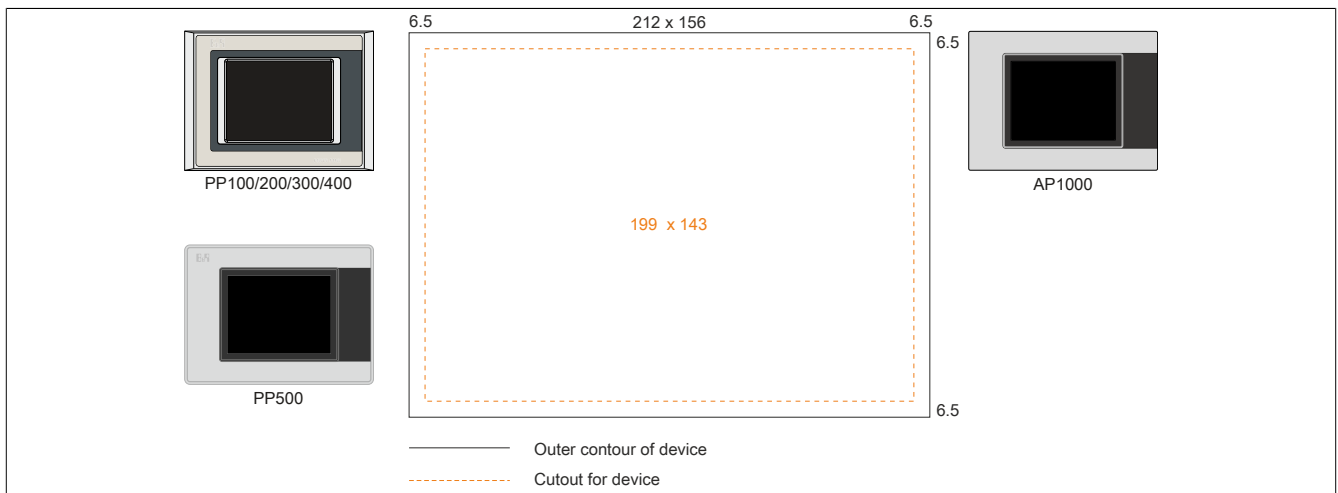

Figure 169: Mounting compatibility - 5.7" device - Horizontal1

5.7" Automation Panel 1000, Power Panel 500 devices and Power Panel 100/200/300/400 devices are 100% mounting compatible in the Horizontal1 format.

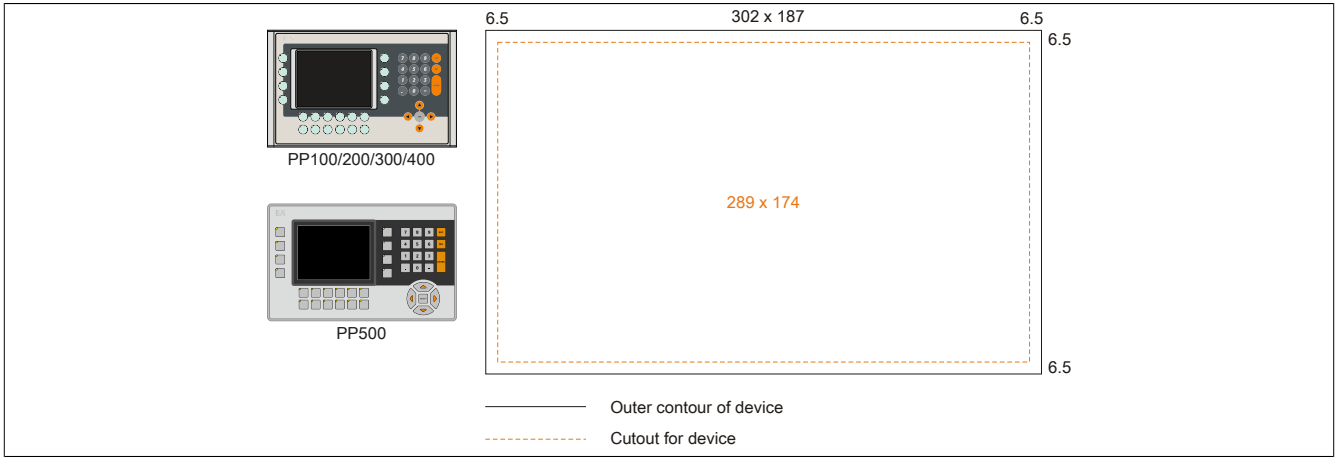

Figure 170: Mounting compatibility - 5.7" device - Horizontal2

5.7" Power Panel 500 devices and Power Panel 100/200/300/400 devices are 100% mounting compatible in the Horizontal2 format.

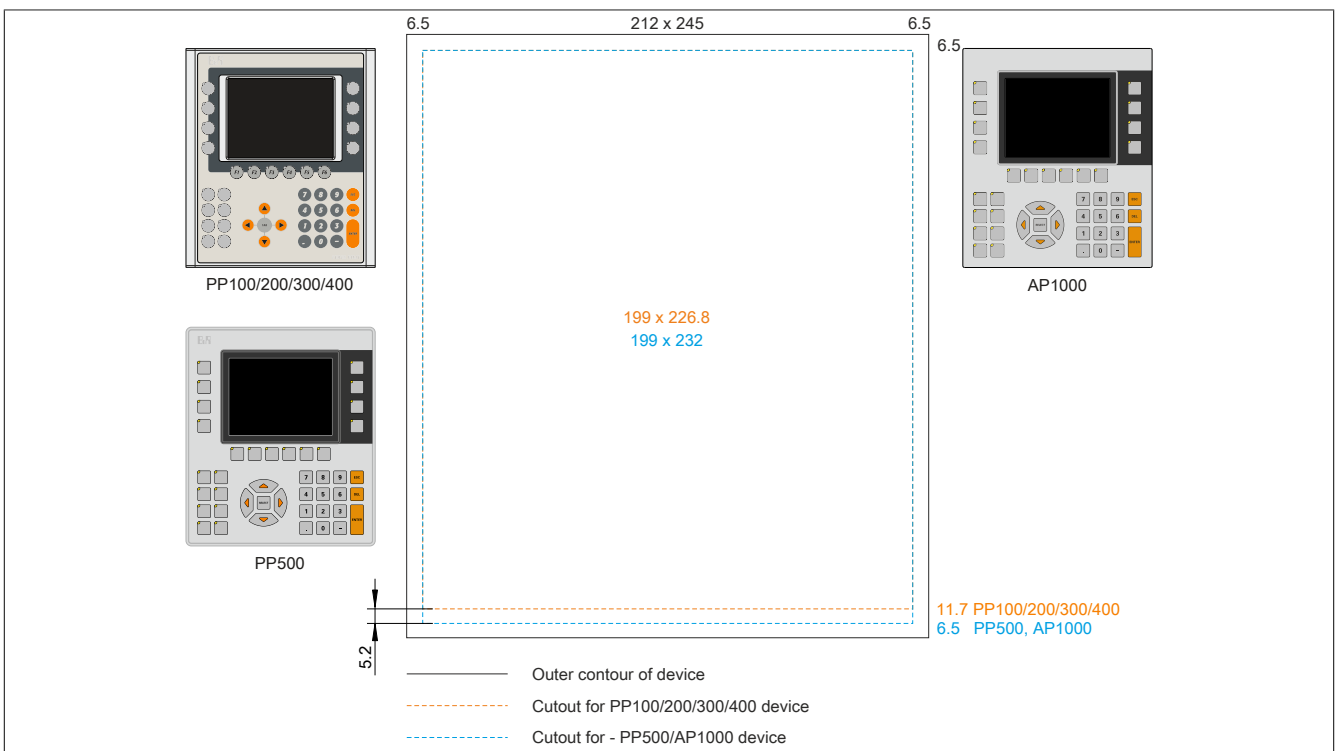

Figure 171: Mounting compatibility - 5.7" device - Vertical1

5.7" Automation Panel 1000 and Power Panel 500 devices are not 100% mounting compatible with Power Panel 100/200/300/400 devices in the Vertical1 format. Automation Panel 1000 and Power Panel 500 devices require a cutout that is 5.2 mm higher (bottom edge).

The larger cutout can be used for all devices under certain conditions:

- When mounting, make sure that the PP100/200/300/400 devices are placed and mounted as close to the center of the cutout as possible. Failure to do so can prevent the retaining clips from holding firmly, which means that a firm seal is no longer guaranteed with the gasket (IP65).

5.2.3 10.4" devices

Cutout tolerance values for the PP100/200, PP300/400, PP500, AP900, PPC700 and PPC800 are ±0,5 mm. The cutout tolerance values from the AP1000 are +0 mm/-0.5 mm.

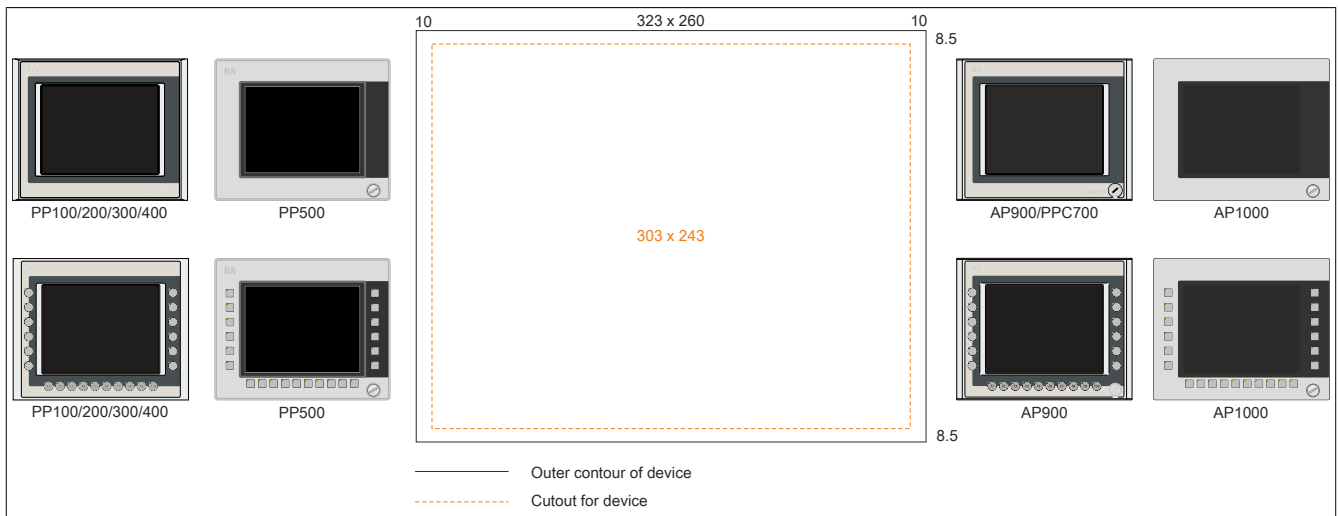

Figure 172: Mounting compatibility - 10.4" device - Horizontal1

10.4" Automation Panel 1000, Automation Panel 900, Panel PC 700, Power Panel 500 devices and Power Panel 100/200/300/400 devices are 100% mounting compatible in Horizontal1 format.

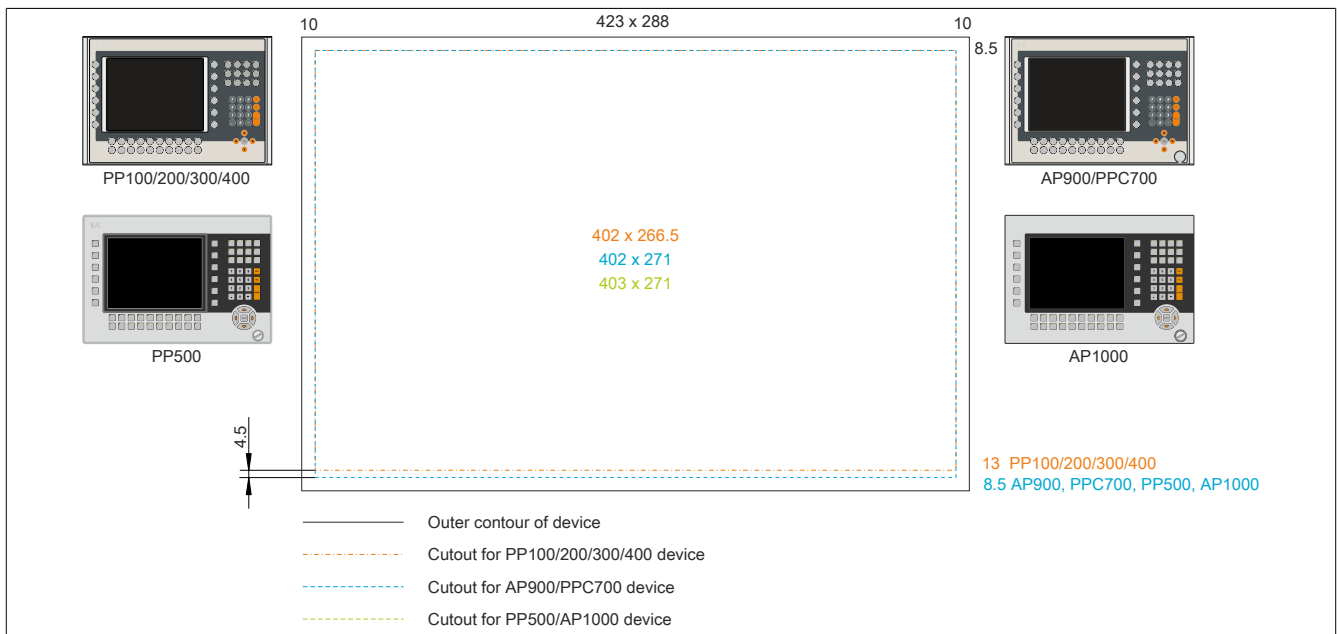

Figure 173: Mounting compatibility - 10.4" device - Horizontal2

10.4" Automation Panel 1000, Automation Panel 900, Panel PC 700 and Power Panel 500 devices are not 100% mounting compatible with Power Panel 100/200/300/400 devices in Horizontal2 format. Automation Panel 1000, Automation Panel 900, Panel PC 700 and Power Panel 500 devices require a cutout that is 4.5 mm higher (bottom edge).

The larger cutout can be used for all devices under certain conditions:

- When mounting, make sure that the PP100/200/300/400 devices are placed and mounted as close to the center of the cutout as possible. Failure to do so can prevent the retaining clips from holding firmly, which means that a firm seal is no longer guaranteed with the gasket (IP65).

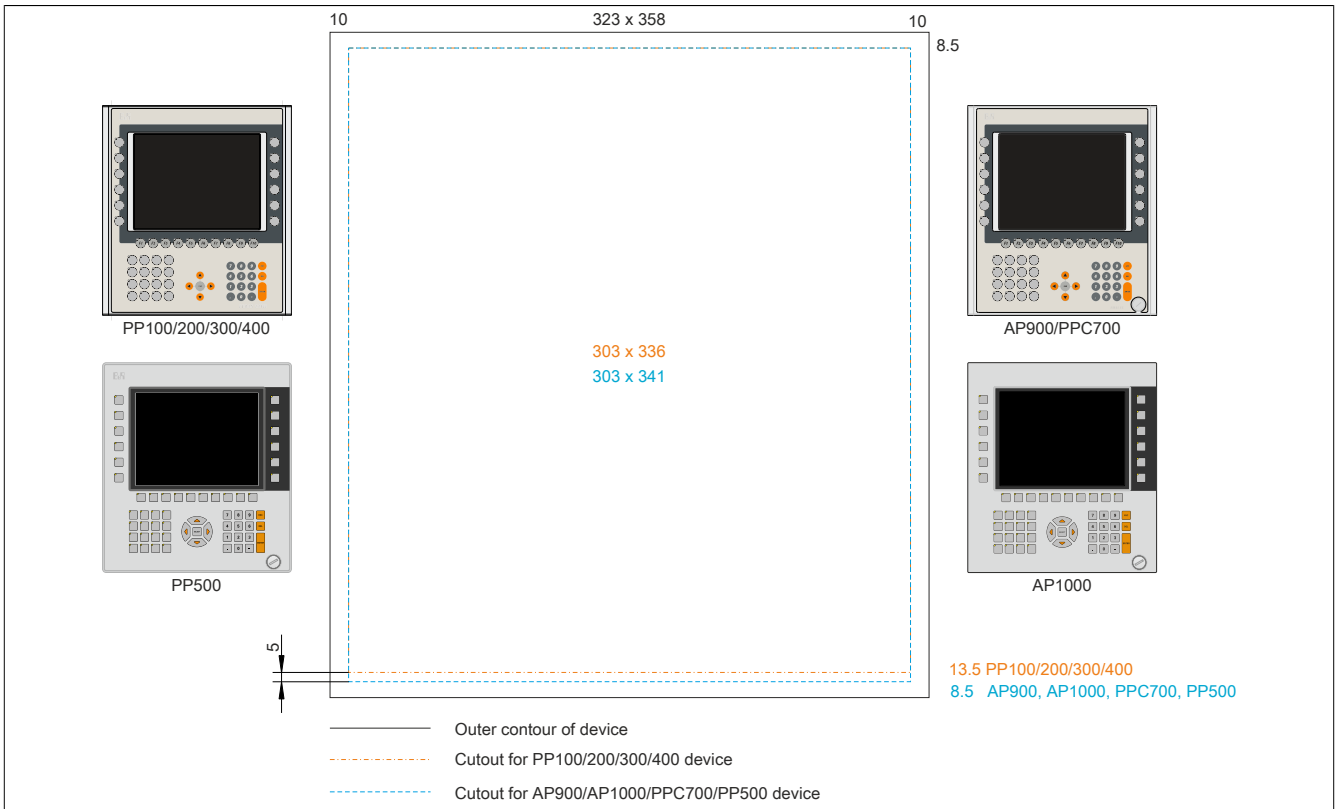

Figure 174: Mounting compatibility - 10.4" device - Vertical1

10.4" Automation Panel 1000, Automation Panel 900, Panel PC 700 and Power Panel 500 devices are not 100% mounting compatible with Power Panel 100/200/300/400 devices in Vertical1 format. Automation Panel 1000, Automation Panel 900, Panel PC 700 and Power Panel 500 devices require a cutout that is 5 mm higher (bottom edge).

The larger cutout can be used for all devices under certain conditions:

- When mounting, make sure that the PP100/200/300/400 devices are placed and mounted as close to the center of the cutout as possible. Failure to do so can prevent the retaining clips from holding firmly, which means that a firm seal is no longer guaranteed with the gasket (IP65).

5.2.4 12.1" devices

Cutout tolerance values for the PP100/200, PP300/400, PP500, AP900, PPC700 and PPC800 are $\pm 0,5$ mm. The cutout tolerance values from the AP1000 are $+0$ mm/ -0.5 mm.

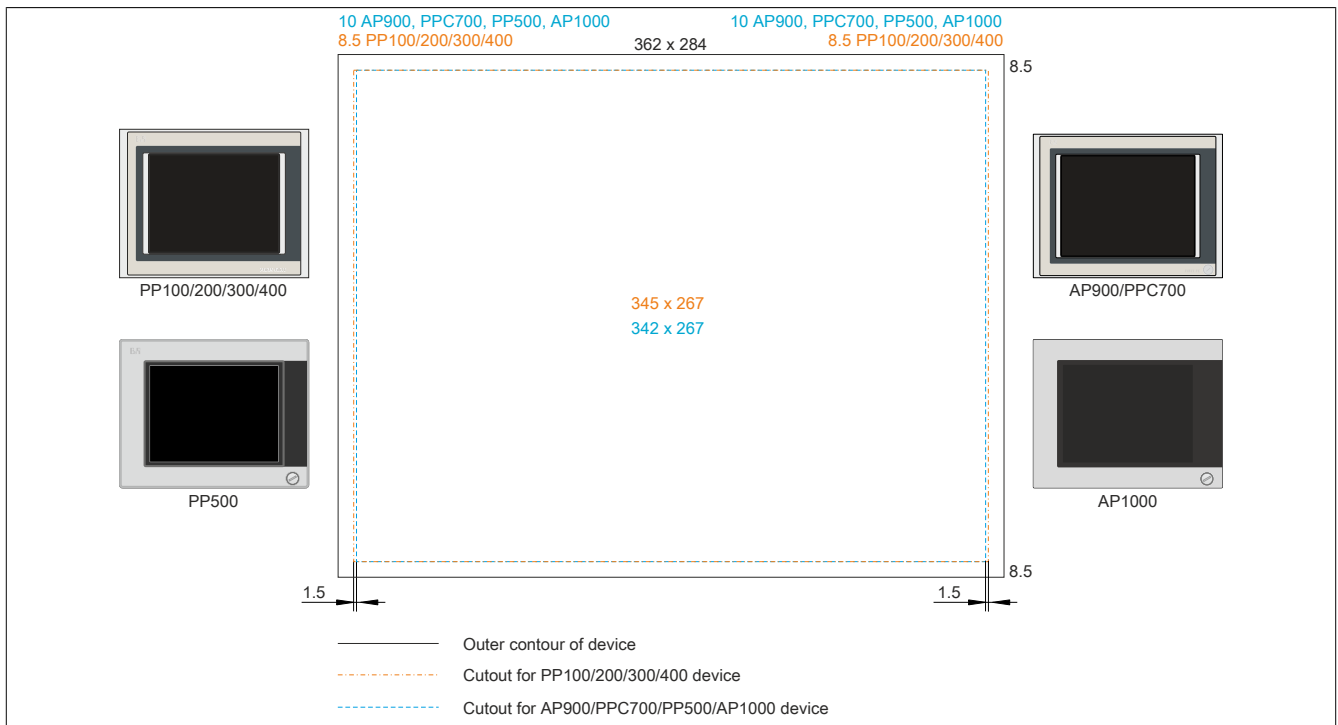

Figure 175: Mounting compatibility - 12.1" device - Horizontal1

12.1" Automation Panel 1000, Automation Panel 900, Panel PC 700 and Power Panel 500 devices are not 100% mounting compatible with Power Panel 100/200/300/400 devices in Horizontal1 format. The Power Panel 300/400 and Power Panel 100/200 devices require a cut that is 1.5 mm wider (left and right).

The larger cutout can be used for all devices under certain conditions:

- When mounting, make sure that the AP1000, AP900, PPC700 and PP500 devices are mounted as close to the center of the cutout as possible.

5.2.5 15" devices

Cutout tolerance values for the PP100/200, PP300/400, PP500, AP900, PPC700 and PPC800 are $\pm 0,5$ mm. The cutout tolerance values from the AP1000 are $+0$ mm/ -0.5 mm.

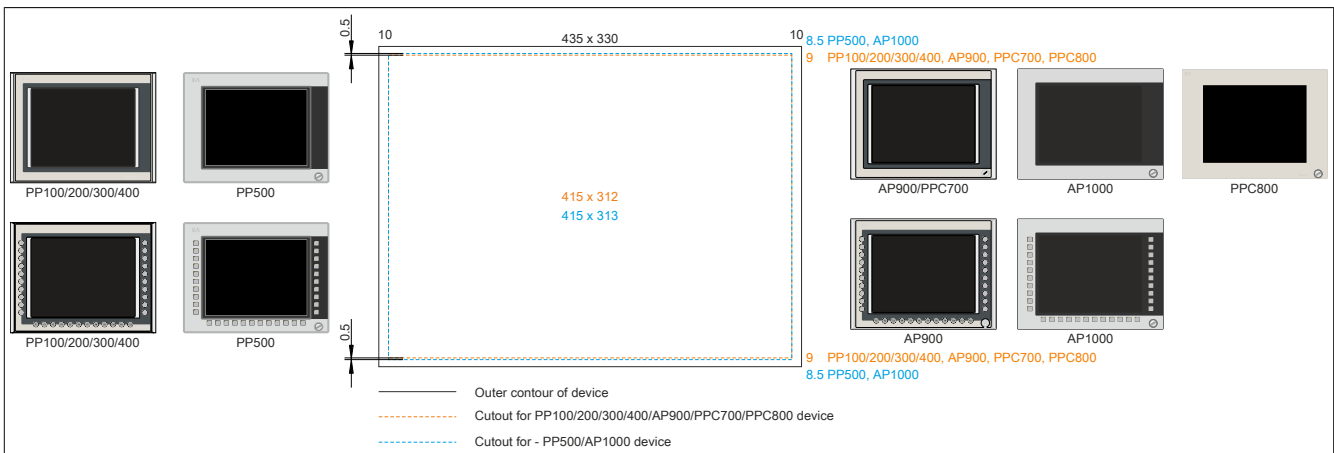

Figure 176: Mounting compatibility - 15" device - Horizontal1

15" Automation Panel 1000 and Power Panel 500 devices are not 100% mounting compatible with Power Panel 100/200/300/400, Automation Panel 900, Panel PC 700 and Panel PC 800 devices in the Vertical1 format. Automation Panel 1000 and Power Panel 500 devices require a cutout that is 0.5 mm higher (top and bottom edge).

The larger cutout can be used for all devices under certain conditions:

- When mounting, make sure that the PP100/200, PP300/400, AP900, PPC700 and PPC800 devices are placed and mounted as close to the center of the cutout as possible. Failure to do so can prevent the retaining clips from holding firmly, which means that a firm seal is no longer guaranteed with the gasket (IP65).

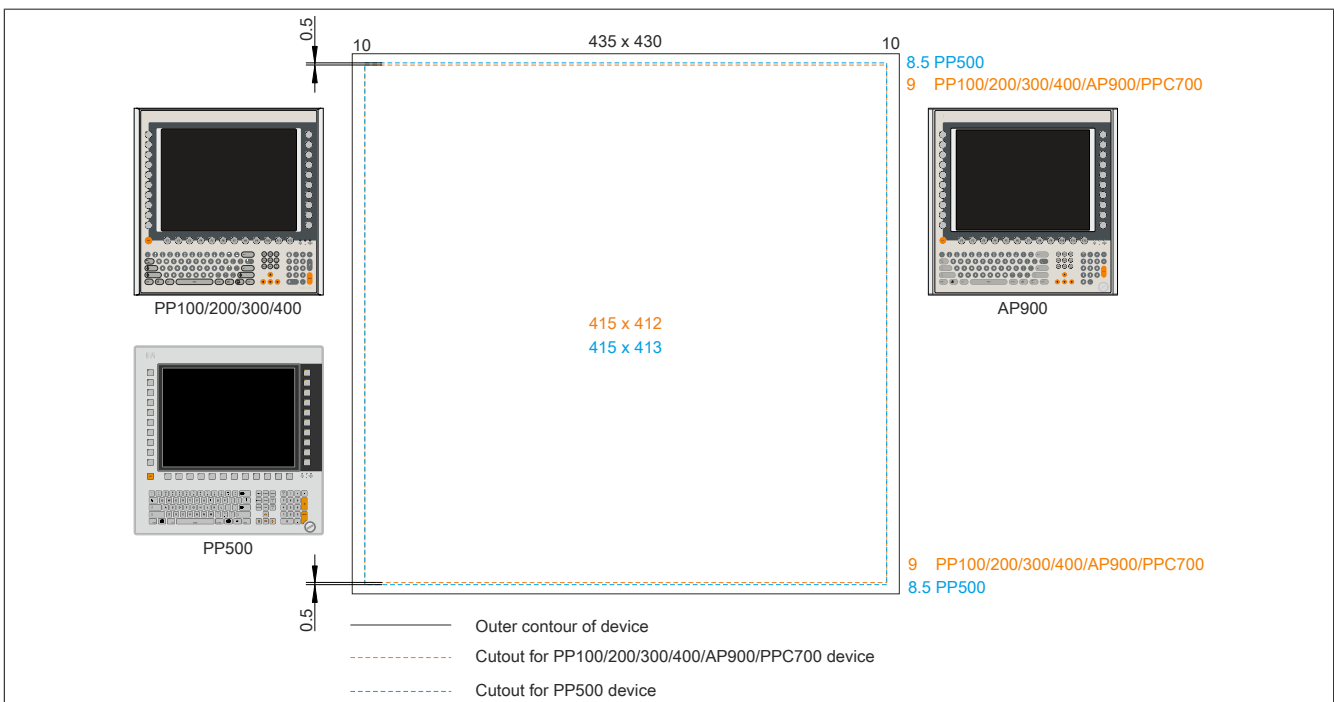

Figure 177: Mounting compatibility - 15" device - Vertical1

15" Power Panel 500 devices are not 100% mounting compatible with Power Panel 100/200/300/400, Automation Panel 900 and Panel PC 700 devices in the Vertical1 format. The Power Panel 500 devices require a cutout that is 0.5 mm higher (top and bottom edge).

The larger cutout can be used for all devices under certain conditions:

- When mounting, make sure that the PP100/200, PP300/400, AP900 and PPC700 devices are mounted as close to the center of the cutout as possible. Failure to do so can prevent the retaining clips from holding firmly, which means that a firm seal is no longer guaranteed with the gasket (IP65).

5.2.6 17" devices

Cutout tolerance values for the PP100/200, PP300/400, PP500, AP900, PPC700 and PPC800 are $\pm 0,5$ mm. The cutout tolerance values from the AP1000 are $+0$ mm/ -0.5 mm.

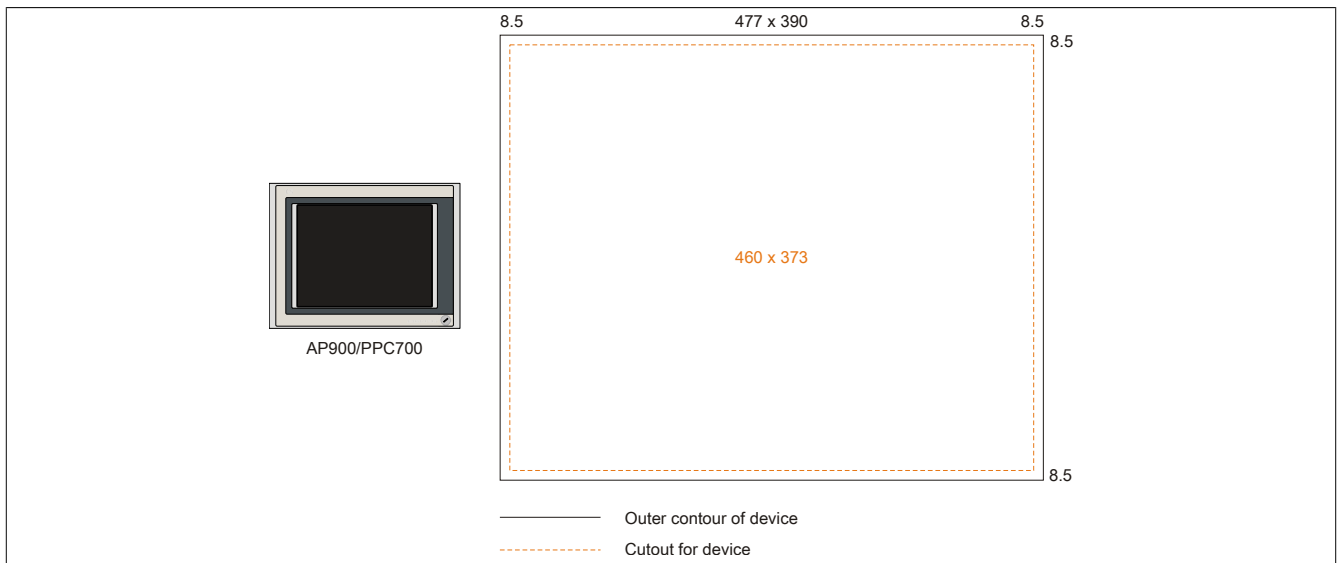

Figure 178: Mounting compatibility - 17" device - Horizontal1

17" Automation Panel 900 devices are 100% mounting compatible with Panel PC 700 devices in the Horizontal1 format.

5.2.7 19" devices

Cutout tolerance values for the PP100/200, PP300/400, PP500, AP900, PPC700 and PPC800 are $\pm 0,5$ mm. The cutout tolerance values from the AP1000 are $+0$ mm/ -0.5 mm.

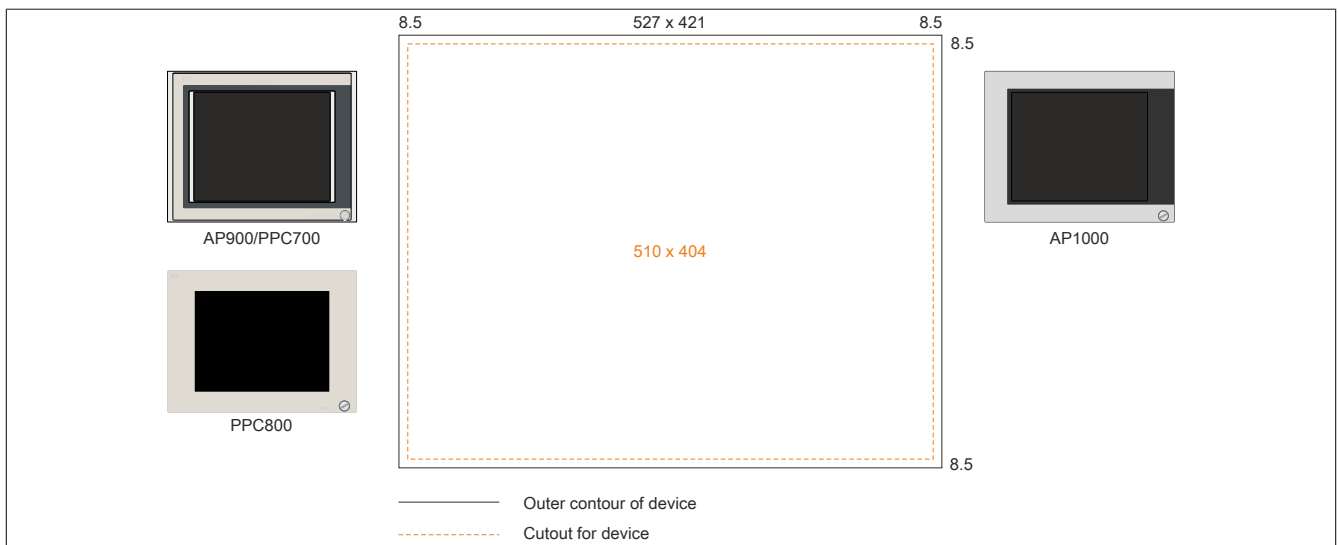

Figure 179: Mounting compatibility - 19" device - Horizontal1

19" Automation Panel 1000, Automation Panel 900, Panel PC 700 and Panel PC 800 are 100% mounting compatible in the Horizontal1 format.

5.2.8 21.3" devices

Cutout tolerance values for the PP100/200, PP300/400, PP500, AP900, PPC700 and PPC800 are $\pm 0,5$ mm. The cutout tolerance values from the AP1000 are +0 mm/-0.5 mm.

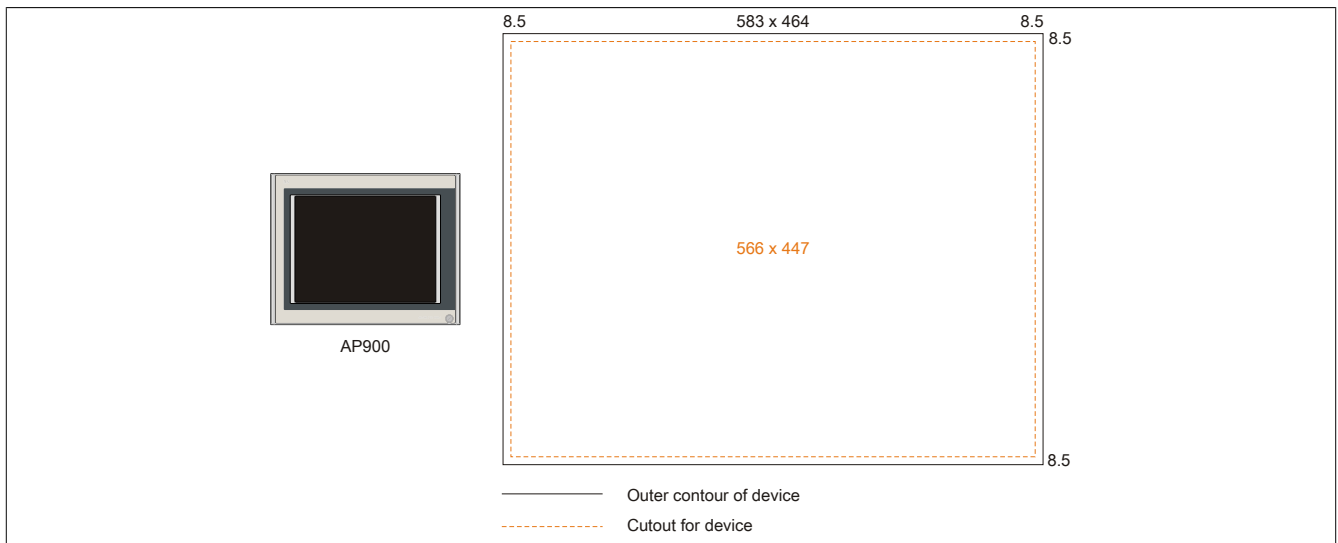

Figure 180: Mounting compatibility - 21.3" device - Horizontal1

6 Abbreviations

Abbreviation	Stands for	Description
NC	Normally closed	A normally closed relay contact
	Not connected	Used in pinout descriptions if a terminal or pin is not connected to a module
ND	Not defined	In data tables, this stands for a value that has not been defined. This may be because a cable manufacturer does not provide certain technical data, for example.
NO	Normally open	A normally open relay contact
TBD	To be defined	Used in technical data tables when certain information is not yet available. The value will be provided later.

Table 221: Abbreviations in this user's manual

7 Glossary

Address	An address is a character string for identifying a memory location or a memory area, where data is stored and can be retrieved. It is also a symbol (e.g. with numerical controllers) for identifying a function unit for which subsequent geometrical or technological data are determined by the symbol.
Algorithms	<p>According to DIN 19226: Algorithms are a finite series of well-defined regulations. The desired output quantities are created from permitted system input quantities. It describes how something is to be done. A procedure must at least satisfy the following requirements to be valid as an algorithm in a mathematical context.</p> <p><i>Discreteness:</i> An algorithm is made up of a finite series of steps.</p> <p><i>Determinacy:</i> Under the same start conditions, it always creates the same end result.</p> <p><i>Clearness:</i> The series of steps is clearly defined.</p> <p><i>Finiteness:</i> It ends after a finite number of steps.</p> <p>From a quantity theory perspective, an algorithm is clearly defined by a set of sizes [input, intermediate and output sizes], a set of elementary operations and also by a regulation, which specifies when and in what sequence certain operations should be carried out. From a functional perspective, it transfers a set of input sizes into a set of output sizes. It can be represented in text form in a natural or artificial formal language or using graphic representations [graph, program flow chart, structured chart, Petri Nets etc.].</p>
ANSI	American National Standards Institute > this organization promotes and manages American industrial standards.
APC	Abbreviation for »Automation PC«
Application software	Software, which is not used for operation by the computer itself, but rather when a computer is used to process a concrete application problem. It sets up the system software and uses this for fulfilling individual tasks. Application software can be accommodated in standard software used by a large number of customers in a wide range of industries. Common examples are Word, Excel, PowerPoint, Paint, Matlab etc. Industrial software tailored to the respective problems of a certain industry and individual software created for solving the particular problems of an individual user.
ASCII	<p>American Standard Code for Information Interchange, used worldwide; numbers, letters, special characters and device controller characters are represented as 7-bit binary combinations. Standard ASCII-characters cover 27 = 128 characters in total. An eighth bit is used as a so-called parity bit for error detection when transferring ASCII files. During even parity checking, this bit is set to 0, when the number of '1s' in the remaining seven bits is an even number. Otherwise, it is set to 1. The expanded ASCII character set does not use parity checking. The highest value bit is used here to switch from the standard character set to the expansion. This allows space for special regional characters e.g. umlauts in the German language.</p> <p>www.asciitable.com</p>
Automation	According to Brockhaus: The application of technical means, using specific programs that (either partially or totally) do not require human intervention to perform operations.
Automation Runtime	A uniform runtime system for all B&R automation components.
Failure	Failure according to IEC 61508: A function unit loses the ability to perform a required function. In regards to safety-oriented systems, a distinction is made between dangerous and safe failures. This depends on whether the status of the system failure is considered dangerous or safe. The cause of the failure may be load related or age-related, and therefore a random failure, or related to a flaw inherent in the system. In this case, it is known as a systematic failure.

Figure 1:	Configuration - Base system.....	20
Figure 2:	Configuration - Software and accessories.....	21
Figure 3:	Temperature sensor locations.....	24
Figure 4:	Supply voltage for system units.....	26
Figure 5:	Serial number sticker.....	27
Figure 6:	Searching for a serial number.....	27
Figure 7:	Interfaces with an interface board.....	28
Figure 8:	Back cover.....	28
Figure 9:	Ground connection.....	29
Figure 10:	LED status indicators.....	35
Figure 11:	5PP520.0573-00 - Dimensions.....	40
Figure 12:	5PP520.0573-00 - Cutout installation.....	40
Figure 13:	5PP520.0573-00 - Temperature humidity diagram.....	41
Figure 14:	5PP520.0573-01 - Dimensions.....	45
Figure 15:	5PP520.0573-01 - Cutout installation.....	45
Figure 16:	5PP520.0573-01 - Temperature humidity diagram.....	46
Figure 17:	5PP551.0573-00 - Dimensions.....	50
Figure 18:	5PP551.0573-00 - Cutout installation.....	50
Figure 19:	5PP551.0573-00 - Temperature humidity diagram.....	51
Figure 20:	5PP552.0573-00 - Dimensions.....	55
Figure 21:	5PP552.0573-00 - Cutout installation.....	55
Figure 22:	5PP552.0573-00 - Temperature humidity diagram.....	56
Figure 23:	5PP520.0702-00 - Dimensions.....	60
Figure 24:	5PP520.0702-00 - Cutout installation.....	60
Figure 25:	5PP520.0702-00 - Temperature humidity diagram.....	61
Figure 26:	5PP520.1043-00 - Dimensions.....	65
Figure 27:	5PP520.1043-00 - Cutout installation.....	65
Figure 28:	5PP520.1043-00 - Temperature humidity diagram.....	66
Figure 29:	5PP580.1043-00 - Dimensions.....	70
Figure 30:	5PP580.1043-00 - Cutout installation.....	70
Figure 31:	5PP580.1043-00 - Temperature humidity diagram.....	71
Figure 32:	5PP581.1043-00 - Dimensions.....	75
Figure 33:	5PP581.1043-00 - Cutout installation.....	76
Figure 34:	5PP581.1043-00 - Temperature humidity diagram.....	76
Figure 35:	5PP582.1043-00 - Dimensions.....	80
Figure 36:	5PP582.1043-00 - Cutout installation.....	80
Figure 37:	5PP582.1043-00 - Temperature humidity diagram.....	81
Figure 38:	5PP520.1214-00 - Dimensions.....	85
Figure 39:	5PP520.1214-00 - Cutout installation.....	85
Figure 40:	5PP520.1214-00 - Temperature humidity diagram.....	86
Figure 41:	5PP520.1505-00 - Dimensions.....	90
Figure 42:	5PP520.1505-00 - Cutout installation.....	90
Figure 43:	5PP520.1505-00 - Temperature humidity diagram.....	91
Figure 44:	5PP580.1505-00 - Dimensions.....	95
Figure 45:	5PP580.1505-00 - Cutout installation.....	95
Figure 46:	5PP580.1505-00 - Temperature humidity diagram.....	96
Figure 47:	5PP581.1505-00 - Dimensions.....	100
Figure 48:	5PP581.1505-00 - Cutout installation.....	101
Figure 49:	5PP581.1505-00 - Temperature humidity diagram.....	101
Figure 50:	CAN terminating switch.....	116
Figure 51:	CAN terminating switch.....	120
Figure 52:	RS232/RS422/RS485 interface - Operation in RS485 mode.....	125
Figure 53:	Serial Interface (COM) terminating resistor.....	126
Figure 54:	Clamping blocks.....	128
Figure 55:	Device with clamping block inserted in cutout.....	130
Figure 56:	Fastening the clamping blocks.....	130
Figure 57:	Retaining clips.....	131

Figure 58:	Inserting the retaining clips.....	131
Figure 59:	Sliding the retaining clips back.....	131
Figure 60:	Mounting with retaining clamps.....	132
Figure 61:	Mounting orientation 0°.....	133
Figure 62:	Mounting orientation -45° or +45°.....	134
Figure 63:	Mounting orientation -90° or +90°.....	135
Figure 64:	Mounting orientation -90° or +90° vertical.....	136
Figure 65:	Mounting orientation 180°.....	137
Figure 66:	Spacing for air circulation - Front view.....	138
Figure 67:	Spacing for air circulation - Side view	138
Figure 68:	Settings for Passmark BurnInTest Pro V4 and a 2-slot APC810 with DVD.....	140
Figure 69:	Test overview of a 2-slot APC810 with DVD.....	141
Figure 70:	Flex radius - Cable connection.....	143
Figure 71:	Grounding concept.....	144
Figure 72:	Local connection of USB peripheral devices on the PP500.....	145
Figure 73:	Remote connection of USB peripheral devices on the APC900 via DVI.....	146
Figure 74:	Remote connection of USB peripheral devices on the APC800/900 via SDL.....	147
Figure 75:	Hardware numbers in the B&R Key Editor and B&R Control Center.....	148
Figure 76:	Display - Keys and LEDs.....	148
Figure 77:	5PP551.0573-00 - Key and LED configuration.....	149
Figure 78:	5PP552.0573-00 - Key and LED configuration	149
Figure 79:	5PP580.1043-00 - Key and LED configuration	150
Figure 80:	5PP581.1043-00 - Key and LED configuration	150
Figure 81:	5PP582.1043-00 - Key and LED configuration.....	151
Figure 82:	5PP580.1505-00 - Key and LED configuration	151
Figure 83:	5PP581.1505-00 - Key and LED configuration	152
Figure 84:	Bootscreen.....	156
Figure 85:	US15W Main - Menü.....	158
Figure 86:	US15W OEM Features - Menü.....	159
Figure 87:	US15W OEM Features - CPU Board Features.....	160
Figure 88:	US15W OEM Features - CPU Board Features - LPC Devices.....	161
Figure 89:	US15W OEM Features - CPU Board Features - Statistical Values.....	162
Figure 90:	US15W OEM Features - CPU Board Features - Temperature Values.....	163
Figure 91:	US15W OEM Features - CPU Board Features - CPU Board Monitor.....	164
Figure 92:	US15W OEM Features - System Unit Features.....	165
Figure 93:	US15W OEM Features - System Unit Features - LPC Devices.....	166
Figure 94:	US15W OEM Features - System Unit Features - Statistical Values.....	167
Figure 95:	US15W OEM Features - System Unit Features - Temperature Values.....	168
Figure 96:	US15W OEM Features - I/O Board Features.....	169
Figure 97:	US15W OEM Features - I/O Board Features - LPC Devices.....	170
Figure 98:	US15W OEM Features - I/O Board Features - Statistical Values.....	171
Figure 99:	US15W OEM Features - I/O Board Features - Temperature Values.....	172
Figure 100:	US15W OEM Features - I/O Board Features - Panel Control.....	173
Figure 101:	US15W OEM Features - IF Board Features.....	174
Figure 102:	US15W OEM Features - IF Board Features - Statistical Values.....	175
Figure 103:	US15W OEM Features - Memory Module Features.....	176
Figure 104:	US15W Advanced - Menü.....	177
Figure 105:	US15W Advanced - RAM Configuration.....	178
Figure 106:	US15W Advanced - Boot Configuration.....	179
Figure 107:	US15W Advanced - Peripheral Configuration.....	180
Figure 108:	US15W Advanced - IDE Configuration.....	181
Figure 109:	US15W Advanced - IDE Configuration - Channel 1 Master.....	182
Figure 110:	US15W Advanced - IDE Configuration - Channel 1 Slave.....	183
Figure 111:	US15W Advanced - Video Configuration.....	184
Figure 112:	US15W Advanced - USB Configuration.....	185
Figure 113:	US15W Advanced - SDIO Configuration.....	186
Figure 114:	US15W Advanced - ACPI Table/Features Control.....	187

Figure 115:	US15W Advanced - PCI Express Root Port 1.....	188
Figure 116:	US15W Advanced - PCI Express Root Port 2.....	190
Figure 117:	US15W Advanced - Console Redirection.....	192
Figure 118:	US15W Security - Menü.....	194
Figure 119:	US15W Security - Set Supervisor Password.....	195
Figure 120:	US15W Security - Set User Password.....	196
Figure 121:	US15W Power - Menü.....	197
Figure 122:	US15W Power - Advanced - CPU Control.....	198
Figure 123:	US15W Power - Advanced - CPU Control - Thermal Trip Points Settings.....	200
Figure 124:	US15W Power - Platform Power Management.....	201
Figure 125:	US15W Boot - Menü.....	202
Figure 126:	US15W Boot - Legacy.....	203
Figure 127:	US15W Boot - Legacy - Boot Type Order.....	204
Figure 128:	US15W Boot - Legacy - Hard Disk Drive.....	205
Figure 129:	US15W Boot - Legacy - USB.....	205
Figure 130:	US15W Boot - Legacy - Others.....	206
Figure 131:	US15W Exit - Menü.....	207
Figure 132:	Interrupt routing with enabled APIC - Beginning with BIOS version N0.15.....	215
Figure 133:	BIOS und MTCX Softwareversionen.....	216
Figure 134:	BIOS and MTCX software versions - Control Center.....	217
Figure 135:	ADI Control Center screenshots - Examples.....	234
Figure 136:	ADI Development Kit Screenshots (Version 3.70).....	236
Figure 137:	ADI .NET SDK screenshots (version 2.10).....	238
Figure 138:	B&R Key Editor screenshots (version 3.60).....	240
Figure 139:	B&R KCF Editor screenshot (version 1.0).....	242
Figure 140:	GL certificate no. 37036 – 12 HH.....	247
Figure 141:	5CFCRD.xxxx-06 - Temperature/Humidity diagram for CompactFlash cards.....	258
Figure 142:	Type I CompactFlash card - Dimensions.....	259
Figure 143:	ATTO Disk Benchmark v2.34 read comparison - 5CFCRD.xxxx-04 and 5CFCRD.xxxx-06.....	260
Figure 144:	ATTO Disk Benchmark v2.34 write comparison - 5CFCRD.xxxx-04 and 5CFCRD.xxxx-06.....	260
Figure 145:	5CFCRD.xxxx-04 - Temperature/Humidity diagram for CompactFlash cards.....	263
Figure 146:	Type I CompactFlash card - Dimensions.....	263
Figure 147:	ATTO Disk Benchmark v2.34 read comparison - 5CFCRD.xxxx-03 and 5CFCRD.xxxx-04.....	264
Figure 148:	ATTO Disk Benchmark v2.34 write comparison - 5CFCRD.xxxx-03 and 5CFCRD.xxxx-04.....	264
Figure 149:	5CFCRD.xxxx-03 - Temperature/Humidity diagram for CompactFlash cards.....	267
Figure 150:	Type I CompactFlash card - Dimensions.....	267
Figure 151:	5MD900.USB2-02 - Dimensions.....	271
Figure 152:	USB media drive with front cover - Dimensions.....	271
Figure 153:	USB media drive with front cover - Installation cutout.....	272
Figure 154:	5MD900.USB2-02 - Mounting orientation	272
Figure 155:	5A5003.03 - Dimensions.....	273
Figure 156:	Front cover mounting and installation depth.....	274
Figure 157:	USB media drive with front cover - Installation cutout.....	274
Figure 158:	5MMUSB.xxxx-01 - Temperature/Humidity diagram.....	276
Figure 159:	5AC804.MFLT-00 - Dimensions.....	281
Figure 160:	5AC804.MFLT-00 - Drilling template.....	281
Figure 161:	Connection example.....	281
Figure 162:	Removing the battery.....	283
Figure 163:	Battery handling.....	284
Figure 164:	Insert battery.....	284
Figure 165:	CompactFlash + ejector.....	285
Figure 166:	MTCX controller location.....	286
Figure 167:	5-wire AMT touch screen - Temperature/Humidity diagram.....	287
Figure 168:	Overview of compatibility figures.....	293
Figure 169:	Mounting compatibility - 5.7" device - Horizontal1.....	293
Figure 170:	Mounting compatibility - 5.7" device - Horizontal2.....	294
Figure 171:	Mounting compatibility - 5.7" device - Vertical1.....	294

Figure 172: Mounting compatibility - 10.4" device - Horizontal1..... 295

Figure 173: Mounting compatibility - 10.4" device - Horizontal2..... 295

Figure 174: Mounting compatibility - 10.4" device - Vertical1..... 296

Figure 175: Mounting compatibility - 12.1" device - Horizontal1..... 297

Figure 176: Mounting compatibility - 15" device - Horizontal1..... 298

Figure 177: Mounting compatibility - 15" device - Vertical1..... 298

Figure 178: Mounting compatibility - 17" device - Horizontal1..... 299

Figure 179: Mounting compatibility - 19" device - Horizontal1..... 299

Figure 180: Mounting compatibility - 211" device - Horizontal1.....300

Table 1:	Manual history.....	10
Table 2:	Environmentally friendly separation of materials.....	14
Table 3:	Description of the safety notices used in this documentation.....	15
Table 4:	Range of nominal sizes.....	15
Table 5:	Temperature sensor locations.....	24
Table 6:	Overview of humidity specifications for individual components.....	25
Table 7:	24 VDC power supply interface.....	29
Table 8:	COM serial interface - Pinout.....	30
Table 9:	Ethernet interface (ETH).....	30
Table 10:	USB1, USB2 interfaces.....	31
Table 11:	USB3 interface.....	31
Table 12:	Battery.....	32
Table 13:	Battery status.....	32
Table 14:	CompactFlash slot.....	33
Table 15:	SD memory card slot.....	33
Table 16:	Power button.....	34
Table 17:	Reset button.....	34
Table 18:	Mode/Node switches.....	34
Table 19:	LED status indicators - Data.....	35
Table 20:	Interface board slot.....	36
Table 21:	I/O board slot.....	36
Table 22:	5PP520.0573-00 - Order data.....	37
Table 23:	5PP520.0573-00 - Technical data.....	38
Table 24:	5PP520.0573-01 - Order data.....	42
Table 25:	5PP520.0573-01 - Technical data.....	43
Table 26:	5PP551.0573-00 - Order data.....	47
Table 27:	5PP551.0573-00 - Technical data.....	48
Table 28:	5PP552.0573-00 - Order data.....	52
Table 29:	5PP552.0573-00 - Technical data.....	53
Table 30:	5PP520.0702-00 - Order data.....	57
Table 31:	5PP520.0702-00 - Technical data.....	58
Table 32:	5PP520.1043-00 - Order data.....	62
Table 33:	5PP520.1043-00 - Technical data.....	63
Table 34:	5PP580.1043-00 - Order data.....	67
Table 35:	5PP580.1043-00 - Technical data.....	68
Table 36:	5PP581.1043-00 - Order data.....	72
Table 37:	5PP581.1043-00 - Technical data.....	73
Table 38:	5PP582.1043-00 - Order data.....	77
Table 39:	5PP582.1043-00 - Technical data.....	78
Table 40:	5PP520.1214-00 - Order data.....	82
Table 41:	5PP520.1214-00 - Technical data.....	83
Table 42:	5PP520.1505-00 - Order data.....	87
Table 43:	5PP520.1505-00, 5PP520.1505-00 - Technical data.....	88
Table 44:	5PP580.1505-00 - Order data.....	92
Table 45:	5PP580.1505-00, 5PP580.1505-00 - Technical data.....	93
Table 46:	5PP581.1505-00 - Order data.....	97
Table 47:	5PP581.1505-00, 5PP581.1505-00 - Technical data.....	98
Table 48:	5PP5CP.US15-00, 5PP5CP.US15-01, 5PP5CP.US15-02 - Order data.....	102
Table 49:	5PP5CP.US15-00, 5PP5CP.US15-01, 5PP5CP.US15-02 - Technical data.....	102
Table 50:	5MMDDR.0512-01, 5MMDDR.1024-01, 5MMDDR.2048-01 - Order data.....	104
Table 51:	5MMDDR.0512-01, 5MMDDR.1024-01, 5MMDDR.2048-01 - Technical data.....	104
Table 52:	5PP5IF.CETH-00 - Order data.....	105
Table 53:	5PP5IF.CETH-00 - Technical data.....	105
Table 54:	5PP5IF.CETH-00 - Ethernet interface.....	106
Table 55:	5PP5IF.CHDA-00 - Order data.....	107
Table 56:	5PP5IF.CHDA-00 - Technical data.....	107
Table 57:	MIC, Line IN, Line OUT.....	107

Table 58:	5PP5IF.FETH-00 - Order data.....	109
Table 59:	5PP5IF.FETH-00 - Technical data.....	109
Table 60:	5PP5IF.FETH-00 - Ethernet interface.....	110
Table 61:	5PP5IF.FPLM-00 - Order data.....	111
Table 62:	5PP5IF.FPLM-00 - Technical data.....	111
Table 63:	5PP5IF.FPLM-00 - POWERLINK interface.....	112
Table 64:	Status/Error LED - Ethernet mode.....	112
Table 65:	Status/Error LED - POWERLINK V1 operating mode.....	112
Table 66:	Status/Error LED - POWERLINK - Error.....	113
Table 67:	Status/Error LED - POWERLINK - Status.....	113
Table 68:	System stop error codes.....	114
Table 69:	5PP5IF.FCAN-00 - Order data.....	115
Table 70:	5PP5IF.FCAN-00 - Technical data.....	115
Table 71:	5PP5IF.FCAN-00 - CAN bus interface.....	116
Table 72:	5PP5IF.FCAN-00 - LED status indicators.....	116
Table 73:	5PP5IF.FX2X-00 - Order data.....	117
Table 74:	5PP5IF.FX2X-00 - Technical data.....	117
Table 75:	5PP5IF.FX2X-00 - X2X Link master interface.....	118
Table 76:	5PP5IF.FX2X-00 - LED status indicators.....	118
Table 77:	5PP5IF.FXCM-00 - Order data.....	119
Table 78:	5PP5IF.FXCM-00 - Technical data.....	119
Table 79:	5PP5IF.FCAN-00 - CAN bus master interface.....	120
Table 80:	5PP5IF.FX2X-00 - X2X Link master interface.....	120
Table 81:	5PP5IF.FXCM-00 - LED status indicators.....	120
Table 82:	5PP5IO.GNAC-00 - Order data.....	121
Table 83:	5PP5IO.GNAC-00 - Technical data.....	121
Table 84:	Panel interface - DVI, SDL.....	122
Table 85:	DVI interface - Pinout.....	122
Table 86:	Cable lengths and resolutions for SDL transmission.....	123
Table 87:	Cable lengths and resolutions for DVI transmission.....	123
Table 88:	COM - Pinout.....	123
Table 89:	RS232/422/485 - I/O address and IRQ.....	123
Table 90:	RS232 - Bus length and transfer rate.....	124
Table 91:	RS232 - Cable requirements.....	124
Table 92:	RS422 - Bus length and transfer rate.....	124
Table 93:	RS422 - Cable requirements.....	124
Table 94:	RS485 - Bus length and transfer rate.....	125
Table 95:	RS485 - Cable requirements.....	125
Table 96:	USB4 interface.....	126
Table 97:	MIC, Line IN, Line OUT.....	126
Table 98:	Evaluation example using a 2-slot APC810.....	142
Table 99:	BIOS-relevant keys for POST.....	157
Table 100:	BIOS-relevant keys.....	157
Table 101:	US15W Main menu - Configuration options.....	158
Table 102:	US15W OEM features menu - Configuration options.....	159
Table 103:	US15W OEM features - CPU board features - Configuration options.....	160
Table 104:	US15W OEM features - CPU board features - LPC devices - Configuration options.....	161
Table 105:	US15W OEM features - CPU board features - Statistical values - Configuration options.....	162
Table 106:	US15W OEM features - CPU board features - Temperature values - Configuration options.....	163
Table 107:	US15W OEM features - CPU board features - CPU board monitor - Configuration options.....	164
Table 108:	US15W OEM features - System unit features - Configuration options.....	165
Table 109:	US15W OEM features - System unit features - LPC devices - Configuration options.....	166
Table 110:	US15W OEM features - System unit features - Statistical values - Configuration options.....	167
Table 111:	US15W OEM features - System unit features - Temperature values - Configuration options.....	168
Table 112:	US15W OEM features - I/O board features - Configuration options.....	169
Table 113:	US15W OEM features - I/O board features - LPC devices - Configuration options.....	170
Table 114:	US15W OEM features - I/O board features - Statistical values - Configuration options.....	171

Table 115:	US15W OEM features - I/O board features - Temperature values - Configuration options.....	172
Table 116:	US15W OEM features - I/O board features - Panel control - Configuration options.....	173
Table 117:	US15W OEM features - IF board features - Configuration options.....	174
Table 118:	US15W OEM features - IF board features - Statistical values - Configuration options.....	175
Table 119:	US15W OEM features - Memory module features - Configuration options.....	176
Table 120:	US15W Advanced menu - Configuration options.....	177
Table 121:	US15W Advanced - RAM configuration - Configuration options.....	178
Table 122:	US15W Advanced - Boot configuration - Configuration options.....	179
Table 123:	US15W Advanced - Peripheral configuration - Configuration options.....	180
Table 124:	US15W Advanced - IDE configuration - Configuration options.....	181
Table 125:	US15W Advanced - IDE configuration - Channel 1 master - Configuration options.....	182
Table 126:	US15W Advanced - IDE configuration - Channel 1 slave - Configuration options.....	183
Table 127:	US15W Advanced - Video configuration - Configuration options.....	184
Table 128:	US15W Advanced - USB configuration - Configuration options.....	185
Table 129:	US15W Advanced - SDIO configuration - Configuration options.....	186
Table 130:	US15W Advanced - ACPI table/features control - Configuration options.....	187
Table 131:	US15W Advanced - PCI Express root port 1 - Configuration options.....	188
Table 132:	US15W Advanced - PCI Express root port 2 - Configuration options.....	190
Table 133:	US15W Advanced - Console redirection - Configuration options.....	192
Table 134:	US15W Security menu - Configuration options.....	194
Table 135:	US15W Security - Set supervisor password - Configuration options.....	195
Table 136:	US15W Security - Set user password - Configuration options.....	196
Table 137:	US15W Power menu - Configuration options.....	197
Table 138:	US15W Power - Advanced CPU control - Configuration options.....	198
Table 139:	US15W Power - CPU control - Thermal trip points settings - Configuration options.....	200
Table 140:	US15W Power - Platform power management - Configuration options.....	201
Table 141:	US15W Boot menu - Configuration options.....	202
Table 142:	US15W Boot - Legacy - Configuration options.....	203
Table 143:	US15W Boot - Legacy - Boot type order - Configuration options.....	204
Table 144:	US15W Boot - Legacy - Hard disk drive - Configuration options.....	205
Table 145:	US15W Boot - Legacy - USB - Configuration options.....	206
Table 146:	US15W Boot - Legacy - Others - Configuration options.....	206
Table 147:	US15W Exit menu - Configuration options.....	207
Table 148:	US15W - Main - Overview of profile settings.....	208
Table 149:	US15W - OEM features - Overview of profile settings.....	208
Table 150:	US15W - CPU board features - Overview of profile settings.....	208
Table 151:	US15W - System unit features - Overview of profile settings.....	209
Table 152:	US15W - I/O board features - Overview of profile settings.....	209
Table 153:	US15W - IF board features - Overview of profile settings.....	209
Table 154:	US15W - Memory module features - Overview of profile settings.....	210
Table 155:	US15W - RAM configuration - Overview of profile settings.....	210
Table 156:	US15W - Boot configuration - Overview of profile settings.....	210
Table 157:	US15W - Peripheral configuration - Overview of profile settings.....	210
Table 158:	US15W - IDE configuration - Overview of profile settings.....	210
Table 159:	US15W - Video configuration - Overview of profile settings.....	211
Table 160:	US15W - USB configuration - Overview of profile settings.....	211
Table 161:	US15W - SDIO configuration - Overview of profile settings.....	211
Table 162:	US15W - ACPI table/features control - Overview of profile settings.....	211
Table 163:	US15W - PCI Express root port 1 - Overview of profile settings.....	211
Table 164:	US15W - PCI Express root port 2 - Overview of profile settings.....	212
Table 165:	US15W - Console redirection - Overview of profile settings.....	212
Table 166:	US15W Power - Overview of profile settings.....	212
Table 167:	US15W - Advanced CPU control - Overview of profile settings.....	212
Table 168:	US15W - Platform power management - Overview of profile settings.....	213
Table 169:	US15W Boot - Overview of profile settings.....	213
Table 170:	RAM address assignment.....	214
Table 171:	I/O address assignment.....	214

Table 172:	IRQ interrupt assignments in PIC mode.....	214
Table 173:	IRQ interrupt assignments in APIC mode.....	215
Table 174:	5SWWXP.0600-GER, 5SWWXP.0600-ENG, 5SWWXP.0600-MUL - Order data.....	219
Table 175:	5SWWI7.0100-GER, 5SWWI7.1100-GER, 5SWWI7.0100-ENG, 5SWWI7.1100-ENG, 5SWWI7.0300-MUL, 5SWWI7.1300-MUL - Order data.....	221
Table 176:	5SWWXP.0736-ENG - Order data.....	223
Table 177:	Device functions in Windows Embedded Standard 2009.....	223
Table 178:	5SWWI7.0536-ENG, 5SWWI7.1536-ENG, 5SWWI7.0736-MUL, 5SWWI7.1736-MUL - Order data.....	225
Table 179:	Device functions in Windows Embedded Standard 7.....	226
Table 180:	5SWWCE.0836-ENG - Order data.....	228
Table 181:	Windows CE 6.0 features.....	228
Table 182:	0TG1000.01, 1TG4600.10-5, 1TG4601.06-5, 1TG4601.06-T - Order data.....	230
Table 183:	5SWLIN.0136-MUL - Order data.....	232
Table 184:	Debian-supported resolutions.....	232
Table 185:	5SWUTI.0001-000 - Order data.....	243
Table 186:	GL certifications.....	246
Table 187:	0AC201.91, 4A0006.00-000 - Order data.....	248
Table 188:	0AC201.91, 4A0006.00-000 - Technical data.....	248
Table 189:	0TB103.9, 0TB103.91 - Order data.....	250
Table 190:	0TB103.9, 0TB103.91 - Technical data.....	250
Table 191:	0TB1208.3100 - Order data.....	251
Table 192:	0TB1208.3100 - Technical data.....	251
Table 193:	5CFCRD.0512-06, 5CFCRD.1024-06, 5CFCRD.2048-06, 5CFCRD.4096-06, 5CFCRD.8192-06, 5CFCRD.016G-06, 5CFCRD.032G-06 - Order data.....	254
Table 194:	5CFCRD.0512-06, 5CFCRD.1024-06, 5CFCRD.2048-06, 5CFCRD.4096-06, 5CFCRD.8192-06, 5CFCRD.016G-06, 5CFCRD.032G-06 - Order data.....	254
Table 195:	5CFCRD.0512-06, 5CFCRD.1024-06, 5CFCRD.2048-06, 5CFCRD.4096-06, 5CFCRD.8192-06, 5CFCRD.016G-06, 5CFCRD.032G-06 - Technical data.....	255
Table 196:	5CFCRD.0512-06, 5CFCRD.1024-06, 5CFCRD.2048-06, 5CFCRD.4096-06, 5CFCRD.8192-06, 5CFCRD.016G-06, 5CFCRD.032G-06 - Technical data.....	256
Table 197:	5CFCRD.0512-04, 5CFCRD.1024-04, 5CFCRD.2048-04, 5CFCRD.4096-04, 5CFCRD.8192-04, 5CFCRD.016G-04 - Order data.....	261
Table 198:	5CFCRD.0512-04, 5CFCRD.1024-04, 5CFCRD.2048-04, 5CFCRD.4096-04, 5CFCRD.8192-04, 5CFCRD.016G-04 - Technical data.....	261
Table 199:	5CFCRD.0064-03, 5CFCRD.0128-03, 5CFCRD.0256-03, 5CFCRD.0512-03, 5CFCRD.1024-03, 5CFCRD.2048-03, 5CFCRD.4096-03, 5CFCRD.8192-03 - Order data.....	265
Table 200:	5CFCRD.0064-03, 5CFCRD.0128-03, 5CFCRD.0256-03, 5CFCRD.0512-03, 5CFCRD.1024-03, 5CFCRD.2048-03, 5CFCRD.4096-03, 5CFCRD.8192-03 - Technical data.....	265
Table 201:	5MD900.USB2-02 - Order data.....	269
Table 202:	5MD900.USB2-02 - Technical data.....	269
Table 203:	5MD900.USB2-02 - Content of delivery.....	272
Table 204:	5A5003.03 - Order data.....	273
Table 205:	5A5003.03 - Technical data.....	273
Table 206:	5A5003.03 - Content of delivery.....	273
Table 207:	5MMUSB.2048-01, 5MMUSB.4096-01 - Order data.....	275
Table 208:	5MMUSB.2048-01, 5MMUSB.4096-01 - Technical data.....	275
Table 209:	5AC900.1201-00 - Order data.....	277
Table 210:	5AC900.1201-01 - Order data.....	277
Table 211:	5AC900.BLOC-00 - Order data.....	278
Table 212:	5AC900.BLOC-01 - Order data.....	278
Table 213:	5AC900.CLIP-01 - Order data.....	279
Table 214:	5AC804.MFLT-00 - Order data.....	280
Table 215:	5AC804.MFLT-00 - Technical data.....	280
Table 216:	Battery status.....	283
Table 217:	5-wire AMT touch screen - Technical data.....	287

Table 218:	Chemical resistance of the panel overlay.....	289
Table 219:	Product abbreviations.....	291
Table 220:	Device compatibilityoverview.....	291
Table 221:	Abbreviations in this user's manual.....	301

0AC201.91.....	248
0TB103.9.....	250
0TB103.91.....	250
0TB1208.3100.....	251
0TG1000.01.....	230
1TG4600.10-5.....	230
1TG4601.06-5.....	230
1TG4601.06-T.....	230
4A0006.00-000.....	248
5A5003.03.....	273
5AC804.MFLT-00.....	280
5AC900.1201-00.....	277
5AC900.1201-01.....	277
5AC900.BLOC-00.....	278
5AC900.BLOC-01.....	278
5AC900.CLIP-01.....	279
5CFCRD.0064-03.....	265
5CFCRD.0128-03.....	265
5CFCRD.016G-04.....	261
5CFCRD.016G-06.....	254
5CFCRD.0256-03.....	265
5CFCRD.032G-06.....	254
5CFCRD.0512-03.....	265
5CFCRD.0512-04.....	261
5CFCRD.0512-06.....	254
5CFCRD.1024-03.....	265
5CFCRD.1024-04.....	261
5CFCRD.1024-06.....	254
5CFCRD.2048-03.....	265
5CFCRD.2048-04.....	261
5CFCRD.2048-06.....	254
5CFCRD.4096-03.....	265
5CFCRD.4096-04.....	261
5CFCRD.4096-06.....	254
5CFCRD.8192-03.....	265
5CFCRD.8192-04.....	261
5CFCRD.8192-06.....	254
5MD900.USB2-02.....	269
5MMDDR.0512-01.....	245
5MMDDR.1024-01.....	245
5MMDDR.2048-01.....	245
5MMUSB.2048-01.....	275
5MMUSB.4096-01.....	275
5PP520.0573-00.....	37
5PP520.0573-01.....	42
5PP520.0702-00.....	245
5PP520.1043-00.....	62
5PP520.1214-00.....	82
5PP520.1505-00.....	245
5PP551.0573-00.....	47
5PP552.0573-00.....	52
5PP580.1043-00.....	67
5PP580.1505-00.....	92
5PP581.1043-00.....	72
5PP581.1505-00.....	97
5PP582.1043-00.....	77
5PP5CP.US15-00.....	245
5PP5CP.US15-01.....	245
5PP5CP.US15-02.....	245
5PP5IF.CETH-00.....	245
5PP5IF.CHDA-00.....	107
5PP5IF.FCAN-00.....	245

5PP5IF.FETH-00.....	245
5PP5IF.FPLM-00.....	245
5PP5IF.FX2X-00.....	245
5PP5IF.FXCM-00.....	245
5PP5IO.GNAC-00.....	121
5SWLIN.0136-MUL.....	232
5SWUTI.0001-000.....	243
5SWWCE.0836-ENG.....	228
5SWWI7.0100-ENG.....	221
5SWWI7.0100-GER.....	221
5SWWI7.0300-MUL.....	221
5SWWI7.0536-ENG.....	225
5SWWI7.0736-MUL.....	225
5SWWI7.1100-ENG.....	221
5SWWI7.1100-GER.....	221
5SWWI7.1300-MUL.....	221
5SWWI7.1536-ENG.....	225
5SWWI7.1736-MUL.....	225
5SWWXP.0600-ENG.....	219
5SWWXP.0600-GER.....	219
5SWWXP.0600-MUL.....	219
5SWWXP.0736-ENG.....	223

A

Abbreviation.....	291
Accessories.....	248
ACPI.....	214, 215
ADI.....	234
.NET SDK.....	238
Development Kit.....	236
air circulation.....	138
ambient temperature.....	134, 135, 136
AP1000.....	291
AP900.....	291
ARemb.....	230
ARwin.....	198, 230
Automation Runtime.....	230
Automation Runtime Embedded.....	230
Automation Runtime Windows.....	230

B

B&R Automation Device Interface.....	234
B&R CompactFlash.....	261
B&R Control Center.....	234
B&R Embedded OS Installer.....	229
B&R KCF Editor.....	242
B&R Key Editor.....	240
Backlight.....	154
backup BIOS.....	159
barcode.....	27
Battery.....	32
BIOS	
ACPI table/features control.....	187
Advanced.....	177
Advanced CPU control.....	198
Boot.....	202
Boot configuration.....	179
Boot type order.....	204
Channel 1 master.....	182
Channel 1 slave.....	183
Console redirection.....	191
CPU board features.....	160
CPU board monitor.....	164
Exit.....	207
Hard disk drive.....	205
I/O board features.....	169
IDE configuration.....	181
IF board features.....	174
Legacy.....	203
LPC devices.....	161, 166, 170
Main.....	158
Memory module features.....	176
OEM features.....	159
Other.....	206
Panel control.....	173
PCI Express root port 1.....	187
PCI Express root port 2.....	190
Peripheral configuration.....	180
Platform power management.....	201
Power.....	197
RAM configuration.....	178
SDIO configuration.....	186
Security.....	194

Set supervisor password.....	195
Set user password.....	196
Statistical values.....	162, 167, 171, 175
System unit features.....	165
Temperature values.....	163, 168, 172
Thermal trip points settings.....	200
USB.....	205
USB configuration.....	185
Video configuration.....	184
BIOS default settings.....	208
BIOS Setup.....	155
BIOS Setup keys.....	157
BIOS upgrade.....	216
Blink code.....	35
boot order.....	202

C

Cable connections.....	143
Cable lengths.....	123, 123
CAN bus interface.....	116
CAN bus master interface.....	115, 120
CAN master interface.....	119
CAN terminating switch.....	116, 120
CE mark.....	244
Certifications.....	245
Germanischer Lloyd.....	245
certifications	
GOST-R.....	245
Certifications	
UL.....	245
Chemical resistance.....	289
Clamping blocks.....	278
Cleaning.....	282, 287
climate-controlled chamber.....	142
COM.....	30, 123
CompactFlash.....	33
Benchmark.....	264
CompactFlash cards.....	252
Compatibilities.....	291
Compatibility overview.....	291
Complete system.....	23
Configuration	
Base system.....	20
Software and accessories.....	21
Control Center.....	139, 234
Creating reports.....	234
Cutout tolerance values.....	291, 293, 295, 297, 298, 299, 299, 300

D

dead/stuck pixels.....	154
Debian.....	232
defective pixels.....	154
deflect disturbances.....	144
Device compatibility.....	291, 291
Device interfaces and slots.....	28
Dimensions	
5A5003.03.....	273
5MD900.USB2-02.....	271
Dimension standards.....	15
Disposal.....	14, 14

dongle.....	231
DVI.....	122
DVI resolution.....	123
DVI transmission.....	123, 123
Dynamic wear leveling.....	252
E	
Electromagnetic compatibility.....	244
EMC directive.....	244
ESD.....	12
Electrical components with a housing.....	12
Electrical components without a housing.....	12
Individual components.....	12
Packaging.....	12
ETH.....	30
Ethernet.....	30
Ethernet interface.....	106, 110
evaluate the temperature.....	140
Evaluating temperatures.....	139
Evaluating the battery status.....	32, 283
example programs.....	142
F	
female Smart Display Link/DVI connector.....	121
Firmware upgrade.....	218
Flex radius.....	143
Flex radius specifications.....	143
Free space.....	138
front USB.....	31
Functional ground.....	144
G	
General tolerance.....	15
Germanischer Lloyd.....	245
GL certification.....	245
GOST-R.....	245
Gosudarstwenny standard.....	245
Ground connection.....	144
Grounding.....	29
Guidelines.....	15
H	
HDA.....	107
HDA sound.....	121
hex switches.....	34
HMI Service Center.....	243
Humidity specifications.....	25
I	
I/O address assignment.....	214
I/O board.....	36
immunity to disturbances.....	144
implementation guide.....	142
Installation	
Mounting orientations.....	133
with clamping blocks.....	128

with retaining clips.....	131
Interface board.....	36, 105
CAN bus interface.....	116
CAN bus master interface.....	120
Ethernet interface.....	106, 110
LED status indicators.....	116, 118, 120
MIC, Line IN, Line OUT.....	107
POWERLINK interface.....	112
X2X Link master interface.....	118, 120
Interfaces.....	28
Interrupt assignment.....	214

K

KCF Editor.....	242
Key Editor.....	240

L

LED.....	35
LED status indicators.....	35, 35, 116, 118, 120
Line filter.....	280
Linux.....	232
loopback plug.....	141
Low voltage directive.....	244

M

Main memory.....	104
Manual history.....	10
MIC, Line IN, Line OUT.....	107, 126
Mode/Node switches.....	34
Mounting compatibility.....	291
Mounting orientation	
0°.....	133
180°.....	137
45°.....	134
90°.....	135
90° vertical.....	136

O

Operating system	
Debian (GNU/Linux).....	232
Windows 7.....	221
Windows CE.....	228
Windows Embedded Standard 2009.....	223
Windows Embedded Standard 7.....	225
Windows XP Professional.....	219
order number.....	27

P

Panel interface.....	122
Panel overlay.....	289
Peripheral USB devices.....	145
Power button.....	34
Power calculation.....	26
Power connectors.....	250
Power failure logic.....	286
Power LED.....	35

POWERLINK.....	111
Link LED.....	112
Speed LED.....	112
Status/Error LED.....	112
System stop error codes.....	114
POWERLINK interface.....	112
Power management.....	26
power supply.....	29, 144
PP100/200.....	291
PP300/400.....	291
PP500.....	291
PP500 configuration.....	20
PPC700.....	291
PPC800.....	291
Product abbreviations.....	291
Proper ESD handling.....	12

R

RAM address assignment.....	214
Relative humidity.....	25
Replacing a CompactFlash card.....	284
Replacing the battery.....	283
Reset button.....	34
Resource distribution	
I/O address assignment.....	214
Retaining clips.....	279
revision.....	27
RS232	
Bus length.....	124
Cable type.....	124
RS422	
Bus length.....	124
Cable type.....	124
RS485	
Bus length.....	125
Cable type.....	125
RS485 interface.....	124

S

Safety guidelines.....	12
Environmental conditions.....	13
Environmentally friendly disposal.....	14
Installation.....	13
Intended use.....	12
Operation.....	13
Policies and procedures.....	12
Protection against electrostatic discharge.....	12
Separation of materials.....	14
Transport and storage.....	13
Screen burn-in.....	154, 154
SDL.....	122
SDL resolution.....	123
SDL transmission.....	123, 123
SD memory card slot.....	33
Serial interface.....	30, 123
serial number sticker.....	27
Service Center.....	243
service life of the display.....	154
Slots.....	28

Smart Display Link.....	122
software versions.....	234
Spacing for air circulation.....	138
Standards and guidelines.....	244
Static wear leveling.....	252

T

Technology Guarding.....	231
Temperature monitoring.....	23, 286
Temperature sensor locations.....	3, 3
Temperature specifications.....	3, 3
temperature testing.....	139
Temperature testing instructions.....	139
Temperature testing procedure.....	139
terminating resistor.....	116, 120
tolerance.....	291, 293, 295, 297, 298, 299, 299, 300
Touch screen calibration.....	153

U

UL certification.....	245
Upgrade	
BIOS.....	216
Firmware.....	218
Upgrade information.....	216
Upgrade problems.....	218
USB.....	31, 126
USB flash drive.....	275
USB media drive.....	269
user serial ID.....	234

V

Viewing angles.....	290
---------------------	-----

W

WES2009.....	223
WES7.....	226
Windows 7.....	221, 221
Windows CE.....	228, 228
Windows CE 6.0 features.....	228
Windows Embedded Standard 2009.....	223
Windows Embedded Standard 7.....	225
Windows XP Professional.....	219, 219

X

X2X Link master interface.....	117, 118, 119, 120
--------------------------------	--------------------