



650 Series AC Drive

Frame 1, 2 & 3

Product Manual

HA464828U003 Issue 7

Compatible with Version 4.9 Software onwards

WARRANTY

Parker SSD Drives warrants the goods against defects in design, materials and workmanship for the period of 12 months from the date of delivery on the terms detailed in Parker SSD Drives Standard Conditions of Sale IA058393C.

Parker SSD Drives reserves the right to change the content and product specification without notice.

© Copyright 2007 Parker SSD Drives, a division of Parker Hannifin Ltd.

All rights strictly reserved. No part of this document may be stored in a retrieval system, or transmitted in any form or by any means to persons not employed by a Parker SSD Drives company without written permission from Parker SSD Drives, a division of Parker Hannifin Ltd. Although every effort has been taken to ensure the accuracy of this document it may be necessary, without notice, to make amendments or correct omissions. Parker SSD Drives cannot accept responsibility for damage, injury, or expenses resulting therefrom.

Safety Information



Requirements

IMPORTANT: Please read this information BEFORE installing the equipment.

Intended Users

This manual is to be made available to all persons who are required to install, configure or service equipment described herein, or any other associated operation.

The information given is intended to highlight safety issues, EMC considerations, and to enable the user to obtain maximum benefit from the equipment.

Complete the following table for future reference detailing how the unit is to be installed and used.

INSTALLATION DETAILS	
Serial Number <i>(see product label)</i>	
Where installed <i>(for your own information)</i>	
Unit used as a: <i>(refer to Certification for the Inverter)</i>	<input type="checkbox"/> Component <input type="checkbox"/> Relevant Apparatus
Unit fitted:	<input type="checkbox"/> Wall-mounted <input type="checkbox"/> Enclosure

Application Area

The equipment described is intended for industrial motor speed control utilising AC induction or AC synchronous machines.

Personnel

Installation, operation and maintenance of the equipment should be carried out by qualified personnel. A qualified person is someone who is technically competent and familiar with all safety information and established safety practices; with the installation process, operation and maintenance of this equipment; and with all the hazards involved.

Product Warnings

	Caution Risk of electric shock		Caution Refer to documentation		Earth/Ground Protective Conductor Terminal
--	--	--	--	--	--

Safety Information



Hazards

DANGER! - Ignoring the following may result in injury

1. This equipment can endanger life by exposure to rotating machinery and high voltages.
2. The equipment must be permanently earthed due to the high earth leakage current, and the drive motor must be connected to an appropriate safety earth.
3. Ensure all incoming supplies are isolated before working on the equipment. Be aware that there may be more than one supply connection to the drive.
4. There may still be dangerous voltages present at power terminals (motor output, supply input phases, DC bus and the brake, where fitted) when the motor is at standstill or is stopped.
5. For measurements use only a meter to IEC 61010 (CAT III or higher). Always begin using the highest range. CAT I and CAT II meters must not be used on this product.
6. Allow at least 5 minutes for the drive's capacitors to discharge to safe voltage levels (<50V). Use the specified meter capable of measuring up to 1000V dc & ac rms to confirm that less than 50V is present between all power terminals and earth.
7. Unless otherwise stated, this product must NOT be dismantled. In the event of a fault the drive must be returned. Refer to "Routine Maintenance and Repair".

WARNING! - Ignoring the following may result in injury or damage to equipment

SAFETY

Where there is conflict between EMC and Safety requirements, personnel safety shall always take precedence.

- Never perform high voltage resistance checks on the wiring without first disconnecting the drive from the circuit being tested.
- Whilst ensuring ventilation is sufficient, provide guarding and /or additional safety systems to prevent injury or damage to equipment.
- When replacing a drive in an application and before returning to use, it is essential that all user defined parameters for the product's operation are correctly installed.
- All control and signal terminals are SELV, i.e. protected by double insulation. Ensure all external wiring is rated for the highest system voltage.
- Thermal sensors contained within the motor must have at least basic insulation.
- All exposed metalwork in the Inverter is protected by basic insulation and bonded to a safety earth.
- RCDs are not recommended for use with this product but, where their use is mandatory, only Type B RCDs should be used.

EMC

- In a domestic environment this product may cause radio interference in which case supplementary mitigation measures may be required.
- This equipment contains electrostatic discharge (ESD) sensitive parts. Observe static control precautions when handling, installing and servicing this product.
- This is a product of the restricted sales distribution class according to IEC 61800-3. It is designated as "professional equipment" as defined in EN61000-3-2. Permission of the supply authority shall be obtained before connection to the low voltage supply.

CAUTION!

APPLICATION RISK

- The specifications, processes and circuitry described herein are for guidance only and may need to be adapted to the user's specific application. We can not guarantee the suitability of the equipment described in this Manual for individual applications.

RISK ASSESSMENT

Under fault conditions, power loss or unintended operating conditions, the drive may not operate as intended.

In particular:

- Stored energy might not discharge to safe levels as quickly as suggested, and can still be present even though the drive appears to be switched off
- The motor's direction of rotation might not be controlled
- The motor speed might not be controlled
- The motor might be energised

A drive is a component within a drive system that may influence its operation or effects under a fault condition.

Consideration must be given to:

- Stored energy
- Supply disconnects
- Sequencing logic
- Unintended operation

650 Quick Start

- Mount the drive vertically in a lockable cubicle.
- Is the drive to operate in Local (using the keypad) or Remote Control?
If Remote Control, make Control Connections.
- Make Power Connections. Power-on and follow the Quick Set-Up procedure.
- Apply a small setpoint. Start and stop the motor.

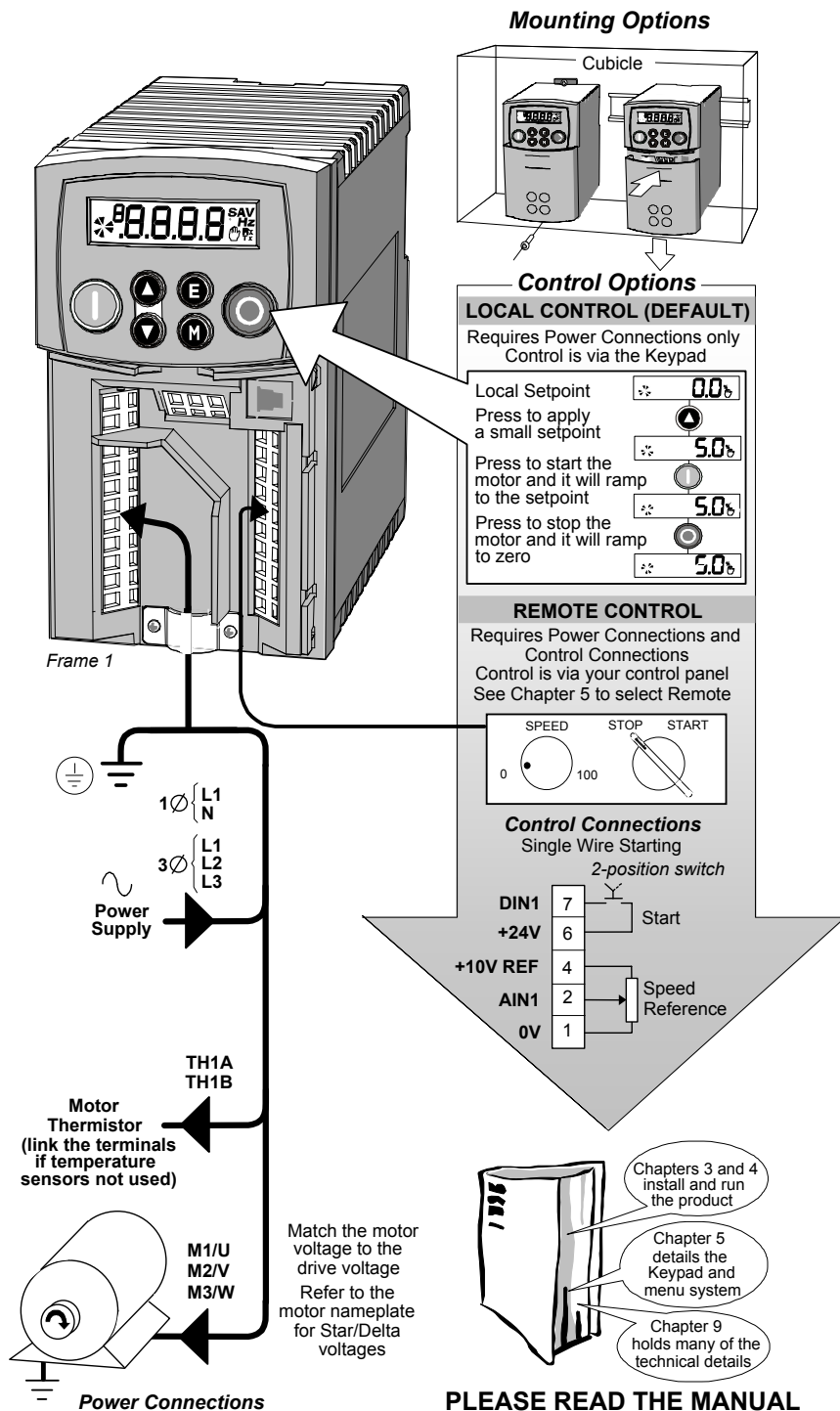

Quick Set-Up

Hold the M key until DIAG is displayed

Navigate to the PAR menu

Press to enter the menu and see the first parameter

Press to show the next parameter

Press to edit the MAX SPEED parameter

Adjust MAX SPEED

Press to exit the parameter

Press (4 times) to show P6

Press to edit the MOTOR CURRENT parameter

Adjust MOTOR CURRENT
Refer to motor nameplate

Press to exit the parameter

Press to show P7

Press to edit the BASE FREQUENCY parameter

Adjust BASE FREQUENCY

Press (3 times) to display the Local Setpoint

POWER-ON

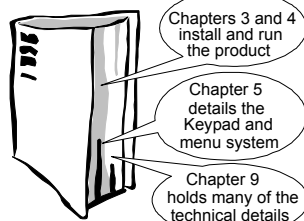
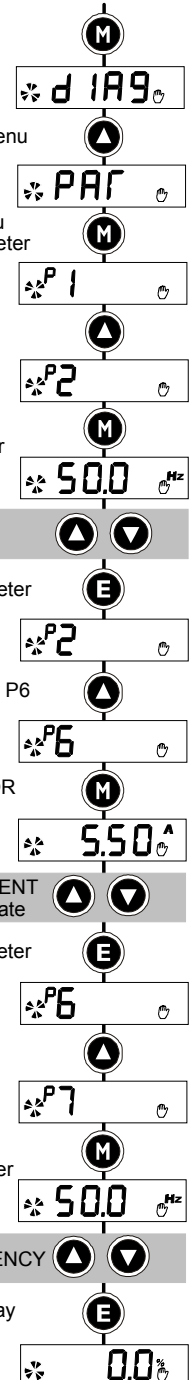

PLEASE READ THE MANUAL

Contents

	Page
Chapter 1 GETTING STARTED	
Introduction	1-1
Equipment Inspection	1-1
Storage and Packaging	1-1
About this Manual	1-1
• Software Product Manual	1-1
Chapter 2 AN OVERVIEW OF THE DRIVE	
Component Identification	2-1
Chapter 3 INSTALLING THE DRIVE	
Mechanical Installation	3-1
Mounting the Drive.....	3-1
Ventilation	3-1
Electrical Installation	3-2
Wiring Instructions.....	3-2
• Local Control Wiring	3-2
• Remote Control Wiring.....	3-2
Connection Diagram.....	3-3
• Control Wiring Connections	3-4
• Power Wiring Connections	3-4
• Terminal Block Acceptance Sizes.....	3-5
Optional Equipment	3-6
• Fitting the Remote 6511 Keypad	3-6
• Fitting the Remote 6521/6901/6911 Keypad	3-7
• RS485/RS232 Communication Module	3-8
• Line Choke	3-10
Chapter 4 OPERATING THE DRIVE	
Pre-Operation Checks	4-1
Initial Start-up Routines	4-1
Local Control Operation.....	4-2
Remote Control Operation	4-2
Chapter 5 THE KEYPAD	
Controlling the Drive using the Keypad	5-1
Control Key Definitions	5-1
Display Indications	5-2
Drive Status Indications.....	5-2
The DIAGNOSTICS Menu	5-2
The Menu System	5-3
How To Change a Parameter Value	5-4
Special Menu Features	5-4
Resetting to Factory Defaults (2-button reset).....	5-4
Changing the Drive Operating Frequency	5-4
Selecting Local or Remote Control.....	5-4
Password Protection	5-5
Quick Application Selection	5-5
Selecting the Menu Detail	5-5
Chapter 6 PROGRAMMING YOUR APPLICATION	
MMI Parameters	6-1
• Configuring Terminal 10 (Digital Input/Output).....	6-8
• PID - Tuning Your Drive	6-8
• Auto Restart	6-9
• Skip Frequencies.....	6-10

Contents

Contents	Page
• Minimum Speed Mode	6-11
Product-Related Default Values	6-11
• * Frequency Dependent Parameters	6-11
• ** Power Dependent Parameters	6-12
Chapter 7 TRIPS AND FAULT FINDING	
Trips	7-1
Trip Warning Message	7-1
What Happens when a Trip Occurs	7-1
Resetting a Trip Condition	7-1
Using the Keypad to Manage Trips	7-1
Hexadecimal Representation of Trips	7-4
Fault Finding	7-5
Chapter 8 ROUTINE MAINTENANCE AND REPAIR	
Routine Maintenance	8-1
Repair	8-1
Saving Your Application Data	8-1
Returning the Unit to Parker SSD Drives	8-1
Disposal	8-1
Chapter 9 TECHNICAL SPECIFICATIONS	
Understanding the Product Code	9-1
• Model Number (Europe)	9-1
• Catalog Number (North America)	9-2
Environmental Details	9-3
Power Details	9-3
User Relay	9-3
Electrical Ratings	9-4
Analog Inputs/Outputs	9-5
Digital Inputs	9-5
Digital Outputs	9-5
Cabling Requirements for EMC Compliance	9-5
Internal Dynamic Braking Circuit	9-6
External Brake Resistor	9-6
Supply Harmonic Analysis (230V filtered)	9-7
Supply Harmonic Analysis (400V filtered)	9-8
Supply Harmonic Analysis (230V unfiltered)	9-9
Supply Harmonic Analysis (400V unfiltered)	9-10
Chapter 10 CERTIFICATION FOR THE DRIVE	
Requirements for EMC Compliance	10-1
Earthing Requirements	10-1
Requirements for UL Compliance	10-1
European Directives and the CE Mark	10-3
CE Marking for Low Voltage Directive	10-3
CE Marking for EMC - Who is Responsible?	10-3
EMC Compliance	10-3
Certificates	10-4
Chapter 11 SERIAL COMMUNICATIONS	
Connection to the P3 Port	11-1
Chapter 12 APPLICATIONS	
The Default Application	12-1
How to Load an Application	12-1
Application Description	12-1

GETTING STARTED

Introduction

The 650 Series AC Drive provides simple, compact, and low-cost speed control for 3-phase induction motors.

It operates as an Open-loop Inverter (V/F Fluxing).

This manual describes the low-power end of the 650 product range for the following motor power ratings:

	Nominal Input Voltage	Phase	Drive Power	
Frame 1	230V	1	0.25 – 0.75kW	0.3 - 1.0 Hp
Frame 2	230V	1	1.1 – 1.5kW	1.5 - 2.0 Hp
Frame 2	400V	3	0.37 – 2.2kW	0.5 - 3.0 Hp
Frame 3	230V	1	2.2kW	3.0 Hp
Frame 3	230V	3	2.2 – 4.0kW	3.0 - 5.0 Hp
Frame 3	400V	3	3.0 – 7.5kW	4.0 - 10.0 Hp

The drive features:

- Local or Remote mode operation
- Support for RS485 and Modbus RTU comms protocols
- SELV control terminals (Safe Extra Low Volts)
- Intelligent monitoring strategy to avoid nuisance tripping
- In-built protection of the unit against overloads, excessive voltages, phase-to-phase and phase-to-earth short circuits
- An internal RFI filter is fitted as standard
- An internal dynamic brake switch for connection to an external resistor (Frame 3: 230V, and 400V units only)
- Quiet operation

Note: Do not attempt to control motors whose rated current is less than 50% of the drive rated current. Poor motor control or Autotune problems may occur if you do.

Equipment Inspection

- Check for signs of transit damage
- Check the drive is suitable for your requirements by reading the Product Code on the rating label. Refer to Chapter 9: “Technical Specifications” - Understanding the Product Code.

If the unit is damaged, refer to Chapter 8: “Routine Maintenance and Repair” for information on returning damaged goods.

Storage and Packaging

Save the packaging in case of return. Improper packaging can result in transit damage.

If the unit is not being installed immediately, store the unit in a well-ventilated place away from high temperatures, humidity, dust or metal particles.

About this Manual

This manual is intended for use by the installer, user and programmer of the drive. It assumes a reasonable level of understanding in these three disciplines.

Note: Please read all Safety Information before proceeding with the installation and operation of this unit.

It is important that you pass the manual on to any new user of this unit.

Software Product Manual

An accompanying Software Product Manual is available for download from the Parker SSD Drives website: www.SSDdrives.com.

AN OVERVIEW OF THE DRIVE

Component Identification

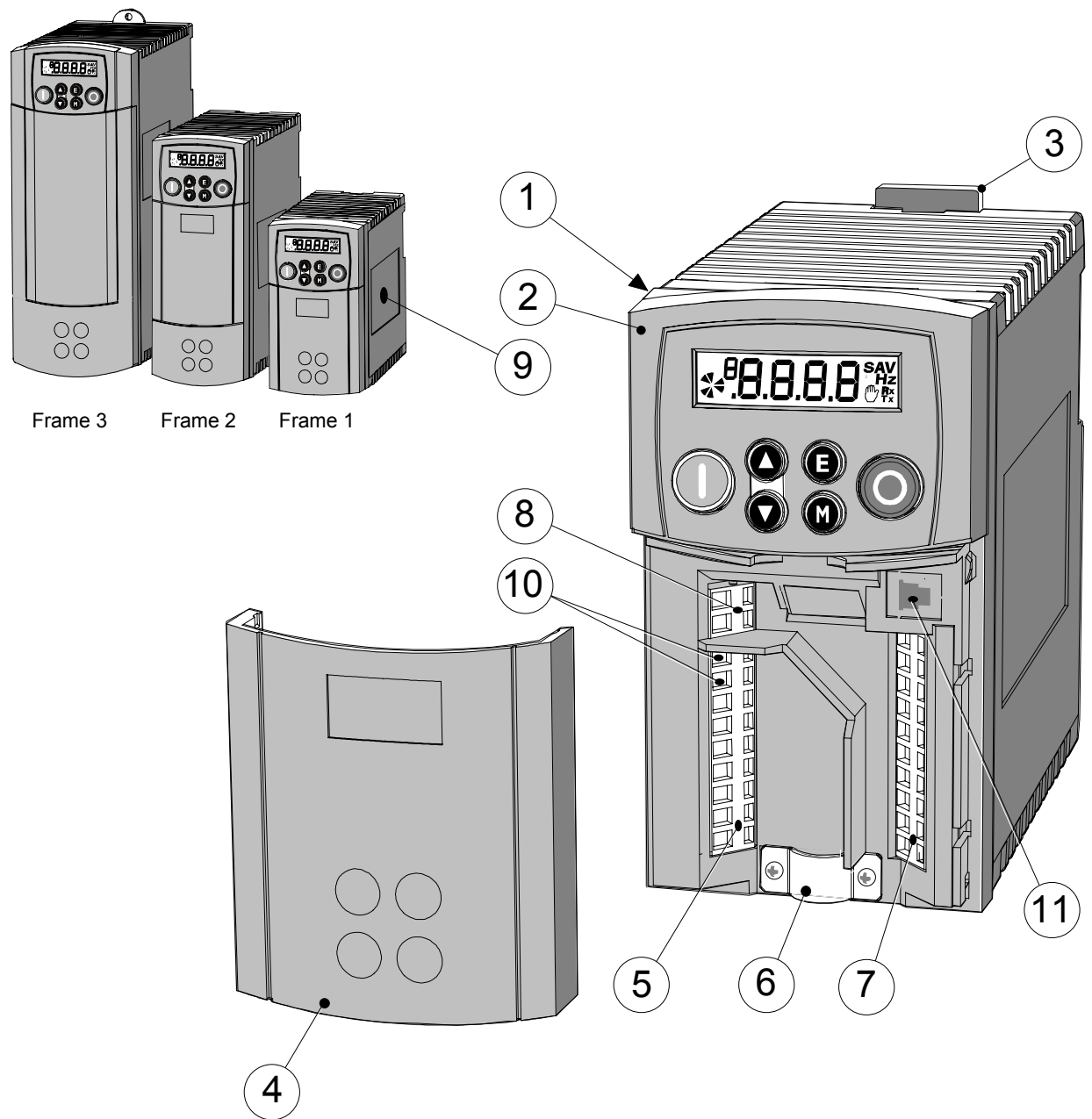

Figure 2-1 View of Component Parts (Frame 1 illustrated)

1	Main drive assembly	7	Control terminals
2	Keypad	8	Volt-free relay contacts
3	DIN clip/fixing bracket	9	Product rating label
4	Terminal cover	10	Motor thermistor terminals
5	Power terminals	11	RS232 port - P3 (optional)
6	Motor cable screen clamp		

INSTALLING THE DRIVE

IMPORTANT: Read Chapter 10: "Certification for the Drive" before installing this unit.

Mechanical Installation

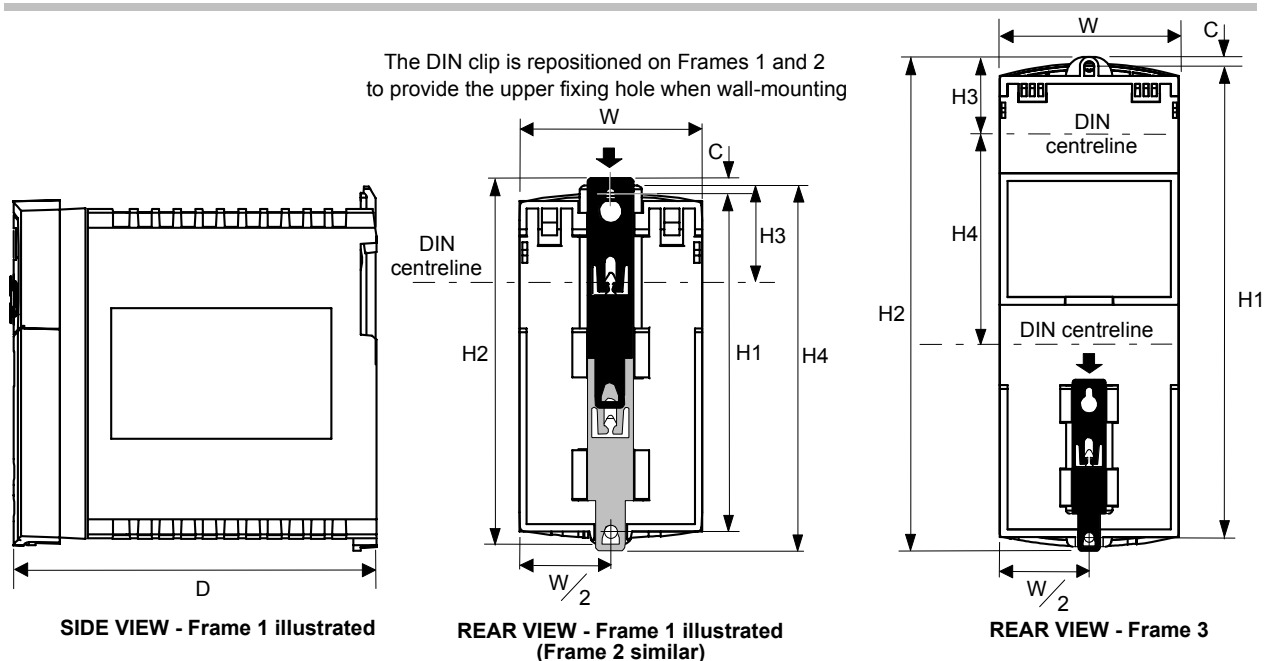

	Fixing	Torque	Weight	H1 Fixing Centres	H2	H3	H4	C	W	D
Frame 1	M4	1.5Nm	0.85kg	132 (5.2")	143 (5.6")	35 (1.4")	139 (5.5")	6 (0.2")	73 (2.9")	142 (5.6")
Frame 2	M5	3.0Nm	1.4kg	188 (7.4")	201 (7.9")	35 (1.4")	194 (7.7")	6.5 (0.24")	73 (2.9")	173 (6.8")
Frame 3	M5	3.0Nm	2.7kg	242 (9.5")	260 (10.2")	38 (1.5")	112 (4.4")	5 (0.2")	96 (3.8")	200 (7.9")

Dimensions are in millimetres (inches)

Mounting the Drive

To maintain compliance with European Electrical Safety Standard VDE0160(1994)/EN50178 (1998) the unit must be mounted inside a control cubicle that requires a tool for opening. The cubicle should provide 15dB attenuation to radiated emissions between 30-100MHz.

Mount the drive vertically on a solid, flat, non-flammable, vertical surface. It can be panel-mounted, or rail-mounted on a rail complying with EN50022 (35mm DIN).

DIN Mounting

To DIN mount the unit, hang the unit on the top DIN rail and push the unit onto the bottom DIN rail until it snaps in to position. Secure with a lower screw fixing. To release the unit, use a flat bladed screwdriver as shown.

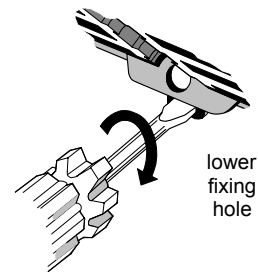

Ventilation

Maintain a minimum air clearance for ventilation of 100mm (4 inches) above and below the unit. When mounting two or more 650 units together, these clearances are additive. Ensure that the mounting surface is normally cool. Be aware that adjacent equipment may generate heat and also have clearance requirements. Provided the minimum clearance for ventilation is maintained, 650 drives may be mounted side-by-side.

3-2 Installing the Drive

Electrical Installation

IMPORTANT: Read the Safety Information on page Cont. 2 before proceeding.

Wiring Instructions

Local Control Wiring

This is the simplest installation. Every new drive will operate in Local Control when first powered-up. The keypad is used to start and stop the drive.

Refer to the Connection Diagram and install the:

- Thermistor cable, or link/jumper terminals TH1A and TH1B if not used (we recommend you use a thermistor)
- Motor cable
- Supply cable
- Follow the earthing/grounding and screening advice

Refer to Chapter 4: "Operating the Drive"- Local Control Operation.

Minimum Connections

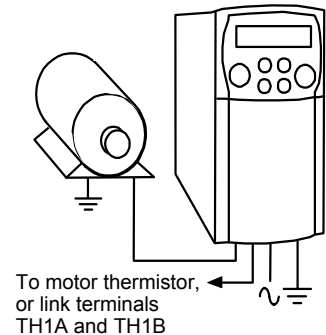

Remote Control Wiring

If operating in Remote Control you will use your control panel to start and stop the drive, via a speed potentiometer and switches or push-buttons.

Your wiring of the control terminals will be governed by the Application you use: refer to Chapter 12 for an explanation of the various Applications you can select and the appropriate control wiring. Application 1 is the default Application.

The diagram below shows the **minimum** connections to operate the drive for single-wire (switch) starting, and push-button starting. Other control connections for your Application, shown in Chapter 12, and can be made to suit your system.

Referring to the Connection Diagram:

- Follow the instructions for Local Control Wiring, as detailed above
- Install using minimum connections (suitable for Application 1 only), or refer to Chapter 12 and install the appropriate control wiring for your system

Minimum Connections for Application 1:

Single Wire Starting

Push-Button Starting

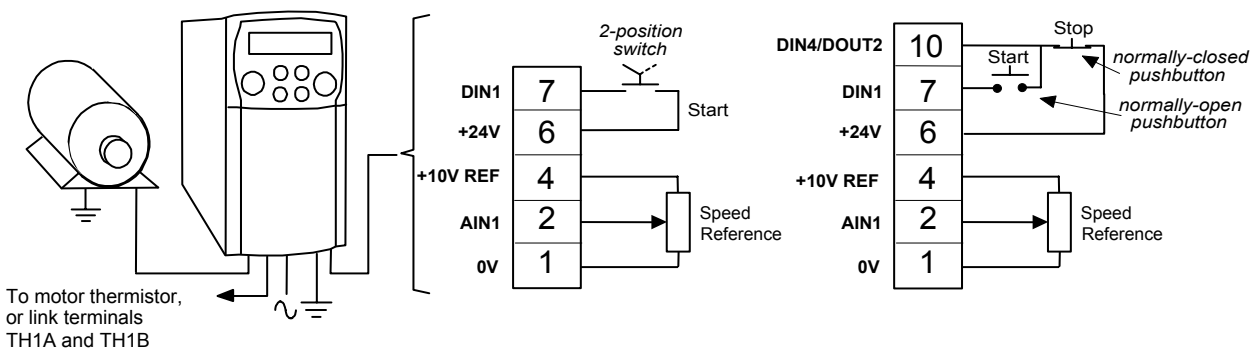

Note: You can still operate the drive in Local mode, if necessary, with any Application selected.

Refer to Chapter 4: "Operating the Drive" and follow the relevant instructions for Single Wire Starting or Push-Button Starting.

WARNING!

This product is designated as "professional equipment" as defined in EN61000-3-2. Where enforced, permission of the supply authority shall be obtained before connection to the low voltage domestic supply.

Ensure that all wiring is electrically isolated and cannot be made "live" unintentionally by other personnel.

The drive is suitable for use with both earth referenced supplies (TN) and non-earth referenced supplies (IT) when fitted with an internal ac supply EMC filter.

Connection Diagram

Frame 2
3Ø 380-460V ac
 (see Power Terminal Variations inset for other frame sizes)

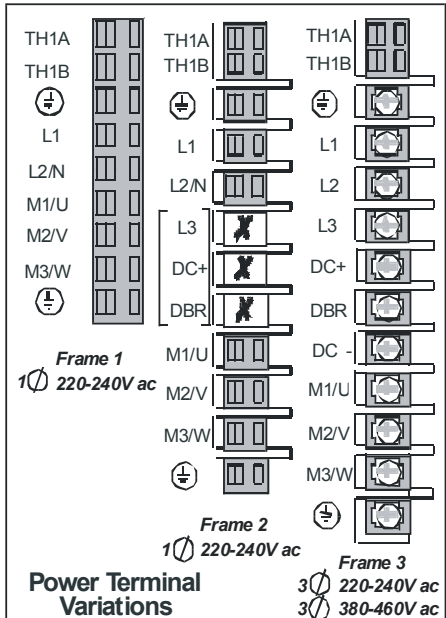
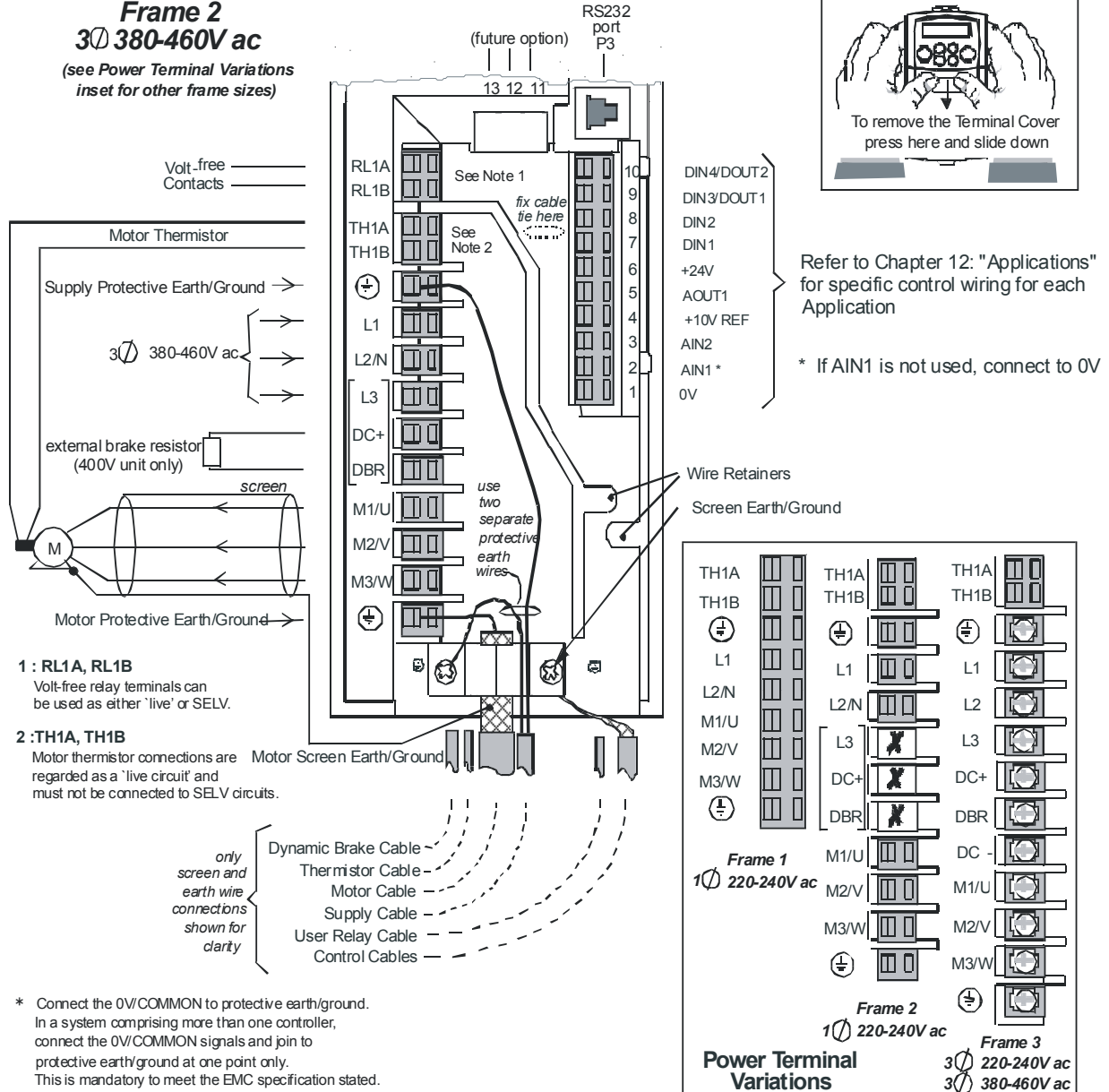

Wiring Instructions

- 1 Remove the terminal cover from the drive.
- 2 Loosen the motor cable screen damp.
- 3 Connect the power supply cable, motor cable and control cables (if required).
- 4 Fasten the motor cable in place with the motor cable screen damp. Secure any control cable screen connections under the right hand screw. *Frames 2 & 3 only: Secure control cables under the wire retainers.*
- 5 Connect the thermistor and user relay if required. *Frames 2 & 3 only: connect the dynamic brake if required (3 phase units only).*
- 6 Use a cable tie and secure all the control cables and user-relay cables (if fitted) as close to the control terminals as possible.
- 7 Connect the ancillary equipment as shown, for example, an external brake resistor.
- 8 Re-fit the terminal cover.

IMPORTANT:

Note that the 650 unit must be **permanently earthed** using two independent protective earth/ground incoming supply conductors.

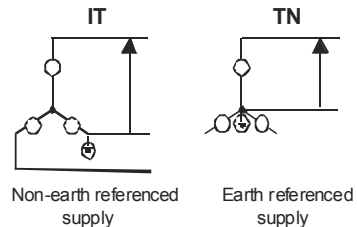



The drive is suitable for use with earth referenced supplies (TN) and non-earth referenced supplies (IT) when fitted with an internal ac supply EMC filter.

3-4 Installing the Drive

Control Wiring Connections

Terminal (SELV)	Description	Application 1 Default Function (for other Applications refer to Chapter 12: "Applications")	Range
P3	P3	RS232 port for use with remote-mounted RS232 keypad or programming PC	-
RL1A	User Relay	Volt-free contact	0-250Vac/24Vdc 4A
RL1B	User Relay	Volt-free contact	0-250Vac/24Vdc 4A
10	DIN4/ DOUT2	Configurable digital input/output Not Stop (input): 0V = No latching of Run (DIN1), 24V = Run latched	0-24V source open collector 50mA maximum
9	DIN3/ DOUT1	Jog – configurable digital input: 0V = Stop, 24V = Jog	0-24V
8	DIN2	Direction – configurable digital input: 0V = Forward, 24V = Reverse	0-24V
7	DIN1	Run – configurable digital input: 0V = Stop, 24V = Run	0-24V
6	+24V	24V – 24V supply for digital I/O	50mA maximum
5	AOUT1	Ramp Output – configurable analog output (10mA loading)	0-10V
4	10VREF	10V - 10V reference (10mA maximum loading)	10V
3	AIN2	Feedback – analog input 2	0-10V, 4-20mA
2	AIN1	Setpoint – analog input 1. If AIN 1 is not used, connect to 0V.	0-10V
1	0V	0V - 0V reference for analog/digital I/O	0V

Power Wiring Connections

Terminal	Description	Function	Range	
			200V 1-Phase	200V/400V 3-Phase
TH1A	Thermistor	Connection to motor thermistor	It is good practice to protect motors by fitting temperature sensitive resistors. A typical resistance (up to a reference temperature of 125°C) is 200Ω, rising rapidly to 2000Ω above this temperature. Connect devices in series between TH1A and TH1B. Link the terminals if temperature sensors are not used.	
TH1B	Thermistor	Connection to motor thermistor		
	Reference Terminal	Supply protective earth (PE). This terminal must be connected to a protective (earth) ground for permanent earthing .		
L1	Power Input	Single and three phase live connection	220/240V ac ±10% rms with respect to L2/N. 50-60Hz (IT/TN)	220/240V or 380/460V ac ±10% rms with respect to L2, L3 phase-to-phase. 50-60Hz (IT/TN)
L2/N L2	Power Input	Single phase neutral (or L2 three phase live connection)	220/240V ac ±10% with respect to L1. 50-60Hz (IT/TN)	220/240V or 380/460V ac ±10% with respect to L1, L3. 50-60Hz (IT/TN)
L3	Power Input	Three phase live connection	Not applicable	220/240V or 380/460V ac ±10% with respect to L1, L2. 50-60Hz (IT/TN)
DC-	No user connection			
DC+	Dynamic Brake	Connection to external brake resistor	Not applicable	Frame 2 (high volt only) & 3. See "Internal Dynamic Brake Switch" table
DBR	Dynamic Brake	Connection to external brake resistor	Not applicable	Frame 2 (high volt only) & 3. See "Internal Dynamic Brake Switch" table
M1/U M2/V M3/W	Motor Outputs	Connection for motor	Motor rated at: 0 to 220/240V ac 0 to 240Hz	Motor rated at: 0 to 220/240V or 380/460V ac 0 to 240Hz
	Reference Terminal	Supply protective earth (PE). This terminal must be connected to a protective (earth) ground for permanent earthing .		

Terminal Block Acceptance Sizes

Wire sizes should be chosen with respect to the operating conditions and your local National Electrical Safety Installation Requirements. Local wiring regulations always take precedence.

Frame Size	Power Terminals (maximum wire size)	Brake Terminals (maximum wire size)	Thermistor/Control Terminals (maximum wire size)
Frame 1	2.5mm ² /12 AWG	Not Applicable	2.5mm ² /12 AWG
Frame 2 200V	2.5mm ² /12 AWG	Not Applicable	2.5mm ² /12 AWG
Frame 2 400V	2.5mm ² /12 AWG	2.5mm ² /12 AWG	2.5mm ² /12 AWG
Frame 3 230V	6.0mm ² /10 AWG	6.0mm ² /10 AWG	2.5mm ² /12 AWG
Frame 3 400V	6.0mm ² /10 AWG	6.0mm ² /10 AWG	2.5mm ² /12 AWG

Power Wiring

Note: For specified EMC emission and immunity performance, install to EMC Installation Instructions. Refer to Chapter 10: "Certification for the Drive" - for more information

Terminal tightening torque for Frame 3 power connections is 20 lb.in (2.26Nm).

Protect the incoming mains supply using the specified fuse, or RCD circuit breaker Type B.

IMPORTANT: We do not recommend the use of circuit breakers (e.g. RCD, ELCB, GFCI), however, where their use is mandatory, they must:

- Operate correctly with dc and ac protective earth currents (i.e. type B RCDs as in Amendment 2 of IEC755).
- Have adjustable trip amplitude and time characteristics to prevent nuisance tripping on switch-on.

Control Wiring

Control wiring of between 0.08mm² (28AWG) and 2.5mm² (12AWG) can be used. Ensure all wiring is rated for the highest system voltage. All control terminals are SELV (Safe Extra Low Voltage), i.e. double-insulated from power circuits.

Using Cage Clamp Terminals

Strip the wire insulation to 5-6mm (0.20-0.24 inches), or alternatively use wire-crimps. Insert a flat-bladed screwdriver, maximum blade size 3.5mm. The cage provides the correct force for a secure connection.

IMPORTANT: DO NOT lever or turn the screwdriver.

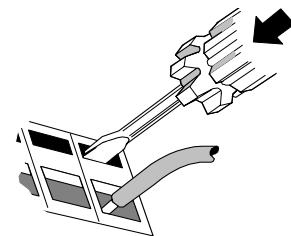

3-6 Installing the Drive

Optional Equipment

Fitting the Remote 6511 Keypad

You can remote-mount the drive-mounted Keypad using:

- the (optional) RS232 (P3) port located under the terminal cover
- A standard P3 lead, Parker SSD Drives' Part Number CM057375U300, which is used to connect the Keypad to the drive.

Two self-tapping screws are provided with the Keypad. Remove the protective film from the gasket. An enclosure rating of IP54 is achieved for the remote Keypad when correctly mounted.

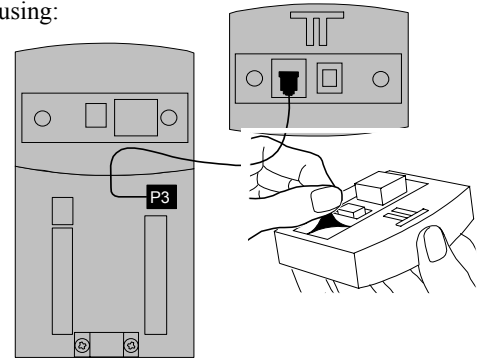

Assembly Procedure

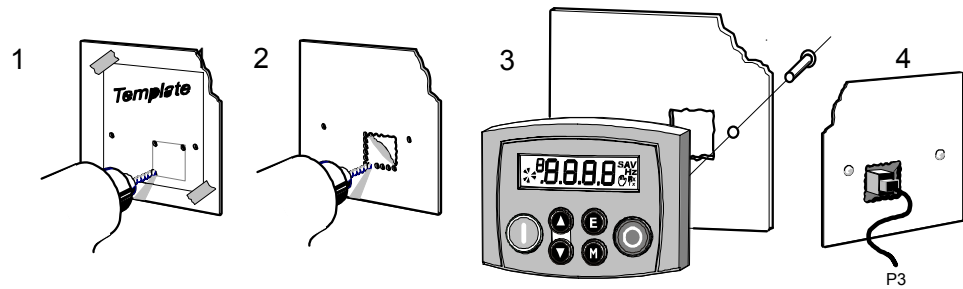

Cut-out Dimensions

The drawing below can be photocopied actual size (100%) and used as a template.

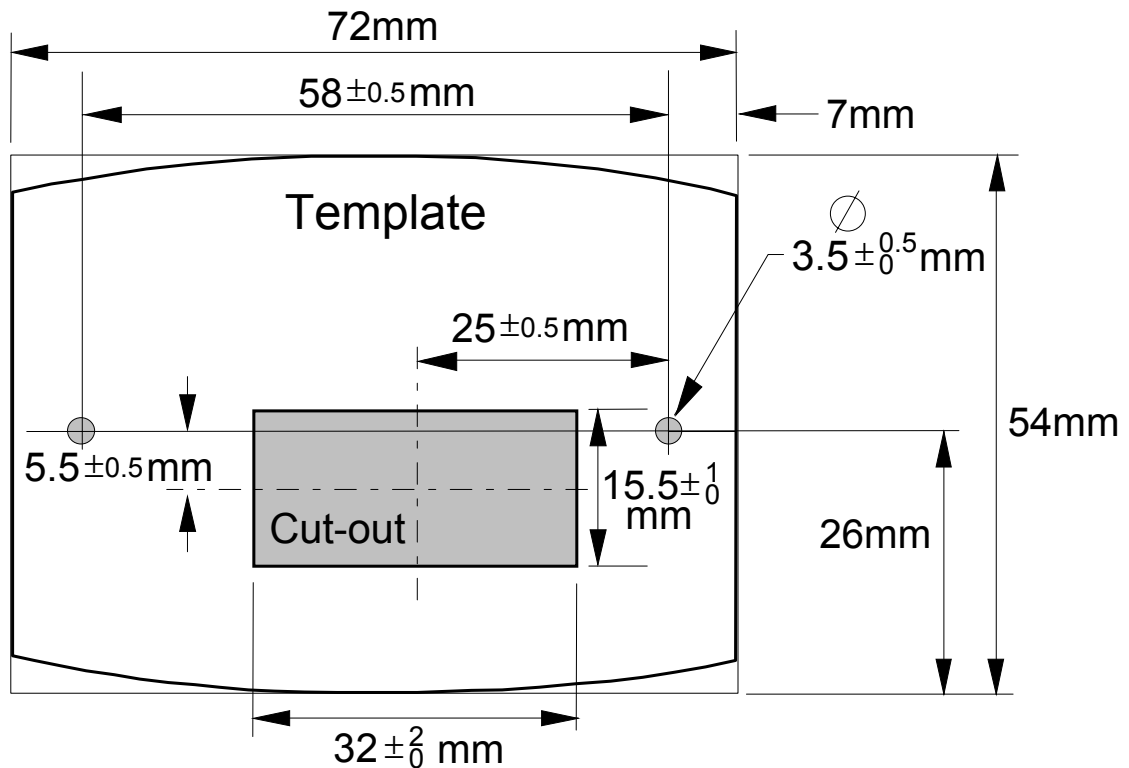





Fitting the Remote 6521/6901/6911 Keypad

The 6052 Mounting Kit is required to remote-mount a 6521 Keypad. An enclosure rating of IP54 is achieved for the remote Keypad when correctly mounted using the 6052 Mounting Kit.

6052 Mounting Kit Parts for the Remote Keypad

Tools Required

No. 2 Posidrive screwdriver.

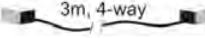
6052 Mounting Kit					
1		1		1	 Steward 28A2025-OAO
4	 No. 6 x 12mm		1	 3m, 4-way	

Assembly Procedure

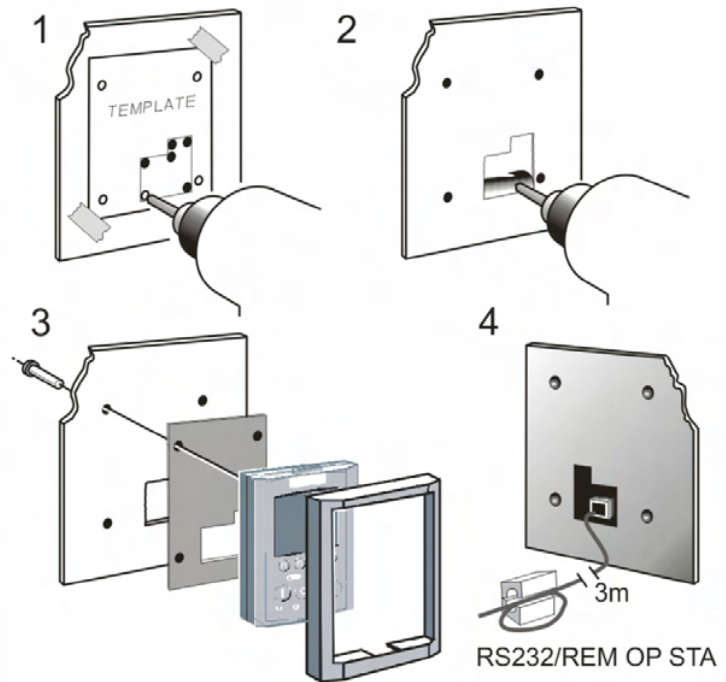

Cutout Dimensions

An actual size template is provided with the Keypad/6052 Mounting Kit.

Figure 3-1 Mounting Dimensions for the Remote-Mounted Keypad 6521/6901/6911

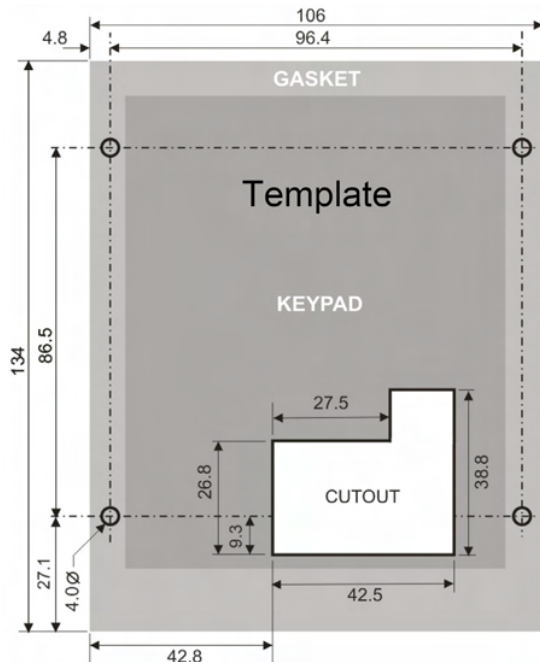
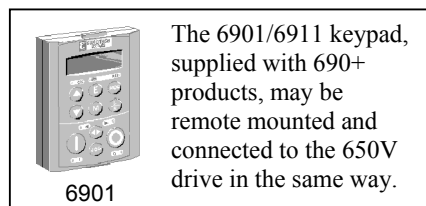

3-8 Installing the Drive

RS485/RS232 Communication Module

You can create a network of drives by linking a Master (PC/PLC) to one or more 650 drives fitted with this module.

Plug this Communication Module on to the front of the 650 drive, replacing the keypad.

It converts signals from the host 650 drive into RS485 or RS232, and vice versa, so that information can be shared between the Master and 650 drive(s).

Wiring is very simple - all connections are SELV (Safe Extra Low Voltage). Select to use RS485 or RS232 by wiring to the appropriate terminal on the module.

Note: RS485 and RS232 terminals cannot be used simultaneously.

We recommend you ground the module to the system earth using the Functional Earth terminal.

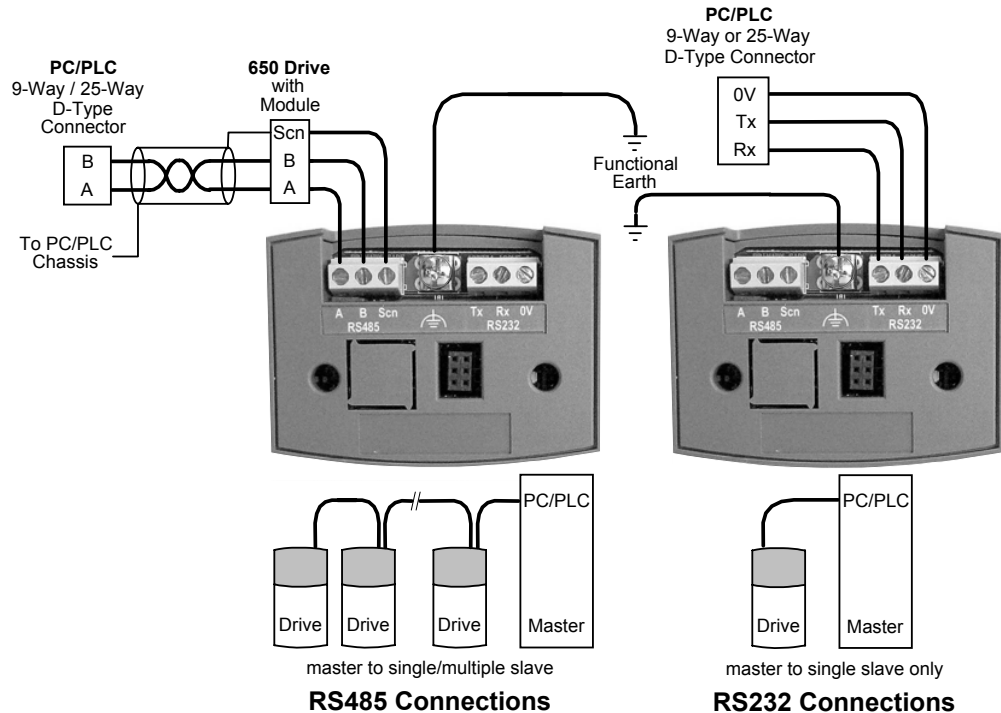





Wiring Specifications		
	RS485 Connections	RS232 Connections
Network Type	2-Wire Shielded Twisted-Pair	3-Wire Un-Shielded Cable
Connections	A=RxA/TxA, B=RxB/TxB, Shield	Rx, Tx, Ground (0V)
Signal Levels	To RS485 Standard	To RS232 Standard
Receiver Input Impedance	¼ Unit Load	3 kΩ minimum 7kΩ maximum
Maximum Cable Length	1200m (4000ft)	3 metres
Maximum Baud Rate	57.6kbaud	57.6kbaud
Maximum Number of Units	32 including slaves and masters	2: 1 master and 1 slave only

LED Indications

The module has three LEDs providing diagnostic information about the 650 host drive's 'Health', 'Receive' and 'Transmit' activity.

HEALTH = Green, Rx = Red, Tx =Red



LED Name	LED Duty	Drive State
HEALTH	 SHORT FLASH	Re-configuration, or corrupted non-volatile memory at power-up
	 EQUAL FLASH	Tripped
	 ON	Healthy
	 LONG FLASH	Braking
	 OFF	No drive power, or serious hardware fault
Rx	INTERMITTENT	Indicates activity on the 'receive' line carrying data from the Master
Tx	INTERMITTENT	Indicates activity on the 'transmit' line carrying data to the Master

Configure the Drive

Before the module can be used you must configure the drive to your system. Set-up the parameters in the SERIAL menu as appropriate. Refer to Chapter 6: "Programming Your Application" - SET::SERL Menu, parameters ^SSE01 to ^SSE08.

For Tag number information refer to the 650 Software Product Manual, available on the Parker SSD Drives website: www.SSDdrives.com.

Note: This Option can only be used on drives using software version 4.1 or higher.

3-10 Installing the Drive

Line Choke

Cables are considered to be electrically sensitive, clean or noisy. A line choke is used to reduce harmonic emission to meet the limits of EN61000-3-2.

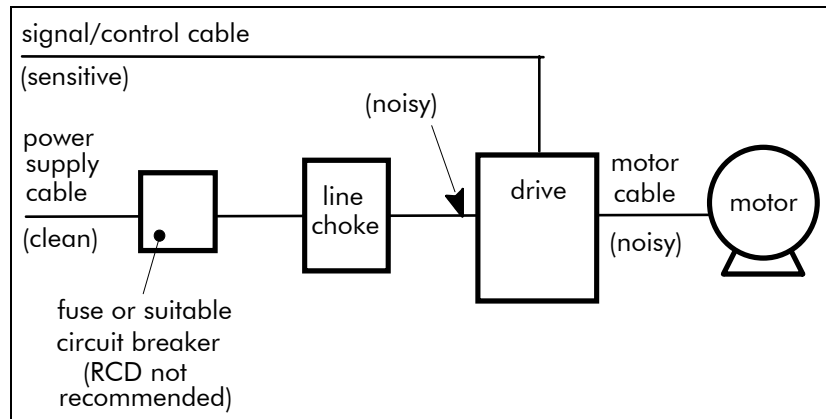

The choke is for use on the following drive:

Phase	Drive Nominal Input Voltage (V)	Drive Power (kW/hp)	Rated Current (A _{eff})	Rated Inductivity (mH)	Choke Part Number
3	400	0.37/0.5	6	4.88	CO467763U003 (Europe)

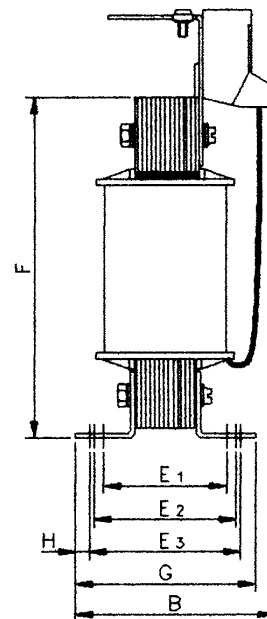
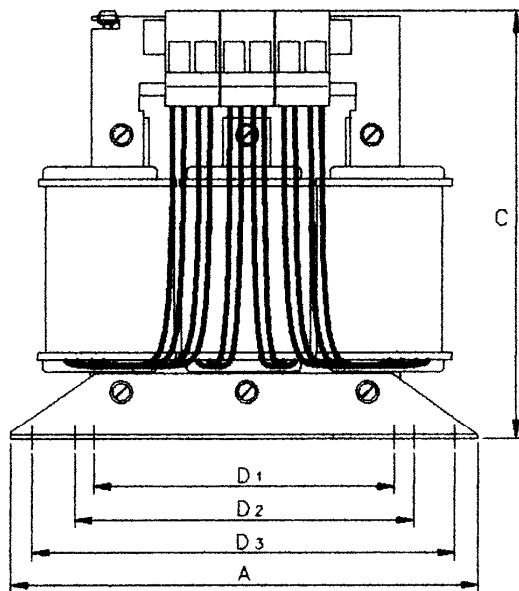

Rated Current (A _{eff})	Rated Inductivity (mH)	A (mm)	B (mm)	C (mm)	D1 (mm)	D2 (mm)	D3 (mm)	E1 (mm)	E2 (mm)	E3 (mm)	F* (mm)	G (mm)	Fixing Screws	Weight (kg/lbs)
650 Frame 2, 3-phase, 400V, 0.37kW/0.5Hp														
6	4.88	148	76	151	90	100	136	39	45	49	110	69	M4	2.1/

* dimension is dependent of the air gap

OPERATING THE DRIVE

Pre-Operation Checks

WARNING!

Wait for 5 minutes after disconnecting power before working on any part of the system or removing the terminal cover from the drive.

Initial checks before applying power:

- Check for damage to equipment.
 - Mains power supply voltage is correct.
 - Motor is of correct voltage rating and is connected in either star or delta, as appropriate.
 - Check all external wiring circuits - power, control, motor and earth connections.
- Note:* Completely disconnect the drive before point to point checking with a buzzer, or when checking insulation with a Meggar.
- Check for loose ends, clippings, drilling swarf etc. lodged in the drive and system.
 - If possible check that the motor can be turned freely, and that any cooling fans are intact and free from obstruction.

Ensure the safety of the complete system before the drive is energised:

- Ensure that rotation of the motor in either direction will not cause damage.
- Ensure that nobody else is working on another part of the system which will be affected by powering up.
- Ensure that other equipment will not be adversely affected by powering up.

Prepare to energise the drive and system as follows:

- Remove the supply fuses, or isolate using the supply circuit breaker.
- Disconnect the load from the motor shaft, if possible.
- If any of the drives control terminals are not being used, check whether these unused terminals need to be tied high or low.
- If the motor thermistor terminals are not connected to a motor thermistor, connect these terminals together.
- Check external run contacts are open. Check external speed setpoints are all zero.

Re-apply power to the drive and system

Initial Start-up Routines

Note: Refer to Chapter 5: "Using the Keypad" to familiarise yourself with the keypad's indications, and how to use the keys and menu structure.



IMPORTANT

When power is applied to the drive in Remote Control, it will immediately start running if the RUN signal is active.

WARNING!

Unpredictable motion, especially if motor parameters are incorrect.
 Ensure no personnel are in the vicinity of the motor or any connected machinery.
 Ensure that machinery connected to the motor will not be damaged by unpredictable motion.
 Ensure that the emergency stop circuits function correctly before running the motor for the first time.

The drive can be started in either Remote Control or Local Control. **By default, the drive will start in Local Control.**

These routines assume that the drive's control terminals are wired as shown in the Control Wiring Connections in Chapter 3.

Connected in this way, a positive setpoint will rotate the motor in a clockwise direction when viewed down the shaft, looking toward the motor.

Note: If during the start-up routine the display shows either an alarm (indicated by the letter "A") or a flashing Warning message, refer to Chapter 7: "Trips and Fault Finding".



A typical alarm

4-2 Operating the Drive

Local Control Operation

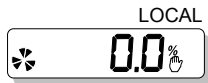

This is the simplest method of operating the drive. Connect the keypad to the drive and power-up the unit.

The drive will display the Local screen. If not, refer to Chapter 5 and select Local Control.

Follow the instructions opposite to start and stop the motor.

Reverse: Instead of setting a negative setpoint, you can reverse the motor direction by pressing STOP + ▼, or START + ▼. To change the direction to forwards, (the normal direction), press STOP + ▲ or START + ▲.

Note that the Setpoint parameter will not change sign to indicate this change, however the rotating indicator on the MMI will show the direction.

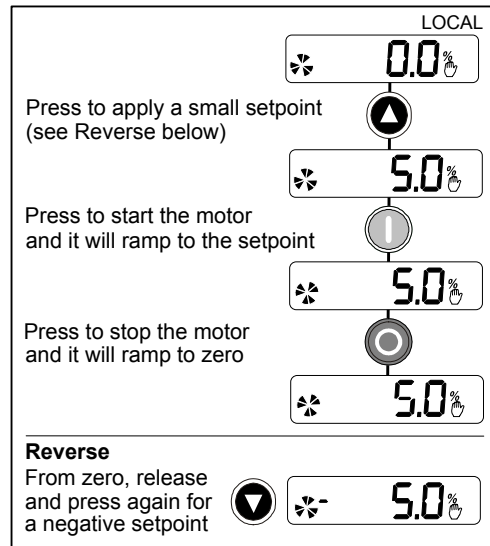

We recommend that you use the STOP key commands if the motor is stopped, and the START key commands if the motor is running. The keys should be pressed and released together.

Remote Control Operation

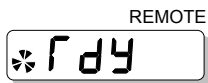

Connect the keypad to the drive and power-up the unit.

The drive will display the Local screen. Refer to Chapter 5 and select Remote Control.

IMPORTANT: Ensure that the speed potentiometer is set to zero.

Follow the instructions below to start and stop the motor using your control panel.

Reverse the motor's direction of rotation using the DIN2 connection (0V = forward, +24V = reverse). Alternatively, swap two of the motor phases (**WARNING: Disconnect the mains supply first**).

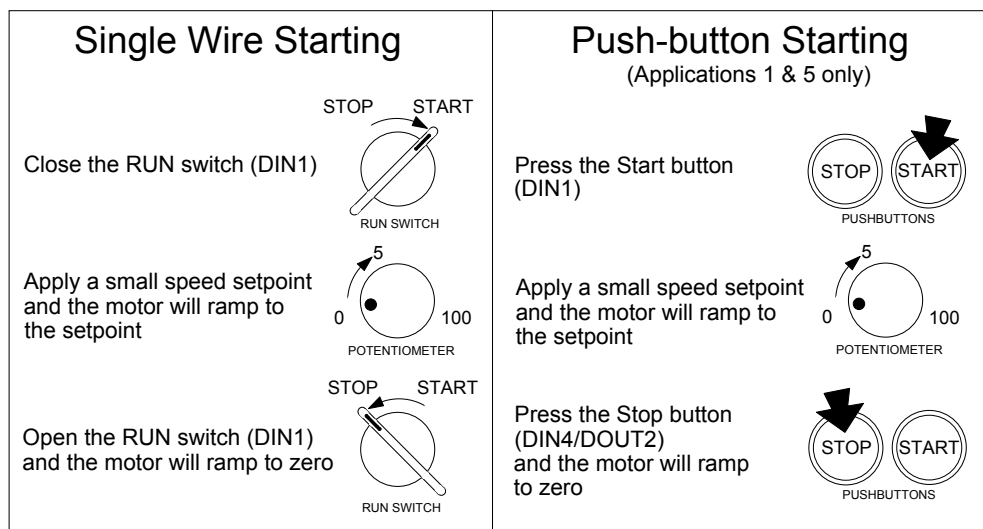

The installation of your drive is now complete:

The drive will operate as an open-loop drive. It is programmed to control an induction motor of equivalent power, current, and voltage rating to the drive.

The drive's default parameters will operate effectively under most circumstances, however you may wish to refer to Chapter 6 to tune the drive to your system.

THE KEYPAD

The Keypad (Man-Machine Interface, MMI) provides for local control of the drive, monitoring, and complete access for application programming.

The 650 can be fitted with either a Standard or Remote Keypad. Both Keypads fit on the front of the drive, but the Remote Keypad (with its extra connector) can also be remote-mounted up to 3 metres away using a connecting lead: refer to Chapter 3: “Installing the Drive” – Fitting the Remote Keypad.

To remove a Keypad, simply pull it away from the drive. To refit it, push it back into place.

The product rating label identifies the Drive/Keypad type: refer to Chapter 9: “Technical Specifications” – Understanding the Product Code.

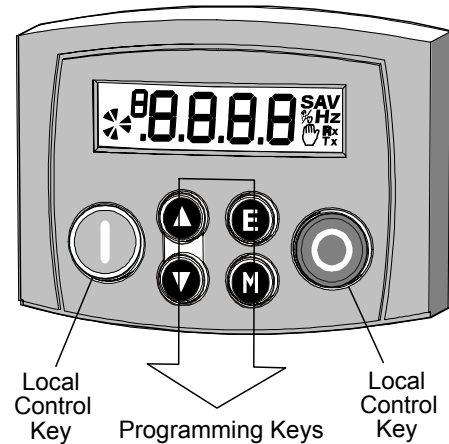

The Power-Up Condition

On initial power-up, direct from the factory, the drive is in Local Control and the MMI will display the Local Setpoint, **0.0** Hz.

All parameters will be at factory default settings. Any changes to these conditions are automatically saved. The drive will initialise on subsequent power-ups with the previously saved settings and control mode, Local or Remote Control.

Controlling the Drive using the Keypad

Control Key Definitions

Key	Operation	Description
	Escape	<i>Navigation</i> – Displays the previous level’s menu <i>Parameter</i> – Returns to the parameter list <i>Trip Display</i> – Removes Trip or Error message from display allowing investigation of parameters
	Menu	<i>Navigation</i> – Displays the next menu level, or the first parameter of the current Menu <i>Parameter</i> – Moves cursor to the left when the parameter is adjustable
	Increment	<i>Navigation</i> – Move upwards through the menu system <i>Parameter</i> – Increase value of the displayed parameter <i>Local Mode</i> – Increase value of the local setpoint
	Decrement	<i>Navigation</i> – Move down through the menu system <i>Parameter</i> – Decrease value of the displayed parameter <i>Local Mode</i> – Decrease value of the local setpoint
	Run	<i>Local Mode</i> – Run the drive <i>Trip Reset</i> – Resets trip condition allowing drive to resume operation
	Stop	<i>Local Mode</i> – Stops the drive. Trip Reset in all modes <i>Navigation</i> – Press and hold to toggle between Local and Remote Control modes (refer to page 5.4) <i>Trip Reset</i> – Resets trip condition allowing drive to resume operation

5-2 The Keypad

Display Indications

P when in the Parameter menu
S when in the Setup menu
A when displaying an Alarm code
- a negative parameter value

Displays the units for the value:
S for time in seconds, **A** for current in Amps
V for voltage in Volts, **%** for percentage
Hz for frequency in Hertz

Indicates the Control Mode

Indicates parameter numbers or values, trip information, error codes etc. See "Drive Status Indications" below.

Indicates the drive is in Local control. Drive is in remote control when not visible.

Indicates control via fieldbus communications

Represents a rotating shaft:
 clockwise = drive running forward
 anticlockwise = drive running in reverse

Drive Status Indications

The keypad can display the following status information:

Display	Status Indication and Meaning	Possible Cause
	READY/HEALTHY No alarms present. Remote mode selected	
	PASSWORD Current password must be entered before this parameter may be altered.	Enter password to change the parameter. Refer to page 5.5
	LOCAL Local Control selected, healthy, no alarms present	Added or removed from the display letter-by-letter to indicate entering or leaving Local Control
	RUN Not possible to change between Local/Remote mode	The drive is running in Local mode or the Remote run signal is active
	JOG Not possible to change between Local/Remote mode	The Remote jog signal is active

The DIAGNOSTICS Menu

Display	Name	Description
	FREQUENCY	The current output frequency in Hertz
	SPEED SETPOINT	The set point as a percentage of MAX SPEED
	DC LINK VOLTS	Vac (rms) x $\sqrt{2}$ = dc link Volts (when motor stopped)
	MOTOR CURRENT	The current load value in Amps

The Menu System

The menu system is divided into a “tree” structure with 3 menu levels.

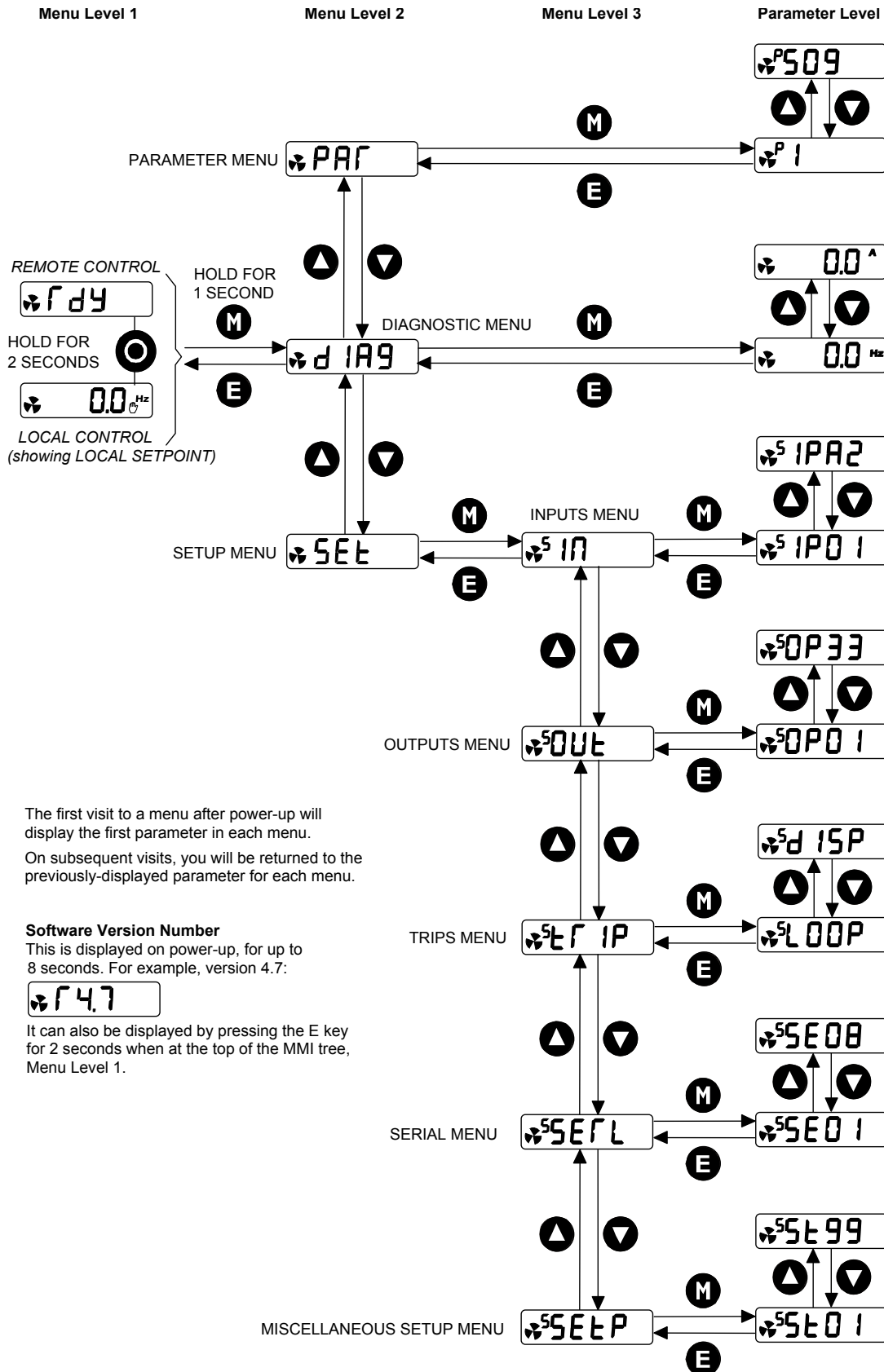

The first visit to a menu after power-up will display the first parameter in each menu. On subsequent visits, you will be returned to the previously-displayed parameter for each menu.

Software Version Number

This is displayed on power-up, for up to 8 seconds. For example, version 4.7:

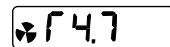

It can also be displayed by pressing the E key for 2 seconds when at the top of the MMI tree, Menu Level 1.

5-4 The Keypad

How To Change a Parameter Value

You can change the values of parameters stored in the **PAR** and **SEt** menus. Refer to Chapter 6: “Programming Your Application” – Configurable Parameters for further information.

- View the parameter to be edited and press **M** to display the parameter’s value.
- Select the digit to be changed (pressing the **M** key moves the cursor from right to left).
- Use the **▲** **▼** keys to adjust the value. Hold the key momentarily to adjust the value marginally, or hold the key to make rapid changes; the rate of change varies with the time held.
- Press **E** to return to the parameter display. The new value is stored.

Special Menu Features

Resetting to Factory Defaults (2-button reset)

Power-up the drive whilst holding the keys as shown to return to factory default settings.

This loads Application 1. Then press the **E** key.

Hold down the keys opposite:
Power-up the drive, continue to hold for at least 1 second

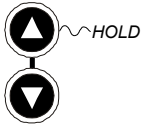

Changing the Drive Operating Frequency

Power-up the drive whilst holding the keys as shown to display the Engineers Menu.

IMPORTANT: This menu contains sensitive parameters that can dramatically alter the running of the drive.

Hold down the keys opposite:
Power-up the drive, continue to hold for at least 1 second

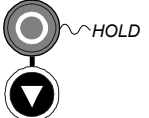

This displays parameter ^E0.01. Press the **▲** key to navigate to ^E0.02. Press the **M** key to edit the parameter: 0 = 50Hz (default), 1 = 60Hz. Select the required frequency then press the **E** key.

Power-down the drive. No permanent change has been made to the drive at this point. To save the change to parameter ^E0.02, you must now perform a 2-button reset (as above). Please note that this will return the drive to its factory default settings for the selected default frequency.

Selecting Local or Remote Control

The drive can operate in one of two ways:

Remote Control: Allowing access for application programming using digital and analog inputs and outputs

Local Control: Providing local control and monitoring of the drive using the Keypad

Local control keys are inactive when Remote Control is selected.

In Remote Control, the drive uses a remote setpoint. In Local Control, it uses the Local Setpoint parameter whose value is adjusted on the MMI.

Note: You can only change between Local and Remote Control when the drive is “stopped”, and either **r dY** or the Local Setpoint is displayed.

Remote to Local Control:

Hold this key down until the display shows **r dY**



Hold this key down until the display spells **L 00**

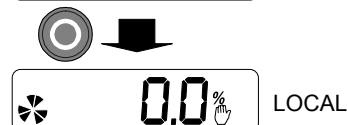

Release the key to display the Local Setpoint

Local to Remote Control:

View the Local Setpoint



Hold this key down until LOC is removed from the display



Release the key to display rdy



Note: For safety reasons, the drive will not return to Remote Control if this will cause the drive to start. Check RUN and JOG inputs are low.

Password Protection

When activated, an odd-numbered password prevents unauthorised parameter modification by making all parameters read-only. The local setpoint is not made read-only if an even-numbered password is used. Password protection is set-up using the P 99 parameter

Steps	ACTIVATE		TEMPORARY DE-ACTIVATION		REMOVE PASSWORD	
	Actions	Display	Actions	Display	Actions	Display
1	Go to P 99 Press M	0000	Try to edit any parameter with password activated	PASS → 0000	Go to P 99 Press M	PASS → 0000
2	Enter new password using ▲ ▼	000 1 for example	Enter current password using ▲ ▼	000 1 for example	Enter current password using ▲ ▼	000 1 for example
3	Press E repeatedly until top of menu is reached	rdy, Remote Setpoint or Local Setpoint	Press E	Original parameter displayed, password de-activated	Press E Reset to 0000 using ▲ ▼	0000
4	Press E to activate password Default = 0000, de-activated Any other value is a password	rdy, Remote Setpoint or Local Setpoint	A drive will power-up with the last password status. Temporary de-activation is lost on power-down.		Press E to remove password	P 99

Quick Application Selection

You can navigate immediately to the APPLICATION parameter, P1, from power-up, as shown opposite.

Hold down the key opposite:  HOLD
Power-up the drive, continue to hold for at least 1 second

Then, press the M key to display the current Application. Press again to allow the parameter to be changed.

Use the ▲ ▼ keys to select the appropriate Application by number.

Press the E key to load the Application.
Refer to Chapter 12: "Applications" for further information.

Selecting the Menu Detail

For ease of operation the drive can display full or reduced menus. Refer to Chapter 6 to see how the setting changes the displayed menu. Additional parameters are indicated with  in the table.

Navigate to the St99 parameter (SET::SETP::ST99) and press the M key. This toggles full or partial menu detail. The default setting of 0 provides partial menu detail. Set the parameter to 1 for full menu detail.

PROGRAMMING YOUR APPLICATION

You can program the drive to your specific application. This programming simply involves changing parameter values. For instance, parameter P_1 selects various Applications which can be used as starting points for application-specific programming.

Each Application internally re-wires the drive for a different use when it is loaded. The default for the parameter is "1". Changing this parameter's setting to "2" will load Application 2. Refer to Chapter 12: "Applications" for further information.

If necessary, there are three parameters for tuning your drive. Refer to PID - Tuning Your Drive, page 6-8.

Saving Your Modifications

When parameter values are modified or an Application is loaded, the new settings are saved automatically. The drive will retain the new settings during power-down.

MMI Parameters

This table provides information about each parameter accessible using the keypad, or MMI (Man Machine Interface). For more information, refer to the 650 Software Product Manual on our website: www.SSDdrives.com.

Key to MMI Parameters Table

F	Parameters indicated with F are visible with full menus only. Refer to the DETAILED MENUS parameter ($ST99$).
M	Parameters indicated with M are Motor Parameters. They are not reset by changing Application using parameter P_1 ; all other parameters are reset to default values.

Note: The "Range" for a parameter value is given in the Configurable Parameters Table. Ranges for outputs are given as "—xx %", for example, indicating an indeterminate integer for the value, to two decimal places.

MMI Parameters Table

MMI Parameters Table				
Display	Parameter	Description	Range	Default
SET::PAR Menu				
P 1	APPLICATION	This parameter selects and loads the Application to be used. APP 0 will not control a motor. APP 6, 7, 8 & 9 are reserved for future use. Refer to the 650 Software Product Manual, Chapter 5: "Applications" which gives detailed information about each Application. Note: Parameter values are changed to factory settings by loading a new Application, except Motor Parameters (indicated M)	0= NULL 1= STANDARD 2= LOCAL/REM (AUTO/MANUAL) 3= PRESETS 4= RAISE/LOWER 5= PID 6= APP 6 7= APP 7 8= APP 8 9= APP 9	1
P 2	MAX SPEED M	The frequency at which the 650 will run when maximum setpoint is applied. The default can be either 50 or 60Hz.	7.5 to 300Hz	product code dependent
P 3	MIN SPEED	The minimum frequency at which the 650 will run, as a percentage of the MAX SPEED parameter	-100.0 to 100.0%	0.0%
P 4	ACCEL TIME M	The time taken for the 650 output frequency to ramp up from zero to MAX SPEED	0.0 to 3000.0s	product code dependent
P 5	DECEL TIME M	The time taken for the 650 output frequency to ramp down from MAX SPEED to zero	0.0 to 3000.0s	product code dependent

MMI Parameters Table				
Display	Parameter	Description	Range	Default
P 6	MOTOR CURRENT M	This parameter contains the motor nameplate full-load line current	0.01 to 999.99A	product code dependent
P 7	BASE FREQUENCY M	The output frequency at which maximum voltage is reached. The default can be either 50 or 60Hz.	7.5 to 240Hz	product code dependent
P 8	JOG SETPOINT	Speed the 650 will run at if the Jog input is high, as a percentage of the MAX SPEED parameter	-100.0 to 100.0%	10.0%
P 9	RUN STOP MODE	<p>RAMPED : The motor speed is reduced to zero at a rate set by DECEL TIME (P5). A 2 second DC pulse is applied at end of ramp</p> <p>COAST : The motor is allowed to freewheel to a standstill</p> <p>DC INJECTION : On a stop command, the motor volts are rapidly reduced at constant frequency to deflux the motor. A low frequency braking current is then applied until the motor speed is almost zero. This is followed by a timed DC pulse to hold the motor shaft.</p>	0=RAMPED 1=COAST 2=DC INJECTION	0
P 11	V/F SHAPE	<p>LINEAR LAW: This gives a constant flux characteristic up to the BASE FREQUENCY</p> <p>FAN LAW: This gives a quadratic flux characteristic up to the BASE FREQUENCY. This matches the load requirement for fan and most pump applications</p> <p>Refer to P12</p>	0=LINEAR LAW 1=FAN LAW	0
P 12	NORMAL DUTY	<p>% OF RATED MOTOR CURRENT</p> <p>FALSE - HEAVY DUTY: Inverse time allows 150% overload for 30s, then ramps back the current limit to 105% over a 10s period. At a lower load, the overload area remains the same, e.g. at 127.5% load for 60s - after 60s has expired, the output of the inverse time function is ramped back over a 10s period from 150% as before.</p> <p>TRUE - NORMAL DUTY: current limit is set to 110% motor current, inverse time delay is set to 30s</p> <p>When P11 is changed from FAN LAW to LINEAR LAW, P12 is set to 0 (HEAVY DUTY)</p> <p>When P11 is changed from LINEAR LAW to FAN LAW, P12 is set to 1 (NORMAL DUTY)</p> <p>P12 can be changed independently</p>	0=FALSE 1=TRUE	0

NORMAL DUTY was previously referred to as Quadratic Torque in past Eurotherm Drives' manuals.

6-3 Programming Your Application

MMI Parameters Table				
Display	Parameter	Description	Range	Default
P 13	FIXED BOOST MVF	Used to correctly flux the motor at low speeds. This allows the drive to produce greater starting torque for high friction loads. It increases the motor volts above the selected V/F characteristic at the lower end of the speed range OUTPUT VOLTS 100% 25% 0% INCREASED TORQUE FLUXING NORMAL FLUXING INCREASING BOOST CONSTANT POWER RANGE FREQUENCY f _B = BASE FREQUENCY	0.00 to 25.00%	product code dependent
P 99	PASSWORD	A password may be set to prohibit unauthorised adjustment of parameters. When P99 is set to non-zero you will be required to match this value before parameters can be adjusted	0000 – FFFF	0000
Parameters P301 to P308 are visible in the PAR menu when Application 3 is selected in parameter P1				
P 301	PRESET 0	A user-adjustable speed preset, set by potentiometer	-100.00 to 100.00	-
P 302	PRESET 1	A user-adjustable speed preset	-100.00 to 100.00	20.00
P 303	PRESET 2	A user-adjustable speed preset	-100.00 to 100.00	50.00
P 304	PRESET 3	A user-adjustable speed preset	-100.00 to 100.00	100.00
P 305	PRESET 4	A user-adjustable speed preset	-100.00 to 100.00	-10.00
P 306	PRESET 5	A user-adjustable speed preset	-100.00 to 100.00	-20.00
P 307	PRESET 6	A user-adjustable speed preset	-100.00 to 100.00	-50.00
P 308	PRESET 7	A user-adjustable speed preset	-100.00 to 100.00	-100.00
Parameters P401 to P404 are visible in the PAR menu when Application 4 is selected in parameter P1				
P 401	R/L RAMP TIME	The time taken to ramp the Raise/Lower output from 0.00% to 100.00% of its value	0.0 to 600.0s	10.0s
P 402	R/L MAX VALUE	The maximum value for the ramp output	-100.00 to 100.00%	100.00%
P 403	R/L MIN VALUE	The minimum value for the ramp output	-100.00 to 100.00%	0.00%
P 404	R/L RESET VALUE	The value the output is set to when Reset is TRUE, when DIN4 (terminal 10) is 24V in Application 4	-100.00 to 100.00%	0.00%
Parameters P501 and P506 are visible in the PAR menu when Application 5 is selected in parameter P1				
P 501	PI P GAIN	The PI proportional gain	0.00 to 100.00	0.10
P 502	PI I GAIN	The PI integral gain	0.00 to 100.00	1.00
P 503	PID D GAIN F	The PID derivative gain	0.00 to 100.00	0.00
P 504	PID D FILTER TC F	In order to help attenuate high frequency noise on the derivative term, a first order lag has been provided. This parameter determines the filter time constant.	0.05 to 10.00s	0.05s
P 505	PID FEEDBACK GAIN F	A multiplier applied to the feedback signal of the PID	-10.00 to 10.00	1.00
P 506	PID LIMIT F	Determines the maximum positive and negative excursion (Limit) of the PID output	0.00 to 300.00%	300.00%
P 507	PID SCALING F	This parameter represents an overall scaling factor which is applied after the PID positive and negative limit clamps	-3.0000 to 3.0000	1.0000

MMI Parameters Table				
Display	Parameter	Description	Range	Default
P 508	PID ERROR F	The result of SETPOINT - FEEDBACK x FEEDBACK GAIN	—.xx %	—.xx%
P 509	PID OUTPUT F	The output of the PID function block	—.xx %	—.xx %

SET::IN Menu				
5 IP01	DIN 1 INVERT	Inverts the value of the signal, TRUE or FALSE.	0 = FALSE 1 = TRUE	0
5 IP02	DIN 2 INVERT	As 5IP01	As 5IP01	0
5 IP03	DIN 3 INVERT	As 5IP01	As 5IP01	0
5 IP04	DIN 4 INVERT	As 5IP01	As 5IP01	0
5 IP11	AIN 1 SCALE		-300.0 to 300.0%	100.0%
5 IP12	AIN 1 OFFSET		-300.0 to 300.0%	0.0%
5 IP13	AIN 1 TYPE		0 = 0-10V 1 = 0-5V	0
5 IP21	AIN 2 SCALE		-300.0 to 300.0%	100.0%
5 IP22	AIN 2 OFFSET		-300.0 to 300.0%	0.0%
5 IP23	AIN 2 TYPE		0 = 0-10V 1 = 0-5V 2 = 0-20mA 3 = 4-20mA	3
5 IPd1	DIN 1 VALUE F	The TRUE or FALSE input (after any inversion)	0=FALSE 1=TRUE	-
5 IPd2	DIN 2 VALUE F	The TRUE or FALSE input (after any inversion)	0=FALSE 1=TRUE	-
5 IPd3	DIN 3 VALUE F	The TRUE or FALSE input (after any inversion)	0=FALSE 1=TRUE	-
5 IPd4	DIN 4 VALUE F	The TRUE or FALSE input (after any inversion)	0=FALSE 1=TRUE	-
5 IPA1	AIN 1 VALUE F	The input reading with scaling and offset applied	—.x%	—.x%
5 IPA2	AIN 2 VALUE F	The input reading with scaling and offset applied	—.x%	—.x%

SET::OUT Menu				
5 OPO1	AOUT 1 SOURCE	ANALOG OUTPUT 0 NONE 1 DEMAND 2 CURRENT % 3 PI ERROR % 4 RAISE/LOWER % OUTPUT	SCALE 5 OP02 OFFSET 5 OP03 → 0-10V ABSOLUTE 5 OP04	0 = NONE 1 = DEMAND 2 = CURRENT 3 = PID ERROR 4 = RAISE/LOWER OUTPUT
5 OPO2	AOUT 1 SCALE		-300.00 to 300.00%	100.00%
5 OPO3	AOUT 1 OFFSET		-300.00 to 300.00%	0.00%
5 OPO4	AOUT 1 ABSOLUTE		0 = FALSE (not absolute) 1 = TRUE (absolute)	1
5 OPOS	AOUT 1 VALUE F		-300.0 to 300.0%	0.0%

6-5 Programming Your Application





MMI Parameters Table				
Display	Parameter	Description	Range	Default
5OP21	DOUT 2 SOURCE Refer to Configuring Terminal 10 (Digital Input/Output), page 6-8.	DIN4 / DOUT2 0 NONE 1 HEALTH 2 TRIPPED 3 RUNNING 4 AT ZERO 5 AT SPEED	0= NONE 1= HEALTH 2= TRIPPED 3= RUNNING 4= AT ZERO 5= AT SPEED	0
5OP22	DOUT 2 INVERT	(OUTPUT) As ^S IP01. Set to 0 for applications 1 & 5.	As ^S IP01	0
5OP23	DOUT 2 VALUE F	The TRUE or FALSE output demand.	0=FALSE 1=TRUE	0
5OP31	RELAY SOURCE	NONE : Relay is open <i>Relay is closed when:</i> HEALTH : the Run signal is not present, or no trip is active TRIPPED : a trip is present RUNNING : the motor is running AT ZERO : the output frequency is below 1% of MAX SPEED (^F 2) AT SPEED : the output frequency is at or near Setpoint and within ±1% of MAX SPEED, set by (^F 2). For example: if MAX SPEED = 50Hz and Setpoint = 30Hz, then 1% of MAX SPEED = 0.5Hz. So AT LOAD is True between 30 ±0.5Hz.	As ^S OP21	1
5OP32	RELAY INVERT	Inverts the value of the signal, TRUE or FALSE.	0=FALSE 1=TRUE	0
5OP33	RELAY VALUE F	The TRUE or FALSE output demand.	0=FALSE 1=TRUE	0

SET::TRIP Menu

5LOOP	DISABLE LOOP	Disables LOST I LOOP trip (4-20mA)	0= TRIP ENABLED 1= TRIP DISABLED	1
5t3	AIN2 OVERLOAD	Disables the overload trip (Terminal 3)	As ^S LOOP	0
5StLL	DISABLE STALL	Disables STALL trip	As ^S LOOP	0
5Ot	DISABLE MOTOR OVERTEMP	Disables the motor thermistor trip	As ^S LOOP	0
5It	INVERSE TIME	Disables the inverse time trip	As ^S LOOP	1
5dI SP	DISPLAY (KEYPAD)	Disables the display (keypad) trip	As ^S LOOP	0
5dCRP	DC LINK RIPPLE F	Disables the DC link ripple trip	As ^S LOOP	0

MMI Parameters Table				
Display	Parameter	Description	Range	Default
SET::SERL Menu				
5SE01	REMOTE COMMS SEL F	Selects the type of remote communications mode: 0 : FALSE, and in REMOTE mode then control is from the terminals. 1 : TRUE, and in REMOTE mode then control is from the communications.	0=FALSE 1=TRUE	0
5SE02	COMMS TIMEOUT F	Sets the maximum time allowed between refreshing the COMMS COMMAND parameter. The drive will trip if this time is exceeded. Set the time to 0.00 seconds to disable this feature.	0.0 to 600.0s	0.0s
5SE03	COMMS ADDRESS F	The drives identity address. Note: if set to 0, it will only respond to broadcast messages.	0 to 255	0
5SE04	BAUD RATE F	Selects the Baud Rate for the MODBUS protocol.	0 : 1200 1 : 2400 2 : 4800 3 : 7200 4 : 9600 5 : 14400 6 : 19200 7 : 38400 8 : 57600	4
5SE05	PARITY F	Selects the Parity for the MODBUS protocol.	0= NONE 1= ODD 2= EVEN	0
5SE06	REPLY DELAY ms	The time in milliseconds between the drive receiving the complete request from the communications master (PLC/PC) and replying to this request.	0 to 200	5
5SE07	OP PORT PROTOCOL F	Selects the protocol to be used by the keypad port on the front of the drive. When EIBISYNC ASCII is selected, BAUD RATE is 19200 and PARITY is EVEN. FIELDBUS is reserved for future use.	0= AUTOMATIC 1= KEYPAD 2=EIBISYNC ASCII 3= MODBUS 4= FIELDBUS	0
5SE08	P3 PORT PROTOCOL F	Selects the protocol to be used by the RS232 programming port on the drive's control board. When EIBISYNC ASCII is selected, BAUD RATE is 19200 and PARITY is EVEN. FIELDBUS is reserved for future use.	As 5SE07	0
SET::SETP Menu				
5SEt01	JOG ACCEL TIME	As P4, for Jog	0.0 to 3000.0s	1.0
5SEt02	JOG DECEL TIME	As P5, for Jog	0.0 to 3000.0s	1.0
5SEt03	RAMP TYPE	Selects the ramp type	0=LINEAR 1=S	0
5SEt04	S RAMP JERK	Rate of change of acceleration of the curve in units per second ³	0.01 to 100.00 s3	10.00
5SEt05	S RAMP CONTINUOUS	When TRUE and the S ramp is selected, forces a smooth transition if the speed setpoint is changed when ramping. The curve is controlled by the S RAMP JERK parameter. When FALSE, there is an immediate transition from the old curve to the new curve	0=FALSE 1=TRUE	1
5SEt06	MIN SPEED MODE F	Selects a mode to determine how the drive will follow a reference: Proportional : minimum limit, Linear : between minimum and maximum.	0=PROP.W/MIN. 1=LINEAR (used by the 601 product)	0

6-7 Programming Your Application

55t 11	SKIP FREQUENCY 1	This parameter contains the centre frequency of skip band 1 in Hz	0.0 to 240.0 Hz	0.0	
55t 12	SKIP FREQUENCY BAND 1	The width of skip band 1 in Hz	0.0 to 60.0 Hz	0.0	
55t 13	SKIP FREQUENCY 2	This parameter contains the centre frequency of skip band 2 in Hz	0.0 to 240.0 Hz	0.0	
55t 14	SKIP FREQUENCY BAND 2	The width of skip band 2 in Hz	0.0 to 60.0 Hz	0.0	
55t 21	AUTO RESTART ATTEMPTS	Determines the number of restarts that will be permitted before requiring an external fault reset	0 to 10	0	
55t 22	AUTO RESTART DELAY	Determines the delay between restart attempts for a trip included in AUTO RESTART TRIGGERS and AUTO RESTART TRIGGERS+. The delay is measured from all error conditions clearing	0.0 to 600.0 s	10.0	
55t 23	AUTO RESTART TRIGGERS	Allows Auto Restart to be enabled for a selection of trip conditions. Refer to Chapter 6: "Trips and Fault Finding" - Hexadecimal Representation of Trips	0x0000 to 0xFFFF	0x0000	
55t 24	AUTO RESTART TRIGGERS+	Allows Auto Restart to be enabled for a selection of trip conditions. Refer to Chapter 6: "Trips and Fault Finding" - Hexadecimal Representation of Trips	0x0000 to 0xFFFF	0x0000	
55t 51	LOCAL MIN SPEED	The magnitude of the minimum setpoint that will be used when running in Local Mode.	0.0 to 100.0 %	0.0 %	
55t 52	ENABLED KEYS	The following keys on the 6901 keypad can be enabled or disabled separately. The combination produces the parameter setting as in the table below. The default of FFFF enables all keys.	0000 to FFFF	FFFF	
	Parameter Setting	RUN	L/R	JOG	DIR
	0000	-	-	-	-
	0010	-	-	-	ENABLED
	0020	-	-	ENABLED	-
	0030	-	-	ENABLED	ENABLED
	0040	-	ENABLED	-	-
	0050	-	ENABLED	-	ENABLED
	0060	-	ENABLED	ENABLED	-
	0070	-	ENABLED	ENABLED	ENABLED
	0080	ENABLED	-	-	-
	0090	ENABLED	-	-	ENABLED
	00A0	ENABLED	-	ENABLED	-
	00B0	ENABLED	-	ENABLED	ENABLED
	00C0	ENABLED	ENABLED	-	-
	00D0	ENABLED	ENABLED	-	ENABLED
	00E0	ENABLED	ENABLED	ENABLED	-
	00F0	ENABLED	ENABLED	ENABLED	ENABLED
 6901					
 6911					
 6511					
 6521					
		When using the standard 6511 and 6521 keypad, disabling the DIR key prevents the local setpoint going negative (for reverse). Similarly, disabling the L/R key prevents the drive being changed from Local to Remote, or Remote to Local modes.			
55t 98	APPLICATION LOCK	Setting this parameter to TRUE prevents editing of parameter P1. Set this parameter to FALSE to edit parameter P1.	0=FALSE 1=TRUE	0	
55t 99	DETAILED MENUS	Selects Full menu detail when TRUE. The additional parameters in the Full menus are indicated in this table by F	0=FALSE 1=TRUE	0	

Configuring Terminal 10 (Digital Input/Output)

Terminal 10 can be operated as digital input DIN 4 or digital output DOUT2. It is configured via the keypad. The default for terminal 10 is to operate as a digital input, and the input logic is non-inverted.

Configure for use as a Digital Input (default)

For example, to use terminal 10 as an input, the output circuitry must be disabled by setting ^SOP21 and ^SOP22 to zero. You can invert this logic using parameter ^SIP04.

Parameter	Setting
^SOP21 DOUT2 SOURCE	0
^SOP22 DOUT2 INVERT	0
^SIP04 DIN4 INVERT	Default is 0, setting to 1 inverts the input logic

Configure for use as a Digital Output

For example, to use terminal 10 as an output, select ^SOP21 to be 1, 2, 3, 4, 5 or 6. For instance, you could set parameter ^SOP21 to 3 to have the output go high (24V) whenever the motor is running, operating an external relay or lamp. You can invert this logic using parameter ^SOP22.

Parameter	Setting
^SOP21 DOUT2 SOURCE	<i>The output is high when:</i>
	1 = HEALTH The Run signal is not present, or no trip is active
	2 = TRIPPED A trip is present
	3 = RUNNING The motor is running
	4 = AT ZERO The output frequency is below 1% of MAX SPEED (^P 2)
	5 = AT SPEED The output frequency is at or near Setpoint and within ±1% of MAX SPEED, set by (^P 2). For example: if MAX SPEED = 50Hz and Setpoint = 30Hz, then 1% of MAX SPEED = 0.5Hz. So AT LOAD is True between 30 ±0.5Hz.
Always set ^S IP04 to 0 if using Applications 1 and 5 – refer to Chapter 12.	
^SOP22 DOUT2 INVERT	Default is 0, setting to 1 inverts the output logic

PID - Tuning Your Drive

Parameters ^P501 to ^P509: PID is used to control the response of any closed loop system. It is used specifically in system applications involving the control of drives to provide zero steady state error between Setpoint and Feedback, together with good transient performance.

Proportional Gain (^P501)

This is used to adjust the basic response of the closed loop control system. The PI error is multiplied by the Proportional Gain to produce an output.

6-9 Programming Your Application

Integral (^P502)

The Integral term is used to reduce steady state error between the setpoint and feedback values of the PI. If the integral is set to zero, then in most systems there will always be a steady state error.

Derivative (^P503)

This is used to correct for certain types of control loop instability, and therefore improve response. It is sometimes used when heavy or large inertia rolls are being controlled. The derivative term has an associated filter to suppress high frequency signals.

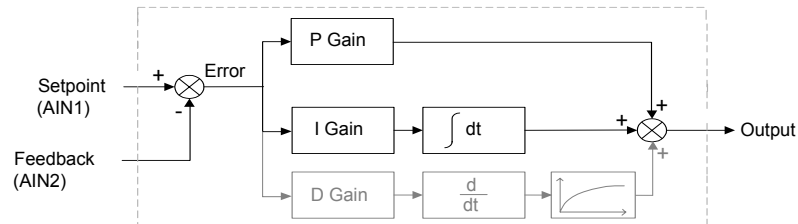

- Functions as P, PI, PID controller
- Single symmetric limit on output

A Method for Setting-up the PI Gains

The gains should be set-up so that a critically damped response is achieved for a step change in setpoint. An underdamped or oscillatory system can be thought of as having too much gain, and an overdamped system has too little.

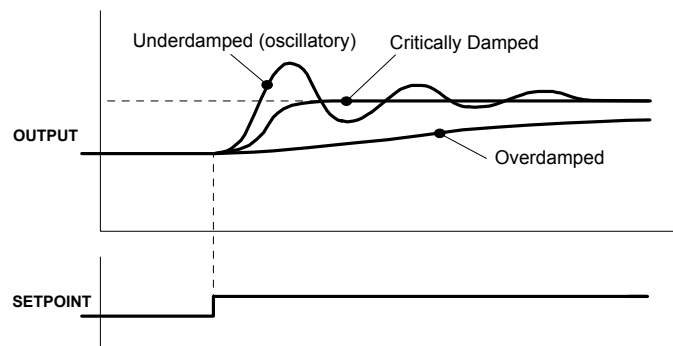

To set up the P gain, set the I gain to zero. Apply a step change in setpoint that is typical for the System, and observe the response. Increase the gain and repeat the test until the system becomes oscillatory. At this point, reduce the P gain until the oscillations disappear. This is the maximum value of P gain achievable.

If a steady state error is present, i.e. the feedback never reaches the setpoint value, the I gain needs to be increased. As before, increase the I gain and apply the step change. Monitor the output. If the output becomes oscillatory, reduce the P gain slightly. This should reduce the steady state error. Increasing the I gain further may reduce the time to achieve zero steady state error.

These values of P and I can now be adjusted to provide the exact response required for this step change.

Auto Restart

Parameters ^SST21 to ^SST24 provide the facility to automatically reset a choice of trip events and restart the drive with a programmed number of attempts. If the drive is not successfully started, a manual or remote trip reset is required.

The number of attempted restarts are recorded. This count is cleared after a trip-free period of operation (5 minutes or 4 x AUTO RESTART DELAY, whichever is the longer); or after a successful manual or remote trip reset; or by removing the Run signal (Terminal 7, DIN1).

Refer to Chapter 7: "Trips and Fault Finding" - Hexadecimal Representation of Trips.

Skip Frequencies

Parameters ^SST11 to ^SST14 control two programmable skip frequencies that can prevent the drive from operating at frequencies that cause mechanical resonance in the load.

- Enter the value of the frequency that causes the resonance into the SKIP FREQUENCY parameter.
- Enter a width for the skip band into the SKIP FREQUENCY BAND parameter.

The drive will then avoid sustained operation within the forbidden band as shown in the diagram. The skip frequencies are symmetrical and thus work in forward and reverse.

Setting SKIP FREQUENCY or SKIP FREQUENCY BAND to 0 disables the corresponding band.

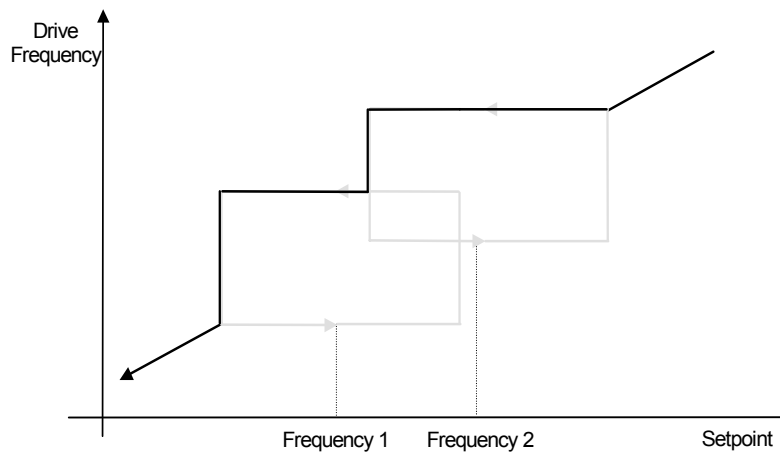
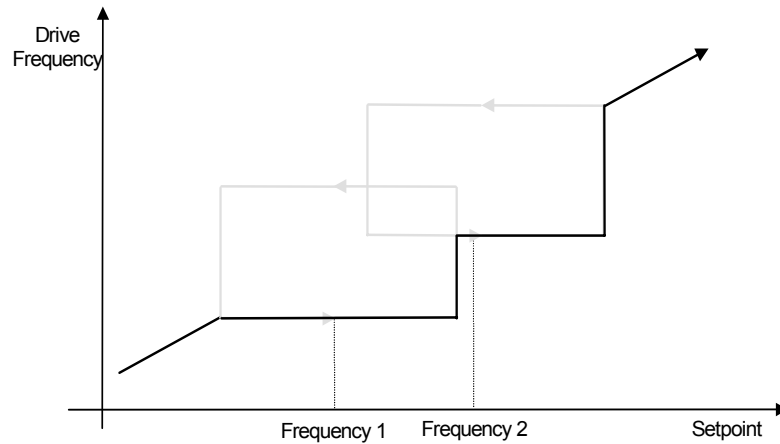
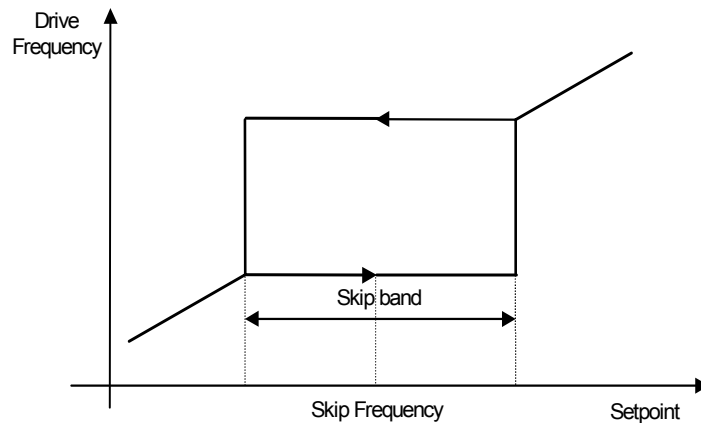

Minimum Speed Mode

There are two operating modes for the minimum speed feature.

Proportional with Minimum

In this mode the speed setpoint is clamped to be between the minimum speed value (P3) and 100%. This is the default for the minimum speed feature.

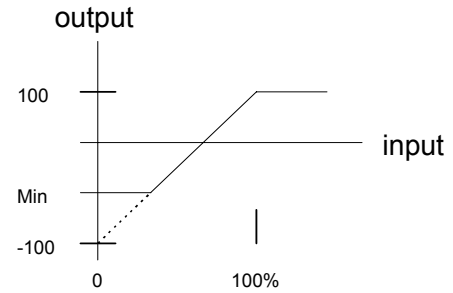

Linear

In this mode the speed setpoint is first clamped to be in the range 0 to 100%. It is then rescaled so that the output goes linearly between the minimum speed value (P3) and 100% for an input setpoint that goes between 0% and 100%. If the minimum speed value (P3) is negative the speed setpoint will be internally set to 0%.

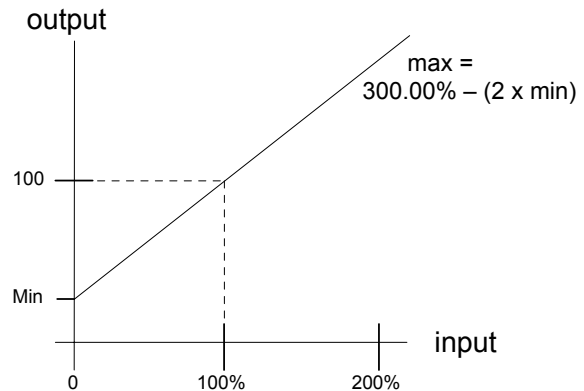

Product-Related Default Values

All examples given in this book are based on a UK, 230V, 50Hz, 0.25kW drive. This manual provides information about each parameter accessible using the keypad, or MMI (Man Machine Interface). For more information, refer to the 650 Software Product Manual on our web site: www.SSDdrives.com.

* Frequency Dependent Parameters

These parameter values (marked with "*" in the Application diagrams) are dependent upon the drive's "default frequency".

Changing the "default frequency" parameter from 50Hz to 60Hz, and vice versa, causes the values of the parameters in the table below to be changed.

To change the "default frequency", power-down the drive. Power-up the drive holding down the STOP and DOWN keys on the keypad. Release the keys to display the ° 0.01 parameter.

Caution

You are now in a menu containing some sensitive and important parameters.

Press the UP key to display the ° 0.02 parameter. Press the M key. The values for this parameter are: 0 = 50Hz default, 1 = 60Hz default. Select the setting using the UP/DOWN keys and then press the E key. Power-down the drive and power-up again holding down the UP and DOWN keys. This resets ALL parameters to their correct default values, including Motor Parameters.

Frequency Dependent Defaults					
Display	Parameter	Function Block	Tag	50Hz Operation	60Hz Operation
P 7	BASE FREQUENCY	MOTOR DATA	1159	50Hz	60Hz
P 2	MAX SPEED	REFERENCE	57	50Hz	60Hz

** Power Dependent Parameters

These parameters (marked with “***” in the Application diagrams) are set to a value depending on the drive's overall “power-build” indicated by the Product Code. We recommend that you do not change the Product Code.

230V Build Power Dependent Defaults								
Parameter	Function Block	Tag	Frame 1				Frame 2	
			0.25kW	0.37kW	0.55kW	0.75kW	1.1kW	1.5kW
MOTOR CURRENT	MOTOR DATA	64	1.50 A	2.20 A	3.00 A	4.00 A	5.50 A	7.00 A
FIXED BOOST	FLUXING	107	5.00 %	5.00 %	5.00 %	5.00 %	5.00 %	5.00 %
ACCEL TIME	REFERENCE RAMP	258	10.0 s	10.0 s	10.0 s	10.0 s	10.0 s	10.0 s
DECEL TIME	REFERENCE RAMP	259	10.0 s	10.0 s	10.0 s	10.0 s	10.0 s	10.0 s

230V Build Power Dependent Defaults					
Parameter	Function Block	Tag	Frame 3		
			2.2kW	3.0kW	4.0kW
MOTOR CURRENT	MOTOR DATA	64	9.60 A	12.30 A	16.40 A
FIXED BOOST	FLUXING	107	3.00 %	3.00 %	3.00 %
ACCEL TIME	REFERENCE RAMP	258	10.0 s	10.0 s	10.0 s
DECEL TIME	REFERENCE RAMP	259	10.0 s	10.0 s	10.0 s

400V Build Power Dependent Defaults								
Parameter	Function Block	Tag	Frame 2					
			0.37kW	0.55kW	0.75kW	1.1kW	1.5kW	2.2kW
MOTOR CURRENT	MOTOR DATA	64	1.50 A	2.00 A	2.50 A	3.50 A	4.50 A	5.50 A
FIXED BOOST	FLUXING	107	5.00 %	5.00 %	5.00 %	5.00 %	5.00 %	5.00 %
ACCEL TIME	REFERENCE RAMP	258	10.0 s	10.0 s	10.0 s	10.0 s	10.0 s	10.0 s
DECEL TIME	REFERENCE RAMP	259	10.0 s	10.0 s	10.0 s	10.0 s	10.0 s	10.0 s

400V Build Power Dependent Defaults						
Parameter	Function Block	Tag	Frame 3			
			3.0kW	4.0kW	5.5kW	7.5kW
MOTOR CURRENT	MOTOR DATA	64	6.80 A	9.00 A	12.00 A	16.00 A
FIXED BOOST	FLUXING	107	3.00 %	3.00 %	3.00 %	3.00 %
ACCEL TIME	REFERENCE RAMP	258	10.0 s	10.0 s	10.0 s	10.0 s
DECEL TIME	REFERENCE RAMP	259	10.0 s	10.0 s	10.0 s	10.0 s

TRIPS AND FAULT FINDING

Trips

Trip Warning Message

The trip display message is flashed repeatedly on the screen to warn of an imminent trip. Some trip conditions need time to take effect. The warning can allow you time to rectify the situation.

The message will clear when you use the Keypad, but after a short time will reappear until the problem is resolved, or the drive trips.

What Happens when a Trip Occurs

When a trip occurs, the drive's power stage is immediately disabled causing the motor and load to coast to a stop. The trip is latched until action is taken to reset it. This ensures that trips due to transient conditions are captured and the drive is disabled, even when the original cause of the trip is no longer present.

Keypad Indications

If a trip condition is detected the activated alarm is displayed on the MMI display.

Resetting a Trip Condition

All trips must be reset before the drive can be re-enabled. A trip can only be reset once the trip condition is no longer active, i.e. a trip due to a heatsink over-temperature will not reset until the temperature is below the trip level.

You can reset the trip as follows:



1. Press the  (STOP) key to reset the trip and clear the alarm from the display.
2. Remove and then re-apply the RUN command and the drive will run normally.

Success is indicated by either **rdy** or the Local Setpoint being displayed.

Using the Keypad to Manage Trips

Trip Messages

If the drive trips, then the display immediately shows a message indicating the reason for the trip. The possible trip messages are given in the table below.

ID	Trip Name	Possible Reason for Trip
1	OVERVOLTAGE 	<i>The drive internal dc link voltage is too high:</i> <ul style="list-style-type: none"> • The supply voltage is too high • Trying to decelerate a large inertia load too quickly; DECEL TIME time too short • The brake resistor is open circuit
2	UNDERVOLTAGE 	<i>DC link low trip:</i> Supply is too low/power down

ID	Trip Name	Possible Reason for Trip
3	OVERCURRENT A OC	The motor current being drawn from the drive is too high: <ul style="list-style-type: none"> Trying to accelerate a large inertia load too quickly; ACCEL TIME time too short Trying to decelerate a large inertia load too quickly; DECEL TIME time too short Application of shock load to motor Short circuit between motor phases Short circuit between motor phase and earth Motor output cables too long or too many parallel motors connected to the drive FIXED BOOST level set too high
4	HEATSINK A HOE	Drive heatsink temperature > 100°C: <ul style="list-style-type: none"> The ambient air temperature is too high Poor ventilation or spacing between drives
5	EXTERNAL TRIP A EE	The external trip input is high: <ul style="list-style-type: none"> Check configuration to identify the source of the signal (non-standard configuration)
6	INVERSE TIME A IE	A prolonged overload condition, exceeding the Inverse Time allowance, has caused the trip: <ul style="list-style-type: none"> Remove the overload condition - refer to Chapter 5: P12
7	CURRENT LOOP A LOOP	A current of less than 1mA is present when 4-20mA setpoint is selected: <ul style="list-style-type: none"> Look for a wire break
8	MOTOR STALLED A SELL	The motor has stalled (not rotating) Drive in current limit >200 seconds: <ul style="list-style-type: none"> Motor loading too great FIXED BOOST level set too high
9	AIN1 FAULT A E 3	AIN2 overload on terminal 3: <ul style="list-style-type: none"> Overcurrent applied in Current mode to terminal 3
12	DISPLAY/KEYPAD A D ISP	Keypad has been disconnected from drive whilst drive is running in Local Control: <ul style="list-style-type: none"> Keypad accidentally disconnected from drive (indicated over Comms, or by second keypad)
13	LOST COMMS A SCI	Lost communications: <ul style="list-style-type: none"> COMMS TIMEOUT parameter set too short Master device failed Wiring broken Incorrect Comms setup
14	CONTACTOR FBK A CNEC	Contact feedback signal lost: <ul style="list-style-type: none"> Check connection to the terminal wired to "contactor closed" parameter in Sequencing Logic (non-standard configuration)
17	MOTOR OVERTEMP A OE	The motor temperature is too high: <ul style="list-style-type: none"> Excessive load Motor voltage rating incorrect FIXED BOOST level set too high Prolonged operation of the motor at low speed without forced cooling Break in motor thermistor connection

7-3 Trips and Fault Finding

ID	Trip Name	Possible Reason for Trip
18	CURRENT LIMIT A I H I	Software overcurrent trip: <ul style="list-style-type: none"> If the current exceeds 180% of stack rated current for a period of 1 second, the drive will trip. This is caused by shock loads. Remove the shock load. ACCEL TIME and/or FIXED BOOST set too high DECEL TIME set too low
21	LOW SPEED OVER I A L S P d	The motor is drawing too much current (>100%) at zero output frequency: <ul style="list-style-type: none"> FIXED BOOST level set too high
22	10V FAULT A t 4	10V fault: <ul style="list-style-type: none"> +10V REF overload warning (terminal 4) - 10mA maximum
24	DESATURATION A S h t e	Desaturation: <ul style="list-style-type: none"> Instantaneous overcurrent. Refer to OVERCURRENT in this table.
25	DC LINK RIPPLE A d C F P	The dc link ripple voltage is too high: <ul style="list-style-type: none"> Check for a missing input phase
26	BRAKE SHORT CCT A d b S C	Brake resistor overcurrent: <ul style="list-style-type: none"> Check brake resistor value is greater than minimum allowed
28	ANOUT FAULT A t 5	AOUT overload on terminal 5: <ul style="list-style-type: none"> 10mA maximum
29	DIGIO 1 (T9) FAULT A t 9	DIN3 overload on terminal 9: <ul style="list-style-type: none"> 20mA maximum
30	DIGIO 2 (T10) FAULT A t 10	DOUT2 overload on terminal 10: <ul style="list-style-type: none"> 50mA maximum
31	UNKNOWN A t F I P	Unknown trip
33	ICAL A I C A L	Zero I Current Calibration: <ul style="list-style-type: none"> Current sensor calibration fault. Switch unit off/on. If persistent, return to factory.
-	Product Code Error A C O D E	Switch unit off/on. If persistent, return unit to factory
-	Calibration Data Error A C A L	Switch unit off/on. If persistent, return unit to factory
-	Configuration Data Error A D A T A	Press the E key to accept the default configuration. If persistent, return unit to factory

Hexadecimal Representation of Trips

The tables below show the possible parameter values for the AUTO RESTART TRIGGERS and AUTO RESTART TRIGGERS+ parameters, ⁵ST23 and ⁵ST24 respectively. Refer to the 650V Software Product Manual, "Trips Status" (on our website: www.SSDdrives.com) for additional trip information that is available over the Comms.

Each trip has a unique, four-digit hexadecimal number as shown in the tables below.

⁵ST23 : AUTO RESTART TRIGGERS				
ID	Trip Name (MMI 6901)	Trip Name (MMI 6511 & 6521)	Mask	User Disable
1	OVERVOLTAGE	DCHI	0x0001	
2	UNDERVOLTAGE	DCLO	0x0002	
3	OVERCURRENT	OC	0x0004	
4	HEATSINK	HOT	0x0008	
5	EXTERNAL TRIP	ET	0x0010	✓
6	INVERSE TIME		0x0020	
7	CURRENT LOOP		0x0040	✓
8	MOTOR STALLED		0x0080	✓
9	ANIN FAULT		0x0100	✓
12	DISPLAY/KEYPAD		0x0800	✓
13	LOST COMMS	SCI	0x1000	✓
14	CONTACTOR FBK	CNTC	0x2000	✓

⁵ST24 : AUTO RESTART TRIGGERS+				
ID	Trip Name (MMI 6901)	Trip Name (MMI 6511 & 6521)	Mask +	User Disable
17	MOTOR OVERTEMP		0x0001	✓
18	CURRENT LIMIT	I HI	0x0002	
21	LOW SPEED OVER I	LSPD	0x0010	
22	10V FAULT	T 4	0x0020	✓
24	SHRT	SHRT	0x0080	
25	DC LINK RIPPLE	DCRP	0x0100	✓
26	DBSC	DBSC	0x0200	
28	ANOUT FAULT	T 5	0x0800	✓
29	DIGIO 1 (T9) FAULT	T 9	0x1000	✓
30	DIGIO 2 (T10) FAULT	T 10	0x2000	✓
31	UNKNOWN	TRIP	0x4000	
33	ICAL	ICAL	0x8000	

Keypads (MMIs):

Trips shown as MMI displays in the tables above, i.e. , can be disabled using the keypads in the TRIPS menu. Other trips, as indicated, can be disabled over the Comms.



6901



6511



6521

7-5 Trips and Fault Finding

When more than one trip is to be represented at the same time then the trip codes are simply added together to form the value displayed. Within each digit, values between 10 and 15 are displayed as letters A to F

For example referring to the tables above, if the AUTO RESTART TRIGGERS parameter is set to **04A0**, then this represents:

- a “4” in digit 3
- an “8” and a “2” in digit 2
(8+2 = 10, displayed as A)
- an “0” in digit 1

This in turn represents the trips BRAKE SWITCH, ANIN FAULT, MOTOR STALLED and INVERSE TIME.

In the same way, the AUTO RESTART TRIGGERS+ parameter set to **04A0** would represent OVERSPEED, ANIN FAULT, DESAT OVER I and 10V FAULT.

Fault Finding

Problem	Possible Cause	Remedy
Drive will not power-up	Fuse blown	Check supply details, fit correct fuse. Check Product Code against Model No.
	Faulty cabling	Check all connections are correct/secure. Check cable continuity
Drive fuse keeps blowing	Faulty cabling or connections wrong	Check for problem and rectify before replacing with correct fuse
	Faulty drive	Contact Parker SSD Drives
Cannot obtain power-on state	Incorrect or no supply available	Check supply details
Motor will not run at switch-on	Motor jammed	Stop the drive and clear the jam
Motor runs and stops	Motor becomes jammed	Stop the drive and clear the jam
	Open circuit speed reference potentiometer	Check terminal

ROUTINE MAINTENANCE AND REPAIR

Routine Maintenance

Periodically inspect the drive for build-up of dust or obstructions that may affect ventilation of the unit. Remove this using dry air.

Repair

There are no user-serviceable components.

IMPORTANT: MAKE NO ATTEMPT TO REPAIR THE UNIT - RETURN IT TO PARKER SSD DRIVES.

Saving Your Application Data

In the event of a repair, application data will be saved whenever possible. However, we advise you to make a note of your application settings before returning the unit.

Returning the Unit to Parker SSD Drives

Please have the following information available:

- The model and serial number - see the unit's rating label
- Details of the fault

Contact your nearest Parker SSD Drives Service Centre to arrange return of the item.

You will be given a *Returned Material Authorisation*. Use this as a reference on all paperwork you return with the faulty item. Pack and despatch the item in the original packing materials; or at least an anti-static enclosure. Do not allow packaging chips to enter the unit.

Disposal

This product contains materials which are consignable waste under the Special Waste Regulations 1996 which complies with the EC Hazardous Waste Directive - Directive 91/689/EEC.

We recommend you dispose of the appropriate materials in accordance with the valid environmental control laws. The following table shows which materials can be recycled and which have to be disposed of in a special way.

Material	Recycle	Disposal
metal	yes	no
plastics material	yes	no
printed circuit board	no	yes

The printed circuit board should be disposed of in one of two ways:

1. High temperature incineration (minimum temperature 1200°C) by an incinerator authorised under parts A or B of the Environmental Protection Act
2. Disposal in an engineered land fill site that is licensed to take aluminium electrolytic capacitors. Do not dispose of in a land fill site set aside for domestic waste.

Packaging

During transport our products are protected by suitable packaging. This is entirely environmentally compatible and should be taken for central disposal as secondary raw material.

Technical Specifications

Understanding the Product Code

Model Number (Europe)

The unit is fully identified using a nine block alphanumeric code which records how the drive was calibrated, and its various settings when despatched from the factory.

The Product Code appears as the “Model No.” on the product rating label. Each block of the Product Code is identified as below:

650/003/230/F/00/DISP/UK/0/0
Block 1 2 3 4 5 6 7 8 9
example product code

Frame 1, 2, 3 – Model Number (Europe)		
Block No.	Variable	Description
1	650	Generic Volts/Hertz product
2	XXX	Three numbers specifying the power output: 002 = 0.25kW 011 = 1.1kW 040 = 4.0kW 003 = 0.37kW 015 = 1.5kW 055 = 5.5kW 005 = 0.55kW 022 = 2.2kW 075 = 7.5kW 007 = 0.75kW 030 = 3.0kW
3	XXX	Three numbers specifying the nominal input voltage rating: 230 = 220 to 240V (±10%) 50/60Hz 400 = 380 to 460V (±10%) 50/60Hz
4	X	One character specifying the use of the Internal RFI Filter: 0 = Not fitted F = Internal Supply Filter fitted: Class A - 400V product Class A - 230V product, 2.2 to 4.0kW Class B - 230V product, 0.25 to 1.5kW
5	XX	Two digits specifying the livery: 00 = Standard Parker SSD Drives Livery 05 = Distributor Livery (01-04, 06-99 – Defined customer liveries)
6	X	Characters specifying the use of the Keypad: 0 = Not fitted DISP = TTL Keypad fitted (not remote mountable) Block 8 must = 0 with this selection. DISPR = RS232 Keypad fitted (remote mountable). Block 8 must = R50 with this selection.
7	XX	Two Characters specifying the user labelling language: FR French (50Hz) UK English (50Hz) GR German (50Hz) US English (60Hz) IT Italian (50Hz) SP Spanish (50Hz) (figures in brackets are the drive’s default base frequency setting, P7)

Frame 1, 2, 3 – Model Number (Europe)		
Block No.	Variable	Description
8	X	Characters specifying the RS232 (P3) port fitting: 0 = No RS232 port (drive uses TTL Keypad) RS0 = RS232 port (drive uses RS232 Keypad)
9	X	Numbers specifying any special option: 0 = Standard Product 001-999 = special option fitted

Catalog Number (North America)

The unit is identified using a 4 block alphanumeric code which records how the drive was calibrated, and its various settings when dispatched from the factory.

The Product Code appears as the “Cat No.”. Each block of the Product Code is identified as below:

650/00F3/230/F
Block 1 2 3 4
example product code

Products with TTL Keypad		
Frame 1, 2, 3 – Catalog Number (North America)		
Block No.	Variable	Description
1	650	Generic product
2	XXXX	Four characters specifying the power output in Hp: 00F3 = 0.3Hp 01F5 = 1.5Hp 0005 = 5Hp 00F5 = 0.5Hp 0002 = 2Hp 0007 = 7Hp 00F7 = 0.75Hp 0003 = 3Hp 0010 = 10Hp 0001 = 1Hp
3	XXX	Three numbers specifying the nominal input voltage rating: 230 230 (±10%) 50/60Hz 460 380 to 460V (±10%) 50/60Hz
4	X	One character specifying the use of the Internal RFI Filter: 0 = Not fitted F = Internal Supply Filter fitted: Class A - 400V product Class B - 230V product

9-3 Technical Specifications

Environmental Details	
Operating Temperature	0°C to 40°C
Storage Temperature	-25°C to +55°C
Shipping Temperature	-25°C to +70°C
Product Enclosure Rating	IP20 (UL Open Type) suitable for cubicle mount only
Cubicle Rating	Cubicle to provide 15dB attenuation to radiated emissions between 30-100MHz. It must also require a security tool for opening
Altitude	If > 1000 metres (3300 feet) above sea level, derate Motor Power Rating by 1% per 100 metres (330 feet)
Humidity	Maximum 85% relative humidity at 40°C non-condensing
Atmosphere	Non flammable, non corrosive and dust free
Climatic Conditions	Class 3k3, as defined by EN50178 (1998)
Vibration	Test Fc of EN60068-2-6 10Hz<=f<=57Hz sinusoidal 0.075mm amplitude 57Hz<=f<=150Hz sinusoidal 1g 10 sweep cycles per axis on each of three mutually perpendicular axis
Safety	
Pollution Degree	Pollution Degree II (non-conductive pollution, except for temporary condensation)
Overvoltage Category	Overvoltage Category III (numeral defining an impulse withstand level)

Power Details	
1-Phase Supply	220-240V ac ±10%,50/60Hz ±10%, ground referenced (TN) or non-ground referenced (IT)
3-Phase Supply	220-240V or 380-460V ac ±10%,50/60Hz ±10%, ground referenced (TN) or non-ground referenced (IT)
Supply Power Factor (lag)	0.9 (@ 50/60Hz)
Output Frequency	0 – 240Hz
Overload	150% for 30 seconds
Maximum Supply Short Circuit Rating	220-240V 1φ product -5000A, 220-240V 3φ product -7500A 380-460V 3φ product -10000A

User Relay	
Terminals RL1A, RL1B.	
Maximum Voltage	250Vac
Maximum Current	4A resistive load
Sample Interval	10ms

Electrical Ratings

Motor power, output current and input current must not be exceeded under steady state operating conditions.

Maximum Motor $dv/dt = 10,000V/\mu s$. This can be reduced by adding a motor choke in series with the motor. Contact Eurotherm Drives for recommended choke details.

Local wiring regulations always take precedence. Select cable rated for the drive.

The supply must be protected with a fuse (or Type B RCD) rated to the supply cable.

Note: For 3-phase units Frames 2 & 3, the Surge Current is less than the running current.

FRAME 1 : 1-Phase (IT/TN), 230V

Drive Power (kW/hp)	Input Current @ 5kA		Output Current @ 40°C (A) ac	Maximum Power Loss (W)
	Surge Current peak/rms for 10ms (A)	(A)		
0.25/0.3	19/12	4.2	1.5	26
0.37/0.5	19/12	6.2	2.2	32
0.55/0.75	20/14	7.9	3.0	41
0.75/1.0	22/15	10.5	4.0	52

FRAME 2 : 1-Phase (IT/TN), 230V

Drive Power (kW/hp)	Input Current @ 5kA		Output Current @ 40°C (A) ac	Maximum Power Loss (W)
	Surge Current peak/rms for 10ms (A)	(A)		
1.1/1.5	24/17	13.8	5.5	65
1.5/2.0	25/18	16.0	7.0	82

FRAME 2 : 3-Phase (IT/TN), 400V

Drive Power (kW/hp)	Input Current @ 10kA (A)	Output Current @ 40°C (A) ac	Maximum Power Loss (W)
0.37/0.5	2.5	1.5	26
0.55/0.75	3.3	2.0	32
0.75/1.0	4.1	2.5	40
1.1/1.5	5.9	3.5	55
1.5/2.0	7.5	4.5	61
2.2/3.0	9.4	5.5	70

FRAME 3 : 1-Phase (IT/TN), 230V

Drive Power (kW/hp)	Input Current @ 7.5kA (A)	Output Current @ 40°C (A) ac	Maximum Power Loss (W)
* 2.2/3.0	22.0	9.6	112

FRAME 3 : 3-Phase (IT/TN), 230V

Drive Power (kW/hp)	Input Current @ 7.5kA (A)	Output Current @ 40°C (A) ac	Maximum Power Loss (W)
* 2.2/3.0	14.3	9.6	103
3.0/4	18.1	12.3	133
4.0/5	23.1	16.4	180

FRAME 3 : 3-Phase (IT/TN), 400V

Drive Power (kW/hp)	Input Current @ 10kA (A)	Output Current @ 40°C (A) ac	Maximum Power Loss (W)
3.0/4	11.1	6.8	80
4.0/5	13.9	9.0	100
5.5/7.5	18.0	12.0	136
7.5/10	23.6	16.0	180

* The Frame 3, 2.2kW drive is capable of operating on a 1-phase or 3-phase supply.

9-5 Technical Specifications

Analog Inputs/Outputs		
Terminals AIN1, AIN2, AOUT1.		
	Inputs	Output
Range	0-10V and 0-5V (no sign) set via parameter ^s IP13 (AIN1) 0-10V, 0-5V, 0-20mA or 4-20mA (no sign) set via parameter ^s IP23 (AIN2) Absolute maximum input current 25mA in current mode Absolute maximum input voltage 24V dc in voltage mode	0-10V (no sign) Maximum rated output current 10mA, with short circuit protection
Impedance	Voltage input 20kΩ Current Input <6V @ 20mA	
Resolution	10 bits (1 in 1024)	10 bits (1 in 1024)
Dynamic Response	Sampled every 10ms	Bandwidth 15Hz

Digital Inputs		
Terminals DIN1, DIN2, DIN3, DIN4.		
Operating Range	0-5V dc = OFF, 15-24V dc = ON (absolute maximum input voltage ±30V dc) IEC1131	
Input Current	7.5mA @ 24V	
Sample Interval	10ms	

Digital Outputs	
Terminals DOUT2 (DOUT1 is reserved for future models).	
Nominal Open Circuit Output Voltage	23V (minimum 19V)
Nominal Output Impedance	33Ω
Rated Output Current	50mA

Cabling Requirements for EMC Compliance				
	Power Supply Cable	Motor Cable	Brake Resistor Cable	Signal/Control Cable
Cable Type (for EMC Compliance)	Unscreened	Screened/armoured	Screened/armoured	Screened
Segregation	From all other wiring (clean)	From all other wiring (noisy)		From all other wiring (sensitive)
Length Limitations With Internal AC Supply EMC Filter	Unlimited	*25 metres	25 metres	25 metres
Length Limitations Without Internal AC Supply EMC Filter	Unlimited	25 metres	25 metres	25 metres
Screen to Earth Connection		Both ends	Both ends	Drive end only
Output Choke		300 metres maximum		
* Maximum motor cable length under any circumstances				

Internal Dynamic Braking Circuit				
The dynamic braking circuit is intended for with short term stopping or braking. DC link brake voltage : 750V				
Motor Power (kW/Hp)	Brake Switch Peak Current (A)	Brake Switch Continuous Current (A)	Peak Brake Dissipation (kW/Hp)	Minimum Brake Resistor Value (Ω)
Frame 2 : 3 Phase (IT/TN), 400V, 100% duty				
0.37/0.5	1.5	1.5	1.1/1.5	500
0.55/0.75	1.5	1.5	1.1/1.5	500
0.75/1.0	1.5	1.5	1.1/1.5	500
1.1/1.5	1.5	1.5	1.1/1.5	500
1.5/2.0	3.75	3.75	2.8/3.75	200
2.2/3.0	3.75	3.75	2.8/3.75	200
Frame 3 : 1 Phase (IT/TN), 230V, 100% duty				
2.2/3.0	7.0	7.0	2.72	56
Frame 3 : 3 Phase (IT/TN), 230V, 100% duty				
2.2/3.0	7.0	7.0	2.72	56
3.0/4	10.8	10.8	4.23	36
4.0/5	14.0	14.0	5.44	28
Frame 3 : 3 Phase (IT/TN), 400V, 30% duty				
3.0/4	7.5	2.3	5.6/7.5	100
4.0/5	7.5	2.3	5.6/7.5	100
5.5/7.5	13.5	4.0	10/13.4	56
7.5/10	13.5	4.0	10/13.4	56

External Brake Resistor

All 650 units are supplied without braking resistors. The dynamic brake switch terminals (where fitted) allow easy connection to an external resistor. These resistors should be mounted on a heatsink (back panel) and covered to prevent injury from burning.

Recommended Brake Resistors

The following brake resistors are available from Parker SSD Drives:

Brake Resistor Value : Frame 2 : 200Ω, 100W - CZ467714; 500Ω, 60W - CZ467715
 Frame 3 : 28Ω, 500W (2 x 56Ω in parallel) - CZ467716; 36Ω, 500W - CZ388396;
 56Ω, 500W - CZ467716; 100Ω, 200W - CZ467717

Alternative Brake Resistor Selection

Brake resistor assemblies must be rated to absorb both peak braking power during deceleration and the average power over the repeated cycles.

Peak braking power $P_{pk} = \frac{0.0055 \times J \times (n_1^2 - n_2^2)}{t_b}$ (W)

Average braking power $P_{av} = \frac{P_{pk}}{t_c} \times t_b$

J- total inertia (kgm²)
 n₁- initial speed (rpm)
 n₂- final speed (rpm)
 t_b- braking time (s)
 t_c- cycle time (s)

Obtain information on the peak power rating and the average power rating of the resistors from the resistor manufacturer. If this information is not available, a large safety margin must be incorporated to ensure that the resistors are not overloaded. By connecting these resistors in series and in parallel the braking capacity can be selected for the application.

IMPORTANT: The minimum resistance of the combination and maximum dc link voltage must be as specified.

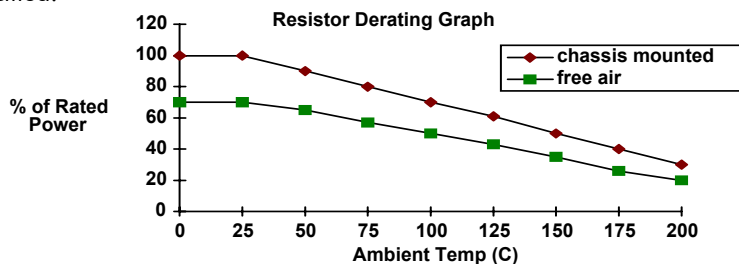

Supply Harmonic Analysis (230V filtered)

Assumptions: (Short circuit fault to Neutral)

5kA short circuit supply capability at 230V 1φ, equivalent to 146μH supply impedance

7.5kA short circuit supply capability at 230V 3φ, equivalent to 56μH supply impedance

10kA short circuit supply capability at 400V 3φ, equivalent to 73μH supply impedance

$$THD(V) \times 100 = \frac{\sqrt{\sum_{h=2}^{h=40} Q_{h^2}}}{Q_{1n}} \%$$

where Q_{1n} is the rated rms value of the fundamental voltage of the supply transformer.

The results conform to stage 1 and stage 2 of the Engineering Recommendation G.5/4 February 2001, Classification 'C': Limits for Harmonics in the UK Electricity Industry.

Drive Type	650								
Motor Power (kW)	0.25	0.37	0.55	0.75	1.1	1.5	2.2	3.0	4.0
Fundamental Voltage (V)	230	230	230	230	230	230	230	230	230
Typical Motor Efficiency %	85	85	85	85	85	85	85	85	85
Harmonic No.	RMS Current (A)								
1	7.4	7.5	7.8	8.2	9.0	10.3	TBA	TBA	TBA
3	1.4	0.2	1.9	2.2	2.9	3.9			
5	2.9	0.4	4.4	4.6	4.8	5.2			
7	1.1	0.5	1.9	2.0	2.3	2.5			
9	0.2	0.2	0.2	0.3	0.4	0.4			
11	0.1	0.1	0.2	0.2	0.2	0.3			
13	0.0	0.1	0.1	0.1	0.1	0.1			
15	0.1	0.0	0.1	0.1	0.1	0.1			
17	0.0	0.1	0.0	0.0	0.0	0.1			
19	0.0	0.0	0.0	0.0	0.0	0.1			
21	0.0	0.0	0.0	0.0	0.0	0.1			
23	0.0	0.0	0.0	0.0	0.0	0.0			
25	0.0	0.0	0.0	0.0	0.0	0.0			
27	0.0	0.0	0.0	0.0	0.0	0.0			
29	0.0	0.0	0.0	0.0	0.0	0.0			
31	0.0	0.0	0.0	0.0	0.0	0.0			
33	0.0	0.0	0.0	0.0	0.0	0.0			
35	0.0	0.0	0.0	0.0	0.0	0.0			
37	0.0	0.0	0.0	0.0	0.0	0.0			
39	0.0	0.0	0.0	0.0	0.0	0.0			
40	0.0	0.0	0.0	0.0	0.0	0.0			
Total RMS Current (A)	8.2	7.5	9.3	9.9	10.9	12.5			
THD (V) %	0.3559	0.0972	0.5426	0.5733	0.6277	0.7055			

Supply Harmonic Analysis (400V filtered)

Assumptions: (Short circuit fault to Neutral)
 5kA short circuit supply capability at 230V 1ϕ, equivalent to 146μH supply impedance
 7.5kA short circuit supply capability at 230V 3ϕ, equivalent to 56μH supply impedance
 10kA short circuit supply capability at 400V 3ϕ, equivalent to 73μH supply impedance

$$THD(V) \times 100 = \frac{\sqrt{\sum_{h=2}^{h=40} Q_{h^2}}}{Q_{1n}} \%$$

where Q_{1n} is the rated rms value of the fundamental voltage of the supply transformer.
 The results conform to stage 1 and stage 2 of the Engineering Recommendation G.5/4 February 2001, Classification 'C': Limits for Harmonics in the UK Electricity Industry.

Drive Type	650									
Motor Power (kW)	0.37	0.55	0.75	1.1	1.5	2.2	3.0	4.0	5.5	7.5
Fundamental Voltage (V)	400	400	400	400	400	400	400	400	400	400
Typical Motor Efficiency %	85	85	85	85	85	85	85	85	85	85
Harmonic No.	RMS Current (A)									
1	0.6	1.0	1.3	1.9	2.6	3.8	5.2	6.9	9.5	12.9
3	0.0	0.0	0.0	0.0	0.0	0.0	0.0	0.0	0.0	0.0
5	0.6	0.9	1.2	1.8	2.4	3.5	4.7	6.2	8.3	11.1
7	0.6	0.9	1.2	1.7	2.3	3.3	4.3	5.5	7.3	9.5
9	0.0	0.0	0.0	0.0	0.0	0.0	0.0	0.0	0.0	0.0
11	0.5	0.8	1.0	1.5	1.9	2.6	3.3	3.9	4.8	5.7
13	0.0	0.7	0.9	1.3	1.6	2.2	2.7	3.0	3.5	3.9
15	0.4	0.0	0.0	0.0	0.0	0.0	0.0	0.0	0.0	0.0
17	0.4	0.6	0.7	1.0	1.1	1.4	1.6	1.5	1.4	1.2
19	0.0	0.5	0.6	0.9	0.9	1.1	1.1	0.9	0.8	0.7
21	0.3	0.0	0.0	0.0	0.0	0.0	0.0	0.0	0.0	0.0
23	0.2	0.3	0.4	0.6	0.5	0.5	0.4	0.3	0.5	0.7
25	0.0	0.3	0.3	0.4	0.3	0.3	0.2	0.4	0.5	0.7
27	0.1	0.0	0.0	0.0	0.0	0.0	0.0	0.0	0.0	0.0
29	0.1	0.2	0.2	0.2	0.1	0.2	0.3	0.4	0.4	0.4
31	0.0	0.1	0.1	0.1	0.1	0.2	0.3	0.3	0.3	0.3
33	0.1	0.0	0.0	0.0	0.0	0.0	0.0	0.0	0.0	0.0
35	0.0	0.1	0.1	0.1	0.1	0.2	0.2	0.2	0.2	0.3
37	0.0	0.1	0.1	0.1	0.1	0.2	0.1	0.1	0.2	0.3
39	0.0	0.0	0.0	0.0	0.0	0.0	0.0	0.0	0.0	0.0
40	0.0	0.0	0.0	0.0	0.0	0.0	0.0	0.0	0.0	0.0
Total RMS Current (A)	1.4	2.1	2.8	4.0	5.1	7.2	9.5	12.0	15.8	20.8
THD (V) %	0.1561	0.2158	0.2776	0.3859	0.4393	0.5745	0.6994	0.8111	0.9899	1.2110

Supply Harmonic Analysis (230V unfiltered)

Assumptions: (Short circuit fault to Neutral)

- 5kA short circuit supply capability at 230V 1φ, equivalent to 146μH supply impedance
- 7.5kA short circuit supply capability at 230V 3φ, equivalent to 56μH supply impedance
- 10kA short circuit supply capability at 400V 3φ, equivalent to 73μH supply impedance

$$THD(V) \times 100 = \frac{\sqrt{\sum_{h=2}^{h=40} Q_{h^2}}}{Q_{1n}} \%$$

where Q_{1n} is the rated rms value of the fundamental voltage of the supply transformer.

The results conform to stage 1, stage 2 and stage 3 of the Engineering Recommendation G.5/3 September 1976, Classification 'C': Limits for Harmonics in the UK Electricity Industry.

Drive Type	650								
Motor Power (kW)	0.25	0.37	0.55	0.75	1.1	1.5	2.2	3.0	4.0
Fundamental Voltage (V)	230	230	230	230	230	230	230	230	230
Typical Motor Efficiency %	85	85	85	85	85	85	85	85	85
Harmonic No.	RMS Current (A)								
1	1.3	2.0	2.9	3.9	5.7	7.8	TBA	TBA	TBA
3	1.3	1.9	2.9	3.8	5.5	7.4			
5	1.2	1.9	2.7	3.5	5.0	6.7			
7	1.1	1.7	2.5	3.1	4.4	5.4			
9	1.1	1.6	2.2	2.7	3.7	4.6			
11	1.0	1.4	1.9	2.2	2.9	3.4			
13	0.8	1.2	1.6	1.6	2.1	2.3			
15	0.7	1.0	1.3	1.2	1.4	1.4			
17	0.6	0.8	1.0	0.8	0.8	0.7			
19	0.5	0.7	0.7	0.4	0.4	0.3			
21	0.4	0.5	0.5	0.2	0.2	0.4			
23	0.3	0.3	0.3	0.2	0.3	0.4			
25	0.2	0.2	0.1	0.2	0.3	0.4			
27	0.1	0.1	0.1	0.2	0.3	0.3			
29	0.1	0.1	0.1	0.2	0.2	0.2			
31	0.0	0.1	0.1	0.1	0.1	0.1			
33	0.0	0.1	0.1	0.1	0.1	0.2			
35	0.0	0.1	0.1	0.1	0.1	0.2			
37	0.1	0.1	0.1	0.1	0.1	0.1			
39	0.0	0.1	0.1	0.1	0.1	0.1			
40	0.0	0.0	0.0	0.0	0.0	0.0			
Total RMS Current (A)	3.2	4.8	6.7	8.3	11.7	15.3			
THD (V) %	0.5633	0.8016	1.0340	1.0944	1.4611	1.7778			

Supply Harmonic Analysis (400V unfiltered)

Assumptions: (Short circuit fault to Neutral)
 5kA short circuit supply capability at 230V 1ϕ, equivalent to 146μH supply impedance
 7.5kA short circuit supply capability at 230V 3ϕ, equivalent to 56μH supply impedance
 10kA short circuit supply capability at 400V 3ϕ, equivalent to 73μH supply impedance

$$THD(V) \times 100 = \frac{\sqrt{\sum_{h=2}^{h=40} Q_{h^2}}}{Q_{1n}} \%$$

where Q_{1n} is the rated rms value of the fundamental voltage of the supply transformer.

The results conform to stage 1, stage 2 and stage 3 of the Engineering Recommendation G.5/3 September 1976, Classification 'C': Limits for Harmonics in the UK Electricity Industry.

Drive Type	650									
Motor Power (kW)	0.37	0.55	0.75	1.1	1.5	2.2	3.0	4.0	5.5	7.5
Fundamental Voltage (V)	400	400	400	400	400	400	400	400	400	400
Typical Motor Efficiency %	85	85	85	85	85	85	85	85	85	85
Harmonic No.	RMS Current (A)									
1	0.6	0.9	1.3	1.9	2.6	3.8	5.2	6.9	9.5	12.7
3	0.0	0.0	0.0	0.0	0.0	0.0	0.0	0.0	0.0	0.0
5	0.6	0.9	1.2	1.8	2.4	3.6	4.7	6.3	8.4	11.0
7	0.6	0.9	1.2	1.7	2.3	3.3	4.3	5.7	7.4	9.5
9	0.0	0.0	0.0	0.0	0.0	0.0	0.0	0.0	0.0	0.0
11	0.5	0.8	1.0	1.5	1.9	2.6	3.3	4.2	4.9	5.8
13	0.5	0.7	0.9	1.3	1.6	2.2	2.7	3.4	3.7	4.0
15	0.0	0.0	0.0	0.0	0.0	0.0	0.0	0.0	0.0	0.0
17	0.4	0.6	0.7	0.9	1.2	1.5	1.6	1.9	1.5	1.3
19	0.4	0.5	0.6	0.8	0.9	1.1	1.1	1.3	0.8	0.7
21	0.0	0.0	0.0	0.0	0.0	0.0	0.0	0.0	0.0	0.0
23	0.3	0.4	0.4	0.5	0.5	0.5	0.4	0.4	0.5	0.7
25	0.2	0.3	0.3	0.3	0.4	0.3	0.2	0.3	0.5	0.7
27	0.0	0.0	0.0	0.0	0.0	0.0	0.0	0.0	0.0	0.0
29	0.1	0.2	0.2	0.2	0.1	0.2	0.2	0.3	0.4	0.4
31	0.1	0.1	0.1	0.1	0.1	0.2	0.3	0.3	0.3	0.3
33	0.0	0.0	0.0	0.0	0.0	0.0	0.0	0.0	0.0	0.0
35	0.1	0.1	0.1	0.1	0.1	0.2	0.2	0.2	0.2	0.3
37	0.0	0.1	0.1	0.1	0.1	0.2	0.2	0.1	0.2	0.2
39	0.0	0.0	0.0	0.0	0.0	0.0	0.0	0.0	0.0	0.0
40	0.0	0.0	0.0	0.0	0.0	0.0	0.0	0.0	0.0	0.0
Total RMS Current (A)	1.5	2.1	2.8	4.0	5.1	7.4	9.5	12.4	16.0	20.6
THD (V) %	0.1634	0.2209	0.2817	0.3569	0.4444	0.5886	0.7107	0.8896	1.0127	1.2138

CERTIFICATION FOR THE DRIVE

Requirements for EMC Compliance

Earthing Requirements

IMPORTANT: Protective earthing always takes precedence over EMC earthing.

Protective Earth (PE) Connections

Note: In accordance with installations to EN60204, only one protective earth conductor is permitted at each protective earth terminal contacting point.

Local wiring regulations may require the protective earth connection of the motor to be connected locally, i.e. not as specified in these instructions. This will not cause shielding problems because of the relatively high RF impedance of the local earth connection.

EMC Earth Connections

For compliance with EMC requirements, the “0V/signal ground” is to be separately earthed. When a number of units are used in a system, these terminals should be connected together at a single, local earthing point.

Control and signal cables connections should be made with screened cables, with the screen connected only at the VSD end. However, if high frequency noise is still a problem, earth screen at the non VSD end via a 0.1µF capacitor.

Note: Connect the screen (at the VSD end) to the VSD protective earth point, and not to the control board terminals.

Requirements for UL Compliance

Solid-State Motor Overload Protection

These devices provide Class 10 motor overload protection. The maximum internal overload protection level (current limit) is 150% for 30 seconds.

An external motor overload protective device must be provided by the installer where the motor has a full-load ampere rating of less than 50% of the drive output rating; or when the DISABLE STALL trip (^SSTLL) is set to True (1).

Short Circuit Rating

The following drives are suitable for use on a circuit capable of delivering not more than:

220-240V product, 1φ - 5000 RMS Symmetrical Amperes

220-240V product, 3φ - 7500 RMS Symmetrical Amperes

380-460V product, 3φ - 10000 RMS Symmetrical Amperes

Solid-State Short-Circuit Protection

These devices are provided with Solid-State Short-Circuit (output) Protection. Branch circuit protection requirements must be in accordance with the latest edition of the National Electrical Code NEC/NFPA-70.

Recommended Branch Circuit Protection

It is recommended that UL Listed (JDDZ) non-renewable cartridge fuses, Class K5 or H; or UL Listed (JDRX) renewable cartridge fuses, Class H, are installed upstream of the drive.

Motor Base Frequency

The motor base frequency rating is 240Hz maximum.

Field Wiring Temperature Rating

Use 75°C Copper conductors only.

Field Wiring Terminal Markings

For correct field wiring connections that are to be made to each terminal refer to Chapter 3: "Installing the Drive" - Wiring Guidelines.

Terminal Tightening Torque

Refer to Chapter 3: "Installing the Drive" – Terminal Tightening Torque.

Terminal/Wire Sizes

North American wire sizes (AWG) are based on NEC/NFPA-70 for ampacities of thermoplastic-insulated (75°C) copper conductors.

Power input and output wire sizes should allow for an ampacity of 125% of the rated input and output amperes for motor branch-circuit conductors as specified in NEC/NFPA-70. Refer to Chapter 3: "Installing the Drive" – Terminal Block Acceptance Sizes.

Input Fuse Ratings

If fitted, fuses should be in accordance with NEC/NFPA-70.

FRAME 1 : 1-Phase (IT/TN), 230V		
Drive Power (kW/hp)	Input Current @ 5kA (A)	Supply Fuse Rating (A) 10 x 38mm
0.25/0.3	4.2	10
0.37/0.5	6.2	10
0.55/0.75	7.9	10
0.75/1.0	10.5	15
FRAME 2 : 1-Phase (IT/TN), 230V		
Drive Power (kW/hp)	Input Current @ 5kA (A)	Supply Fuse Rating (A) 10 x 38mm
1.1/1.5	13.8	20
1.5/2.0	16.0	20
FRAME 2 : 3-Phase (IT/TN), 400V		
Drive Power (kW/hp)	Input Current @ 10kA (A)	Supply Fuse Rating (A) 10 x 38mm
0.37/0.5	2.5	10
0.55/0.75	3.3	10
0.75/1.0	4.1	10
1.1/1.5	5.9	10
1.5/2.0	7.5	10
2.2/3.0	9.4	15
FRAME 3 : 1-Phase (IT/TN), 230V		
Drive Power (kW/hp)	Input Current @ 7.5kA (A)	Supply Fuse Rating (A) 10 x 38mm
2.2/3.0	22.0	30
FRAME 3 : 3-Phase (IT/TN), 230V		
Drive Power (kW/hp)	Input Current @ 7.5kA (A)	Supply Fuse Rating (A) 10 x 38mm
2.2/3.0	14.3	20
3.0/4	18.1	25
4.0/5	23.1	30
FRAME 3 : 3-Phase (IT/TN), 400V		
Drive Power (kW/hp)	Input Current @ 10kA (A)	Supply Fuse Rating (A) 10 x 38mm
3.0/4	11.1	15
4.0/5	13.9	20
5.5/7.5	18.0	25
7.5/10	23.6	30

10-3 Certification for the Drive

Field Grounding Terminals

The field grounding terminals are identified with the International Grounding Symbol (IEC Publication 417, Symbol 5019).



Operating Ambient Temperature

Devices are considered acceptable for use in a maximum ambient temperature of 40°C (can be derated up to 50°C).

European Directives and the CE Mark

CE Marking for Low Voltage Directive

When installed in accordance with this manual, the 650 Series AC Drive is CE marked by Parker SSD Drives in accordance with the low voltage directive (S.I. No. 3260 implements this LVD directive into UK law). An EC Declaration of Conformity (low voltage directive) is included at the end of this chapter.

CE Marking for EMC - Who is Responsible?

Note: The specified EMC emission and immunity performance of this unit can only be achieved when the unit is installed to the EMC Installation Instructions given in this manual.

According to S.I. No. 2373 which implements the EMC directive into UK law, the requirement for CE marking this unit falls into two categories:

1. Where the supplied unit has an intrinsic/direct function to the end user, then the unit is classed as **relevant apparatus**. In this situation the responsibility for certification rests with Parker SSD Drives. The Declaration of Conformity is included at the end of this Chapter.
2. Where the supplied unit is incorporated into a higher system/apparatus or machine which includes (at least) the motor, cable and a driven load but is unable to function without this unit, then the unit is classed as a **component**. In this circumstance, the responsibility rests with the manufacturer/supplier/installer of the system/apparatus/machine.

EMC Compliance

All Models All models are compliant with BS EN61800-3.	
Radiated Emissions	EN50081-1(1992) and EN61800-3 unrestricted distribution when mounted inside the specified cubicle, see above. Control and motor cables must be screened and correctly fitted with glands where they exit the cubicle. Control 0V must be connected to protective earth/ground.
Immunity	EN50082-1 (1997), EN61800-3 (1997), EN61000-6-2 (1999)
FRAME 1 & 2: 1-Phase (TN only),	
Conducted Emissions	EN50081-1(1992), EN61800-3 unrestricted distribution, maximum motor cable length: 25m
FRAME 2 & 3 : 3-Phase, FRAME 3 : 1-Phase (TN only)	
Conducted Emissions	EN50081-2(1993), EN61800-3 restricted distribution maximum motor cable length: 25m

Certificates

650 0.25 - 4.0kW 230V



EC DECLARATIONS OF CONFORMITY

Date CE marked first applied: 26/07/2001

EMC Directive

In accordance with the EEC Directive
2004/108/EC

We Parker SSD Drives, address as below, declare under our sole responsibility that the above Electronic Products when installed and operated with reference to the instructions in the Product Manual (provided with each piece of equipment) is in accordance with the relevant clauses from the following standard:-

BSEN61800-3 (2004)

Low Voltage Directive

In accordance with the EEC Directive
2006/95/EC

We Parker SSD Drives, address as below, declare under our sole responsibility that the above Electronic Products when installed and operated with reference to the instructions in the Product Manual (provided with each piece of equipment), is in accordance with the following standard :-

EN61800 (2007)

Issued for compliance with the EMC Directive when the unit is used as *relevant apparatus*.

The drive is CE marked in accordance with the low voltage directive for electrical equipment and appliances in the voltage range when installed correctly.

MANUFACTURERS DECLARATIONS

EMC Declaration

We Parker SSD Drives, address as below, declare under our sole responsibility that the above Electronic Products when installed and operated with reference to the instructions in the Product Manual (provided with each piece of equipment) is in accordance with the relevant clauses from the following standard:-

BSEN61800-3 (2004)

This is provided to aid your justification for EMC compliance when the unit is used as a component.

Machinery Directive

The above Electronic Products are components to be incorporated into machinery and may not be operated alone.

The complete machinery or installation using this equipment may only be put into service when the safety considerations of the Directive 89/392/EEC are fully adhered to.

Particular reference should be made to EN60204-1 (Safety of Machinery - Electrical Equipment of Machines).

All instructions, warnings and safety information of the Product Manual must be adhered to.

Since the potential hazards are mainly electrical rather than mechanical, the drive does not fall under the machinery directive. However, we do supply a manufacturer's declaration for when the drive is used(as a component) in machinery.

Dr Martin Payn (Conformance Officer)

Compliant with these immunity standards without specified EMC filters.

PARKER SSD DRIVES

NEW COURTWICK LANE, LITTLEHAMPTON, WEST SUSSEX BN17 7RZ
TELEPHONE: +44(0)1903 737000 FAX: +44(0)1903 737100

Registered Number: 4806503 England. Registered Office: 55 Maylands Avenue, Hemel Hempstead, Herts HP2 4SJ

Certificates

Issued for compliance with the EMC Directive when the unit is used as *relevant apparatus*.

This is provided to aid your justification for EMC compliance when the unit is used as a component.

650 0.37 - 7.5kW 400V	
<div style="display: flex; justify-content: space-between; align-items: center;"> <div style="font-size: 2em; font-weight: bold;">CE</div> <div style="text-align: center;"> <h3>EC DECLARATIONS OF CONFORMITY</h3> <p>Date CE marked first applied: 26/07/2001</p> </div> </div>	
<div style="text-align: center; background-color: black; color: white; padding: 2px; font-weight: bold;">EMC Directive</div> <p>In accordance with the EEC Directive 2004/108/EC</p> <p>We Parker SSD Drives, address as below, declare under our sole responsibility that the above Electronic Products when installed and operated with reference to the instructions in the Product Manual (provided with each piece of equipment) is in accordance with the relevant clauses from the following standard:-</p> <p style="text-align: center;">BSEN61800-3 (2004)</p>	<div style="text-align: center; background-color: black; color: white; padding: 2px; font-weight: bold;">Low Voltage Directive</div> <p>In accordance with the EEC Directive 2006/95/EC</p> <p>We Parker SSD Drives, address as below, declare under our sole responsibility that the above Electronic Products when installed and operated with reference to the instructions in the Product Manual (provided with each piece of equipment), is in accordance with the following standard :-</p> <p style="text-align: center;">EN61800 (2007)</p>
<h3>MANUFACTURERS DECLARATIONS</h3>	
<div style="text-align: center; background-color: black; color: white; padding: 2px; font-weight: bold;">EMC Declaration</div> <p>We Parker SSD Drives, address as below, declare under our sole responsibility that the above Electronic Products when installed and operated with reference to the instructions in the Product Manual (provided with each piece of equipment) is in accordance with the relevant clauses from the following standard:-</p> <p style="text-align: center;">BSEN61800-3 (2004)</p>	<div style="text-align: center; background-color: black; color: white; padding: 2px; font-weight: bold;">Machinery Directive</div> <p>The above Electronic Products are components to be incorporated into machinery and may not be operated alone.</p> <p>The complete machinery or installation using this equipment may only be put into service when the safety considerations of the Directive 89/392/EEC are fully adhered to.</p> <p>Particular reference should be made to EN60204-1 (Safety of Machinery - Electrical Equipment of Machines).</p> <p>All instructions, warnings and safety information of the Product Manual must be adhered to.</p>
 <hr style="width: 20%; margin: auto;"/> <p>Dr Martin Payn (Conformance Officer)</p>	
<p># Compliant with these immunity standards without specified EMC filters.</p>	
<p>PARKER SSD DRIVES NEW COURTWICK LANE, LITTLEHAMPTON, WEST SUSSEX BN17 7RZ TELEPHONE: +44(0)1903 737000 FAX: +44(0)1903 737100 Registered Number: 4806503 England. Registered Office: 55 Maylands Avenue, Hemel Hempstead, Herts HP2 4SJ</p>	

The drive is CE marked in accordance with the low voltage directive for electrical equipment and appliances in the voltage range when installed correctly.

Since the potential hazards are mainly electrical rather than mechanical, the drive does not fall under the machinery directive. However, we do supply a manufacturer's declaration for when the drive is used (as a component) in machinery.

SERIAL COMMUNICATIONS

Connection to the P3 Port

IMPORTANT: The drive **MUST** be earthed. Failure to do so could damage your communications ports.

The port is an un-isolated RS232, 19200 Baud. Contact Parker SSD Drives for further information.

The P3 port is located under the terminal cover and is used only by the remote-mounted RS232 Keypad.

P3 Port

A standard P3 lead is used to connect to the drive.

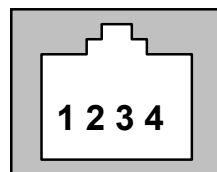

P3 Port Pin	Lead	Signal
1	Black	0V
2	Red	5V
3	Green	TX
4	Yellow	RX

Note: There is 5V present on pin 2 of the P3 port - do not connect this to your PC.

APPLICATIONS

The Default Application

The drive is supplied with 6 Applications, Application 0 to Application 5. Each Application recalls a pre-programmed structure of internal links when it is loaded.

DEFAULT

- Application 0 will not control a motor. Loading Application 0 removes all internal links.
- Application 1 is the factory default application, providing for basic speed control
- Application 2 supplies speed control using a manual or auto setpoint
- Application 3 supplies speed control using preset speeds
- Application 4 is a set-up providing speed control with Raise/Lower Trim
- Application 5 supplies speed control with Run Forward/Run Reverse

IMPORTANT: Refer to Chapter 5: The Keypad – Special Menu Features to reset the drive to factory default values which are suitable for most applications.

How to Load an Application

In the **PRG** menu, go to **P I** and press the **M** key twice.

The Applications are stored in this menu.

Use the **▲** **▼** keys to select the appropriate Application by number.

Press the **E** key to load the Application.

Application Description

Control Wiring for Applications

The large Application Diagrams on the following pages show the full wiring for push-button starting. The diagrams on the reverse show the full wiring for single wire starting.

For the minimum connections to make the drive run refer to Chapter 3: "Installing the Drive" - Electrical Installation; the remaining connections can be made to suit your system.

When you load an Application, the input and output parameters shown in these diagrams default to the settings shown. For alternative user-settings refer to the Software Product Manual, Chapter 1 "Programming Your Application".

Key to Application Diagrams

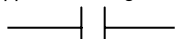

normally open contact (relay)

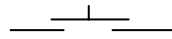

normally open push-button

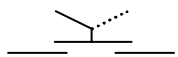

2-position switch



normally closed push-button

Application 1 : Basic Speed Control (default)

- STANDARD PARAMETERS**
- p1 Application
 - p2 Max speed
 - p3 Min speed
 - p4 Accel time
 - p5 Decel time
 - p6 Motor current
 - p7 Base frequency
 - p8 Jog setpoint
 - p9 Run stop mode
 - p11 V/F shape
 - p12 Normal duty
 - p13 Fixed boost, (VF only)
 - p99 Password

- DIAGNOSTICS**
- Frequency Hz
 - Speed Setpoint %
 - DC Link Volts V
 - Motor Current A

Application 1: Basic Speed Control

IDEAL FOR GENERAL PURPOSE APPLICATIONS
NORMAL DUTY AND HEAVY

P 1 = 1

Italic text indicates Default

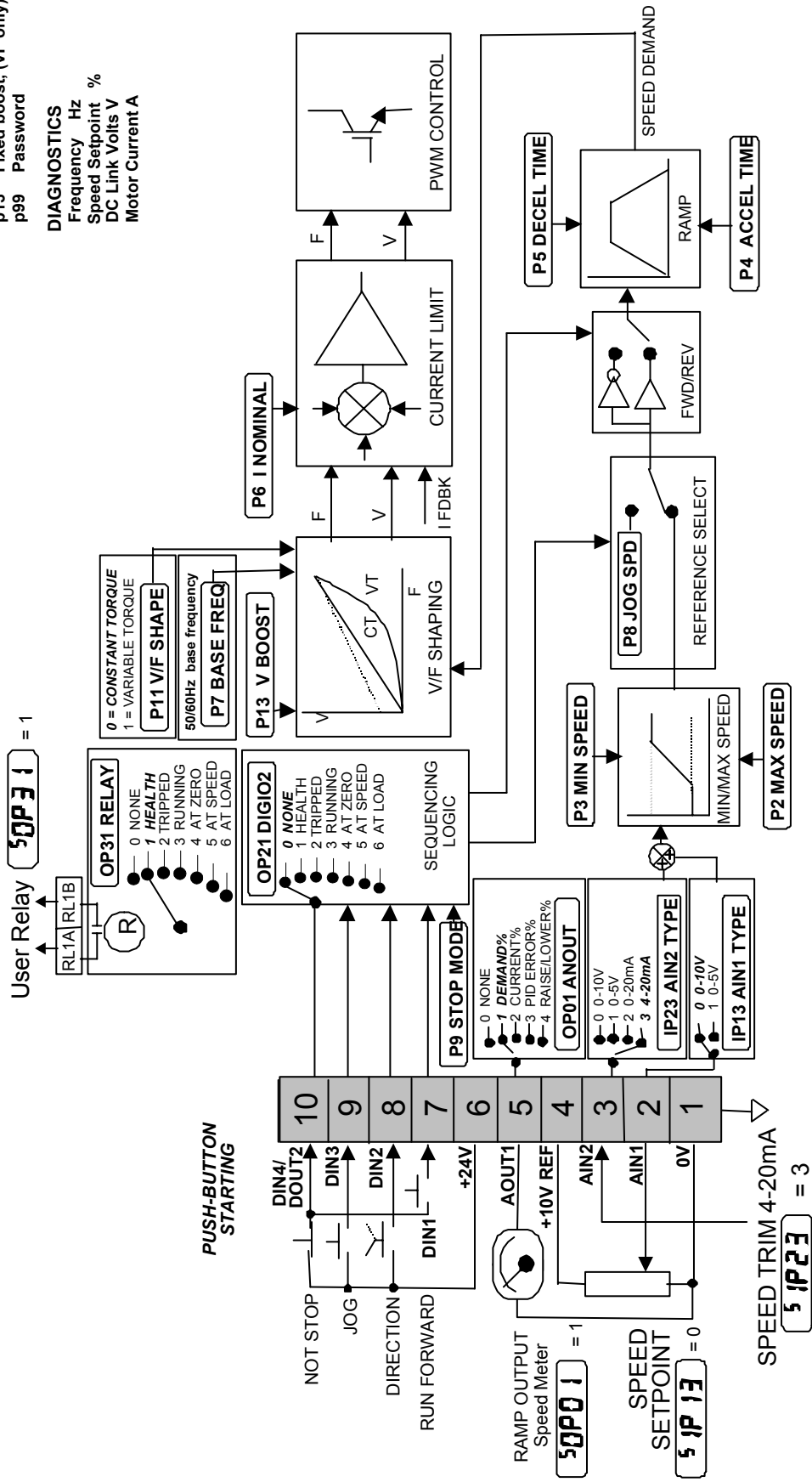
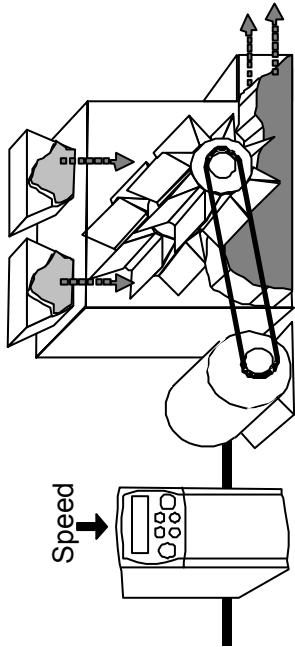

12-3 Applications

Application 1: Basic Speed Control (default)

This Application is ideal for general purpose applications. It provides push-button or switched start/stop control. The setpoint is the sum of the two analogue inputs AIN1 and AIN2, providing Speed Setpoint + Speed Trim capability.

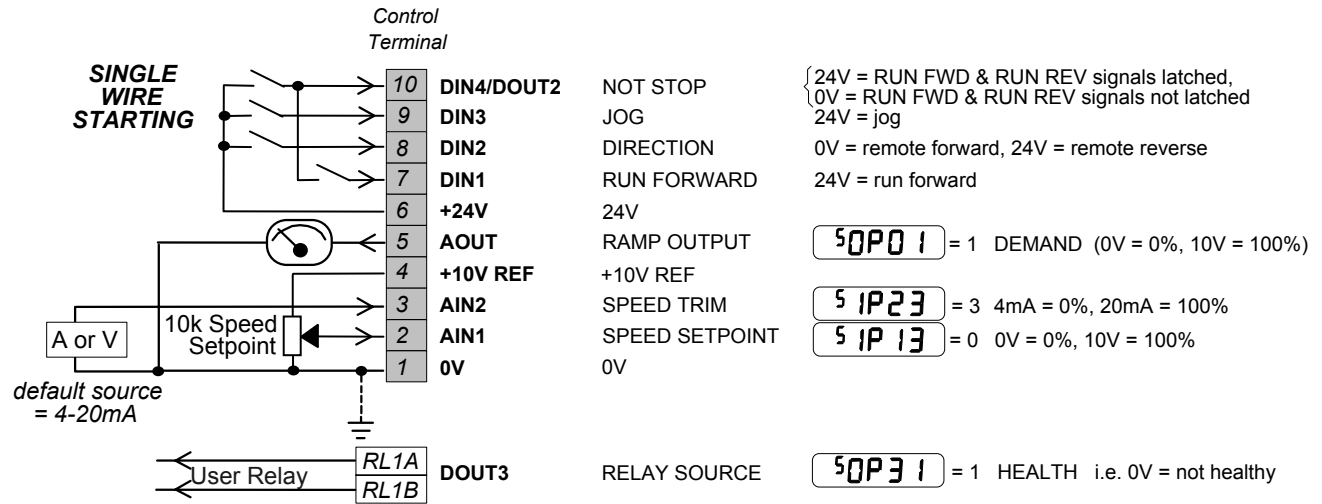

Application 2 : Auto/Manual Control

- STANDARD PARAMETERS**
- p1 Application
 - p2 Max speed
 - p3 Min speed
 - p4 Accel time
 - p5 Decel time
 - p6 Motor current
 - p7 Base frequency
 - p8 Jog setpoint
 - p9 Run stop mode
 - p10 V/F shape
 - p11 Normal duty
 - p12 Fixed boost, (VF only)
 - p99 Password

- DIAGNOSTICS**
- Frequency Hz
 - Speed Setpoint %
 - DC Link Volts V
 - Motor Current A

Application 2: Auto/Manual

IDEAL FOR AUTOMATIC CONTROL APPLICATIONS
WITH LIMIT SWITCHES OR PROXIMITY TRANSDUCERS

P 1 = 2

Italic text indicates Default

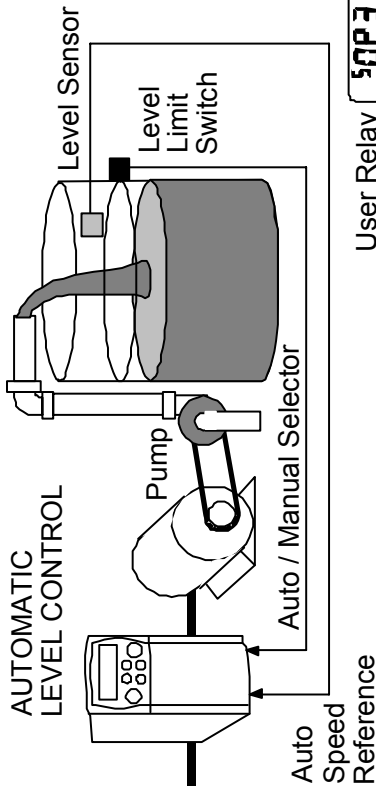

User Relay **OP31** = 1



PUSH-BUTTON STARTING

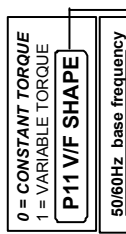
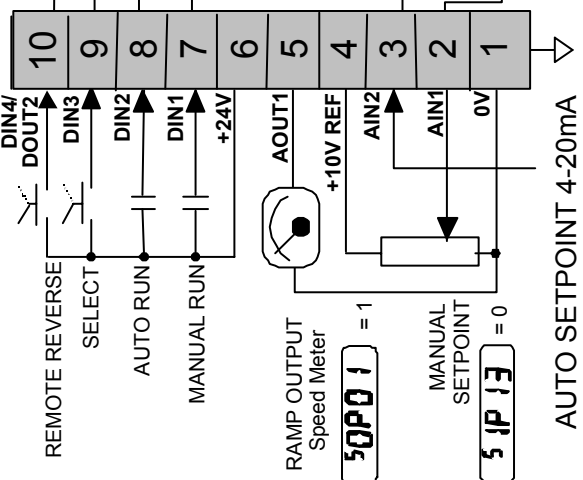

P6 I RATED

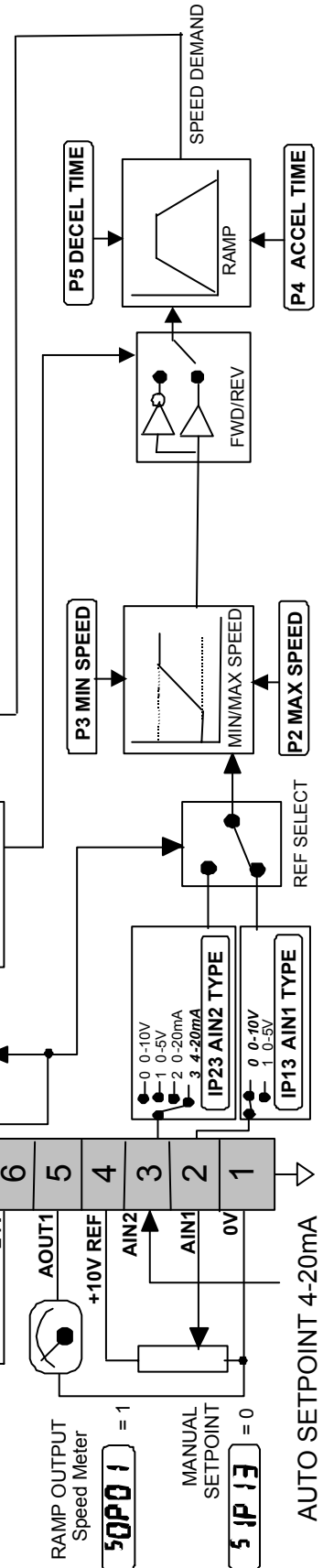
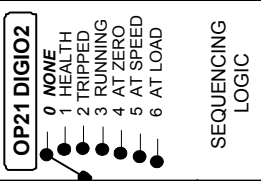
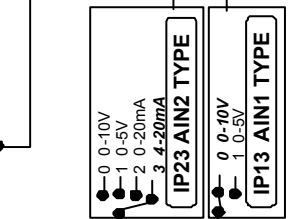
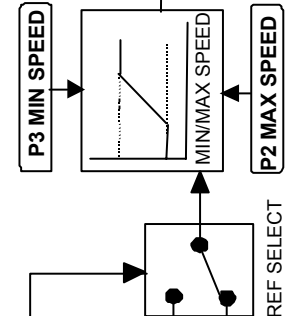
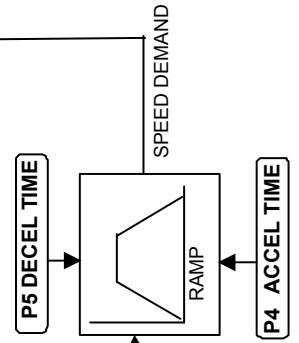
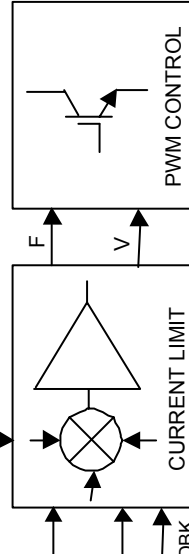

12-5 Applications

Application 2: Auto/Manual Control

Two Run inputs and two Setpoint inputs are provided. The Auto/Manual switch selects which pair of inputs is active. The Application is sometimes referred to as Local/Remote.

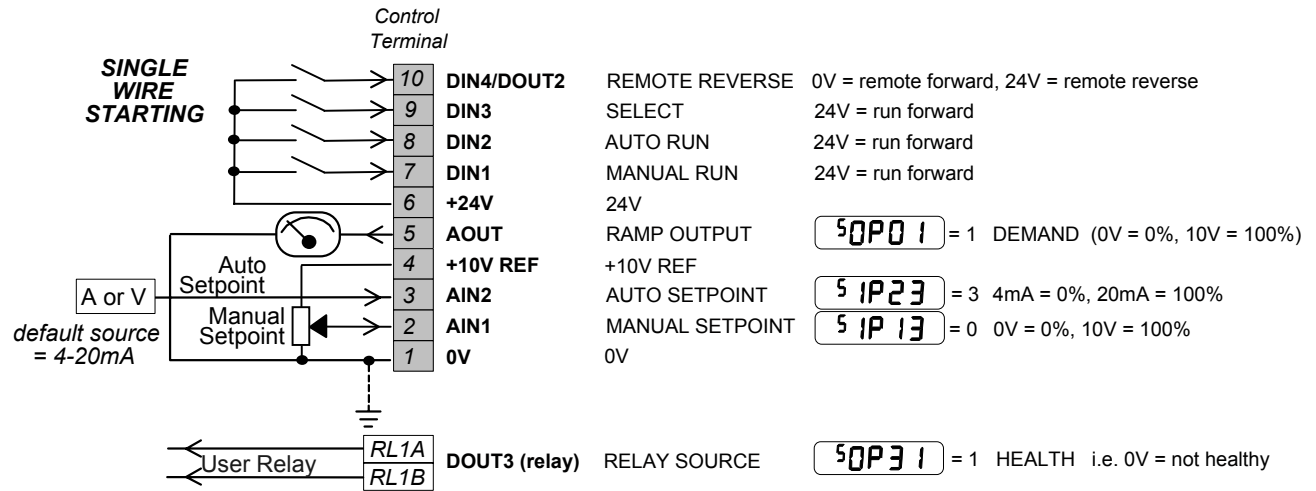

Application 3 : Preset Speeds

- STANDARD PARAMETERS**
- p1 Application
 - p2 Max speed
 - p3 Min speed
 - p4 Accel time
 - p5 Decel time
 - p6 Motor current
 - p7 Base frequency
 - p8 Jog setpoint
 - p9 Run stop mode
 - p11 V/F shape
 - p12 Normal duty
 - p13 Fixed boost, (VF only)
 - p89 Password

- DIAGNOSTICS**
- Frequency Hz
 - Speed Setpoint %
 - DC Link Volts V
 - Motor Current A

Application 3: Preset Speeds

IDEAL FOR APPLICATIONS REQUIRING MULTIPLE DISCRETE SPEED LEVELS

P 1 = 3

Italic text indicates Default

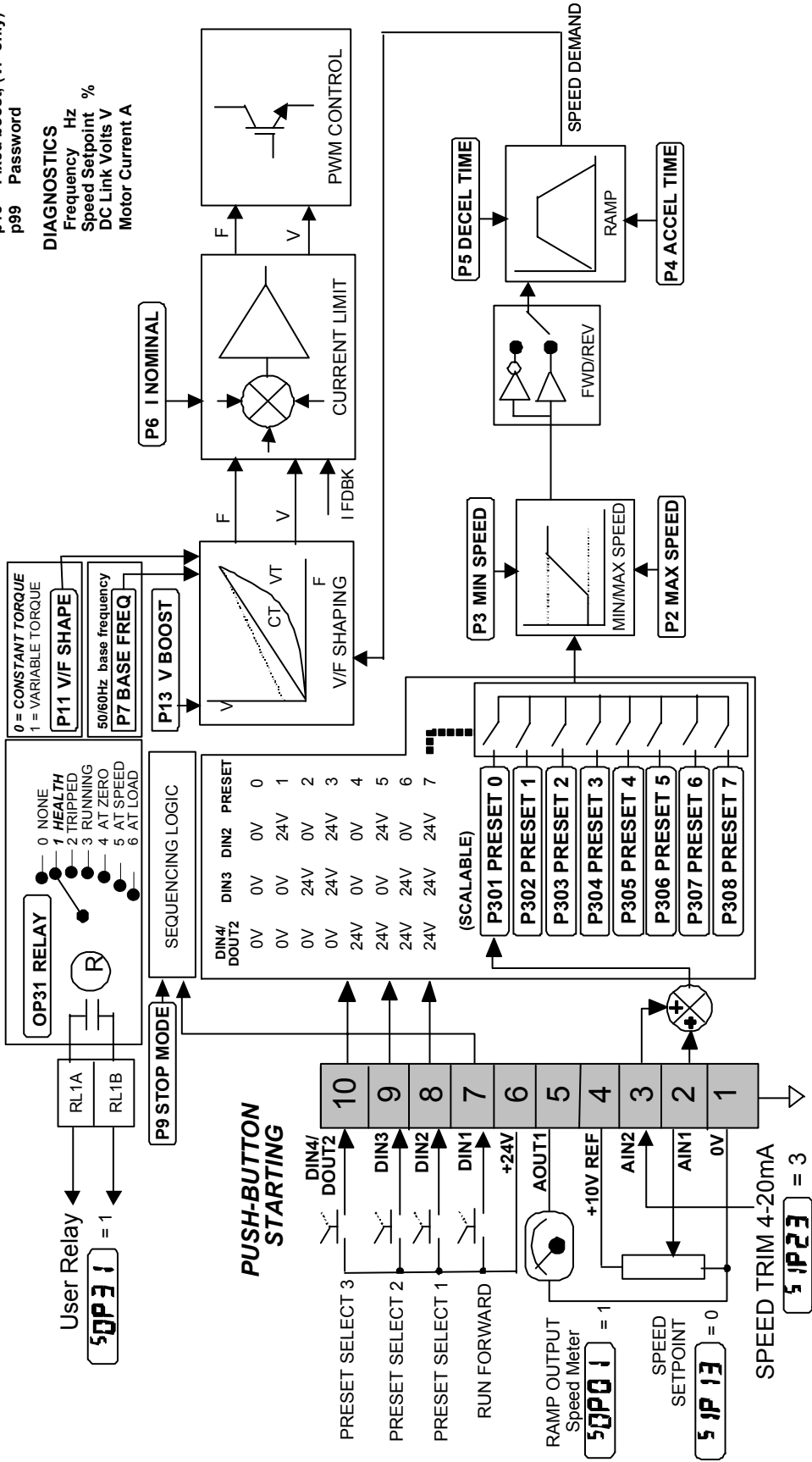
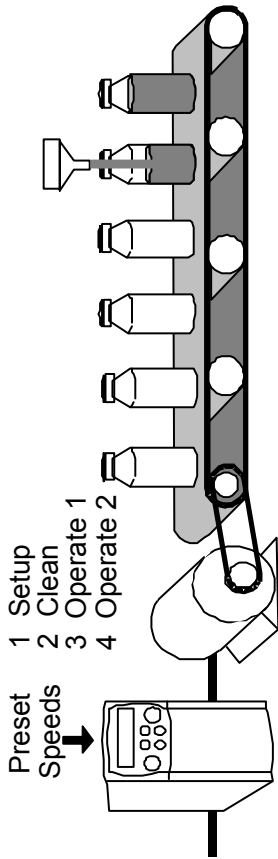

12-7 Applications

Application 3: Preset Speeds

This is ideal for applications requiring multiple discrete speed levels.

The setpoint is selected from either the sum of the analogue inputs, (as in Application 1 and known here as PRESET 0), or as one of up to seven other pre-defined speed levels. These are selected using DIN2, DIN3 and DIN4, refer to the Truth Table below.

Edit parameters P302 to P308 on the keypad to re-define the speed levels of PRESET 1 to PRESET 7. Reverse direction is achieved by entering a negative speed setpoint.

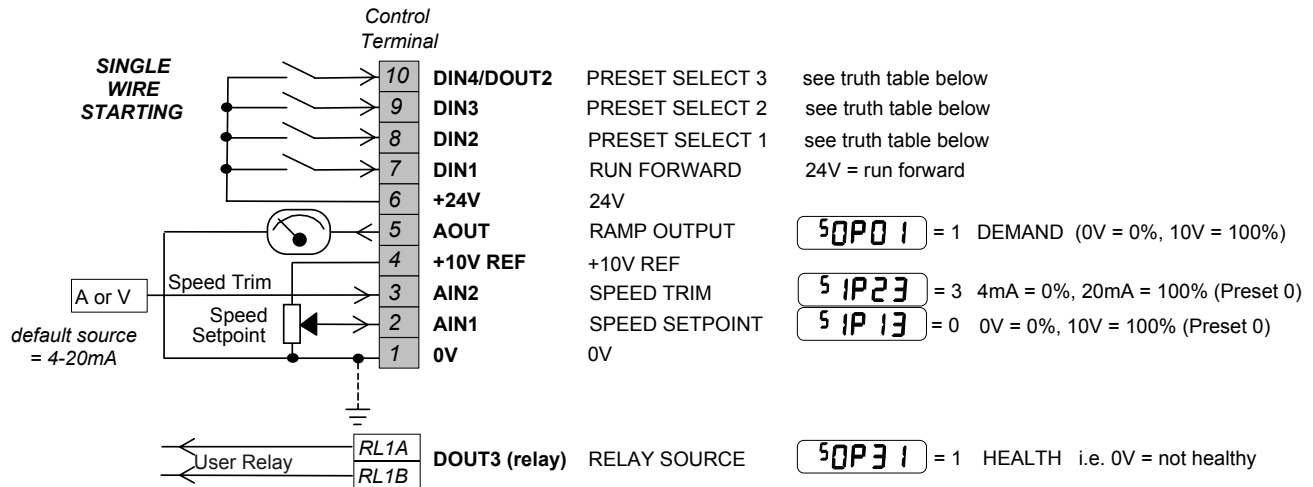

Preset Speed Truth Table

DIN4/DOUT2	DIN3	DIN2	Preset
0V	0V	0V	0
0V	0V	24V	1
0V	24V	0V	2
0V	24V	24V	3
24V	0V	0V	4
24V	0V	24V	5
24V	24V	0V	6
24V	24V	24V	7

Application 4 : Raise/Lower Trim

Application 4: Raise/Lower Trim

IDEAL FOR APPLICATIONS
SPEED CONTROL FROM MULTIPLE

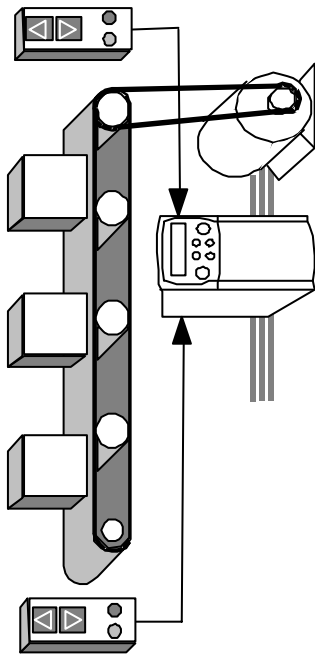

P ! = 4

Italic text indicates Default

User Relay **50P31** = 1

- STANDARD PARAMETERS**
- p1 Application
 - p2 Max speed
 - p3 Min speed
 - p4 Accel time
 - p5 Decel time
 - p6 Motor current
 - p7 Base frequency
 - p8 Jog setpoint
 - p9 Run stop mode
 - p11 V/F shape
 - p12 Normal duty
 - p13 Fixed boost, (VF only)
 - p99 Password

DIAGNOSTICS

- Frequency Hz
- Speed Setpoint %
- DC Link Volts V
- Motor Current A

- 0 = CONSTANT TORQUE
- 1 = VARIABLE TORQUE
- P11 V/F SHAPE**
- 50/60Hz base frequency
- P7 BASE FREQ**
- P13 V BOOST**

- OP31 RELAY**
- 0 NONE
- 1 HEALTH
- 2 TRIPPED
- 3 RUNNING
- 4 AT ZERO
- 5 AT SPEED
- 6 AT LOAD

PUSH-BUTTON STARTING

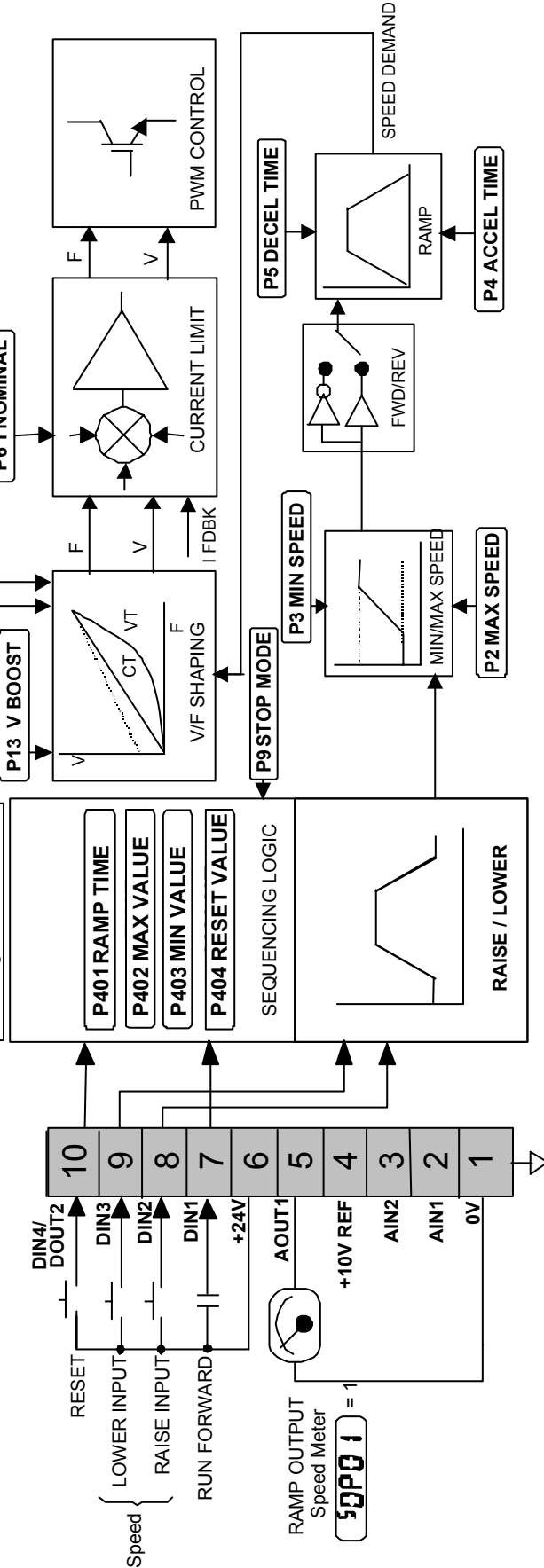

12-9 Applications

Application 4: Raise/Lower Trim

This Application mimics the operation of a motorised potentiometer. Digital inputs allow the setpoint to be increased and decreased between limits. The limits and ramp rate can be set using the keypad.

The Application is sometimes referred to as Motorised Potentiometer.

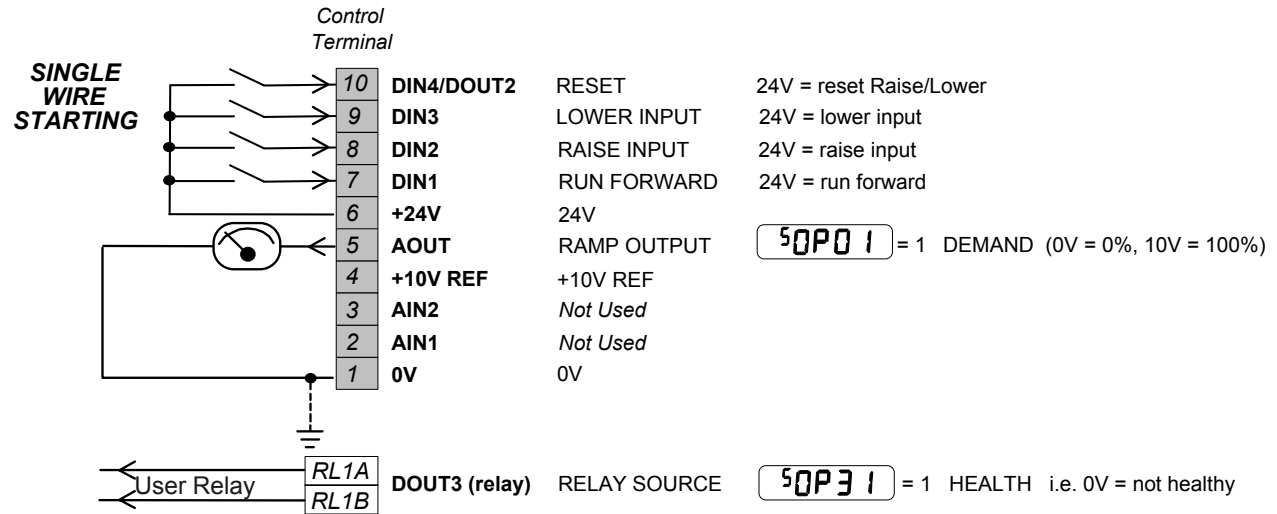

Application 5 : PID

Application 5: PI Control

EASY TUNING FOR SETPOINT/FEEDBACK CONTROL
APPLICATIONS REGULATING VOLUME OR PRESSURE,
SUCH AS AIR HANDLING OR PUMPING

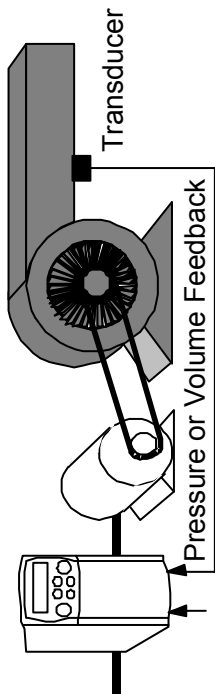

- STANDARD PARAMETERS**
- p1 Application
 - p2 Max speed
 - p3 Min speed
 - p4 Accel time
 - p5 Decel time
 - p6 Motor current
 - p7 Base frequency
 - p8 Jog setpoint
 - p9 Run stop mode
 - p11 V/F shape
 - p12 Normal duty
 - p13 Fixed boost, (VF only)
 - p99 Password

P I = 5
Italic text indicates Default

- DIAGNOSTICS**
- Frequency Hz
 - Speed Setpoint %
 - DC Link Volts V
 - Motor Current A

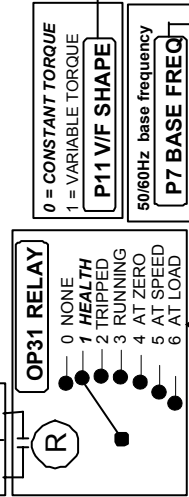

PUSH-BUTTON STARTING

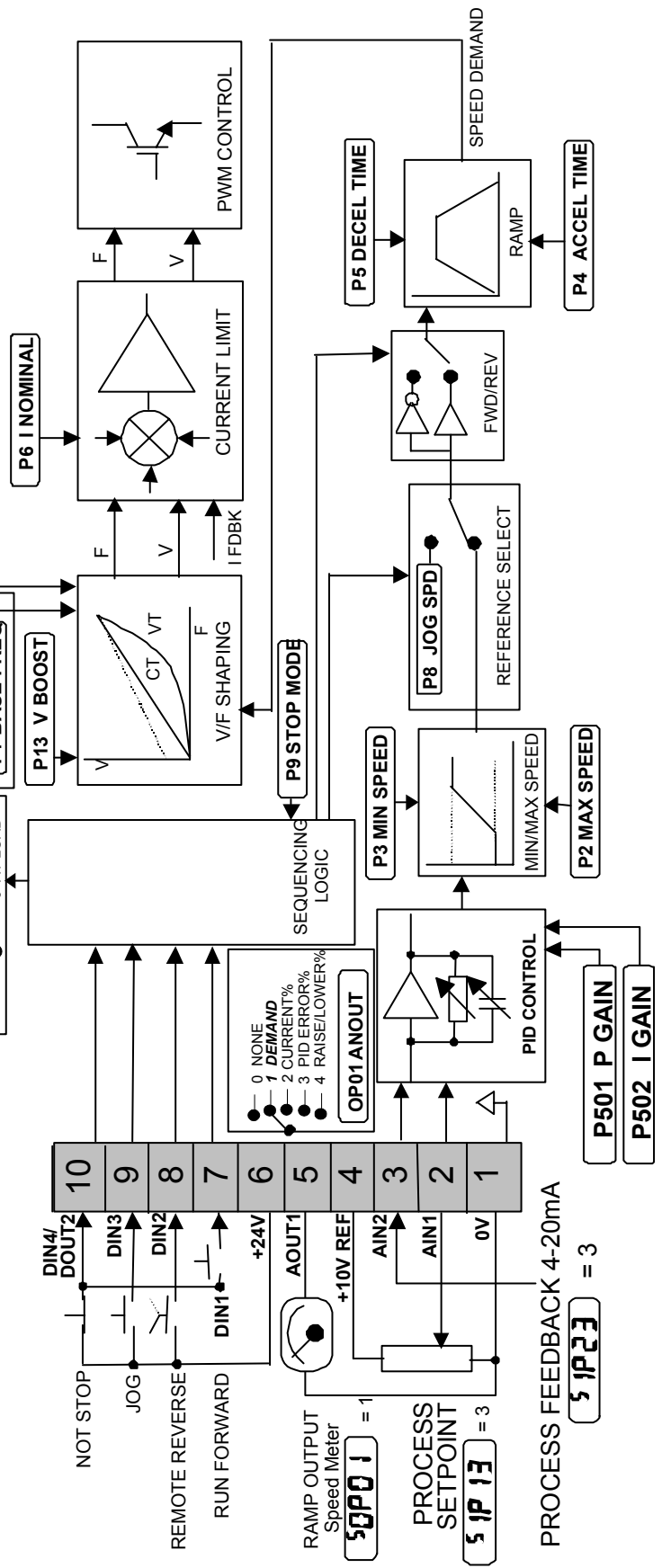

OP31 = 1

OP01 = 1

IP13 = 3

IP23 = 3

12-11 Applications

Application 5: PID

A simple application using a Proportional-Integral-Derivative 3-term controller. The setpoint is taken from AIN1, with feedback signal from the process on AIN2. The scale and offset features of the analogue input blocks may be used to correctly scale these signals. The difference between these two signals is taken as the PID error. The output of the PID block is then used as the drive setpoint.

